

FTdx9000 Contest

Operation Manual



YAESU
Choice of the World's top DX'ers

GENERAL DESCRIPTION

We wish to take this opportunity to thank you for your purchase of the FT DX 9000 Series Transceiver!

The FT DX 9000 is the culmination of a four-year design project. But it also is the product of our company's fifty years of engineering, design, and manufacturing know how. As pioneers in the development of SSB, we have led the technological advances in Amateur Radio communications over the last half century. And now, with the introduction of the FT DX 9000 Series, we again lead the way with a no-compromise 21st-century design that will make your operating dreams come true. More importantly, it is a radio that will let your skills and experience find expression, as you harness the excitement of HF operating like you've never done before!

ABOUT THIS MANUAL. . .

The FT DX 9000 Series is a leading-edge transceiver with a number of new and exciting features, some of which may be unfamiliar to you. In order to gain the most enjoyment and operating efficiency from your FT DX 9000, we recommend that you read this manual in its entirety, and keep it handy for reference as you explore the many capabilities of your new transceiver.

Before using your FT DX 9000, be sure to read and follow the instructions in the "Before You Begin" section of this manual.

CONVENTIONS USED IN THIS MANUAL

Please note the conventions, described below, for operational commands and texts included in this manual.

【 (#○) This refers to a switch or knob used for controlling a particular function. The name or number inside the brackets designate the name of the switch/knob, or its reference number within this manual.

【XX】 In the texts, you may be advised to press a button momentarily, or press and hold it in for a time interval (such as two seconds). Please be sure to observe the proper procedure when pressing a button.

【OO】 This indicates the pressing of a button when a "momentary" press is the only selection available.

『Note』 This is used for a note as to a particular point of interest.

『Advice』 This is used to amplify or expand on instructions, so as to recommend a way to gain maximum benefit from a feature or function.

『Example』 This is used to demonstrate an example of how a feature or function should work or be programmed.

『Quick Note』/『Quick Point』 This is used for a brief explanation of a particular aspect of operation.

『Terminology』 An explanation of a term or expression used in this manual.

TABLE OF CONTENTS

General Description	1	Advanced Interference	
About This Manual	1	-Suppression Features	54
Conventions Used in This Manual	1	Using the VRF (Variable RF Front-end Filter)	54
Before You Begin.	4	Interference Rejection	55
1. Connecting AC Power	4	ROOFING (Roofing Filters)	55
2. Configuring Your FT DX 9000 Using the Menu	4	Contour Control Operation	56
3. Connecting and Selecting the Microphone	5	IF SHIFT Operation (SSB/CW/RTTY/PKT Modes)	57
4. Extending the Front Feet	5	WIDTH (IF DSP Bandwidth) Tuning	
5. Adjusting the Main Dial Torque	6	(SSB/CW/RTTY/PKT Modes)	58
6. Restarting Power after a Voltage Fluctuation	6	Using IF Shift and Width Together	58
7. Resetting the Microprocessor	7	IF Notch Filter Operation (SSB/CW/RTTY/PKT/AM Modes)	59
Resetting Memories (Only)	7	Digital Noise Reduction (DNR) Operation	60
Menu Resetting	7	NARROW (NAR) One-Touch IF Filter Selection	61
Full Reset	7	Digital Notch Filter (D.NOTCH) Operation	62
Features	8	IF Noise Blanker (NB) Operation	62
Accessories	10	Tools for Comfortable and	
Options	11	Effective Reception	63
Installation and Interconnections	12	AGC (Automatic Gain Control)	63
Antenna Considerations	12	SLOPED AGC Operation	64
About Coaxial Cable	12	Audio Limiter (AFL) Feature	65
Grounding	13	SSB/AM Mode Transmission	66
Connection of Antenna and Power Cables	14	Phantom Voltage for Condenser Microphones	67
Connection of Microphone, Headphones and		Using the Automatic Antenna Tuner	68
FH-2 Remote Control Keypad	15	ATU Operation	68
Key, Keyer, and Computer-Driven Keying Interconnections	16	About ATU Operation	69
VL-1000 Linear Amplifier Interconnections	17	Lithium Battery Replacement	70
Interfacing to Other Linear Amplifiers	18	SSB/AM Mode Transmission	72
Plug/Connector Pinout Diagrams	19	Using the Speech Processor - SSB, AM Mode -	72
Front Panel Controls	20	Adjusting the SSB Transmitted Bandwidth	73
Rear Panel	34	Signal Quality Enhancement Using the	
Frequency Display	36	Parametric Microphone Equalizer	74
FH-2 Operation	37	Low-Distortion CLASS-A Operation	76
Basic Operation:		Voice Memory	78
Receiving on Amateur Bands	38	Convenient Transmitter Accessories	80
Operation	39	VOX: Automatic TX/RX Switching using Voice Control	
Operation on 60-Meter (5 MHz) Band (U.S. Version only)	41	SSB/AM/FM Modes	80
CLAR (Clarifier) Operation on Main (VFO-A)	42	Using the MONITOR	80
LOCK	43	Split Operation Using the TX Clarifier (VFO-A Operation)	81
DIM	43	Clarifier Offset Bar Indicator	81
B-DISP OFF	43	Split-Frequency Operation	82
Convenient Features	44	Quick Split Operation	83
P.BACK (Audio Playback) from VFO-A Receiver	44	CW Mode Operation	84
"MY Bands" Operation	45	Setup for Straight Key (and Straight Key emulation) Operation	84
Band Stack Operation	46	Using the Built-in Electronic Keyer	85
C.S (Custom Switch)	46	Full Break-in (QSK) Operation	85
Rotator Control Functions	47	Setting the Keyer Weight (Dot/Space:Dash) Ratio	86
More Frequency Navigation Techniques	48	Selecting the Keyer Operating Mode	86
ANTENNA SELECTION	49	CW Convenience Features	87
Receiver Operation (Front End Block Diagram)	50	CW Spotting (Zero-Beating)	87
IPO (Intercept Point Optimization)	51	Using CW Reverse	88
ATT	52	CW Delay Time Setting	89
RF Gain (SSB/CW/AM Modes)	53	CW Pitch Adjustment	89
		Contest Memory Keyer	90
		Message Memory	90
		TEXT Memory	92

TABLE OF CONTENTS

FM Mode Operation	94	Customized Option	133
Operation	94	About Customized Option	133
Repeater Operation	95	Dual Receive Unit (RXU-9000)	134
Convenient Memory Functions	96	Front Panel Controls	134
QMB (Quick Memory Bank)	97	Dual Receive	136
QMB Channel Storage	97	Dial Swap Configuration (AF/RF GAIN Controls)	115
QMB Channel Recall	97	Changing the Speaker Output Configuration	141
Memory Groups	98	Adjacent Channel Monitor (ACM) -- CW Mode Only --	142
Memory Group Assignment	98	RF Gain -- SSB/CW/AM Modes --	143
Choosing the Desired Memory Group	98	Using the VRF (Variable RF Front-end Filter)	144
Memory Operation	99	ROOFING/R.FLT (Roofing Filters)	145
Memory Storage	99	CONTOUR/CONT (Contour) Control Operation	146
Memory Channel Recall	99	IF SHIFT Operation -- SSB/CW/RTTY/PKT Modes --	147
Checking a Memory Channel's Status	100	WIDTH (IF DSP Bandwidth) Tuning	
Erasing Memory Channel Data	100	-- SSB/CW/RTTY/PKT Modes --	148
Moving Memory Data to the Main (VFO-A) Band	101	IF Notch Filter Operation -- SSB/CW/RTTY/PKT/AM Modes -- ..	149
Memory Tune Operation	101	NR/DNR (Digital Noise Reduction) Operation	150
Operation on Alaska Emergency Frequency:		Digital Notch Filter (DNF) Operation	151
5167.5 kHz (U.S. Version Only)	102	IF Noise Blanke (NB) Operation	152
Operation on the 60-Meter Band (U.S. Version)	103	AGC (Automatic Gain Control)	153
VFO and Memory Scanning	104	Mute Feature -- VFO-A --	153
VFO Scanning	104	Audio Limiter (AFL) Feature	154
Memory Scan	104	ATT	154
PMS	105	RF μ-Tuning Units	
Packet Operation	106	(MTU-160, MTU-80/40, MTU-30/20)	156
RTTY (Radio TeleType) Operation	107	Optional Data Management Unit (DMU-9000)/	
Miscellaneous AFSK-based Data Modes	108	TFT Display Unit (TFT-9000)	158
About the Transverter Output Terminal	109	Front Panel Controls	158
Menu Mode	110	TFT Feature / Control Details	160
Using the Menu	110	Rear Panel Connections	161
Menu Mode Reset	110	Connecting a GPS Receiver	161
Menu Mode Setting Table	111	Specifications	162
Menu Mode Setting	115		

Before You Begin. . .

1. Connecting AC Power

There are two power switches on this transceiver, one each on the rear and front panels. If the rear panel's Power switch is not turned on, the front panel Power switch will not function.

- Push the rear panel's Power switch to the **【 I 】** position to apply power from the power supply to the OCXO (Reference Crystal Oven) and to enable the front panel power switch.
- Press and hold in the front panel Power switch for two seconds to turn the transceiver on.

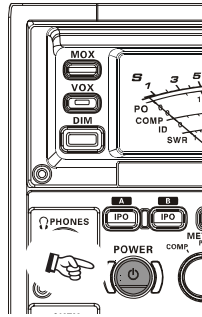
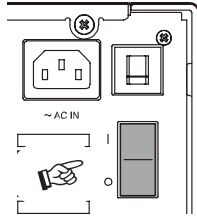

【Note】

The self-check function of the CPU inside the radio will begin. Then, if the optional RF μ -Tuning Unit is installed, the μ -Tuning circuitry will receive the data from the CPU and it will perform its own self-check, and will preset itself to the proper settings for the current operating frequency.

While the μ -Tuning circuitry is obtaining the data, the drive mechanism will move from one end of its range to the other end (fast), and this will cause a temporary "motor" noise that can be heard; this, does not represent any trouble or problem.

When the optional μ -Tuning Unit and/or the Data Management Unit are installed, the initialization process for the transceiver will take about 10 seconds, after which operation may begin.

2. Configuring Your FT DX 9000 Contest Using the Menu

The FT DX 9000 Contest is configured, at the factory, with its various functions set up in a manner typical for most operation. Via the "Menu" system, you may change these settings to match the way you want your transceiver to operate.

Menu programming is enabled by pressing the **【MNU】** (Menu) key momentarily. You may then rotate the **【Main】** Tuning Dial to display the desired Menu item, in the menu list, on the LCD. Each of the settings can be changed or customized via the **【CLAR/VFO-B】** knob, as you like, in this mode.

Once you have made a change to the configuration of a Menu item or items, you must press **and hold in** the **【MNU】** (Menu) key for **two seconds** to save the new settings and exit to normal operation.

If you wish to cancel a change to a Menu item or items, just press the **【MNU】** key momentarily. If you do not press and hold in the **【MNU】** key in for two seconds, any changes you have made will not be saved.

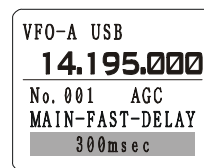
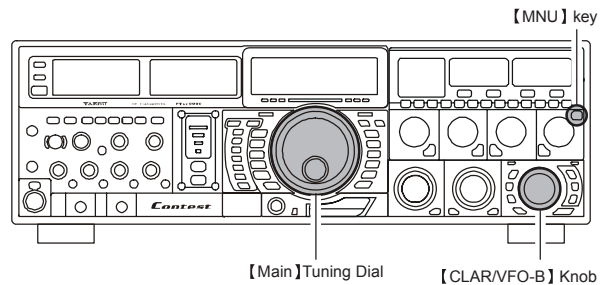

← MENU ITEM
← MENU SETTING

Before You Begin...

3. Connecting and Selecting the Microphone

The FT DX 9000 Contest comes equipped with two microphone connectors: the front panel includes a “Cannon” (XLR) three-pin connector, while the rear panel provides an eight-pin (round) connector.

As shipped from the factory, the front panel XLR connector is engaged for operation, and the rear panel 8-pin microphone jack is not connected. If you wish to enable the 8-pin connector instead of the XLR connector, use the Menu to accomplish this. Note that you may leave microphones connected to both jacks, and may select the microphone you want for operation on a particular operating mode (SSB, AM, FM, etc.), as well!

- Press the **【MNU】** (Menu) key momentarily to enter the Menu Mode.
- Rotate the **【Main】** Tuning Dial to select Menu Item #069, located within the “MODE SSB” group: SSB MIC SELECT.
- Rotate the **【CLAR/VFO-B】** knob to change the setting of Menu #069 from “FRONT” to “REAR.”
- Press **and hold in** the **【MNU】** (Menu) key for **two seconds** to save the new setting and exit to normal operation.
- In a similar manner, you may use Menu #040 (AM MIC SELECT) in the MODE-AM Menu Group to select the microphone jack to be used during AM operation, and Menu #059 (FM MIC SELECT) in the MODE-FM Menu Group to select the microphone to be used during FM transmission.

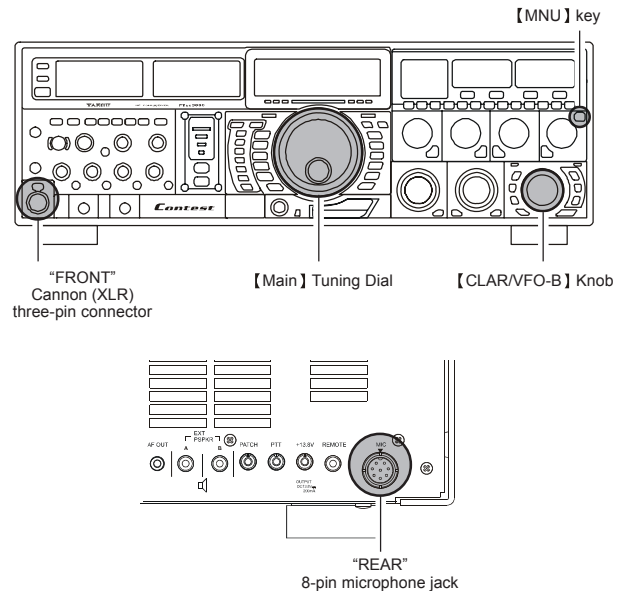

4. Extending the Front Feet

In order to elevate the front panel for easy viewing, the front left and right feet of the bottom case may be extended.

- Pull the front legs outward from the bottom panel.
- Rotate the legs counter-clockwise to lock them in the extended position. Be sure the legs have locked securely in place, because the transceiver is quite heavy and an unlocked leg could result in damage, should the transceiver move suddenly.

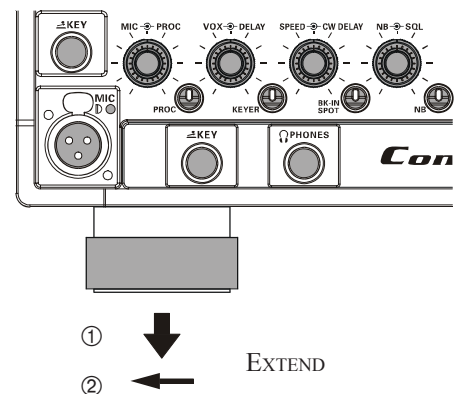

Retracting the Front Feet

- Rotate the legs clockwise, and push them inward while rotating to the right.
- The front feet should now be locked in the retracted position.

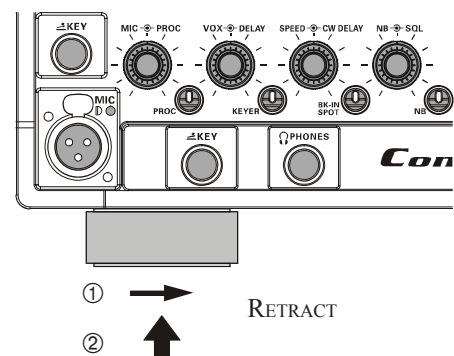

Before You Begin. . .

5. Adjusting the Main Dial Torque

The torque (drag) of the Main Tuning Dial may be adjusted according to your preferences. Simply hold down the rear skirt of the knob, and while holding it in place rotate the Main Dial itself to the right to reduce the drag, or to the left to increase the drag.

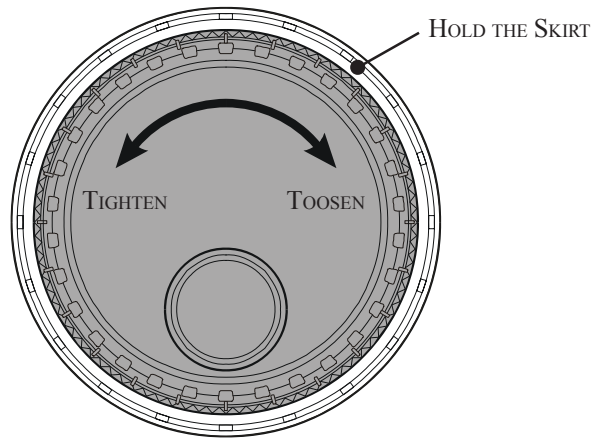

6. Restarting Power after a Voltage Fluctuation

If your AC mains power should suffer a significant fluctuation or interruption, we recommend that you go through a complete power-up cycle, in order to ensure that all circuits are properly initialized. To do this, be sure the front panel Power switch is turned off, then set the rear-panel Power switch to the "O" position. Now unplug the AC cable from the rear panel of the transceiver, and wait ten seconds. Plug the AC cable back in, set the rear-panel Power switch to "O," and now press and hold in the front-panel Power switch for two seconds to turn the transceiver on. After about 50 seconds, all circuits will be initialized, and normal operation may resume.

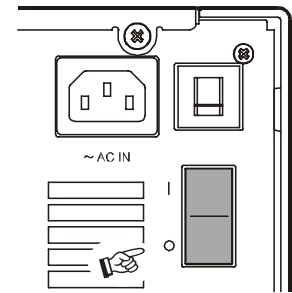

Before You Begin...

7. Resetting the Microprocessor

Resetting Memories (Only)

Use this procedure to reset (clear out) the Memory channels previously stored, without affecting any configuration changes you may have made to the Menu settings.

1. Press the front panel's **【POWER】** switch to turn the transceiver off.
2. Press and hold in the **【A▶M】** switch; while holding it in, press and hold in the front panel's **【POWER】** switch to turn the transceiver on. Once the transceiver comes on, you may release the **【A▶M】** switch.

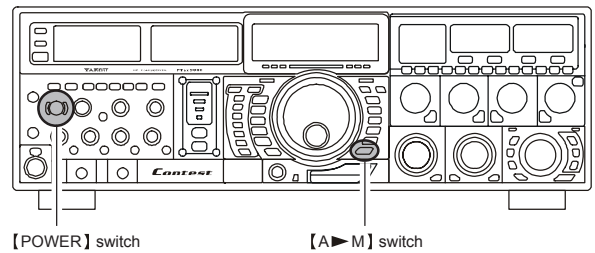

Menu Resetting

Use this procedure to restore the Menu settings to their factory defaults, without affecting the memories you have programmed.

1. Press the front panel's **【POWER】** switch to turn the transceiver off.
2. Press and hold in the **【MNU】** (Menu) key; while holding it in, press and hold in the front panel's **【POWER】** switch to turn the transceiver on. Once the transceiver comes on, you may release the **【MNU】** (Menu) key.

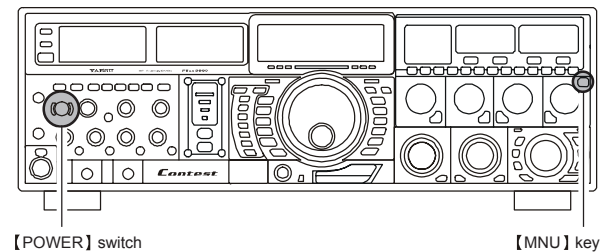

Full Reset

Use this procedure to restore all Menu and Memory settings to their original factory defaults. All Memories will be cleared out by this procedure.

1. Press the front panel's **【POWER】** switch to turn the transceiver off.
2. Press and hold in the **【FAST】** and **【LOCK】** switches; while holding them in, press and hold in the front panel's **【POWER】** switch to turn the transceiver on. Once the transceiver comes on, you may release the other two switches.

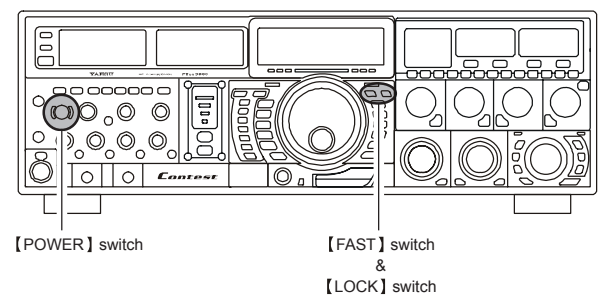

FEATURES

Superior Visibility and Logical, Fatigue-reducing Panel Layout

The front panel layout is logically crafted, with the large-aperture main frequency display squarely in the middle of the front panel; the two large S-meters to the left providing instant recognition of signal strength.

Just as in an aircraft cockpit, the panel meters and the LCD are canted slightly toward the center for maximum visibility.

Large, Multi-colored VFD Fluorescent Display

A proprietary, high-brightness VFD (fluorescent) display is incorporated in the FT DX 9000 Series, providing outstanding visibility and easy reading of the important frequency information, whether in dim or bright lighting environments.

Function-Indicating LEDs

The many function status indications on the front panel are clearly identified by the operator, thanks to the innovative multi-color LEDs incorporated in design. A Red LED indicates that a function is engaged on the VFO-A, while an Orange LED shows that the function is engaged on the VFO-B.

Indirect Illumination

To assist with operation in a dark environment, indirect illumination of the front panel's knobs and switches is provided via lamps installed beneath the meters and the **[BAND]** switch.

Aluminum-Die-Cast Oversized Main Tuning Dial

The Main Tuning Dial is a large-diameter (3.2"/81 mm) dial directly coupled to the magnetic rotary encoder which drives the HRDDS via microprocessor control. Its heavy weight (7 oz./200 g) and quality mounting and construction provide a smooth "flywheel" effect during operation, ideal for quick cruising up and down a band.

Oversized Knobs for Most Important Functions

The concentric AF/RF Gain, SHIFT/WIDTH, and CLAR/VFO-B knobs are conveniently located at the right-bottom side of the Front Panel, for ease of access to these important controls.

World's First 400 MHz HRDDS Local Oscillator

So as to optimize spurious-free dynamic range in a multi-signal environment, Yaesu's engineers have introduced the world's first HRDDS (High Resolution Direct Digital Synthesizer) as the first local oscillator of the FT DX 9000 Contest. Dividing directly from this high frequency, this local oscillator design ensures extraordinarily low noise, resulting in improved weak-signal reception even on a crowded band during a weekend contest.

New-design Large-area OCXO Reference Oscillator

Serving as the master reference oscillator for the transceiver, the 10 MHz OCXO (Oven Controlled Crystal Oscillator) is a large-area (50 x 50 mm/2" x 2") oven-stabilized oscillator operating at high temperature, for industry-leading frequency stability rated at 0.03 ppm over the temperature range -10 °C to +60 °C (-14 °F to +140 °F).

Triple-conversion Design with Optimized Gain Distribution

Taking into account the most efficient transceiver design concept consistent with high performance we have adopted a triple-conversion IF structure, utilizing a first IF at 40 MHz, a second IF at 455 kHz, and the third IF at 30 kHz (for FM, the 3rd IF is at 24 kHz). Gain distribution through all stages is carefully optimized, for preservation of high system dynamic range.

Ultra-strong Receiver Front End

YAESU's outstanding RF-stage filtering establishes a clean performance that allows the rest of the receiver to perform at a high level. By reducing the ingress of energy from very strong sources like Shortwave Broadcast, local AM/FM/TV stations, and other signal sources, the overall purity of the spectrum delivered to the RF Amplifier first mixer, and subsequent stages is maintained, and the system Blocking Dynamic Range is also enhanced.

Professional-Grade Cannon (XLR) Microphone Connector

The FT DX 9000 Contest incorporates, for the first time ever in an Amateur Radio transceiver, a balanced-input "Cannon" (XLR) microphone connector on the front panel, for use with studio-grade professional microphones. A round 8-pin microphone jack is also provided on the rear panel.

Two High-precision Analog Meters (Page 27)

The FT DX 9000 Contest incorporates two large (3.4"/86 mm) high-precision analog meters, for the utmost accuracy in measuring transceiver performance. Visibility is enhanced by the oversized meter scales, making the meters easy to read at all times.

Separated Clarifier Display (Pages 42, 81)

A clearly-separated display window within the main frequency display area contains receiver and/or transmitter frequency offset ("Clarifier") data, for quick comprehension by the operator.

YAESU Custom-designed 32-Bit Floating Point IF DSP (Page 50)

The new IF DSP system, utilizing a TI TMS320C6711 device, is a high-speed 32-bit floating point circuit designed with a unique objective: to do away with the "digital" sound of many DSP filtering systems, and emulate the "Analog Sound" so familiar and comfortable to HF DX and Contest operators. The result is a leading-edge receiver that has the "feel" of a traditional analog receiver, but with the flexibility and superb filtering capability of a modern digital filtering system.

VRF (Variable RF Filter) Preselector Filter (Page 54)

Yaesu's robust VRF (Variable RF Filter) preselector provides a relay-selected RF selectivity much tighter than that afforded by traditional bandpass filter networks. Sealed relays select heavy-duty inductors and capacitors, providing a tracking RF filter that protects the RF amplifier and following stages from strong out-of-band energy.

First IF 3 kHz Roofing Filter (Page 24, 55)

In the 40 MHz 1st IF, three selectable roofing filters are provided, in bandwidths of 3 kHz, 6 kHz, and 15 kHz, to protect the following stages from strong signals that could degrade dynamic range in the first IF amplifier and subsequent stages. The roofing filters are automatically assigned according to the operating mode, but the operator may override the automatic selections on the fly.

CONTOUR Filter Enhances "Analog Feeling" of DSP Filters (Page 29, 56)

The DSP-based Contour system is a unique five-band filter that may be used to roll off or peak the IF response. It is chiefly useful for modifying the response of the ultra-sharp DSP filters, allowing you to roll off (or emphasize) certain frequency components. Often times, the result is that a difficult-to-understand signal suddenly will pop out of the background noise as solid copy.

SLOPED AGC Circuitry (Page 64)

In traditional AGC systems, all signals rising above a certain RF level are then clamped together at the same audio output, so as to prevent distortion throughout the IF and AF stages. In the FT DX 9000, however, you can engage the "Sloped" AGC capability to provide an AGC response whereby ever-increasing signal strength results in a slightly-louder audio response, still without accompanying distortion. This lets you use your brain to sort out weak signals from strong ones more effectively.

Receiver AF Limiter Circuit (Page 30, 65)

Occasionally a noise burst or a sudden transmission from a loud station may startle you if you have the AF Gain turned up, and may even damage your hearing temporarily. The FT DX 9000 Contest provides an AF Limiter (AFL) circuit which, once engaged, clamps an upper limit on the available audio output power, much like the AGC circuit does in the RF and IF stages.

Parametric Microphone Equalizer Circuit (Page 74)

For unmatched flexibility in tailoring your microphone's audio to match your voice, Yaesu's engineers have incorporated the industry's first Three-Band Parametric Microphone Equalizer, which allows you to enhance or suppress frequency components in three different audio bands. Equalization may be applied independently to microphones attached to the front and rear panel microphone jacks.

Ultra-linear Class-A Operation Capability (Page 76)

The FT DX 9000 Contest's Class-A capability provides ultra-linear amplifier operation at 75 Watts of power output. Typically, 3rd-order IMD products are suppressed more than 50 dB, while 5th- and higher-order distortion products are at least 70 dB down during Class-A operation.

Rugged, High-Output Final Amplifier Design (Page 77)

The final amplifier stage of the FT DX 9000 Contest utilizes push-pull SD2931 MOS FET devices in a conservative, high-stability design. The large-area die-cast aluminum heat sink is monitored thermostatically, and a quiet cooling fan will engage when the heat sink temperature rises during long periods of high-power transmission.

Customization of Your FT DX 9000 Contest

A wide range of custom configuration options (other than a better location or taller tower!) are available for your FT DX 9000 Contest, allowing you to build a Dream Station from the basic "Contest" version foundation.

Because these options involve high-technology modules, please consult WDXC regarding factory installation of these items.

Dual Receive Unit (RXU-9000)

The Dual Receive Unit (model RXU-9000) not only permits simultaneous reception on two frequencies (in the same band or on different bands), but also it enables Full Duplex operation, whereby you may be transmitting on 20 meters while, simultaneously, receiving on 40 meters or any band other than 14 MHz. The RXU-9000 is a fully-equipped replica of the VFO-A receiver, so reception is not compromised when using the VFO-B.

RF μ -Tuning Units (MTU-160, MTU-80/40, MTU-30/20)

On the 14 MHz and lower bands, the μ -Tuning Units provide extraordinarily high Q; the resulting steep shape factor is a powerful aid for reducing off-frequency interference. Separate modules are available for the 1.8 MHz, 3.5/7 MHz, and 10.1/14 MHz bands, and they may be installed on the Main Receiver only (not in the RXU-9000).

Thanks to the large (1.1"/28 mm) inductor through which a stack of ferrite cores is adjusted, the narrow RF bandwidth of the μ -Tuning system provides unmatched protection for the receiver front end and following circuits.

Variable RF Preselector Unit (VRF-9000)

The VRF-9000 provides outstanding protection against out-of-band interference, with a bandwidth much narrower than the standard fixed bandpass filter network. Adding the VRF-9000 can be particularly useful if your station is located near a broadcast station, or if you use Dual Receive a lot in a multi-transmitter environment.

Data Management Unit (DMU-9000)/TFT Display Unit (TFT-9000)

In order to enable the World Clock, Spectrum Scope, Audio Scope/Oscilloscope, Logbook, Rotator Control, and Temperature/SWR Status Display functions, you may install the Data Management Unit (DMU-9000), which actually is a mini-computer that fits inside your transceiver. These various functions may then be displayed on a user-supplied external display screen, such as a plasma or TFT display. Furthermore, if the TFT Display Unit (TFT-9000) is installed, an external display becomes unnecessary. The TFT-9000 includes a 6.5", 800 x 480 dot screen which provides high resolution and easy viewing, as well as quick access to the control options available on each TFT display page.

ACCESSORIES

SUPPLIED ACCESSORIES

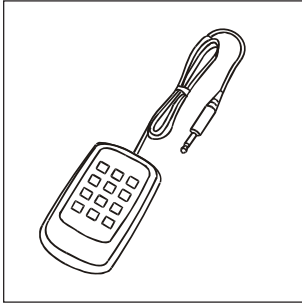

FH-2
Remote Control Keypad

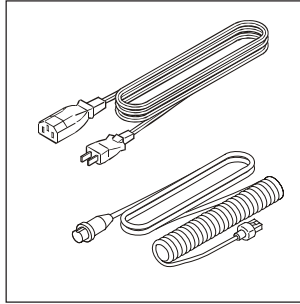

AC Power Cord^{※1}
Microphone Extend Cable^{※2}
(T9101549: 8 Pin ↔ Modular)

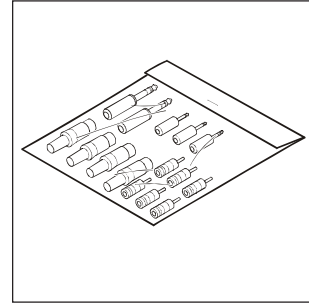

Plugs

- Operating Manual
- Warranty Card

※1 AC Power Cord

USA: T9017882

Europe: T9013285

Australia: T9013283A

UK: T9013285

※2 This microphone cable is for use with the optional MD-200A8X, MD-100A8X, or MH-31B8 microphones.

Plug Details and Part Numbers

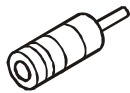

RCA Plug (P0091365)
6 pcs

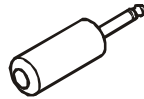

3.5 mm 2-contact Plug (P0090034)
2 pcs



3.5 mm 3-contact Plug (P0091046)
1 pc

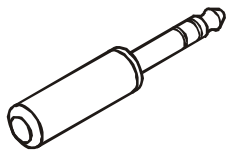

1/4-inch 3-contact Plug (P0090008)
2 pcs

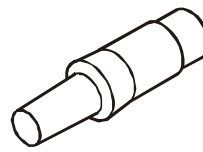

4-pin DIN Plug (P0091004) 1 pc
5-pin DIN Plug (P0091006) 1 pc
7-pin DIN Plug (P0091419) 1 pc
8-pin DIN Plug (P0090651) 1 pc

Items are shown for illustrative purposes only, and may vary slightly in appearance.

AVAILABLE OPTIONS

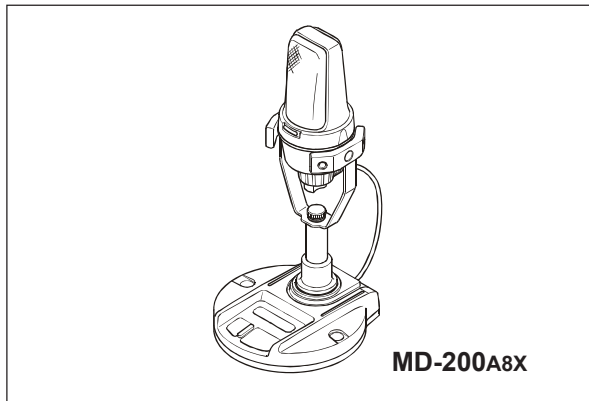

Ultra-High-Fidelity Desk-Top Microphone
MD-200A8X
Desk-Top Microphone
MD-100A8X



Lightweight Stereo Headphones
YH-77STA

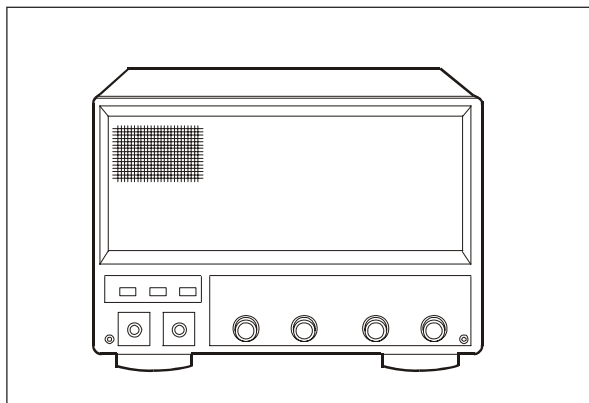

External Speaker with Dual Speakers and Audio Filter
SP-9000

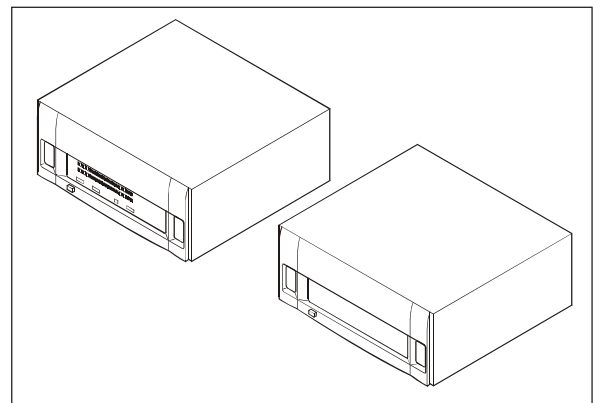

Linear Amplifier / AC Power Supply
VL-1000 / VP-1000

Customization Options

- Dual Receive Unit RXU-9000
- Sub Band VRF Unit VRF-9000
- RF μ -Tuning Unit A MTU-160 (160 m Band)
- RF μ -Tuning Unit B MTU-80/40 (80/40 m Bands)
- RF μ -Tuning Unit C MTU-30/20 (30/20 m Bands)
- Data Management Unit DMU-9000
- TFT Display Unit TFT-9000

INSTALLATION AND INTERCONNECTIONS

ANTENNA CONSIDERATIONS

The FT DX 9000 Contest is designed for use with any antenna system providing a 50 Ohm resistive impedance at the desired operating frequency. While minor excursions from the 50-Ohm specification are of no consequence, the transceiver's Automatic Antenna Tuner may not be able to reduce the impedance mismatch to an acceptable value if the Standing Wave Ratio (SWR) present at the Antenna jack is greater than 3:1.

Every effort should, therefore, be made to ensure that the impedance of the antenna system utilized with the FT DX 9000 Contest be as close as possible to the specified 50-Ohm value.

Any antenna to be used with the FT DX 9000 Contest must, ultimately, be fed with 50 Ohm coaxial cable. Therefore, when using a "balanced" antenna such as a dipole, remember that a balun or other matching/balancing device must be used so as to ensure proper antenna performance.

The same precautions apply to any additional (receive-only) antennas connected to the RX ANT jack; if your receive-only antennas do not have an impedance near 50 Ohms at the operating frequency, you may need to install an external antenna tuner to obtain optimum performance.

ABOUT COAXIAL CABLE

Use high-quality 50-Ohm coaxial cable for the lead-in to your FT DX 9000 Contest transceiver. All efforts at providing an efficient antenna system will be wasted if poor quality, lossy coaxial cable is used. This transceiver utilizes standard "M" ("PL-259") type connectors, except for the "RX OUT" BNC connectors used for special filters, etc.



Typical PL-259 Installation

INSTALLATION AND INTERCONNECTIONS

GROUNDING

The FT DX 9000 Contest HF transceiver, like any other HF communications apparatus, requires an effective ground system for maximum electrical safety and best communications effectiveness. A good ground system can contribute to station efficiency in a number of ways:

- It can minimize the possibility of electrical shock to the operator.
- It can minimize RF currents flowing on the shield of the coaxial cable and the chassis of the transceiver; such currents may lead to radiation which can cause interference to home entertainment devices or laboratory test equipment.
- It can minimize the possibility of erratic transceiver/accessory operation caused by RF feedback and/or improper current flow through logic devices.

An effective earth ground system make take several forms; for a more complete discussion, see an appropriate RF engineering text. The information below is intended only as a guideline.

Typically, the ground connection consists of one or more copper-clad steel rods, driven into the ground. If multiple ground rods are used, they should be positioned in a “V” configuration, and bonded together at the apex of the “V” which is nearest the station location. Use a heavy, braided cable (such as the discarded shield from type RG-213 coaxial cable) and strong cable clamps to secure the braided cable(s) to the ground rods. Be sure to weatherproof the connections to ensure many years of reliable service. Use the same type of heavy, braided cable for the connections to the station ground bus (described below).

Inside the station, a common ground bus consisting of a copper pipe of at least 25 mm (1”) diameter should be used. An alternative station ground bus may consist of a wide copper plate (single-sided circuit board material is ideal) secured to the bottom of the operating desk. Grounding connections from individual devices such as transceivers, power supplies, and data communications devices (TNCs, etc.) should be made directly to the ground bus using a heavy, braided cable.

Do not make ground connections from one electrical device to another, and thence to the ground bus. This so-called “Daisy-Chain” grounding technique may nullify any attempt at effective radio frequency grounding. See the drawing below for examples of proper grounding techniques.

Inspect the ground system - inside the station as well as outside - on a regular basis so as to ensure maximum performance and safety.

Besides following the above guidelines carefully, note that household or industrial gas lines must never be used in an attempt to establish an electrical ground. Cold water pipes may, in some instances, help in the grounding effort, but gas lines represent a significant explosion hazard, and must never be used.

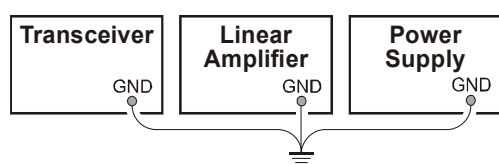

PROPER GROUND CONNECTION

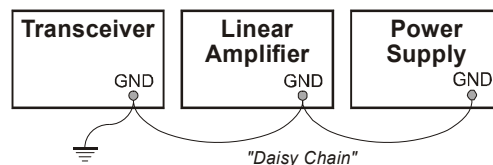

IMPROPER GROUND CONNECTION

INSTALLATION AND INTERCONNECTIONS

CONNECTION OF ANTENNA AND POWER CABLES

Please follow the outline in the illustration regarding the proper connection of antenna coaxial cables, as well as the AC power cable.

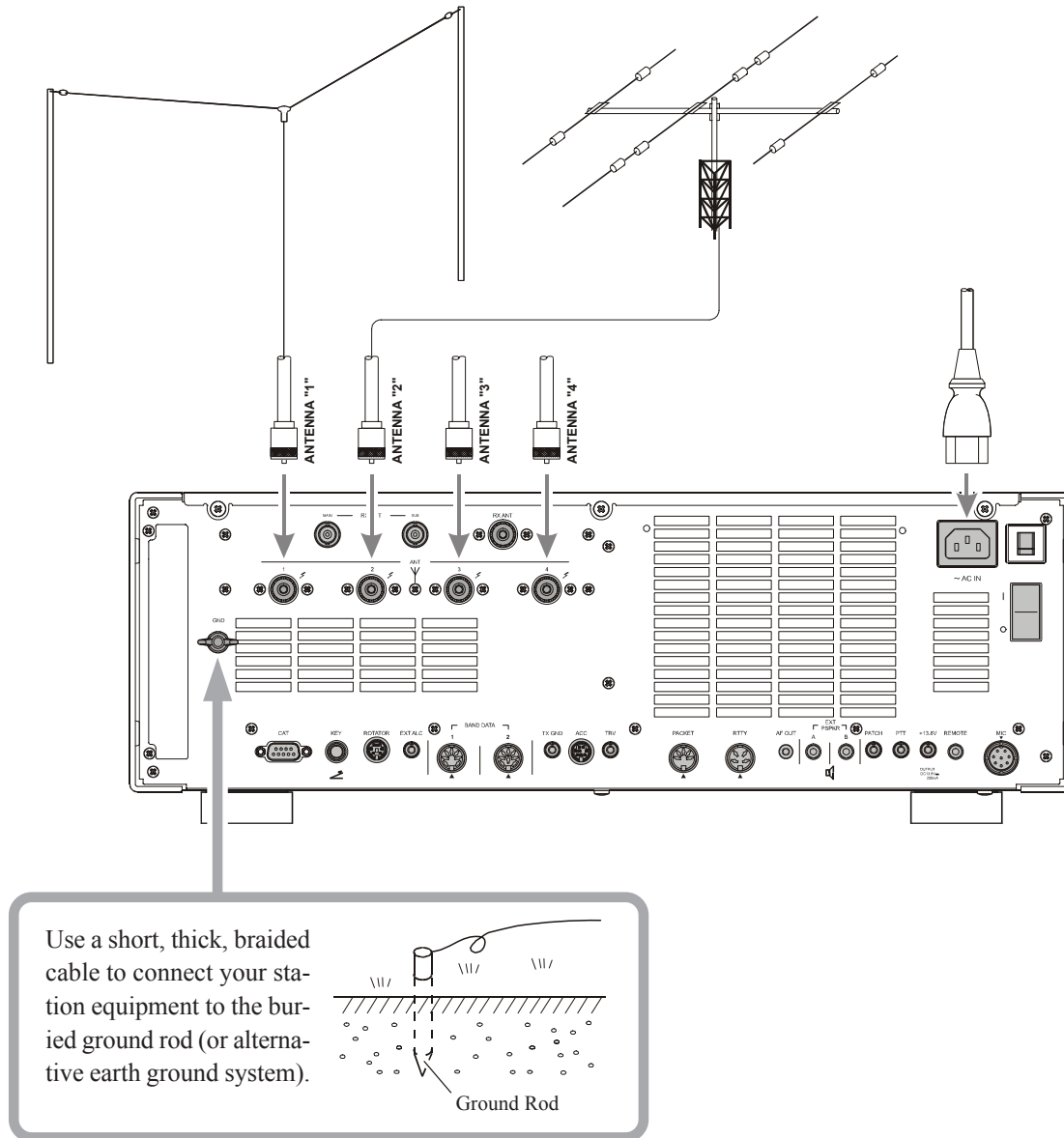

『Advice』

- Do not position this apparatus in a location with direct exposure to sunshine.
- Do not position this apparatus in a location exposed to dust and/or high humidity.
- Ensure adequate ventilation around this apparatus, so as to prevent heat build-up and possible reduction of performance due to high heat.
- Do not install this apparatus in a mechanically-unstable location, or where objects may fall onto this product from above.
- To minimize the possibility of interference to home entertainment devices, take all precautionary steps including separation of TV/FM antennas from Amateur transmitting antennas to the greatest extent possible, and keep transmitting coaxial cables separated from cables connected to home entertainment devices.
- Ensure that the AC power cord is not subject to undue stress or bending, which could damage the cable or cause it to be accidentally unplugged from the rear panel AC input jack.
- Be absolutely certain to install your transmitting antenna(s) such that they cannot possibly come in contact with TV/FM radio or other antennas, nor with outside power or telephone lines.

INSTALLATION AND INTERCONNECTIONS

CONNECTION OF MICROPHONE, HEADPHONES AND FH-2 REMOTE CONTROL KEYPAD

This transceiver was shipped from the factory in configuration for a microphone input via the *Front Panel XLR connector*. To use the *Rear Panel microphone* with an 8-pin round connector, please change the microphone set up via the Menu.

1. To do this, first press the **[MNU]** key.
2. The Menu list will appear on the LCD display screen.
3. Rotate the **[Main]** tuning dial to select menu item “**MODE-SSB 069 SSB MIC SELECT.**”
4. Now rotate the **[CLAR/VFO-B]** knob to change the setting to *Rear*.
The available selections are FRONT-REAR-DATA-PC.
5. To save the set-up, press and hold in the **[MNU]** key for 2 seconds.
If the **[MNU]** key is not held for 2 seconds, the set-up will not be saved.

[Note]: To use the AM or FM mode, please select Menu items 040 for AM and 059 for FM, and follow the same procedure above.

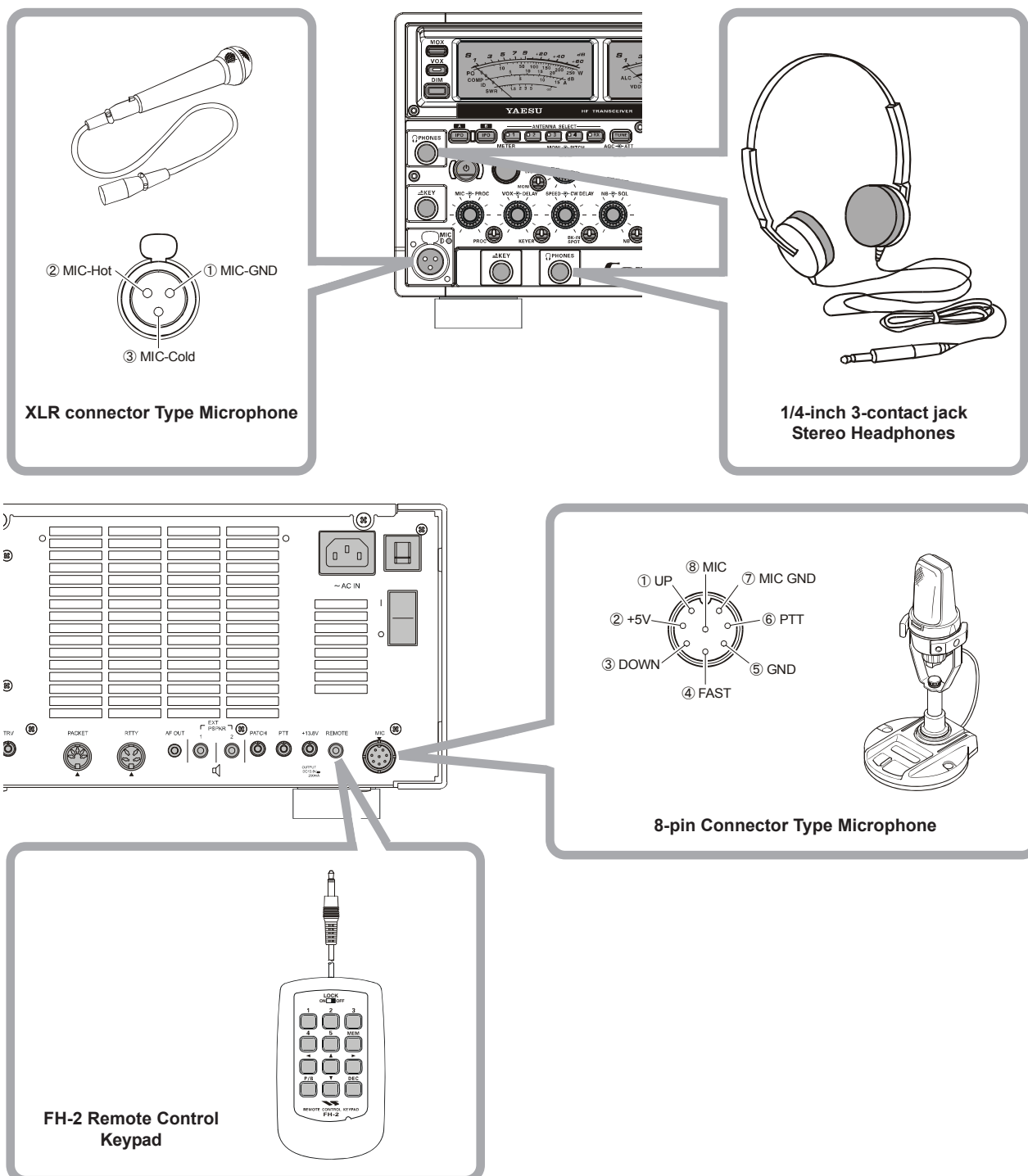

INSTALLATION AND INTERCONNECTIONS

KEY, KEYSER, AND COMPUTER-DRIVEN KEYING INTERCONNECTIONS

The FT DX 9000 Contest includes a host of features for the CW operator, the functions of which will be detailed in the “Operation” section later. Besides the built-in Electronic Keyer, two key jacks are provided, one each on the front and rear panels, for convenient connection to keying devices.

The Menu system allows you to configure the front and rear panel KEY jacks according to the device you wish to connect. For example, you may connect your keyer paddle to the front panel KEY jack, and use Menu #42 for paddle input, while connecting the rear panel’s KEY jack to the keying line from your personal computer (which emulates a “straight key” for connection purposes), and configure the rear panel jack using Menu #44.

Both KEY jacks on the FT DX 9000 Contest utilize “Positive” keying voltage. Key-up voltage is approximately +5V DC, and key-down current is approximately 1 mA.

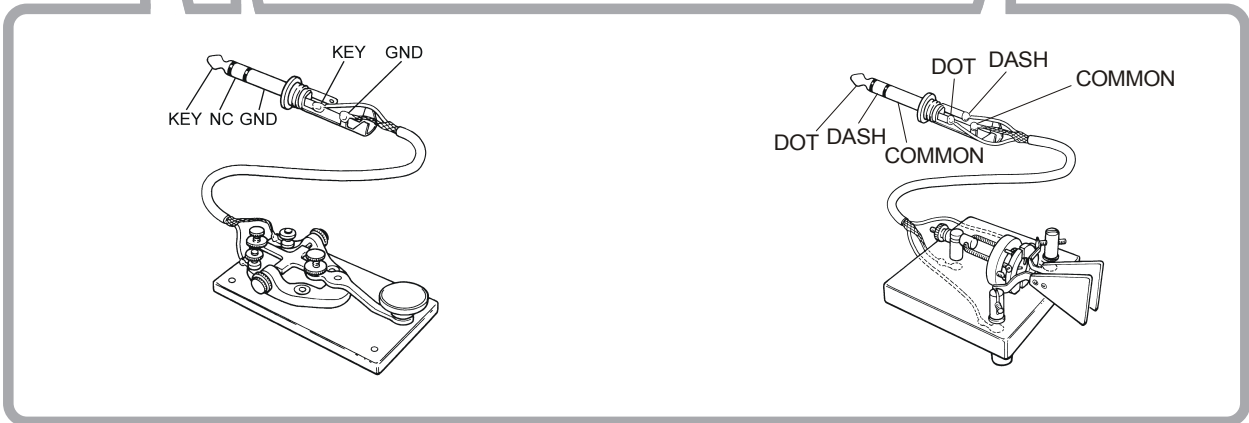
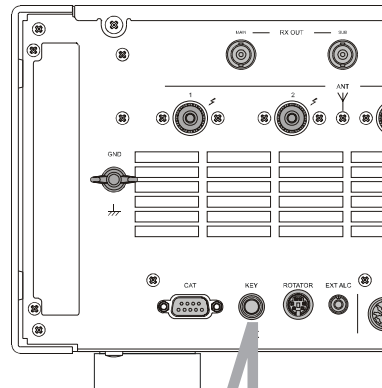
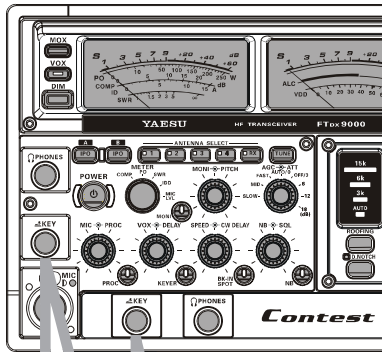

『Advice』

When connecting a key or other device to the KEY jacks, use only a 3-pin (“stereo”) 1/4” phone plug; a 2-pin plug will place a short between the ring and (grounded) shaft of the plug, resulting in a constant “key-down” condition in some circumstances.

INSTALLATION AND INTERCONNECTIONS

VL-1000 LINEAR AMPLIFIER INTERCONNECTIONS

Be sure that both the FT DX 9000 Contest and VL-1000 are turned off, then follow the installation recommendations contained in the illustration.

On the rear panel of the VL-1000, please set the “ATT” switch to the “ON” position. The 200-Watt power output from the FT DX 9000 Contest is far in excess of what is required to drive the VL-1000 to its full rated output.

『Note』

- Please refer to the VL-1000 Operating Manual for details regarding amplifier operation.
- Please do not attempt to connect or disconnect coaxial cables when your hands are wet.

Control Cable Modification

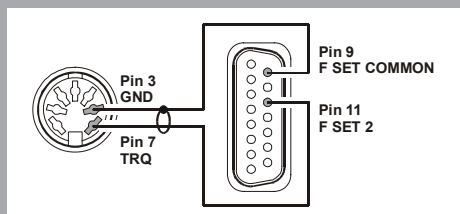

Please cut off the RCA connector on one end of the CONTROL Cable supplied with the VL-1000, and install a 7-pin DIN connector in its place, according to the illustration.

About the CONTROL Cable

The VL-1000 may be operated with the FT DX 9000 Contest whether or not the CONTROL Cable is connected; however, the CONTROL Cable allows you to tune up the amplifier automatically by just pressing the [F SET] or [TUNE] key on the VL-1000, so as to transmit a carrier for tuning purposes.

To link the FT DX 9000 Contest and VL-1000 Power switches, set the VL-1000 REMOTE switch to the ON position.

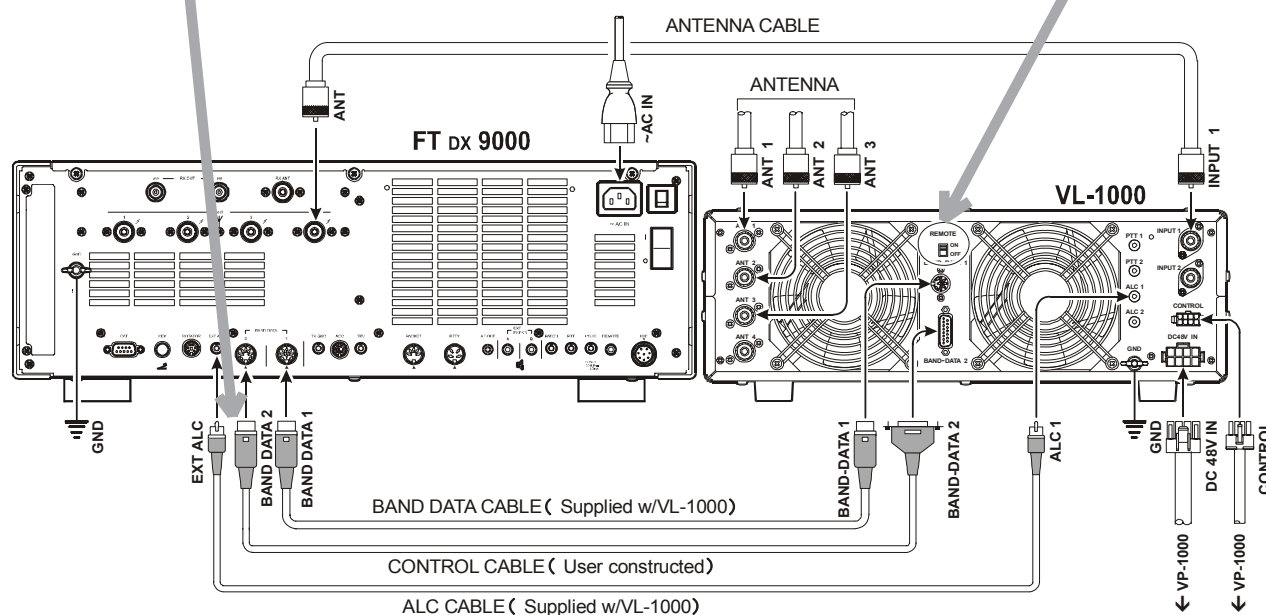

INSTALLATION AND INTERCONNECTIONS



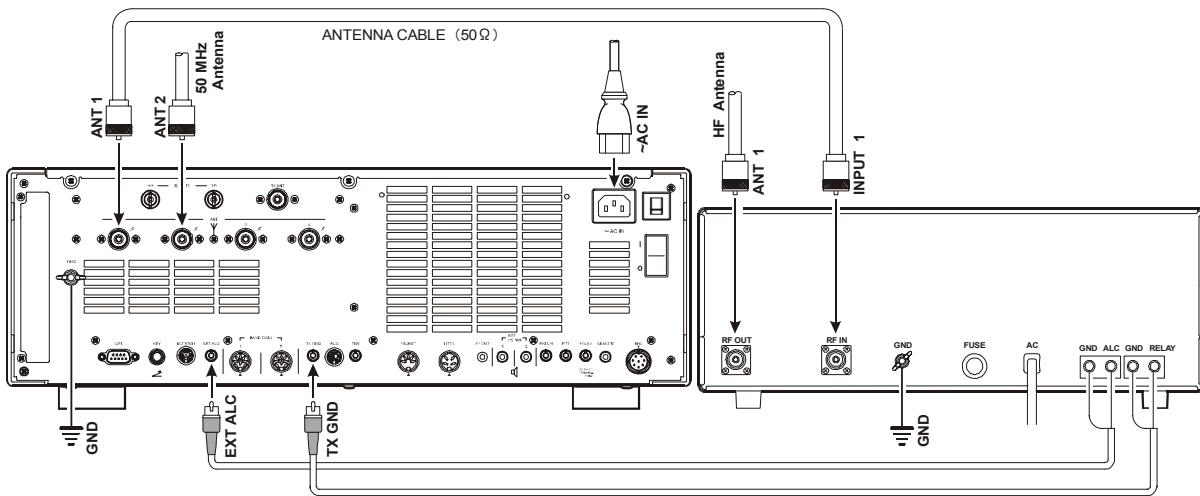

INTERFACING TO OTHER LINEAR AMPLIFIERS

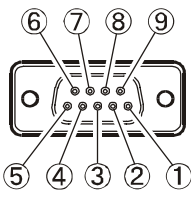
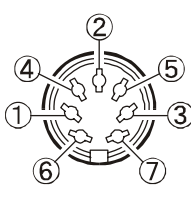

『Note』

- The TX/RX switching in the linear amplifier is controlled by switching components in the transceiver. The relay circuit of the FT DX 9000 Contest used for this switching is capable of switching AC voltage of 100 Volts at up to 300 mA, or DC voltages or 60 V at 200 mA or 30 V at up to 1 Amp. In order to engage the switching relay, use Menu item “**TX GNRL 156 EXT AMP TX-GND**” within the “TX GNRL” Menu Group; set this Menu selection to “ENABLE” to activate the amplifier switching relay.
- The specified range for ALC voltage to be used with the FT DX 9000 Contest is 0 to -4 Volts DC.
- Amplifier systems utilizing different voltages will not work correctly with the FT DX 9000 Contest, and their ALC lines must not be connected if this is the case.

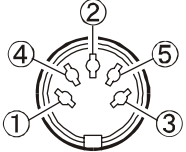
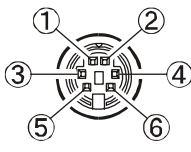
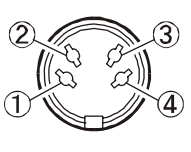
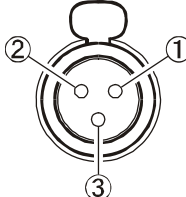
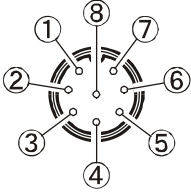
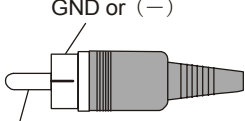
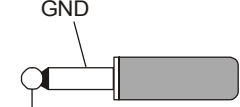
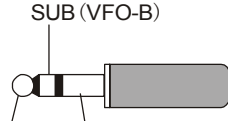
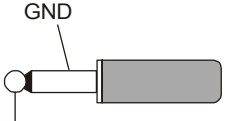
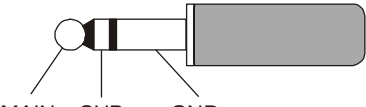
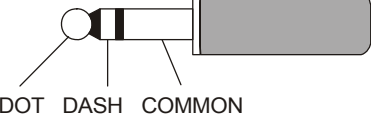
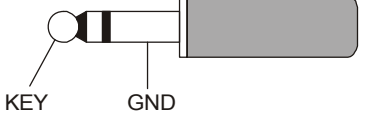
PLUG/CONNECTOR PINOUT DIAGRAMS

CAT	BAND DATA1	BAND DATA2
 <p>① N/A ② SERIAL OUT ③ SERIAL IN ④ N/A ⑤ GND ⑥ N/A ⑦ N/A ⑧ N/A ⑨ NC</p> <p>(as viewed from rear panel)</p>	 <p>① EXT ALC ② TX GND ③ GND ④ NC ⑤ NC ⑥ TXINH ⑦ FSET</p> <p>(as viewed from rear panel)</p>	 <p>① +13V ② TX GND ③ GND ④ BAND DATA A ⑤ BAND DATA B ⑥ BAND DATA C ⑦ BAND DATA D ⑧ LINEAR</p> <p>(as viewed from rear panel)</p>
PACKET	ROTATOR	RTTY
 <p>① DATA IN ② GND ③ PTT ④ DATA OUT ⑤ BUSY</p> <p>(as viewed from rear panel)</p>	 <p>① RT1 ② RT2 ③ RT3 ④ RT4 ⑤ GND ⑥ NC</p> <p>(as viewed from rear panel)</p>	 <p>① RX OUT ② PTT ③ GND ④ SHIFT</p> <p>(as viewed from rear panel)</p>
MIC (XLR)	MIC	RCA PLUG
 <p>① MIC-GND ② MIC-Hot ③ MIC-Cold</p> <p>(as viewed from front panel)</p>	 <p>① UP ② +5V ③ DOWN ④ FAST ⑤ GND ⑥ PTT ⑦ MIC GND ⑧ MIC</p> <p>(as viewed from rear panel)</p>	 <p>GND or (-) SIGNAL or (+)</p>
REMOTE	AF OUT	EXT SPKR
 <p>GND SIGNAL</p>	 <p>SUB (VFO-B) MAIN (VFO-A) GND</p>	 <p>GND SIGNAL</p>
PHONE	KEY	
 <p>MAIN SUB GND</p>	<p><i>For Internal Keyer</i></p>  <p>DOT DASH COMMON</p>	<p><i>For Straight Key</i></p>  <p>KEY GND</p> <p> Do not use 2-conductor type plug</p>

FRONT PANEL CONTROLS

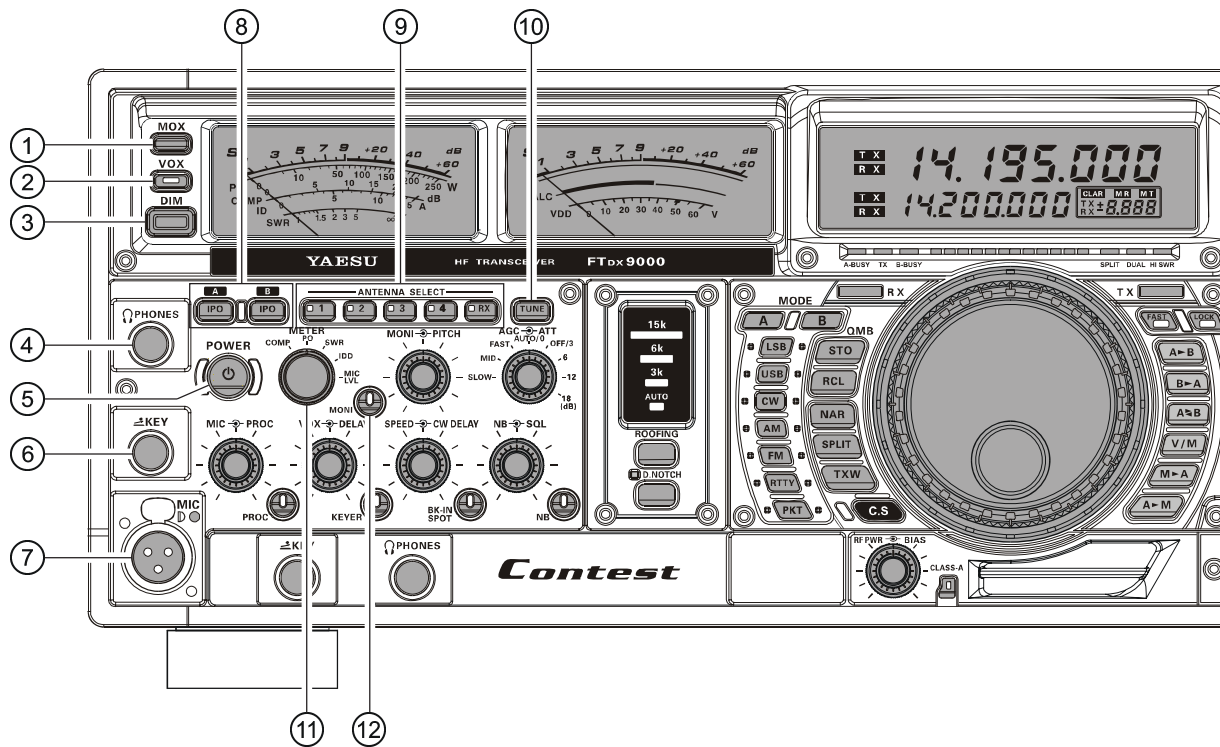

① MOX Switch

Pressing this button engages the PTT (Push to Talk) circuit, to activate the transmitter. It must be in the undepressed position for reception. This switch replicates the action of the Push to Talk (PTT) switch on the microphone. When engaging the **【MOX】** switch, or otherwise causing a transmission to be started, be certain you have either an antenna or 50-Ohm dummy load connected to the selected Antenna jack.

② VOX Switch

VOX Operation: This button enables automatic voice-actuated transmitter switching in the SSB, AM, and FM modes. While activated, the LED inside this button glows red. The controls affecting VOX operation are the front panel's **【VOX】** and **【DELAY】** knobs (see section (17) below. By proper adjustment of these controls, hands-free voice-actuated operation is possible.

③ DIM Switch

Press this button to lower the illumination intensity of the analog meters, the frequency display, and the LCD. Press it once more to restore full brightness.

『Advice』

Menu Items “**DISPLAY 014 DIMMER-METER**” and “**DISPLAY 015 DIMMER-VFD**” allow you to configure the dimming levels for the analog meters and the frequency display/LCD independently, so you can customize the brightness levels.

④ PHONES Jack

A 1/4-inch, 3-contact jack accepts either monaural or stereo headphones with 2- or 3-contact plugs. When a plug is inserted, the loudspeaker is disabled. With stereo headphones such as the optional YH-77STA, you can monitor both VFO-A and VFO-B receiver channels at the same time during Dual Receive operation. Note: When wearing headphones, we recommend that you turn the AF Gain levels down to their lowest settings before turning power on, to minimize the impact on your hearing caused by audio “pops” during switch-on.

⑤ POWER Switch

Press and hold in this switch for two seconds to turn the transceiver on, after first setting the rear panel Power switch to the “**I**” position. Press and hold in this switch for two seconds, similarly, to turn the transceiver off. If the rear panel's Power switch is set to the “**O**” position, the front panel **【POWER】** switch will not function.

『Advice』

This is the actual power On/Off switch for turning on the transceiver. When the rear panel's Power switch is set to the (I) position, power is supplied to the OCXO to stabilize the reference oscillator, and the remainder of the transceiver is set in a “stand-by” mode, awaiting the command for the transceiver to switch on via the front panel **【POWER】** switch. For further information on the rear panel Power switch, please see the discussion on page 34.

⑥ KEY Jack

This 1/4-inch, 3-contact jack accepts a CW key or keyer paddles (for the built-in electronic keyer), or output from an external electronic keyer. Pinout is shown on page 16. Key up voltage is 5 V, and key down current is 1 mA. This jack may be configured for keyer, “Bug,” “straight key,” or computer keying interface operation via Menu Selection “**MODE-CW 041 F-KEYER TYPE**” (see page 120). There is another jack with the same name on the rear panel, and it may be configured independently for Internal Keyer or pseudo-straight-key operation.

『Note』

You cannot use a 2-contact plug in this jack (to do so produces a constant “key down” condition).

⑦ Cannon (“XLR”) Microphone Connector

This Cannon-type (XLR) connector accepts input from the Microphone or other XLR-equipped microphone system. MIC connector pinout is shown on page 15. Proper microphone input impedance is 500 ~ 600 Ohms.

If you are using a condenser microphone requiring 48 Volts DC, you may enable this voltage to appear on the microphone line; see page 67. When the 48-volt supply line has been enabled, the LED adjacent to the MIC jack will glow red.

To disconnect the microphone plug, draw out the microphone plug while pressing and holding in the silver push-button.

⑧ IPO (Intercept Point Optimization) Switch

The **【IPO(A)】** Lamp-button may be used to set the optimum receiver front end characteristics of the VFO-A circuit for a very strong-signal environment. Selecting IPO bypasses the front end RF amplifier and feeds the received signals directly to the first mixer of the VFO-A receiver circuit. While the IPO feature is activated, this button will remain illuminated.

The **【IPO(B)】** Lamp-button, similarly, allows direct feed of the received signals to the first mixer of the VFO-B circuit. While the IPO feature is activated on the VFO-B, this button will be lit.

『Advice』

The FT DX 9000 Contest’s first mixer is an active type, using four SST310 Junction FETs. This mixer design provides gain to the receiver chain, so the noise figure of the receiver is fundamentally lower than with some other designs. Therefore, it frequently is not necessary to utilize the RF preamplifier, and the receiver Intercept Point will be substantially increased by engaging IPO, so as to feed the incoming signals directly to the first (active) mixer. We recommend that IPO be switched on whenever possible.

⑨ ANTENNA SELECT Switches

These momentary buttons select the antenna jack on the rear panel, with the selection indicated by the LED in each button. When an antenna has been selected for operation on the VFO-A, the LED in the button glows red. When an antenna has been selected for operation on the VFO-B, the LED in the button glows amber.

⑩ TUNE Switch

This is the on/off switch for the FT DX 9000 Contest’s Automatic Antenna Tuner.

Pressing this button momentarily places the antenna tuner in line between the transmitter final amplifier and the antenna jack (the LED will become illuminated). Reception is not affected.

Pressing and holding in this button for 1/2 second, while receiving in an amateur band, activates the transmitter for a few seconds while the automatic antenna tuner rematches the antenna system impedance for minimum SWR. The resulting setting is automatically stored in one of the antenna tuner’s 100 memories, for instant automatic recall later when the receiver is tuned near the same frequency.

Pressing this button momentarily, while the Tuner is engaged, will take the Automatic Antenna tuner out of the transmit line.

『Note』

When the Automatic Antenna tuner is tuning itself, a signal is being transmitted. Therefore, be absolutely certain that an antenna or dummy load is connected to the selected antenna jack before pressing and holding in the **【TUNE】** button to start antenna tuning.

⑪ METER Switch

This control switch determines the function of the Main Meter during transmission.

COMP: Indicates the RF speech compressor level (SSB modes only).

PO: Indicates the power output level.

SWR: Indicates the Standing Wave Ratio (Forward: Reflected).

IDD: Indicates the final amplifier drain current.

MIC LVL: Indicates the relative microphone level.

⑫ MONI (Monitor) Switch

This button enables the transmit (RF) monitor in all modes (except CW, in which the monitor function is always on, to produce the sidetone). While activated, the LED in this button glows red. Adjustment of the Monitor level is accomplished using the **【MONI】** knob, located just to the right of the **【MONI】** switch.

『Advice』

When using headphones, the Monitor is highly useful for making adjustments to the Parametric Equalizer or other voice quality adjustments, because the voice quality heard in the headphones is such a “natural” reproduction of the transmitted audio quality.

FRONT PANEL CONTROLS

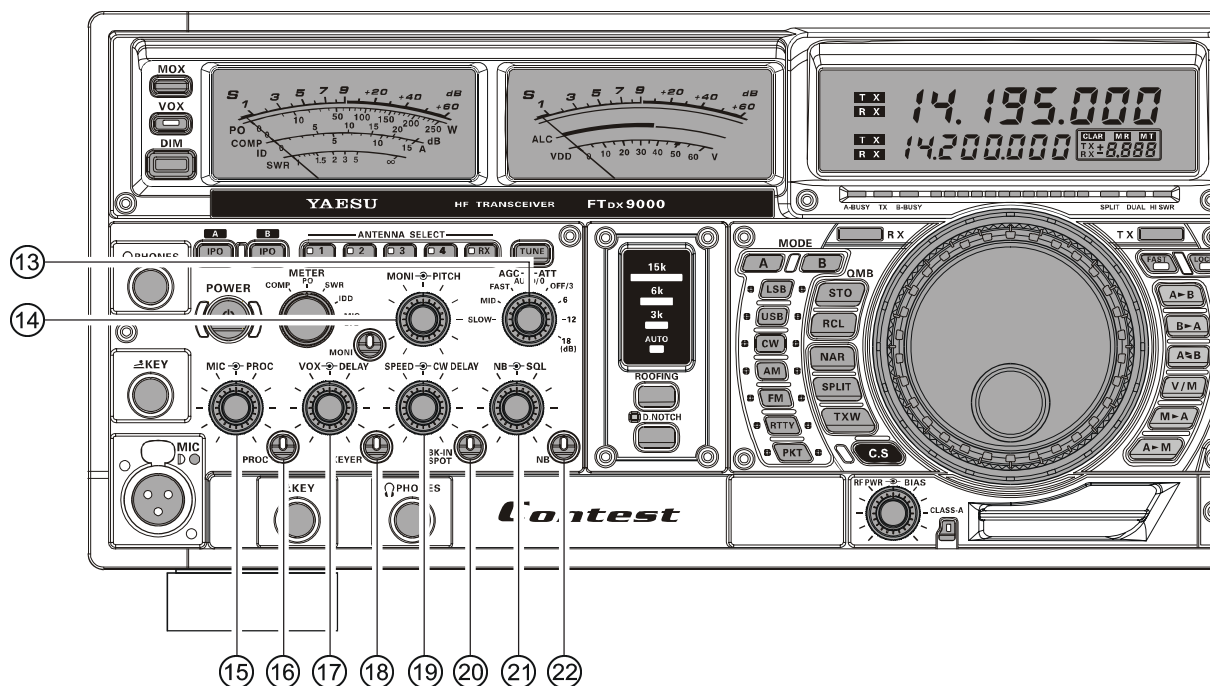

13 AGC → ATT Knobs

AGC Knobs

This switch selects the AGC characteristics for the VFO-A.

ATT Knobs

This switch selects the degree of attenuation, if any, to be applied to the VFO-A.

『Advice』

The Attenuator may be used in conjunction with the IPO switch (#8), described previously) to provide two stages of signal reduction when an extremely strong signal is being received.

14 MONI → PITCH Knobs

MONI Knob

The inner **MONI** knob adjusts the audio level of the transmit RF monitor during transmission (relative to the **AF GAIN** control: #73, described later), when activated by the **MONI** button (#12, described previously).

PITCH Knob

The outer **PITCH** knob selects your preferred CW tone pitch (from 300 ~ 1000 Hz, in 50 Hz increments). The Tx sidetone, receiver IF passband, and display offset from the BFO (carrier) frequency are all affected simultaneously. The Pitch control setting also affects the operation of the CW Tuning Indicator, as the center frequency of the CW Tuning Indicator will follow the setting of this control.

15 MIC → PROC Knobs

MIC Knob

The inner **MIC** knob adjusts the microphone input level for (non-processed) SSB transmission.

『Advice』

If you adjust the MIC Gain while speaking in a louder-than-normal voice level and watching the ALC level on the right-side meter, adjust the MIC Gain so that the ALC reaches over to the right edge of the ALC scale. Then, when you speak in a more normal voice level, you'll be certain not to be over-driving the mic amplifier stage.

PROC Knob

The outer **PROC** knob sets the compression (input) level of the transmitter RF speech processor in the SSB and modes, when activated by the button with the same name (see next section).

16 PROC (Processor) Switch

This button enables the RF speech processor for SSB transmission. Processing level is set by the outer control with the same name (see previous section). While activated, the LED in this button glows red.

『Advice』

The Speech Processor is a tool for increasing the average power output through a compression technique. However, if the PROC level control is advanced too far, the increase in compression becomes counter-productive, as intelligibility will suffer. We recommend that you monitor the sound of your signal using the Monitor (with headphones), then advance the PROC level only as far as required to obtain a useful increase in average power output.

When the optional Data Management Unit (DMU-9000) and TFT Display Unit (TFT-9000) are installed, you

may use the Audio Scope/Oscilloscope page on the TFT to help you adjust the setting of the Compression Level of the Speech Processor for the optimum performance using your voice and microphone.

⑰ VOX DELAY Knobs

VOX Knob

The inner **【VOX】** knob sets the gain of the VOX circuit, to set the level of microphone audio needed to activate the transmitter during voice operation while the **【VOX】** switch (#②, described previously) is engaged. The **【VOX】** switch must be switched On to engage the VOX circuit.

DELAY Knob

The outer **【DELAY】** knob sets the hang time of the VOX circuit, between the moment you stop speaking, and the automatic switch from transmit back to receive. Adjust this for smooth VOX operation, so the receiver is only activated when your transmission is ended and you wish to receive.

For CW operation, you can adjust the keying delay separately; see control #⑱ below.

⑱ KEYER Switch

This button toggles the internal CW keyer on and off. While activated, the LED in this button glows red. The Keyer sending speed, and the CW Hang Time are adjusted via the controls described in the next section.

⑲ SPEED CW DELAY Knobs

The internal Electronic Keyer is activated by the **【KEYER】** switch, described in the previous section.

SPEED Knob

The inner **【SPEED】** knob adjusts the keying speed of the internal CW keyer. Clockwise rotation increases the sending speed.

CW DELAY Knob

This outer **【CW DELAY】** knob sets the hang time of the CW “VOX” circuit, between the moment you stop sending, and the automatic switch from transmit back to receive during “Semi-break-in” operation. Adjust this just long enough to prevent the receiver from being restored during word spaces at your preferred sending speed. Clockwise rotation increases the hang time.

『Note』

The SSB VOX hang time is adjusted via the **【DELAY】** control (#⑰, described previously).

⑳ BK-IN/SPOT Switches

This button turns the full break-in (QSK) CW capability on and off. While QSK is activated, the LED in this button glows red.

The **【SPOT】** button turns on the CW receiver spotting tone; by matching the SPOT tone to that of the incoming CW signal (precisely the same pitch), you will be “zero beating” your transmitted signal on to the frequency of the other station.

㉑ NB/SQL Knobs

NB Knob

The inner **【NB】** knob adjusts the noise blanking level when the (analog) IF noise blanker is activated by pressing the **【NB】** switch (#㉒ below). The Noise Blanker is activated via the **【NB】** switch, described in the next section.

SQL Knob

The outer **【SQL】** knob sets the signal level threshold at which VFO-A audio is muted, in all modes. It is very useful during local rag-chews, to eliminate noise between incoming transmissions. This control is normally kept fully counter-clockwise (off), except when scanning and during FM operation.

㉒ NB Switch

Pressing this button activates the (analog) IF Noise Blanker, which may help reduce many different types of man-made impulse noise (but not atmospheric). When the Noise Blanker is activated, the LED inside the button will glow red. Adjustment of the Noise Blanker level is accomplished via the **【NB】** knob (#㉑ above), described in the previous section.

FRONT PANEL CONTROLS

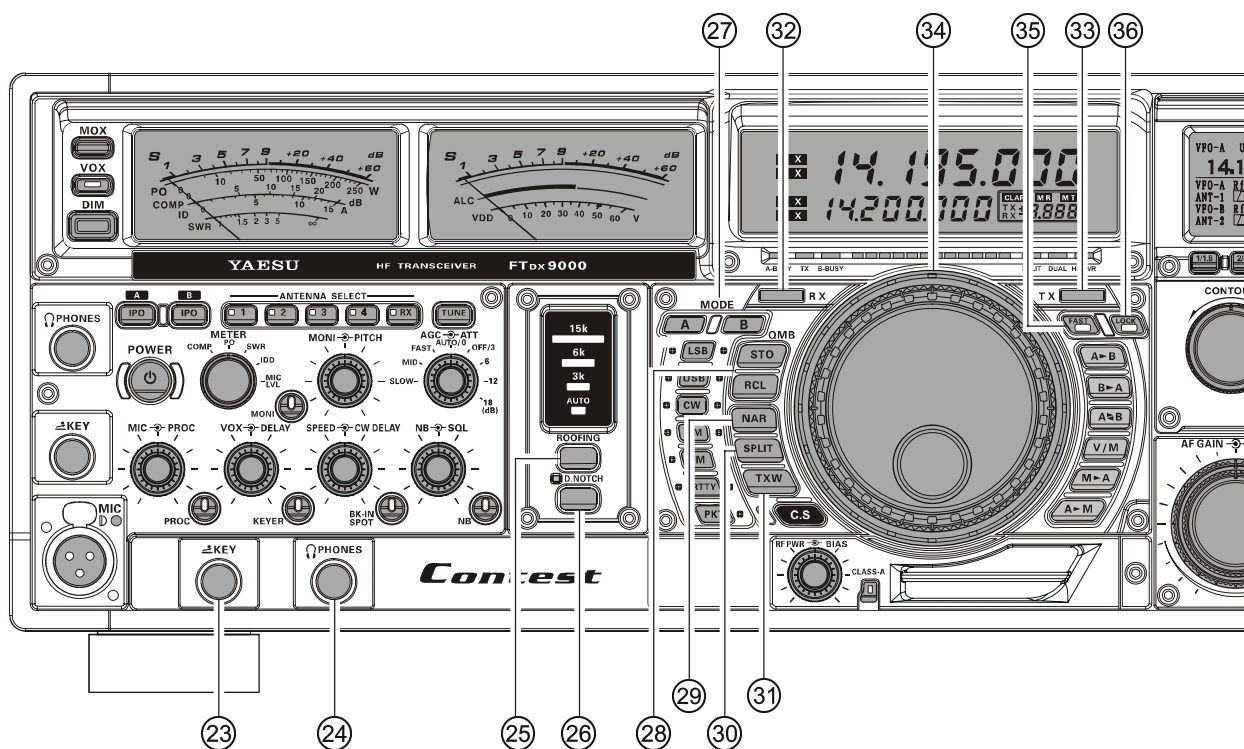

23 KEY Jack

This 1/4-inch, 3-contact jack accepts a CW key or keyer paddles (for the built-in electronic keyer), or output from an external electronic keyer. Pinout is shown on page 16. Key up voltage is 5 V, and key down current is 1 mA. This jack may be configured for keyer, “Bug,” “straight key,” or computer keying interface operation via Menu item “**MODE-CW 041 F-KEYER TYPE**” (see page 120). There is another jack with the same name on the rear panel, and it may be configured independently for Internal Keyer or pseudo-straight-key operation.

『Note』

This Key jack is connected in parallel with the jack with the same name on the front panel.

You cannot use a 2-contact plug in this jack (to do so produces a constant “key down” condition).

24 PHONES Jack

A 1/4-inch, 3-contact jack accepts either monaural or stereo headphones with 2- or 3-contact plugs. When a plug is inserted, the loudspeaker is disabled. With stereo headphones such as the optional YH-77STA, you can monitor both VFO-A and VFO-B channels at the same time during Dual Receive operation.

『Note』

This Phones jack is connected in parallel with the jack with the same name on the front panel.

When wearing headphones, we recommend that you turn the AF Gain levels down to their lowest settings before turning power on, to minimize the impact on your hearing caused by audio “pops” during switch-on.

25 ROOFING Switch

This button selects the bandwidth for the VFO-A receiver’s first IF Roofing Filter. Available selections are 3 kHz, 6 kHz, 15 kHz, or Auto, and the LED indicator will change according to the bandwidth selected.

『Advice』

Because the roofing filter is in the first IF, the protection it provides against interference is quite significant. When set to AUTO, the SSB bandwidth is 6 kHz, while CW is 3 kHz and FM/RTTY are 15 kHz. On a crowded SSB band, however, you may wish to select the 3 kHz filter, for the maximum possible interference rejection.

26 D.NOTCH Switch

This button turns the VFO-A Digital Notch Filter on and off. When the Digital Notch Filter is activated, the LED indicator will glow red. This is an automatic circuit, and there is no adjustment knob for the D.NOTCH.

27 MODE Switches

A, B Button

Pressing the **[A]** or **[B]** switch will illuminate the respective indicator imbedded within the switch, allowing adjustment of the operating mode on the VFO-A or VFO-B. Pressing the **[A]** switch causes the indicator to glow Red, signifying VFO-A is being adjusted. Similarly, pressing the **[B]** switch will cause its indicator to glow Orange, signifying VFO-B adjustment.

『Advice』

When changing bands, be sure to press the **[A]** or **[B]** switch first, then press the appropriate Band selector switch, so as to change operating frequencies on the proper (VFO-A or VFO-B).

LSB, USB, CW, AM, FM, RTTY, PKT Button

Pressing the **[LSB]**, **[USB]**, **[CW]**, **[AM]**, **[FM]**, **[RTTY]**, or **[PKT]** button will select the operating mode. Pressing the **[CW]**, **[AM]**, **[RTTY]**, or **[PKT]** button multiple times will switch between the alternate operating features that can be used on these modes (covered later). Also, when you press and hold in the **[PKT]** button for one second, the user-programmed custom function setting mode will be activated.

28 QMB (Quick Memory Bank) Switch STO (Store) Button

Pressing this button copies operating information (frequency, mode, bandwidth, and also repeater direction/shift frequency and CTCSS functions on the FM mode) into consecutive QMB Memories.

RCL (Recall) Button

Pressing this button recalls one of up to five Quick Memory Bank memories for operation.

29 NAR (Narrow) Switch

In the SSB/CW mode, this button is used to set the bandwidth of the DSP IF filters to a user-programmed bandwidth (default values are SSB: 1.8 kHz, CW/RTTY/PSK: 300 Hz, AM: 6 kHz). When **[NAR]** has been engaged, the **[WIDTH]** knob will be disabled. In the AM mode, this button is used to toggle the receiver's bandwidth between wide (9 kHz) and narrow (6 kHz).

In the FM mode on the 28 MHz and 50 MHz bands, this button is used to toggle the FM deviation/bandwidth between wide (± 5.0 kHz Dev./25.0 kHz BW) and narrow (± 2.5 kHz Dev./12.5 kHz BW).

Pressing the **[A]** or **[B]** button (located above the MODE selection buttons) will select either the VFO-A or VFO-B for individual bandwidth setting.

『Advice』

When **[NAR]** has been engaged, the **[WIDTH]** knob will be disabled, although IF Shift still works normally.

30 SPLIT Switch

Pressing this button to activates split frequency operation between the VFO-A, used for transmission and VFO-B, used for reception. The same name LED located at the right of the main tuning knob glows orange while this function is active.

If you press and hold in the **[SPLIT]** switch for two seconds, the "Quick Split" feature will be engaged, whereby the VFO-B will automatically be set to a frequency 5 kHz higher than the VFO-A frequency, and the transceiver will be placed in the Split mode.

31 TXW "TX Watch" Switch

Pressing this key lets you monitor the transmit frequency when split frequency operation is engaged. When receiving on the transmit frequency, the LED indicator will glow green. Press this key again to return to normal operation.

32 RX Indicator/Switch

This switch, when pressed, engages the VFO-A; the indicator will glow Green when the VFO-A is active. When the VFO-A is active, pressing this button momentarily will mute the receiver, and the indicator will blink. Pressing the button once more will restore receiver operation, and the indicator will glow Green steadily.

33 TX Indicator/Switch

When this button is pushed, the indicator will glow Red, and the transmitter will be engaged on the same frequency and mode as was set up for the VFO-A (subject to any Clarifier offset, of course).

『Advice』

If this indicator is not illuminated, it means that the VFO-B TX indicator has been selected (it will be glowing Red). In this case, transmission will be effected on the frequency and mode programmed for the VFO-B.

34 Main Dial Knob

This large knob adjusts the operating frequency of the VFO-A or a recalled memory. Clockwise rotation of this knob increases the frequency. Default tuning increments are 10 Hz (100 Hz in AM and FM modes); when the **[FAST]** switch is pressed, the tuning steps increase. The available steps are:

Operating Mode	1 Step*	1 Dial Rotation
LSB/USB/CW/RTTY/PKT(LSB)	10 Hz (100 Hz)	10 kHz (100 kHz)
AM/FM/PKT(FM)	100 Hz (1 kHz)	100 kHz (1 MHz)

*Numbers in parentheses indicate steps when the **[FAST]** switch is On.

『Advice』

The tuning steps for the **[Main]** Tuning Dial (described in this section) are set, at the factory, to 10 Hz per step. Via Menu item "**TUNING 129 MAIN DIAL STEP**," however, you may change this setting from 10 Hz to 1 Hz instead. When 1 Hz basic steps are selected, the action of the **[FAST]** button (#35 below) will be changed to 1/10 of the values listed above.

35 FAST Switch

Pressing this button will increase or decrease the tuning rate of the **[Main]** Tuning Knob (#34 above) by a factor of ten, as mentioned in the previous section. When this function is activated, the LED inside the button will glow red.

36 LOCK Switch

This button toggles locking of the main tuning knob, to prevent accidental frequency changes. When the button is active, the **[Main]** Tuning Knob (#34, described previously) can still be turned, but the frequency will not change, and the LED inside the button will glow red.

FRONT PANEL CONTROLS

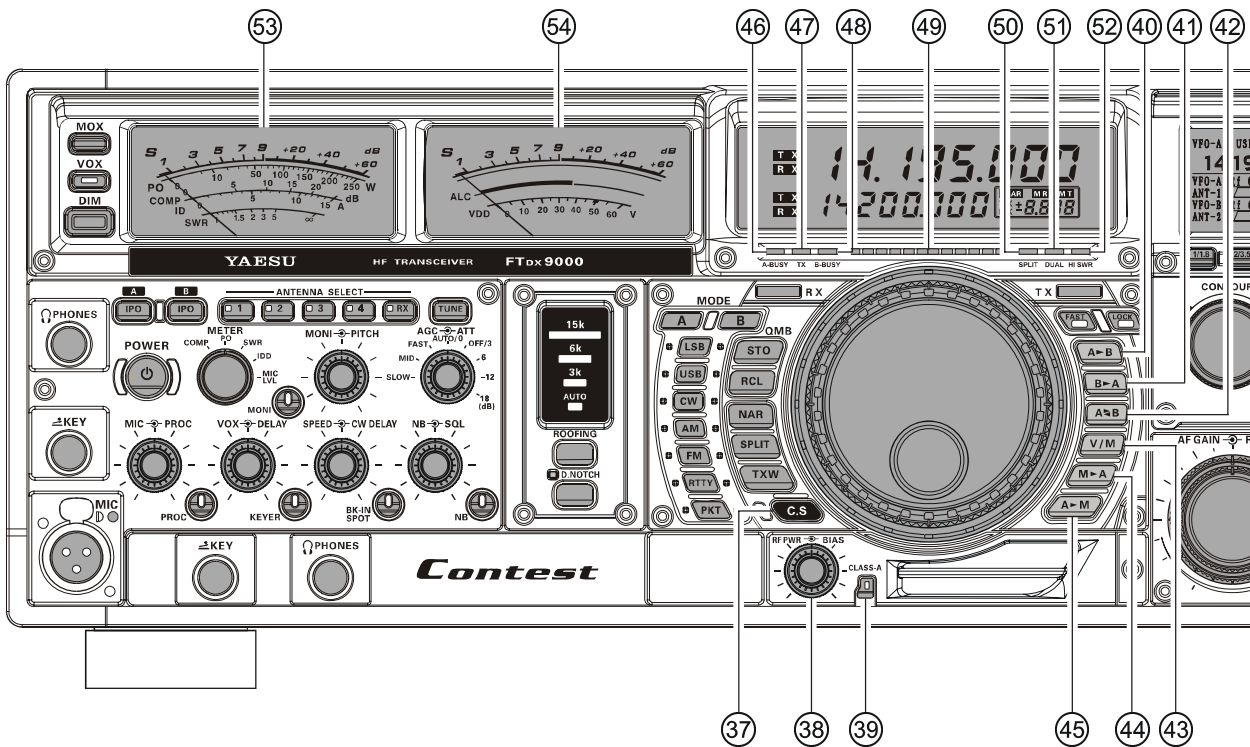

37 C.S Switch

Press this button momentarily to recall a favorite Menu Selection directly.

To program a Menu selection as the short-cut, press the **[MNU]** key (#72, described later) to enter the Menu, then select the item you want to set as the short-cut. Now press and hold in the **[C/S]** key for two seconds; this will lock in the selected Menu item as the short-cut.

38 RF PWR \rightarrow BIAS Knobs

RF PWR Knob

This is the main RF Power output control for the transceiver, active in all operating modes. Clockwise rotation increases the power output. Adjust this control for the desired power output from the FT DX 9000 Contest, or for the desired system output when using a linear amplifier or transverter.

BIAS Knob

During SSB operation, pressing the **[CLASS-A]** button (#39 below) will lower the power output to a maximum of 75 Watts, and the **[BIAS]** control will then provide adjustment of the final amplifier Bias level between classes AB and A. Full Class-A operation provides an ultra-clean SSB wave-form. Because Class A is a high-bias, low-efficiency mode, you should monitor the heat sink temperature (using the “SWR” page on the LCD periodically to ensure that the operating temperature is within the safe range, and you may adjust the Bias level more toward the “AB” side if the heat sink gets too warm. The power output will not change if you adjust the setting of the **[BIAS]** control.

39 CLASS-A Switch

Pressing this switch engages the Class-A capability for the transmitter. The power output will be reduced to a maximum of 75 Watts, and the Bias level may be adjusted using the **[BIAS]** control (#38 above), described in the previous section. When Class-A operation is engaged, the Red LED inside this switch will light up. Press this switch once more to return to Class AB operation at a maximum power output of 200 Watts; the Red LED will shut off to confirm Class AB operation.

40 A \blacktriangleright B Switch

Press this button momentarily to transfer data from the VFO-A frequency (or a recalled memory channel) to the VFO-B, overwriting any previous contents in the VFO-B. Use this key to set both VFO-A and VFO-B to the same frequency and mode.

41 B \blacktriangleright A Switch

Press this button momentarily to transfer data from the VFO-B frequency to the VFO-A, overwriting any previous contents in the VFO-A. Use this key to set both VFO-A and VFO-B to the same frequency and mode.

42 A \blacktriangleright B Switch

Pressing this button momentarily exchanges the contents of the VFO-A (or a recalled memory channel) and the VFO-B.

43 V/M Switch

This button toggles VFO-A operation between the memory system and the VFO. Either “VFO,” “MEM,” or “M TUNE” will be displayed to the left of the main frequency display field to indicate the current selec-

tion. If you have tuned off of a Memory channel frequency (M TUNE), pressing this button returns the display to the original memory contents (MEM), and pressing it once more returns operation to the VFO-A.

④④ **M▶A Switch**

Pressing this button momentarily displays the contents of the currently-selected memory channel for three seconds.

Holding this button in for 2 seconds copies the data from the currently-selected memory to the VFO-A, as two beeps sound. Previous data in the VFO-A will be overwritten.

④⑤ **A▶M Switch**

Pressing and holding in this key for 1/2 second (until the double beep) copies the current operating data from the VFO-A into the currently selected memory channel, overwriting any previous data stored there.

Also, pressing and holding in this button after recalling a memory, without first retuning, causes the memory channel to be “masked,” and repeating the process restores the masked memory.

④⑥ **A-BUSY Indicator**

This LED glows green whenever the VFO-A squelch is open. If this indicator is not illuminated, and reception seems to have been “lost” on the VFO-A for no apparent reason, check the position of the **【SQL】** control (#②①), described previously) and rotate it fully counter-clockwise to restore reception.

④⑦ **TX Indicator**

This indicator glows Red during transmission. If you attempt to transmit while operating outside of an Amateur band, this indicator will blink Red, indicating an “out of band” condition.

④⑧ **B-BUSY Indicator**

This LED glows green whenever the VFO-B squelch is open. If this indicator is not illuminated, and reception seems to have been “lost” on the VFO-B for no apparent reason, check the position of the **【SQL】** control (#②①), described previously) and rotate it fully counter-clockwise to restore reception.

④⑨ **Tuning Offset Indicator**

This is a tuning scale that, as configured from the factory, provides a visual CW tuning indication of the incoming signal’s offset from your transceiver’s CW carrier frequency, as programmed by the position of the **【PITCH】** control (#①④), described previously).

『Advice』

Using Menu item “**DISPLAY 016 BAR DISPLAY SELECT**,” you can choose indication of the CW - TUNE, Clarifier, VRF, or IF Notch function.

⑤⑩ **SPLIT Indicator**

This indicator glows Red when the “Split” mode is engaged (with the VFO-A and VFO-B operating on different frequencies).

⑤① **DUAL Indicator**

In the standard FT DX 9000 Contest version, this indicator does not function.

When the optional Dual Receive Unit (RXU-9000) is installed, the Dual Indicator will be available for use.

⑤② **HI SWR Indicator**

This indicator glows Red if the directional coupler and microprocessor detect an abnormally high SWR condition (over 3.0:1) that cannot be resolved by the Automatic Antenna Tuner.

『Note』

If this indicator lights up, check to be sure that you have the correct antenna selected on the current operating band. If so, you will need to check the condition of the antenna, its coaxial cable, and/or the connectors on the cable so as to locate and correct the fault.

⑤③ **S-Meter (VFO-A)**

There are five functions on the main multi-meter. The bottom five selections in the list below are transmit functions, determined by the position of the METER switch (#①①), described previously):

S: Indicates the received signal strength on the VFO-A, from S-0 to S9 +60 dB.

PO: Indicates the RF Power Output, from 0 to 250 Watts on transmit.

COMP: Indicates the compression level of the speech processor, from 0 to 20 dB.

IC: Indicates the final amplifier drain current (ID), from 0 to 15 A.

SWR: Indicates the antenna system observed standing wave ratio (SWR), from 1.0 to 5.0.

MIC LVL: Indicates the relative level of modulation from the microphone amplifier stage (affected by the setting of the **【MIC】** Gain control: #①⑤), described previously).

⑤④ **S-Meter (VFO-B)**

On receive, this meter displays signal strength of incoming signals as received on the VFO-B.

On transmit, this meter serves as the ALC meter. The function of this meter, on transmit, can be changed to indication or PA Voltage (VDD) via Menu item “**DISPLAY 019 RIGHT TX METER**.”

ALC: Display of relative ALC voltage. On SSB, the ALC level is chiefly controlled via the **【MIC】** Gain control (#①⑤), described previously).

VDD: Final amplifier FET Drain Voltage (nominal value: 50 V).

FRONT PANEL CONTROLS

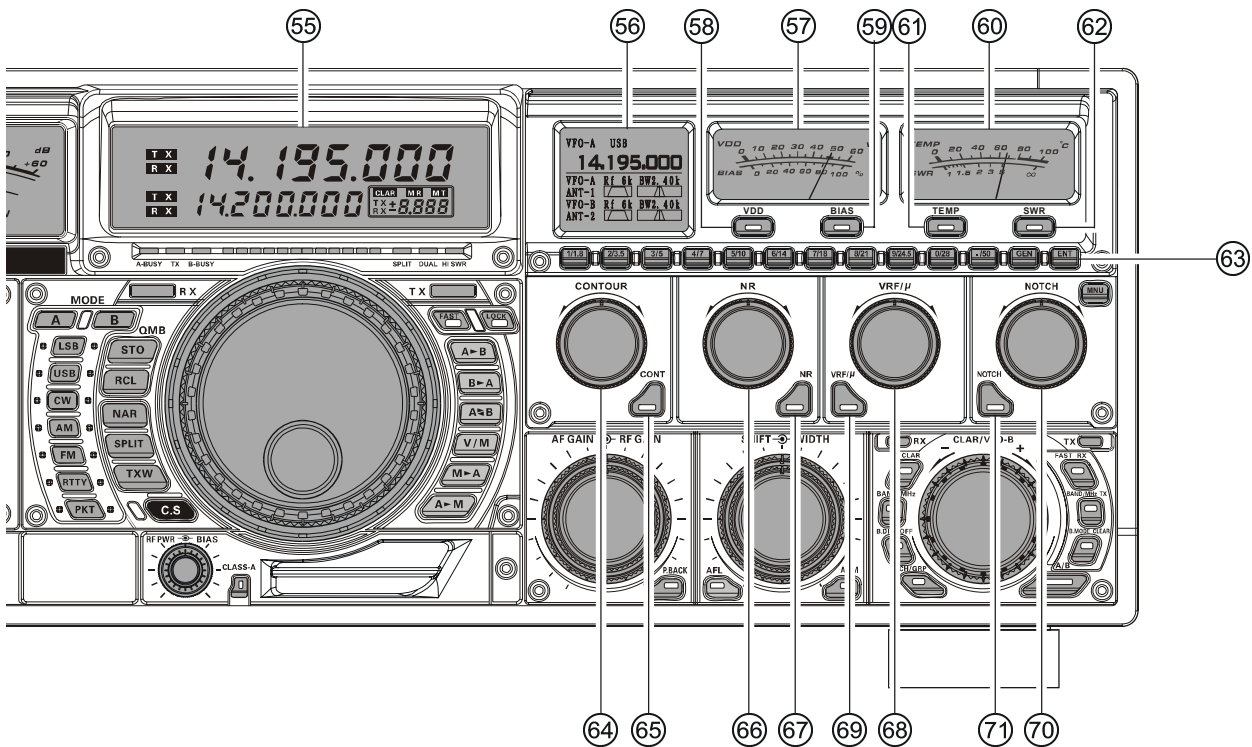

55 Frequency Display (See Page 36)

The upper large display field indicates the current operating frequency on the VFO-A, and its TX/RX status. The lower small display field indicates the current operating frequency on the VFO-B, and its TX/RX status.

56 LCD Display

This 1.8 inch LCD display is used for viewing the status of the VFO-A and VFO-B VFOs, and it indicates the Menu listing.

57 VDD/BIAS Meter

You may observe the Drain Voltage on the final amplifier FETs, using this meter. As well, the current Bias Level being utilized may be observed. Press the **[VDD]** (#58 below) or **[BIAS]** (#59 below) switch to select the desired information.

58 VDD Switch

Pressing this switch enables display of the final amplifier FET Drain Voltage on the **[VDD/BIAS]** meter (#57 above); a red LED will light up to confirm your selection. The display range is 0 ~ 60 Volts, and a reading of 50 Volts is normal during transmission.

59 BIAS Switch

Pressing this switch enables display of the final amplifier FET Bias Level currently in use; a red LED will light up to confirm your selection.

During Class-A operation, the Bias Level will indicate “0%” during Class AB operation, and “100%” during Class A. Because the power output is fixed when the “Class A” mode has been engaged, you may adjust the Bias Level, according to the measured temperature, anywhere between Class AB and Class A, without having to worry about the drive level being applied to your linear amplifier.

60 TEMP/SWR Meter

This meter allows monitoring of the heat sink temperature or the SWR as measured at the rear-panel Antenna jack.

Press the **[TEMP]** (#61 below) or **[SWR]** (#62 below) switch to select the desired display function.

61 TEMP Switch

Pressing this switch enables monitoring of the heat sink temperature; a red LED will light up to confirm your selection.

The measurement range for the temperature display is 0 °C ~ 100 °C, and there are four stages of cooling fan speed that will, progressively, increase the air flow if the temperature rises to near the “red zone” (80 °C or higher). Because of the advanced cooling system, there should never be a circumstance where the temperature will rise this high, but if you are operating in a hot environment, in Class A, and are making long transmissions, you may wish to reduce the Bias Level closer to Class AB to reduce the heat dissipation associated with Class A operation.

62 SWR Switch

Pressing this switch enables display of the antenna system SWR; a red LED will light up to confirm your selection. The SWR measured at the rear panel Antenna Jack will be displayed during transmission.

63 BAND Keys

These keys allow selection of the operating band. One key is provided for each Amateur band between 1.8 MHz and 50 MHz (except for the 60-meter band, covered via the Memory system).

As well, direct frequency entry of the desired operating frequency may be accomplished using these keys. If you press and hold in the **【ENT】** key for two seconds, the frequency display area will change to indicate the rotator position, if you have a YAESU G-800DXA/-1000DXA/-2800DXA rotator's control cable connected to the rear panel of the transceiver, and you can then control the position of the rotator from the front panel.

64 CONTOUR Knob

This knob selects the desired VFO-B CONTOUR filter response. The CONTOUR filter is engaged via the **【CONT】** switch (#65 below).

65 CONT Button

This button turns the CONTOUR filter on and off. When the CONTOUR filter is activated, the LED inside the button will glow amber. Adjustment of the CONTOUR filter's center frequency is provided by the **【CONTOUR】** knob (#64 above).

『Quick Note』

There are times, when you're trying to remove interference with a sharp DSP filter, that the remaining signal has a somewhat unnatural sound. This is caused by the cutting of some frequency components, leaving other components in excess. The CONTOUR filter allows you (especially) to roll off certain frequency components inside the remaining passband, but in a smooth manner that helps restore a natural sound and/or raise intelligibility.

『Advice』

- The action of the CONTOUR filter may be adjusted via Menu item “**RX DSP 078 MAIN-CONTOUR-LEVEL**” and “**RX DSP 079 MAIN-CONTOUR-WIDTH**.”
- When the optional Data Management Unit (DMU-9000) and TFT Display Unit (TFT-9000) are installed, you may use the Audio Scope on the Audio Scope/Oscilloscope page on the TFT to help you adjust the setting of the Contour control for the optimum performance. The effect of the Contour adjustments will be easy to see on the Audio Scope.

66 NR Knob

This knob selects the optimum VFO-A Digital Noise Reduction response. The Noise Reduction circuit is engaged via the **【NR】** switch (#67 below).

67 NR Switch

This button turns the Digital Noise Reduction circuit on and off. When the Digital Noise Reduction is activated, the LED inside the button will glow amber. Adjustment of the Noise Reduction level is provided by the **【NR】** knob (#66 above).

68 VRF/ μ Knob

This knob tunes the passband of the RF filter (18 MHz and higher Amateur bands) for maximum receiver sensitivity (and out-of-band interference rejection).

『Quick Point』

When the optional RF μ -Tuning Unit is installed, this knob allows adjustment of the center frequency of the μ -Tuning filter passband.

69 VRF/ μ Switch

This button turns the VRF filter on and off. While activated, the LED inside the button will glow red.

『Quick Point』

When the optional RF μ -Tuning Unit is installed, pressing this switch will engage the μ -Tuning preselector function. The μ -Tuning Units provide much better RF selectivity than any other RF filter in the Amateur industry, yielding outstanding protection from high RF levels not far removed from the current operating frequency.

70 NOTCH Knob

This adjusts the center frequency of the IF Notch filter, when engaged by the **【NOTCH】** switch (#71 below).

71 NOTCH Switch

This button turns the VFO-A IF notch filter on and off. When the IF notch filter is activated, the LED inside the button will glow red. The Notch Filter center frequency is adjusted via the **【NOTCH】** knob (#70 above).

『Advice』

- The width of the notch may be set to either “Wide” or “Narrow” via Menu item “**RX DSP 082 IF-NOTCH-WIDTH**” in the RX DSP Menu Group. Setting this selection to “Narrow” will provide a very sharp notch, with minimal disturbance to the incoming signal wave-form.
- When the optional Data Management Unit (DMU-9000) and TFT Display Unit (TFT-9000) are installed, you may use the Audio Scope on the Audio Scope/Oscilloscope page on the TFT to help you adjust the setting of the Notch filter control for the optimum performance. The effect of the Notch filter adjustments will be easy to see on the Audio Scope.

FRONT PANEL CONTROLS

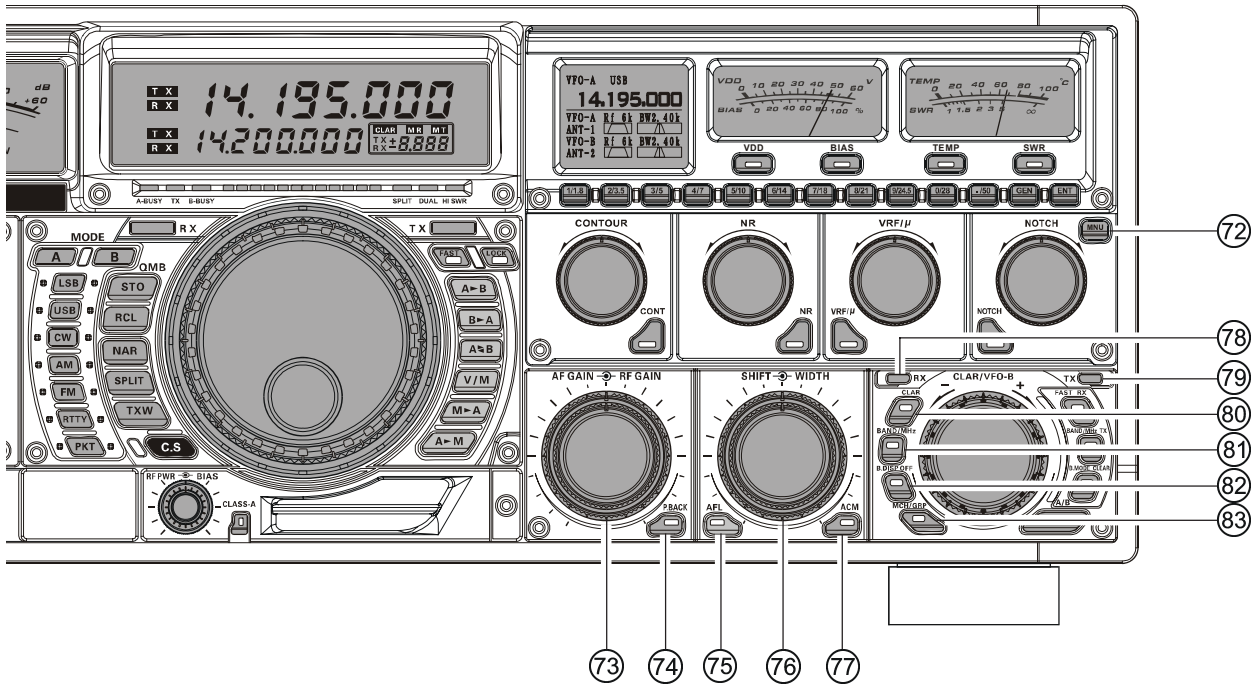

72 MNU Key

This key is used to engage the configuration Menu. When this key is pressed the Menu Mode information will appear on the LCD, allowing selection and adjustment of the various Menu items.

Use the **[Main]** Tuning Dial (#34, described previously) to select the desired Menu item, then use the **[CLAR/VFO-B]** knob (#84, described later) to adjust the setting of the selected Menu item. When you are done, press and hold in the **[MNU]** key for two seconds to save the revised settings and exit to normal operation.

73 AF GAIN → RF GAIN Knobs

AF GAIN Knob

Clockwise rotation of this control increases the Volume level. Typically, you will operate with this control set past the 9 o'clock to 10 o'clock position.

RF GAIN Knob

This is the control that adjusts the gain of the VFO-A's RF and IF stages. Clockwise rotation increases the gain level, and this control typically is left in the fully clockwise position, which provides maximum receiver gain.

74 P.BACK Switch

Press and hold in this button for 2 seconds to activate the recording feature of the internal Digital Voice Recorder. The Voice Recorder allows you to record the VFO-A audio for the most-recent 30 seconds. While you're recording the receiver audio, the LED in this button glows red.

Press and hold in this button for 2 seconds once more to stop the recording, then press this button momentarily again to play back the receiver audio for the most-recent 30 seconds of reception before you stopped the recording.

While playing back the receiver audio, the LED inside button will glow amber.

Press and hold in this button for 2 seconds again to resume recording.

75 AFL Switch

Pressing this button activates the Audio (AF) Limiter circuit of the VFO-B. This will protect the audio amplifier from distortion, and protect your ears from high audio levels, caused by sudden peaks in audio input when the AGC is set to "OFF." When the Audio Limiter circuit is activated, the LED inside the button will glow orange.

76 SHIFT WIDTH Knobs (except on AM and FM mode)

SHIFT Knob

The inner **【SHIFT】** knob provides adjustment of the IF DSP passband, using 20 Hz steps for precise adjustment and easy reduction of interference on either side of your operating frequency. The total adjustment range is ± 1 kHz.

The normal operating setting for this knob is straight up, in the 12 o'clock position.

WIDTH Knob

The outer **【WIDTH】** knob, when turned to the 12 o'clock position, sets the overall IF bandwidth of the VFO-A to its maximum bandwidth. Turning the **【WIDTH】** knob either direction, reduces the overall IF bandwidth of the VFO-A.

When the NAR (Narrow) filter selection is engaged, this control is disabled. The **【SHIFT】** control, however, is still fully functional.

Use this control to narrow the IF DSP passband, as necessary, to reduce interference. The **【SHIFT】** control may be used to re-center the passband response on the incoming signal, and you may find that the CONTOUR and IF NOTCH filters may also help improve intelligibility and/or reduce interference.

『Advice』

When the **【NAR】** switch has been pushed, the **【WIDTH】** control no longer functions. The IF SHIFT system is still fully operational, however.

77 ACM (Adjacent Channel monitor) Switch (CW Mode only)

In the standard FT DX 9000 Contest version, this switch does not function.

When the optional Dual Receive Unit (RXU-9000) is installed, the Adjacent Channel Monitor will be available for use (because it utilizes the second receiver to provide the ACM function).

『Advice』

When the RXU-9000 is installed, engaging ACM utilizes the VFO-B to monitor a 2.4 kHz window outside your current CW passband (for example, 500 Hz) for the VFO-A. The peak signal strengths within this 2.4 kHz window are displayed on the VFO-B's S-meter, alerting you to encroachment from other stations. The ACM results are only displayed on the S-meter, you will not be annoyed by the audio from the potentially-interfering stations.

78 RX Indicator/Switch

This is the switch that turns the VFO-B On and Off. When this button is pressed to make the VFO-B active, the Green LED imbedded within the switch will light up. Pressing the switch again will disable this receiver, and the imbedded Green LED will turn off.

79 TX Indicator/Switch

This is the switch that turns the VFO-B transmitter On and Off. When this button is pressed to transfer transmitter control to the VFO-B frequency and mode, the Red LED imbedded within the switch will light up. Pressing this switch once more will transfer frequency/mode control back to the VFO-A side, and the Red LED imbedded within this switch will turn off.

80 CLAR (Clarifier) Switch

When this switch is pushed, the **【CLAR/VFO-B】** knob (#84, described later) will be enabled for the purpose of utilizing the **【CLAR/VFO-B】** knob as an "Offset tuning" control to allow tuning away from the VFO-A frequency.

81 BAND/MHz Switch

BAND Switch

Pressing this button momentarily allows you to select the VFO-A operating band (Amateur bands) using the **【CLAR/VFO-B】** knob (#84, described later).

MHz Switch

Pressing and holding in this button for 2 seconds allows you to tune the VFO-A frequency down or up in 1 MHz increments, using the **【CLAR/VFO-B】** knob (#84, described later).

82 B-DISP OFF Switch

Pressing this button causes the VFO-B frequency to be blanked out, for local rag-chews or other occasions when the additional display information is not needed. When this function is activated, the LED inside the button will glow green.

83 MCH/GRP Switch

MCH Switch

Pressing this button momentarily allows you to select the memory channel using the **【CLAR/VFO-B】** knob (#84, described later).

GRP Switch

Pressing and holding in this button for 2 seconds allows you to select the memory group using the **【CLAR/VFO-B】** knob (#84, described later).

FRONT PANEL CONTROLS

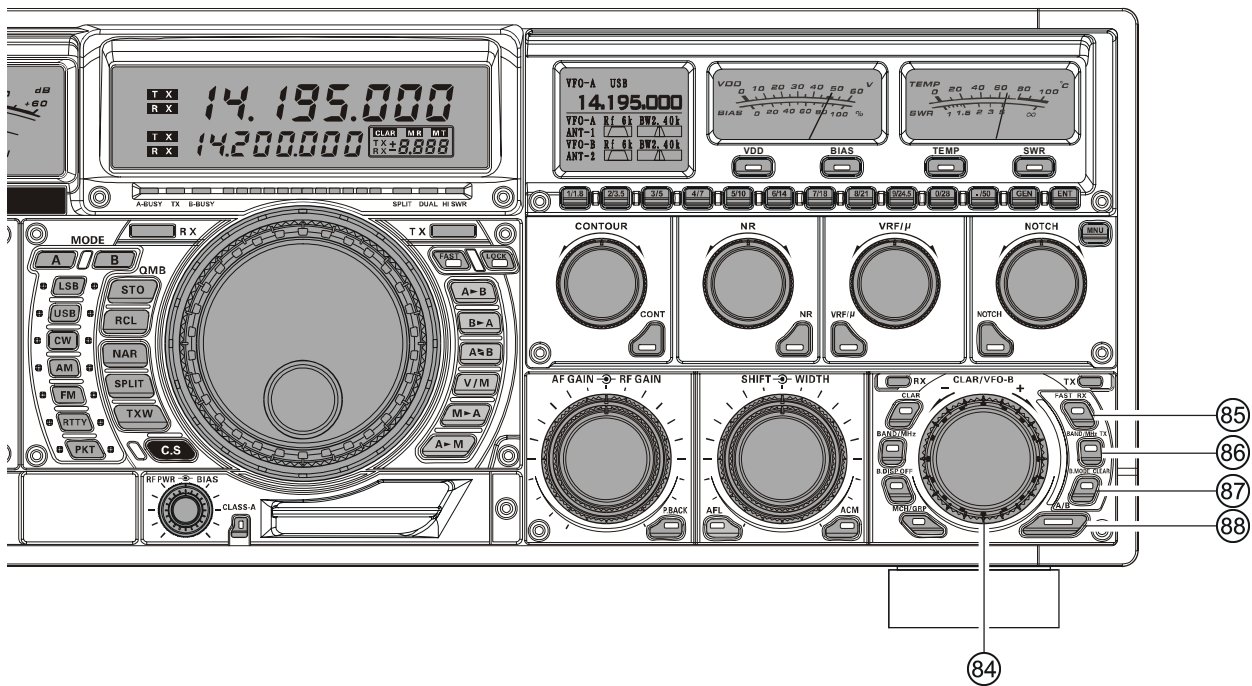

84 CLAR/VFO-B Knob

Depending on the status of the [A/B] switch (#88), described later) the [CLAR/VFO-B] is used for functions associated with the VFO-A or VFO-B frequency control registers.

Advice

Functions Associated with VFO-A Control

In the case of VFO-A control, this knob is used for Clarifier tuning, as well as Up/Down selection of the Amateur band, Memory Channels, 1 MHz tuning steps, or Memory Groups. For VFO-A control, be sure that the Orange lamp beside this control is not illuminated. If the Orange lamp is turned on, press the [A/B] switch (#88) to turn it off.

Clarifier Operation

When the [CLAR] switch (#80) is pushed, this knob may be used to program an offset of up to ± 9.99 kHz from the VFO-A frequency. This offset is only applied, however, to the receive or transmit frequency if the [FAST/RX] switch (#89) and/or [BAND/MHz / TX] switch (#86), respectively, have been pushed.

To apply the programmed frequency offset to the Receive frequency, press the [FAST/RX] switch momentarily. To return to the VFO-A frequency, without the offset, press the [FAST/RX] switch once more. To apply the programmed frequency offset to the Transmit frequency, press the [BAND/MHz / TX] switch momentarily. To return the transmitter to the VFO-A frequency, without the offset, press the [BAND/MHz / TX] switch once more.

To reset the Clarifier frequency to "0" offset, press the [B.MODE/CLEAR] switch (#87).

Functions Associated with VFO-B Operation

When the [A/B] switch (#88) is pressed, the Orange lamp to the right of the [CLAR/VFO-B] knob (#84) will light up, and this knob will now be exercising control functions associated with the VFO-B frequency control register. If the Orange lamp is not illuminated, please press the [A/B] switch. Rotation of the knob will now control the VFO-B frequency.

VFO-B FAST Tuning

When the [FAST/RX] switch (#89) is pressed, the imbedded LED will light up, and tuning of the VFO-B frequency will increase by a factor of 10. Press the [FAST/RX] switch once more to return to the normal tuning rate.

VFO-B BAND/MHz Up/Down Control

If you press the [BAND/MHz / TX] switch (#86) momentarily, the imbedded LED will light up, and this knob may now be used for selection of the desired Amateur band. Pressing the [BAND/MHz / TX] switch once again will cancel Up/Down Band selection, and the LED will turn off.

If you press and hold in the [BAND/MHz / TX] switch for 2 seconds, the imbedded LED will light up, and this knob may now be

BAND/MHz Up/Down Control

When the [BAND/MHz] switch (#81) is pressed momentarily, the Red LED imbedded in the switch will light up, and you may then use this knob for selecting the desired Amateur band. If you have engaged the "My Bands" feature via Menu #135, this knob will select from among just the Amateur bands that you have included in the "My Bands" list.

If you press and hold in the [BAND/MHz] switch for 2 seconds, the imbedded LED will glow Orange, and this knob may now be used for rapid tuning in 1 MHz frequency steps.

Memory Channel/Memory Group Control

Pressing the [MCH/GRP] switch (#83) momentarily will enable the use of this knob for selection of the desired Memory Channel.

Pressing and holding in the [MCH/GRP] switch for two seconds will enable the use of this knob for selecting the desired Memory Group.

used for Up/Down tuning of the VFO-B frequency in 1 MHz steps. Press the [BAND/MHz / TX] switch momentarily to cancel Up/Down tuning; the imbedded LED will turn off.

VFO-B Mode Selection

When the [B.MODE/CLEAR] switch (#87) is pressed, the imbedded LED will light up, and this knob may now be used for selection of the operating mode for VFO-B operation. Pressing the [B.MODE/CLEAR] switch once more will cancel mode selection, and the imbedded LED will turn off.

〔Note〕

Mode selection may also be accomplished by pressing the [A/B] switch (#88), then pressing the appropriate [MODE] switch (#27) to the left of the [Main] Tuning Dial (#34).

⑧⑤ **FAST/RX Switch**

FAST Switch

When the **[A/B]** switch (#⑧⑧, described later) is pushed, and the Orange lamp to the right of the **[CLAR/VFO-B]** knob lights up, the **[CLAR/VFO-B]** knob (#⑧④, above) will be controlling the VFO-B frequency; pressing the **[FAST/RX]** switch will increase the tuning rate by a factor of 10.

RX Switch

When the **[CLAR]** switch (#⑧⑩, described previously) is pressed (and its imbedded LED is illuminated), pressing the **[FAST/RX]** switch applies the programmed Clarifier offset to the VFO-A receive frequency. Press the **[FAST/RX]** switch once more to return the VFO-A to the frequency shown on the main frequency display field; the Clarifier offset will still be present, though, in case you want to use it again. To cancel the Clarifier offset, press the **[B.MODE/CLEAR]** switch (#⑧⑦, described later).

⑧⑥ **BAND/MHz / TX Switch**

BAND/MHz

When the **[A/B]** switch (#⑧⑧, described later) is pressed, and the Orange lamp to the right of the **[CLAR/VFO-B]** knob (#⑧④, described previously) lights up, pressing the **[BAND/MHz / TX]** switch allows you to rotate this knob for selection of the Amateur band to be used for the VFO-B.

TX Switch

When the **[CLAR]** switch (#⑧⑩, described previously) is pressed (and its imbedded LED is illuminated), pressing the **[BAND/MHz / TX]** switch applies the programmed Clarifier offset to the VFO-A transmit frequency. Press the **[FAST/RX]** switch (⑧⑤, above) once more to return the transmitter to the VFO-A frequency shown on the main frequency display field; the Clarifier offset will still be present, though, in case you want to use it again. To cancel the Clarifier offset, press the **[B.MODE/CLEAR]** switch (#⑧⑦, described later).

⑧⑦ **B.MODE/CLEAR Switch**

B.MODE Switch

When the **[A/B]** switch (#⑧⑧ below) is pressed, and the Orange lamp to the right of the **[CLAR/VFO-B]** knob (#⑧④, described previously) lights up, pressing the **[B.MODE/CLEAR]** switch allows you to rotate this knob for selection of the operating mode to be used on the VFO-B.

CLEAR Switch

When the **[CLAR]** switch (#⑧⑩, described previously) is pressed (and its imbedded LED is illuminated), pressing the **[B.MODE/CLEAR]** switch clears out any frequency offset you have programmed into the Clarifier register (thereby setting the offset to “Zero”).

⑧⑧ **A/B Switch**

The **[A/B]** switch controls the determines whether the actions of the **[CLAR/VFO-B]** knob (#⑧④, described previously) will be applied to the VFO-A (“CLAR” option), or the VFO-B (“VFO-B option”). Pressing this switch once causes the Orange lamp to the right of the **[CLAR/VFO-B]** knob to light up; in this case, rotation of the **[CLAR/VFO-B]** knob affects operation on the VFO-B band (tuning, etc.). Pressing the **[A/B]** switch once more causes the Orange lamp to turn off; in this instance, rotation of the **[CLAR/VFO-B]** knob affects operations associated with the VFO-B (Clarifier function, etc.).

REAR PANEL

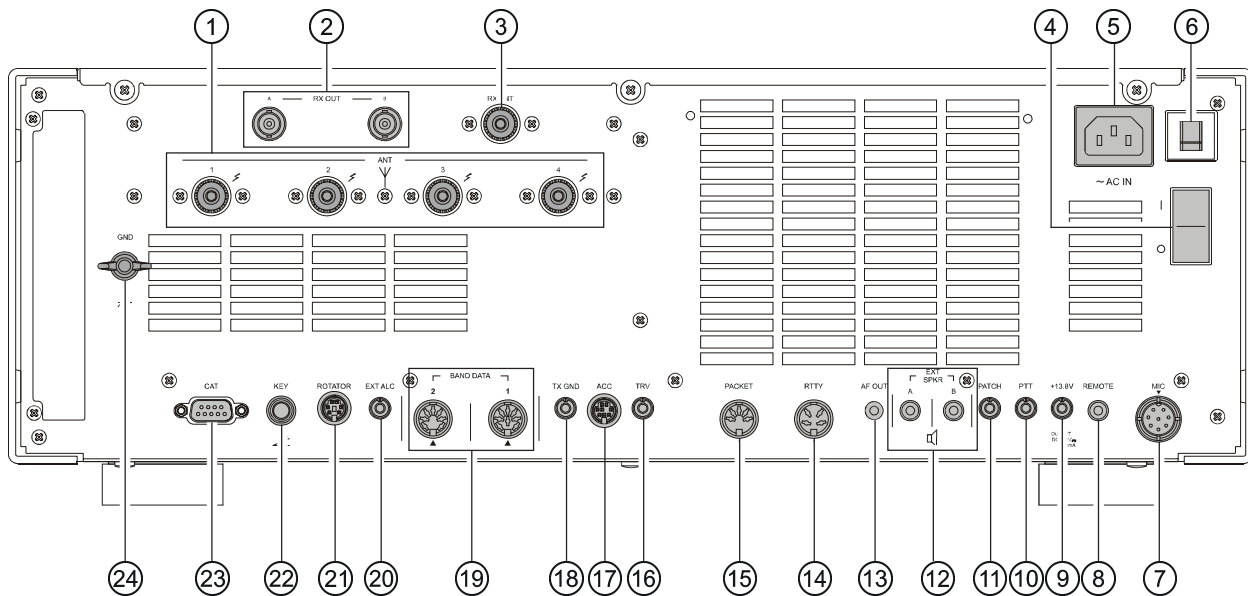

① ANT

Connect your main antenna(s) here, using a type-M (PL-259) plug and coaxial feedline for each. These antenna ports are always used for transmission, and also are used for reception unless a separate receive antenna is also used for the VFO-A. The internal antenna tuner affects only the antenna(s) connected here, and only during transmission. These connectors utilize Teflon^R insulation for extreme durability and to ensure stable impedance over the entire frequency range.

② RX OUT

These BNC jacks provide output of the receiver signal lines from the Antenna jacks which are connected to the VFO-A and VFO-B front ends.

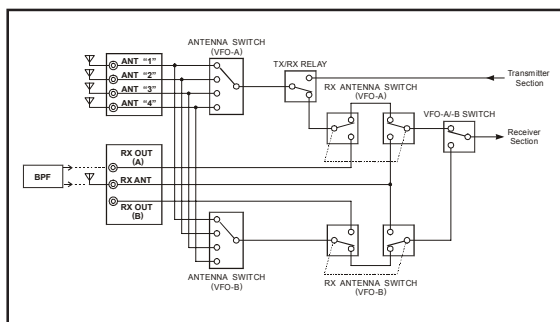

③ RX ANT

This type-M jack is for a separate receive-only antenna. An antenna connected here can be used, by both the VFO-A and VFO-B, when the **[RX ANT]** button (#9) on the front panel is pressed.

If you want to use some special kind of external bandpass filter or preamplifier, you may connect it between the RX OUT and RX ANT jacks, as shown in the illustration.

④ Main Power Switch

This is main power On (I)/Off (O) switch of the FT DX 9000 Contest. Always turn this switch on before turning on the front panel's POWER button.

If this switch is not turned On, the front panel Power switch will not function.

Turning this Main Power switch On supplies voltage to the OCXO (Crystal Oven), ensuring that frequency stability is always maintained even when the transceiver is turned off via the front panel's **[POWER]** switch (#5).

⑤ AC IN

Connect the supplied 3-wire AC line cord to this socket. AC voltages of 100-240 V may be accommodated by the FT DX 9000 Contest without any sort of modification (universal voltage input).

⑥ CIRCUIT BREAKER Switch

This circuit breaker shuts off in the event of dangerously high current consumption by the transceiver.

『Advice』

If the Circuit Breaker interrupts power, by all means try to determine the cause of the over-current condition before re-applying power. To restore the Circuit Breaker after verifying that all is normal, push this switch in until you hear a "click."

⑦ MIC

This 8-pin jack accepts input from a microphone utilizing a traditional YAESU HF-transceiver pinout.

⑧ REMOTE

By plugging in the supplied FH-2 Remote Control Keypad to this gold-plated jack, direct access to the FT DX 9000 Contest CPU is provided for control functions such as contest memory keying, plus frequency and function control.

- ⑨ **+13.8V**
This gold-plated output jack provides regulated, separately fused 13.8 VDC at up to 200 mA, to power an external device such as a packet TNC. Make sure your device does not require more current (if it does, use a separate power source).
- ⑩ **PTT**
This gold-plated input jack may be used to provide manual transmitter activation using a footswitch or other switching device. Its function is identical to the MOX button on the front panel. The same line is available at the PACKET and RTTY jacks for TNC control. Open-circuit voltage is +13.5 VDC, and closed-circuit current is 5 mA.
- ⑪ **PATCH**
This gold-plated RCA input jack accepts transmitter audio - either AFSK or voice - for transmission. This line is mixed with the microphone audio input line, so the microphone should be disconnected if using this jack and mixing is not desired. The optimum impedance is 500 ~ 600 Ohms, and the nominal input level should be 1 mV.
- ⑫ **EXT SPKR**
The EXT SPKR two-contact output jacks are gold plated, providing audio from the VFO-A and VFO-B for an external loudspeaker or speakers, such as the SP-8. Inserting a plug into one of these jacks disables the corresponding internal loudspeaker. Impedance is 4 ~ 8 Ohms.
- ⑬ **AF OUT**
This gold-plated 3-contact jack provides dual-channel low-level receiver output, for recording or external amplification. Peak signal level is 3 Vrms at 10 kOhms. VFO-A audio is on the left channel (tip), and VFO-B audio is on the right channel (ring). A stereo amplifier or recorder is recommended, to record each receiver's audio separately when dual reception is enabled (audio from either receiver, or both, may be used via this jack). The front panel **[AF GAIN]** knobs do not affect the signals at this jack.
- ⑭ **RTTY**
This 4-pin input/output jack provides connections for an RTTY terminal unit. Pinout is shown on page 107. The receiver audio level at this jack is at a constant 100-mV (@600 Ohms) level. FSK keying at this jack is accomplished by a closure of the SHIFT line to ground by the terminal unit.
- ⑮ **PACKET**
This 5-pin input/output jack provides receiver audio and squelch signals, and accepts transmit (AFSK) audio and PTT control, from an external Packet TNC. Pinout is shown on page 106. The receiver audio level at this jack is approximately 100 mV (@600 Ohms).
- ⑯ **TRV**
This gold-plated RCA jack provides a low level RF output for use with a transverter. Maximum output is approximately -20 dBm (0.01 mW) at 50 Ohms.
- ⑰ **ACC**
This is an accessory jack which is used at the factory for adjustment of the radio. Please do not connect any cable or accessory to this terminal.
- ⑱ **TXGND**
This jack's center pin is closed to ground while the transceiver's transmitter is engaged. It may be used for control of a peripheral device, most typically a linear amplifier. To enable this jack, please set Menu item "**TX GNRL 156 EXT AMP TX-GND**" to the "ENABLE" selection. This RCA connector is gold-plated, and the specifications are shown below.
- ⑲ **BAND DATA**
BAND DATA1
This 7-pin output jack used for control of the VL-1000 Solid-state Linear Amplifier.
BAND DATA2
This 8-pin output jack provides band selection data which may be used for control of optional accessories such as the VL-1000 Solid-state Linear Amplifier.
- ⑳ **EXT ALC**
This gold-plated RCA input jack accepts negative-going external ALC (Automatic Level Control) voltage from a linear amplifier, to prevent over-excitation by the transceiver. Acceptable input voltage range is 0 to -4 VDC.
- ㉑ **ROTATOR**
This 5-pin MINI-DIN Jack accepts a cable connected to a YAESU G-800DXA/-1000DXA/-2800DXA Antenna Rotator. You may control the antenna azimuth rotation (and rotation speed) using the Function buttons on the front panel. (Listed models are current as of early 2005).
- ㉒ **KEY**
This 1/4-inch gold-plated phone jack accepts a CW key or keyer paddle. A 2-contact plug cannot be used in this jack. Key-up voltage is +5 V, and key-down current is 1 mA. Plug wiring is shown on page 16, and this jack may be configured for keyer, "Bug," "straight key," or computer keying interface operation via Menu Selection "**MODE-CW 043 R-KEYER TYPE**" (see page 120).
- ㉓ **CAT**
This 9-pin serial DB-9 jack allows external computer control of the FT DX 9000 Contest. Connect a serial cable here and to the RS-232C COM port on your personal computer (no external interface is required).
- ㉔ **GND**
Use this terminal to connect the transceiver to a good earth ground, for safety and optimum performance. Use a large diameter, short braided cable for making ground connections, and please refer to page 13 for other notes about proper grounding.

FREQUENCY DISPLAY

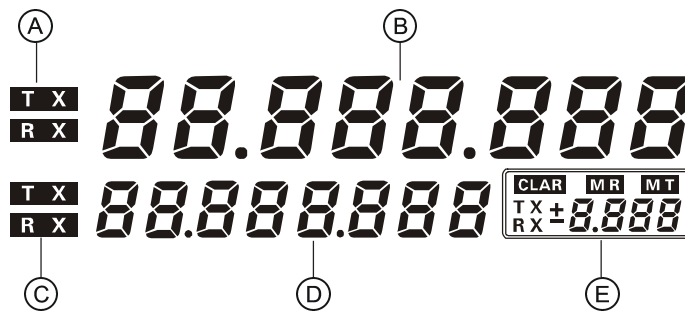

Ⓐ VFO-A TX/RX Indicators

These combination lamp-buttons select and indicate the transmit/receive status of the VFO-A. When the green “RX” lamp is lit, the receiving frequency is under control of the **【Main】** Tuning Dial (#34) and display (either VFO-A or a recalled memory channel). When the red “TX” lamp is lit, the transmitting frequency is under control of the main knob and display. Thus, for “normal” (non-split) operation, both the red and green lamps associated with the **【Main】** Tuning Dial will be illuminated.

Ⓑ VFO-A Frequency Display

This is the VFO-A frequency display.

『Advice』

The Tone Encoder/Decoder frequency is indicated during the setup process.

Ⓒ VFO-B TX/RX Indicators

These combination lamp-buttons select and indicate the transmit/receive status of the VFO-B.

Ⓓ VFO-B Frequency Display

This is the VFO-B frequency display.

『Advice』

The Tone Encoder/Decoder frequency is indicated during the setup process.

Ⓔ Multi-Panel

This field within the frequency display area provides several indications, depending on the frequency control mode in use:

CLAR (Clarifier)

This window displays the Clarifier frequency offset from the VFO-A frequency. The Clarifier is engaged when the CLAR LED is illuminated.

MR (Memory Recall)

When the **【MCH/GRP】** switch is pushed, the currently-selected Memory channel or Memory Group number will be displayed in this window.

MT (Memory Tune)

If you rotate the **【Main】** Tuning Dial (#34) (or change the mode) during memory operation, the transceiver will change into the “Memory tune” mode to indicate that the memory contents have been temporarily changed; “**MT**” lights up to confirm this change.

Repeater Shift Data

During FM operation, the Repeater Shift will be indicated in this window.

A Negative frequency shift will be indicated by “-” while a Positive frequency shift will be indicated by “+” in the window. During Simplex operation (no shift), “S” will be displayed.

The supplied Remote Control Keypad “FH-2” can be used to control the voice memory capability for the SSB/AM/FM modes, and the contest memory keyer for the CW mode. You can also play back up to 30 seconds of incoming received audio, as well, for verification of a missed callsign or other purposes. Among the specific capabilities of the FH-2 are:

- Five channels of storage and playback of voice memory (20 seconds each), using your own voice for recording (see page 78).
- Playback of the last 30 seconds of incoming receiver audio (see page 44).
- On CW, the FH-2 provides storage and recall of CW messages for repetitive CQ and contest number transmissions.

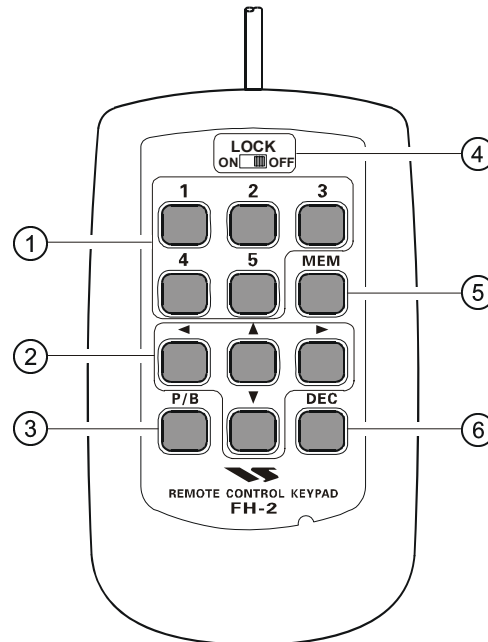

① Voice Memory/CW Message Memory Selection Keys (5 Channels)

In the case of Voice Memory, up to 20 seconds of audio may be stored on each channel.

For CW messages and CW Text messages, up to 50 characters (“PARIS” specification) may be stored into each channel.

② Text Memory Programming Keys

These keys are used for navigation when selecting text characters for the programming of Contest and Text memories.

③ Playback Key

This key replicates the action of the [P.BACK] (“Playback”) switch on the front panel of the transceiver, and is used for playing back the last 30 seconds of recorded receiver audio.

④ LOCK Switch

This switch may be used to lock out the FH-2’s keys, to prevent accidental activation of FH-2 operation.

⑤ MEM Key

This key is pressed for the purpose of storing either a Voice Memory or a Contest Keyer Memory channel’s contents.

⑥ DEC Key

When utilizing the sequential contest number capability of the Contest Keyer, press this key to decrement (back up) the current Contest Number by one digit (i.e. to back up from #198 to #197, etc.).

BASIC OPERATION: RECEIVING ON AMATEUR BANDS

Before turning on main power, please verify the following items once more.

- Have you made all ground connections securely? See page 13 for details.
- Do you have your antenna(s) connected to the rear-panel Antenna jack(s)? See page 14 for details.
- Is your microphone (and/or key or paddle) connected? See pages 15 and 16 for details.
- If using a linear amplifier, have all interconnections been successfully completed? See page 17 for details.
- Please rotate both **【AF GAIN】** controls to their fully counter-clockwise positions, to avoid a loud blast of audio when the transceiver turns on. See pages 30 and 39 for details.
- Rotate the **【RF PWR】** control fully counter-clockwise, to set minimum power at first. See pages 26 and 70 for details.
- Before attempting voice transmissions, you must be certain that the microphone you intend to use is plugged into an “Active” microphone jack. On the front panel is a 3-pin “Cannon” (XLR) connector, and on the rear panel you’ll find a “traditional” 8-pin round connector. At the factory, the XLR connector is selected, but you may easily change this using the Menu item “**MODE-SSB 069 SSB MIC SELECT;**” please confirm that this Menu item is configured appropriately.

『Note』

If the wrong microphone jack is selected, voice transmission will not be possible.

- If your AC mains power should suffer a significant fluctuation or interruption, we recommend that you go through a complete power-up cycle, in order to ensure that all circuits are properly initialized. To do this, be sure the front panel Power switch is turned off, then set the rear-panel Power switch to the “**●**” position. Now unplug the AC cable from the rear panel of the transceiver, and wait ten seconds. The start-up procedure is described on the next page.

BASIC OPERATION: RECEIVING ON AMATEUR BANDS

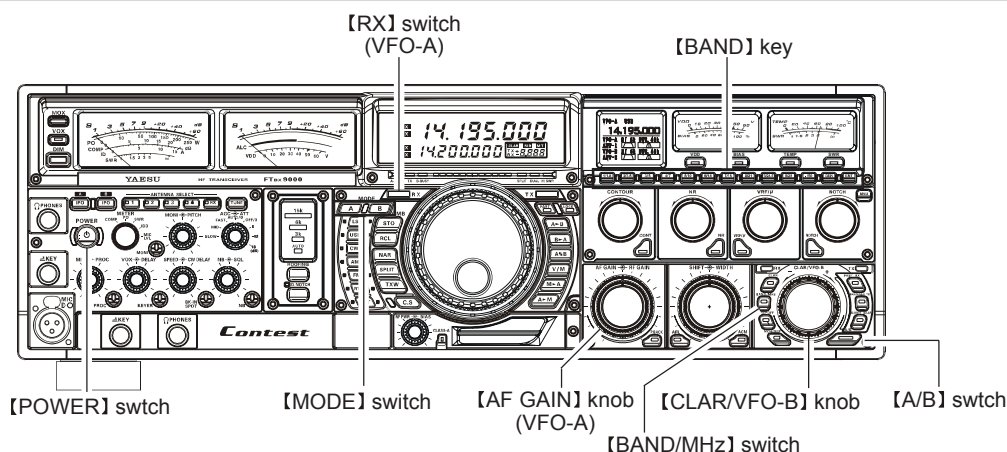

1. Plug the AC cable back in, set the rear-panel Power switch to "I."
2. Press and hold in the front-panel **[POWER]** switch (#5) for two seconds to turn the transceiver on. Transceiver will start up on 7.000.00 MHz LSB, and normal operation may resume.

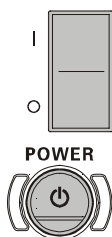

『Note』

To turn power off, press and hold in the front panel **[POWER]** switch for two seconds.

『Quick Note』

It will take around 10 seconds until the transceiver is ready for full operation.

3. Rotate the **[AF GAIN]** knob (#73) to set a comfortable audio level on incoming signals or noise. Clockwise rotation of the **[AF GAIN]** knob increases the volume level.

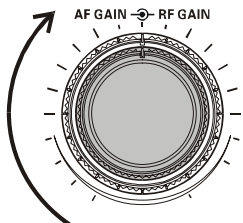

『Note』

When using headphones, start by rotating the **[AF GAIN]** control counter-clockwise, then bring the volume level up after you put the headphones on. This will minimize the chance of damage to your hearing caused by an unexpectedly-high audio level.

4. Press the **[RX]** (#32) switch to engage the VFO-A, the imbedded LED will glow Green.

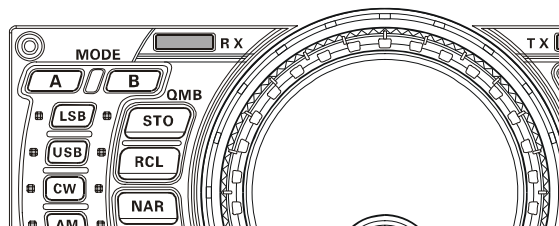

5. Press the **[A]** switch (#27) to enable the capability to change the operation for the VFO-A the imbedded LED will glow Red.
6. Press the **[BAND]** key (#63) corresponding to the Amateur band on which you wish to begin operation.

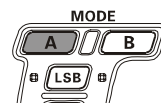

『Advice』

- One-touch selection of each Amateur band between 1.8 and 50 MHz is provided.
- If you press the **[BAND/MHz]** key (#81) momentarily, the **[CLAR/VFO-B]** knob (#84) may be used as a band selection knob. If the **[CLAR/VFO-B]** knob is pressed and held in for two seconds, rotation of the **[BAND/MHz]** (#81) key allows frequency navigation in 1 MHz steps.
- When the **[BAND/MHz]** key's imbedded LED is illuminated, the **[CLAR/VFO-B]** knob controls the functions associated with the **[BAND/MHz]** key.

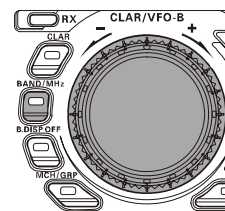

『Advice』

- Depending on the setting of the **[A/B]** switch (#88), the function of the **[CLAR/VFO-B]** knob (#84) will change. Please see page 32 for more details.
- The FT DX 9000 Contest utilizes a triple band-stack VFO selection technique, that permits you to store up to three favorite frequencies and modes onto each band's VFO register. For example, you may store one frequency each on 14 MHz CW, RTTY, and USB, then recall these VFOs by successive, momentary presses of the **[14]** MHz band key (#63). Each Amateur band key may similarly have up to three frequency/mode settings applied.

BASIC OPERATION: RECEIVING ON AMATEUR BANDS

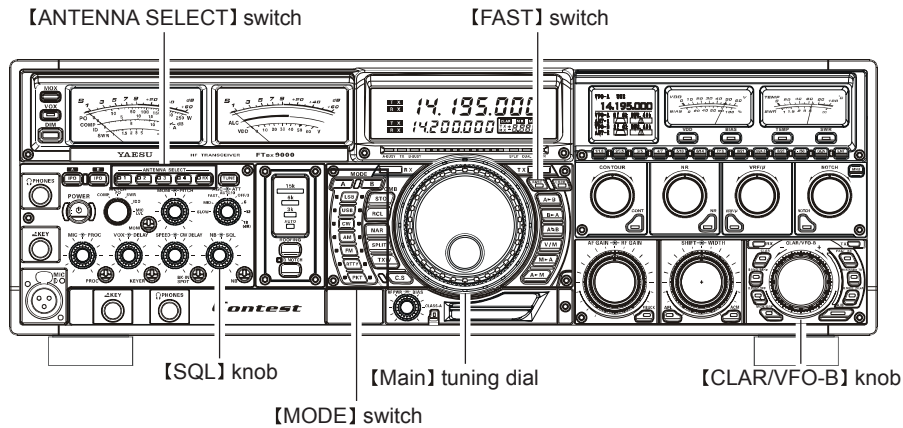

- Press one of the **[ANTENNA SELECT (1~4)]** switches (#9) to select the appropriate antenna for the band in use; alternatively, if one is connected, you may also press the **[RX]** antenna selection switch (#9). Up to four TX/RX antennas may be connected, or one RX-only antenna.



『Advice』

Once you have made your antenna selection, that antenna is “remembered” by the microprocessor in conjunction with the VFO register (frequency and mode) in use when you chose that particular antenna.

- Press the appropriate **[MODE]** key (#27) to select the desired operating mode.

『Advice』

- By convention in the Amateur bands, LSB is used on the 7 MHz and lower bands (with the exception of 60 meters), while USB is utilized on the 14 MHz and higher bands.
- When changing modes from SSB to CW, you will observe a frequency shift on the display. This shift represents the BFO offset between the “zero beat” frequency and the audible CW pitch (tone) you can hear (the pitch is programmed by the **[PITCH]** control (#14)), even though the actual tone that you hear is not changing. If you do not want this frequency shift to appear when changing modes from (for example) USB to CW, use the Menu item “**MODE-CW 050 CW FREQ DISPLAY,**” described on page 121.
- When operating on the FM mode, rotate the **[SQL]** (Squelch) control (#21) clockwise just to the point where the background noise is just silenced. This is the point of maximum sensitivity to weak signals.

- Rotate the **[Main]** Tuning Dial knob (#34) to tune around the band, and begin normal operation.

『Quick Note』

- Clockwise rotation of the **[Main]** Tuning Dial knob increases the operating frequency, one “step” of the synthesizer at a time; similarly, counter-clockwise rotation of the **[Main]** Tuning Dial knob will decrease the frequency.

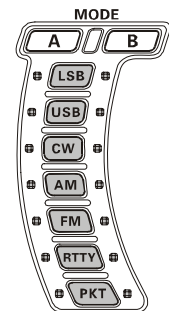

Two steps, one “normal” and one “fast,” are available on each operating mode. Pressing the **[FAST]** key (#35) engages the “Fast” tuning selection.

Operating Mode	1 Step	1 Dial Rotation
LSB, USB, CW, RTTY, PKT(LSB)	10 Hz [100 Hz]	10 kHz [100 kHz]
AM, FM, PKT(FM)	100 Hz [1 kHz]	100 kHz [1 MHz]

[]: **[FAST]** switch set to “ON”

- It is possible to separate the frequency change over one dial rotation, while operating solely on the CW mode, using the Menu items “**TUNING 129 MAIN DIAL STEP,**” and “**TUNING 130 MAIN DIAL CW FINE.**” See page 129.
- If you want to navigate quickly, so as to effect rapid frequency change, there are several techniques available:
 - Direct keyboard frequency entry of the frequency (see page 48).
 - Use the **[CLAR/VFO-B]** knob (#84) to tune in 1 MHz steps (see page 48).
 - Use the microphone’s Up/Down scanning keys, if your microphone is so equipped.

BASIC OPERATION: RECEIVING ON AMATEUR BANDS

OPERATION ON 60-METER (5 MHz) BAND (U.S. VERSION ONLY)

The FT DX 9000 Contest includes the capability for transmission and reception on the five spot frequencies assigned to the Amateur Service in the United States. To operate on the 5 MHz band:

1. Press the **【V/M】** key (#43) once to enter the “Memory” mode (a memory channel number “USX” will appear on the Multi-Panel in the display).
2. Memory channels “US1” through “US5” are pre-programmed, at the factory, with the permitted frequencies in the 5 MHz band, and the USB mode is automatically selected on these channels.
3. To exit from 60-meter operation and return to the VFO mode, just press the **【V/M】** key.

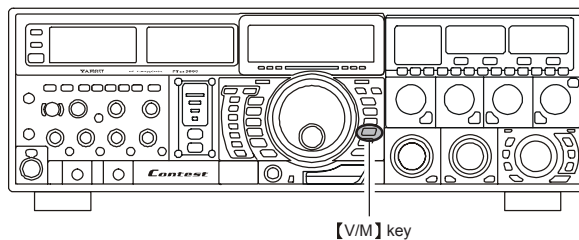

『Note』

The frequencies and operating mode for 5 MHz band operation are both fixed, and may not be changed.

BASIC OPERATION: RECEIVING ON AMATEUR BANDS

CLAR (CLARIFIER) OPERATION ON MAIN (VFO-A)

The **【CLAR】** button and **【CLAR/VFO-B】** knob are used to offset either the receive, transmit, or both frequencies from their settings on the VFO-A frequency (the Clarifier does not affect the Δ , however). The four small numbers on the Multi Display Window show the current Clarifier offset. The Clarifier controls on the FT DX 9000 Contest are designed to allow you to preset an offset (up to ± 9.999 kHz) without actually retuning, and then to activate it via the Clarifier's RX (FAST RX) and TX (BAND/MHz TX) buttons. This feature is ideal for following a drifting station, or for setting small frequency offsets sometimes utilized in DX "Split" work.

Here is the technique for utilizing the Clarifier:

1. Press the **【CLAR】** switch (#80). The LED imbedded in the switch will glow Red, and "CLAR" will appear on the display to signify that rotation of the **【CLAR/VFO-B】** knob (#84) will allow setting of a frequency offset.
2. Press the **【FAST/RX】** switch (#85). On the display, "RX" will appear, and the programmed offset will be applied to the receive frequency.
3. Rotation of the **【CLAR/VFO-B】** knob (#84) will allow you to modify your initial offset on the fly. Offsets of up to ± 9.99 kHz may be set using the Clarifier.

To cancel the application of the offset to the receiver frequency temporarily, press the **【FAST/RX】** switch (#85).

The "CLAR RX" notation will disappear from the display.

To cancel Clarifier operation, press the **【CLAR】** switch.

『Advice』

Turning the Clarifier Off simply cancels the application of the programmed offset from the receive and/or transmit frequencies. To clear out the programmed Clarifier offset altogether, and reset it to "zero," press the **【CLAR】** switch. The programmed offset is displayed in the small multi-channel window of the frequency display.

『Note』

If the Clarifier seems not to be operating, check to see if the Orange lamp to the right of the **【CLAR/VFO-B】** knob is illuminated. If so, pressing the **【A/B】** (#88) switch will cause the Orange lamp to the right of the **【CLAR/VFO-B】** knob to go out. Now press the **【CLAR】** switch to begin Clarifier operation.

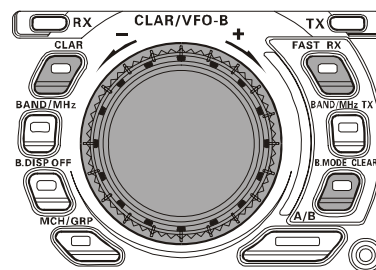
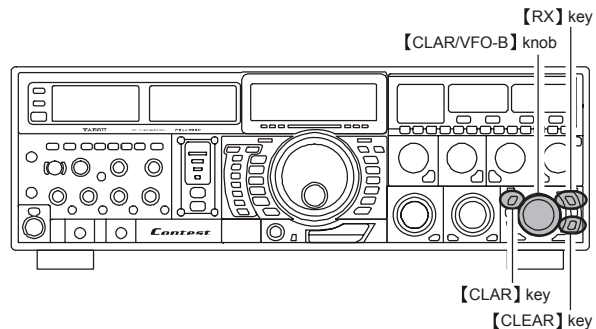

TXCLAR

Without changing the receive frequency, you may alternatively apply the Clarifier offset to the transmit frequency (typically, for "split" DX pile-ups). See page 81 for details.

The LED Bar Display provides a graphical representation of the Clarifier offset.

On CW, the Bar Display field is used for CW Center Tuning, instead of Clarifier Offset, as the transceiver is configured at the factory. If you wish to change this, so that the Clarifier Offset is also displayed on CW, use the following procedure:

1. Press the **【MNU】** key (#92) to enter the Menu mode.
2. Rotate the **【Main】** Tuning Dial (#34) to select Menu item "DISPLAY 016 BAR DISPLAY SELECT."
3. Rotate the **【CLAR/VFO-B】** knob (#84) to select "CLAR" (replacing the default "CW-TUNE" selection).
4. Press and hold in the **【MNU】** key for two seconds to save the new setting and exit to normal operation.

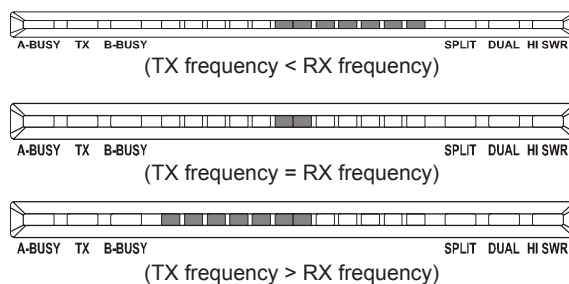

BASIC OPERATION: RECEIVING ON AMATEUR BANDS

LOCK

You may lock the setting of the **【Main】** Tuning Dial, to prevent accidental frequency change.

To lock out the **【Main】** Tuning Dial (#34), just press the **【LOCK】** switch (#36) that is located to the right of the Dial. To unlock the Dial setting, and restore normal tuning, just press the **【LOCK】** switch once more.

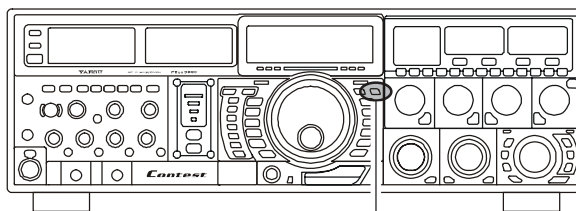

【LOCK】 switch

DIM

The illumination level of the analog meters, main frequency display, and the LCD display may be reduced, if you are using the transceiver in a dark environment where high brightness is not desired.

To reduce the illumination level, press the **【DIM】** switch (#3), located to the left of the leftmost analog meter. To restore full brightness, press the **【DIM】** switch once more.

You may also customize the amount of brightness reduction engaged by the pressing of the **【DIM】** switch, and may use different brightness levels for different front panel areas. Menu item “**DISPLAY 014 DIMMER-METER**” adjusts the brightness level of the analog meters and LCD display, while menu item “**DISPLAY 015 DIMMER-VFD**” sets the brightness levels of the main frequency display (these settings are effective only when the **【DIM】** switch is pressed).

【DIM】 switch

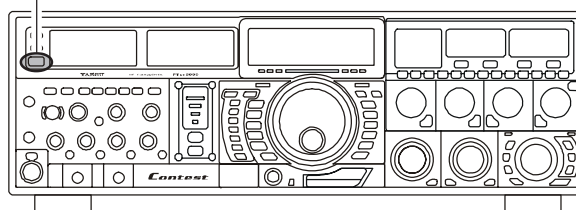

DIM



LCD Display Brightness Adjustment

By following the procedure below, you may adjust the brightness level of the LCD window.

1. Press the front panel's **【POWER】** switch (#5) for two seconds to switch the main transceiver power off.
2. Press and hold in the **【SWR】** key (#62) while turning on the transceiver main power (press and hold in the **【POWER】** switch for two seconds). Once power comes on, release the **【SWR】** key; the LCD window will now be configured for setting of the brightness level.
3. Rotate the **【CLAR/VFO-B】** knob (#84) to set the brightness level. You can observe the brightness level changing on the LCD window.
4. When you have finished your adjustment, press the **【SWR】** switch momentarily to save the new setting.

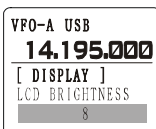

B-DISP OFF

During monoband operation, you may wish to disable (temporarily) the display of the Sub (VFO-B) band frequency.

To do this, press the **【B-DISP OFF】** switch (#82), found at the lower left side of the **【CLAR/VFO-B】** knob.

Press the **【B-DISP OFF】** switch once more to restore the Sub (VFO-B) band frequency display.

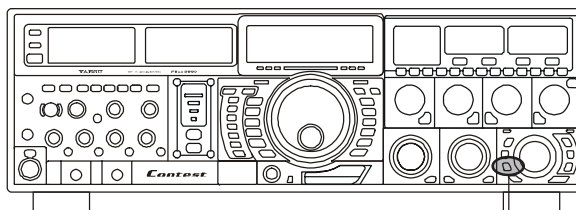

【B-DISP OFF】 switch

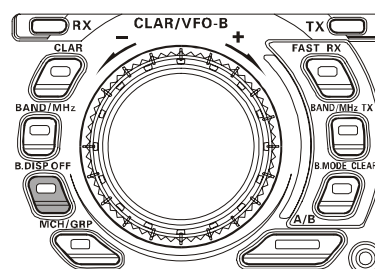
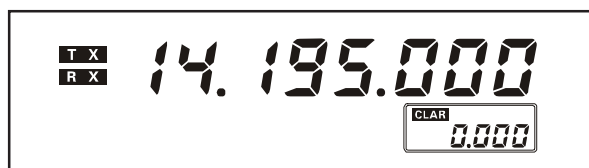

CONVENIENT FEATURES

P.BACK (AUDIO PLAYBACK) FROM VFO-A RECEIVER

Once engaged by the operator, the FT DX 9000 Contest begins the automatic recording of the last 30 seconds of incoming receiver audio on the VFO-A. This capability is especially useful for confirming a callsign that may have been difficult to copy due to noise or QRM, etc.

Recording

Press and hold in the **[P.BACK]** key (#74) for two seconds to initiate recording; an LED imbedded in the switch will light up to confirm that recording is in progress. The recorder will store up to 15 seconds of the VFO-A received audio, and will retain the most-recent 15 seconds of audio on a running basis.

Pressing the **[P.BACK]** switch once more will halt the recording, and the LED imbedded in the switch will go out.

『Note』

When the transceiver is turned off, the contents of the recording memory are erased!

Playback

Press the **[P.BACK]** key (#74) momentarily, after recording has been halted, to begin playback of the recorded audio. The last 15 seconds of audio will be heard in the speaker or headphones. If you do not intervene, the entire 30 seconds will be played back, after which the playback will stop automatically. To halt playback at any time, just press the **[P.BACK]** key momentarily again. The next time you press the **[P.BACK]** key, it will pick up the playback where you left off.

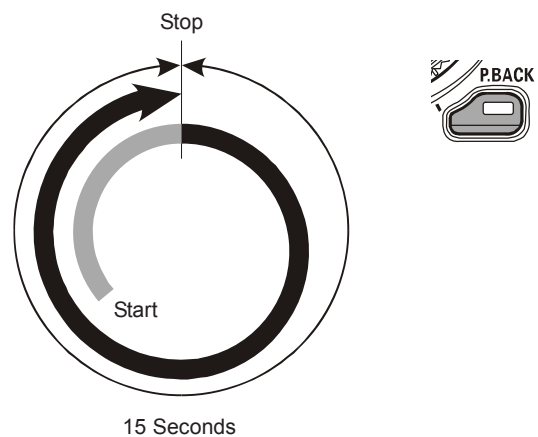
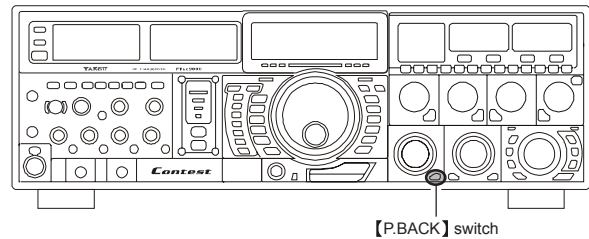

The **[P/B]** key of the supplied FH-2 Keypad can also serve as a remote-control recording/playback switch. Operation is described below.

Recording

Press and hold in the FH-2's **[P/B]** key for two seconds to initiate recording.

The front panel **[P.BACK]** switch's (#74) LED will light up to confirm that recording is in progress.

Press the FH-2's **[P/B]** key momentarily to halt recording; the front panel's LED will go out.

You may also press the front panel's **[P.BACK]** key (momentarily) to halt recording, as well.

When the transceiver is turned off, the contents of the recording memory are erased.

Playback

Press the FH-2's **[P/B]** key momentarily, after recording has been halted, to begin playback of the recorded audio. The last 15 seconds of audio will be heard in the speaker or headphones. If you do not intervene, the entire 15 seconds will be played back, after which the playback will stop automatically. To halt playback at any time, just press the **[P/B]** key momentarily again. The next time you press the **[P.BACK]** key, it will pick up the playback where you left off. You may also press the front panel's **[P.BACK]** key (momentarily) to play back the recorded audio, as well.

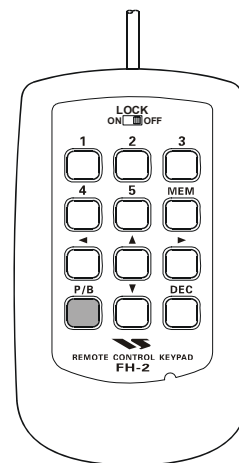

“MY BANDS” OPERATION

When operating on an Amateur Band on the VFO-A register, it is possible to use the **[BAND/MHz]** switch to engage the use of the **[CLAR/VFO-B]** knob for Amateur band selection. The “My Bands” feature allows you to select several Amateur bands, and make only those bands available for selection via the **[CLAR/VFO-B]** knob.

This feature can be very useful in a contest, where the 10/18/24 MHz band are not used, or if you do not have antennas for some bands.

“My Bands” Setup

1. Press the **[MNU]** key (#72) to engage the Menu mode; the Menu list will appear on the LCD.
2. Rotate the **[Main]** Tuning Dial knob (#34) to select Menu item “**TUNING 135 MY BAND.**”
3. Rotate the **[CLAR/VFO-B]** knob (#84) to choose a band that you wish to skip (omit) from the band-selection loop (when using the **[CLAR/VFO-B]** knob for band selection). The available choices are 1.8/3.5/7/10/14/18/21/24/28/50/GEN/TRV, and the factory-default selection is TRV (only).
4. Press the **[ENT]** key (#63) to set the omission command to ON.
5. Repeat steps 3 and 4 to select/deselect as many bands as you like.

『Note』

The “ON” command sets the selected band to be skipped, while the “OFF” command sets the selected band to be included in the band-selection list.

6. Press and hold in the **[MNU]** key for two seconds to lock in the new configuration and exit to normal operation.

“My Bands” Operation

1. Press the **[BAND/MHz]** switch (#81); the imbedded LED will glow Red.
2. Rotate the **[CLAR/VFO-B]** knob (#84) to choose the Amateur band on which you wish to operate. Only those Amateur bands that have not been skipped will appear as you scroll through the bands.

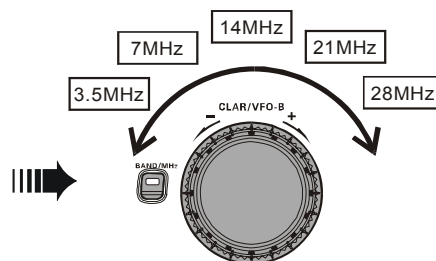
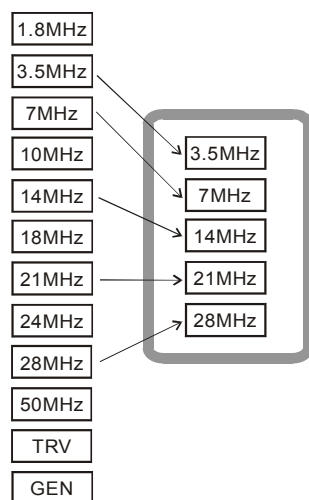
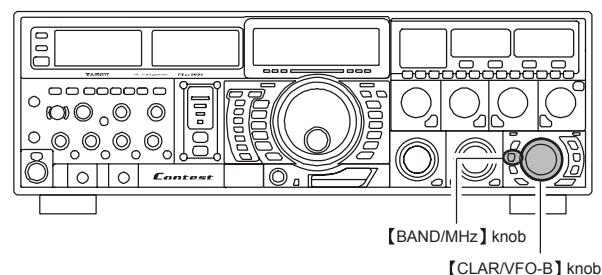
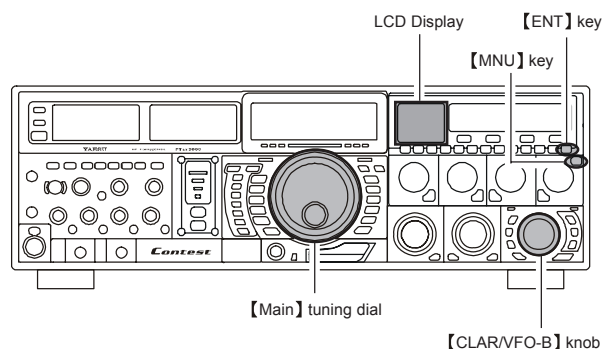

CONVENIENT FEATURES

BAND STACK OPERATION

The FT DX 9000 Contest utilizes a triple band-stack VFO selection technique, that permits you to store up to three favorite frequencies and modes onto each band's VFO register. For example, you may store one frequency each on 14 MHz CW, RTTY, and USB, then recall these VFOs by successive, momentary presses of the **[14] MHz [BAND]** key. Each Amateur band key may similarly have up to three frequency/mode settings applied. Both the VFO-A and VFO-B systems have their own, independent, band stacks.

A typical setup, for the 14 MHz band, might be arranged like this:

1. Program 14.0250 MHz, CW Mode, then press the **[14] MHz [BAND]** key (#63);
2. Program 14.080 MHz, RTTY Mode, then press the **[14] MHz [BAND]** key;
3. Program 14.195 MHz, SSB Mode, then press the **[14] MHz [BAND]** key.

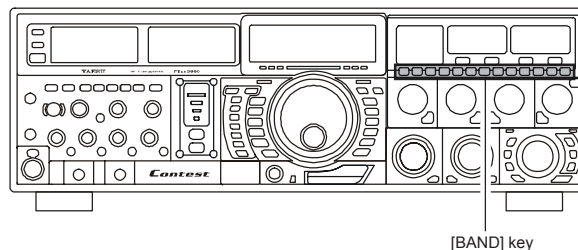

BAND Key	Band Stack1		Band Stack2		Band Stack3	
	Frequency (MHz)	MODE	Frequency (MHz)	MODE	Frequency (MHz)	MODE
1.8	1.800000	CW	1.800000	CW	1.800000	CW
3.5	3.500000	LSB	3.500000	LSB	3.500000	LSB
5	5.000000	USB	5.000000	USB	5.000000	USB
7	7.000000	LSB	7.000000	LSB	7.000000	LSB
10	10.100000	CW	10.100000	CW	10.100000	CW
14	14.100000	USB	14.100000	USB	14.100000	USB
18	18.068000	USB	18.068000	USB	18.068000	USB
21	21.000000	USB	21.000000	USB	21.000000	USB
24	24.890000	USB	24.890000	USB	24.890000	USB
28	28.000000	USB	28.000000	USB	28.000000	USB
50	50.000000	USB	50.000000	USB	50.000000	USB
GEN	15.000000	USB	15.000000	USB	15.000000	USB

With this configuration, successive momentary presses of the **[14] MHz [BAND]** key will allow you to toggle sequentially through these three VFOs.

C.S (CUSTOM SWITCH)

An often-used Menu mode selection may be brought out to the front panel's **[C.S]** key

C.S Setup

1. Press the **[MNU]** key (#72) to engage the Menu mode; the Menu list will appear on the LCD.
2. Rotate the **[Main]** Tuning Dial knob (#34) to select the Menu item you want to be able to access via the **[C.S]** key (#37).
3. Press and hold in the **[C.S]** key for two seconds to lock in your selection.
4. Press and hold in the **[MNU]** key for two seconds to save the new configuration and exit to normal operation.

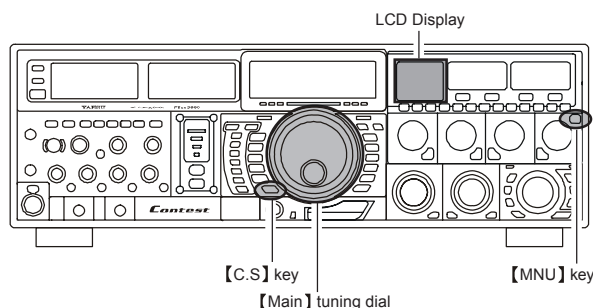

Menu Selection Recall via [C.S] key

Press the **[C.S]** key.

On the LCD, the programmed Menu item will appear. You may now rotate the **[CLAR/VFO-B]** knob (#84) to change the setting of this menu item. Press the **[MNU]** key for two seconds, when you are done, to save the new configuration and exit to normal operation.

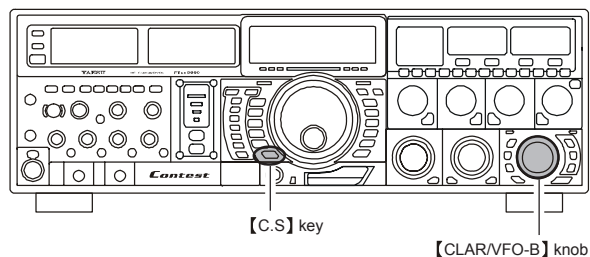

ROTATOR CONTROL FUNCTIONS

When using a YAESU model G-800DXA, G-1000DXA, or G-2800DXA rotator (not supplied), it is possible to control it from the front panel of the FT DX 9000 Contest.

1. Press and hold in the **【ENT】** key (one of the **【BAND】** keys (#63)) for two seconds. The frequency display area will change over to the “Rotator Control” configuration.
2. Press either the **【2/3.5】** key or the **【3/5】** key to rotate the antenna. Pressing the **【2/3.5】** key will cause rotation to the left (counter-clockwise), while pressing the **【3/5】** key will cause rotation to the right (clockwise).
3. Press the **【5/10】** key or the **【6/14】** key to control the speed of rotation. Pressing the **【5/10】** key will cause slower rotation, while pressing the **【6/14】** key will speed up rotation. Usually, you will be using the “100%” setting.

When you are through exercising rotator control, press the **【BAND】** key momentarily. The frequency display will return to the main display field.

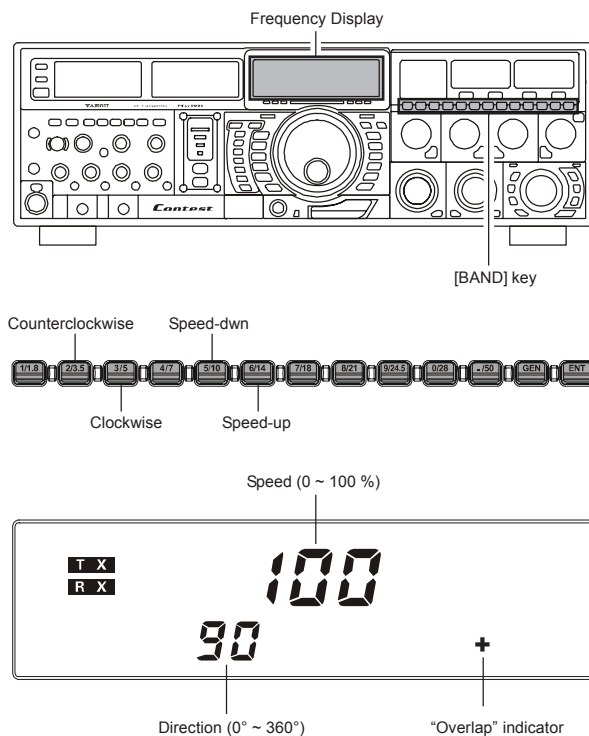

CONVENIENT FEATURES

MORE FREQUENCY NAVIGATION TECHNIQUES

Keyboard Frequency Entry

You may enter operating frequencies, for either the VFO-A or VFO-B, using the front panel band/frequency selection keys.



Example 1:

Enter 14.250.00 MHz into the VFO-A:

1. Press the **[A]** key (#27).
2. Press the **[ENT]** key (#63) to engage the direct frequency entry process. Now, beginning with the “10 MHz” digit of the frequency (the leftmost digit), we will enter the required digits of the frequency.
3. Press, in order, the digits of the operating frequency, using the **[BAND]** keys (#63): which have the frequency-entry digit or decimal point on the right side of the slash bar). In this example, enter

**[1/1.8] → [4/7] → [./50] → [2/3.5] → [5/10]
[0/28] → [0/28] → [0/28] → [0/28]**

The decimal point after the “MHz” portion of the frequency must be entered, but no decimal point is required after the “kHz” portion.

4. Press the **[ENT]** key once more. A short “beep” will confirm that the frequency entry was successful, and the new operating frequency will appear on the VFO-A frequency display fields.

Example 2:

Enter 7.100.000 MHz into the VFO-B:

1. Press the **[B]** key (#27).
2. Press the **[ENT]** key (#63) to engage the direct frequency entry process. Now, beginning with the “10 MHz” digit of the frequency (the leftmost digit), we will enter the required digits of the frequency to be entered into the VFO-B register.
3. Press, in order, the digits of the operating frequency, using the **[BAND]** keys (#63): which have the frequency-entry digit or decimal point on the right side of the slash bar). In this example, enter

**[7/18] → [./50] → [1/1.8] → [0/28]
[0/28] → [0/28] → [0/28] → [0/28]**

4. Press the **[ENT]** key once more. A short “beep” will confirm that the frequency entry was successful, and the new operating frequency will appear on the VFO-A frequency display fields.

Advice

- In the above examples, you will notice that the trailing “zero” digits of the frequency were not entered. It is not necessary to enter these trailing zeroes; just press the **[ENT]** to terminate frequency entry, and they will be entered automatically.
- If you attempt to enter a frequency outside the operating range of 30 kHz ~ 60 MHz, the microprocessor will ignore the attempt, and you will be returned to your previous operating frequency. If this happens, please try again, taking care not to repeat the error in the frequency entry process.

- Using the **[CLAR/VFO-B]** knob (#84), you may change the VFO-A frequency in 1 MHz steps. If you first press and hold in the **[BAND/MHz]** key (#81) for two seconds, the 1 MHz steps will be applied to the VFO-B instead. The imbedded LED in the **[BAND/MHz]** key will glow Red in the latter case.

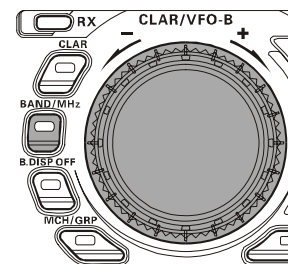

When tuning in 1 MHz steps, clockwise rotation of the **[CLAR/VFO-B]** knob will increase the frequency, while counter-clockwise rotation will decrease the frequency.

Using the UP/DOWN switches of the optional MD-200A8X Base Station Microphone

The UP/DOWN switches on the optional MD-200A8X Base Station Microphone may also be used for manually scanning upward or downward in frequency, respectively.

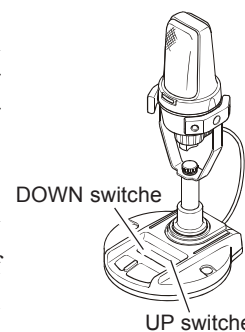

The microphone’s UP/DOWN switches utilize the tuning steps of the **[Main]** Tuning Dial knob (#34); moreover, when the microphone’s **[FAST]** key is pressed, the tuning rate increases by a factor of ten, in a manner similar to the effect of the transceiver’s front-panel **[FAST]** key (#35).

MODE	UP	DWN	FST+UP	FST+DWN
LSB, USB, CW, RTTY, PKT(LSB)	+10 Hz	-10 Hz	+100 Hz	-100 Hz
AM, FM, PKT(FM)	+5 kHz	-5 kHz	+50 kHz	-50 kHz

Advice

In the Am and FM modes, you may independently set the tuning steps when using the UP/DOWN switches. To set new tuning steps, use Menu items “**TUNING 132 AM CH STEP**” and “**TUNING 133 FM CH STEP**.”

ANTENNA SELECTION

Four main antenna jacks, available for both transmission and reception, are provided on the rear panel of the transceiver. What's more, a receive-only jack is provided, and the incoming signal path may also have a special after-market filter or preamplifier inserted, if desired, with one-touch access.

Selection of the desired TX/RX antenna is accomplished by pressing the appropriate **[1]** ~ **[4]** Antenna Selection switch (#9) on the front panel.

To engage the RX-only antenna, press the **[RX]** switch within the Antenna Selection switch group (#9) on the front panel. The RX-only antenna must be connected to the corresponding "RX ANT" antenna jack on the rear panel.

The antenna currently selected for use on the VFO-A will be designated by a Red LED.

The antenna currently selected for use on the VFO-B will be designated by an Orange LED.

If both VFOs are utilizing the same antenna, both the Red and Orange LEDs will light up on the same antenna location.

【ANTENNA SELECT】switch

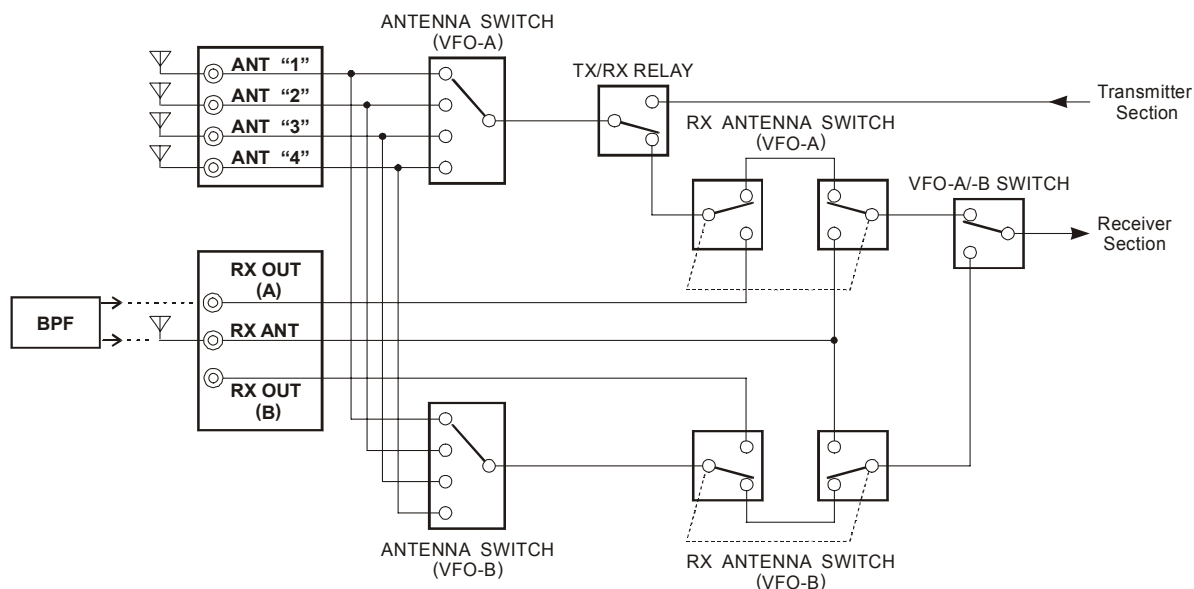
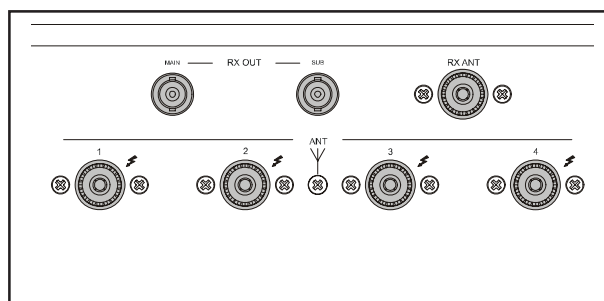
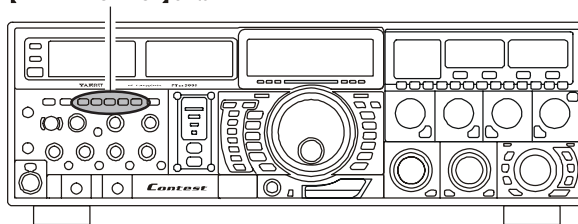

CONVENIENT FEATURES

RECEIVER OPERATION (FRONT END BLOCK DIAGRAM)

The FT DX 9000 Contest includes a wide range of special features to suppress the many types of interference that may be encountered on the HF bands. However, real world interference conditions are constantly changing, so optimum setting of the controls is somewhat of an art, requiring familiarity with the types of interference and the subtle effects of some of the controls. Therefore, the following information is provided as a general guideline for typical situations, and a starting point for your own experimentation.

We provide the RF -TUNING Unit (Narrow-bandwidth High-Q RF Filter) for the customized option..

VRF (See page 54)

On the HF/50 MHz Amateur bands, Yaesu's powerful VRF (Variable RF Filter) preselector circuit provides excellent suppression of out-of-band interference, with a passband much narrower than that provided by traditional fixed bandpass filters.

R. FLT (IF Roofing Filters) (See page 55)

Three automatically-selected Roofing filters, in bandwidths of 15 kHz, 6 kHz, and 3 kHz, are provided in the 40 MHz First IF, right after the first mixer. These filters provide narrow-band selectivity to protect the following IF and DSP stages, and the filters' automatically-selected bandwidths may be manually changed by the operator, if desired, for special operating circumstances.

CONTOUR Filter (See page 56)

The Contour filter is a unique capability of the FT DX 9000 Contest, providing either nulling or peaking of tunable segments of the receiver passband, so as to suppress interference or excessive frequency components on an incoming signal, or to peak those tunable frequency segments. The amount of nulling/peaking, and the bandwidth over which it is applied, are adjustable via the Menu.

IF SHIFT (See page 57)

The passband center frequency response of the IF DSP filtering may be adjusted using this control.

IF WIDTH (See page 58)

The width of the IF DSP filtering may be carried using this control.

IF NOTCH (See page 59)

The IF Notch filter is a high-Q notch filter that can significantly reduce, if not eliminate, an interfering carrier. The Q (sharpness) of the filter may be adjusted using the Menu.

NR (Digital Noise Reduction) (See page 60)

The DSP's Digital Noise Reduction (DNR) feature utilizes sixteen different mathematical algorithms to analyze and suppress different noise profiles encountered on the HF/50 MHz bands. Choose the selection that provides the best noise suppression, which concurrently will allow the signal to rise up out of the noise.

D.NOTCH (Digital Notch filter) (See page 62)

When multiple interfering carriers are encountered during reception, the Digital Notch Filter can significantly reduce the level of these signals.

AGC (See page 63)

The AGC system is highly adaptable to changing signal and fading characteristics, making reception possible under the most difficult conditions.

SLOPED AGC (See page 64)

The Sloped AGC system, instead of clamping a fixed upper bound on audio output across a wide range of input signals, actually allows the audio output to rise, very gently, with ever-increasing signal strength. This capability allows you to separate signals, using your brain, according to signal strength in addition to slight frequency differences.

IF Filter Quality Adjustment (See page 124)

The "Q" (quality factor) of the IF DSP filters may be adjusted independently for the IF DSP filters, using the Menu.

Variable IF Filter Shape Factor (See page 124)

You may adjust the shape factor of the IF DSP filters, using the Menu.

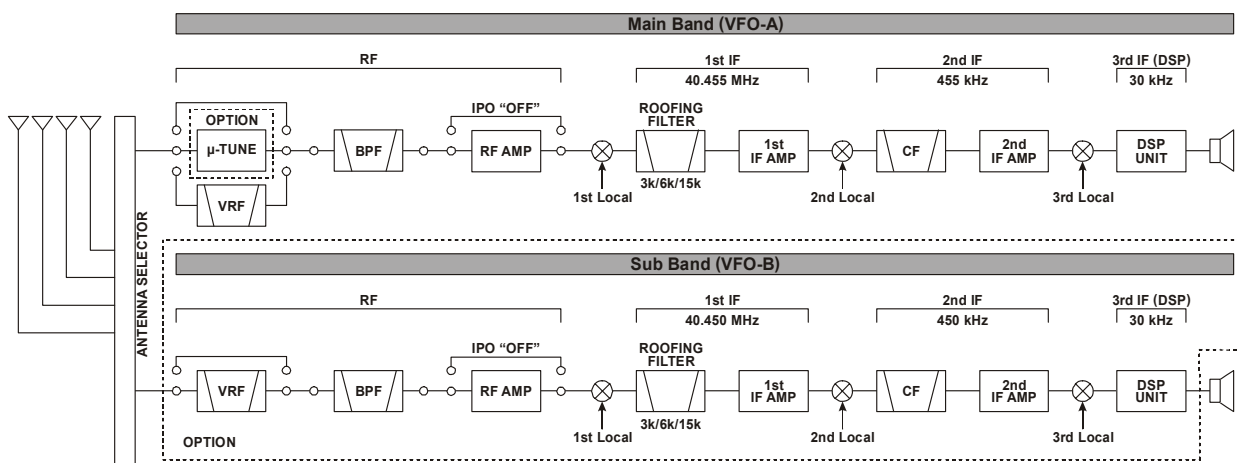

IPO (INTERCEPT POINT OPTIMIZATION)

Normally, the front-end FET RF amplifiers provide maximum sensitivity for weak signals. During typical conditions on lower frequencies (where strong signals and high noise are common), the RF amplifiers can be bypassed by pressing the IPO button so that the button's illumination is lit. This improves the IMD (intermodulation distortion) rejection characteristics of the receiver, with only a slight reduction of sensitivity. On frequencies below about 10 MHz, you generally will want to keep the IPO button engaged at all times, as the preamplifiers are usually not needed at these frequencies unless you are using a Beverage or other lossy receive antenna.

『Quick Note』

The FT DX 9000 Contest's first mixer is an active type, using four SST310 Junction FETs. This mixer design provides gain to the receiver chain, so the noise figure of the receiver is fundamentally lower than with some other designs. Therefore, it frequently is not necessary to utilize the RF preamplifier, and the receiver Intercept Point will be substantially increased by engaging IPO, so as to feed the incoming signals directly to the first (active) mixer. We recommend that IPO be switched on whenever possible.

VFO-A IPO Setup

Press the VFO-A side's **【A-IPO switch】** key (#8) to engage the IPO on the VFO-A.

A Red LED imbedded in the switch will light up, and the preamplifier for the VFO-A will be bypassed. The system gain and sensitivity will be reduced.

To cancel IPO operation and restore full system gain and sensitivity, press the **【A-IPO switch】** key once more.

VFO-B IPO Setup

Press the VFO-B side's **【B-IPO switch】** key (#8) to engage the IPO on the VFO-B.

An Orange LED imbedded in the switch will light up, and the preamplifier for the VFO-B will be bypassed. The system gain and sensitivity will be reduced.

To cancel IPO operation and restore full system gain and sensitivity, press the **【B-IPO switch】** key once more.

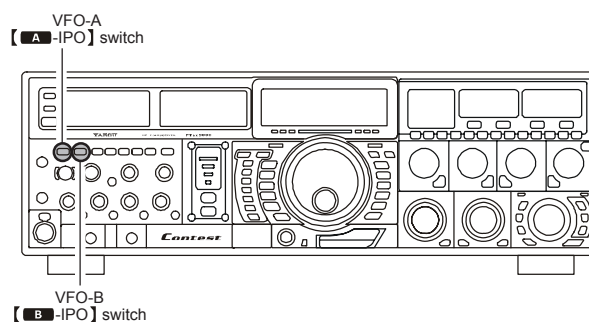

CONVENIENT FEATURES

ATT

Even with the IPO function on, extremely strong local signals or high noise can still degrade reception. In such situations, you can use the **【ATT】** switch to insert 3, 6, 12, or 18-dB of RF attenuation in front of the RF amplifier.

Rotate the **【ATT】** switch (#13) to set the desired attenuation level, per the chart below.

To restore full signal strength through the Attenuator circuit area, set the **【ATT】** switch to the “0” position.

0 dB	Attenuator is Off
3 dB	The incoming signal power is reduced by 3 dB (signal voltage reduced by 1/1.4)
6 dB	The incoming signal power is reduced by 6 dB (signal voltage reduced by 1/2)
12 dB	The incoming signal power is reduced by 12 dB (signal voltage reduced by 1/4)
18 dB	The incoming signal power is reduced by 18 dB (signal voltage reduced by 1/8)

『Advice』

If background noise causes the S-meter to deflect on clear frequencies, turn the **【ATT】** knob clockwise until the S-meter drops to about “S-1.” This setting optimizes the trade-offs between sensitivity, noise, and interference immunity. Also, once you have tuned in a station you want to work, you may want to reduce sensitivity further (or add more attenuation) by turning the **【ATT】** knob to a more clockwise setting. This reduces the strength of all signals (and noise) and can make reception more comfortable, important especially during long QSOs.

When looking for weak signals on a quiet band, you will want maximum sensitivity, so the IPO should be disabled and the **【ATT】** knob should be set to “0.” This situation is typical during quiet times on frequencies above 21 MHz, and when using a small or negative-gain receiving antenna on other bands.

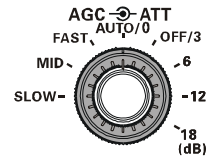
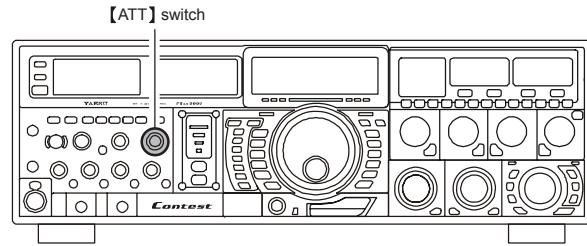

RF GAIN (SSB/CW/AM MODES)

The RF Gain controls provide manual adjustment of the gain levels for the receiver RF and IF stages, to account for noise and/or signal strength conditions at the moment.

The **【RF GAIN】** control (#73) should, initially, be rotated to the fully clockwise position. This is the point of maximum sensitivity, and counter-clockwise rotation will gradually reduce the system gain.

- As the **【RF GAIN】** control is rotated counterclockwise to reduce the gain, the S-meter reading will rise. This indicates that the AGC voltage being applied to the receiver (to reduce the gain) is increasing.
- Rotating the **【RF GAIN】** control to the fully counterclockwise position will essentially disable the receiver, as the gain will be greatly reduced. In this case, as well, the S-meter will appear to be “pegged” against the right edge of the analog S-meter scale.

『Advice』

Reception frequently can be optimized by rotating the RF Gain control slightly counter-clockwise to the point where the incoming noise level is just about the same as the “stationary” meter needle position as set by the adjustment of the **【RF GAIN】** control. This setting ensures that excessive gain is not being utilized, without so much gain reduction that incoming signals cannot be heard.

『Quick Point』

The **【RF GAIN】** control, along with the IPO and Attenuator features, all affect the system receiver gain in different ways. As a first step in dealing with high noise or a crowded, high-level signal environment, the IPO generally should be the first feature engaged, if the frequency is low enough to allow the preamplifier to be bypassed. Thereafter, the RF Gain and Attenuator features may be employed to provide precise, delicate adjustment of the receiver gain so as to optimize performance fully.

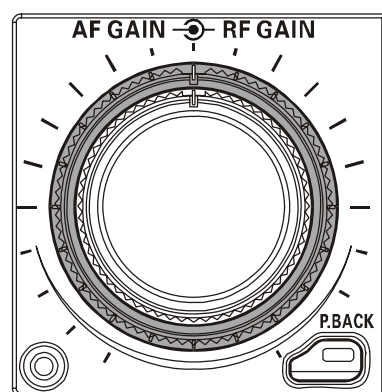
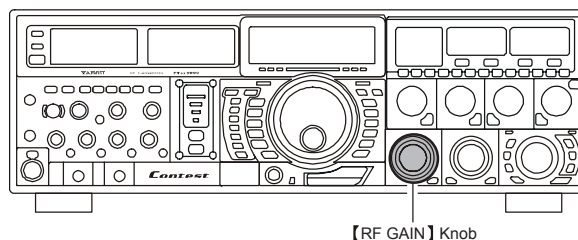

ADVANCED INTERFERENCE-SUPPRESSION FEATURES: RF FRONT END

USING THE VRF (VARIABLE RF FRONT-END FILTER)

The VRF system is a high-performance RF front-end preselector that provides outstanding rejection of out-of-band signals.

1. Press the **【VRF/μ】** switch (#69) momentarily. The LED inside the switch will become illuminated, and the VRF system will be engaged, centered on your current Amateur band.
2. You may rotate the **【VRF/μ】** knob (#68) to skew the position of the VRF system relative to your operating frequency. Because the VRF system is relatively broad, although still much narrower than the fixed bandpass filter, you may not hear much difference in the background noise or signal quality when you make minor adjustments. However, if you have receiving problems associated by a very strong signal, rotation of the **【VRF/μ】** knob may help reduce the strength of the interfering station, allowing improved reception of the desired signal.
 - After moving the passband of the VRF system manually, you may re-center it on the current Amateur band by pressing and holding in the **【VRF/μ】** switch for two seconds.
 - To switch VRF off, press the **【VRF/μ】** switch momentarily again. The LED imbedded in the switch will go out, and the VRF circuit will be removed from the incoming received signal path.

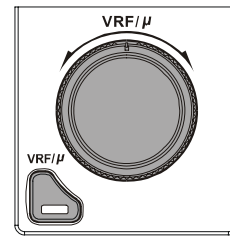
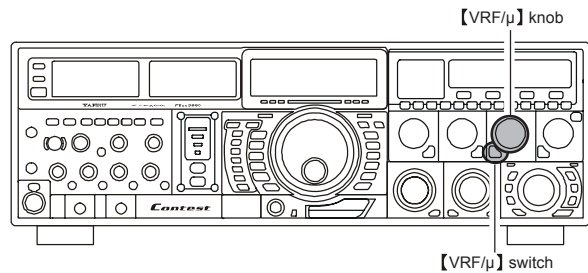

『Quick Point』

The VRF filter, utilizing high-quality coils and capacitors that provide high Q, yields a passband that is approximately 20% to 30% the width of a traditional, fixed bandpass filter. As a result, significantly more unwanted signal rejection is provided. Within each Amateur band, 64 adjustment steps are provided (50 MHz: 8 steps), if you wish to skew the response in a particular direction so as to enhance interference rejection even more.

INTERFERENCE REJECTION (SIGNALS OFF FREQUENCY BY JUST A FEW KHZ)

ROOFING (ROOFING FILTERS)

Narrow-band Roofing Filters of 15 kHz, 6 kHz, and 3 kHz bandwidths are provided in the first IF, right after the first mixer. These filters provide protection for the 2nd mixer, DSP, and other circuitry that follow, and can dramatically improve reception on a very crowded band (during a contest, etc.). Typically, the AUTO selection mode is satisfactory for most operating situations, but in an extremely crowded phone band you may wish to select, for example, the 3 kHz roofing filter for SSB operation.

Press the **[ROOFING]** switch (#25) to toggle the Roofing Filter selection.

AUTO → 15 kHz → 6 kHz → 3 kHz → AUTO

- As you repeatedly press this switch, you will observe different LEDs lighting up in the Roofing Filter area of the front panel, denoting the Roofing Filter currently in use.
- Typically, this selection will be set to “AUTO.”
- The Roofing Filter selection will be memorized independently on each VFO in the VFO stack.

『Quick Point』

- The “AUTO” selection of the Roofing Filter is based on the operating mode. However, you may override the automatic selection, if band conditions warrant a different (usually, a tighter) selection.
- The AUTO mode Roofing Filter selections are shown below:

AM/FM/FM-PKT	15 kHz
LSB/USB/PKT	6 kHz
CW/RTTY	3 kHz

- When the Roofing filter mode is set to “AUTO” and the Noise Blanking is turned On, the Roofing Filter bandwidth will automatically be set to 15 kHz, as this setting provides the most effective noise blanking. However, you still may override the automatic setting, and select a more narrow Roofing Filter. Noise blanking may be compromised, however, with a tighter Roofing Filter in the line.

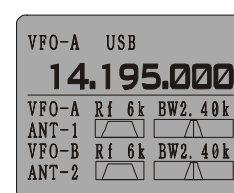
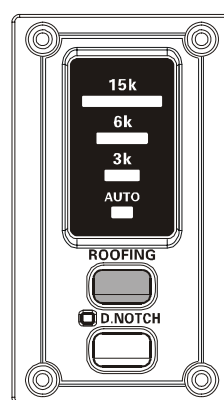
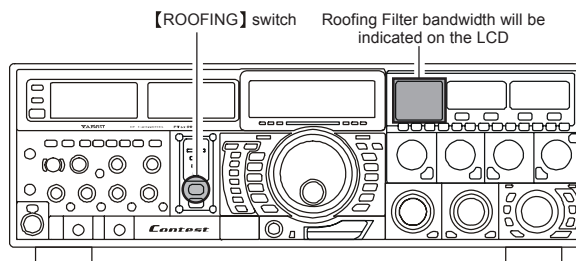

『Terminology』

A “Roofing Filter,” as its name implies, places a “Roof” over the receiver’s IF system bandwidth. This “Roof” protects the circuitry downstream from the first mixer from interference, just as a roof on a house protects the contents from rain and snow.

INTERFERENCE REJECTION (SIGNALS WITHIN 3 KHZ)

CONTOUR CONTROL OPERATION

The Contour filtering system provides a gentle perturbation of the IF filter passband, so as to suppress or enhance certain frequency components modestly, so as to enhance the natural-sounding received signal.

1. Press the **【CONT】** switch (#65). The LED imbedded in the switch will glow Red to confirm that the Contour filter is engaged.
2. Rotate the **【CONTOUR】** knob (#64) to achieve the most natural-sounding audio reproduction on the incoming signal. To cancel Contour tuning, press the **【CONT】** switch once more.

『Advice』

- When the optional Data Management Unit (DMU-9000) and TFT Display Unit (TFT-9000) are installed, you may use the Audio Scope on the Audio Scope/Oscilloscope page on the TFT to help you adjust the setting of the Contour control for the optimum performance. The effect of the Contour filter adjustments within the Audio Scope passband will be easy to see on the Audio Scope.
- The Width of the Contour filter effect, and the degree of nulling or peaking, may be adjusted using the menu.
 - The Contour filter's level (either nulling or peaking) may be adjusted using Menu Item **“RX DSP 078 MAIN-CONTOUR-LEVEL.”** The factory default setting is -15.
 - The bandwidth over which the Contour filter effect is applied may be adjusted using Menu Item **“RX DSP 079 MAIN-CONTOUR-WIDTH.”** The factory default setting is 10.

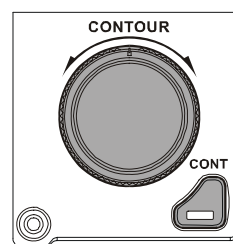
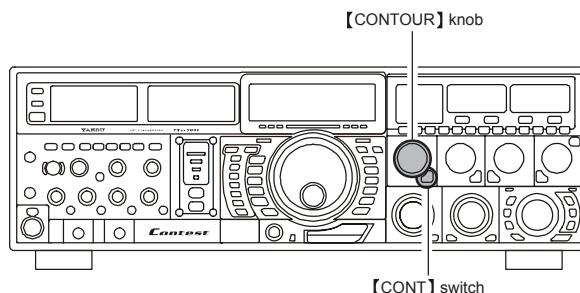

『Quick Point』

The steep slopes of the DSP filtering can, when adjusted aggressively, impart an unnatural sound to an incoming signal. Oftentimes, though, a narrow bandwidth is not the key to improving copy; the incoming signal itself may have undesirable or excessive frequency components, especially in the low-frequency range around 400 Hz. By judicious use of the Contour filter, the “shoulder” of the passband response may be altered, or components removed from within the passband, allowing the desired signal to rise above the background noise and interference in a manner not obtainable with other filtering systems.

With reference to Figure (B), note the initial position (12 o'clock) of the **【CONTOUR】** control when the **【CONT】** switch is pushed. You may observe the "indentation" in the receiver passband where the Contour filter is placing a low-Q “notch” (per the setting of Menu #078, referenced above). Counter-clockwise rotation (to the left) of the Contour knob causes the indentation to move toward a lower frequency within the passband, while clockwise rotation (to the right) causes the indentation to move toward a higher frequency within the passband. By removing interference or unwanted frequency components on the incoming signal, it is possible to make the desired signal rise out of the background noise/interference, enhancing intelligibility.

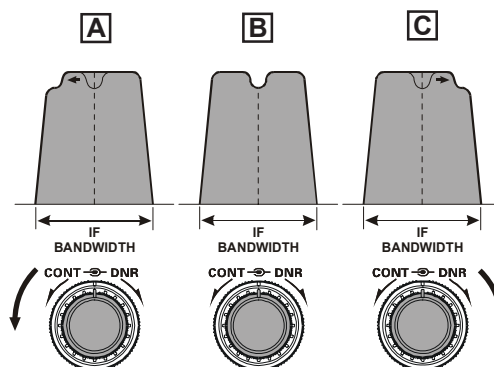

INTERFERENCE REJECTION (SIGNALS WITHIN 3 KHZ)

IF SHIFT OPERATION (SSB/CW/RTTY/PKT MODES)

IF Shift allows you to vary the DSP filter passband higher or lower, without changing the pitch of the incoming signal, so as to reduce or eliminate interference. Because the carrier tuning frequency is not varied, there is no need to re-tune the operating frequency when eliminating the interference. The total passband tuning range for the IF Shift system is ± 1 kHz.

Rotate the **[SHIFT]** (#76) control to the left or right to reduce the interference.

『Advice』

The position of the IF Shift system may be observed on the LCD.

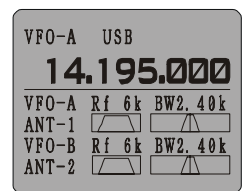
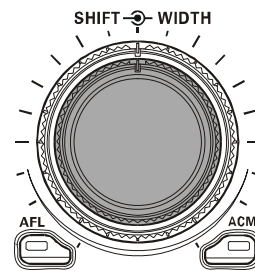
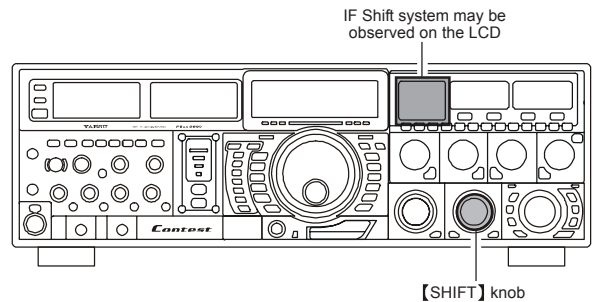

IF Shift system may be observed

Referring to Figure (A), note the depiction of the IF DSP filter as the thick line, with the **[SHIFT]** control in the 12 o'clock position. In Figure (B), an interfering signal has appeared inside the original passband. In Figure (C), you can see the effect of rotating the **[SHIFT]** control so as to reduce the interference level by moving the filter passband so that the interference is outside of the passband.

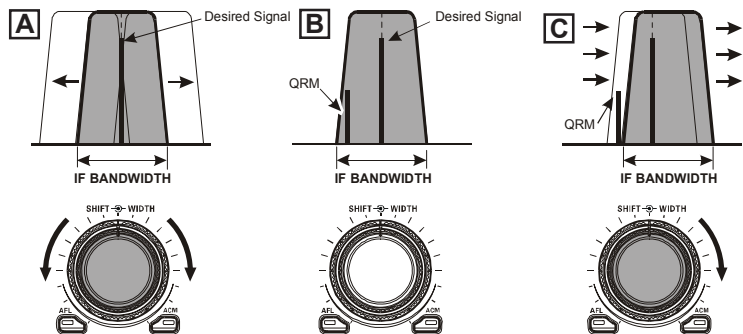

INTERFERENCE REJECTION (SIGNALS WITHIN 3 KHZ)

WIDTH (IF DSP BANDWIDTH) TUNING (SSB/CW/RTTY/PKT MODES)

The IF Width tuning system allows you to vary the width of the DSP IF passband, so as to eliminate interference. Moreover, the bandwidth may actually be expanded from its default setting, should you wish to enhance incoming signal fidelity when interference on the band is low.

Rotate the **[WIDTH]** knob (#76) to adjust the bandwidth. Counter-clockwise rotation reduces the bandwidth, while clockwise rotation increases the bandwidth.

By rotating the **[WIDTH]** knob to the left, the bandwidth will narrow (see Figure (A)), while rotation of the **[WIDTH]** knob to the right, as depicted in Figure (C), will widen the bandwidth. The default bandwidths, and total bandwidth adjustment range, will vary according to the operating mode:

SSB Mode

200 Hz ~ 4.0 kHz (bandwidth at 12 o'clock position of **[WIDTH]**: 2.4 kHz).

CW/RTTY/PKT Modes

25 Hz ~ 2.4 kHz (bandwidth at 12 o'clock position of **[WIDTH]**: 500 Hz).

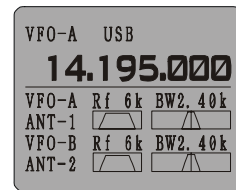
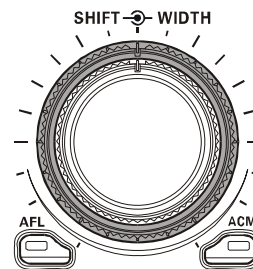
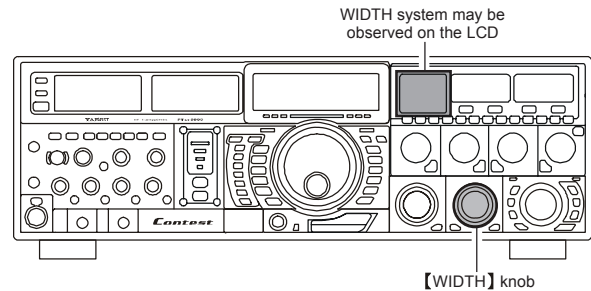
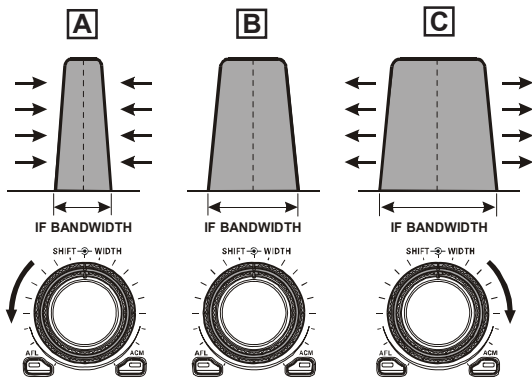

WIDTH system may be observed on the LCD

『Advice』

You may observe the effects of adjustment of the **[WIDTH]** control on the LCD.

Using IF Shift and Width Together

The IF Shift and Variable IF Width features together form a very effective interference-fighting filtering system.

For example, in Figure (A) you can see how interference has appeared both on the high and low sides of the desired signal. By rotating the **[WIDTH]** control, as shown in Figure (B), the interference from one side can be eliminated, and by re-positioning the **[SHIFT]** control (Figure (C)), the interference on the opposite side can be removed, without re-introducing the interference previously eliminated in Figure (B).

『Advice』

For best interference reduction, the Width and Shift features are the primary tools you should use. After narrowing the bandwidth (Width) and/or adjusting the center of the passband (Shift), the Contour control may also yield additional signal-enhancement benefits on the net residual bandwidth. What's more, the IF Notch Filter (see the next section) may also be utilized, in conjunction with the three other filter systems, to significant advantage.

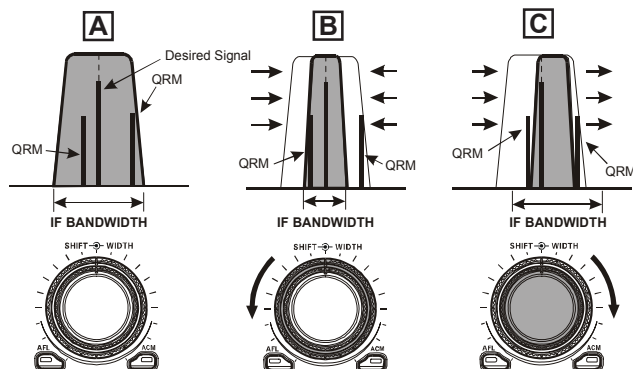

INTERFERENCE REJECTION (SIGNALS WITHIN 3 KHZ)

IF NOTCH FILTER OPERATION (SSB/CW/RTTY/PKT/AM MODES)

The IF Notch filter is a highly-effective system that allows you to slice out an interfering beat note or other carrier signal from inside the receiver passband.

1. Press the **【NOTCH】** switch (#71). The LED imbedded in the switch will glow Red to confirm that the IF Notch filter has been engaged.
2. Rotate the **【NOTCH】** knob (#70) to null out the interfering carrier.

To switch the IF Notch filter off, press the **【NOTCH】** switch once more. The LED imbedded in the switch will turn off, confirming that the IF Notch filter is no longer operating.

『Advice』

- When the optional Data Management Unit (DMU-9000) and TFT Display Unit (TFT-9000) are installed, you may use the Audio Scope on the Audio Scope/Oscilloscope page on the TFT to help you adjust the setting of the Notch filter control for the optimum performance. The effect of the Notch filter adjustments will be easy to see on the Audio Scope.
- The width of the IF Notch null may be adjusted using Menu Item “**RX DSP 082 IF-NOTCH-WIDTH.**” Both “Wide” and “Narrow” selections are available, with “Narrow” providing the least disruption of the “desired” signal.
- Under the frequency display, you may also use the Bar Display to show the position of the IF Notch. Use Menu Item “**DISPLAY 016 BAR DISPLAY SELECT**” to engage this function.

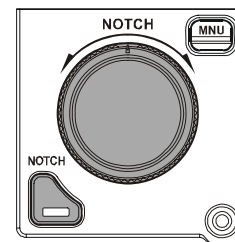
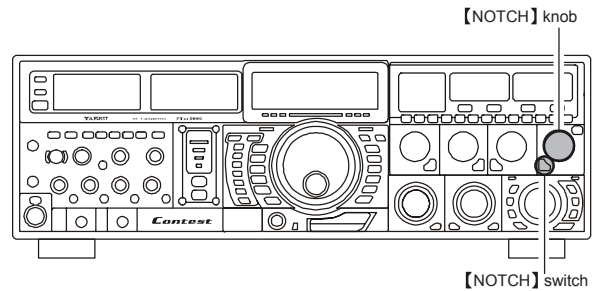

『Note』

When the **【NOTCH】** switch is pressed and held in for two seconds, the center of the notch action will be reset to the positions described below (mode-sensitive):

SSB/AM: The Notch will center at 1.5 kHz (center of the receiver passband).

CW: The Notch will center on the frequency programmed by the **【PITCH】** knob (#14).

The performance of the IF Notch filter is shown in Figure (A), where the effect of rotation of the **【NOTCH】** knob is depicted. In Figure (B) you can see the notching effect of the IF Notch filter as you rotate the **【NOTCH】** knob to eliminate the incoming interference.

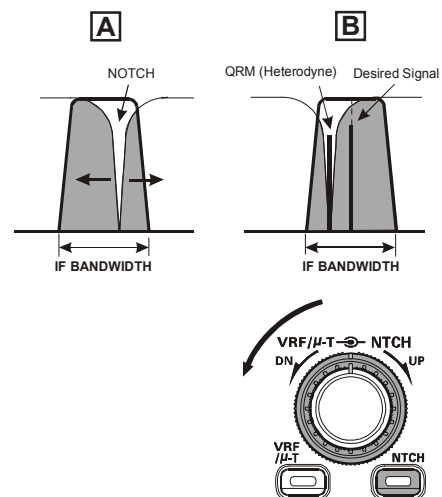

INTERFERENCE REJECTION (SIGNALS WITHIN 3 KHZ)

DIGITAL NOISE REDUCTION (NR) OPERATION

The Digital Noise Reduction (NR) system is designed to reduce the level of random noise found on the HF and 50 MHz bands, and it is especially effective during SSB operation. By rotating the **【NR】** knob, any of sixteen different noise-reduction algorithms can be selected; each of these algorithms was create for dealing with a different noise profile, and you will want to experiment with the NR system to find the best setting according to the noise currently being experienced.

1. Press the **【NR】** switch (#67). The LED imbedded in the switch will glow Red, confirming that the DNR system is engaged.
2. Rotate the **【NR】** knob (#66) to select the setting that most effectively reduces the noise level.

To disable the NR system, press the **【NR】** switch once more. The imbedded LED will turn off, confirming that the NR system is not active.

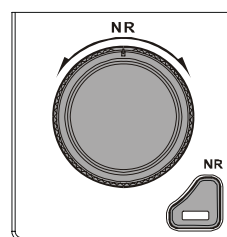
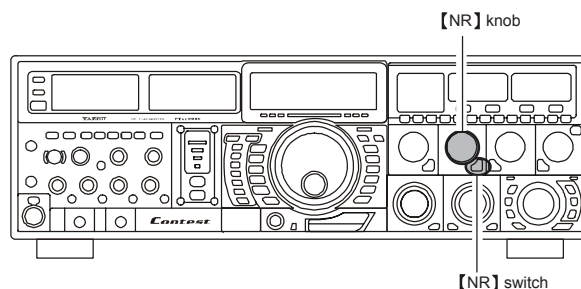

INTERFERENCE REJECTION (SIGNALS WITHIN 3 KHZ)

NARROW (NAR) ONE-TOUCH IF FILTER SELECTION

Pressing the **[NAR]** switch (#29) provides one-touch, mode-specific selection of a narrow IF DSP filter setting that does not depend on the setting of the Width control. Pressing the **[NAR]** switch once more returns the bandwidth control to the Width/Shift system. The factory default bandwidths are:

SSB Mode

Pressing the **[NAR]** switch selects a bandwidth of 1.8 kHz.

CW/RTTY/PKT Modes

Pressing the **[NAR]** switch selects a bandwidth of 300 Hz.

AM Mode

Pressing the **[NAR]** switch selects a bandwidth of 6 kHz.

FM Mode (28/50 MHz Bands)

Pressing the **[NAR]** switch selects a bandwidth of 9 kHz.

『Advice』

- The bandwidth applied when the **[NAR]** switch is pressed may be adjusted using the Menu. This allows you to customize a quick-switch “Narrow” bandwidth matching your operating needs (in examples below, the default setting is underlined).

SSB

Main (VFO-A)

RX DSP 094 MAIN-SSB-NARROW

200/400/600/850/1100/1350/1500/
1650/1800/1950/2100/2250 Hz

Sub (VFO-B)

RX DSP 106 SUB-SSB-NARROW

200/400/600/850/1100/1350/1500/
1650/1800/1950/2100/2250 Hz

CW

Main (VFO-A)

RX DSP 085 MAIN-CW-NARROW

25/50/100/200/300/400 Hz

Sub (VFO-B)

RX DSP 097 SUB-CW-NARROW

25/50/100/200/300/400 Hz

PSK

Main (VFO-A)

RX DSP 088 MAIN-PSK-NARROW

25/50/100/200/300/400 Hz

Sub (VFO-B)

RX DSP 100 SUB-PSK-NARROW

25/50/100/200/300/400 Hz

RTTY

Main (VFO-A)

RX DSP 91 MAIN-RTTY-NARROW

25/50/100/200/300/400 Hz

Sub (VFO-B)

RX DSP 103 SUB-RTTY-NARROW

25/50/100/200/300/400 Hz

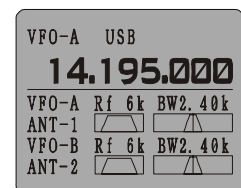
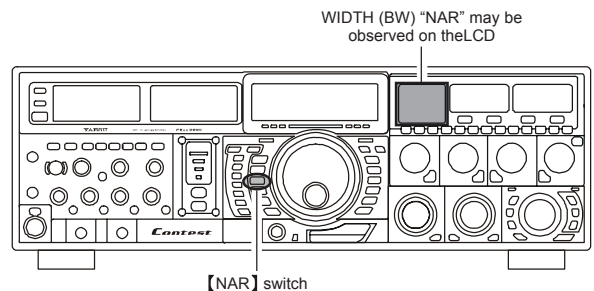

WIDTH (BW) “NAR” may be observed on the LCD

『Advice』

- When the **[NAR]** button has been pushed so as to engaged the narrow filter, the Width control will be disabled, but IF Shift still is operational. For many applications, you may find that simple adjustment of the **[WIDTH]** control (#78), instead of engaging the Narrow filter, may be satisfactory for interference reduction.
- When you press the **[NAR]** button in the FM mode, both the transmit and receive bandwidths are narrowed.

『Note』

When the **[NAR]** button is pressed, the **[WIDTH]** control no longer functions.

INTERFERENCE REJECTION (SIGNALS WITHIN 3 KHZ)

DIGITAL NOTCH FILTER (D.NOTCH) OPERATION

The Digital Notch Filter (D.NOTCH) is an effective beat-cancelling filter that can null out a number of interfering beat notes inside the receiver passband. Because this is an Auto-Notch feature, there is no adjustment knob associated with this filter.

『Advice』

If a very strong interfering carrier is encountered, we recommend you first use the IF Notch filter, as it is the most effective notching tool in the receiver section.

Press the **[D.NOTCH]** switch (#26) to engage the Digital Notch filter. The LED imbedded in the switch will glow Red, to confirm that the DNF circuit is engaged.

To cancel D.NOTCH operation, press the **[D.NOTCH]** switch once more. The imbedded LED will go out, confirming that the Digital Notch Filter is no longer in operation.

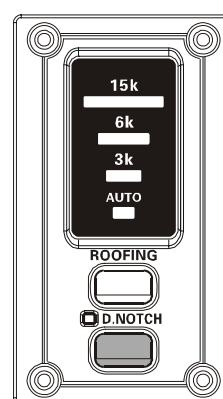
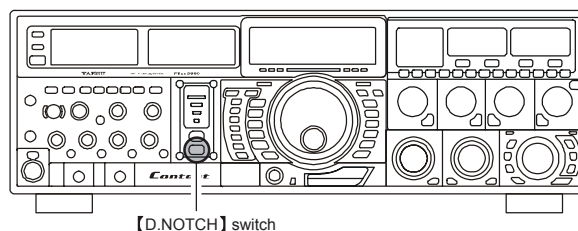

IF NOISE BLANKER (NB) OPERATION

The FT DX 9000 Contest includes an effective IF Noise Blanker, which can significantly reduce noise caused by automotive ignition systems.

1. Press the VFO-A **[NB]** switch (#22) momentarily to reduce a short pulse noise such as from switching transients, automobile ignitions and power lines. The LED imbedded in the switch will glow Red to confirm that the Narrow-NB is operating.

Press and hold the VFO-A **[NB]** switch for two seconds to reduce a longer duration man-made pulse noise. The LED imbedded in the switch will glow Yellow to confirm that the Wide-NB is operating.

2. Advance the VFO-A **[NB]** control (#21) to the point where the offending ignition noise is best reduced or eliminated.

To end Noise Blanker operation, press the **[NB]** switch once more. The LED imbedded in the switch will turn off, confirming that the Noise Blanker is no longer in operation.

『Advice』

When the Roofing filter mode is set to "AUTO" and the Noise Blanker is turned On, the Roofing Filter bandwidth will automatically be set to 15 kHz.

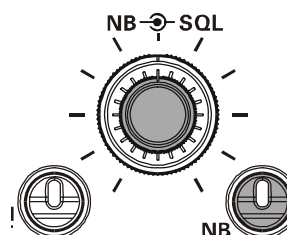
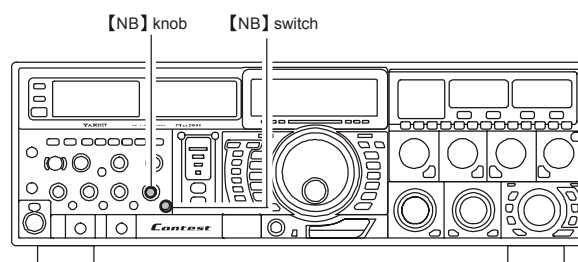

TOOLS FOR COMFORTABLE AND EFFECTIVE RECEPTION

AGC (AUTOMATIC GAIN CONTROL)

The AGC system is designed to help compensate for fading and other propagation effects, with characteristics that can be of particular value on each operating mode. The basic objective of AGC is to maintain a constant audio output level once a certain minimum threshold of signal strength is achieved.

Rotate the **【AGC】** switch (#13) to select the desired receiver-recovery time constant. For most operation, we recommend the “AUTO” mode.

Rotation of the **【AGC】** switch allows selection of the desired receiver-recovery time constant. Normally, the “AUTO” selection is satisfactory for most situations, but in the event of operation on a crowded band where you wish to receive a weak signal, you may wish to change the setting (to FAST, for example). The AUTO mode selections are:

Operation Mode	AUTO AGC Selection
LSB	SLOW
USB	SLOW
CW	FAST
AM	FAST
FM	FAST
RTTY	SLOW
PKT(FM)	FAST
PKT(LSB)	SLOW

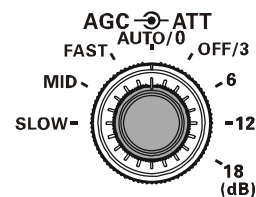
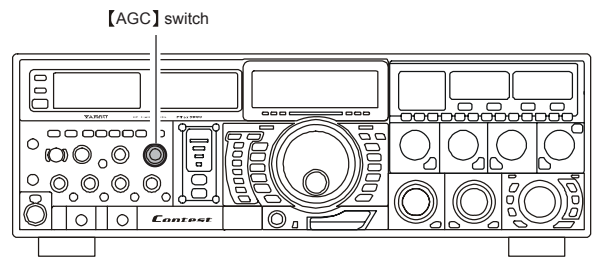

『Advice』

If the **【AGC】** switch is set to the “Off” position, the S-meter will no longer deflect. Additionally, you will likely encounter distortion on stronger signals, as the IF amplifiers and the following stages are probably being overloaded.

『Quick Point』

Several aspects of AGC performance may be configured via the Menu. However, because AGC can have such a profound impact on overall receiver performance, we generally do not recommend any changes to the AGC Menu selections.

『Terminology』

Automatic Gain Control, or AGC, is a circuit that senses the incoming signal strength, and then limits the gains of the RF and IF stages so as to keep the output audio volume at a more-or-less constant level. AGC also protects the RF, IF, Audio, and DSP stages from overload, as it limits the signal strength that is allowed to flow, irrespective of the input signal level.

SLOPED AGC Operation

TOOLS FOR COMFORTABLE AND EFFECTIVE RECEPTION

AGC (AUTOMATIC GAIN CONTROL)

In traditional AGC systems, the audio output from the transceiver becomes essentially fixed once the threshold for AGC action is reached (usually several dozen dB above the no-signal noise floor). The FT DX 9000 Contest, however, includes an innovative Sloped AGC system, that allows the audio volume to rise and fall slightly according to signal strength. Although the rise/fall are not dramatic, they are sufficient to allow you to use your ear to discern and separate signals according to signal strength, not just audio frequency.

Using Sloped AGC

1. To the bottom right side of the LCD, press the **[MNU]** (Menu) key (#72) momentarily to enter the Menu mode; the Menu will appear on the LCD.
2. Use the **[Main]** Tuning Dial knob (#34) to select Menu Item “**RX AUDIO 075 AGC-SLOPE**.”
3. Rotate the **[CLAR/VFO-B]** knob (#84) to change the setting to “SLOPE.”
4. Press and hold in the **[MNU]** key for two seconds to save the new setting and exit to normal operation. You will now be using the Sloped AGC system.

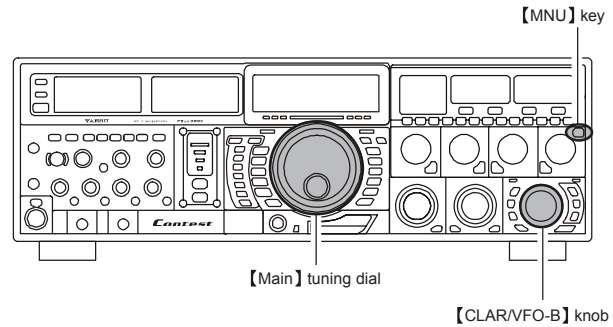
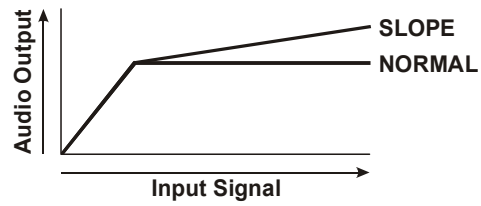

TOOLS FOR COMFORTABLE AND EFFECTIVE RECEPTION

AUDIO LIMITER (AFL) FEATURE

Particularly when the AGC is off, you may desire to limit the level of audio output that is permitted to flow to the speaker or earphones. For these circumstances, the AFL (Audio Limiter) feature will provide the desired cap on the audio output.

Press the **AFL** switch (#75) to turn on the Audio Limiter. The imbedded LED in the button will glow red. To disable the Audio limiter, press the **AFL** switch once more; the imbedded LED will turn off.

『Advice』

Because the AFL feature will generally reduce the overall audio level, we recommend that it be left Off unless special operating conditions warrant its use.

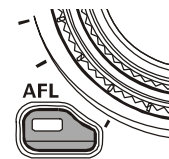
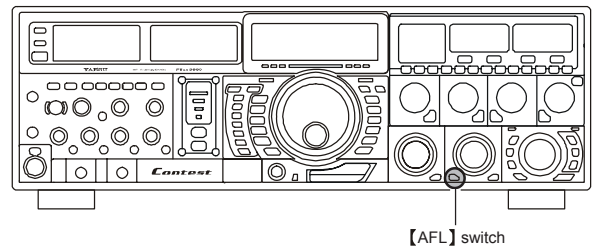

SSB/AM MODE TRANSMISSION

- The operating mode is selected using the **[MODE]** switches (#27) to the left of the **[Main]** Tuning Dial knob (#34), and the VFO (A or B) to which the selection is applied is selected by pressing the **[A]** or **[B]** switch above the Mode keys. Press the **[A]** or **[B]** key to select the desired VFO, then press the **[LSB]** or **[USB]** key to select one of the SSB modes. For AM operation, press the **[AM]** key.

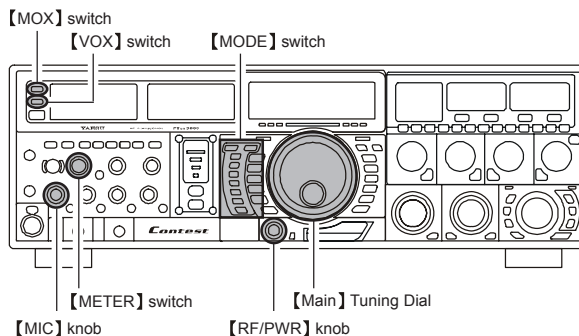
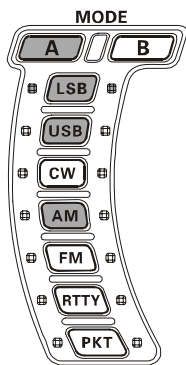

Please adjust the **[MIC]** gain control to set the ALC within this range.

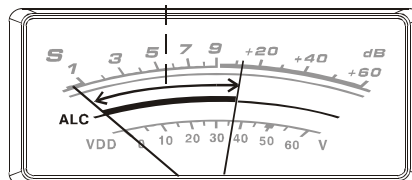

『Quick Point』

By convention, LSB is used in the 7 MHz and lower Amateur bands for SSB communication, and USB is used on the 14 MHz and higher bands (the 10 MHz band is used for CW and data modes only).

- Rotate the **[Main]** Tuning Dial knob to adjust the operating frequency. Alternatively, if using the optional MD-200A8X Desktop Microphone, you may use the Up/Down scanning buttons to sweep up or down the current band.

『Advice』

Be sure to verify that the microphone you are using is enabled for operation via the Menu. There are two microphone jacks (the front panel's three-pin XLR ("Cannon") connector, and the rear panel's 8-pin round connector), and either jack may be chosen independently for SSB, AM, and FM operation. See the Menu list below for details of the associated Menu Item:

- Press the microphone's PTT (Push To Talk) switch to begin transmission; speak into the microphone in a normal voice level.
 - The "TX" indicator will light up in the frequency display area, confirming that transmission is in progress.
 - When transmitting in the AM mode, rotate the **[RF PWR]** control (#38) so as to set a maximum (carrier) power output of 50 Watts.
 - Release the PTT switch at the end of your transmission. The transceiver will return to the receive mode.

- To adjust the microphone amplifier gain to match the microphone and your voice level, close the PTT switch, speak into the microphone in a normal voice level, and adjust the **[MIC]** (gain) control (#15) as follows:

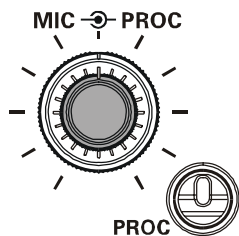

SSB Mode

Adjust the **[MIC]** control so that the ALC voltage (displayed on the right meter) stays within the ALC zone of the meter (up to 2/3 or full scale deflection) on voice peaks.

For AM, the **[MIC]** control should not be advanced to the point where the ALC meter deflects. In many cases, the same setting as used on SSB will be satisfactory.

『Advice』

- ALC meter deflection may be caused by excessive drive power, but also by reflected power detected in the antenna system. If the impedance presented to the transceiver is different from 50 Ohms, ALC meter action may be observed that is not related to the proper setting of the **[MIC]** gain control. Therefore, we recommend that you make **[MIC]** gain adjustments into a dummy load or antenna system presenting an impedance very close to 50 Ohms.
- Rotate the **[RF PWR]** control to set the desired power output. Clockwise rotation of the **[RF PWR]** control will increase the power. The adjustment range is between 5 Watts and 200 Watts, and you should always use the minimum power necessary for maintaining reliable communications.
- When performing tests (such as the setup of the **[MIC]** or **[RF PWR]** controls), be sure to check the frequency before transmitting, so as to avoid interference to others who may already be using the frequency.
- Four techniques for exercising Transmit/Receive control are provided on the FT DX 9000 Contest, and you may choose the technique(s) that best suit your operating needs:

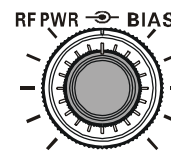

- Pressing the microphone's PTT switch will engage the transmitter.
- The rear panel PTT jack may be connected to a foot switch or other manual switching device in order to engage the transmitter.

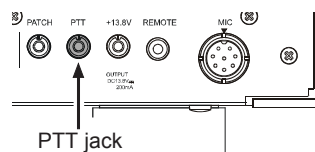

- Pressing the front panel **[MOX]** switch (#1) will lock the transmitter on. Press the **[MOX]** switch (a latching type) to return to receive.
- The VOX (Voice Operated Xmit) circuit will engage the transmitter automatically when you speak into the microphone. For details of VOX operation, see page 80.



SSB/AM MODE TRANSMISSION

PHANTOM VOLTAGE FOR CONDENSER MICROPHONES

For powering a studio-quality condenser microphone connected to the front panel's XLR ("Canon") connector, it is possible to enable a 48-volt DC line connected to that jack. Because the improper enabling of this voltage could cause damage to other microphone types, the simple process for enabling the voltage has been made somewhat complicated, so as to prevent the voltage from being enabled by accident.

1. Turn the front and rear panel power switches Off.
2. Unplug the AC cable from the rear panel **[AC IN]** jack.
3. Referring to Figure 1, remove the eight screws from the sides of the transceiver case.
4. Now remove the six screws shown in Figure 1 from the bottom case.
5. Referring to Figure 2, locate jack J28 on the AF Unit, and remove the jumper plug which is connected across pins 2 and 3 of J28.
6. Connect the just-removed jumper plug so that it now is connected across pins 1 and 2 of J28 (instead of the original position across pins 2 and 3).
7. Replace the six screws to affix the bottom case, and replace the eight screws from the sides of the transceiver (these screws were removed in steps 3 and 4 above).
8. Connect the AC cable to the rear panel's **[AC IN]** jack.
9. Turn the rear panel's power switch on, then turn the front panel power switch on.
10. If the above process has been successfully completed, you will observe that a small red LED just above and to the right of the XLR connector is now illuminated. If this LED is not glowing red, please check the status of the jumper plug once more.
11. If the red LED is glowing properly, the modification to enable the phantom 48 Volt line is now complete.

『Note』

- *When opening/closing the case, take care with your screwdriver not to short out internal components, or touch them in a way that will cause them to short out against other components.*
- *Avoid touching internal components with your hand, as static electricity can cause damage to certain components if appropriate anti-static bench techniques are employed.*
- *Only engage the phantom power when you have no alternative but to use a condenser microphone requiring such voltage. The wide availability of studio-grade Dynamic microphones (that do not require the phantom voltage) generally makes the use of the phantom voltage unnecessary over the life of the transceiver. Because damage can occur if the phantom voltage is enabled on a microphone not requiring it, we strongly recommend that the jumper plug at J28 (AF Unit) be left in its original position across pins 2 and 3.*
- *The phantom voltage capability of the FT dx 9000 Contest is disabled at the factory, and the lack of this voltage is not a "defect" or other condition covered by the Limited Warranty on this product. Accordingly, if you do not feel capable of enabling the phantom voltage and ask a service shop to do so on your behalf, a service fee may apply.*

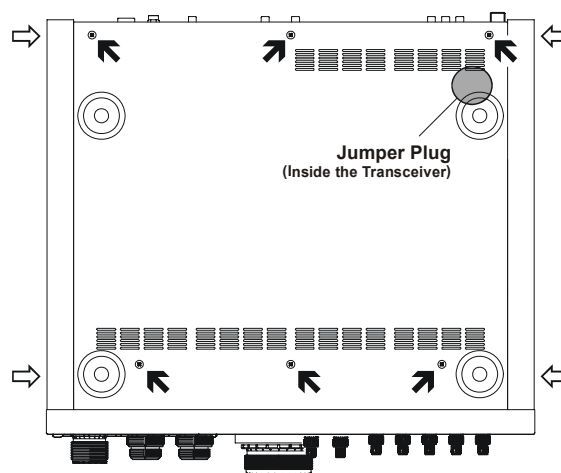

Figure 1

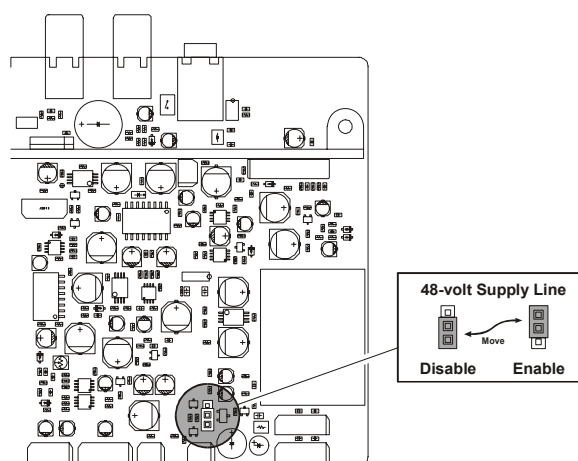

Figure 2

『Terminology』

Phantom Voltage

Phantom Voltage is a term describing the voltage (48 Volts at 10 mA max.) provided via the front panel's XLR ("Canon") microphone connector, for use with a studio-grade condenser microphone. Although disabled at the factory, enabling of the voltage only requires that the position of an internal jumper plug be moved.

USING THE AUTOMATIC ANTENNA TUNER

The Automatic Antenna Tuner (hereinafter referred to as the “ATU”) built into each FT DX 9000 Contest is crafted to ensure a 50-Ohm load for the final amplifier stage of the transmitter. We recommend that the ATU be used whenever you operate on the FT DX 9000 Contest.

『Advice』

- The ATU of the FT DX 9000 Contest, being located inside the station, only adjusts the impedance presented to the transceiver at the station end of your coaxial cable feedline. It does not “tune” the SWR at the antenna feedpoint itself. When designing and building your antenna system, we recommend that every effort be made to ensure a low SWR at the antenna feedpoint.
- The ATU of the FT DX 9000 Contest includes 100 memories for tuning data. Eleven of these memories are allocated, one per Amateur band, so that each band has at least one setting preset for use on that band. The remaining 89 memories are reserved for the 89 most-recent tuning points, for quick frequency change without the need to retune the ATU.
- The ATU in the FT DX 9000 Contest is designed to match impedances within the range of 16.5 Ohms to 150 Ohms, corresponding to an SWR of 3:1 or less. Accordingly, simple non-resonant whip antennas, along with random-length wires and the “G5RV” antenna (on most bands) may not be within the impedance matching range of the ATU.

ATU OPERATION

1. Rotate the **【RF PWR】** control (#38) fully clockwise (to the right).
2. Use the **【MAIN】** Tuning Dial knob (#34) to set the radio to desired operating frequency within the Amateur band.
3. Press the **【TUNE】** switch (#10) momentarily to place the ATU in the transmit line (no adjustment/tuning will occur yet). An LED inside the **【TUNE】** switch will glow red continuously.

Quick Point

The momentary press of the **【TUNE】** switch will turn the tuner on, and the microprocessor will automatically select the tuning point closest to the current operating frequency.

4. Press and hold in the **【TUNE】** switch for two seconds to begin automatic tuning. The transmitter will be engaged, and the red LED imbedded in the **【TUNE】** switch will blink while tuning is in progress. When the optimum tuning point has been reached, the radio will return to receive, and the red LED will again glow steadily (instead of blinking).
5. While tuning around the band using the Main tuning dial, you will observe that the **【TUNE】** LED blinks momentarily every 10 kHz. This momentary blinking indicates that a new tuning window has been entered. If you want to save tuning data associated with this 10 kHz window, repeat step 4 (above) for each such window. On bands like 1.8 MHz where the impedance may change rapidly, the storage of a number of tuning points is recommended.
6. To disconnect the ATU from the transmit line, press the **【TUNE】** switch momentarily. The red LED imbedded in the **【TUNE】** switch will go out, confirming that the ATU has been turned off. In the “Off” mode, the transceiver will be directly connected to the coaxial cable connected to your antenna, and will operate based on whatever impedance is present at the station end of the coax.

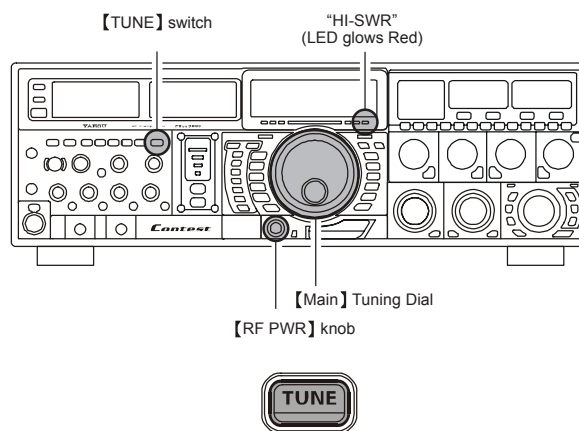

『Advice』

The ATU is connected both to the transmitter and the receiver, and its natural RF selectivity has a beneficial effect in rejecting out-of-band energy during reception. Accordingly, we recommend that the ATU be left “On” at all times.

『Quick Point』

- As shipped from the factory, only one ATU alignment point is saved on each Amateur band. This was memorized during the final alignment and performance verification stages on the production line.
- The momentary flickering of the **【TUNE】** switch’s LED occurs whenever you cross over into a new 10 kHz ATU memory window.

『Note』

Although transmitter power is decreased to 100 Watts (maximum) during tuning, by all means please check the operating frequency before beginning the tuning process, to be sure you are not interfering with others who may already be using the frequency.

『Terminology』

Antenna Tuner Memories

The microprocessor of the ATU makes a note of the positions of the tuning capacitors and the selected inductors, and stores the data for each 10 kHz window in which tuning has occurred. This eliminates the need to re-tune every time you return to a frequency on which you already have completed the tuning process.

USING THE AUTOMATIC ANTENNA TUNER

ABOUT ATU OPERATION

Figure 1 depicts a situation where normal tuning via the ATU has been successfully completed, and the tuning data has been stored in the ATU memory. The antenna system as seen by the transmitter is shown.

In Figure 2, the operator has changed frequency, and the HI SWR LED has become illuminated. The operator presses and holds in the **[TUNE]** switch for two seconds to begin impedance matching using the ATU.

If a high SWR condition exists (above 3:1), corrective action must be taken in the antenna system to bring the impedance closer to 50 Ohms. Besides the fact that the ATU will refuse to memorize settings on frequencies where the SWR exceeds 3:1, the high SWR may indicate a mechanical failure in the feed system, and such failures can lead to the generation of spurious signals causing TVI, etc.

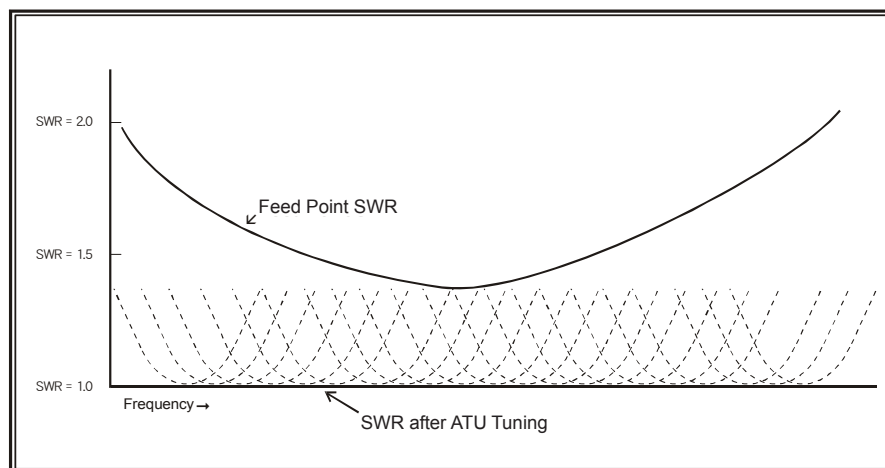

Figure 1

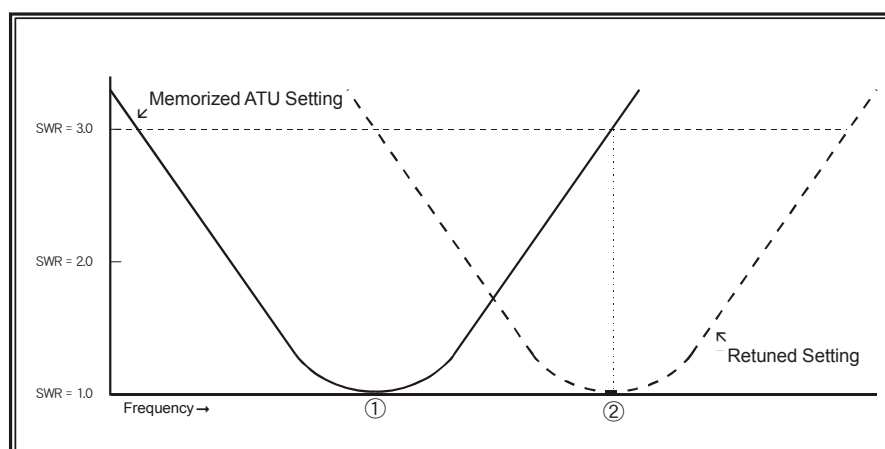

Figure 2

About ATU Memories

SWR (Post-tuning) Less than 1.5:1

The tuning settings are committed to the ATU memory.

SWR (Post-tuning) Greater than 1.5:1

Tuning data will not be retained in memory. If you return to the same frequency, the tuning process must be repeated.

SWR (Post-tuning) Greater than 3:1

The HI SWR LED will light up, and tuning settings, if achieved, will not be memorized. Please investigate and resolve the high SWR condition before attempting further operation using this antenna. The high SWR may indicate a mechanical failure in the feed system, and such failures can lead to the generation of spurious signals causing TVI, etc.

USING THE AUTOMATIC ANTENNA TUNER

LITHIUM BATTERY REPLACEMENT

The memories for the ATU are backed up by a common Lithium backup battery (type CR2032 or equivalent). After two or more years of heavy use, you may notice that the tuner memories are not being maintained, and that you have to re-tune when returning to a frequency on which you had previously stored tuning data.

In this case, please replace the ATU Backup Battery using the following procedure:

1. Turn the transceiver's main power switch Off.
2. Unplug the AC cable from the rear panel's (~AC IN) jack.
3. Referring to Figure 1, remove the eight screws (⇔) from the side of the transceiver, along with the six screws (←) affixing the bottom case; remove the bottom case.
4. Now remove the three screws (⇒) affixing the top case (Figure 2), and remove the top case.
5. Referring to Figure 3, remove the screws (←) at the top left and top right that hold the front panel assembly in place, and loosen the two screws (⇔) at the bottom left and bottom right, so they can hold the front panel as it is folded forward.
6. Refer to Figure 4, and slide the front panel diagonally upward and outward, then fold the front panel forward to expose the Control Unit behind it.
7. Locate the Lithium battery on the left side of the Control Unit (Figure 5).
8. Follow the guidelines in Figure 6, and remove the old battery, replacing it with a new one of the identical type.
9. Restore the front panel to its original position, and replace the two screws (one from each side, near the top) and tighten the two lower screws that were loosened in step 5. Replace the top and bottom covers, re-installing all the screws removed in steps 3 and 4. Replace the eight screws removed from the sides of the transceiver.
10. ATU Backup Battery replacement is now complete.

『Quick Point』

When the ATU Backup Battery is replaced, all tuner memories will be erased, and new sets of tuning data will have to be stored.

『Note』

- Use care in the handling and storage of the Lithium battery. It is small, and presents a choking hazard to small children; therefore keep such batteries out of the reach of children at all times. Do not dispose of Lithium batteries in fire, and do not attempt to re-charge them under any circumstances.
- When opening/closing the case, take care with your screwdriver not to short out internal components, or touch them in a way that will cause them to short out against other components.
- The exhaustion of the ATU backup battery of the FT DX 9000 Contest is a normal "wear and tear" situation, and the loss of the backup voltage is not a "defect" or other condition covered by the Limited Warranty on this product. Accordingly, if you do not feel capable of replacing the battery, and ask a service shop to do so on your behalf, a service fee may apply.

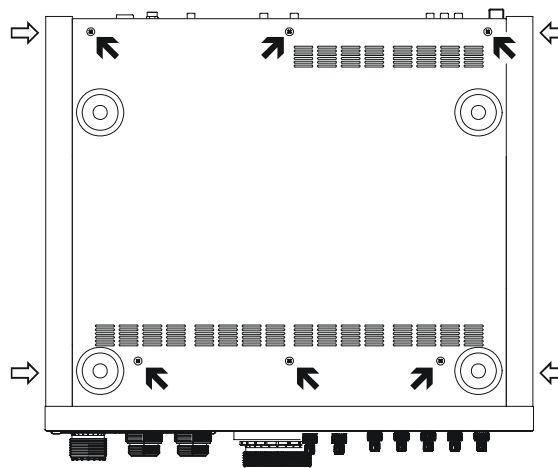

Figure 1

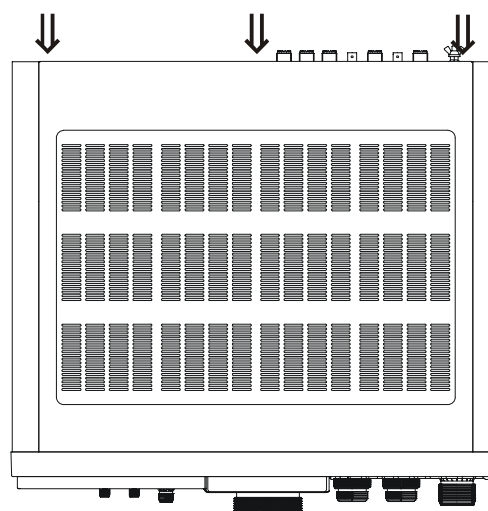

Figure 2

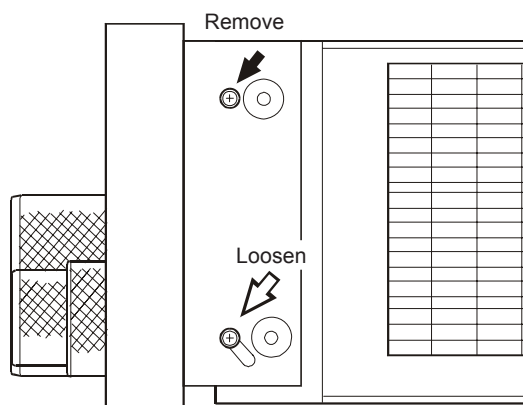

Figure 3

USING THE AUTOMATIC ANTENNA TUNER

LITHIUM BATTERY REPLACEMENT

Slide the front panel diagonally upward and outward.

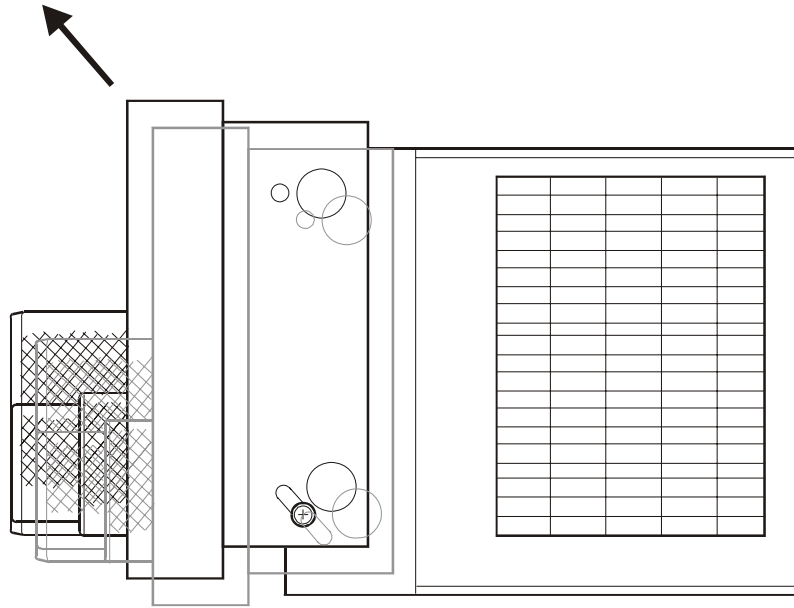

Figure 4

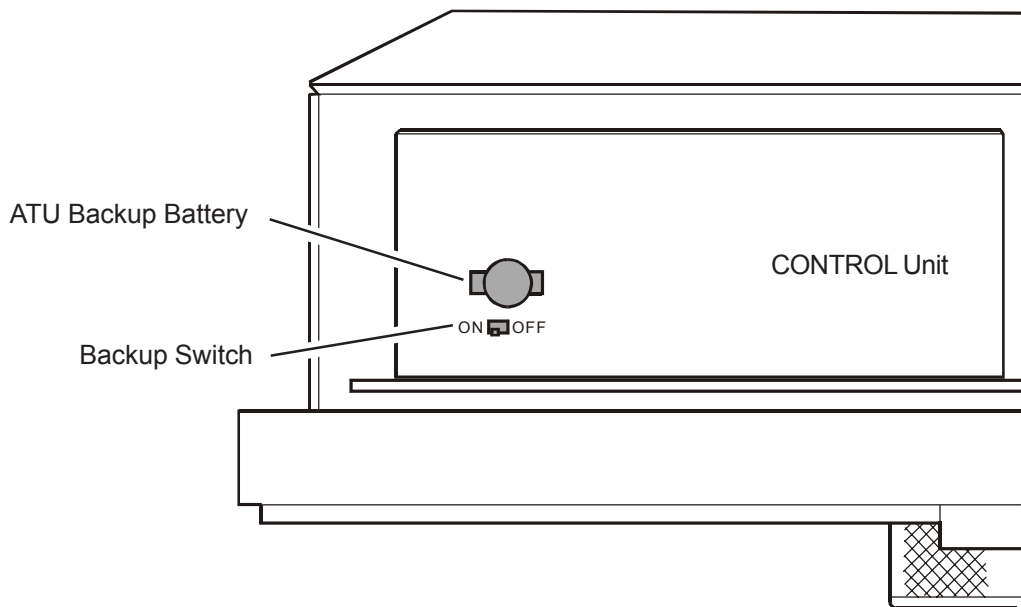
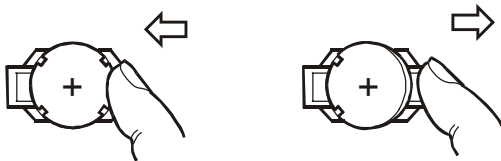

Figure 5

Removal of the Lithium Backup Battery
After pushing in the direction of the arrow,
move your finger upward.



Inserting the Lithium Backup Battery
Use your fingertip to push in the
indicated direction.

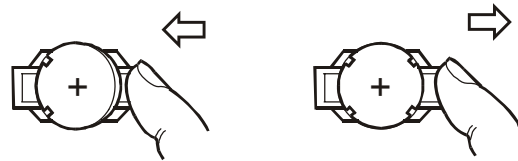

Figure 6

SSB/AM MODE TRANSMISSION (ENHANCING TRANSMIT SIGNAL QUALITY)

USING THE SPEECH PROCESSOR - SSB, AM MODE -

The Speech Processor is designed to increase “talk power” by increasing the average power output via a sophisticated compression technique. The result is improved intelligibility when conditions are difficult.

1. Adjust the **[MIC]** gain control (#15) for SSB use, as described on page 66.
2. Rotate the **[METER]** switch (#11) fully to the left, so as to select “COM” (Compression).
3. Press the **[PROC]** switch (#16) momentarily. The Red LED imbedded in the switch will light up, confirming that the Speech Processor is engaged.
4. Press the **[PTT]** switch on the microphone, and speak into the microphone in a normal voice level. Observe the deflection of the meter needle on the COMP meter scale.
5. Rotate the **[PROC]** control (#15) so that the meter needle deflects to not more than “10 dB” on the COMP scale.

To switch the Speech Processor off, press the **[PROC]** switch once more. The Red LED imbedded in the switch will go out, confirming that the Speech processor is turned off.

『Advice』

Excessive advancement of the COMP control will result in a degradation of the transmitted signal’s signal-to-noise ratio, thereby reducing intelligibility at the other end of the circuit.

- When the optional Data Management Unit (DMU-9000) and TFT Display Unit (TFT-9000) are installed, you may use the Audio Scope/Oscilloscope page on the TFT to help you adjust the setting of the Compression Level of the Speech Processor for the optimum performance using your voice and microphone.
- The Transmit Monitor is another helpful way of verifying proper adjustment of the Compression level. By Pressing the **[MONI]** key (#12) and adjusting the **[MONI]** control (#14) for a comfortable listening level while you are transmitting, you will be able to hear the difference in sound quality as you make adjustments.
- The **[RF PWR]** control (#38) still controls the RF power output, whether or not the Speech Processor is engaged.

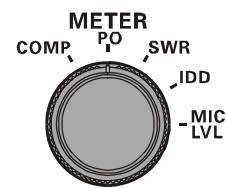
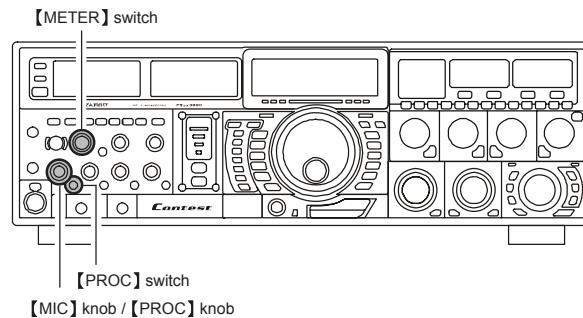

[METER] switch

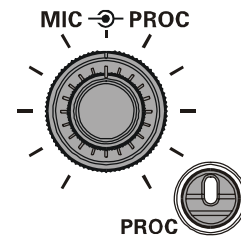

[MIC] knob / [PROC] knob

[PROC] switch

SSB/AM MODE TRANSMISSION (ENHANCING TRANSMIT SIGNAL QUALITY)

ADJUSTING THE SSB TRANSMITTED BANDWIDTH

For transmission on SSB, a default bandwidth of 2.4 kHz is provided. This bandwidth provides reasonable fidelity along with good talk power, and is typical of the bandwidth used for decades during SSB transmission. However, the bandwidth may be varied by the operator, so as to provide different levels of fidelity or talk power, according to your preferences. Here's how to adjust the transmitted bandwidth on SSB:

1. Press the **[MNU]** key (#72) to engage the Menu.
2. Rotate the **[Main]** Tuning Dial knob (#34) so as to select Menu Item “**MODE SSB 070 SSB-TX-BPF.**”
3. Rotate the **[CLAR/VFO-B]** knob (#84) to select the desired bandwidth. The available selections are
3000WB/50-3000/100-2900/200-2800/
300-2700/400-2600,
and the default is 300-2700 Hz.
4. Press and hold in the **[MNU]** key for two seconds to save the new setting and exit to normal operation.

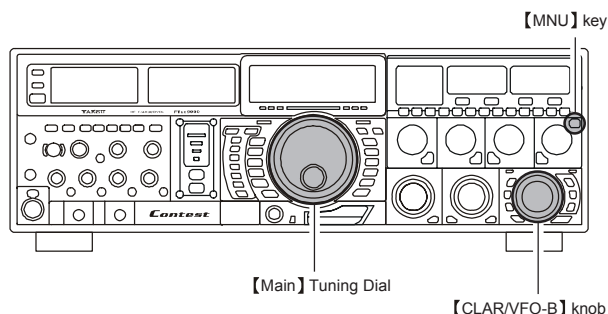

『Advice』

- When the optional Data Management Unit (DMU-9000) and TFT Display Unit (TFT-9000) are installed, you may use the Audio Scope function of the Audio Scope/Oscilloscope page on the TFT to help you view any changes to the passband.
- The Transmit Monitor is another helpful way of verifying the effects on fidelity of changing the bandwidth. By adjusting the **[MONI]** control (#14) for a comfortable listening level while you are transmitting, you will be able to hear the difference in sound quality as you make changes.

『Quick Point』

- The higher fidelity associated with wide bandwidth will be particularly enjoyable on the low bands, during local rag-chew QSOs.
- The “3000WB” setting is a special hi-fidelity setting, whereby the transmitted bandwidth is in excess of 3 kHz. This selection, in conjunction with judicious adjustment of the Parametric Microphone Equalizer (see next chapter) can provide truly outstanding fidelity and very natural-sounding audio.
- When using the wider bandwidth selections (especially “3000WB”), the apparent power output from the transmitter may seem lower. This is because the available power from the transmitter is being distributed over a wider bandwidth, and the power detection circuitry does not compensate for the effect of the bandwidth selection (it is calibrated in the default 2.4 kHz bandwidth).

SSB/AM MODE TRANSMISSION (ENHANCING TRANSMIT SIGNAL QUALITY)

SIGNAL QUALITY ENHANCEMENT USING THE PARAMETRIC MICROPHONE EQUALIZER

The FT DX 9000 Contest includes a unique Three-Band Parametric Microphone Equalizer, that provides precise, independent control over the low-, mid-, and treble-ranges in your voice wave-form.

『Quick Point』

- The Parametric Equalizer is a unique technique for adjusting the signal quality. Because the three ranges may be adjusted so precisely, it is possible to craft a response that provides a more natural and pleasant sound than you have ever experienced before.
- The Parametric Equalizer adjustments are applied independently to the front XLR (“Cannon”) and rear (8-pin) microphone jacks, so you can connect different microphones and customize the audio response that best suits each microphone.

The aspects of configuration that you may adjust on the Parametric Equalizer are:

Center Frequency: The center frequency of each of the three bands may be adjusted.

Gain: The amount of enhancement (or suppression) within each band may be adjusted.

Q: The bandwidth over which the equalization is performed may be adjusted.

1. Connect the microphone to the front or rear microphone jack.
2. Set the **【RF PWR】** control (#38) to its minimum value, so as not to cause interference to other users during adjustment.

『Advice』

- Because the setup of the Parametric Equalizer for both front and rear microphone jacks may take some time, we recommend you consider connecting a dummy load to one of the Antenna jacks, and monitor your signal on a separate receiver, so as to prevent interference to other users.
 - You will have the best chance of hearing the effects of adjustments if you wear headphones while monitoring your transmitted signal.
3. Press the **【MONI】** switch (#12).
 4. Press the **【MNU】** key (#72) momentarily. The Menu list will appear on the LCD.
 5. Rotate the **【Main】** Tuning Dial knob (#34) to Menu Items 136 through 153; these pertain to the adjustment of the Parametric Microphone Equalizer.
 6. Rotate the **【CLAR/VFO-B】** knob (#84) to perform adjustments to a particular Menu item.
 7. Close the PTT switch, and speak into the microphone while listening to the effects of the changes you are making (in step 6). Because the overall effect on the sound will change with each adjustment you make, you should make several passes through each adjustment area, to be sure that you are achieving the optimum setting.
 8. When you have completed all adjustments, press and hold in the **【MNU】** key for two seconds to save the new settings and exit to normal operation. If you only press the **【MNU】** key momentarily to exit, any changes you performed will not be stored.

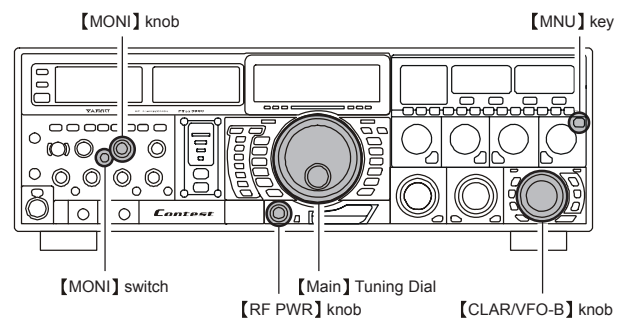

SSB/AM MODE TRANSMISSION (ENHANCING TRANSMIT SIGNAL QUALITY)

SIGNAL QUALITY ENHANCEMENT USING THE PARAMETRIC MICROPHONE EQUALIZER

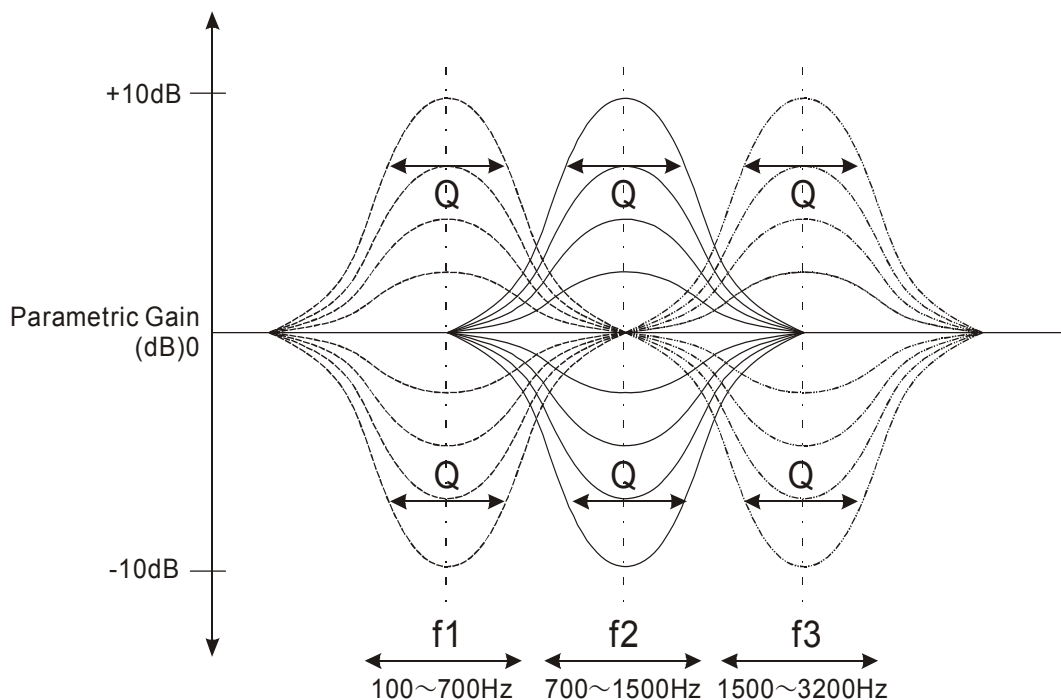

3-Stage Parametric Equalizer Adjustments: Front Panel Microphone Jack

Center Frequency	TX AUDIO 136 F-PRMTRC EQ1-FREQ	“100” (Hz) ~ “700” (Hz)
	TX AUDIO 139 F-PRMTRC EQ2-FREQ	“700” (Hz) ~ “1500” (Hz)
	TX AUDIO 142 F-PRMTRC EQ3-FREQ	“1500” (Hz) ~ “3200” (Hz)
Parametric Gain	TX AUDIO 137 F-PRMTRC EQ1-LEVEL	(Low) “-10” (-10dB) ~ “+10” (+10dB)
	TX AUDIO 140 F-PRMTRC EQ2-LEVEL	(Mid) “-10” (-10dB) ~ “+10” (+10dB)
	TX AUDIO 143 F-PRMTRC EQ3-LEVEL	(High) “-10” (-10dB) ~ “+10” (+10dB)
Q (Bandwidth)	TX AUDIO 138 F-PRMTRC EQ1-BWTH	(Low) “1” ~ “10”
	TX AUDIO 141 F-PRMTRC EQ2-BWTH	(Mid) “1” ~ “10”
	TX AUDIO 144 F-PRMTRC EQ3-BWTH	(High) “1” ~ “10”

3-Stage Parametric Equalizer Adjustments: Rear Panel Microphone Jack

Center Frequency	TX AUDIO 145 R-PRMTRC EQ1-FREQ	“100” (Hz) ~ “700” (Hz)
	TX AUDIO 148 R-PRMTRC EQ2-FREQ	“700” (Hz) ~ “1500” (Hz)
	TX AUDIO 151 R-PRMTRC EQ3-FREQ	“1500” (Hz) ~ “3200” (Hz)
Parametric Gain	TX AUDIO 146 R-PRMTRC EQ1-LEVEL	(Low) “-10” (-10dB) ~ “+10” (+10dB)
	TX AUDIO 149 R-PRMTRC EQ2-LEVEL	(Mid) “-10” (-10dB) ~ “+10” (+10dB)
	TX AUDIO 152 R-PRMTRC EQ3-LEVEL	(High) “-10” (-10dB) ~ “+10” (+10dB)
Q (Bandwidth)	TX AUDIO 147 R-PRMTRC EQ1-BWTH	(Low) “1” ~ “10”
	TX AUDIO 150 R-PRMTRC EQ2-BWTH	(Mid) “1” ~ “10”
	TX AUDIO 153 R-PRMTRC EQ3-BWTH	(High) “1” ~ “10”

SSB/AM MODE TRANSMISSION (LOW-DISTORTION CLASS-A OPERATION)

LOW-DISTORTION CLASS-A OPERATION

Class-A operation of the FT dx 9000 Contest transmitter is provided, yielding ultra-low distortion products during SSB operation. Power output during Class-A operation is 75 Watts.

To engage Class-A operation, press the **[CLASS-A]** switch (#39). The imbedded Red LED will light up, confirming that Class-A operation has been selected.

Engaging the “Class-A” mode actually places the transceiver in a condition whereby the Bias level may be adjusted, using the **[BIAS]** control (#38), to set the transceiver for operation anywhere between Class A and Class AB (which has lower heat dissipation but higher distortion products). Clockwise rotation of the **[BIAS]** control increases the Bias, and fully clockwise rotation of the **[BIAS]** control will place the transmitter in fully Class-A operation. Counter-clockwise rotation of the **[BIAS]** control will move the transmitter toward Class AB operation.

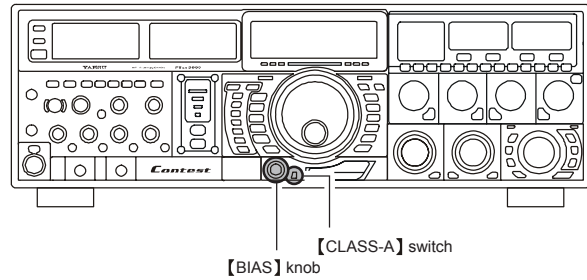
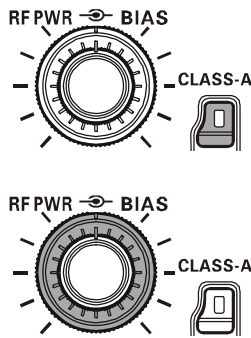

To exit from the CLASS-A mode, press the **[CLASS-A]** switch once more. The Red LED imbedded in the switch will go out, confirming that the CLASS-A mode has been disengaged.

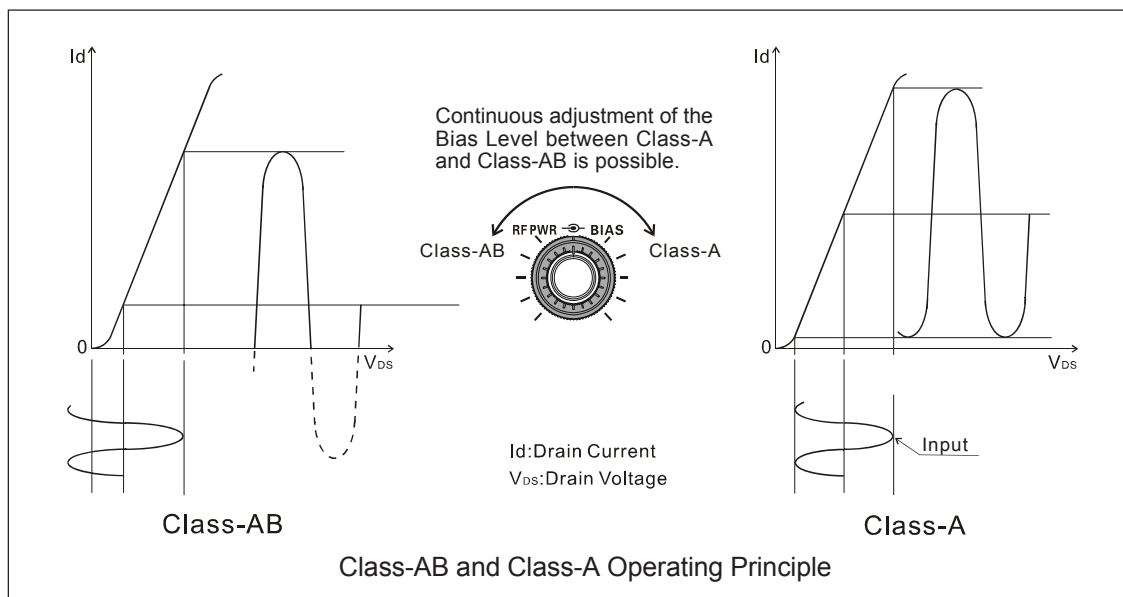

Advice

- During Class-A operation, ten Amps of Bias current will be flowing, regardless of the modulation level that leads to actual power output. Therefore, if the ambient temperature in your operation location is high, the transceiver temperature may rise as well, due to the high bias level (which must be dissipated as heat). Depending on the temperature, you may wish to reduce the setting of the **[BIAS]** control, so as to reduce the amount of heat being generated.
- During Class A operation, we recommend that you monitor the heat sink temperature by pressing the **[TEMP]** switch (#61) so as to engage the temperature monitoring mode of the **[TEMP/SWR]** meter (#60). Usually, the temperature will be well below the 80 °C “Red Zone,” because the fan speed will increase to control a rise in temperature. If you are operating in a hot environment, though, and the increasing fan speed does not maintain the temperature below 80 °C, try adjusting the Bias Level temporarily in the direction of Class AB operation; this will reduce the amount of heat being dissipated in the heat sink.
- The Bias Level is displayed on the **[VDD/BIAS]** meter (#67) when the **[BIAS]** switch (#69) is pushed. On the “Bias” scale, “0%” represents Class AB operation, while “100%” represents Class A operation.
- An innovative aspect of the “Class-A” mode is that the actual power output is always limited to 75 Watts. So even though you might adjust the **[BIAS]** control in the direction of Class-AB operation, the power output will not rise; this eliminates the need, for example, to re-tune your linear amplifier, if used.

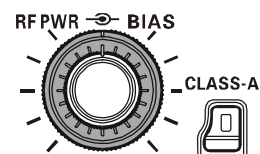

Quick Point

SSB/AM MODE TRANSMISSION (LOW-DISTORTION CLASS-A OPERATION)

LOW-DISTORTION CLASS-A OPERATION

- Class-A operation provides a significant improvement in transmitter distortion suppression. During Class-A, the 3rd-order IMD products are typically suppressed 50 dB, while the 5th- and higher-order IMD products (that can cause “splatter” that interferes with others) will typically be suppressed 70 dB or more.
- If you are using a linear amplifier such as the VL-1000, the low distortion produced by the FT DX 9000 Contest’s transmitter means that these intermodulation distortion products will not exist to be amplified by your linear.
- **High-Power 200-Watt Final Amplifier Stage**

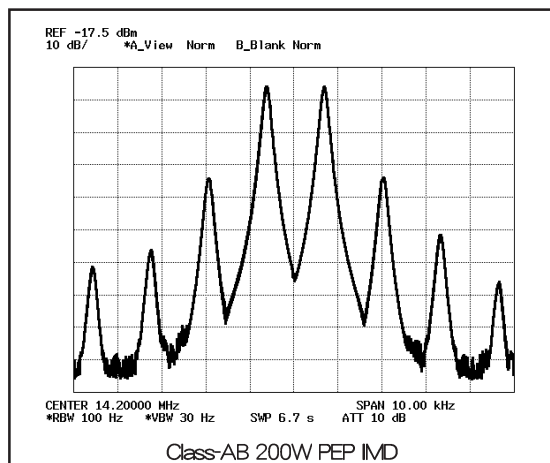
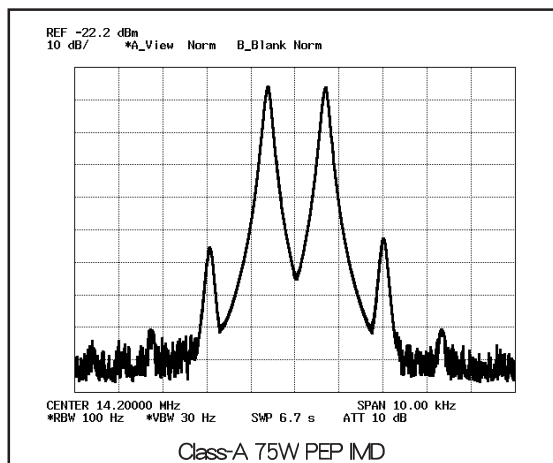

The final amplifier stage of the FT DX 9000 Contest utilizes a pair of ST Micro Electronics Corp. SD2931 MOSFET devices operating at 50 Volts. This push-pull configuration provides low distortion along with high power output. The 120 mm thermostatically-controlled cooling fan directs forced air across the heat sink, should the heat sink temperature exceed the temperature that will trigger the thermostat.

SSB/AM MODE TRANSMISSION

VOICE MEMORY

You may utilize the Voice Memory capability of the FT DX 9000 Contest by plugging in the supplied FH-2 Remote Control Keypad into the rear panel's **【REMOTE】** jack.

The Voice Memory system includes five memories capable of storing up to 20 seconds of voice audio each. The maximum that any memory can hold is 20 seconds. Please see the diagram depicting connection of the FH-2 Remote Control Keypad on page 15.

Recording Your Own Voice in Memory

1. Select the LSB, USB, AM, or FM mode using the front panel Mode selector switches.
2. Press the **【MEM】** key on the FH-2.

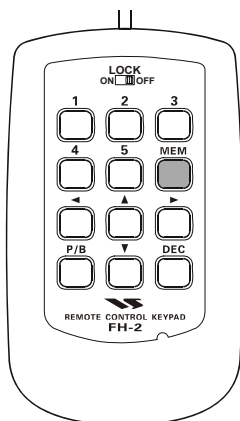

Checking Your Recording

1. Be sure that the front panel **【MOX】** switch is Off (not pushed in).
2. Press the **【1】** ~ **【5】** key (whichever one you just recorded in), and you will hear the contents of the voice memory you just recorded.

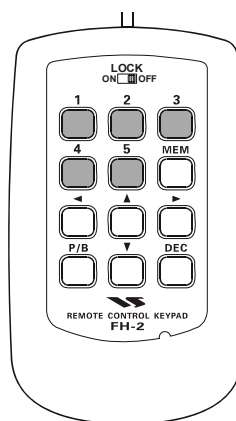

3. Press any of the keys numbered **【1】** through **【5】** to select that memory storage register. If you do not press the PTT key (see next step) within five seconds, the memory storage process will be cancelled.

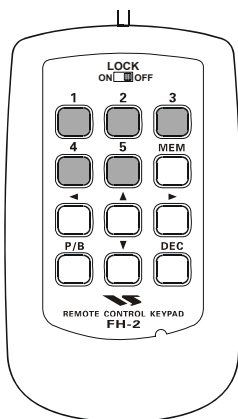

『Advice』

You may rotate the **【AF GAIN】** control (#23) to adjust the playback level of the recording.

Transmitting the Recorded Message

1. Select the LSB, USB, AM, or FM mode using the front panel **【MODE】** selector switches (#27).
2. Press the front panel's **【BK-IN/SPOT】** switch (#20).
3. Press the FH-2 **【1】** ~ **【5】** key, depending on which memory register's message you wish to transmit. If you hit the key again during playback, the message will be terminated.

4. Press the microphone's PTT switch, and speak into the microphone in a normal voice level to record the message (such as "CQ DX, CQ DX, this is W 6 Delta X-Ray Charlie, W 6 Delta X-Ray Charlie, Over"). Remember that the time limit for recording any message is 20 seconds.
5. Press the FH-2 **【MEM】** key to terminate the message storage process.

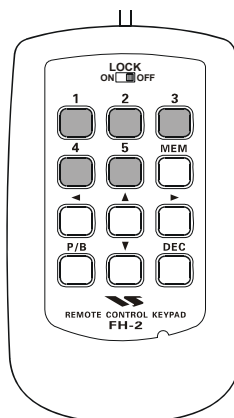

CONVENIENT TRANSMITTER ACCESSORIES

VOX: AUTOMATIC TX/RX SWITCHING USING VOICE CONTROL SSB/AM/FM MODES

Instead of using the microphone's PTT switch or the front panel **【MOX】** switch to activate the transmitter, the VOX (Voice Operated TX/RX Control) system provides hands-free, automatic activation of the transmitter, based on voice input into the microphone. Setup of the VOX system takes only a few seconds.

1. To start, set the **【DELAY】** and **【VOX】** controls (#17) fully counter-clockwise (to the left).
2. Press the **【VOX】** switch (#2) to engage VOX operation.
3. Speak into the microphone in a normal voice level, and rotate the **【VOX】** knob clockwise (to the right) until the point where your voice input activates the transmitter.
 - Do not advance the setting of the **【VOX】** control too much, because to do so will make the transmitter respond to minor background noises in your station.
4. Now stop speaking, and note the amount of time it takes for the receiver to recover. If the hang time is too long or too short; rotate the **【DELAY】** knob, while speaking briefly into the microphone and then pausing, so as to set the desired hang time. Clockwise rotation of the **【DELAY】** control will increase the hang time.
5. To exit from VOX operation, press the **【VOX】** switch once more. We recommend doing this if you are going to leave your station, to prevent inadvertent activation of the VOX system by a ringing nearby telephone, speaker audio from a TV, etc.

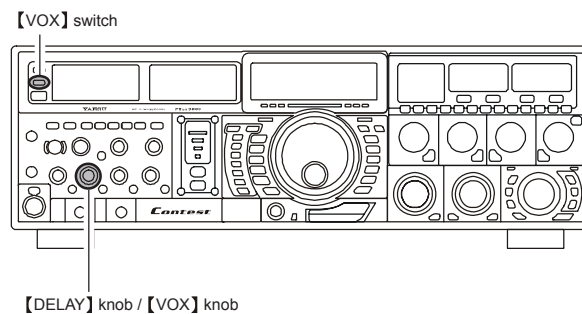

『Advice』

VOX operation may be engaged on either Voice modes (SSB/AM/FM) and on AFSK-based Data modes. Use Menu item **“TX GNRL 159 VOX SELECT”** (the selections are **“MIC”** and **“DATA”**).

USING THE MONITOR

You may listen to the quality of your transmitted signal using the Monitor feature.

1. Press the **【MONI】** switch (#12). The imbedded Red LED will light up, indicating that the Monitor is turned on.
2. During transmission, rotate the **【MONI】** knob (#14) to adjust the audio level from the Monitor. Clockwise rotation of this knob will increase the volume level.
3. To switch the Monitor off again, press the **【MONI】** switch once more. The Red LED will go out, confirming that the Monitor is now disengaged.

『Advice』

- If you are using the speaker for monitoring, instead of headphones, excessive advancement of the **【MONI】** control can cause feedback to occur. Additionally, this feedback can cause the VOX system to hang up in a loop, making it impossible to return to receive. Therefore, we recommend the use of headphones, if at all possible, or the minimum usable setting of the **【MONI】** control, if the speaker must be used.
- Because the Monitor feature utilizes a sampling of the transmitter's IF signal, it can be very useful for checking the adjustment of the Speech Processor or Parametric Equalizer on SSB, and for checking the general signal quality on AM and FM.

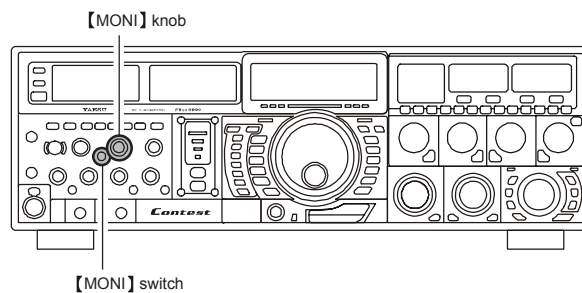

CONVENIENT TRANSMITTER ACCESSORIES

SPLIT OPERATION USING THE TX CLARIFIER (VFO-A OPERATION)

For split TX/RX operation in “casual” pile-ups, where the split is less than 10 kHz, the TX Clarifier (Offset Tuning) feature may be utilized.

1. Press the **【CLAR】** switch (#80). The Red LED imbedded in the switch will light up, and “CLAR” will appear in the display. The **【CLAR/VFO-B】** knob (#84) will now be enabled for offset tuning of the transmitter.

『Advice』

- Please verify that the lamp to the right of the **【CLAR/VFO-B】** knob is not lit up in Orange. If so, this indicates that this knob is currently engaged for VFO-B tuning. If the Orange lamp is lit, press the **【A/B】** switch (#88), then press the **【CLAR】** switch, to engage Clarifier operation.

『Quick Point』

- The Clarifier is frequently used for receiver offset tuning. However, for DX pile-ups where the DX station is using a split of less than 10 kHz, the TX Clarifier function is usually the quickest way to set the transmitter to the desired offset frequency.
2. Press the **【TX】** switch (#86), located above and to the right of the **【CLAR/VFO-B】** knob. The “TX” notation will appear on the frequency display to the left of the main frequency.
 3. Rotate the **【CLAR/VFO-B】** knob to set the desired transmitter offset. A maximum split of ± 9.999 kHz may be set.

To disengage the transmit Clarifier temporarily, press the **【TX】** switch once more. The “TX” indication will disappear from the frequency display area.

To exit from Clarifier operation, press the **【CLAR】** switch once more. The “CLAR” indication will disappear from the display.

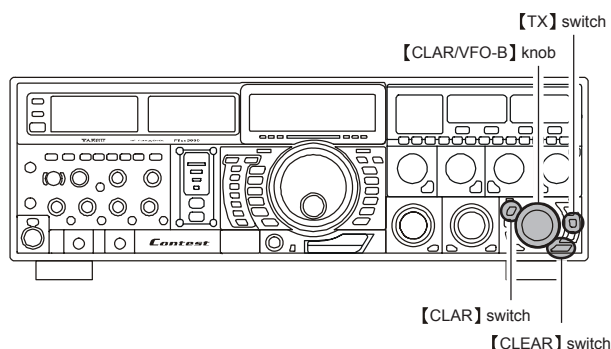

『Advice』

- To listen to the pile-up calling the DX station, so as to find the station currently being worked, you may press the **【RX】** switch (#78) (above and to the left of the **【CLAR/VFO-B】** knob). Once you have zeroed in on the station calling the DX (use the SPOT function on CW for precise alignment of your frequency), you may then press the **【RX】** switch again to cancel the RX Clarifier, and return to reception on the DX station's frequency.
- Just as with receiver Clarifier operation, the amount of offset from the original VFO frequency will appear in the small display window.
- As with receiver Clarifier operation, when you turn the TX Clarifier off the last-used offset is not lost, and will be available if you turn the TX Clarifier back on. To clear the Clarifier offset, press the **【CLAR】** switch.

Clarifier Offset Bar Indicator

A visual depiction of the relative offset of the Clarifier may be displayed, using the Bar Indicator.

1. Press the **【MNU】** key (#72); the Menu list will appear on the LCD.
2. Rotate the **【Main】** Tuning Dial knob (#34) to select Menu item “**DISPLAY 016 BAR DISPLAY SELECT.**”
3. Rotate the **【CLAR/VFO-B】** control (#84) to select “CLAR” from the available choices; the factory default is “CW-TUNE.”
4. Press and hold in the **【MNU】** key for two seconds to save the new setting and exit to normal operation.

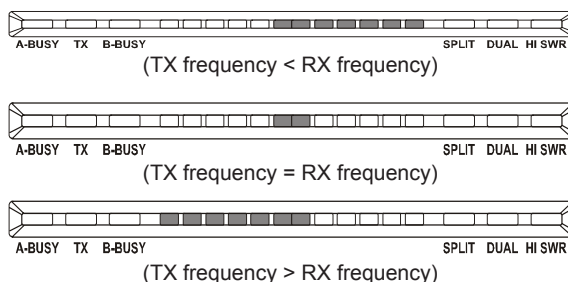

CONVENIENT TRANSMITTER ACCESSORIES

SPLIT-FREQUENCY OPERATION

A powerful capability of the FT DX 9000 Contest is its flexibility in Split Frequency operation, using the VFO-A and VFO-B frequency registers. This makes the FT DX 9000 Contest especially useful for high-level DX-pedition use, as the Split operation capability is very advanced and easy to use.

1. Set the VFO-A frequency as desired.
2. Set the VFO-B frequency.
3. Now press the **[SPLIT]** switch (#30). The “Split” mode will be engaged, and the front panel switch/LEDs will look like this:

VFO-A

[RX] switch (#32) “ON” (LED glows Green)

[TX] switch (#33) “OFF” (LED Off)

VFO-B

[RX] switch (#78) “OFF” (LED Off)

[TX] switch (#79) “ON” (LED glows Red)

During Split operation, the VFO-A register will be used for reception, while the VFO-B register will be used for transmission. If you press the **[SPLIT]** switch once more, Split operation will be cancelled.

You may also press the **[TX]** switch located above and to the right of the **[Main]** Tuning Dial knob (#34) to return transmit frequency control to the VFO-A side, and thereby cancel Split operation.

『Advice』

- During normal (non-split) VFO-A operation, you may simply press the VFO-B **[TX]** switch (located above and to the right of the **[CLAR/VFO-B]** knob: #84) to engage Split operation. The **[TX]** indicator will glow Red when you press the switch.
- During Split operation, pressing the **[A↔B]** switch (#42) will reverse the contents of the VFO-A and VFO-B. Press the **[A↔B]** switch once more to return to the original frequency alignment.
- During Split operation, you may also press the **[TXW]** (#31) switch (below and to the left of the Main Tuning Dial) to listen to the TX frequency temporarily.
- It is possible to set different operating modes (for example, LSB and USB) on the two VFOs used during Split operation.
- During Split operation, it also is possible to set the VFO-A and VFO-B to different Amateur bands, and it also is possible to engage Crossband operation for multiplier hunting while calling CQ on the “TX” band.

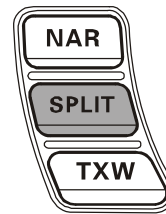
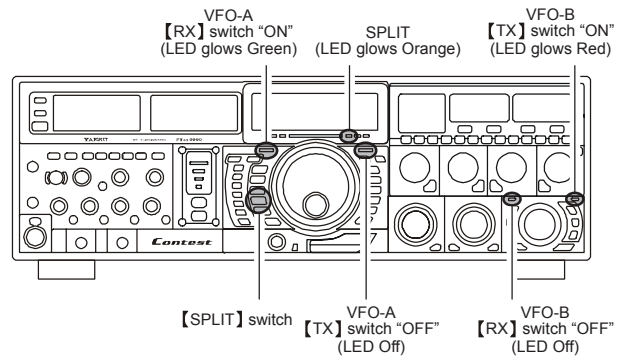

CONVENIENT TRANSMITTER ACCESSORIES

SPLIT-FREQUENCY OPERATION

Quick Split Operation

The Quick Split feature allows you to set a one-touch offset of +5 kHz to be applied to your radio's transmit frequency on the VFO-B, compared to the VFO-A frequency.

1. Start with regular transceiver operation on the VFO-A.

VFO-A

【RX】 switch (#32) "ON" (LED glows Green)

【TX】 switch (#33) "ON" (LED glows Red)

VFO-B

【RX】 switch (#78) "OFF" (LED Off)

【TX】 switch (#79) "OFF" (LED Off)

2. Press and hold in the 【SPLIT】 switch (#30) for two seconds to engage the Quick Split feature, and apply a frequency 5 kHz above the VFO-A frequency to the VFO-B frequency register.

Press and hold in the 【SPLIT】 switch for two seconds to increment the VFO-A frequency to +5 kHz.

The VFO configuration will then be:

VFO-A

【RX】 switch "ON" (LED glows Green)

【TX】 switch "OFF" (LED Off)

VFO-B

【RX】 switch "OFF" (LED Off)

【TX】 switch "ON" (LED glows Red)

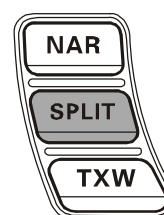
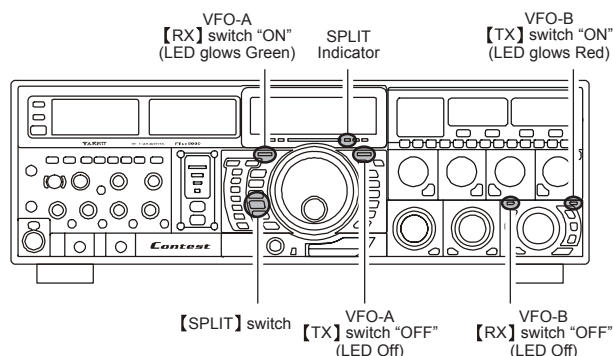

『Quick Point』

- The operating mode applied to the VFO-B register will be the same as that in use on the VFO-A register.
- The offset of the VFO-B from the VFO-A is programmed via the Menu, and is set to +5 kHz at the factory. Other offsets may be selected, however, using the following procedure:

1. Press the 【MNU】 key (#72) to enter the Menu mode.
2. Rotate the 【Main】 Tuning Dial knob (#34) to select Menu item "GENERAL 032 QUICK SPLIT FREQ."
3. Rotate the 【CLAR/VFO-B】 knob (#84) to select the desired offset.
The available selections are -20kHz ~ 0kHz ~ +20kHz (factory default: +5 kHz).
4. When you have completed all adjustments, press and hold in the 【MNU】 key for two seconds to save the new setting and exit to normal operation. If you only press the 【MNU】 key momentarily to exit, any changes you performed will not be stored.

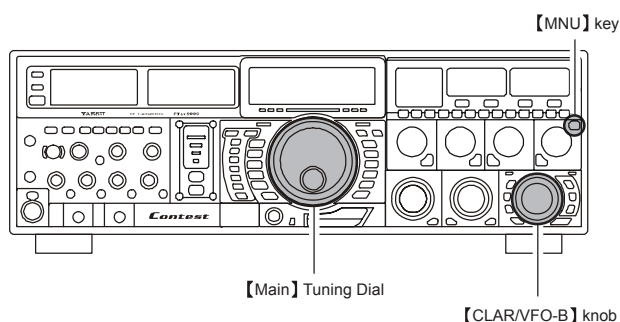

CW MODE OPERATION

The powerful CW operating capabilities of the FT DX 9000Contest include operation using both an electronic keyer paddle and a “straight key” or emulation thereof, as is provided by a computer-based keying device.

SETUP FOR STRAIGHT KEY (AND STRAIGHT KEY EMULATION) OPERATION

Before starting, connect your key line to the front and/or rear panel **[KEY]** jack, and be sure the **[KEYER]** switch on the left side of the front panel is turned off for now.

1. Press the **[CW]** mode switch (#27) to engage CW operation.

- The operating mode is selected using the **[MODE]** switches to the left of the **[Main]** Tuning Dial knob (#34), and the VFO (A or B) to which the selection is applied is selected by pressing the **[A]** or **[B]** switch above the Mode keys. Please be sure you are engaging CW on the right VFO.
- The LED associated with your VFO and (CW) Mode selection will light up.
- If you press the **[CW]** key once more, after initially selecting CW, you will engage the “CW Reverse” mode (see page 88), whereby the “opposite” sideband injection is used, compared to the “normal” sideband. The CW LED will blink for three seconds if you select CW Reverse.

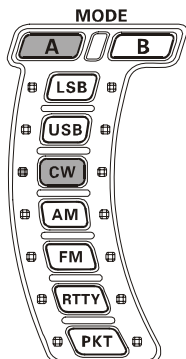

2. Rotate the **[MAIN]** Tuning Dial knob (#34) to select the desired operating frequency.

3. Press the **[BK-IN/SPOT]** key (#20) momentarily to engage automatic activation of the transmitter when you close the CW key. The LED imbedded in the **[BK-IN/SPOT]** switch will light up.

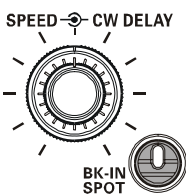

- When you close your CW key, the transmitter will automatically be activated, and the CW carrier will be transmitted. When you release the key, transmission will cease after a brief delay; the delay time is user-programmable, per the discussion on page 89.
- As shipped from the factory, the FT DX 9000 Contest TX/RX system for CW is configured for “Semi-break-in” operation. However, using Menu item “**MODE-CW 047 CW BK-IN**,” you may change this setup for full break-in (QSK) operation, whereby the switching is quick enough to hear incoming signals in the spaces between the dots and dashes of your transmission. This may prove very useful during contest and traffic-handling operations.

4. Operation using your CW key may now proceed.

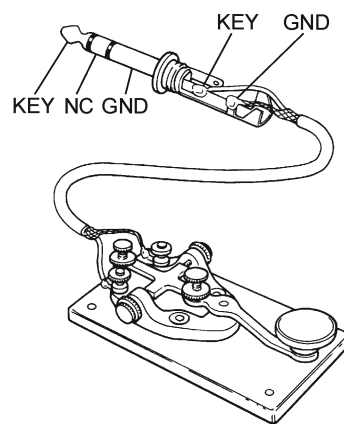
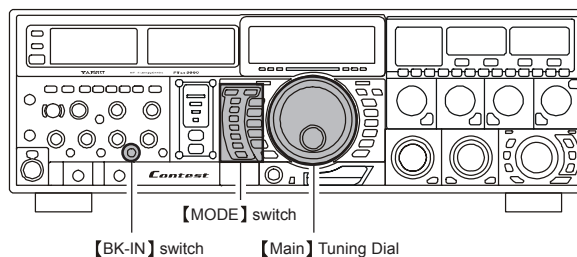

『Advice』

- You can monitor your sending by pressing the **[MONI]** key (#12), and adjust the **[MONI]** control (#14) for a comfortable listening level on the CW sidetone.
- If you set the **[BK-IN/SPOT]** switch to Off, you may practice your sending without having the signal go out over the air (sidetone only).

『Terminology』

- **Semi-break-in**

This is a pseudo- “VOX” mode used on CW, whereby the closure of the CW key will engage the transmitter, and release of the key will allow the receiver to receive after a short delay. No signals will be heard between the spaces between dots and dashes (unless the sending speed is extremely slow).

- **Full break-in**

Full break-in (Also known as “Full QSK”) involves very fast switching between transmit and receive, such that incoming signals may be heard between the dots and dashes as you send them. This allows you to hear a station that suddenly starts transmitting on your frequency, while you are in the midst of a transmission.

USING THE BUILT-IN ELECTRONIC KEYS

Connect the cable from your keyer paddle to the front or rear panel **[KEY]** jack.

1. Press the **[CW]** mode switch (#27) to engage CW operation.

- If you press the **[CW]** key once more, after initially selecting CW, you will engage the “CW Reverse” mode (see page 88), whereby the “opposite” sideband injection is used, compared to the “normal” sideband. The CW LED will blink for three seconds if you select CW Reverse.

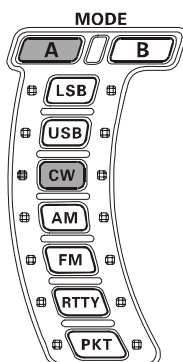

2. Rotate the **[Main]** Tuning Dial knob (#34) to select the desired operating frequency.
3. Press the **[KEYER]** switch (#18).

The LED imbedded in the switch will light up, confirming that the built-in Electronic Keyer is now active.

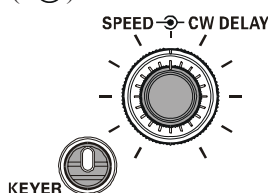

4. Rotate the **[SPEED]** control (#19) to set the desired sending speed. Clockwise rotation of the **[SPEED]** control will increase the keying speed.

- When you press either the “Dot” or “Dash” side of your paddle, the transmitter will automatically be activated.

5. If you press the **[BK-IN/SPOT]** key (#20) momentarily, “semi-break-in” operation (discussed previously) will be engaged.

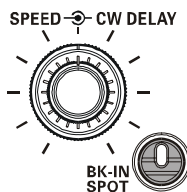

6. CW operation utilizing your paddle may now commence.

- When you utilize your keyer paddle, the transmitter will automatically be activated, and the CW characters (or a string of dots and dashes) will be transmitted. When you release the keyer paddle contacts, transmission will cease after a brief delay; the delay time is user-programmable, per the discussion on page 89.

Advice

If you reduce power using the **[RF PWR]** control (#38), the ALC meter reading will increase; this is normal and does not indicate any problem whatsoever (because increased ALC voltage is being used to lower the power).

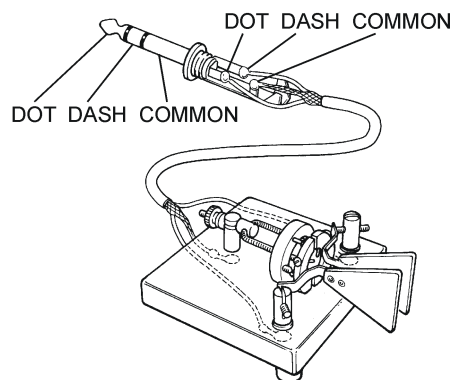
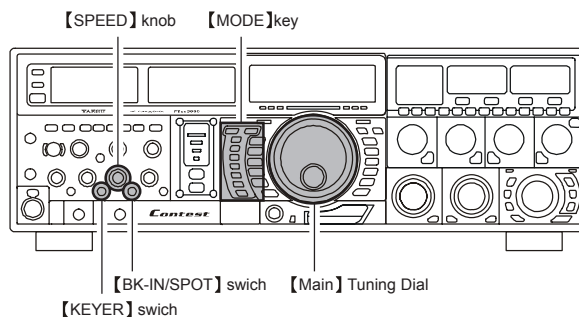

Full Break-in (QSK) Operation

As shipped from the factory, the FT DX 9000 Contest TX/RX system for CW is configured for “Semi-break-in” operation. However, using Menu item “**MODE-CW 047 CW BK-IN**,” you may change this setup for full break-in (QSK) operation, whereby the switching is quick enough to hear incoming signals in the spaces between the dots and dashes of your transmission.

1. Press the **[MNU]** key (#72) to open the Menu.
2. Rotate the **[Main]** Tuning Dial (#34) to select Menu item “**MODE-CW 047 CW BK-IN**.”
3. Rotate the **[CLAR/VFO-B]** knob (#84) to set this Menu item to “FULL.”
4. Press and hold in the **[MNU]** key for two seconds to save the new setting and exit.

A number of interesting and useful features are available during Electronic Keyer operation.

CW MODE OPERATION

USING THE BUILT-IN ELECTRONIC KEYS

Setting the Keyer Weight (Dot/Space:Dash) Ratio

The Menu may be used to adjust the Weight for the built-in Electronic Keyer. The default weighting is 3:1 (a dash is three times longer than a dot or space).

1. Press the **[MNU]** key (#72) to enter the Menu mode.
2. Rotate the **[Main]** Tuning Dial knob (#34) to select Menu item "**MODE-CW 049 CW WEIGHT**."
3. Rotate the **[CLAR/VFO-B]** key (#84) to set the weight to the desired value. The available adjustment range is for a Dot/Space:Dash ratio of 2.5 ~ 4.5 (default value: 3.0).
4. When you are finished, press and hold in the **[MNU]** key for two seconds to save the new setting and exit to normal operation.

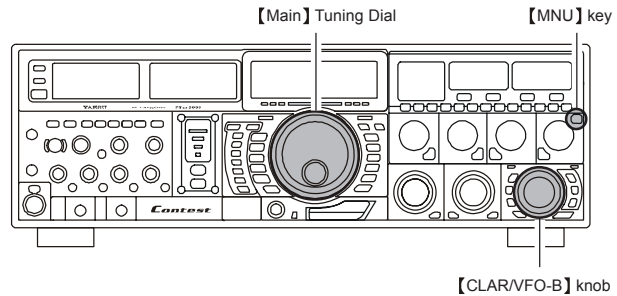

Selecting the Keyer Operating Mode

The configuration of the Electronic Keyer may be customized independently for the front and rear **[KEY]** jacks of the FT DX 9000 Contest. This permits utilization of Automatic Character Spacing (ACS), if desired, as well as the use of the electronic keyer via the front jack and a straight key or computer-driven keying line via the rear panel.

1. Press the **[MNU]** key (#72) to enter the Menu mode.
2. Rotate the **[Main]** Tuning Dial (#34) to select Menu item "**MODE-CW 041 F-KEYER TYPE**" (for the front **[KEY]** jack) or "**MODE-CW 043 R-KEYER TYPE**" (for the rear-panel's **[KEY]** jack).
3. Rotate the **[CLAR/VFO-B]** knob (#84) to set the keyer to the desired mode. The available selections are:
 - OFF:** The built-in Electronic Keyer is turned off ("straight key" mode.)
 - BUG:** Dots will be generated automatically by the keyer, but dashes must be sent manually.
 - ELEKEY:** Both dots and dashes will be generated automatically when you use your paddle.
 - ACS:** Same as "ELEKEY" except that the spacing between characters is precisely set by the keyer to be the same length as a dash (three dots in length.)
4. When you are finished, press and hold in the **[MNU]** key for two seconds to save the new setting and exit to normal operation.

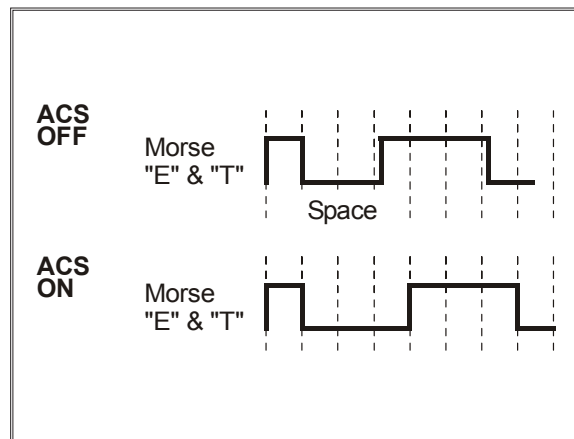
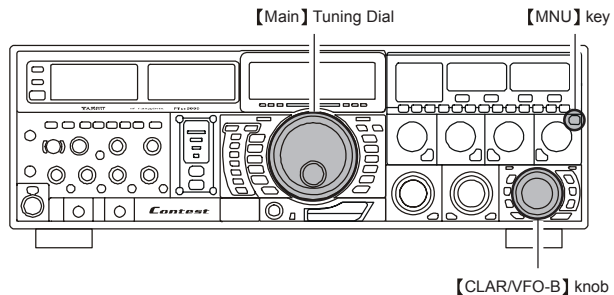

CW CONVENIENCE FEATURES

CW SPOTTING (ZERO-BEATING)

“Spotting” (zeroing in on another CW station) is a handy technique for ensuring that you and the other station are precisely on the same frequency.

For everyday operation, the (CW) **【PITCH】** control (#14) allows you to set the center of the receiver passband, as well as the offset pitch of your CW carrier signal, to the tone pitch you prefer to listen to.

The front panel’s Tuning Meter may also be moved so you can adjust your receiver frequency to center the incoming station on the pitch corresponding to that of your transmitted signal.

Using the SPOT System

If you press and hold in the front panel’s **【BK-IN/SPOT】** key (#20), the Spot tone will be heard. This tone corresponds to the pitch of your transmitted signal, and if you adjust the receiver frequency to match the pitch of the received CW signal to that of the Spot tone, your transmitted signal will be precisely matched to that of the other station.

『Advice』

- In a tough DX pile-up, you may actually want to use the SPOT system to find a “gap” in the spread of calling stations, instead of zeroing in precisely on the last station being worked by the DX station. From the DX side, if a dozen or more operators (also using Yaesu’s SPOT system) all call precisely on the same frequency, their dots and dashes merge into a single, long tone that the DX station cannot decipher. In such situations, calling slightly higher or lower may get your call through.
- The bar indicator on the front panel may be utilized for CW frequency adjustment, as well. Its configuration is set via Menu item “**DISPLAY 016 BAR DISPLAY SELECT;**” at the factory, the bar indicator is already set up for the “CW TUNE” selection.

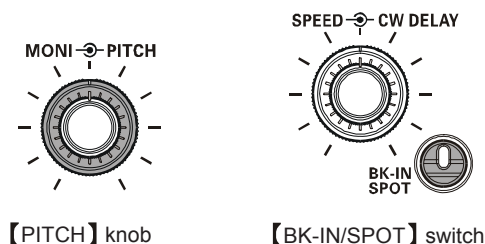
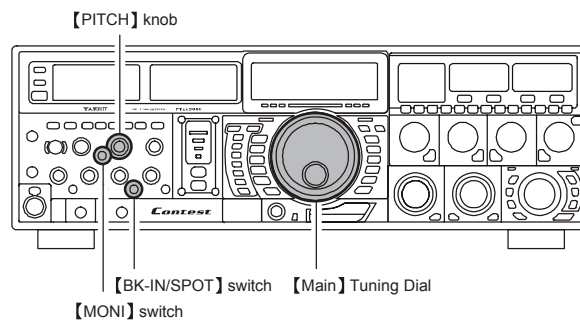
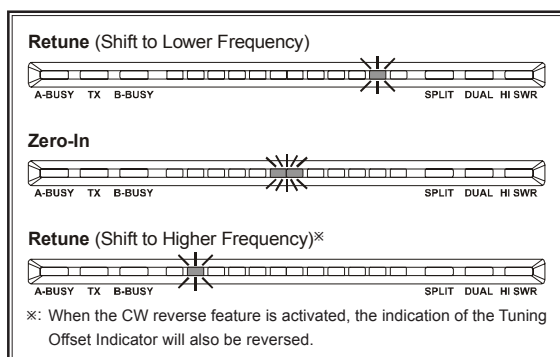

『Quick Point』

- The CW Spotting process utilizes the Spot tone or the bar indicator, with the actual offset pitch being set by the (CW) **【PITCH】** control on the front panel. The offset pitch may be set to any frequency between 300 Hz and 1050 Hz, in 50 Hz steps, and you can either match tones audibly (using the **【BK-IN/SPOT】** key) or align the receiver frequency so that the central LED on the bar indicator lights up. Note that there are 51 “dots” on the bar indicator, and depending on the resolution selected, the incoming CW signal may fall outside the visible range of the bar indicator, if you are not reasonably close to the proper alignment of tones.
- The displayed frequency, on CW, normally reflects the “zero beat” frequency of your offset carrier. That is, if you were to listen on USB on 14.100.00 MHz to a signal with a 700 Hz offset, the “zero beat” frequency of that CW carrier would be 14.000.70 MHz; the latter frequency is what the FT DX 9000 Contest displays, by default. However, you can change the display to be identical to that of what you would see on SSB by using Menu item “**MODE-CW 050 CW-FREQ DISPLAY**” and setting it to “FREQ” instead of its default “PITCH” setting.

CW CONVENIENCE FEATURES

USING CW REVERSE

If you experience a difficult interference situation, where an interfering station cannot readily be eliminated, you may wish to try receiving using the opposite sideband. This may throw the interfering station's frequency in a direction that may lend itself more readily to rejection.

To start, let's use a typical example where you have set the CW mode (using the default "USB" injection) onto the VFO-A.

- Now be sure your mode selection is still set for the VFO-A register, and press the **【CW】** mode key (#27) once more. The "LSB" LED will blink for three seconds, indicating that the "LSB" injection side has now been selected.
- When using Dual Receive, just press the **【B】** Mode key (#27), then press the **【CW】** key to engage CW Reverse on the VFO-B, in exactly the same way as for the VFO-A.

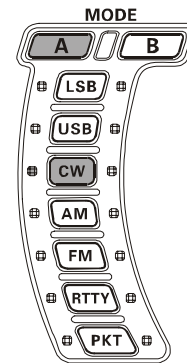
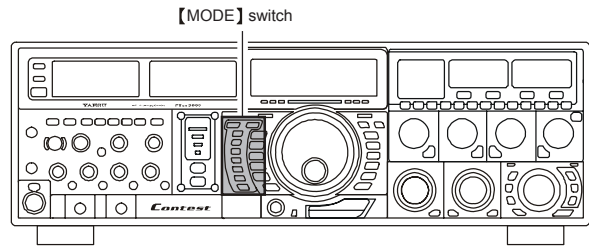

Press the **【CW】** mode key (#27) once more to return to the normal (USB) injection side and cancel CW Reverse operation.

In the illustration, Figure A demonstrates the normal CW injection setup, using the USB side. In Figure B, CW Reverse has been engaged, so as to receive using LSB-side injection to eliminate interference.

The beneficial effect of switching sidebands can clearly be seen in this example.

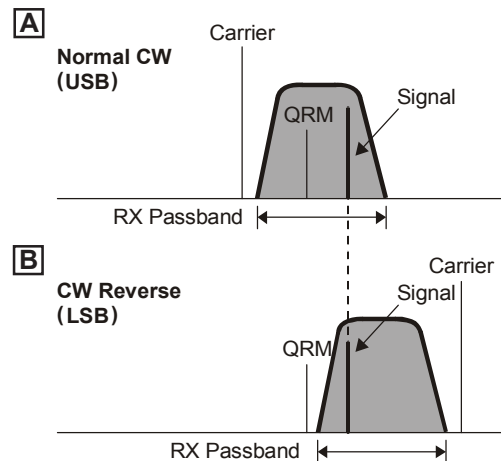

【Note】

When CW Reverse is engaged, the Tuning Meter action will concurrently be reversed as to its indication.

When the incoming signal pitch tone is properly aligned, the central LED lights up whether or not CW Reverse is engaged.

Retune (Shift to Lower Frequency)

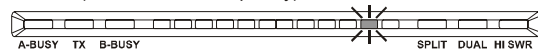

Zero-In

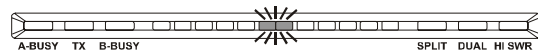

Retune (Shift to Higher Frequency)

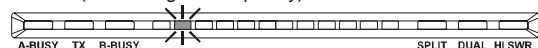

CW CONVENIENCE FEATURES

CW DELAY TIME SETTING

During semi-break-in (not QSK) operation, the hang time of the transmitter, after you have finished sending, may be adjusted to a comfortable value consistent with your sending speed. This is the functional equivalent to the “VOX Delay” adjustment used on voice modes; however, this is an independent adjustment used on CW, so you don’t have to change the delay when changing from Voice to CW.

The delay may be varied anywhere between 0 seconds (**【CW DELAY】** (#19) set fully counter-clockwise) to 5 seconds (fully clockwise).

1. Press the **【BK-IN/SPOT】** key (#20) momentarily to enable CW transmission (Menu item “MODE-CW 047 CW BK-IN” must be set to “SEMI”).
2. Start sending, and adjust the **【CW DELAY】** knob (#19) so that the hang time is as you prefer for comfortable operation.

『Quick Point』

The CW Delay feature is the functional equivalent to the “VOX Delay” adjustment used on voice modes; however, this is an independent adjustment used on CW, so you don’t have to change the delay when changing from Voice to CW.

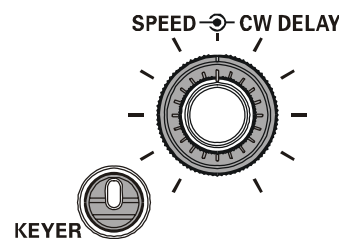
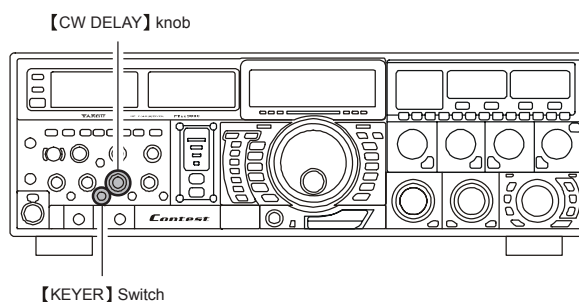

CW PITCH ADJUSTMENT

Rotation of the front panel’s **【CW PITCH】** control (#14) will allow adjustment of the center frequency of the receiver passband, as well as the pitch of your offset CW carrier, to the tone you prefer. The tone may be varied between 300 Hz and 1050 Hz, in 50 Hz steps.

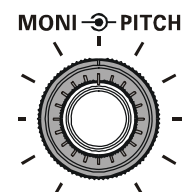
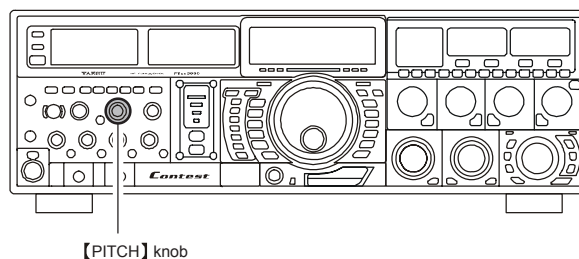

『Terminology』

CW Pitch

If you tuned to an exact “zero beat” on an incoming CW signal, you could not copy it (“Zero beat” implies a 0 Hz tone). Therefore, the receiver is offset several hundreds of Hz (typically), so as to allow your ear to detect the tone. The BFO offset associated with this tuning (that produces the comfortable audio tone) is called the CW Pitch.

CW CONVENIENCE FEATURES

CONTEST MEMORY KEYER

Message Memory Programming (Using Your Paddle)

1. Set the operating mode to CW.
2. Set the **【BK-IN/SPOT】** switch (#20) to Off.
3. Turn the internal Electronic Keyer On by pressing the **【KEYER】** switch (#18), if necessary.
4. Press the FH-2's **【MEM】** key.

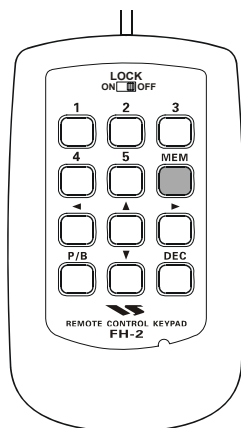

5. Press the **【1】 ~ 【5】** key on the FH-2 to begin the memory storage process.

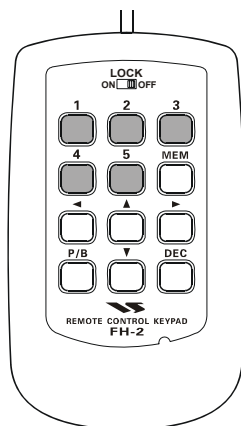

6. Send the desired message using your keyer paddle.
7. Press the **【MEM】** key on the FH-2 once more at the end of your message. Up to 50 characters may be stored among the five memories.

【Note】

You must exercise care in sending to ensure that the spaces between letters and words are accurately done; if your timing is off, the spacing may not come out right in the stored message.

For ease in setting up the keyer memories, we recommend you set Menu item **“MODE-CW 041 F-KEYER TYPE”** and/or **“MODE-CW 043 R-KEYER TYPE”** to “ACS” (Automatic Character Spacing) while you are programming the keyer memories.

Checking the CW Memory Contents

1. Be sure that Break-in is still turned Off.
2. Press the FH-2's **【1】 ~ 【5】** key to check your work. You will hear the results in the sidetone, but no RF energy will be transmitted.

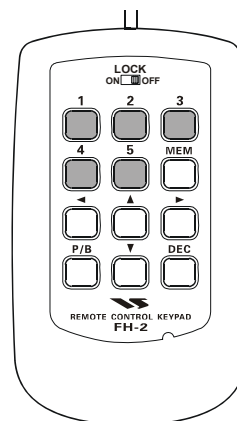

On-The-Air CW Message Playback

1. Press the **【BK-IN/SPOT】** key to enable transmission. Either Full- or Semi-break-in will be engaged, depending on the setting of Menu item **“MODE-CW 047 CW BK-IN.”**
2. Press the FH-2's **【1】 ~ 【5】** key to transmit the programmed message.

【Note】

If you subsequently decide to use the “Text” technique for memory storage, please note that the contents of a message stored using keyer paddle input will not be transferred over when you select “TEXT” on a particular memory register.

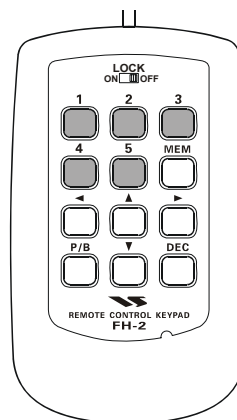

Transmitting in the Beacon Mode

It is possible to transmit, repetitively in a “Beacon” mode, any message programmed either via paddle input or via the “Text” input method. The time delay between message repeats may be set anywhere between 0 and 255 seconds via Menu item **“FH-2 SET 021 BEACON TIME.”** If you do not wish the message to repeat in a “Beacon” mode, please set this Menu item to “Off.” Press the **【1】 ~ 【5】** key, depending on the register into which the Beacon message is stored. Repetitive transmission of the Beacon message will begin. Press one of these keys once more to halt the Beacon transmissions.

CW CONVENIENCE FEATURES

CONTEST MEMORY KEYS

TEXT Memory

The five channels of CW message memory (up to 50 characters total) may also be programmed using a text-entry technique. This technique is somewhat slower than when you send the message directly from your keyer paddle, but accuracy of character spacing is ensured.

『Example 1』: CQ CQ CQ DE W6DXC K} (20 characters)

Now we will utilize another powerful feature of the CW Memory Keyer, the sequential contest number (“Countup”) feature.

『Example 2』: 599 10 200 # K} (15 characters)

Text Memory Storage

1. Press the **【MNU】** key (#72) to enter the Menu mode.
2. Rotate the **【Main】** Tuning Dial (#34) to select the CW Memory Register into which you wish to store the message; we are now selecting the message entry technique (Text entry).

FH-2SET 023 CW MEMORY 1
FH-2SET 024 CW MEMORY 2
FH-2SET 025 CW MEMORY 3
FH-2SET 026 CW MEMORY 4
FH-2SET 027 CW MEMORY 5

3. Rotate the **【CLAR/VFO-B】** knob (#84) to set the selected Memory Register to “TEXT.”
4. Press and hold in the **【MNU】** key for two seconds to save the new settings and exit.

『Advice』

By referring to the chart, you may view the characters available for message entry (both capital and small letters, plus numbers and a few punctuation marks, are available).

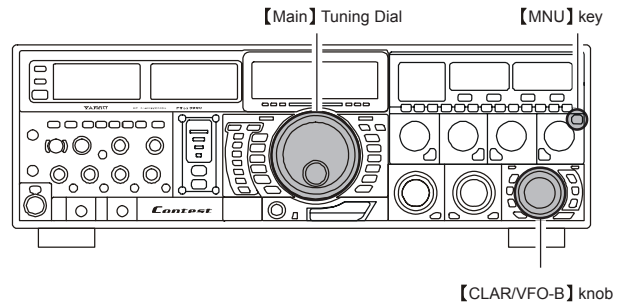

TEXT	CW	TEXT	CW
!	SN	.	AAA
"	AF	/	DN
\$	SX	:	OS
%	KA	;	KR
&	AS	=	BT
'	WG		SK
(KN	?	IMI
)	KK	\	HH
+	AR	¥	AL
,	MIM	—	IQ
-	DU		

Note that some punctuation and other marks ({ ^] [> < *) are listed, but they are displayed only and cannot be transmitted.

Contest Number Programming

Use this process if you are starting a contest, or of you somehow get out of sync with the proper number in the middle of a contest.

1. Press the FH-2's **【DEC】** key for two seconds. The current Contest Number will be displayed.
2. Rotate the Main Tuning Dial to set the Contest Number to the desired value.
3. Press the **【DEC】** key for two seconds to store the new number.

Decrementing the Contest Number

Use this process if the current contest number gets slightly ahead of the actual number you want to send (in case of a duplicate QSO, for example).

Press the FH-2's **【DEC】** key momentarily. The current Contest Number will be reduced by one. Press the **【DEC】** key as many times as necessary to reach the desired number. If you go too far, use the “Contest Number Programming” technique described above.

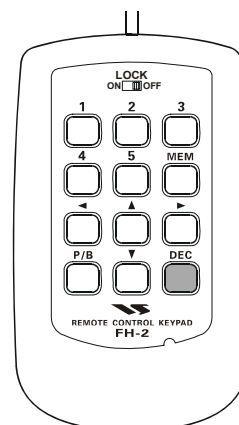

CW CONVENIENCE FEATURES

CONTEST MEMORY KEYS

Text Message Programming

1. Press the **[CW]** Mode key (#27) to set the operating mode to CW.
2. Be sure that Break-in is Off by pressing the **[BK-IN/SPOT]** key (#20), if necessary.
3. Press the FH-2's **[MEM]** key.

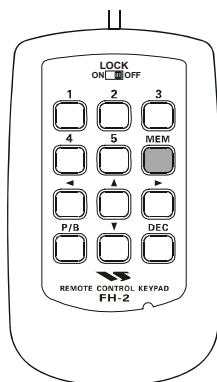

4. Press the FH-2's **[1]** ~ **[5]** key to select the desired Message Memory Register into which you wish to program the text.

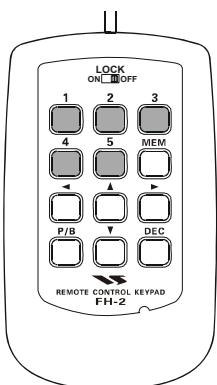

5. Use the FH-2's **[◀]** and **[▶]** keys to set the cursor position and use the **[▲]** and **[▼]** keys to choose the letter/number to be programmed in each slot of the memory. In the case of the second example above, the “}” character designates the slot where the Contest Number will appear.

『Advice』

You may also use the **[Main]** Tuning Dial (#34) and the **[CLAR/VFO-B]** knobs (#84) to program the message characters.

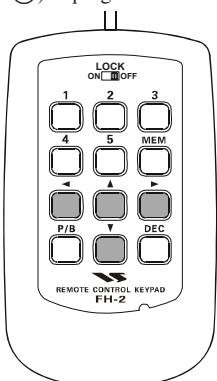

6. Press the FH-2's **[MEM]** key again once all characters have been programmed.

Checking the CW Memory Contents

1. Be sure that Break-in is still turned Off.
2. Press the FH-2's **[1]** ~ **[5]** key to check your work. You will hear the results in the sidetone, but no RF energy will be transmitted.

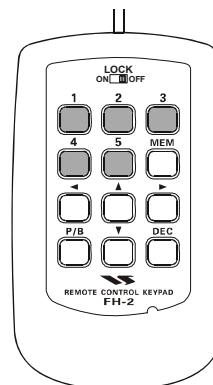

On-The-Air CW Message Playback

1. Press the **[BK-IN/SPOT]** key to enable transmission. Either Full- or Semi-break-in will be engaged, depending on the setting of Menu item “**MODE-CW 047 CW BK-IN.**”
2. Press the FH-2's **[1]** ~ **[5]** key to transmit the programmed message.

『Note』

If you subsequently decide to use the “MESSAGE” technique for memory storage, please note that the contents of a message stored using text input will not be transferred over when you select “MESSAGE” on a particular memory register.

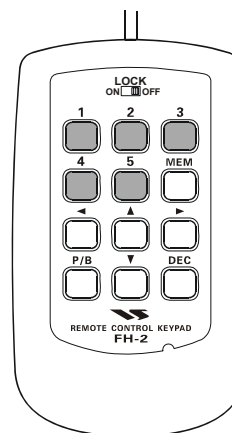

Correcting/Editing Previously-Stored Characters

Use the **[Main]** Tuning Dial knob (#34) to select the letter/number to be corrected, then rotate the **[CLAR/VFO-B]** knob (#84) to choose the revised letter/number to be utilized in this slot.

Deleting Previously-stored Characters

Use the **[Main]** Tuning Dial knob (#34) to select the last correct letter in the message. Now rotate the **[CLAR/VFO-B]** knob (#84) to select the “}” character; everything after the “}” character will be deleted.

FM MODE OPERATION

1. Press the **[FM]** mode key (#27) to select the FM operating mode.
 - Be sure that the FM mode is being selected on the proper VFO; check the status of the **[A]** and **[B]** switches above the mode selection keys before making your mode selection.
 - The LED (Red or Orange) corresponding to the VFO on which you selected FM (VFO-A or VFO-B, respectively), will light up.
2. Rotate the **[Main]** Tuning Dial knob (#34) (in the case of VFO-A operation) to select the desired operating frequency. If using the optional MD-200_{A8X} Desk Microphone, pressing the **[UP]** or **[DOWN]** button will cause frequency change in 5 kHz steps.
3. Press the microphone's PTT switch (or press the front panel **[MOX]** switch (#1)) to transmit. Speak into the microphone in a normal voice level. Release the PTT or **[MOX]** switch to return to receive.
4. Adjustment of the microphone gain may be accomplished in two ways. At the factory, a default level has been programmed that should be satisfactory for most situations. However, using Menu item "**MODE-FM 058 FM MIC GAIN**," you may set a different fixed value, or choose the "MCVR" option, which then lets you use the front panel **[MIC]** control (#15) to set the microphone gain in the FM mode. The microphone gain should be set such that deflection of the ALC meter goes all the way to the right side of the ALC meter scale.

『Advice』

- The FH-2 may be used, in the FM mode, for storage of voice memory messages. See page 92.
- FM is only used in the 28 MHz and 50 MHz Amateur bands covered in the FT DX 9000 Contest. Please do not use FM on any other bands.
- Reduction of the setting of the **[RF PWR]** knob (#38) will cause the deflection of the ALC meter to increase; this is normal.

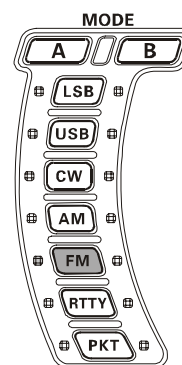
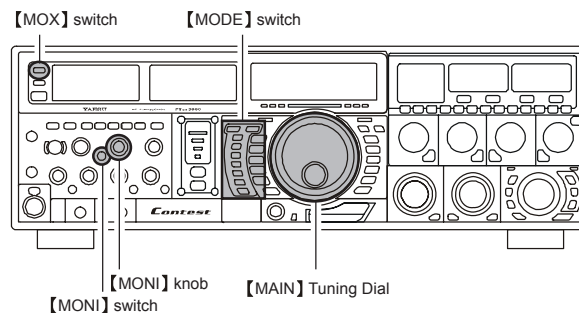

REPEATER OPERATION

The FT DX 9000 Contest may be utilized on 29 MHz and 50 MHz repeaters.

1. Rotate the Main tuning Dial to the output frequency (downlink) from the repeater.
2. If CTCSS Tone operation is desired/needed, press and hold in the **[FM]** Mode key (#27) for two seconds to engage the CTCSS mode.
3. Rotate the **[Main]** Tuning Dial knob (#34) to select the desired CTCSS mode. If you just need to send the uplink encoding tone, select “tn.” For encode/decode operation, choose “ts.” Instead.

The available choices are
“OFF” → “tn” → “ts” → “OFF.”

4. Rotate the **[CLAR/VFO-B]** knob (#84) to select the desired CTCSS Tone to be used. A total of 50 standard CTCSS tones are provided (see the CTCSS Tone Chart).
5. Press the **[FM]** Mode key to select the desired repeater shift direction.

The selections are
“S” → “+” → “-” → “S”

where “S” represents “Simplex” operation (not used on a repeater).

6. Press and hold in the **[FM]** Mode key for two seconds to exit from the repeater setup mode.
7. Close the microphone’s PTT switch (or press the **[MOX]** switch (#1)) to begin transmission. You will observe that the frequency has shifted to correspond to the programming you set up in the previous steps. Speak into the microphone in a normal voice level, and release the PTT or **[MOX]** switch to return to the receive mode.

『Advice』

The conventional repeater shift used on 29 MHz is 100 kHz, while on the 50 MHz band the shift may vary between 500 kHz and 1.7 kHz (or more). To program the proper repeater shift, use Menu items “**MODE-FM 060 RPT SHIFT(28 MHz)**” and “**MODE-FM 061 RPT SHIFT(50 MHz)**,” as appropriate.

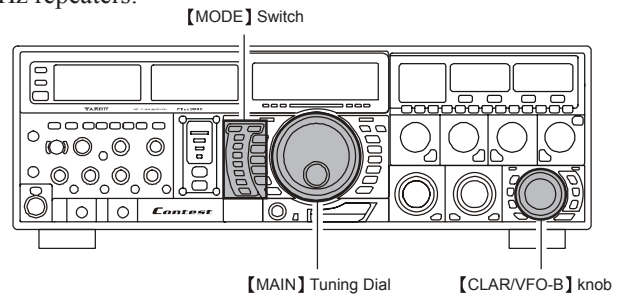

CTCSS Operation
tn: Tone Encoder
ts: Tone Squelch
oFF: OFF

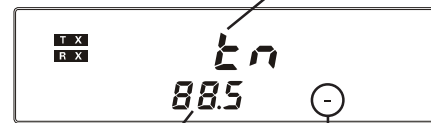

CTCSS Tone Frequency Repeater Shift Direction
S: Simplex
-: Minus Shift
+: Plus Shift

CTCSS Tone Frequency (Hz)							
67.0	69.3	71.9	74.4	77.0	79.7	82.5	85.4
88.5	91.5	94.8	97.4	100.0	103.5	107.2	110.9
114.8	118.8	123.0	127.3	131.8	136.5	141.3	146.2
151.4	156.7	159.8	162.2	165.5	167.9	171.3	173.8
177.3	179.9	183.5	186.2	189.9	192.8	196.6	199.5
203.5	206.5	210.7	218.1	225.7	229.1	233.6	241.8
250.3	254.1	—	—	—	—	—	—

You may also use “Tone Squelch” whereby your receiver will be kept silent until an incoming signal bearing a matching CTCSS tone is received. Your receiver’s squelch will then open in response to the reception of the required tone.

1. Rotate the **[Main]** Tuning Dial knob (#34) to the output frequency (downlink) from the repeater.
2. Press and hold in the **[FM]** Mode key (#27) for two seconds to engage the CTCSS mode.
3. Rotate the **[Main]** Tuning Dial knob to choose “ts.” The available choices are
“OFF” → “tn” → “ts” → “OFF.”
4. Rotate the **[CLAR/VFO-B]** knob (#84) to select the desired CTCSS Tone to be used. A total of 50 standard CTCSS tones are provided (see the CTCSS Tone Chart).
5. Press and hold in the **[FM]** Mode key for two seconds. On the display, just below the “1 Hz” frequency digit, a small “d” will indicate that the Tone Decoder is engaged.

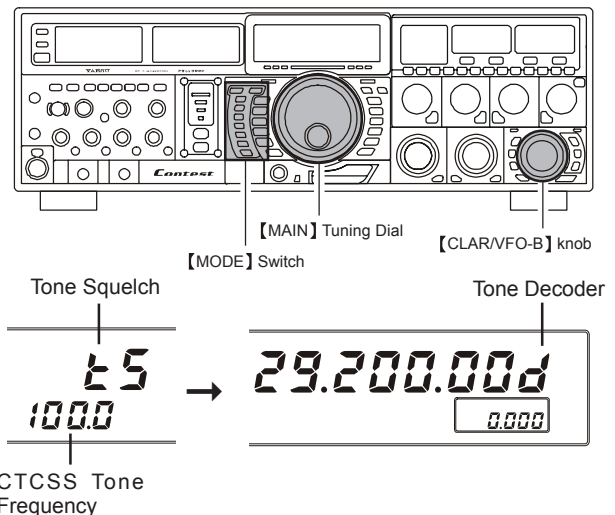

CONVENIENT MEMORY FUNCTIONS

The FT DX 9000 Contest contains ninety-nine regular memories, labeled 01 through 99, nine special programmed limit memory pairs, labeled P-1L/1U through P-9L/9U, and five QMB (Quick Memory Bank) memories, labeled C1 ~ C5. Each stores various settings, not only the VFO-A frequency and mode (See below). By default, the 99 regular memories are contained in one group; however, they can be arranged in up to six separate groups, if desired.

『Quick Point』

The FT DX 9000 Contest's memory channels store the following data (not just the operating frequency):

- Frequency
- Mode
- Clarifier status and its Offset Frequency
- ANT status
- IPO status
- Roofing filter status and its Bandwidth
- Noise Blanker status
- CONTOUR status and its Peak Frequency
- DSP Noise Reduction (DNR) status and its Reduction algorithm selection.
- DSP Notch filter (NTCH) status
- NAR bandwidth status
- DSP Auto Notch filter (DNF) status
- Repeater Shift Direction and Shift Frequency
- CTCSS status and Tone Frequency

Memory channels may be grouped into as many as six convenient batches, for easy identification and selection. For example, you might want to set aside memory groups for AM BC stations, shortwave broadcast stations, contest frequencies, repeater frequencies, and PMS limits, or any other groupings you like.

Each memory group is capable of holding up to 22 memory channels (the Group size is fixed). When a memory channel is grouped, the channel numbers change to correspond to the chart below:

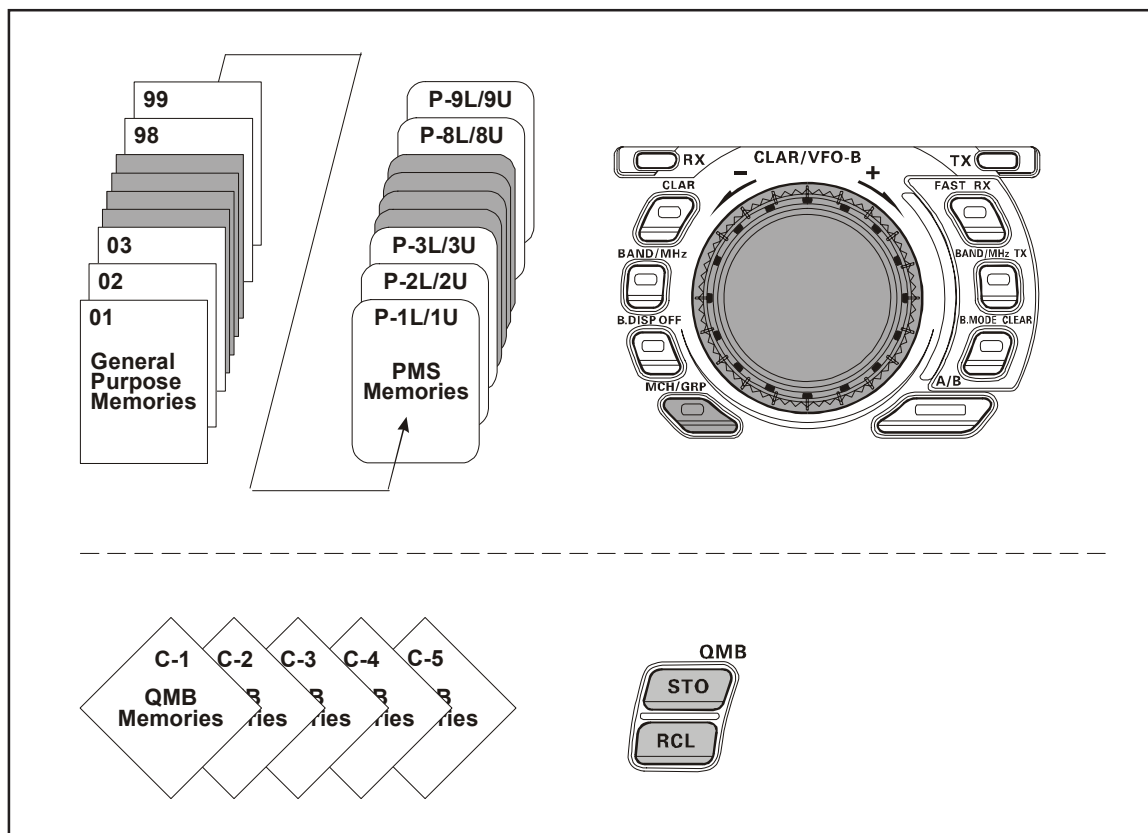

QMB (QUICK MEMORY BANK)

The Quick Memory Bank is comprised of five memories (labeled C1 ~ C5) independent from the regular and PMS memories. These can quickly store operating parameters for later recall.

QMB CHANNEL STORAGE

1. Tune to the desired frequency on the VFO-A.
2. Press the blue (QMB) **【STO】** key (#28). The “beep” will confirm that the contents of the VFO-A have been written to the currently-available QMB memory.

If you repeatedly press the (QMB) **【STO】** key, the QMB memories will be written in the following order:

C-2 → C-3 → C-4 → C-5 → C-1

Once all five QMB memories have data on them, previous data (starting with channel C1) will be over-written on a first-in, first-out basis.

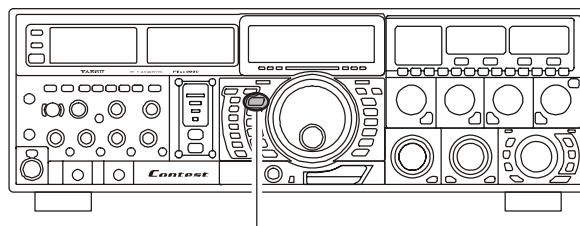

【QMB STO】key

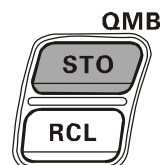

QMB CHANNEL RECALL

1. Press the (QMB) **【RCL】** key (#29). The display will indicate “QMB” and the current QMB channel’s data will be shown on the main frequency display field.
2. Repeatedly pressing the (QMB) **【RCL】** key will toggle you through the QMB channels:

C-2 → C-3 → C-4 → C-5 → C-1

【Advice】

You may change the QMB channel’s frequency by rotating the **【Main】** Tuning Dial (#34) (Memory Tune Operation, described details on page 101).

- “**MT**” will replace “**MR**” in the multi-panel window, indicating you are in the “Memory Tune” mode.
- During Memory Tune operation, you may change operating modes, and engage and offset the Clarifier, if desired.
Press the **【V/M】** switch momentarily to return to the originally-memorized frequency of the current memory channel. One more press of the **【V/M】** key will return you to VFO operation.

QMB is a very convenient means of storing and recalling memories, if you only have recourse to a few. With one touch of the (QMB) **【RCL】** key, the frequency data will appear instantly as though you were operating on the VFO-A.

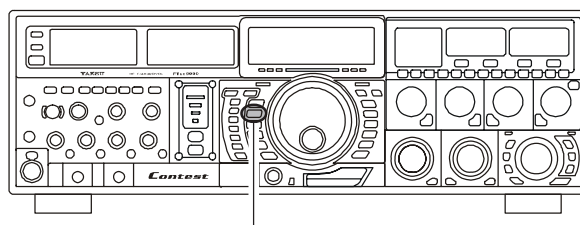

【QMB RCL】key

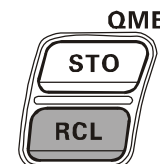

MEMORY GROUPS

MEMORY GROUP ASSIGNMENT

1. Press the **【MNU】** key (#72) to enter the Menu mode.
2. Rotate the **【Main】** Tuning Dial (#34) to select Menu item “**GENERAL 031 MEM GROUP.**”
Rotate the **【CLAR/VFO-B】** knob (#84) to set this Menu item to “ENABLE” (the default setting is “DISABLE”).
3. Press and hold in the **【MNU】** key for two seconds to save the new setting and exit. Operation will now be restricted to the six Memory Groups.
To cancel Memory Group operation, repeat steps (1) through (3) above, choosing “DISABLE” in step (2).

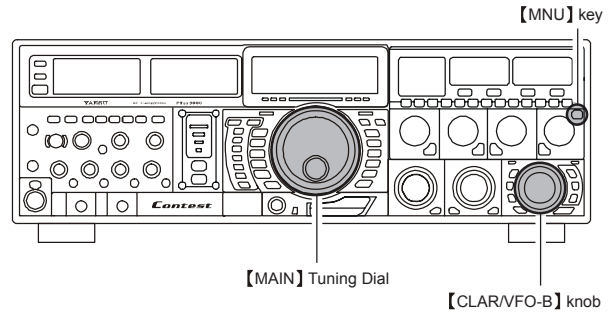

『Advice』

Note that for the PMS memory group, the PMS memories “P1L” through “P9U” will be so designated, so as to avoid confusion.

Memory Channel Number	
Groups Memory “OFF”	Groups Memory “ON”
01 ~ 19	1-01 ~ 1-19
20 ~ 39	2-01 ~ 2-20
40 ~ 59	3-01 ~ 3-20
60 ~ 79	4-01 ~ 4-20
80 ~ 99	5-01 ~ 5-20
P-1L/1U ~ P-9L/9U	P-1L/1U ~ P-9L/9U

CHOOSING THE DESIRED MEMORY GROUP

You may recall memories just within a particular Memory Group, if desired.

1. Press the **【V/M】** key (#43), if necessary, to enter the Memory mode.
2. Press and hold in the **【MCH/GRP】** key (#83) (below and to the left of the **【CLAR/VFO-B】** knob (#84)) for two seconds. The imbedded LED inside the switch will light up.
3. Rotate the **【CLAR/VFO-B】** knob to select the desired Memory Group.

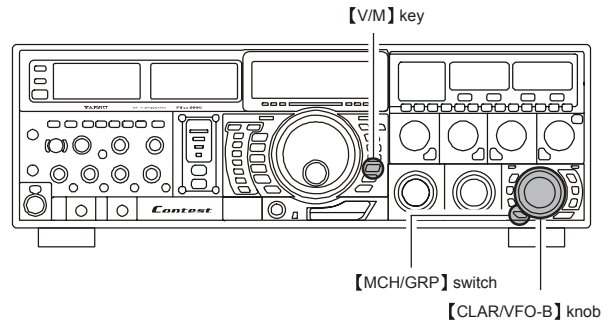

To exit from Memory Group operation, press and hold in the **【MCH/GRP】** key for two seconds once more.

『Advice』

- You will now be operating using memories only within the selected Memory Group.
- If no channels have been assigned to a particular Memory Group, you will not have access to that Group.

MEMORY OPERATION

The memory system of the FT DX 9000 Contest allows storage and recall of up to 99 memories, each storing frequency, mode, and a wide variety of status information detailed previously. Memories may be grouped into as many as six Memory Groups, and additionally you get nine pairs of band-limit (PMS) memories along with five QMB (Quick Memory Bank) memories.

MEMORY STORAGE

1. Set the VFO-A up with all frequency, mode, and status the way you want to have it stored.
2. Press the **[A▶M]** button (#45) momentarily (the current channel number will start blinking); the contents of the current memory channel will be shown on the VFO-B display field.
3. Press the **[MCH/GRP]** key (#83) momentarily. When you press the **[MCH/GRP]** key, the Red LED imbedded within the switch should light up, indicating that you are ready to choose a channel into which to store the data.

『Advice』

- If the Red LED imbedded in the **[MCH/GRP]** switch does not light up, check to be sure that the orange lamp to the right of the **[CLAR/VFO-B]** knob (#84) is not illuminated. If it is, press the **[A/B]** switch to make it go out, then press the **[MCH/GRP]** key again.
4. Rotate the **[CLAR/VFO-B]** knob (#84) to select the memory channel onto which you wish to store the data. If you have selected a channel on which data is already stored, that frequency will appear on the VFO-B's frequency display field.
 5. Press and hold in the **[A▶M]** key for two seconds to store the frequency and other data into the selected memory channel. A double beep will confirm that you have held the **[A▶M]** key in long enough.

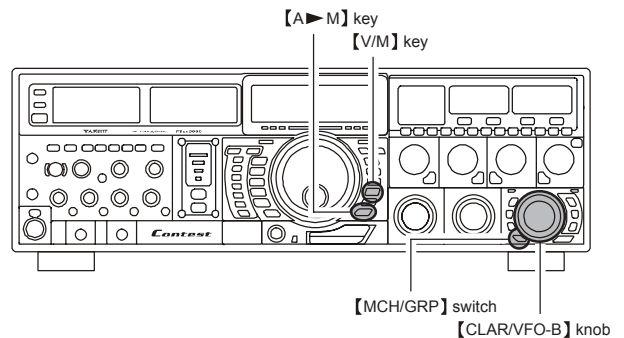

MEMORY CHANNEL RECALL

1. Press the **[V/M]** switch (#43), if necessary, to enter the Memory mode. A memory channel number will appear in the multi-panel window.
2. Press the **[MCH/GRP]** key (#83) momentarily. The Red LED inside the switch will light up, indicating that you are ready to recall a memory channel.

『Advice』

- If the Red LED imbedded in the **[MCH/GRP]** key does not light up, check to be sure that the orange lamp to the right of the **[CLAR/VFO-B]** knob (#84) is not illuminated. If it is, press the **[A/B]** switch (#88) to make it go out, then press the **[MCH/GRP]** key again.
3. After pressing the **[MCH/GRP]** key, you may rotate the **[CLAR/VFO-B]** knob (#84) to select the desired memory channel.

『Advice』

To work within a particular Memory Group, press and hold in the **[MCH/GRP]** key for two seconds. The imbedded LED will glow Orange; now press the **[MCH/GRP]** key momentarily, and the LED will change to Red; you may now choose the channel within the selected Memory Group.

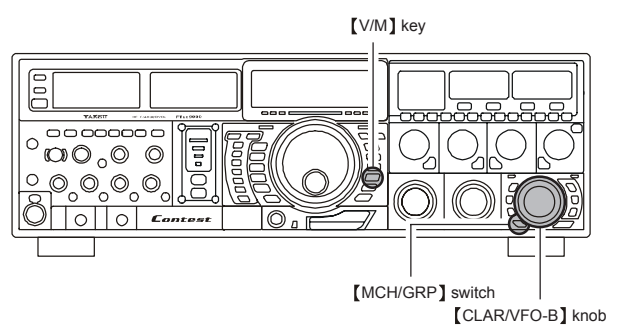

MEMORY OPERATION

MEMORY CHANNEL RECALL

Checking a Memory Channel's Status

Before programming a channel into memory, you can check the current contents of that channel without the danger of over-writing the data accidentally.

1. Press the **【MCH/GRP】** key (#83) momentarily. The imbedded LED will glow Red, indicating that you are now ready to view memory channel contents.

『Advice』

If the Red LED imbedded in the **【MCH/GRP】** key does not light up, check to be sure that the orange lamp to the right of the **【CLAR/VFO-B】** knob (#84) is not illuminated. If it is, press the **【A/B】** switch to make it go out, then press the **【MCH/GRP】** key again.

2. Press the **【A▶M】** key (#45). The data stored in the currently-selected memory channel will be displayed in the VFO-B frequency field. However, since you are only checking the contents of the memory channel, your radio will not have moved to the memory channel's frequency.
3. Rotate the **【CLAR/VFO-B】** knob (#84) to select other memory channels. To exit from the Memory Check mode, press the **【A▶M】** key once more.

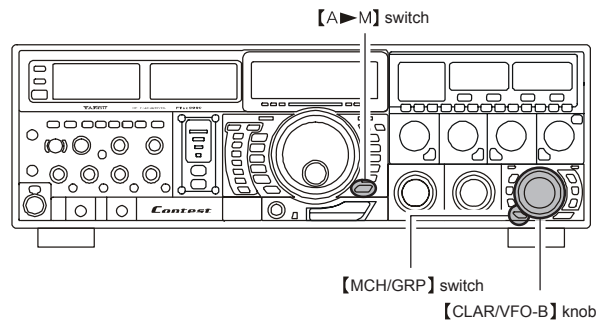

『Advice』

- While the Memory Check function is engaged, the memory channel number will blink.
- While operating in the VFO mode, using Memory Check, you may store the current contents of the VFO into the selected memory by pressing and holding in the **【A▶M】** key for two seconds (until the double beep). Conversely, if you wish to write the contents of the current memory into the VFO-A register, press and hold in the **【M▶A】** key (#44) for two seconds.

ERASING MEMORY CHANNEL DATA

1. Press the **【MCH/GRP】** key (#83) momentarily. The imbedded LED will glow Red, indicating that you are now ready to view memory channel contents.

『Advice』

- If the Red LED imbedded in the **【MCH/GRP】** key does not light up, check to be sure that the orange lamp to the right of the **【CLAR/VFO-B】** knob (#84) is not illuminated. If it is, press the **【A/B】** switch to make it go out, then press the **【MCH/GRP】** key again.

2. Press the **【A▶M】** key (#45). The data stored in the currently-selected memory channel will be displayed in the VFO-B frequency field.
3. Rotate the **【CLAR/VFO-B】** knob (#84) to select the memory channel that you would like to erase.
4. Press the **【LOCK】** switch (#36) to erase the contents of the selected memory channel.

『Advice』

- After erasure, only the memory channel number will remain; the frequency data will disappear from the display.
- If you make a mistake and wish to restore the memory's contents, just repeat steps (1) through (3) above.

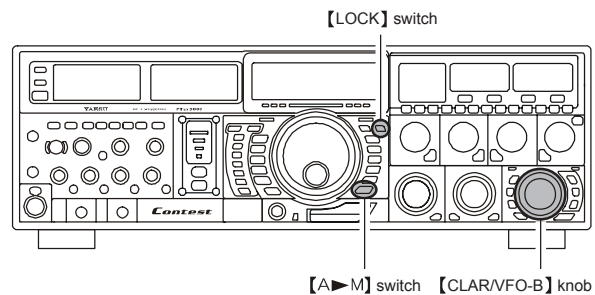

MOVING MEMORY DATA TO THE VFO-A

You may transfer the contents of the currently-selected memory channel into the VFO-A register, if you like.

1. Press the **【V/M】** switch (#43), as necessary, to go to the Memory mode. The memory channel number will appear in the multi-panel window.
2. Press the **【MCH/GRP】** key (#83) momentarily. The Red LED inside the switch will light up, indicating that you are ready to recall a memory channel.

『Advice』

If the Red LED imbedded in the **【MCH/GRP】** key does not light up, check to be sure that the orange lamp to the right of the **【CLAR/VFO-B】** knob (#84) is not illuminated. If it is, press the **【A/B】** switch to make it go out, then press the **【MCH/GRP】** key again.

3. Rotate the **【CLAR/VFO-B】** knob (#84) to select the memory channel the contents of which you wish to transfer to the VFO-A.
4. Press and hold in the **【M▶A】** switch (#44) for two seconds, until you hear the double beep. The data in the selected memory channel will now be transferred to the VFO-A.

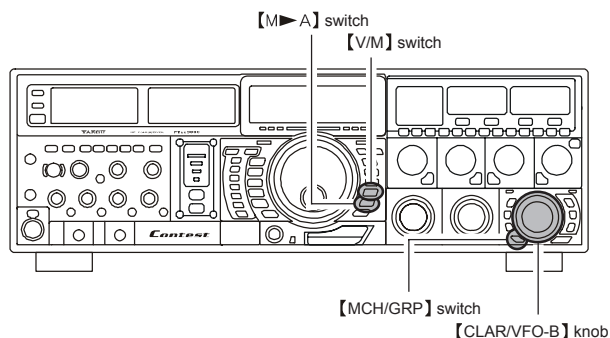

『Advice』

This transfer of data to the VFO-A does not affect the original contents of the memory channel; this is a “copy” function that leaves the memory contents unchanged.

Memory Tune Operation

You may freely tune off of any memory channel in a “Memory tune” mode that is similar to VFO operation. So long as you do not over-write the contents of the current memory, Memory tune operation will not alter the contents of the memory channel.

1. Press the **【V/M】** switch (#43) to recall any memory channel.
2. Rotate the **【Main】** Tuning Dial (#34); you will now observe that the memory channel’s frequency is changing.
 - “**MT**” will replace “**MR**” in the multi-panel window, indicating you are in the “Memory Tune” mode.
 - During Memory Tune operation, you may change operating modes, and engage and offset the Clarifier, if desired. Press the **【V/M】** switch momentarily to return to the originally-memorized frequency of the current memory channel. One more press of the **【V/M】** switch will return you to VFO operation.

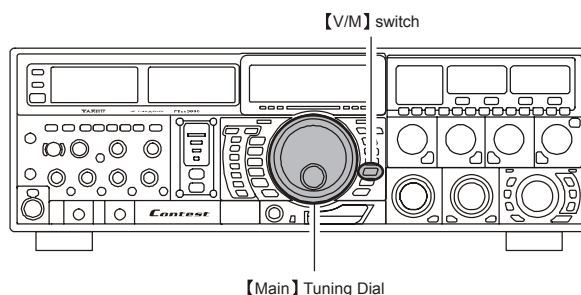

『Note』

Computer software programs utilizing the CAT system interface port may presume that the transceiver is operating in the VFO mode for certain features like “band mapping” and/or frequency logging. Because the “Memory Tune” mode so closely resembles the VFO mode, be sure that you have the FT DX 9000 Contest operating in a control mode compatible with your software’s requirements. Use the VFO mode if you’re not sure.

OPERATION ON ALASKA EMERGENCY FREQUENCY: 5167.5 kHz (U.S. VERSION ONLY)

Section 97.401(d) of the regulations governing amateur radio in the United States permit emergency amateur communications on the spot frequency of 5167.5 kHz by stations in (or within 92.6 km of) the state of Alaska. This frequency is only to be used when the immediate safety of human life and/or property are threatened, and is never to be used for routine communications.

The FT DX 9000 Contest includes the capability for transmission and reception on 5167.5 kHz under such emergency conditions via the Menu system. To activate this feature:

1. Press the **【MNU】** (#72) key.
2. Rotate the **【Main】** Tuning Dial knob (#34) to select “**TX GNRL 160 EMERGENCY FREQ TX.**”
3. Rotate the **【CLAR/VFO-B】** knob (#84) select “ENABLE.”
4. Press and hold in the **【MNU】** key for two second to save the new setting and exit to normal operation. Emergency communication on this spot frequency is now possible.
5. Press the **【V/M】** switch (#43), as necessary, to enter the Memory mode, then rotate the **【CLAR/VFO-B】** knob to select the emergency channel (M-EMG), which is found between channels “P-9U” and “01.”

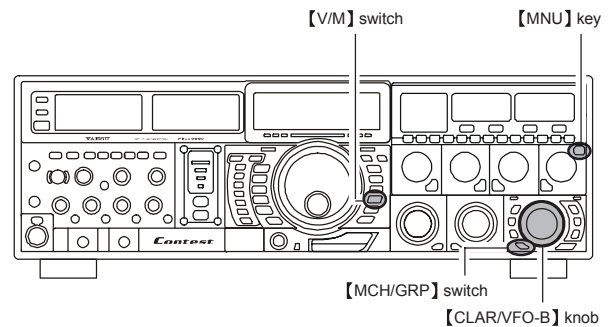

Note that the receive-mode CLARIFIER functions normally while using this frequency, but variation of the transmit frequency is not possible. Activation of “**TX GNRL 160 EMERGENCY FREQ TX**” does not enable any other out-of-amateur-band capability on the transceiver. The full specifications of the FT DX 9000 Contest are not necessarily guaranteed on this frequency, but power output and receiver sensitivity should be fully satisfactory for the purpose of emergency communication.

If you wish to disable operation capability on the Alaska Emergency Frequency, repeat the above procedures, but set “**TX GNRL 160 EMERGENCY FREQ TX**” to “DISABLE” in step 3.

In an emergency, note that a half-wave dipole cut for this frequency should be approximately 45’3” on each leg (90’6” total length). Emergency operation on 5167.5 kHz is shared with the Alaska-Fixed Service. This transceiver is not authorized for operation, under the FCC’s Part 87, for aeronautical communications.

OPERATION ON THE 60-METER BAND (U.S. VERSION)

The recently-released 60-meter band is covered, in the FT DX 9000 Contest, by five special, fixed memory channels. These channels are set to USB, and they appear between the “last” PMS channel (“P9U”) and the first “regular” memory channel (Channel 1).

The five channels are:

Channel Number	Frequency
US1	5.332.000 MHz
US2	5.348.000 MHz
US3	5.368.000 MHz
US4	5.373.000 MHz
US5	5.405.000 MHz

To operate on the 60-meter band channels, press the **【V/M】** switch (#43), if necessary, to enter the Memory mode, then rotate **【CLAR/VFO-B】** knob (#84) to select the desired channel from the above selections.

Be sure to observe all current regulations regarding Effective Radiated Power (E.R.P.) while operating on the 60-meter band.

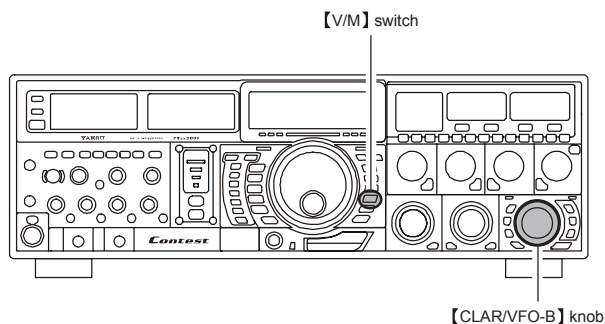

VFO AND MEMORY SCANNING

You may scan with the VFO or the memories of the FT DX 9000 Contest, and the radio will halt the scan on any station with a signal strong enough to open the receiver's squelch.

VFO SCANNING

1. Set the (RX) VFO to the frequency on which you would like to begin scanning.
2. Rotate the **【SQL】** control (#21) so that the background noise is just silenced.
3. Press and hold in the microphone's **【UP】** or **【DOWN】** key for 2 second to start scanning in the specified direction.
 - If the scanner halts on an incoming signal, the decimal point between the "MHz" and "kHz" digits of the frequency display will blink.
 - If the incoming signal disappears, scanning will resume in about five seconds.
 - On the SSB/CW and SSB-based Data modes, the scanner will pause on a received signal, then will step across the signal very slowly, giving you time to stop the scan, if you like. In these modes on the VFO, the scanner does not stop, however.

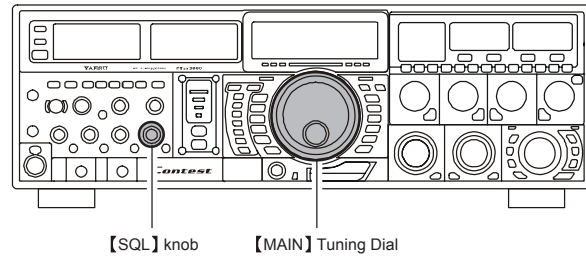

MEMORY SCAN

1. Set the transceiver up in the memory mode by pressing the **【V/M】** switch (#43), if necessary.
2. Rotate the **【SQL】** control (#21) so that the background noise is just silenced.
3. Press and hold in the microphone's **【UP】** or **【DOWN】** key for 2 second to start scanning in the specified direction.
 - If the scanner halts on an incoming signal, the decimal point between the "MHz" and "kHz" digits of the frequency display will blink.
 - If the incoming signal disappears, scanning will resume in about five seconds.

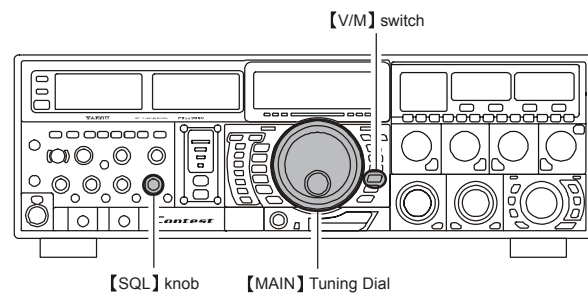

『Advice』

- During Memory Group operation, only the channels within the current Memory Group will be scanned.
- If the scan has paused on a signal, pressing the microphone's **【UP】** or **【DOWN】** key will cause scanning to resume instantly.
- If you press the microphone's PTT switch during scanning, the scanner will halt at once. Pressing the PTT switch during scanning will not cause transmission, however.
- You may select the manner in which the scanner resumes while it has paused on a signal, using Menu item "**GENERAL 037 MIC SCAN RESUME.**" During memory scanning, the default "TIME" setting will cause the scanner to resume scanning after five seconds; you may change it, however, to resume only after the carrier has dropped out, if you like See page 119.

『Quick Point』

If you have no interest in scanning, and wish to prohibit the microphone's **【UP】/【DOWN】** keys from initiating scanning, you may disable scanning control from the microphone using Menu Item "**GENERAL 036 MIC SCAN**" (set it to "DISABLE").

To limit scanning (and manual tuning) within a particular frequency range, you can use the Programmable Memory Scanning (PMS) feature, which utilizes nine special-purpose memory pairs (“P-1L/P-1U” through “P-9L/P-9U”). The PMS feature is especially useful in helping you to observe any operating sub-band limits which apply to your Amateur license class.

1. Store the Lower and Upper tuning/scanning limit frequencies into the memory pair “P1L” and “P1U,” respectively, or any other “L/U” pair of memories in the special PMS memory area. See page 99 for details regarding memory storage.
2. Press the **【V/M】** switch (#43) to enter the Memory mode.
3. Press the **【MCH/GRP】** key (#83) momentarily. When you press the **【MCH/GRP】** key, the Red LED imbedded within the switch should light up, indicating that you are ready to choose a channel into which to store the data.

『Advice』

- If the Red LED imbedded in the **【MCH/GRP】** key does not light up, check to be sure that the orange lamp to the right of the **【CLAR/VFO-B】** knob (#84) is not illuminated. If it is, press the **【A/B】** switch to make it go out, then press the **【MCH/GRP】** key again.
4. Rotate the **【CLAR/VFO-B】** knob (#84) to select memory channel “P1L” or “P1U.”
 5. Rotate the **【SQL】** control (#21) so that the background noise is just silenced.
 6. Turn the **【Main】** Tuning Dial knob (#34) slightly (to activate memory tuning). Tuning and scanning are now limited to the range within the P1L/P1U limits until you press the **【V/M】** switch to return to memory channel or VFO-A operation.
 7. Press and hold in the microphone’s **【UP】** or **【DOWN】** key for 2 second to start scanning in the specified direction.
 - If the scanner halts on an incoming signal, the decimal point between the “MHz” and “kHz” digits of the frequency display will blink.
 - If the incoming signal disappears, scanning will resume in about five seconds.
 - On the SSB/CW and SSB-based Data modes, the scanner will pause on a received signal, then will step across the signal very slowly, giving you time to stop the scan, if you like. In these modes on the VFO, the scanner does not stop, however.
 - If the scan has paused on a signal, pressing the microphone’s **【UP】** or **【DOWN】** key will cause scanning to resume instantly.
 - If you rotate the **【Main】** Tuning Dial knob in the opposite direction from the current scanning direction (in other words, you rotate the dial to the left when scanning toward a higher frequency), the direction of the scan will reverse.

If you press the microphone’s PTT switch during scanning, the scanner will halt at once. Pressing the PTT switch during scanning will not cause transmission, however.

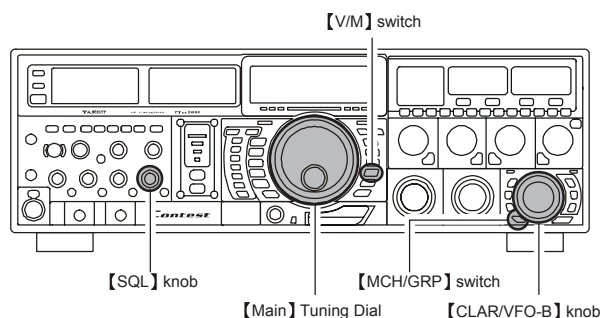

PACKET OPERATION

Packet operation is easily accomplished on the FT DX 9000 Contest by connecting your TNC (Terminal Node Controller) to the transceiver, per the illustration. “Packet” operation also applies to SSB-based AFSK data modes, such as PSK31, etc.

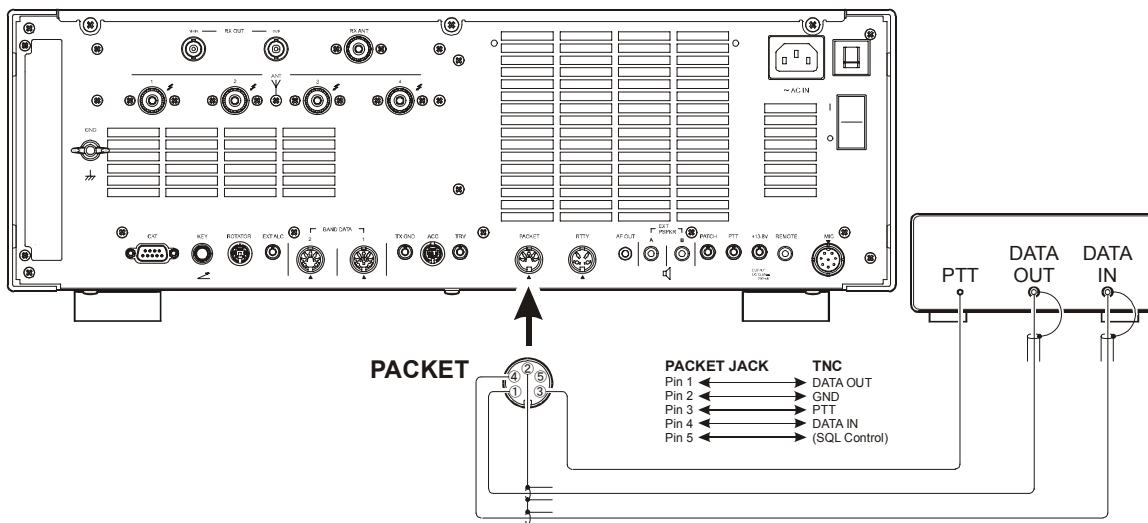

PACKET SETUP (INCLUDING SUBCARRIER FREQUENCY)

Before operation can commence, some basic setup procedures must be performed, using the Menu, to configure your radio for the data mode to be used.

Menu Mode	Setup
MODE-PKT 062 PKT DISP	0Hz
MODE-PKT 063 PKT GAIN	128
MODE-PKT 064 PKT SHIFT	1000Hz

BASIC SETUP

- Press the **【PKT】** Mode switch (#27).
 - For HF operation, SSB-based Data operation is generally used. One press of the **【PKT】** switch will engage Packet operation in the “LSB” mode (by default). Both the “PKT” and “LSB” LEDs will become illuminated.
 - If you need to do FM-based 1200-baud packet on the 29/50 MHz bands, press the **【PKT】** switch once more to engage the “PKT-FM” mode. The “PKT” and “FM” LEDs will both become illuminated.
- When the “transmit” command is received from the TNC, the transmitter of the FT DX 9000 Contest will automatically be engaged. Likewise, the command to return to receive will cause the radio to revert to the receive mode.
 - If you need to adjust the output level from the radio from the “DATA OUT” pin of the **【PACKET】** jack (pin 4), please do so at the TNC side. For the input level from the TNC, as applied to the DATA IN pin of the **【PACKET】** jack (pin 1), please use Menu item “No.063 MODE-PKT PKT GAIN.”
 - During Packet operation via the rear panel’s **【PACKET】** jack, the front and rear panel MIC jacks are both cut off, so you won’t have a “live microphone” problem during data operation.

【Note】

If you anticipate making data transmissions of longer than a few minutes, we recommend that you use the **【RF PWR】** control (#38) to reduce the transmitter power to 1/2 ~ 1/3 of its normal maximum.

【Quick Point】

PACKET Jack Specifications

- DATA IN (Pin 1)**
Input Level: 17mVrms
Input Impedance: 10 kOhms
- DATA OUT (Pin 4)**
Fixed level, does not respond to setting of **【AF GAIN】** or **【SQL】** control.)
Output Level: 700 mVp-p max.
Output Impedance: 10 kOhms

RTTY (RADIO TELETYPE) OPERATION

Most RTTY operation today is accomplished using a TNC or other computer-based system that utilizes AFSK tones. As such, the previous discussion on LSB-mode “Packet” operation will apply for Baudot operation, as well. For RTTY operation using a Terminal Unit (TU) or the “FSK” output from a TNC, please see the discussion below. See also the illustration for details regarding connection to your TU.

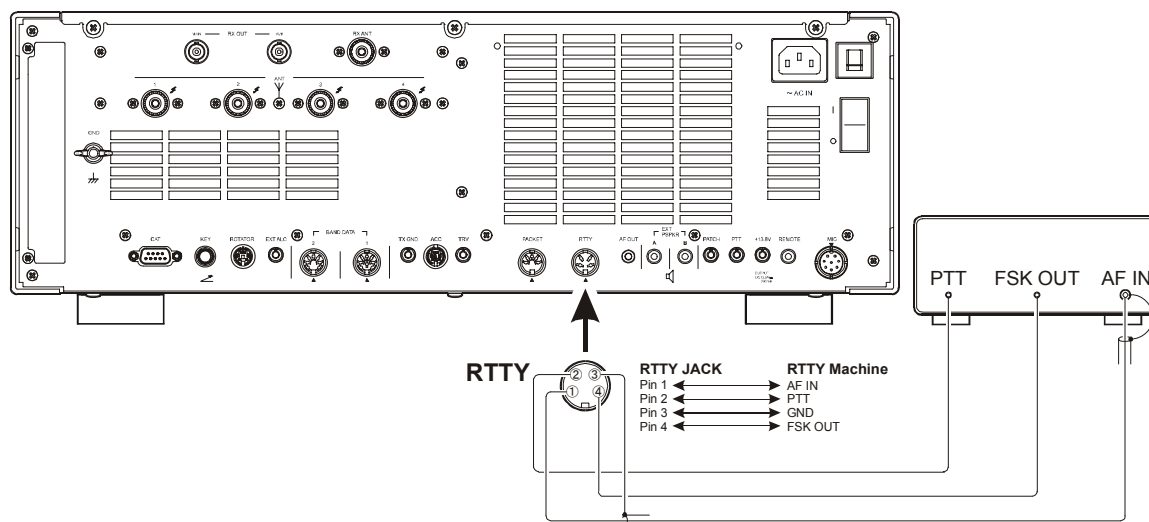

SETTING UP FOR RTTY OPERATION

Before commencing RTTY operation, please direct your attention to the setup steps below.

Menu Mode	Setup
MODE-RTY 065 POLARITY-R	NOR/REV
MODE-RTY 066 POLARITY-T	NOR/REV
MODE-RTY 067 RTTY SHIFT	170Hz
MODE-RTY 068 RTTY TONE	2125Hz

BASIC SETUP

- Press the **[RTTY]** Mode switch (#27) to enter the RTTY mode.
 - One press of the **[RTTY]** Mode switch will engage RTTY operation using “LSB” injection, which is generally used in the Amateur service. In this mode, both the “RTTY” and “LSB” LEDs will light up.
 - To switch to USB-side injection in RTTY, press the **[RTTY]** mode switch once more. Both the “RTTY” and “USB” LEDs will now be illuminated. Repeatedly pressing the **[RTTY]** button will toggle between LSB and USB injection on RTTY.
- When you begin typing on your TU or computer keyboard, the command to transmit should automatically be sent to the transceiver, causing it to enter the transmit mode.

『Note』

- If you anticipate making data transmissions of longer than a few minutes, we recommend that you use the **[RF PWR]** control (#38) to reduce the transmitter power to 1/2 ~ 1/3 of its normal maximum.

『Advice』

- There is no adjustment of the receiver output level from Pin 2 (“RX OUT”) of the **[RTTY]** jack on the rear panel; please make any needed level adjustments at the TU side.
- The Mark/Space Shift utilized in most Amateur RTTY operation is 170 Hz. Other shifts may be configured, however, using Menu item “**MODE-RTY 067 RTTY SHIFT**.”

- The FT DX 9000 Contest is set up for “high tone” operation (centered on 2125 Hz) by default, but you may configure it for low tone (1275 Hz) operation using Menu item “**MODE-RTY 068 RTTY TONE**.”
- You may find that you are unable to decode some RTTY stations, even if they are of sufficient signal strength. If this is observed, there may be a Mark/Space polarity problem between your station and the other station. If so, try setting Menu item “**MODE-RTY 065 POLARITY-R**” to “REV” (“Reverse”) to see if that permits copy. A separate Menu item permits reversal of your transmitter’s Mark/Space polarity: “**MODE-RTY 066 POLARITY-T**.”

『Quick Point』

In the FT DX 9000 Contest, “RTTY” is a mode defined as being an “FSK” mode, whereby the closing and opening of a keying line (to ground) causes the Mark/Space tones to alternate. The RTTY mode is not an AFSK based mode in this transceiver, and the AFSK output tones from a TNC will not cause Mark/Space shifting to occur. Use the “Packet” mode for AFSK-based Baudot and other data modes.

MISCELLANEOUS AFSK-BASED DATA MODES

The FT DX 9000 Contest may also be used for a host of other SSB-based Data modes. Please set up your system using the illustration as a guideline.

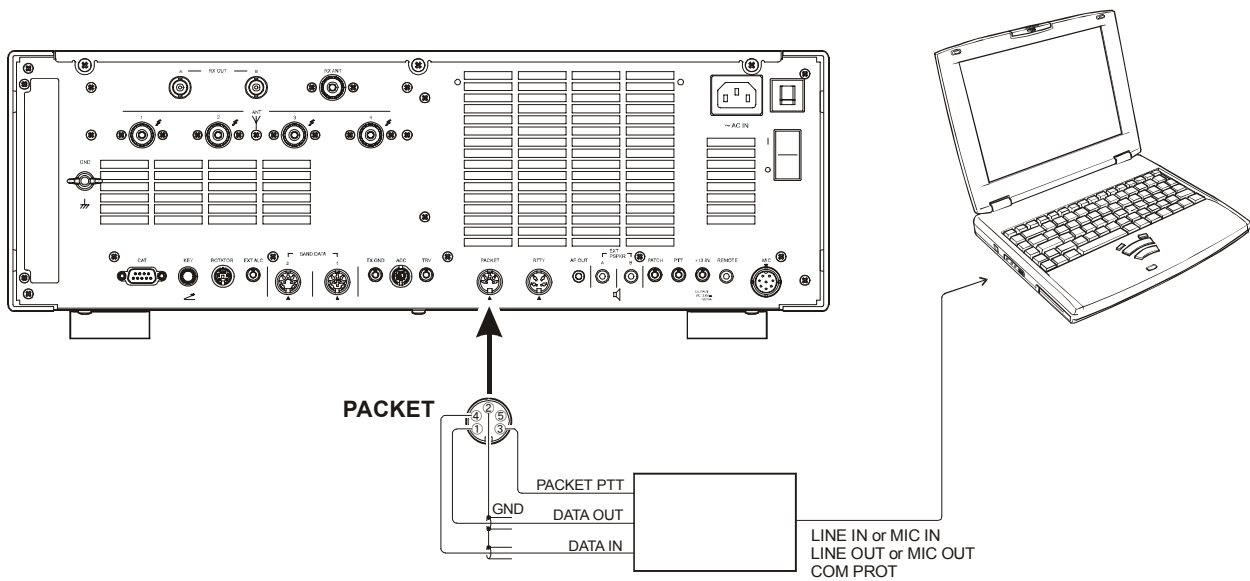

『Quick Point』

When you have configured Menu item “**TX GNRL 159 VOX SELECT**” to “DATA,” the transceiver will operate in a “VOX” mode, and it is not necessary to connect a “PTT” line. This makes for very convenient interfacing to computer Sound Cards, etc.

ABOUT THE TRANSVERTER OUTPUT TERMINAL

You may connect an after-market transverter to the rear panel's TRV (Transverter) jack. The output, at 28 MHz, is approximately -20 dBm (0.01 mW) at 50 Ohms.

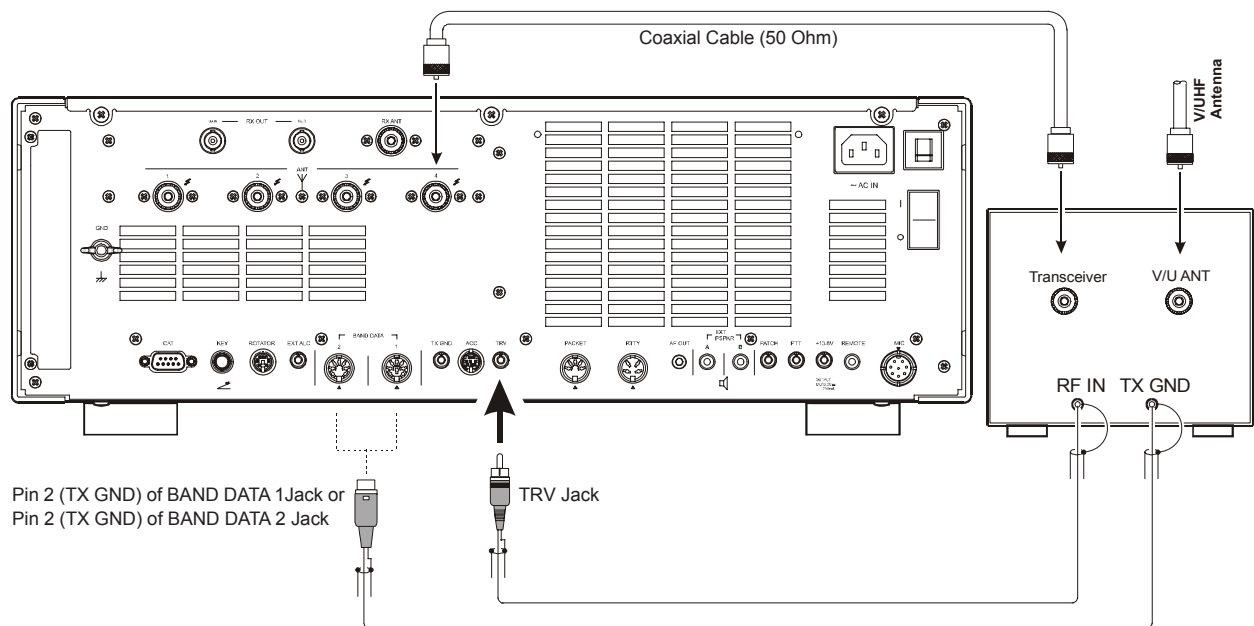

SETUP

1. Press the **[MNU]** key (#72) to enter the Menu mode (the LCD will change to Menu display).
2. Rotate the **[Main]** Tuning Dial knob (#34) to choose Menu item **"TUNING 135 MY BAND."**
3. Rotate the **[CLAR/VFO-B]** knob (#84) to find the Menu parameter **"TRV OFF"** (this is the factory default setting).
4. Press the **[ENT]** key (#63) to change the parameter to **"TRV ON"** (this will add this condition to your "My Band" list; see page 55).
5. Press and hold in the **[MNU]** key for at least two seconds to save the new setting and exit to normal operation.

OPERATION

1. Set up the frequency offset for transverter use, as described previously.
2. Rotate the **[Main]** Tuning Dial knob (#34) to set the desired operating frequency. Operation is basically unchanged from normal transceiver operation.

『Advice』

When the "TRV" mode is turned on, power output will not be allowed to pass to the [ANT1] ~ [ANT4] main antenna jacks. So one of these may be connected to your transverter's "RX" jack. Just be certain to disconnect the transverter when returning to HF operation, as the selected Antenna jack will now be capable of passing RF power.

Setting the Transverter Frequency Offset

You may set up the frequency display so that it shows the actual band on which your transverter is operating (instead of the "IF" used by the transverter, which is the 28 MHz band on your FT DX 9000Contest).

Example: Setting Up the FT DX 9000 Contest Display for Use with a 144 MHz Transverter

1. Connect the 144 MHz transverter to the transceiver.
2. Use the Menu mode to confirm that Menu item **"GENERAL 035 TRV OFFSET"** is set to "44" (the factory default setting).
3. Press the **[BAND/MHZ]** key (#81) momentarily, then rotate the **[CLAR/VFO-B]** knob (#84) so as to select "44.000000" on the display.
4. Press and hold in the **[MNU]** key (#72) for at least two seconds to save the new setting and exit.

The "100 MHz" digit of the frequency is not displayed, so when you are operating on 2 meters and see "45 MHz" on the frequency readout, this indicates "145 MHz" instead.

『Advice』

With the setup described above, tuning the operating range 28-29 MHz will correspond to an actual operating frequency of 144-145 MHz, with "44-45" being displayed on the front panel of the transceiver.

MENU MODE

The Menu system of the FT DX 9000 Contest provides extensive customization capability, so you can set up your transceiver just the way you want to operate it. The Menu items are grouped by general utilization category, and are numbered from “AGC 1” to “TX GNRL 160.”

USING THE MENU

1. Press the **【MNU】** key (#72) momentarily. The Menu list will appear on the LCD display, and you will see the Menu Number, Menu Groups, Menu Items, and the current settings for each item displayed on the LCD display.
2. Rotate the **【Main】** Tuning Dial (#34) to select the Menu item you wish to work on.
3. Rotate the **【CLAR/VFO-B】** knob (#84) to change the current setting of the selected Menu item.
4. When you have finished making your adjustments, press and hold in the **【MNU】** key (#72) for two seconds to save the new setting and exit to normal operation. If you only momentarily press the **【MNU】** key (#72), the new settings will not be retained.

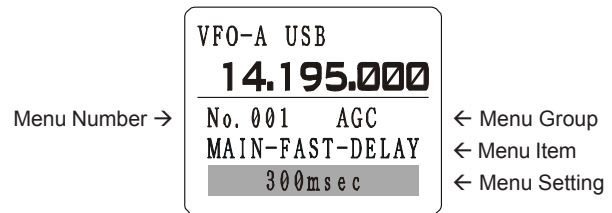
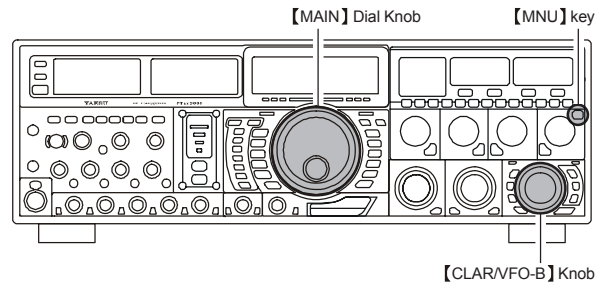

Menu Mode Reset

You may reset all the Menu settings to their original factory defaults, if desired.

1. Turn the front panel **【POWER】** switch (#5) off.
2. Press and hold in the **【MNU】** key (#72), and while holding it in, press the **【POWER】** switch (#5) to turn the transceiver back on. Now release the **【MNU】** key (#72).

MENU MODE

Groupe	No.	Menu Function	Available Values	Default Setting
AGC	001	MAIN-FAST-DELAY	20 ~ 4000 msec (20 msec Step)	300 msec
AGC	002	MAIN-FAST-HOLD	0 ~ 2000 msec (20 msec Step)	0 msec
AGC	003	MAIN-MID-DELAY	20 ~ 4000 msec (20 msec Step)	700 msec
AGC	004	MAIN-MID-HOLD	0 ~ 2000 msec (20 msec Step)	0 msec
AGC	005	MAIN-SLOW-DELAY	20 ~ 4000 msec (20 msec Step)	2000 msec
AGC	006	MAIN-SLOW-HOLD	0 ~ 2000 msec (20 msec Step)	0 msec
AGC	007	SUB-FAST-DELAY	20 ~ 4000 msec (20 msec Step)	300 msec
AGC	008	SUB-FAST-HOLD	0 ~ 2000 msec (20 msec Step)	0 msec
AGC	009	SUB-MID-DELAY	20 ~ 4000 msec (20 msec Step)	700 msec
AGC	010	SUB-MID-HOLD	0 ~ 2000 msec (20 msec Step)	0 msec
AGC	011	SUB-SLOW-DELAY	20 ~ 4000 msec (20 msec Step)	2000 msec
AGC	012	SUB-SLOW-HOLD	0 ~ 2000 msec (20 msec Step)	0 msec
DISPLAY	013	TFT COLOR	COOL BLUE / CONTRAST BLUE / FLASH WHITE / CONTRAST UMBER / UMBER	*
DISPLAY	014	DIMMER-METER	0 ~ 15	4
DISPLAY	015	DIMMER-VFD	0 ~ 15	8
DISPLAY	016	BAR DISPLAY SELECT	CLAR / CW TUNE / VRF- μ TUNE / NOTCH	CW TUNE
DISPLAY	017	ROTATOR START UP	0 / 90 / 180 / 270 (°)	0 (°)
DISPLAY	018	ROTATOR OFFSET ADJ	-30 ~ 0	0
DISPLAY	019	RIGHT TX METER	ALC / VDD	ALC
DISPLAY	020	QMB MARKER	ENABLE / DISABLE	ENABLE
FH-2 SET	021	BEACON TIME	OFF / 1 ~ 255 sec	OFF
FH-2 SET	022	CONTEST NUMBER	1290 / AUNO / AUNT / A2NO / A2NT / 12NO / 12NT	1290
FH-2 SET	023	CW MEMORY 1	TEXT / MESSAGE	MESSAGE
FH-2 SET	024	CW MEMORY 2	TEXT / MESSAGE	MESSAGE
FH-2 SET	025	CW MEMORY 3	TEXT / MESSAGE	MESSAGE
FH-2 SET	026	CW MEMORY 4	TEXT / MESSAGE	MESSAGE
FH-2 SET	027	CW MEMORY 5	TEXT / MESSAGE	MESSAGE
GENERAL	028	ANT SELECT	BAND / STACK	BAND
GENERAL	029	BEEP LEVEL	0 ~ 255	50
GENERAL	030	CAT RATE	4800 / 9600 / 38400 bps	4800 bps
GENERAL	031	MEM GROUP	ENABLE / DISABLE	DISABLE
GENERAL	032	QUICK SPLIT FREQ	-20 ~ 0 ~ 20 kHz (1kHz Step)	5 kHz
GENERAL	033	TIME OUT TIMER	OFF / 5 / 10 / 15 / 20 / 25 / 30 min	OFF
GENERAL	034	TRV OFFSET	30 ~ 49 MHz	44 MHz
GENERAL	035	μ -TUNE DIAL STEP	DIAL STEP-2 / DIAL STEP-1 / OFF	DIAL STEP-1
GENERAL	036	MIC SCAN	ENABLE / DISABLE	ENABLE
GENERAL	037	MIC SCAN RESUME	PAUSE / TIME	TIME
GENERAL	038	AF/RF DIAL SWAP	NORMAL / SWAP	NORMAL
MODE-AM	039	AM MIC GAIN	MCVR / 0 ~ 255	160
MODE-AM	040	AM MIC SELECT	FRONT / REAR / DATA / PC	FRONT
MODE-CW	041	F-KEYER TYPE	OFF / BUG / ELEKEY / ACS	ELEKEY
MODE-CW	042	F-CW KEYER	NOR / REV	NOR
MODE-CW	043	R-KEYER TYPE	OFF / BUG / ELEKEY / ACS	ELEKEY
MODE-CW	044	R-CW KEYER	NOR / REV	NOR
MODE-CW	045	CW AUTO MODE	OFF / 50M / ON	OFF
MODE-CW	046	CW BFO	USB / LSB / AUTO	USB
MODE-CW	047	CW BK-IN	SEMI / FULL	SEMI
MODE-CW	048	CW WAVE SHAPE	1 / 2 / 4 / 6 msec	4 msec
MODE-CW	049	CW WEIGHT	2.5 ~ 4.5	3.0
MODE-CW	050	CW FREQ DISPLAY	DIRECT FREQ / PITCH OFFSET	PITCH OFFSET
MODE-CW	051	PC KEYING	ENABLE / DISABLE	DISABLE
MODE-CW	052	QSK	15 / 20 / 25 / 30 msec	15 msec

*: Unmber Display Color: UNMBER, Light Blue Display Color: COOL BLUE

MENU MODE

Groupe	No.	Menu Function	Available Values	Default Setting
MODE-DAT	053	DATA IN SELECT	DATA / PC	DATA
MODE-DAT	054	DATA GAIN	0 ~ 255	128
MODE-DAT	055	DATA OUT	VFO-a / VFO-b	VFO-a
MODE-DAT	056	DATA VOX DELAY	30 ~ 3000 msec	300 msec
MODE-DAT	057	DATA VOX GAIN	0 ~ 255	128
MODE-FM	058	FM MIC GAIN	MCVR / 0 ~ 255	128
MODE-FM	059	FM MIC SELECT	FRONT / REAR / DATA / PC	FRONT
MODE-FM	060	RPT SHIFT(28MHz)	0 ~ 1000 kHz (10 kHz Step)	100 kHz
MODE-FM	061	RPT SHIFT(50MHz)	0 ~ 4000 kHz (10 kHz Step)	1000 kHz
MODE-PKT	062	PKT DISP	-3000 ~ 0 ~ 3000Hz (10 Hz Step)	0 Hz
MODE-PKT	063	PKT GAIN	0 ~ 255	128
MODE-PKT	064	PKT SHIFT	-3000 ~ 0 ~ 3000Hz (10 Hz Step)	1000 Hz
MODE-RTY	065	POLARITY-R	NOR / REV	NOR
MODE-RTY	066	POLARITY-T	NOR / REV	NOR
MODE-RTY	067	RTTY SHIFT	170 / 200 / 425 / 850 Hz	170 Hz
MODE-RTY	068	RTTY TONE	1275 / 2125 Hz	2125 Hz
MODE-SSB	069	SSB MIC SELECT	FRONT / REAR / DATA / PC	FRONT
MODE SSB	070	SSB-TX-BPF	50-3000 / 100-2900 / 200-2800 / 300-2700 / 400-2600 (Hz) / 3000WB	300-2700 (Hz)
MODE-SSB	071	LSB RX-CARRIER	-200 ~ 0 ~ 200 Hz (10Hz Step)	0Hz
MODE-SSB	072	LSB TX-CARRIER	-200 ~ 0 ~ 200 Hz (10Hz Step)	0Hz
MODE-SSB	073	USB RX-CARRIER	-200 ~ 0 ~ 200 Hz (10Hz Step)	0Hz
MODE-SSB	074	USB TX-CARRIER	-200 ~ 0 ~ 200 Hz (10Hz Step)	0Hz
RXAUDIO	075	AGC-SLOPE	NORMAL / SLOPE	NORMAL
RXAUDIO	076	HEADPHONE MIX	SEPARATE / COMBINE-1 / COMBINE-2	COMBINE-2
RXAUDIO	077	SPEAKER OUT	SEPARATE / COMBINE	COMBINE
RX DSP	078	MAIN-CONTOUR-LEVEL	-40 ~ 0 ~ 20	-15
RX DSP	079	MAIN-CONTOUR-WIDTH	1 ~ 11	10
RX DSP	080	SUB-CONTOUR-LEVEL	-40 ~ 0 ~ 20	-15
RX DSP	081	SUB-CONTOUR-WIDTH	1 ~ 11	10
RX DSP	082	IF-NOTCH-WIDTH	NARROW / WIDE	WIDE
RX DSP	083	MAIN-CW-SHAPE	SOFT / SHARP	SHARP
RX DSP	084	MAIN-CW-SLOPE	STEEP / MEDIUM / GENTLE	MEDIUM
RX DSP	085	MAIN-CW-NARROW	25 / 50 / 100 / 200 / 300 / 400 (Hz)	300 (Hz)
RX DSP	086	MAIN-PSK-SHAPE	SOFT / SHARP	SHARP
RX DSP	087	MAIN-PSK-SLOPE	STEEP / MEDIUM / GENTLE	MEDIUM
RX DSP	088	MAIN-PSK-NARROW	25 / 50 / 100 / 200 / 300 / 400 (Hz)	300 (Hz)
RX DSP	089	MAIN-RTTY-SHAPE	SOFT / SHARP	SHARP
RX DSP	090	MAIN-RTTY-SLOPE	STEEP / MEDIUM/GENTLE	MEDIUM
RX DSP	091	MAIN-RTTY-NARROW	25 / 50 / 100 / 200 / 300 / 400 (Hz)	300 (Hz)
RX DSP	092	MAIN-SSB-SHAPE	SOFT / SHARP	SHARP
RX DSP	093	MAIN-SSB-SLOPE	STEEP / MEDIUM / GENTLE	MEDIUM
RX DSP	094	MAIN-SSB-NARROW	200 / 400 / 600 / 850 / 1100 / 1350 / 1500 / 1650 / 1800 / 1950 / 2100 / 2250 (Hz)	1800 (Hz)
RX DSP	095	SUB-CW-SHAPE	SOFT / SHARP	SHARP
RX DSP	096	SUB-CW-SLOPE	STEEP / MEDIUM / GENTLE	MEDIUM
RX DSP	097	SUB-CW-NARROW	25 / 50 / 100 / 200 / 300 / 400 (Hz)	300 (Hz)
RX DSP	098	SUB-PSK-SHAPE	SOFT / SHARP	SHARP
RX DSP	099	SUB-PSK-SLOPE	STEEP / MEDIUM / GENTLE	MEDIUM
RX DSP	100	SUB-PSK-NARROW	25 / 50 / 100 / 200 / 300 / 400 (Hz)	300 (Hz)
RX DSP	101	SUB-RTTY-SHAPE	SOFT / SHARP	SHARP
RX DSP	102	SUB-RTTY-SLOPE	STEEP / MEDIUM / GENTLE	MEDIUM
RX DSP	103	SUB-RTTY-NARROW	25 / 50 / 100 / 200 / 300 / 400 (Hz)	300 (Hz)
RX DSP	104	SUB-SSB-SHAPE	SOFT / SHARP	SHARP
RX DSP	105	SUB-SSB-SLOPE	STEEP / MEDIUM / GENTLE	MEDIUM

Groupe	No.	Menu Function	Available Values	Default Setting
RX DSP	106	SUB-SSB-NARROW	200 / 400 / 600 / 850 / 1100 / 1350 / 1500 / 1650 / 1800 / 1950 / 2100 / 2250 (Hz)	1800 (Hz)
SCOPE	107	MAIN FIX 1.8MHz	1800 ~ 1999 kHz	1800kHz
SCOPE	108	MAIN FIX 3.5MHz	3500 ~ 3999 kHz	3500kHz
SCOPE	109	MAIN FIX 5.0MHz	5250 ~ 5499 kHz	5250kHz
SCOPE	110	MAIN FIX 7.0MHz	7000 ~ 7299 kHz	7000kHz
SCOPE	111	MAIN FIX 10MHz	10100 ~ 10149 kHz	10100kHz
SCOPE	112	MAIN FIX 14MHz	14000 ~ 14349 kHz	14000kHz
SCOPE	113	MAIN FIX 18MHz	18000 ~ 18199 kHz	18068kHz
SCOPE	114	MAIN FIX 21MHz	21000 ~ 21449 kHz	21000kHz
SCOPE	115	MAIN FIX 24MHz	24800 ~ 24989 kHz	24890 kHz
SCOPE	116	MAIN FIX 28MHz	28000 ~ 29699 kHz	28000 kHz
SCOPE	117	MAIN FIX 50MHz	50000 ~ 53999 kHz	50000 kHz
SCOPE	118	SUB FIX 1.8MHz	1800 ~ 1999 kHz	1800 kHz
SCOPE	119	SUB FIX 3.5MHz	3500 ~ 3999 kHz	3500 kHz
SCOPE	120	SUB FIX 5.0MHz	5250 ~ 5499 kHz	5250 kHz
SCOPE	121	SUB FIX 7.0MHz	7000 ~ 7299 kHz	7000 kHz
SCOPE	122	SUB FIX 10MHz	10100 ~ 10149 kHz	10100 kHz
SCOPE	123	SUB FIX 14MHz	14000 ~ 14349kHz	14000 kHz
SCOPE	124	SUB FIX 18MHz	18000 ~ 18199 kHz	18068 kHz
SCOPE	125	SUB FIX 21MHz	21000 ~ 21449 kHz	21000 kHz
SCOPE	126	SUB FIX 24MHz	24800 ~ 24989 kHz	24890 kHz
SCOPE	127	SUB FIX 28MHz	28000 ~ 29699kHz	28000 kHz
SCOPE	128	SUB FIX 50MHz	50000 ~ 53999 kHz	50000 kHz
TUNING	129	MAIN DIAL STEP	1 / 10 Hz	10 Hz
TUNING	130	MAIN DIAL CW FINE	DISABLE / ENABLE	DISABLE
TUNING	131	1MHz/100kHz SELECT	1MHz / 100kHz	1 MHz
TUNING	132	AM CH STEP	2.5 / 5 / 9 / 10 / 12.5 kHz	5 kHz
TUNING	133	FM CH STEP	5 / 6.25 / 10 / 12.5 / 25 kHz	5 kHz
TUNING	134	FM DIAL STEP	10Hz / 100 Hz	100 Hz
TUNING	135	MY BAND	1.8 ~ 50 (MHz) / GEN / TRV	---
TXAUDIO	136	F-PRMTRC EQ1-FREQ	OFF / 100 / 200 / 300 / 400 / 500 / 600 / 700 (Hz)	OFF
TXAUDIO	137	F-PRMTRC EQ1-LEVEL	-10 ~ 0 ~ 10	5
TXAUDIO	138	F-PRMTRC EQ1-BWTH	1 ~ 10	10
TXAUDIO	139	F-PRMTRC EQ2-FREQ	OFF / 700 / 800 / 900 / 1000 / 1100 / 1200 / 1300 / 1400 / 1500 (Hz)	OFF
TXAUDIO	140	F-PRMTRC EQ2-LEVEL	-10 ~ 0 ~ 10	5
TXAUDIO	141	F-PRMTRC EQ2-BWTH	1 ~ 10	10
TXAUDIO	142	F-PRMTRC EQ3-FREQ	OFF/1500 ~ 3200 (100Hz Step)	OFF
TXAUDIO	143	F-PRMTRC EQ3-LEVEL	-10 ~ 0 ~ 10	5
TXAUDIO	144	F-PRMTRC EQ3-BWTH	1 ~ 10	10
TXAUDIO	145	R-PRMTRC EQ1-FREQ	OFF / 100 / 200 / 300 / 400 / 500 / 600 / 700 (Hz)	OFF
TXAUDIO	146	R-PRMTRC EQ1-LEVEL	-10 ~ 0 ~ 10	5
TXAUDIO	147	R-PRMTRC EQ1-BWTH	1 ~ 10	10
TXAUDIO	148	R-PRMTRC EQ2-FREQ	OFF / 700 / 800 / 900 / 1000 / 1100 / 1200 / 1300 / 1400 / 1500 (Hz)	OFF
TXAUDIO	149	R-PRMTRC EQ2-LEVEL	-10 ~ 0 ~ 10	5
TXAUDIO	150	R-PRMTRC EQ2-BWTH	1 ~ 10	10
TXAUDIO	151	R-PRMTRC EQ3-FREQ	OFF / 1500 ~ 3200 (Hz) (100Hz Step)	OFF
TXAUDIO	152	R-PRMTRC EQ3-LEVEL	-10 ~ 0 ~ 10	5
TXAUDIO	153	R-PRMTRC EQ3-BWTH	1 ~ 10	10
TXGNRL	154	TX MAX POWER	10 / 50 / 100 / 200 (W)	200 (W)

MENU MODE

Groupe	No.	Menu Function	Available Values	Default Setting
TXGNRL	155	TX PWR CONTROL	ALL MODE / CARRIER	ALL MODE
TXGNRL	156	EXT AMP TX-GND	ENABLE / DISABLE	DISABLE
TXGNRL	157	EXT AMP TUNING PWR	10 / 50 / 100 / 200 (W)	100 (W)
TXGNRL	158	FULL DUPLEX	SIMP / DUP	SIMP
TXGNRL	159	VOX SELECT	MIC / DATA	MIC
TXGNRL	160	EMERGENCY FREQ TX	DISABLE / ENABLE	DISABLE

AGC GROUP

001. MAIN-FAST-DELAY

Function: Sets the delay time for the AGC FAST mode of the main band (VFO-A) receiver.

Available Values: 20 ~ 4000 msec (20 msec/step)

Default Setting: 300 msec

002. MAIN-FAST-HOLD

Function: Sets the hang time of the AGC peak voltage for the AGC FAST mode of the main band (VFO-A) receiver.

Available Values: 0 ~ 2000 msec (20 msec/step)

Default Setting: 0 msec

003. MAIN-MID-DELAY

Function: Sets the delay time for the AGC MID mode of the main band (VFO-A) receiver.

Available Values: 20 ~ 2000 msec (20 msec/step)

Default Setting: 700 msec

004. MAIN-MID-HOLD

Function: Sets the hang time of the AGC peak voltage for the AGC MID mode of the main band (VFO-A) receiver.

Available Values: 0 ~ 2000 msec (20 msec/step)

Default Setting: 0 msec

005. MAIN-SLOW-DELAY

Function: Sets the delay time for the AGC SLOW mode of the main band (VFO-A) receiver.

Available Values: 20 ~ 4000 msec (20 msec/step)

Default Setting: 2000 msec

006. MAIN-SLOW-HOLD

Function: Sets the hang time of the AGC peak voltage for the AGC SLOW mode of the main band (VFO-A) receiver.

Available Values: 0 ~ 2000 msec (20 msec/step)

Default Setting: 0 msec

007. SUB-FAST-DELAY

Function: Sets the delay time for the AGC FAST mode of the sub band (VFO-B) receiver.

Available Values: 20 ~ 4000 msec (20 msec/step)

Default Setting: 300 msec

Explanation: When the Dual Receive Unit (RXU-9000) is installed, once the input signal falls below the AGC threshold, it is possible to configure the AGC decay time in 20 ms steps.

Advice: If the Dual Receiver Unit (RXU-9000) is not installed, changing this setting will have no effect.

008. SUB-FAST-HOLD

Function: Sets the hang time of the AGC peak voltage for the AGC FAST mode of the sub band (VFO-B) receiver.

Available Values: 0 ~ 2000 msec (20 msec/step)

Default Setting: 0 msec

Explanation: When the Dual Receive Unit (RXU-9000) is installed, once the input signal falls below the AGC threshold, it is possible to configure the AGC decay time in 20 ms steps.

Advice: If the Dual Receiver Unit (RXU-9000) is not installed, changing this setting will have no effect.

009. SUB-MID-DELAY

Function: Sets the delay time for the AGC MID mode of the sub band (VFO-B) receiver.

Available Values: 20 ~ 4000 msec (20 msec/step)

Default Setting: 700 msec

Explanation: When the Dual Receive Unit (RXU-9000) is installed, once the input signal falls below the AGC threshold, it is possible to configure the AGC decay time in 20 ms steps.

Advice: If the Dual Receiver Unit (RXU-9000) is not installed, changing this setting will have no effect.

AGC GROUP

010. SUB-MID-HOLD

Function: Sets the hang time of the AGC peak voltage for the AGC MID mode of the sub band (VFO-B) receiver.

Available Values: 0 ~ 2000 msec (20 msec/step)
Default Setting: 0 msec

Explanation: When the Dual Receive Unit (**RXU-9000**) is installed, once the input signal falls below the AGC threshold, it is possible to configure the AGC decay time in 20 ms steps.

Advice: If the Dual Receiver Unit (**RXU-9000**) is not installed, changing this setting will have no effect.

011. SUB-SLOW-DELAY

Function: Sets the delay time for the AGC SLOW mode of the sub band (VFO-B) receiver.

Available Values: 20 ~ 4000 msec (20 msec/step)
Default Setting: 2000 msec

Explanation: When the Dual Receive Unit (**RXU-9000**) is installed, once the input signal falls below the AGC threshold, it is possible to configure the AGC decay time in 20 ms steps.

Advice: If the Dual Receiver Unit (**RXU-9000**) is not installed, changing this setting will have no effect.

012. SUB-SLOW-HOLD

Function: Sets the hang time of the AGC peak voltage for the AGC SLOW mode of the sub band (VFO-B) receiver.

Available Values: 0 ~ 2000 msec (20 msec/step)
Default Setting: 0 msec

Explanation: When the Dual Receive Unit (**RXU-9000**) is installed, once the input signal falls below the AGC threshold, it is possible to configure the AGC decay time in 20 ms steps.

Advice: If the Dual Receiver Unit (**RXU-9000**) is not installed, changing this setting will have no effect.

DISPLAY GROUP

013. TFT COLOR

Function: Selects the TFT color.

Available Values: COOL BLUE/CONTRAST BLUE/
FLASH WHITE/UMBER/CONTRAST UMBER

Default Setting: COOL BLUE

Explanation: When the optional TFT Display Unit (**TFT-9000**) is installed, you may set the TFT display color.

Advice: If the optional TFT Display Unit (**TFT-9000**) is not installed, this adjustment has no effect unless you are using an external display in conjunction with the optional Data Management Unit (**DMU-9000**).

014. DIMMER-METER

Function: Setting of the meter brightness level when "DIM" is selected.

Available Values: 0 ~ 15

Default Setting: 4

Explanation: The Dimmer may be used to set the brightness level of the LCD and the analog meters. Higher numerical values indicate more dimming (i.e. a darker display). When the optional TFT Display Unit (**TFT-9000**) is installed, the brightness level of the TFT will also be affected by this adjustment.

015. DIMMER-VFD

Function: Setting of the frequency and TFT display brightness level when "DIM" is selected.

Available Values: 0 ~ 15

Default Setting: 8

016. BAR DISPLAY SELECT

Function: Selects one of three parameters to be viewed on the Tuning Offset Indicator.

Available Values: CLAR/CW TUNE/VRF- μ TUNE/
NOTCH

Default Setting: CW TUNE

CLAR: Displays relative clarifier offset.

CW TUNE: Displays relative tuning offset between the incoming signal and transmitted frequency.

VRF- μ TUNE: Displays the peak position of the VRF or μ TUNE filter.

NOTCH: While you rotate the **[NOTCH]** knob, the center frequency of the IF NOTCH feature will be indicated.

DISPLAY GROUP

017. ROTATOR START UP

Function: Selects the starting point of your controller's indicator needle.

Available Values: 0/90/180/270°

Default Setting: 0°

018. ROTATOR OFFSET ADJ

Function: Adjusts the indicator needle precisely to the starting point set in menu selection 123.

Available Values: -30 - 0

Default Setting: 0

019. RIGHT TX METER

Function: Selects the Sub meter function

Available Values: ALC/VDD

Default Setting: ALC

ALC: Indicates incoming signal strength on the sub band (VFO-B) while receiving, and indicates the ALC (Automatic Level Control) operating range while transmitting.

VDD: Indicates the Vdd (final amplifier drain voltage) at all times.

020. QMB MARKER

Function: Enables/Disable the QMB Maker (White arrow "▽") to display on the Spectrum Band Scope.

Available Values: ENABLE/DISABLE

Default Setting: ENABLE

Advice: If the optional Data Management Unit (**DMU-9000**) is not installed, this selection has no effect unless you are using an external display in conjunction with the **DMU-9000**.

FH-2 SETUP GROUP

021. BEACON TIME

Function: Sets the interval time between repeats of the beacon message.

Available Values: OFF/1 ~ 255 sec

Default Setting: OFF

022. CONTEST NUMBER

Function: Selects the Contest Number "Cut" format for imbedded contest number.

Available Values: 1290/AUNO/AUNT/A2NO/A2NT/12NO/12NT

Default Setting: 1290

1290: Does not abbreviate the Contest Number

AUNO: Abbreviates to "A" for "One," "U" for "Two," "N" for "Nine," and "O" for "Zero."

AUNT: Abbreviates to "A" for "One," "U" for "Two," "N" for "Nine," and "T" for "Zero."

A2NO: Abbreviates to "A" for "One," "N" for "Nine," and "O" for "Zero."

A2NT: Abbreviates to "A" for "One," "N" for "Nine," and "T" for "Zero."

12NO: Abbreviates to "N" for "Nine" and "O" for "Zero."

12NT: Abbreviates to "N" for "Nine" and "T" for "Zero."

023. CW MEMORY 1

Function: Permits entry of the CW message for message register 1.

Available Values: TEXT/MESSAGE

Default Setting: MESSAGE

TEXT: You may enter the CW message from a supplied **FH-2** Remote Control Keypad.

MESSAGE: You may enter the CW message from the CW keyer.

024. CW MEMORY 2

Function: Permits entry of the CW message for message register 2.

Available Values: TEXT/MESSAGE

Default Setting: MESSAGE

TEXT: You may enter the CW message from a supplied **FH-2** Remote Control Keypad.

MESSAGE: You may enter the CW message from the CW keyer.

025. CW MEMORY 3

Function: Permits entry of the CW message for message register 3.

Available Values: TEXT/MESSAGE

Default Setting: MESSAGE

TEXT: You may enter the CW message from a supplied **FH-2** Remote Control Keypad.

MESSAGE: You may enter the CW message from the CW keyer.

FH-2 SETUP GROUP

026. CW MEMORY 4

Function: Permits entry of the CW message for message register 4.

Available Values: TEXT/MESSAGE

Default Setting: MESSAGE

TEXT: You may enter the CW message from a supplied **FH-2** Remote Control Keypad.

MESSAGE: You may enter the CW message from the CW keyer.

027. CW MEMORY 5

Function: Permits entry of the CW message for message register 5.

Available Values: TEXT/MESSAGE/COUNTUP

Default Setting: MESSAGE

TEXT: You may enter the CW message from a supplied **FH-2** Remote Control Keypad.

MESSAGE: You may enter the CW message from the CW keyer.

GENERAL GROUP

028. ANT SELECT

Function: Sets the method of antenna selection.

Available Values: BAND/STACK

Default Setting: BAND

BAND: The antenna is selected in accordance with the operating band.

STACK: The antenna is selected in accordance with the band stack (different antennas may be utilized on the same band, if so selected in the band stack).

029. BEEP LEVEL

Function: Sets the beep level.

Available Values: 0 ~ 255

Default Setting: 50

030. CAT RATE

Function: Sets the transceiver's computer-interface circuitry for the CAT baud rate to be used.

Available Values: 4800/9600/38400 bps

Default Setting: 4800 bps

031. MEM GROUP

Function: Enables/Disables Memory Group Operation.

Available Values: DISABLE/ENABLE

Default Setting: DISABLE

032. QUICK SPLIT FREQ

Function: Selects the tuning offset for the Quick Split feature.

Available Values: -20 ~ 0 ~ +20 kHz (1 kHz Step)

Default Setting: +5 kHz

Explanation: When the front panel **[SPLIT]** key (#30) is pushed for two seconds, VFO-B will be set to the pro-programmed offset with respect to the VFO-A frequency.

033. TIME OUT TIMER

Function: Sets the Time-Out Timer countdown time.

Available Values: OFF/5/10/15/20/25/30 min

Default Setting: OFF

The Time-Out Timer shuts off the transmitter after continuous transmission of the programmed time.

034. TRV OFFSET

Function: Set the 10's and 1's of the MHz digits display for operation with a transverter.

Available Values: 30 ~ 49 MHz

Default Setting: 44 MHz

If you connect a 430 MHz transverter to the radio, set this menu to "30" (the "100 MHz" digits are hidden on this radio).

GENERAL GROUP

035. μ TUNE DIAL STEP

Function: Select the μ -TUNE mode.

Available Values: DIAL STEP-1/DIAL STEP-2/OFF

Default Setting: DIAL STEP-1

Explanation: If the RF μ -Tuning Unit is installed, the installation may change the setting of this Menu item.

DIAL STEP-1: Activates the μ -TUNE system in the Auto mode using “**FINE**” steps of the μ -TUNE knob (1 step/click) on the 14 MHz and lower amateur bands on the main band (VFO-A).

DIAL STEP-2: Activates the μ -TUNE system in the Auto mode using “**COARSE**” steps of the μ -TUNE knob (2 steps/click) on the 7 MHz and lower amateur bands. On the 10/14 MHz bands, “**FINE**” μ -TUNE knob steps will be used (1 step/click).

OFF: Disables the μ -TUNE system. Activates the VRF feature on the 14 MHz and lower amateur bands on the main band (VFO-A).

Advice: If none of the RF μ -Tuning Units is installed, changing this Menu setting will have no effect.

036. MIC SCAN

Function: Enables/disables scanning access via the microphone’s [UP]/[DWN] keys (only available at the rear panel’s MIC Jack).

Available Values: ENABLE/DISABLE

Default Setting: ENABLE

037. MIC SCAN RESUME

Function: Selects the Scan Resume mode.

Available Values: PAUSE/TIME

Default Setting: TIME

PAUSE: The scanner will hold until the signal disappears, then will resume after one second.

TIME: The scanner will hold for five seconds, then resume whether or not the other station is still transmitting.

038. AF/RF DIAL SWAP

Function: Reverses the functions of the **AF GAIN** (VFO-B) and **RF GAIN** (VFO-A) knobs.

Available Values: NORMAL/SWAP

Default Setting: NORMAL

Explanation: When the optional Dual Receive Unit (**RXU-9000**) is installed, you may swap the functions of the RF and AF Gain controls for the Main and Sub VFOs, so as to have both the Main and Sub VFOs’ AF Gain controls on the same shaft.

When this menu is set to “**SWAP**,” you may adjust the sub (VFO-B) receiver audio using the large **RF GAIN** (VFO-A) knob and adjust the main (VFO-A) receiver RF gain using the small **AF GAIN** (VFO-B) knob. This puts both “Volume” controls on the same shaft.

MODE-AM GROUP

039. AM MIC GAIN

Function: Sets the microphone gain for the AM mode.

Available Values: MCVR/0 ~ 255 (FIX)

Default Setting: 160

When this menu is set to “**MCVR**,” you may adjust the microphone gain using the front panel’s **MIC** knob.

040. AM MIC SELECT

Function: Selects the microphone to be used on the AM mode.

Available Values: FRONT/REAR/DATA/PC

Default Setting: FRONT

FRONT: Selects the microphone connected to the front panel’s **MIC** jack while using the AM mode.

REAR: Selects the microphone connected to the rear panel’s **MIC** jack while using the AM mode.

DATA: Selects the microphone connected to pin 1 of the **PACKET** Jack while using the AM mode.

PC: Selects the microphone connected to the rear panel’s **AUDIO IN** 3.5-mm jack while using the AM mode. The optional Data Management Unit (**DMU-9000**) is required for this to be effective.

MODE-CW GROUP

041. F-KEYER TYPE

Function: Selects the desired keyer operation mode for the device connected to the front panel's **KEY** jack.

Available Values: OFF/BUG/ELEKEY/ACS

Default Setting: ELEKEY

OFF: Disables the front panel's keyer ("straight key" mode for use with external keyer or computer-driven keying interface).

BUG: Mechanical "bug" keyer emulation. One paddle produces "dits" automatically, while the other paddle manually produces "dahs."

ELEKEY: Iambic keyer with ACS (Automatic Character Spacing) disabled.

ACS: Iambic keyer with ACS (Automatic Character Spacing) enabled.

042. F-CW KEYER

Function: Selects the keyer paddle's wiring configuration of the **KEY** jack on the front panel.

Available Values: NOR/REV

Default Setting: NOR

NOR: Tip = Dot, Ring = Dash, Shaft = Ground

REV: Tip = Dash, Ring = Dot, Shaft = Ground

043. R-KEYER TYPE

Function: Select the desired keyer operation mode for the device connected to the rear panel's **KEY** jack.

Available Values: OFF/BUG/ELEKEY/ACS

Default Setting: ELEKEY

OFF: Disables the front panel's keyer ("straight key" mode for use with external keyer or computer-driven keying interface).

BUG: Mechanical "bug" keyer emulation. One paddle produces "dits" automatically, while the other paddle manually produces "dahs."

ELEKEY: Iambic keyer with ACS (Automatic Character Spacing) disabled.

ACS: Iambic keyer with ACS (Automatic Character Spacing) enabled.

044. R-CW KEYER

Function: Selects the keyer paddle's wiring configuration of the **KEY** jack on the rear panel.

Available Values: NOR/REV

Default Setting: NOR

NOR: Tip = Dot, Ring = Dash, Shaft = Ground

REV: Tip = Dash, Ring = Dot, Shaft = Ground

045. CW AUTO MODE

Function: Enables/disables CW keying while operating on SSB.

Available Values: OFF/50MHz/ON

Default Setting: OFF

OFF: Disables CW keying while operating on SSB.

50MHz: Enables CW keying only while operating SSB on 50 MHz (but not HF).

ON: Enables CW keying while operating on SSB (all TX bands).

Note: This feature allows you to move someone from SSB to CW *without having* to change modes on the front panel.

046. CW BFO

Function: Sets the CW carrier oscillator injection side for the CW mode.

Available Values: USB/LSB/AUTO

Default Setting: USB

USB: Injects the CW carrier oscillator on the USB side.

LSB: Injects the CW carrier oscillator on the LSB side.

AUTO: Injects the CW carrier oscillator on the LSB side while operating on the 7 MHz band and below, and the USB side while operating on the 10 MHz band and up.

047. CW BK-IN

Function: Sets the CW "break-in" mode.

Available Values: SEMI/FULL

Default Setting: SEMI

SEMI: The transceiver will operate in the semi break-in mode. The delay (receiver recovery) time is set by the front panel's **CW DELAY** knob.

FULL: The transceiver will operate in the full break-in (QSK) mode.

048. CW WAVE SHAPE

Function: Selects the CW carrier wave-form shape (rise/fall times).

Available Values: 1/2/4/6 msec

Default Setting: 4 msec

049. CW WEIGHT

Function: Sets the Dot:Dash ratio for the built-in electronic keyer.

Available Values: (1:) 2.5 ~ 4.5

Default Setting: 3.0

MODE-CW GROUP

050. CW FREQ DISPLAY

Function: Frequency Display Format for the CW mode.

Available Values: DIRECT FREQ/PITCH OFFSET

Default Setting: PITCH OFFSET

DIRECT FREQ: Displays the receiver carrier frequency, without any offset added. When changing modes between SSB and CW, the frequency display remains constant.

PITCH OFFSET: This frequency display reflects the added BFO offset.

051. PC KEYING

Function: Enables/disables CW keying from the "DATA IN" terminal on the rear panel's **PACKET** jack while operating on the CW mode.

Available Values: DISABLE/ENABLE

Default Setting: DISABLE

052. QSK

Function: Selects the time delay between when the PTT is keyed and the carrier is transmitted during QSK operation when using the internal keyer.

Available Values: 15/20/25/30 msec

Default Setting: 15 msec

MODE-DAT GROUP

053. DATA IN SELECT

Function: Selects the data input to be used on the PKT mode.

Available Values: DATA/PC

Default Setting: DATA

DATA: Uses the data input line which is connected to the rear panel's **PACKET** jack while using the PKT mode.

PC: Uses the data input line which is connected to the rear panel's **AUDIO IN** jack while using the PKT mode. The optional Data Management Unit (**DMU-9000**) is required for this to be effective.

054. DATA GAIN

Function: Sets the data input level from the TNC to the AFSK modulator.

Available Values: 0 ~ 255

Default Setting: 128

055. DATA OUT

Function: Selects the receiver to be connected to the data output port (pin 4) of the **PACKET** jack.

Available Values: VFO-a/VFO-b

Default Setting: VFO-a

056. DATA VOX DELAY

Function: Adjusts the "VOX" delay (receiver recovery) time on the PKT mode.

Available Values: 30 ~ 3000 msec

Default Setting: 300 msec

057. DATA VOX GAIN

Function: Adjusts the "VOX" gain on the PKT mode.

Available Values: 0 ~ 255

Default Setting: 128

MODE-FM GROUP

058. FM MIC GAIN

Function: Sets the microphone gain for the FM mode.

Available Values: MCVR/0 ~ 255 (FIX)

Default Setting: 128

When this menu is set to "MCVR," you may adjust the microphone gain using the front panel's **MIC** knob.

059. FM MIC SELECT

Function: Selects the microphone to be used on the FM mode.

Available Values: FRONT/REAR/DATA/PC

Default Setting: FRONT

FRONT: Selects the microphone connected to the front panel's **MIC** jack while using the FM mode.

REAR: Selects the microphone connected to the rear panel's **MIC** jack while using the FM mode.

DATA: Selects the microphone connected to pin 1 of the **PACKET** Jack while using the FM mode.

PC: Selects the microphone connected to the rear panel's **AUDIO IN** 3.5-mm jack while using the FM mode. The optional Data Management Unit (**DMU-9000**) is required for this to be effective.

060. RPT SHIFT (28MHz)

Function: Sets the magnitude of the repeater shift on the 28 MHz band.

Available Values: 0 ~ 1000 kHz

Default Setting: 100 kHz

061. RPT SHIFT (50MHz)

Function: Sets the magnitude of the repeater shift on the 50 MHz band.

Available Values: 0 ~ 4000 kHz

Default Setting: 1000 kHz

MODE-PKT GROUP

062. PKT DISP (SSB)

Function: Sets the packet frequency display offset.

Available Values: -3000 ~ +3000 Hz (10 Hz/step)

Default Setting: 0 Hz

063. PKT GAIN

Function: Adjusts the audio input level from the TNC to the AFSK modulator.

Available Values: 0 ~ 255

Default Setting: 128

064. PKT SHIFT (SSB)

Function: Sets the carrier point during the SSB Packet operation

Available Values: -3000 ~ +3000 Hz (10 Hz/step)

Default Setting: +1000 Hz (Typical center frequency for PSK31, etc.)

MODE-RTTY GROUP

065. POLARITY-R

Function: Selects normal or reverse Mark/Space polarity for RTTY receive operation.

Available Values: NOR/REV

Default Setting: NOR

066. POLARITY-T

Function: Selects normal or reverse Mark/Space polarity for RTTY transmit operation.

Available Values: NOR/REV

Default Setting: NOR

067. RTTY SHIFT

Function: Selects the frequency shift for the FSK RTTY operation.

Available Values: 170/200/425/850 Hz

Default Setting: 170 Hz

068. RTTY TONE

Function: Selects the mark tone for RTTY operation.

Available Values: 1275/2125 Hz

Default Setting: 2125 Hz

MODE-SSB GROUP

069. SSB MIC SELECT

Function: Selects the microphone to be used on the SSB mode.

Available Values: FRONT/REAR/DATA/PC

Default Setting: FRONT

FRONT: Selects the microphone connected to the front panel's **MIC** jack while using the SSB modes.

REAR: Selects the microphone connected to the rear panel's **MIC** jack while using the SSB modes.

DATA: Selects the microphone connected to pin 1 of the **PACKET** Jack while using the SSB modes.

PC: Selects the microphone connected to the rear panel's **AUDIO IN** 3.5-mm jack while using the SSB modes. The optional Data Management Unit (**DMU-9000**) is required for this to be effective.

070. SSB-TX-BPF

Function: Selects the audio passband of the Enhanced DSP modulator on the SSB mode.

Available Values: 50-3000(Hz)/100-2900(Hz)/200-2800(Hz)/300-2700(Hz)/400-2600(Hz)/3000WB

Default Setting: 300-2700 Hz

071. LSB RX-CARRIER

Function: Adjusts the receiver carrier point for LSB mode.

Available Values: -200 Hz ~ +200 Hz (10 Hz steps)

Default Setting: 0 Hz

072. LSB TX-CARRIER

Function: Adjusts the transmitter carrier point for LSB mode.

Available Values: -200 Hz ~ +200 Hz (10 Hz steps)

Default Setting: 0 Hz

Advice: This menu item is for future expansion of the transceiver's capabilities. Changing this setting will have no effect.

073. USB RX-CARRIER

Function: Adjusts the receiver carrier point for USB mode.

Available Values: -200 Hz ~ +200 Hz (10 Hz steps)

Default Setting: 0 Hz

074. USB TX-CARRIER

Function: Adjusts the transmitter carrier point for USB mode.

Available Values: -200 Hz ~ +200 Hz (10 Hz steps)

Default Setting: 0 Hz

Advice: This menu item is for future expansion of the transceiver's capabilities. Changing this setting will have no effect.

RX AUDIO GROUP

075. AGC-SLOPE

Function: Selects the gain curve of the AGC amplifier.

Available Values: NORMAL/SLOPE

Default Setting: NORMAL

NORMAL: The AGC output level will follow a linear response to the antenna input level, while AGC is activated.

SLOPE: The AGC output level will increase at 1/10 the rate of the antenna input level, while AGC is activated.

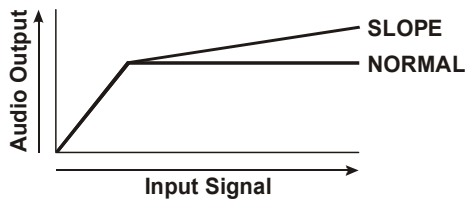

076. HEADPHONE MIX

Function: Selects one of three audio mixing modes when using headphones during Dual Receive operation.

Available Values: SEPARATE/COMBINE-1/COMBINE-2

Default Setting: COMBINE-2

SEPARATE: Audio from the main (VFO-A) receiver is heard only in the left ear, and sub (VFO-B) receiver audio solely in the right ear.

COMBINE-1: Audio from both main (VFO-A) and sub (VFO-B) receivers can be heard in both ears, but sub (VFO-B) audio is attenuated in the left ear and main (VFO-A) audio is attenuated in the right ear.

COMBINE-2: Audio from both main (VFO-A) and sub (VFO-B) receivers is combined and heard equally in both ears.

077. SPEAKER OUT

Function: Selects audio mixing modes for the "sub" (secondary) speaker during Dual Receive operation.

Available Values: SEPARATE/COMBINE

Default Setting: COMBINE

SEPARATE: Audio from the main (VFO-A) receiver is fed to the main speaker, and sub (VFO-B) receiver audio is fed to the "sub" speaker.

COMBINE: Audio from both main (VFO-A) and sub (VFO-B) receivers is combined and split equally between the main and sub speakers.

RX DSP GROUP

078. MAIN-CONTOUR-LEVEL

Function: Adjusts the parametric equalizer gain of the main band (VFO-A) receiver Contour filter.

Available Values: -40 ~ +20 dB

Default Setting: -15 dB

079. MAIN-CONTOUR-WIDTH

Function: Adjusts the Q-factor of the main band (VFO-A) receiver Contour filter.

Available Values: 1 - 11

Default Setting: 10

080. SUB-CONTOUR-LEVEL

Function: Adjusts the parametric equalizer gain of the sub band (VFO-B) receiver Contour filter.

Available Values: -40 ~ +20 dB

Default Setting: -15 dB

081. SUB-CONTOUR-WIDTH

Function: Adjusts the Q-factor of the sub band (VFO-B) receiver Contour filter.

Available Values: 1 ~ 11

Default Setting: 10

082. IF-NOTCH-WIDTH

Function: Selects the bandwidth of the DSP NOTCH filter

Available Values: NARROW/WIDE

Default Setting: WIDE

083. MAIN-CW-SHAPE

Function: Selects the passband characteristics of the main band (VFO-A) DSP filter for the CW mode.

Available Values: SOFT/SHARP

Default Setting: SHARP

SOFT: Primary importance attached to amplitude of the filter factor.

SHARP: Primary importance attached to phase of the filter factor.

084. MAIN-CW-SLOPE

Function: Selects the shape factor of the main band (VFO-A) DSP filter for the CW mode.

Available Values: GENTLE/MEDIUM/STEEP

Default Setting: MEDIUM

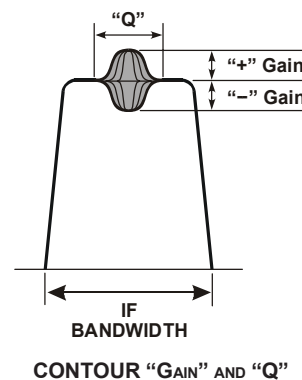

RX DSP GROUP

085. MAIN-CW-NARROW

Function: Selects the passband of the main band (VFO-A) DSP filter for the CW “narrow” mode.

Available Values: 25/50/100/200/300/400 Hz

Default Setting: 300 Hz

086. MAIN-PSK-SHAPE

Function: Selects the passband characteristics of the main band (VFO-A) DSP filter for the PSK mode.

Available Values: SOFT/SHARP

Default Setting: SHARP

SOFT: Primary importance attached to amplitude of the filter factor.

SHARP: Primary importance attached to phase of the filter factor.

087. MAIN-PSK-SLOPE

Function: Selects the shape factor of the main band (VFO-A) DSP filter for the PSK mode.

Available Values: GENTLE/MEDIUM/STEEP

Default Setting: MEDIUM

088. MAIN-PSK-NARROW

Function: Selects the passband of the main band (VFO-A) DSP filter for the PSK “narrow” mode.

Available Values: 25/50/100/200/300/400 Hz

Default Setting: 300 Hz

089. MAIN-RTTY-SHAPE

Function: Selects the passband characteristics of the main band (VFO-A) DSP filter for the RTTY mode.

Available Values: SOFT/SHARP

Default Setting: SHARP

SOFT: Primary importance attached to amplitude of the filter factor.

SHARP: Primary importance attached to phase of the filter factor.

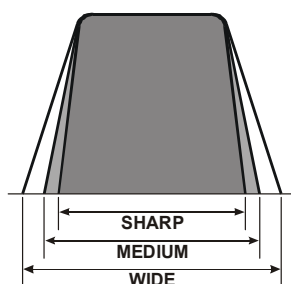

FILTER PASSBAND

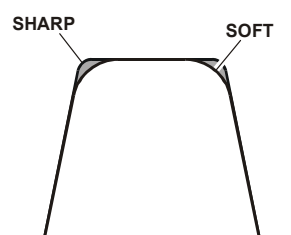

FILTER SHAPE

090. MAIN-RTTY-SLOPE

Function: Selects the shape factor of the main band (VFO-A) DSP filter for the RTTY mode.

Available Values: GENTLE/MEDIUM/STEEP

Default Setting: MEDIUM

091. MAIN-RTTY-NARROW

Function: Selects the passband of the main band (VFO-A) DSP filter for the RTTY “narrow” mode.

Available Values: 25/50/100/200/300/400 Hz

Default Setting: 300 Hz

092. MAIN-SSB-SHAPE

Function: Selects the passband characteristics of the main band (VFO-A) DSP filter for the SSB mode.

Available Values: SOFT/SHARP

Default Setting: SHARP

SOFT: Primary importance attached to amplitude of the filter factor.

SHARP: Primary importance attached to phase of the filter factor.

093. MAIN-SSB-SLOPE

Function: Selects the shape factor of the main band (VFO-A) DSP filter for the SSB mode.

Available Values: GENTLE/MEDIUM/STEEP

Default Setting: MEDIUM

094. MAIN-SSB-NARROW

Function: Selects the passband of the main band (VFO-A) DSP filter for the “narrow” SSB mode.

Available Values: 200/400/600/850/1100/1350/1500/1650/1800/1950/2100/2250 Hz

Default Setting: 1800 Hz

095. SUB-CW-SHAPE

Function: Selects the passband characteristics of the sub band (VFO-B) DSP filter for the CW mode.

Available Values: SOFT/SHARP

Default Setting: SHARP

SOFT: Primary importance attached to amplitude of the filter factor.

SHARP: Primary importance attached to phase of the filter factor.

Advice: If the Dual Receiver Unit (**RXU-9000**) is not installed, changing this setting will have no effect.

096. SUB-CW-FIL-SLOPE

Function: Selects the shape factor of the sub band (VFO-B) DSP filter for the CW mode.

Available Values: GENTLE/MEDIUM/STEEP

Default Setting: MEDIUM

Advice: If the Dual Receiver Unit (**RXU-9000**) is not installed, changing this setting will have no effect.

RX DSP GROUP

097. SUB-CW-NARROW

Function: Selects the passband of the sub band (VFO-B) DSP filter for the CW “narrow” mode.

Available Values: 25/50/100/200/300/400 Hz

Default Setting: 300 Hz

Advice: If the Dual Receiver Unit (**RXU-9000**) is not installed, changing this setting will have no effect.

098. SUB-PSK-SHAPE

Function: Selects the passband characteristics of the sub band (VFO-B) DSP filter for the PSK mode.

Available Values: SOFT/SHARP

Default Setting: SHARP

SOFT: Primary importance attached to amplitude of the filter factor.

SHARP: Primary importance attached to phase of the filter factor.

Advice: If the Dual Receiver Unit (**RXU-9000**) is not installed, changing this setting will have no effect.

099. SUB-PSK-SLOPE

Function: Selects the shape factor of the sub band (VFO-B) DSP filter for the PSK mode.

Available Values: GENTLE/MEDIUM/STEEP

Default Setting: MEDIUM

Advice: If the Dual Receiver Unit (**RXU-9000**) is not installed, changing this setting will have no effect.

100. SUB-PSK-NARROW

Function: Selects the passband of the sub band (VFO-B) DSP filter for the PSK “narrow” mode.

Available Values: 25/50/100/200/300/400 Hz

Default Setting: 300 Hz

Advice: If the Dual Receiver Unit (**RXU-9000**) is not installed, changing this setting will have no effect.

101. SUB-RTTY-SHAPE

Function: Selects the passband characteristics of the sub band (VFO-B) DSP filter for the RTTY mode.

Available Values: SOFT/SHARP

Default Setting: SHARP

SOFT: Primary importance attached to amplitude of the filter factor.

SHARP: Primary importance attached to phase of the filter factor.

Advice: If the Dual Receiver Unit (**RXU-9000**) is not installed, changing this setting will have no effect.

102. SUB-RTTY-SLOPE

Function: Selects the shape factor of the sub band (VFO-B) DSP filter for the RTTY mode.

Available Values: GENTLE/MEDIUM/STEEP

Default Setting: MEDIUM

Advice: If the Dual Receiver Unit (**RXU-9000**) is not installed, changing this setting will have no effect.

103. SUB-RTTY-NARROW

Function: Selects the passband of the sub band (VFO-B) DSP filter for the RTTY “narrow” mode.

Available Values: 25/50/100/200/300/400 Hz

Default Setting: 300 Hz

Advice: If the Dual Receiver Unit (**RXU-9000**) is not installed, changing this setting will have no effect.

104. SUB-SSB-SHAPE

Function: Selects the passband characteristics of the sub band (VFO-B) DSP filter for the SSB mode.

Available Values: SOFT/SHARP

Default Setting: SHARP

SOFT: Primary importance attached to amplitude of the filter factor.

SHARP: Primary importance attached to phase of the filter factor.

Advice: If the Dual Receiver Unit (**RXU-9000**) is not installed, changing this setting will have no effect.

105. SUB-SSB-SLOPE

Function: Selects the shape factor of the sub band (VFO-B) DSP filter for the SSB mode.

Available Values: GENTLE/MEDIUM/STEEP

Default Setting: MEDIUM

Advice: If the Dual Receiver Unit (**RXU-9000**) is not installed, changing this setting will have no effect.

106. SUB-SSB-NARROW

Function: Selects the passband of the main band (VFO-A) DSP filter for the “narrow” SSB mode.

Available Values: 200/400/600/850/1100/1350/1500/1650/1800/1950/2100/2250 Hz

Default Setting: 1800 Hz

Advice: If the Dual Receiver Unit (**RXU-9000**) is not installed, changing this setting will have no effect.

SCOPE GROUP

107. MAIN FIX 1.8 MHz

Function: Selects the scan start frequency of the FIX mode Spectrum Scope while monitoring on the main band (VFO-A) 160 m amateur band, when the optional Data Management Unit (**DMU-9000**) and TFT Display Unit (**TFT-9000**) are installed.

Available Values: 1800 - 1999 kHz (1 kHz steps)

Default Setting: 1800 kHz

108. MAIN FIX 3.5 MHz

Function: Selects the scan start frequency of the FIX mode Spectrum Scope while monitoring on the 80 m amateur band, when the optional Data Management Unit (**DMU-9000**) and TFT Display Unit (**TFT-9000**) are installed.

Available Values: 3500 - 3999 kHz (1 kHz steps)

Default Setting: 3500 kHz

109. MAIN FIX 5.0 MHz

Function: Selects the scan start frequency of the FIX mode Spectrum Scope while monitoring on the 60 m amateur band, when the optional Data Management Unit (**DMU-9000**) and TFT Display Unit (**TFT-9000**) are installed.

Available Values: 5250 - 5499 kHz (1 kHz steps)

Default Setting: 5250 kHz

110. MAIN FIX 7.0 MHz

Function: Selects the scan start frequency of the FIX mode Spectrum Scope while monitoring on the 40 m amateur band, when the optional Data Management Unit (**DMU-9000**) and TFT Display Unit (**TFT-9000**) are installed.

Available Values: 7000 - 7299 kHz (1 kHz steps)

Default Setting: 7000 kHz

111. MAIN FIX 10 MHz

Function: Selects the scan start frequency of the FIX mode Spectrum Scope while monitoring on the 30 m amateur band, when the optional Data Management Unit (**DMU-9000**) and TFT Display Unit (**TFT-9000**) are installed.

Available Values: 10100 - 10149 kHz (1 kHz steps)

Default Setting: 10100 kHz

112. MAIN FIX 14 MHz

Function: Selects the scan start frequency of the FIX mode Spectrum Scope while monitoring on the 20 m amateur band, when the optional Data Management Unit (**DMU-9000**) and TFT Display Unit (**TFT-9000**) are installed.

Available Values: 14000 - 14349 kHz (1 kHz steps)

Default Setting: 14000 kHz

113. MAIN FIX 18 MHz

Function: Selects the scan start frequency of the FIX mode Spectrum Scope while monitoring on the 17 m amateur band, when the optional Data Management Unit (**DMU-9000**) and TFT Display Unit (**TFT-9000**) are installed.

Available Values: 18000 - 18199 kHz (1 kHz steps)

Default Setting: 18068 kHz

114. MAIN FIX 21 MHz

Function: Selects the scan start frequency of the FIX mode Spectrum Scope while monitoring on the 15 m amateur band, when the optional Data Management Unit (**DMU-9000**) and TFT Display Unit (**TFT-9000**) are installed.

Available Values: 21000 - 21449 kHz (1 kHz steps)

Default Setting: 21000 kHz

115. MAIN FIX 24 MHz

Function: Selects the scan start frequency of the FIX mode Spectrum Scope while monitoring on the 12 m amateur band, when the optional Data Management Unit (**DMU-9000**) and TFT Display Unit (**TFT-9000**) are installed.

Available Values: 24800 - 24989 kHz (1 kHz steps)

Default Setting: 24890 kHz

116. MAIN FIX 28 MHz

Function: Selects the scan start frequency of the FIX mode Spectrum Scope while monitoring on the 10 m amateur band, when the optional Data Management Unit (**DMU-9000**) and TFT Display Unit (**TFT-9000**) are installed.

Available Values: 28000 - 29699 kHz (1 kHz steps)

Default Setting: 28000 kHz

117. MAIN FIX 50 MHz

Function: Selects the scan start frequency of the FIX mode Spectrum Scope while monitoring on the 6 m amateur band, when the optional Data Management Unit (**DMU-9000**) and TFT Display Unit (**TFT-9000**) are installed.

Available Values: 50000 - 53999 kHz (1 kHz steps)

Default Setting: 50000 kHz

118. SUB FIX 1.8 MHz

Function: Selects the scan start frequency of the FIX mode Spectrum Scope while monitoring on the main band (VFO-A) 160 m amateur band, when the optional Data Management Unit (**DMU-9000**) and TFT Display Unit (**TFT-9000**) are installed.

Available Values: 1800 - 1.999 kHz (1 kHz steps)

Default Setting: 1800 kHz

SCOPE GROUP

119. SUB FIX 3.5 MHz

Function: Selects the scan start frequency of the FIX mode Spectrum Scope while monitoring on the 80 m amateur band, when the optional Data Management Unit (**DMU-9000**) and TFT Display Unit (**TFT-9000**) are installed.

Available Values: 3500 - 3999 kHz (1 kHz steps)

Default Setting: 3500 kHz

120. SUB FIX 5.0 MHz

Function: Selects the scan start frequency of the FIX mode Spectrum Scope while monitoring on the 60 m amateur band, when the optional Data Management Unit (**DMU-9000**) and TFT Display Unit (**TFT-9000**) are installed.

Available Values: 5250 - 5499 kHz (1 kHz steps)

Default Setting: 5250 kHz

121. SUB FIX 7.0 MHz

Function: Selects the scan start frequency of the FIX mode Spectrum Scope while monitoring on the 40 m amateur band, when the optional Data Management Unit (**DMU-9000**) and TFT Display Unit (**TFT-9000**) are installed.

Available Values: 7000 - 7299 kHz (1 kHz steps)

Default Setting: 7000 kHz

122. SUB FIX 10 MHz

Function: Selects the scan start frequency of the FIX mode Spectrum Scope while monitoring on the 30 m amateur band, when the optional Data Management Unit (**DMU-9000**) and TFT Display Unit (**TFT-9000**) are installed.

Available Values: 10100 - 10149 kHz (1 kHz steps)

Default Setting: 10100 kHz

123. SUB FIX 14 MHz

Function: Selects the scan start frequency of the FIX mode Spectrum Scope while monitoring on the 20 m amateur band, when the optional Data Management Unit (**DMU-9000**) and TFT Display Unit (**TFT-9000**) are installed.

Available Values: 14000 - 14349 kHz (1 kHz steps)

Default Setting: 14000 kHz

124. SUB FIX 18 MHz

Function: Selects the scan start frequency of the FIX mode Spectrum Scope while monitoring on the 17 m amateur band, when the optional Data Management Unit (**DMU-9000**) and TFT Display Unit (**TFT-9000**) are installed.

Available Values: 18000 - 18199 kHz (1 kHz steps)

Default Setting: 18068 kHz

125. SUB FIX 21 MHz

Function: Selects the scan start frequency of the FIX mode Spectrum Scope while monitoring on the 15 m amateur band, when the optional Data Management Unit (**DMU-9000**) and TFT Display Unit (**TFT-9000**) are installed.

Available Values: 21000 - 21449 kHz (1 kHz steps)

Default Setting: 21000 kHz

126. SUB FIX 24 MHz

Function: Selects the scan start frequency of the FIX mode Spectrum Scope while monitoring on the 12 m amateur band, when the optional Data Management Unit (**DMU-9000**) and TFT Display Unit (**TFT-9000**) are installed.

Available Values: 24800 - 24989 kHz (1 kHz steps)

Default Setting: 24890 kHz

127. SUB FIX 28 MHz

Function: Selects the scan start frequency of the FIX mode Spectrum Scope while monitoring on the 10 m amateur band, when the optional Data Management Unit (**DMU-9000**) and TFT Display Unit (**TFT-9000**) are installed.

Available Values: 28000 - 29699 kHz (1 kHz steps)

Default Setting: 28000 kHz

128. SUB FIX 50 MHz

Function: Selects the scan start frequency of the FIX mode Spectrum Scope while monitoring on the 6 m amateur band, when the optional Data Management Unit (**DMU-9000**) and TFT Display Unit (**TFT-9000**) are installed.

Available Values: 50.000 - 53999 kHz (1 kHz steps)

Default Setting: 50000 kHz

TUNING GROUP

129. MAIN DIAL STEP

Function: Setting of the Main Tuning Knob's tuning speed on the SSB, CW, and AM modes.

Available Values: 1 or 10 Hz

Default Setting: 10 Hz

130. MAIN DIAL CW FINE

Function: Setting of the Main Tuning Knob's tuning speed in the CW mode.

Available Values: ENABLE/DISABLE

Default Setting: DISABLE

ENABLE : Tuning in 1 Hz steps on the CW mode.

DISABLE: Tuning according to the steps determined via menu item 129: **MAIN DIAL STEP**.

131. 1MHz/100kHz SELECT

Function: Selects the tuning steps for the **CLAR/VFO-B** knob when the **BAND/MHz** button is pressed.

Available Values: 1 MHz/100 kHz

Default Setting: 1 MHz

132. AM CH STEP

Function: Selects the tuning steps for the microphone's **[UP]/[DWN]** keys in the AM mode.

Available Values: 2.5/5/9/10/12.5 kHz

Default Setting: 5 kHz

133. FM CH STEP

Function: Selects the tuning steps for the microphone's **[UP]/[DWN]** keys in the FM mode.

Available Values: 5/6.25/10/12.5/20 kHz

Default Setting: 5 kHz

134. FM DIAL STEP

Function: Setting of the Main Tuning Knob's tuning speed in the FM mode.

Available Values: 10/100 Hz

Default Setting: 100 Hz

135. MY BAND

Function: Programs a band to be skipped while selecting bands using the **CLAR/VFO-B** knob.

Available Values: 1.8 ~ 50 (MHz)/GEN/TRV

Default Setting: TRV

To program the band to be skipped, rotate the **CLAR/VFO-B** knob to recall the band to be skipped while selecting bands via the **CLAR/VFO-B** knob, then press the **[ENT]** key to change this setting to "ON." Repeat the same procedures to cancel the setting (skipped "off"). The skipped band will be high-lighted on the TFT display.

TX AUDIO GROUP

136. F-PRMTRC EQ1-FREQ

Function: Selects the center frequency of the lower range for the front panel's parametric microphone equalizer.

Available Values: OFF/100 ~ 700 Hz (100 Hz/step)

Default Setting: OFF

OFF: The equalizer gain and Q-factor are set to factory defaults (flat).

100 ~ 700: You may adjust the equalizer gain and Q-factor at this selected audio frequency via menu items 137: **F-PRMTRC EQ1-LEVEL** and 138: **F-PRMTRC EQ1-BWTH**.

137. F-PRMTRC EQ1-LEVEL

Function: Adjusts the equalizer gain of the low range of the front panel's parametric microphone equalizer.

Available Values: -10 ~ +10

Default Setting: +5

138. F-PRMTRC EQ1-BWTH

Function: Adjusts the Q-factor of the low range of the front panel's parametric microphone equalizer.

Available Values: 1 ~ 10

Default Setting: 10

139. F-PRMTRC EQ2-FREQ

Function: Selects the center frequency of the middle range for the front panel's parametric microphone equalizer.

Available Values: OFF/700 ~ 1500 Hz (100 Hz/step)

Default Setting: OFF

OFF: The equalizer gain and Q-factor are set to factory defaults (flat).

700 ~ 1500: You may adjust the equalizer gain and Q-factor at this selected audio frequency via menu items 140: **F-PRMTRC EQ2-LEVEL** and 141: **F-PRMTRC EQ2-BWTH**.

140. F-PRMTRC EQ2-LEVEL

Function: Adjusts the equalizer gain of the middle range of the front panel's parametric microphone equalizer.

Available Values: -10 ~ +10

Default Setting: +5

141. F-PRMTRC EQ2-BWTH

Function: Adjusts the Q-factor of the middle range of the front panel's parametric microphone equalizer.

Available Values: 1 ~ 10

Default Setting: 10

TX AUDIO GROUP

142. F-PRMTRC EQ3-FREQ

Function: Selects the center frequency of the high range for the front panel's parametric microphone equalizer.

Available Values: OFF/1500 ~ 3200 Hz (100 Hz/step)

Default Setting: OFF

OFF: The equalizer gain and Q-factor are set to factory defaults (flat).

15 ~ 32: You may adjust the equalizer gain and Q-factor in this selected audio frequency via menu items 143: **F-PRMTRC EQ3-LEVEL** and 144: **F-PRMTRC EQ3-BWTH**.

143. F-PRMTRC EQ3-LEVEL

Function: Adjusts the equalizer gain of the high range of the front panel's parametric microphone equalizer.

Available Values: -10 ~ +10

Default Setting: +5

144. F-PRMTRC EQ3-BWTH

Function: Adjusts the Q-factor of the high range of the front panel's parametric microphone equalizer.

Available Values: 1 ~ 10

Default Setting: 10

145. R-PRMTRC EQ1-FREQ

Function: Selects the center frequency of the low range for the rear panel's parametric microphone equalizer.

Available Values: OFF/100 ~ 700 Hz (100 Hz/step)

Default Setting: OFF

OFF: The equalizer gain and Q-factor are set to factory defaults (flat).

100 ~ 700: You may adjust the equalizer gain and Q-factor in this selected audio frequency via menu items 146: **R-PRMTRC EQ1-LEVEL** and 147: **R-PRMTRC EQ1-BWTH**.

146. R-PRMTRC EQ1-LEVEL

Function: Adjusts the equalizer gain of the low range of the rear panel's parametric microphone equalizer.

Available Values: -10 ~ +10

Default Setting: +5

147. R-PRMTRC EQ1-BWTH

Function: Adjusts the Q-factor of the low range of the rear panel's parametric microphone equalizer.

Available Values: 1 ~ 10

Default Setting: 10

148. R-PRMTRC EQ2-FREQ

Function: Selects the center frequency of the middle range for the rear panel's parametric microphone equalizer.

Available Values: OFF/700 ~ 1500 Hz (100 Hz/step)

Default Setting: OFF

OFF: The equalizer gain and Q-factor are set to factory defaults (flat).

700 ~ 1500: You may adjust the equalizer gain and Q-factor at this selected audio frequency via menu items 149: **R-PRMTRC EQ2-LEVEL** and 150: **R-PRMTRC EQ2-BWTH**.

149. R-PRMTRC EQ2-LEVEL

Function: Adjusts the equalizer gain of the middle range of the rear panel's parametric microphone equalizer.

Available Values: -10 ~ +10

Default Setting: +5

150. R-PRMTRC EQ2-BWTH

Function: Adjusts the Q-factor of the middle range of the rear panel's parametric microphone equalizer.

Available Values: 1 ~ 10

Default Setting: 10

151. R-PRMTRC EQ3-FREQ

Function: Selects the center frequency of the high range for the rear panel's parametric microphone equalizer.

Available Values: OFF/1500 ~ 3200 Hz (100 Hz/step)

Default Setting: OFF

OFF: The equalizer gain and Q-factor are set to factory defaults (flat).

1500 ~ 3200: You may adjust the equalizer gain and Q-factor at this selected audio frequency via menu items 152: **R-PRMTRC EQ3-LEVEL** and 153: **R-PRMTRC EQ3-BWTH**.

152. R-PRMTRC EQ3-LEVEL

Function: Adjusts the equalizer gain of the high range of the rear panel's parametric microphone equalizer.

Available Values: -10 ~ +10

Default Setting: +5

153. R-PRMTRC EQ3-BWTH

Function: Adjusts the Q-factor of the high range of the rear panel's parametric microphone equalizer.

Available Values: 1 ~ 10

Default Setting: 10

TX GNRL GROUP

154. TX MAX POWER

Function: Selects a maximum output power limit.

Available Values: 200/100/50/10 W

Default Setting: 200 W

155. TX PWR CONTROL

Function: Configures the **RF PWR** knob.

Available Values: ALL MODE/CARRIER

Default Setting: ALL MODE

ALL MODE: The **RF PWR** knob is enabled on all modes.

CARRIER: The **RF PWR** knob is enabled in all modes except SSB. In this configuration, the SSB output power will be set to maximum, regardless of the **RF PWR** knob's position.

156. EXT AMP TX-GND

Function: Enables/Disables the **TX GND** jack on the rear panel.

Available Values: ENABLE/DISABLE

Default Setting: DISABLE

157. EXT AMP TUNING PWR

Function: Selects a maximum output power limit for driving the input circuit of an external linear RF amplifier while tuning (while using the Remote Control function of the linear RF amplifier).

Available Values: 200/100/50/10 W

Default Setting: 100 W

158. FULL DUPLEX

Function: Enables/Disables Full Duplex operation.

Available Values: SIMP/DUP

Default Setting: SIMP

Explanation: When the optional Dual Receive Unit (RXU-9000) is installed, engaging "DUP" allows you to listen on the Sub (VFO-B) receiver while simultaneously transmitting on the Main (VFO-A) frequency (on a different band) in a "Full Duplex" mode.

159. VOX SELECT

Function: Selects the audio input source for triggering TX during VOX operation.

Available Values: MIC/DATA

Default Setting: MIC

MIC: The VOX function will be activated by microphone audio input.

DATA: The VOX function will be activated by data audio input.

160. EMERGENCY FREQ TX

Function: Enables Tx/Rx operation on the Alaska Emergency Channel, 5167.5 kHz.

Available Values: DISABLE/ENABLE

Default Setting: DISABLE

When this Menu Item is set to "ENABLE," the spot frequency of 5167.5 kHz will be enabled. The Alaska Emergency Channel will be found between the Memory channels "P-1" and "01 (or 1-01)."

NOTE

ABOUT CUSTOMIZATION OPTIONS

With regard to the FT DX 9000 Contest, the addition of one or more of the customization options can elevate performance of the basic transceiver to a higher level. Additionally, you may configure the level of performance that fits the requirements of your station, as well as your personal tastes and preferences. Because these options are delicate, high-technology devices, please contact WDXC regarding the latest information regarding installation of any options inside your FT DX 9000 Contest.

Dual Receive Unit (RXU-9000)

The Dual Receive Unit (model **RXU-9000**) not only permits simultaneous reception on two frequencies (in the same band or on different bands), but also it enables Full Duplex operation, whereby you may be transmitting on 20 meters while, simultaneously, receiving on 40 meters or any band other than 14 MHz. The **RXU-9000** is a fully-equipped replica of the VFO-A, so reception is not compromised when using the VFO-B.

RF μ -Tuning Units (MTU-160, MTU-80/40, MTU-30/20)

On the 14 MHz and lower bands, the μ -Tuning Units provide extraordinarily high Q; the resulting steep shape factor is a powerful aid for reducing off-frequency interference. Separate modules are available for the 1.8 MHz, 3.5/7 MHz, and 10.1/14 MHz bands, and they may be installed on the Main Receiver only (not in the **RXU-9000**).

Thanks to the large (1.1"/28 mm) inductor through which a stack of ferrite cores is adjusted, the bandwidth of the μ -Tuning (± 12.5 kHz) provides unmatched protection for the receiver front end and following circuits.

Data Management Unit (DMU-9000)/TFT Display Unit (TFT-9000)

In order to enable the World Clock, Spectrum Scope, Audio Scope/Oscilloscope, Logbook, Rotator Control, and Temperature/SWR Status Display functions, you may install the Data Management Unit (**DMU-9000**), which actually is a mini-computer that fits inside your transceiver. These various functions may then be displayed on a user-supplied external display screen, such as a plasma or TFT display.

Furthermore, if the TFT Display Unit (**TFT-9000**) is installed, an external display becomes unnecessary. The **TFT-9000** includes a 6.5", 800 x 480 dot screen which provides high resolution and easy viewing, as well as quick access to the control options available on each TFT display page.

DUAL RECEIVE UNIT (RXU-9000)

When the optional Dual Receive Unit (**RXU-9000**) is installed, simultaneous reception on two frequencies will be possible. What's more, full duplex operation (whereby you can be calling CQ on 14 MHz while simultaneously tuning for new countries on 21 MHz) can be engaged. Independent controls for both receivers are provided, ensuring that there is no impairment of operating capability when using either receiver in the Dual Receive mode.

Furthermore, the two receivers (VFO-A and VFO-B) have identical architectures, so there is no difference in the interference- or noise-fighting capabilities of the two receivers.

FRONT PANEL CONTROLS

『Advice』

These switch's and knob's function is basically identical to that explained with respect to the VFO-A, please see the VFO-A discussions for detailed explanations of these controls, switches, and indicators.

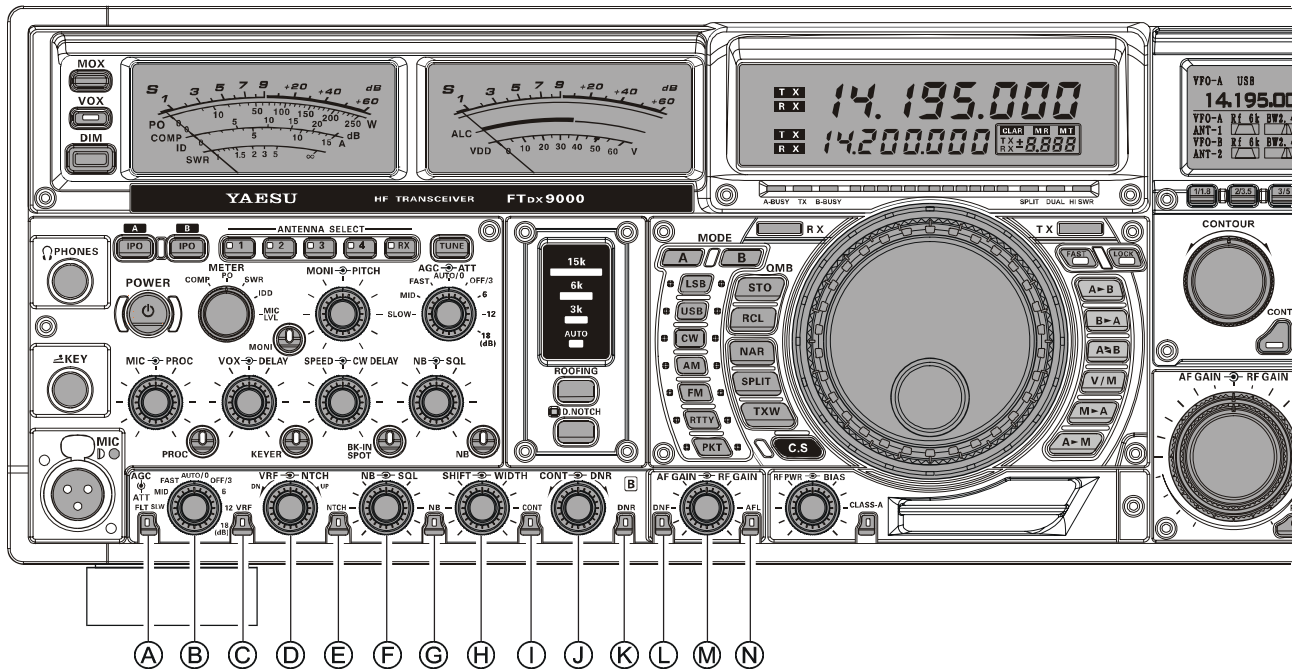

- Ⓐ **R.FLT Switch (Refer to VFO-A: 25)**
This switch allows selection of the VFO-B Roofing filter.
- Ⓑ **AGC → ATT Knobs (Refer to VFO-A: 13)**
AGC Switch
This switch selects the AGC characteristics for the VFO-B.
ATT Switch
This switch selects the degree of attenuation, if any, to be applied to the VFO-B.
- Ⓒ **VRF Switch (Refer to VFO-A: 69)**
This button turns the VFO-B VRF filter on and off. While activated, the LED inside the button will glow amber.

- Ⓓ **VRF/NTCH Knobs**
VRF/μ-T Knob (Refer to VFO-A: 68)
The inner [VRF] knob tunes the passband of the VFO-B RF filter for maximum receiver sensitivity.
『Advice』
In order to take advantage of the Variable RF Preselector filter on the VFO-B, the optional VRF Unit (**VRF-9000**) must be installed.
NTCH Knob (Refer to VFO-A: 70)
The outer [NTCH] knob adjusts the center frequency of the VFO-B IF notch filter. The Notch Filter is engaged via the [NTCH] switch, described in the next section.
- Ⓔ **NTCH Switch (Refer to VFO-A: 71)**
This switch turns the VFO-B manual IF Notch filter On and Off. Adjustment of the center frequency of the Notch filter is provided by the [NTCH] knob, described in the previous section.

DUAL RECEIVE UNIT (RXU-9000)

FRONT PANEL CONTROLS

Ⓕ NB SQL Knobs (Refer to VFO-A: 21)

NB Knob

This adjusts the VFO-B IF Noise Blanker level, when the Noise Blanker is engaged via the **【NB】** switch, described below.

SQL Knob

This knob provides adjustment of the VFO-B noise Squelch system.

Ⓖ NB Switch (except on FM mode) (Refer to VFO-A: 22)

This switch engages the VFO-B IF Noise Blanker. Adjustment of the Noise Blanker level is provided by the **【NB】** knob, described in the previous section.

Ⓗ SHIFT WIDTH Knobs (except on FM mode) (Refer to VFO-A: 76)

SHIFT Knob

This knob adjusts the center frequency of the VFO-B DSP filter, with an adjustment range of ± 1 kHz.

WIDTH Knob

This knob varies the width of the IF DSP filter for the VFO-B.

Ⓘ CONT Switch (Refer to VFO-A: 65)

This is the On/Off switch for the VFO-B CONTOUR filter. When engaged, the **【CONT】** LED will glow Umber. Adjustment of the VFO-B CONTOUR filter's frequency is provided by the **【CONT】** knob (described in the next section).

Ⓙ CONT DNR

CONT (Contour) (Refer to VFO-A: 64)

This knob provides adjustment of the VFO-B CONTOUR filter frequency.

『Advice』

Use the Menu items “**RX DSP 080 SUB-CONTOUR-LEVEL**” and “**RX DSP 081 SUB-CONTOUR-WIDTH**” to configure the VFO-B CONTOUR filter.

DNR Knob (Refer to VFO-A: 66)

This knob is used to select one of the 16 available noise reduction parameters for the VFO-B Digital Noise Reduction system.

Ⓚ DNR Switch (Refer to VFO-A: 67)

This button turns the VFO-B Digital Noise Reduction circuit on and off. When the Digital Noise Reduction is activated, the LED inside the button will glow Umber. Adjustment of the Noise Reduction level is provided by the **【DNR】** knob, described in the previous section.

Ⓛ DNF Switch (Refer to VFO-A: 26)

This switch is the On/Off switch for the VFO-B Digital Notch Filter. When turned On, the associated LED glows Umber.

Ⓜ AF GAIN RF GAIN (Refer to VFO-A: 73)

AF GAIN Knob

This is the VFO-B Volume (AF GAIN) control.

RF GAIN Knob

This is the VFO-B RF GAIN control, which adjusts the gain of the receiver's RF and IF amplifier stages. This control is normally left in the fully clockwise position.

Ⓝ AFL Switch (Refer to VFO-A: 75)

Pressing this button activates the Audio (AF) Limiter circuit of the VFO-B. This will protect the audio amplifier from distortion, and protect your ears from high audio levels, caused by sudden peaks in audio input when the AGC is set to “OFF.” When the Audio Limiter circuit is activated, the LED inside the button will glow Umber.

DUAL RECEIVE UNIT (RXU-9000)

DUAL RECEIVE

When the optional Dual Receive Unit (**RXU-9000**) is installed, simultaneous reception on the VFO-A and VFO-B is possible.

1. While receiving on the VFO-A, engage the VFO-B by pressing the **[SUB RX]** key (#78). You will now be receiving on the two frequencies shown on the main frequency display.

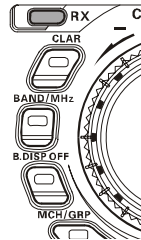

2. Adjusting the volume:

To adjust the VFO-A audio level, rotate the Main **[AF GAIN]** control (#73). To adjust the VFO-B audio level, rotate the Sub **[AF GAIN]** control (#M). In both cases, clockwise rotation of the knob will increase the volume level.

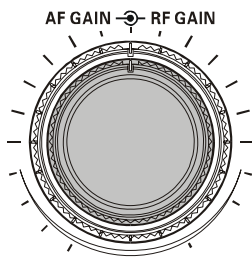
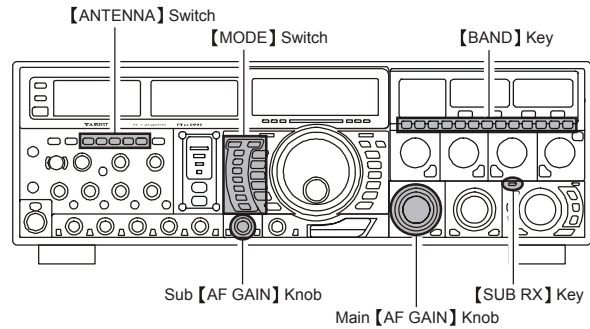

VFO-A AF GAIN



VFO-B AF GAIN

3. Press the **[B]** switch (#27) to enable the capability to change the operating mode for the VFO-B.
4. Having pressed the **[B]** switch (#27) in the previous step, you may also press the **[BAND]** keys switch (#63) to select the operating band on which you want to set up the VFO-B.

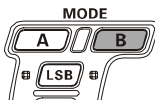

5. Press the appropriate **[MODE]** switch (#27) to select the desired operating mode for the VFO-B.

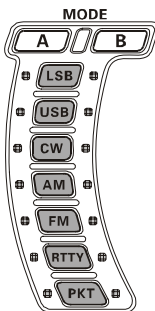

6. After you have set up the band and mode for the VFO-B, you should now select the proper antenna, using the **[ANTENNA SELECT 1 ~ 4]** switches, or, for receive-only capability, the **[RX]** (Antenna) switch (#9).



DUAL RECEIVE UNIT (RXU-9000)

DUAL RECEIVE

7. Rotate the **【Main】** Tuning Dial (#34) to adjust the VFO-A frequency, and rotate the **【CLAR/VFO-B】** tuning dial (#84) to adjust the VFO-B frequency.

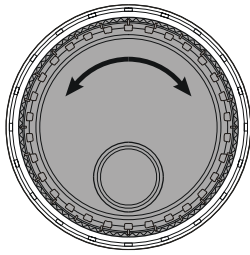

VFO-A MAIN DIAL Knob

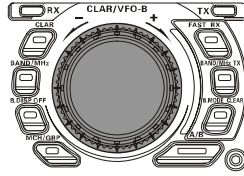

VFO-B CLAR/VFO-B Knob

8. To cancel Dual Receive operation, and receive just on the VFO-A, press the **【MAIN RX】** key (#32); the Green **【SUB RX】** key (#78) LED will go out, and monoband operation on the VFO-A will resume.

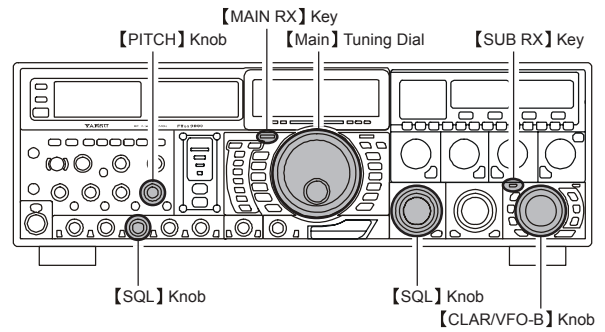
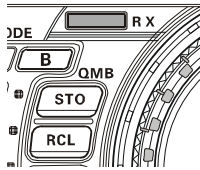

【Note】

Please remember that, so long as the **【B】** Mode switch (#27) is illuminated, any mode or band changes will still be applied to the VFO-B, whether or not Dual Receive is engaged.

【Quick Note】

By convention in the Amateur bands, LSB is used on the 7 MHz and lower bands (with the exception of 60 meters), while USB is utilized on the 14 MHz and higher bands.

【Advice】

- When operating in Dual Receive, the manner in which the audio is fed to the left and right sides of your headphones (Stereo, Monaural, or Mixed) may be configured using Menu item “**RX AUDIO 076 HEADPHONE MIX**” (see page 124).
- When changing modes from SSB to CW, you will observe a frequency shift on the display. This shift represents the BFO offset between the “zero beat” frequency and the audible CW pitch (tone) you can hear (the pitch is programmed by the **【PITCH】** control (#14)), even though the actual tone that you hear is not changing. If you do not want this frequency shift to appear when changing modes from (for example) USB to CW, use the Menu item “**MODE-CW 050 CW FREQ DISPLAY**,” described on page 121.
- When operating on the FM mode on the VFO-B, rotate the Sub **【SQL】** (Squelch) control (#F) clockwise just to the point where the background noise is just silenced. This is the point of maximum sensitivity to weak signals. Excessive advancement of the **【SQL】** control will degrade the ability of the receiver to detect weak signals. Adjustment of the VFO-A Squelch is accomplished using the Main **【SQL】** control (#21).

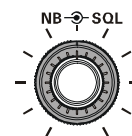

VFO-A SQL Knob

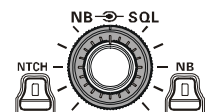

VFO-B SQL Knob

DUAL RECEIVE UNIT (RXU-9000)

DUAL RECEIVE: FULL DUPLEX OPERATION

The FT DX 9000 Contest which is installed the optional Dual Receive Unit (**RXU-9000**) includes a unique capability among HF transceivers: the ability to operate in a full duplex environment, where by you can transmit on the VFO-A while simultaneously tuning around, on a different band, on the VFO-B. This affords the contest operator extra tuning time in search of new contacts and multipliers while calling CQ on the “run” band. This yields “SO2R” (Single Operator, Two Radio) operating capability while using only one transceiver!

To engage Full Duplex crossband operation, set Menu item “**TX GNRL 158 FULL DUP**” to “DUP” instead of the default “SIMP” selection. To return to normal (non-duplex) operation, return Menu to “SIMP.”

When Full duplex operation is engaged, you may receive on the VFO-B frequency while transmitting, during dual receive operation, on a different band on the VFO-A. This allows you to tune for contacts on 15 meters, for example, while calling CQ on 20 meters during a slow time in a contest. Press the **【SUB TX】** Button/LED (#**79**) to switch transmit control to that VFO to call a station, then press the **【MAIN TX】** Button/LED (#**33**) to return to the “run” band and continue your “CQ” process.

This capability within a single transceiver is a unique feature of the FT DX 9000. It relieves you of the need to run separate key, PTT, and other control lines to two different radios from your logging computer.

『Note』

Full Duplex operation within the same band (e.g. both VFO-A and VFO-B on 20 meters) is not possible.

Important Guidelines for Full Duplex Operation

Remember that, at your station location, the capability exists for damaging RF voltage to be conducted from your transmitting antenna into your receiving antenna during full duplex operation. The exact amplitude will depend on the operating frequency, proximity and polarization alignment of the antennas, and the transmitting power level (including your linear amplifier, if used).

Accordingly, you should take some time, in assembling your station, to ensure that proper isolation exists between your station antenna systems. One way to do this is to connect the “receive” antenna coaxial cable to the “Transmitter” jack of low-power Wattmeter, and connect the “Antenna” jack of the Wattmeter to a 50-Ohm Dummy load. Now transmit on the “TX” antenna you will be using, and observe the deflection (if any) on the low-power Wattmeter connected to the “receive” antenna. For safe operation of the FT DX 9000, you should observe “10 mW” or less on the Wattmeter.

DUAL RECEIVE UNIT (RXU-9000)

DUAL RECEIVE: FULL DUPLEX OPERATION

Using Headphones for Dual Receive

To take advantage of dual reception, you will want to connect stereo headphones to the PHONES jack. Like the **【AF GAIN】** control, headphone audio mixing can also be configured as desired from Menu Selection: “**RX AUDIO 076 HEADPHONE MIX.**” Three audio mixing schemes are selectable as follows:

- OFF:** Audio from the VFO-A is heard only in the left ear, and VFO-B audio solely in the right ear.
- MID:** Audio from both VFO-A and VFO-B can be heard in both ears, but VFO-B audio is attenuated in the left ear and VFO-A audio is attenuated in the right ear.
- FULL:** Audio from both VFO-A and VFO-B combined and heard equally in both ears “Monaural” mode).

Sideband Diversity Reception

Here you receive a single AM signal through the two receivers, each receiving the opposite sideband. Skywave-propagated signals often show phase distortion in this mode, but it gives you a view of the entire passband, from which you can then select the best sideband for listening (or for SWL Dx'ing, you may want to listen to both sidebands at the same time, to get the best copy). On groundwave signals, where the phase of the sidebands is likely to be the same, there is an interesting sense of depth to the signal.

To tune in a signal using this mode, you should have stereo headphones connected to the front panel PHONES jack or an external stereo speaker connected to the rear panel EXT SP jacks.

- Set the VFO-A to either LSB or USB mode, and tune for zero beat on the desired signal.
- Press the **【A▶B】** button (#40) to copy this mode and frequency into the VFO-B, then press the mode button to select the opposite sideband for the VFO-A.
- If using headphones, set the headphone mixing scheme to the “COMBINE-1” mode via the Menu Selection: “**RX AUDIO 076 HEADPHONE MIX,**” and activate dual reception.
- Adjust the **【AF GAIN】** knob(s) to balance the volume of the two receivers.

If interference is present on one of the channels, you may have to turn its **【AF GAIN】** control to suppress that channel (or press the green **【RX】** LED/button to disable the receiver with the sideband experiencing interference). Otherwise, try changing the headphone audio mixing scheme to “FULL” or “OFF” in the Menu Selection: “**RX AUDIO 076 HEADPHONE MIX**” for different effects (or try settings with similar effects on your external amplifier). Although you don't get the “stereophonic” effect in the monaural mode, the two signals are still mixed, offering the potential for much better copy than in regular AM or even single-sideband ECSS modes.

Bandwidth Diversity Reception

This mode involves receiving the same signal through two different bandpass filters. The frequency and mode of both the VFO-A and VFO-B are the same. The VFO-A can be set up for a narrow bandpass, and the VFO-B for a wide bandpass, using the **【WIDTH】** knobs, resulting in a spatial perception of the channel. Although any mode (except FM) can be used, CW offers the widest array of choices, and perhaps the most startling effects on crowded channels.

Stereo headphones or an external stereo speaker are recommended for this mode. To set up the transceiver for bandwidth diversity reception:

- Select the desired mode on the Main band (VFO-A).
- Tune to the signal of interest.
- Press the **【A▶M】** button (#45) to copy this mode and frequency into the VFO-B.
- If using headphones, set the headphone mixing scheme to the “MID” mode via the Menu Selection “**RX AUDIO 076 HEADPHONE MIX**” and activate dual reception.
- Adjust the **【AF GAIN】** knob(s) to balance the volume of the two receivers.
- Now try manipulating the **【SHIFT】** and **【WIDTH】** controls (on both VFO-A and VFO-B) to observe the interesting effects of bandwidth diversity.

Polarity Diversity

Similar in concept to the bandwidth diversity capability just described, another interesting capability of the FT DX 9000 is the ability to use two different antennas on the same frequency, using dual reception. For example, you might have a horizontal Yagi on the main band, and a vertical antenna on the sub band, then lock the two frequencies together and engage dual reception.

Frequently, the fading observed on the HF bands is not so much a change in ionization level, but rather a shift in the polarization of the signal as it travels to and from the ionosphere. Having an opposite-polarization antenna available can fill in the signal during deep fades, and you may then transmit on whichever antenna is providing the strongest signal at the moment (see the discussion on Split Frequency operation, see page 82).

DUAL RECEIVE UNIT (RXU-9000)

DIAL SWAP CONFIGURATION (AF/RF GAIN CONTROLS)

Using the Menu, it is possible to change the **[RF GAIN]** control (for the VFO-A) to serve as the VFO-B **[AF GAIN]** control. In this case, the Menu Item “**GENERAL 038 AF/RF DIAL SWAP**” will move the VFO-A **[RF GAIN]** control function to the knob normally utilized for the VFO-B receiver’s **[AF GAIN]** control. In this way, both the VFO-A and VFO-B **[AF GAIN]** controls will be on the same shaft, as will the two VFOs’ **[RF GAIN]** controls, and this may be particularly useful during Dual Receive operation.

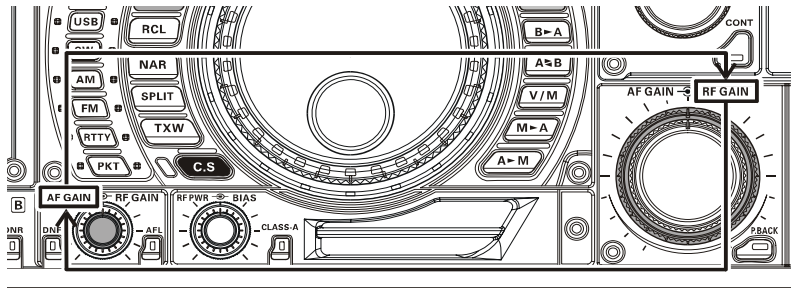

VFO-A
[RF GAIN] knob



VFO-B
[RF GAIN] knob

VFO-A
[AF GAIN] knob

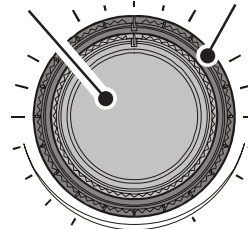

VFO-B
[AF GAIN] knob

Dial Swap Setup

1. Press the **[MNU]** key (#72) to engage the Menu mode; the Menu list will appear on the LCD Display.
2. Rotate the **[Main]** Tuning Dial (#34) to select Menu item “**GENERAL 038 AF/RF DIAL SWAP**.”
3. Rotate the **[CLAR/VFO-B]** knob (#84) so as to select “**SWAP**” instead of the factory-default “**NORMAL**” selection.
4. Press and hold in the **[MNU]** key (#72) for two seconds to save the new configuration and exit to normal operation.

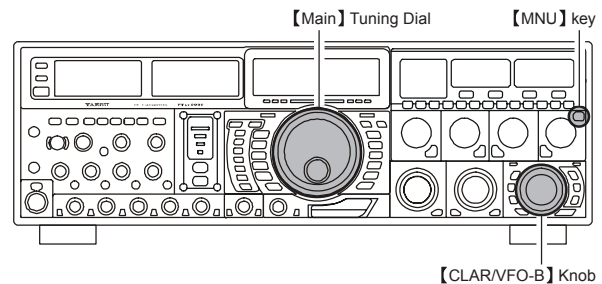

『Quick Point』

If the Dial Swap function has been engaged, the VFO-A **AF GAIN** → **RF GAIN** control (#76) will be reconfigured so that it now operates as **AF GAIN** (VFO-A) → **AF GAIN** (VFO-B); the VFO-B **AF GAIN** → **RF GAIN** control (#84) will now be configured as **RF GAIN** (VFO-A) → **RF GAIN** (VFO-B).

DUAL RECEIVE UNIT (RXU-9000)

CHANGING THE SPEAKER OUTPUT CONFIGURATION

An internal switch, and the menu, allow you to configure the way audio is fed to the two internal speakers (either “stereo” or “monaural” modes are available).

『Advice』

At the default setting, the audio signals from both the VFO-A and VFO-B are combined, and the resulting monaural audio takes advantage of the combined aperture of the two speakers. For most operation, this configuration results in beautiful audio reproduction, and is to be preferred. If you wish to leave the speaker setup as is, you may skip the remainder of this section.

		SPEAKER SELECT SWITCH	
		COM	SEP
MENU SELECTION 77 SPEAKER MIX	COMBINE	VFO-A and VFO-B audio will be mixed in the two internal speakers.	VFO-A and VFO-B audio will be mixed but heard only from the “A” internal speaker.
	SEPARATE	VFO-A audio will be heard from internal speaker “A.” For listening to audio from the VFO-B receiver, connect an external speaker to rear-panel terminal “B.”	VFO-A audio will be heard from internal speaker “A,” and VFO-B audio will be heard from internal speaker “B.”

With respect to the switch on the Speaker Unit, the left position is 【SEP】 and the right position is 【COM】.

Speaker Selection Switch Configuration

1. Set the front panel’s Main Power switch to the Off position to turn the radio off.
2. Turn the rear panel Power switch off (“O”), and unplug the AC cable from the rear-panel [~AC IN] jack.
3. Remove the eight screws from the left and right faces of the outer case, then remove the three remaining screws that are affixing the top case, and remove the top case from the transceiver.
4. Refer to the illustration, and change the position of the speaker selection switch (the default setting is “COM” which combines the audio; “SEP” separates the Main and Sub receiver audio into the Left and Right speakers).
5. Replace the three screws on the top case, then replace the eight screws previously removed from the left and right sides of the transceiver.
6. Speaker re-configuration is now complete. You may now plug in the AC cable, and turn the rear panel and front panel Power switches back on (in that order), to resume operation.

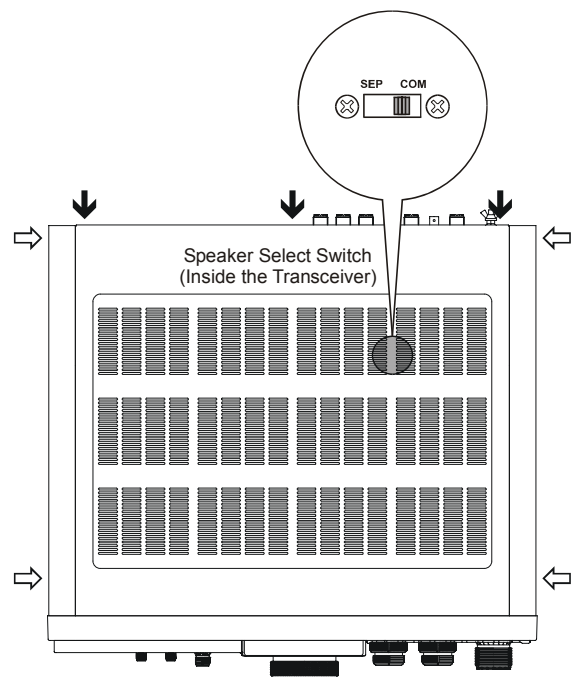
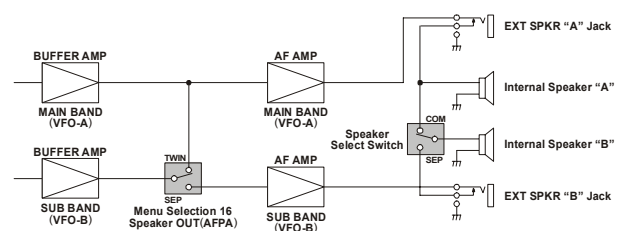

『Quick Point』

High-Quality Internal Speaker Details!

Two large-aperture, high quality speakers are incorporated into the FT DX 9000 Contest, for outstanding reproduction of the incoming audio signals. Sporting a combined aperture of 7” (184 mm), the twin 3-5/8” (92 mm) speakers are designed to enhance your operating experience with their rich tonal quality and ultra-low distortion characteristics.

DUAL RECEIVE UNIT (RXU-9000)

ADJACENT CHANNEL MONITOR (ACM) – CW MODE ONLY –

When the optional Dual Receive Unit (RXU-9000) is installed, the Adjacent Channel Monitor will be available for use (because it utilizes the second receiver to provide the ACM function). ACM utilizes the VFO-B to monitor a 2.4 kHz window outside your current CW passband (for example, 500 Hz) for the VFO-A. The peak signal strengths within this 2.4 kHz window are displayed on the VFO-B S-meter, alerting you to encroachment from other stations.

To activate the Adjacent Channel Monitor, press the **【ACM】** switch (#77). The LED imbedded in the switch will glow Red.

【Advice】

- If you do not have Dual Receive engaged, turning on the ACM feature will cause the **【RX】** LED associated with the VFO-B to become illuminated.
- When ACM is turned on, the frequency of the VFO-B will automatically be set to match that of the VFO-A.
- When operating on Dual Receive, engaging the ACM feature automatically sets the VFO-B to the same frequency as the VFO-A, and by inverting the DSP filter the VFO-B is used for monitoring (visually) for activity outside your current receiver passband on the VFO-A.

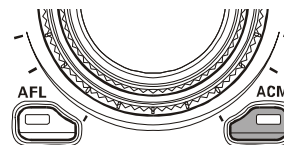
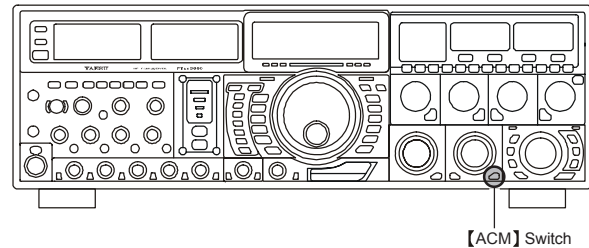

When ACM is turned on during Dual Receive operation, the audio from the VFO-B will disappear.

A typical operating circumstance where ACM can help is when you are running stations during a contest in a 250 Hz bandwidth. If stations suddenly stop calling you, it may be because another strong station has started calling CQ near your frequency. By engaging ACM, your VFO-B S-meter will display the strongest station on the area ± 1.2 kHz from your current operating frequency; if the encroaching station is sufficiently close, you might want to ask him or her kindly to QSY.

【Advice】

By rotating the VFO-B **【AF GAIN】** control (#M) fully counter-clockwise, then setting the VFO-A **【AF GAIN】** control (#73) to a comfortable listening level, you will be able to hear the desired signal within the 300 Hz passband selected.

In addition, if you rotate the VFO-A **【AF GAIN】** control fully counter-clockwise, then advance the VFO-B **【AF GAIN】** control, you will be able to hear audio from the passband 1.05 kHz on either side of the VFO-A's 300 Hz passband, but you will not hear the audio from within that 300 Hz passband. In other words, you can monitor everything outside the selected 300 Hz bandwidth, but within a 2.4 kHz window, by advancing the VFO-B **【AF GAIN】** control.

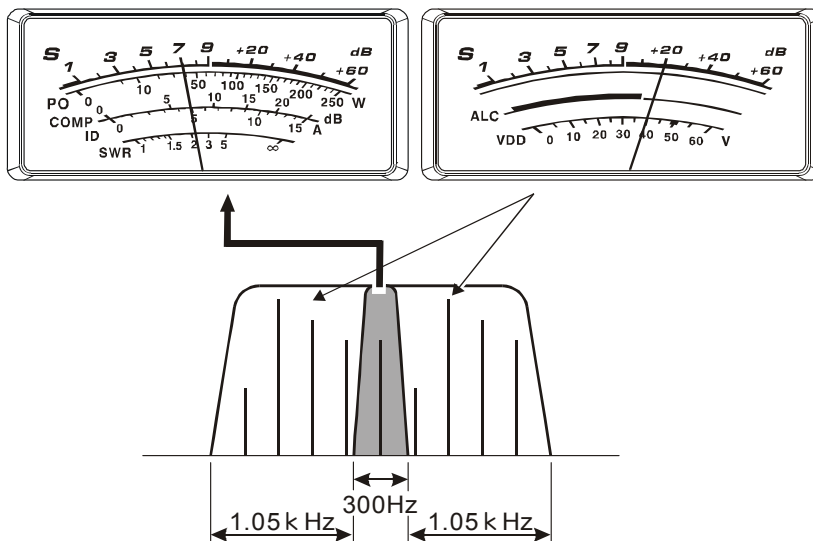

DUAL RECEIVE UNIT (RXU-9000)

RF GAIN – SSB/CW/AM MODES –

When the optional Dual Receive Unit (RXU-9000) is installed, the RF Gain levels of the VFO-A and VFO-B may be adjusted independently.

As a reminder, there is no difference in the fundamental performance of the two VFOs. Please see page 53 for details.

VFO-A RF Gain Adjustment

The VFO-A [RF GAIN] control (#73) should, initially, be rotated to the fully clockwise position. This is the point of maximum sensitivity, and counter-clockwise rotation will gradually reduce the system gain.

- As the [RF GAIN] control (#73) is rotated counter-clockwise to reduce the gain, the S-meter reading will rise. This indicates that the AGC voltage being applied to the receiver (to reduce the gain) is increasing.
- Rotating the [RF GAIN] control (#73) to the fully counter-clockwise position will essentially disable the receiver, as the gain will be greatly reduced. In this case, as well, the S-meter will appear to be “pegged” against the right edge of the analog S-meter scale.

VFO-B RF Gain Adjustment

The VFO-B [RF GAIN] control (#M) operates identically to the VFO-A RF Gain control. The effects of counter-clockwise rotation of the VFO-B RF Gain control may be observed visually on the VFO-B S-meter.

- As the [RF GAIN] control (#M) is rotated counter-clockwise to reduce the gain, the S-meter reading will rise. This indicates that the AGC voltage being applied to the receiver (to reduce the gain) is increasing.
- Rotating the [RF GAIN] control (#M) to the fully counter-clockwise position will essentially disable the receiver, as the gain will be greatly reduced. In this case, as well, the S-meter will appear to be “pegged” against the right edge of the analog S-meter scale.

『Advice』

Reception frequently can be optimized by rotating the [RF GAIN] control slightly counter-clockwise to the point where the incoming noise level is just about the same as the “stationary” meter needle position as set by the adjustment of the RF Gain control. This setting ensures that excessive gain is not being utilized, without so much gain reduction that incoming signals cannot be heard.

『Quick Point』

The RF Gain control, along with the IPO and Attenuator features, all affect the system receiver gain in different ways. As a first step in dealing with high noise or a crowded, high-level signal environment, the IPO generally should be the first feature engaged, if the frequency is low enough to allow the preamplifier to be bypassed. Thereafter, the RF Gain and Attenuator features may be employed to provide precise, delicate adjustment of the receiver gain so as to optimize performance fully.

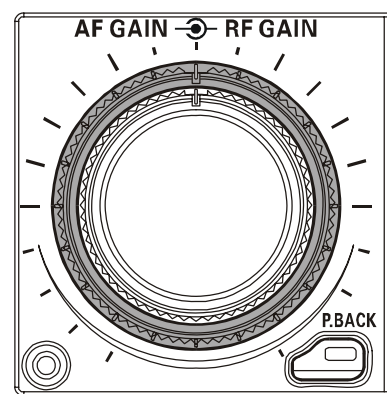
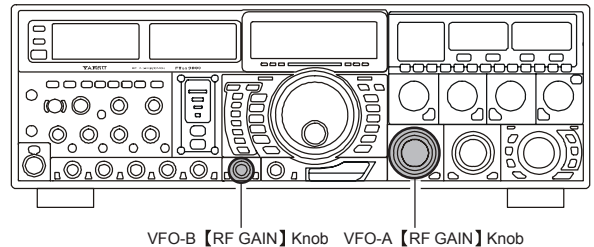

VFO-A

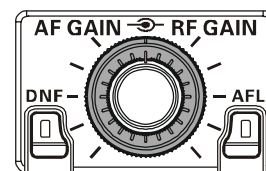

VFO-B

DUAL RECEIVE UNIT (RXU-9000)

USING THE VRF (VARIABLE RF FRONT-END FILTER)

If the optional Dual Receive Unit (**RXU-9000**) and the Sub Receiver's Variable RF Front-end Filter Unit (**VRF-9000**) are installed, you will have VRF capability either on the VFO-A and VFO-B. Operation is identical on both VFO.

As a reminder, there is no difference in the fundamental performance of the two VFOs. Please see page 54 for details.

Using VRF on VFO-A Frequency

1. Press the **[VRF/μ]** switch (#69) momentarily. The LED inside the switch will become illuminated, and the VRF system will be engaged, centered on your current Amateur band.
2. You may rotate the **[VRF/μ]** knob (#68) to skew the position of the VRF system relative to your operating frequency.
 - After moving the passband of the VRF system manually, you may re-center it on the current Amateur band by pressing and holding in the **[VRF/μ]** switch (#69) for two seconds.
3. To switch VRF off, press the **[VRF/μ]** switch (#69) momentarily again. The LED imbedded in the switch will go out, and the VRF circuit will be removed from the incoming received signal path.

Using VRF on the VFO-B Frequency

『Advice』

In order to take advantage of the Variable RF Preselector filter on the VFO-B, the optional VRF Unit (**VRF-9000**) must be installed.

1. Press the **[SUB RX]** switch (#78) to engage Dual Receive operation.

When the imbedded LED glows green, this is your confirmation that Dual Receive is in operation.
2. Press the VFO-B **[VRF]** switch (#C) to engage the VRF. The LED imbedded in the switch will light up, confirming that VRF is now in the signal path for the VFO-B.
 - The settings of the VRF are set and held in memory independently for each Amateur band, so any custom settings will be maintained despite any band changes you perform.
3. Rotation of the VFO-B **[VRF]** knob (#D) allows adjustment of the center frequency of the VRF circuit.
 - If you have made adjustments to the VRF circuit's center frequency, press and hold in the **[VRF]** switch (#C) for two seconds to re-center the VRF on the center of the Amateur band on which you currently are operating.
4. To switch VRF off, press the VFO-B **[VRF]** switch (#C) momentarily again. The LED imbedded in the switch will go out, and the VRF circuit will be removed from the VFO-B incoming signal path.

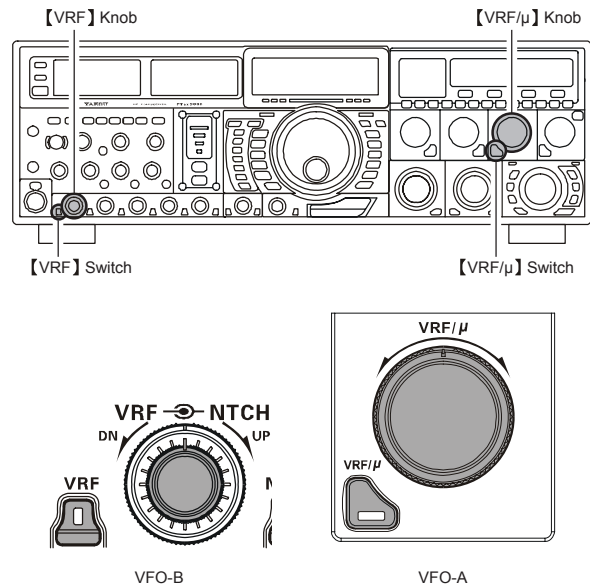

DUAL RECEIVE UNIT (RXU-9000)

ROOFING/R.FLT (ROOFING FILTERS)

If the optional Dual Receive Unit (**RXU-9000**) is installed, three Roofing Filters are available for selection in each VFO (VFO-A and VFO-B). Operation is identical on either VFO.

As a reminder, there is no difference in the fundamental performance of the two VFOs. Please see page 55 for details.

VFO-A Roofing Filter Operation

Press the VFO-A **【ROOFING】** switch (#25) to toggle the Roofing Filter selection.

AUTO → 15kHz → 6kHz → 3kHz → AUTO

- As you repeatedly press this switch, you will observe different LEDs lighting up in the Roofing Filter area of the front panel, denoting the Roofing Filter currently in use. Also, the selected Roofing Filter bandwidth will be indicated on the LCD.
- Typically, this selection will be set to “AUTO.”
- The Roofing Filter selection will be memorized independently on each VFO in the VFO stack.

VFO-B Roofing Filter Operation

1. Pressing the **【SUB RX】** switch (#79) will engage Dual Receive operation.

When the imbedded LED glows green, this is your confirmation that Dual Receive is in operation.

2. Press the VFO-B **【R.FLT】** switch (#A) to toggle the Roofing Filter selection.

AUTO → 15kHz → 6kHz → 3kHz → AUTO

- As you repeatedly press the **【R.FLT】** switch (#A), the selected bandwidth will appear on the LCD.
- Typically, this selection will be set to “AUTO.”
- When “AUTO” is selected, the LED imbedded in the switch will go out (there always is a roofing filter in the receiver path).
- The Roofing Filter selection will be memorized independently on each VFO in the VFO stack.

『Quick Point』

- The “AUTO” selection of the Roofing Filter is based on the operating mode. However, you may override the automatic selection, if band conditions warrant a different (usually, a tighter) selection.
- The AUTO mode Roofing Filter selections are shown below:

AM/FM/FM-PKT	15kHz
LSB/USB/PKT	6kHz
CW/RTTY	3kHz

- When the Roofing filter mode is set to “AUTO” and the Noise Blanker is turned On, the Roofing Filter bandwidth will automatically be set to 15 kHz, as this setting provides the most effective noise blanking. However, you still may override the automatic setting, and select a more narrow Roofing Filter. Noise blanking may be compromised, however, with a tighter Roofing Filter in the line.

Roofing Filter bandwidth will be indicated on the LCD

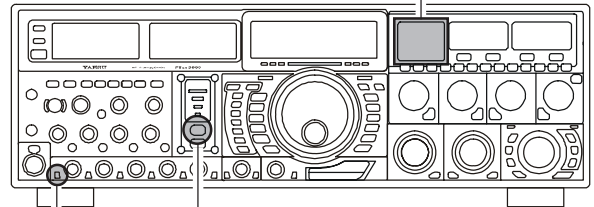

【R.FLT】 Switch 【ROOFING】 Switch

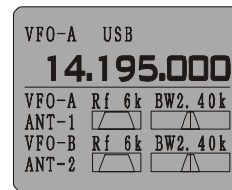

Roofing Filter bandwidth will be indicated on the TFT



VFO-B

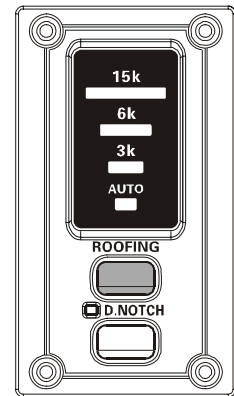

VFO-A

DUAL RECEIVE UNIT (RXU-9000)

CONTOUR/CONT (CONTOUR) CONTROL OPERATION

If the optional Dual Receive Unit (**RXU-9000**) is installed, “Contour” tuning is available on both the VFO-A and VFO-B receivers. Operation is identical on either VFO.

As a reminder, there is no difference in the fundamental performance of the two VFOs. Please see page 56 for details.

Using Contour on the VFO-A Receiver

1. Press the VFO-A **【CONT】** switch (#65). The LED imbedded in the switch will glow Red to confirm that the Contour filter is engaged.
2. Rotate the VFO-A **【CONTOUR】** knob (#64) to achieve the most natural-sounding audio reproduction on the incoming signal.

To cancel Contour tuning, press the VFO-A **【CONT】** switch (#65) once more.

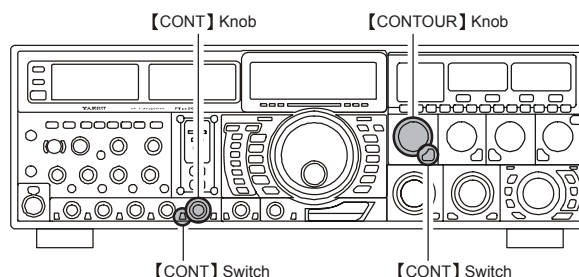

Using Contour on the VFO-B Receiver

1. Pressing the **【SUB RX】** switch (#78) will engage Dual Receive operation. When the imbedded LED glows green, this is your confirmation that Dual Receive is in operation.
2. Press the VFO-B **【CONT】** switch (#1). The LED imbedded in the switch will glow Orange, confirming that the Contour filter is engaged.
3. Rotate the VFO-B **【CONT】** knob (#J) to achieve the most natural-sounding audio reproduction on the incoming signal.

To cancel Contour tuning, press the VFO-B **【CONT】** switch (#1) once more.

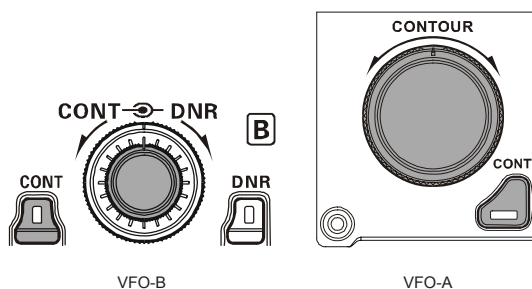

DUAL RECEIVE UNIT (RXU-9000)

IF SHIFT OPERATION – SSB/CW/RTTY/PKT MODES –

If the optional Dual Receive Unit (RXU-9000) is installed, IF Shift operation is available on both the VFO-A and VFO-B. Operation is identical on either VFO.

As a reminder, there is no difference in the fundamental performance of the two VFOs. Please see page 57 for details.

VFO-A Band IF Shift Operation

Rotate the VFO-A **【SHIFT】** (#76) control to the left or right to reduce the interference.

VFO-B Band IF Shift Operation

1. Pressing the **【SUB RX】** switch (#78) will engage Dual Receive operation.

When the imbedded LED glows green, this is your confirmation that Dual Receive is in operation.

2. Rotate the VFO-B **【SHIFT】** (#H) control to the left or right to reduce the interference.

『Advice』

The position of the IF Shift system may be observed on the LCD display.

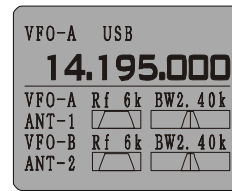
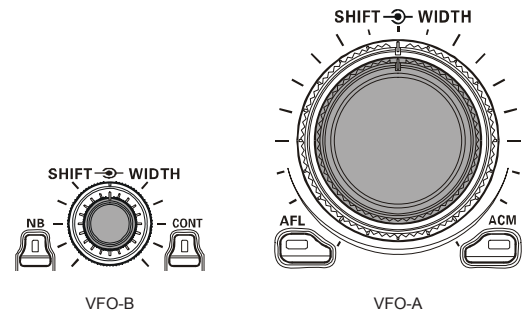
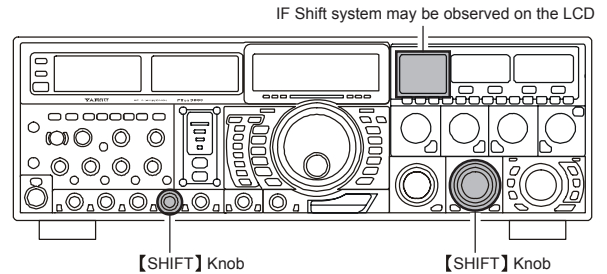

IF Shift system may be observed on the LCD

DUAL RECEIVE UNIT (RXU-9000)

WIDTH (IF DSP BANDWIDTH) TUNING – SSB/CW/RTTY/PKT MODES –

If the optional Dual Receive Unit (RXU-9000) is installed, IF Width operation is available on both the VFO-A and VFO-B. Operation is identical on either VFO.

As a reminder, there is no difference in the fundamental performance of the two VFOs. Please see page 58 for details.

VFO-A Band IF Width Operation

Rotate the VFO-A **【WIDTH】** knob (#76) to adjust the bandwidth. Counter-clockwise rotation reduces the bandwidth, while clockwise rotation increases the bandwidth.

Sub (VFO-B) Band IF Width Operation

- Pressing the **【SUB RX】** switch (#78) will engage Dual Receive operation.
When the imbedded LED glows green, this is your confirmation that Dual Receive is in operation.
- Rotate the VFO-B **【WIDTH】** knob (#79) to adjust the bandwidth. Counter-clockwise rotation reduces the bandwidth, while clockwise rotation increases the bandwidth.

『Advice』

You may observe the effects of adjustment of the **【WIDTH】** control on the LCD display.

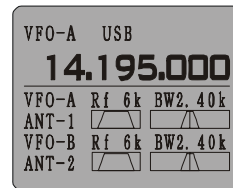
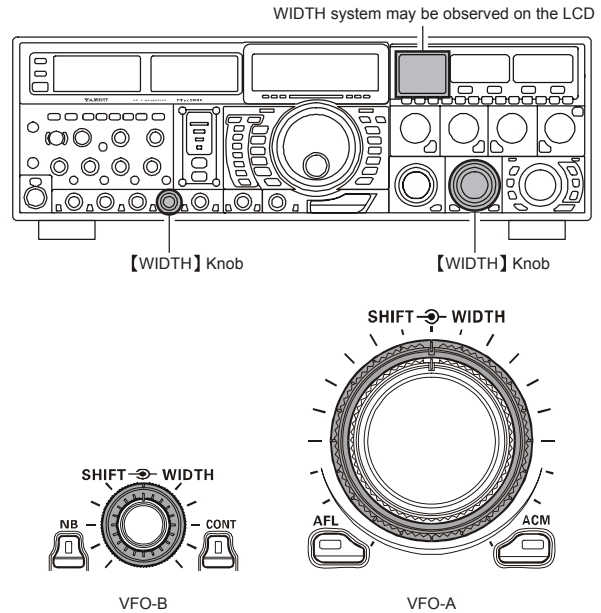

WIDTH system may be observed on the LCD

DUAL RECEIVE UNIT (RXU-9000)

IF NOTCH FILTER OPERATION – SSB/CW/RTTY/PKT/AM MODES –

If the optional Dual Receive Unit (**RXU-9000**) is installed, IF Notch operation is available on both the VFO-A and VFO-B. Operation is identical on either VFO.

As a reminder, there is no difference in the fundamental performance of the two VFOs. Please see page 59 for details.

VFO-A Band IF Notch Operation

1. Press the VFO-A **【NOTCH】** switch (#**71**). The LED imbedded in the switch will glow Red to confirm that the IF Notch filter has been engaged.
2. Rotate the VFO-A **【NOTCH】** knob (#**70**) to null out the interfering carrier.

To switch the IF Notch filter off, press the VFO-A **【NOTCH】** switch (#**71**) once more. The LED imbedded in the switch will turn off, confirming that the IF Notch filter is no longer operating.

Sub (VFO-B) Band IF Notch Operation

1. Pressing the **【SUB RX】** switch (#**78**) will engage Dual Receive operation.
When the imbedded LED glows green, this is your confirmation that Dual Receive is in operation.
2. Press the VFO-B **【NTCH】** switch (#**E**). The LED imbedded in the switch will glow Umber to confirm that the IF Notch filter has been engaged.
3. Rotate the VFO-B **【NTCH】** knob (#**F**) to null out the interfering carrier.

To switch the IF Notch filter off, press the VFO-B **【NTCH】** switch (#**E**) once more. The LED imbedded in the switch will turn off, confirming that the IF Notch filter is no longer operating.

『Note』

When the **【NTCH】** switch is pressed and held in for two seconds, the center of the notch action will be reset to the positions described below (mode-sensitive):

- SSB/AM: The Notch will center at 1.5 kHz (center of the receiver passband).
- CW: The Notch will center on the frequency programmed by the **【PITCH】** knob (#**14**).

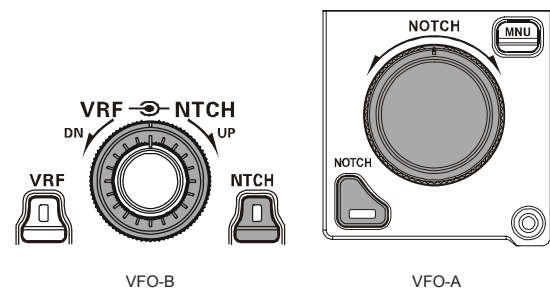
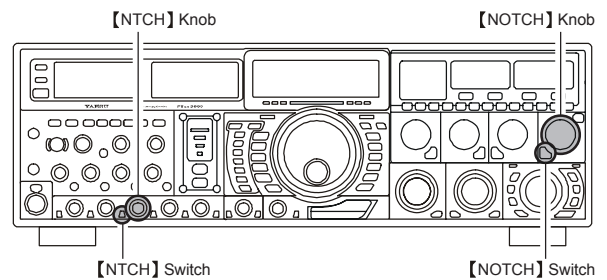

DUAL RECEIVE UNIT (RXU-9000)

NR/DNR (DIGITAL NOISE REDUCTION) OPERATION

If the optional Dual Receive Unit (RXU-9000) is installed, Digital Noise Reduction operation is available on both the VFO-A and VFO-B. Operation is identical on either VFO.

As a reminder, there is no difference in the fundamental performance of the two VFOs. Please see page 60 for details.

VFO-A Band DNR Operation

1. Press the VFO-A **【NR】** switch (#67). The LED imbedded in the switch will glow Red, confirming that the DNR system is engaged.
2. Rotate the VFO-A **【NR】** knob (#66) to select the setting that most effectively reduces the noise level.

To disable the DNR system, press the VFO-A **【NR】** switch (#67) once more. The imbedded LED will turn off, confirming that the DNR system is not active.

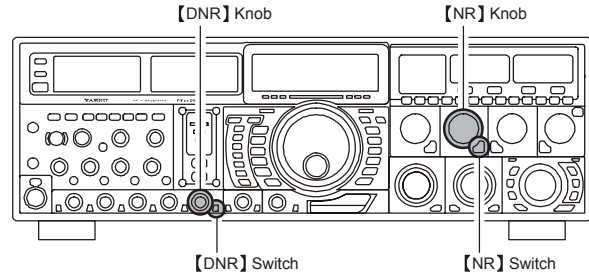

VFO-B Band DNR Operation

1. Pressing the **【SUB RX】** switch (#78) will engage Dual Receive operation. When the imbedded LED glows green, this is your confirmation that Dual Receive is in operation.
2. Press the VFO-B **【DNR】** switch (#K). The LED imbedded in the switch will glow Umber, confirming that the DNR system is engaged.
3. Rotate the VFO-B **【DNR】** knob (#J) to select the setting that most effectively reduces the noise level.

To disable the DNR system, press the VFO-B **【DNR】** switch (#K) once more. The imbedded LED will turn off, confirming that the DNR system is not active.

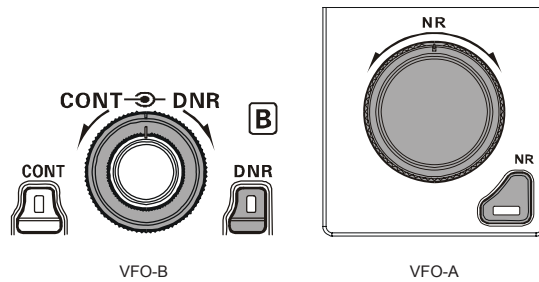

DUAL RECEIVE UNIT (RXU-9000)

D.NOTCH/DNF (DIGITAL NOTCH FILTER) OPERATION

If the optional Dual Receive Unit (**RXU-9000**) is installed, Digital Automatic Notch Filter operation is available on both the VFO-A and VFO-B. Operation is identical on either VFO.

As a reminder, there is no difference in the fundamental performance of the two VFOs. Please see page 62 for details.

VFO-A Band DNF Operation

Press the VFO-A **[D.NOTCH]** switch (#26) to engage the Digital Notch filter. The LED imbedded in the switch will glow Red, to confirm that the DNF circuit is engaged.

To cancel DNF operation, press the VFO-A **[D.NOTCH]** switch (#26) once more. The imbedded LED will go out, confirming that the Digital Notch Filter is no longer in operation.

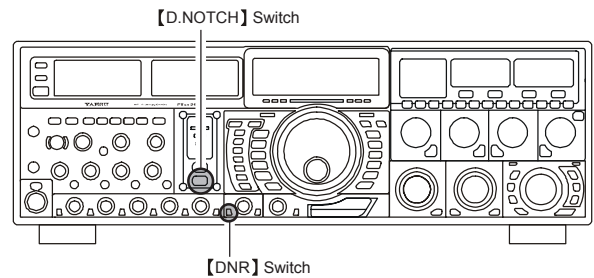

Sub (VFO-B) Band DNF Operation

1. Pressing the **[SUB RX]** switch (#78) will engage Dual Receive operation.
When the imbedded LED glows green, this is your confirmation that Dual Receive is in operation.
2. Press the VFO-B **[DNF]** switch (#L) to engage the Digital Notch filter. The LED imbedded in the switch will glow Umber, to confirm that the DNF circuit is engaged.

To cancel DNF operation, press the VFO-B **[DNF]** switch (#L) once more. The imbedded LED will go out, confirming that the Digital Notch Filter is no longer in operation.

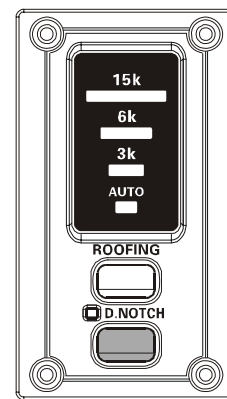

VFO-A

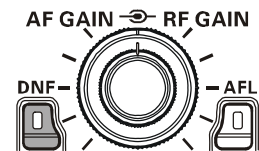

VFO-B

DUAL RECEIVE UNIT (RXU-9000)

IF NOISE BLANKE (NB) OPERATION

If the optional Dual Receive Unit (RXU-9000) is installed, IF Noise Blanker operation is available on both the VFO-A and VFO-B. Operation is identical on either VFO.

As a reminder, there is no difference in the fundamental performance of the two VFOs. Please see page 62 for details.

VFO-A Band NB Operation

1. Press the VFO-A **[NB]** switch (#22) momentarily to reduce a short pulse noise such as from switching transients, automobile ignitions and power lines. The LED imbedded in the switch will glow Red to confirm that the Narrow-NB is operating.
Press and hold the VFO-A **[NB]** switch (#22) for two seconds to reduce a longer duration man-made pulse noise. The LED imbedded in the switch will glow Yellow to confirm that the Wide-NB is operating.
2. Advance the VFO-A **[NB]** control (#21) to the point where the offending ignition noise is best reduced or eliminated.

To end Noise Blanker operation, press the VFO-A **[NB]** switch (#22) once more. The LED imbedded in the switch will turn off, confirming that the Noise Blanker is no longer in operation.

VFO-B Band NB Operation

1. Pressing the **[SUB RX]** switch (#78) will engage Dual Receive operation.
When the imbedded LED glows green, this is your confirmation that Dual Receive is in operation.
2. Press the VFO-B **[NB]** switch (#3) momentarily to reduce a short pulse noise such as from switching transients, automobile ignitions and power lines. The LED imbedded in the switch will glow Umber to confirm that the Narrow-NB is operating.
Press and hold the VFO-B **[NB]** switch (#3) for two seconds to reduce a longer duration man-made pulse noise. The LED imbedded in the switch will glow Yellow to confirm that the Wide-NB is operating.
3. Advance the VFO-B **[NB]** control (#F) to the point where the offending ignition noise is best reduced or eliminated.

To end Noise Blanker operation, press the VFO-B **[NB]** (#3) switch once more. The LED imbedded in the switch will turn off, confirming that the Noise Blanker is no longer in operation.

『Advice』

When the Roofing filter mode is set to “AUTO” and the Noise Blanker is turned On, the Roofing Filter bandwidth will automatically be set to 15 kHz. However, you still may override the automatic setting, and select a more narrow Roofing Filter.

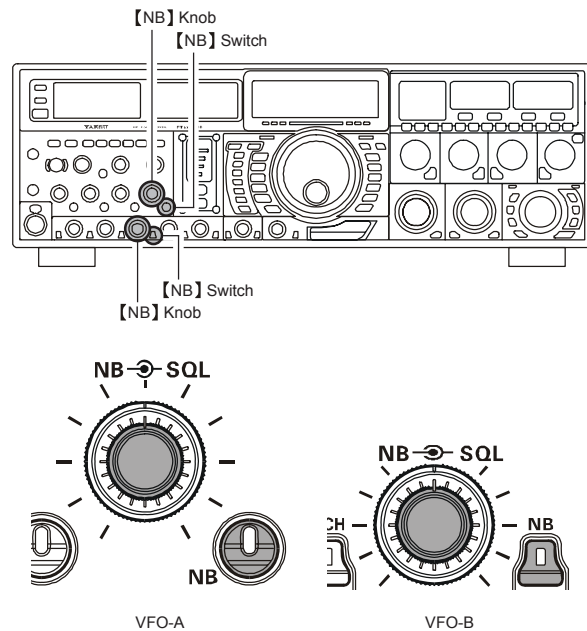

DUAL RECEIVE UNIT (RXU-9000)

AGC (AUTOMATIC GAIN CONTROL)

If the optional dual Receive Unit (RXU-9000) is installed, AGC operation is identical on either VFO.

As a reminder, there is no difference in the fundamental performance of the two VFOs. Please see page 63 for details.

VFO-A Band AGC Selection

Rotate the VFO-A **AGC** switch (#13) to select the desired receiver-recovery time constant. For most operation, we recommend the "AUTO" mode.

VFO-B Band AGC Selection

1. Pressing the **SUB RX** switch (#78) will engage Dual Receive operation.
When the imbedded LED grows green, this is your confirmation that Dual Receive is in operation.
2. Rotate the VFO-B **AGC** switch (#B) to select the desired receiver-recovery time constant.

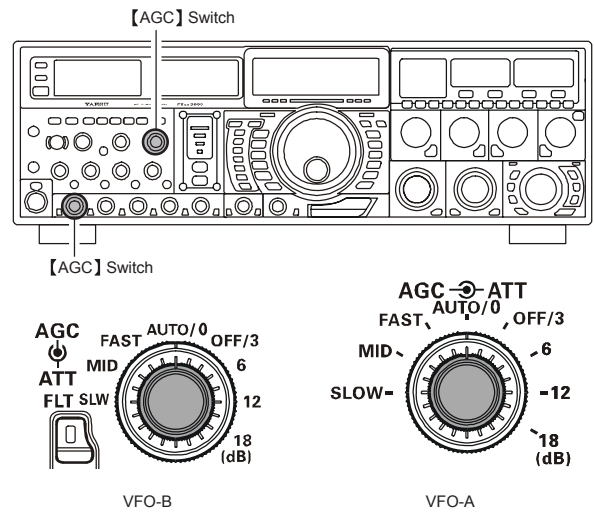

MUTE FEATURE - VFO-A -

If the optional Dual Receive Unit (RXU-9000) is installed, during Dual Receive operation it is possible to mute the VFO-A audio temporarily, without touching the setting of the **AF GAIN** control (#73) for the VFO-A.

This capability is particularly useful if you wish to concentrate on the signal being received on the VFO-B during Dual Receive operation.

Press the VFO-A band's **RX** LED/switch (#32).

The VFO-A audio will be silenced, and the green LED in the **RX** switch (#32) will blink. To restore reception on the VFO-A, just press the blinking **RX** switch/LED (#32) once more.

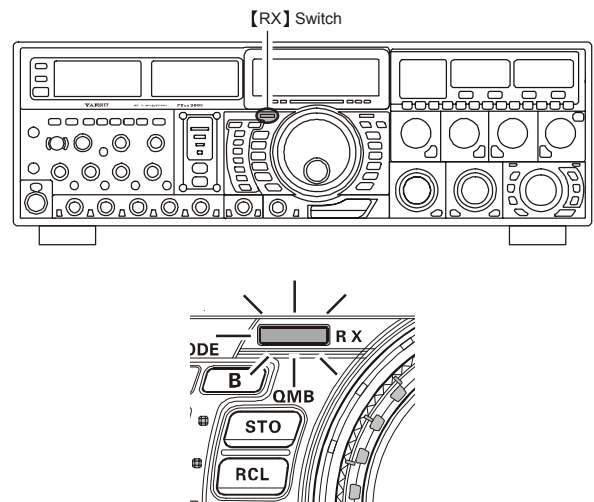

DUAL RECEIVE UNIT (RXU-9000)

AUDIO LIMITER (AFL) FEATURE

If the optional Dual Receive Unit (**RXU-9000**) is installed, the Audio Limiter (AFL) feature is available on both the VFO-A and VFO-B.

As a reminder, there is no difference in the fundamental performance of the two VFOs. Please see page 65 for details.

VFO-A Band AFL Setup

Press the VFO-A **[AFL]** switch (#75) to turn on the Audio Limiter. The imbedded LED in the button will glow red.

To disable the Audio limiter, press the **[AFL]** switch once more; the imbedded LED will turn off.

VFO-B Band AFL Setup

- Pressing the **[SUB RX]** switch (#78) will engage Dual Receive operation.
When the imbedded LED glows green, this is your confirmation that Dual Receive is in operation.
- Press the VFO-B **[AFL]** switch (#N) to turn on the Audio Limiter. The imbedded LED in the button will glow Umber.

To disable the Audio limiter, press the **[AFL]** switch once more; the imbedded LED will turn off.

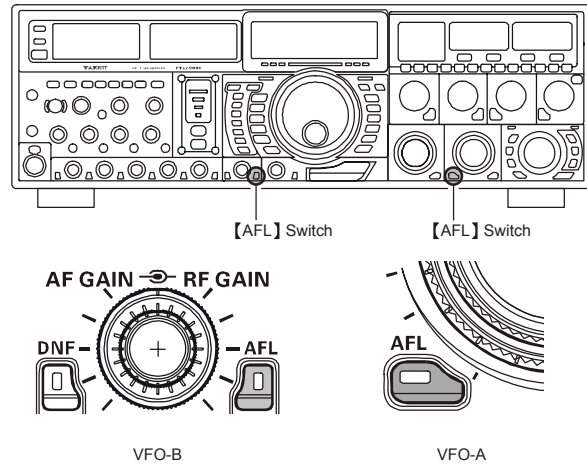

ATT

If the optional Dual Receive Unit (**RXU-9000**) is installed, the RF Attenuator (ATT) feature is available on both the VFO-A and VFO-B.

As a reminder, there is no difference in the fundamental performance of the two VFOs. Please see page 52 for details.

VFO-A Attenuator Setup

Rotate the VFO-A **[ATT]** switch (#13) to set the desired attenuation level.

To restore full signal strength through the Attenuator circuit area, set the **[ATT]** switch to the "0" position.

VFO-B Attenuator Setup

Rotate the VFO-B **[ATT]** switch (#B) to set the desired attenuation level.

To restore full signal strength through the Attenuator circuit area, set the **[ATT]** switch to the "0" position.

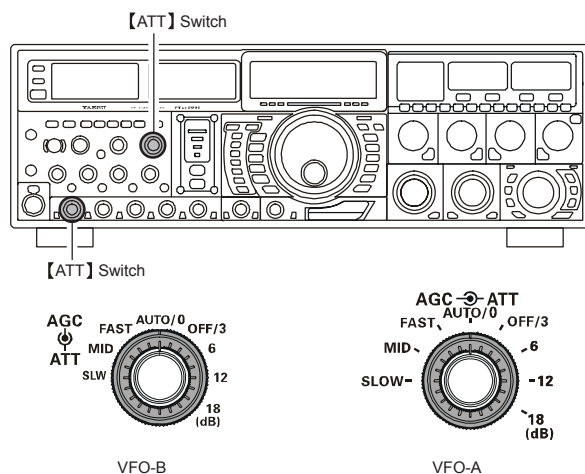

DUAL RECEIVE UNIT (RXU-9000)

NOTE

RF μ -TUNING UNITS (MTU-160, MTU-80/40, MTU-30/20)

The optional RF μ -Tuning Units provide ultra-sharp RF selectivity for the VFO-A. The high Q is made possible by the narrow-band design; one μ -Tune module is required for the 1.8 MHz band (**MTU-160**), while the 3.5 and 7 MHz bands are covered by the **MTU-80/40**, and the 10.1 and 14 MHz bands are covered by the **MTU-30/20**.

When one of three optional units is installed, it will automatically be adjusted so as to center on your operating frequency. The narrow bandwidth is especially useful on the low bands, where many strong signals being received via NVIS propagation (Near Vertical-Incidence Signals) within a narrow bandwidth, and the added protection at the RF stage is especially helpful in preventing IMD and blocking.

The μ -Tuning circuitry, with a Q and shape factor much higher than that afforded even by VRF, can also be manually adjusted to provide relief against interference as close as 10 kHz away. The insertion loss of the μ -Tune filters is higher than that of the VRF circuit, so if Noise Figure is a concern you may select the VRF circuit, instead of μ -Tuning, via the Menu.

『Note』

The μ -Tuning modules are available only for the VFO-A, and only function up through the 14 MHz band. On the 18 MHz and higher Amateur bands, the VRF circuitry is utilized.

μ -Tune Operation on the VFO-A Receiver

1. Press the **【VRF/ μ 】** switch (#69). The imbedded Red LED will light up.
 - The μ -Tune circuit will automatically align itself onto your operating frequency.
 - Remember that μ -Tune only operates on the VFO-A band on the 14 MHz and lower bands.
2. Now rotate the **【VRF/ μ 】** knob (#68) to peak the response (background noise) or reduce interference.
 - The amount of change in the center frequency of the μ -Tune filter, when rotating the **【VRF/ μ 】** knob by one click, can be configured using Menu item “**GENERAL 035 μ TUNE DIAL STEP.**”
3. Press the **【VRF/ μ 】** switch (momentarily) once more to disengage the μ -Tune filter; the imbedded Red LED will switch off. In this mode, only the fixed bandpass filter for the current band will be engaged.

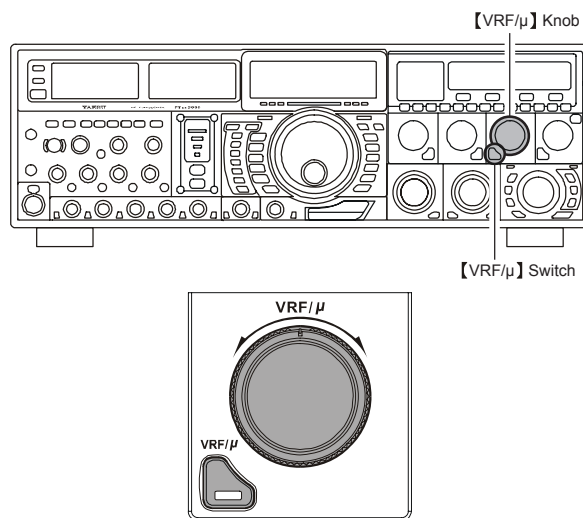

『Advice』

- The μ -Tune filters are the most advanced, selective RF preselector filters ever incorporated into an Amateur Radio transceiver. The RF selectivity provided by μ -Tune can be of tremendous value in ensuring quiet, intermod-free reception even in the most crowded bands on a contest weekend. The μ -Tune filters provide RF selectivity on the order of a few dozen kHz at -6 dB, at the expense of a few dB of system gain on bands where noise figure is seldom an issue. You will notice that the S-meter deflection, when μ -Tune is engaged, is slightly less than when it is out of the circuit; this is normal. If your antenna system gain is so low as to make it impossible to hear band noise when μ -Tune is engaged (highly unlikely), just switch it out or revert to the VRF system, which has slightly less insertion loss.
- As you tune around on an amateur band with μ -Tune engaged, the microprocessor automatically commands the stepper motor driving the toroid core stack to center the filter on your current operating frequency (the tuning resolution is 5 kHz). You may, however, use the **【VRF/ μ 】** knob (#68) to skew the filter response to one side or the other from your operating frequency, to deal with heavy interference on one side. To re-center the μ -Tune filter on your operating frequency, and eliminate any offset, press and hold in the **【VRF/ μ 】** switch (#69) for two seconds.
- While μ -Tune is a superior RF preselection circuit, it may be disabled via the Menu; if this is done, the VRF circuit will engage when the **【VRF/ μ 】** switch is pressed. To disable μ -Tune, go to Menu item “**GENERAL 035 μ TUNE DIAL STEP**” and set the selection to “OFF.”

『Quick Note』

The permeability-tuning concept utilized in the μ -Tune circuit dates back many decades, as it was incorporated in such classic transceivers as the FT-101 and FT-901 series, in addition to the FT DX 400 and similar models. The μ -Tune circuit in the FT DX 9000 is the highest development of this circuit concept ever employed in an Amateur transceiver.

RF μ -TUNING UNITS (MTU-160, MTU-80/40, MTU-30/20)

μ -Tune and VRF: Comparisons to Fixed Bandpass Filters

μ -Tune

Inspection of the illustrations to the right will demonstrate the profound advantage of the μ -Tune circuit. In illustration [A], the gray area represents the passband of a typical fixed bandpass filter covering the 1.8 ~ 3 MHz range; this is typical of the kind of bandpass filter found in many high-quality HF receivers today. Note also the hypothetical distribution of signals across the 160-meter band.

In illustration [B], note the narrow white segment within the gray passband of the fixed BPF. These narrow segments represent the typical bandwidth of the μ -Tune filter, and one can see that the passband has been reduced from about 750 kHz in the case of the fixed BPF) to a few dozen kHz when μ -Tune is engaged. The vast majority of the incoming signals are outside the passband of the high-Q μ -Tune filter, and they will not impinge on any of the RF/IF amplifiers, the mixers, or the DSP. Very strong out-of-band signals like this can cause Intermodulation, blocking, and an elevated noise floor for a receiver.

VRF

In this example, illustration [a] depicts a typical fixed bandpass filter covering 14.5 to 22 MHz, and once again the gray shaded area depicts the fixed bandpass filter's frequency coverage. The vertical lines in the illustration, once again, represent hypothetical signals throughout this frequency range.

Figure [b] shows the same fixed BPF, with the white area representing the typical passband of the VRF filter operating in the same frequency range. Although the selectivity of the VRF is not as tight as that of the μ -Tune filter, the RF selectivity of the VRF preselector is still magnitudes better than that of the usual fixed bandpass filter, affording significant protection against the ingress of high signal voltage from strong out-of-band signals.

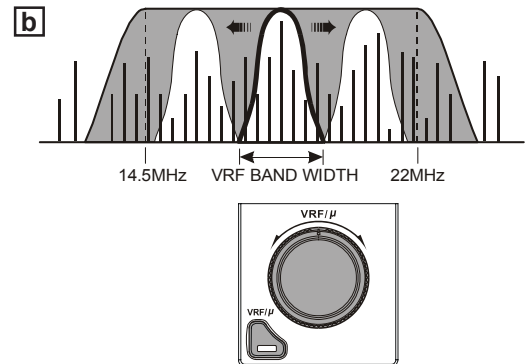
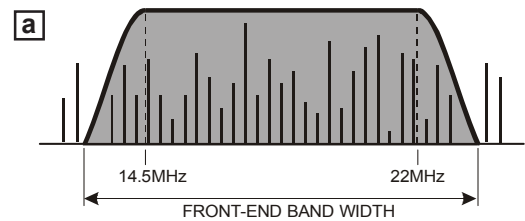
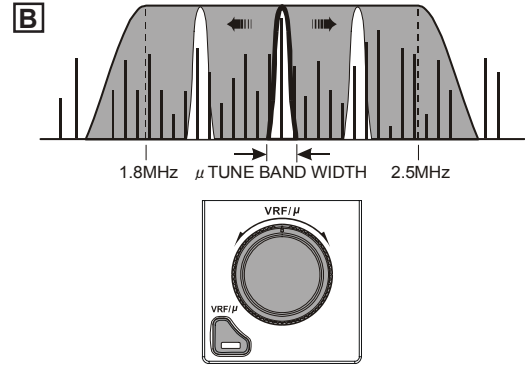
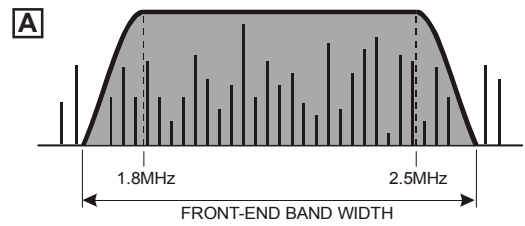

『Advice』

With μ -Tuning, the center frequency of the filter is continuously adjustable throughout its operating range, and the quality L/C components ensure a tight passband due to the high Q of the circuit. The RF preselection design task involves not only the selection of quality L/C components, but the crafting of a tuning mechanism and tuning concept that preserves system Q (thus assuring a tight bandwidth) while providing a wide operating frequency range and consistent, automated tuning. The smooth tuning is achieved by varying the inductance over a wide range; this is accomplished by motor-driving a large 1.1" (28 mm) ferrite core stack through a 2" high (50 mm) coil structure. Three μ -Tune modules provide coverage of the 160, 80/40, and 30/20 meter bands on the FT DX 9000, and the Q of this circuit, being over 300, yields unmatched RF selectivity for outstanding rejection of undesired signals.

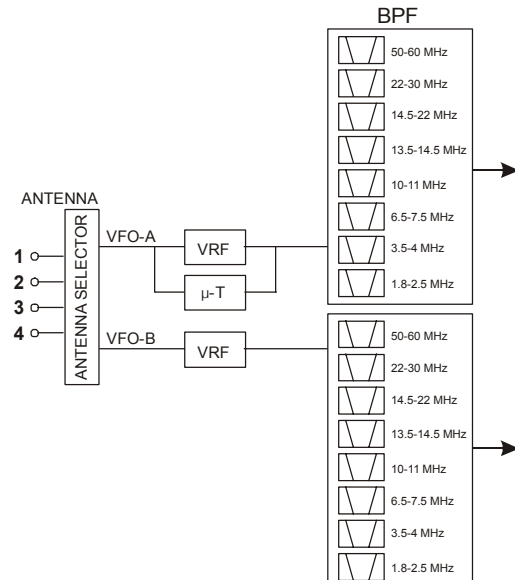

OPTIONAL DATA MANAGEMENT UNIT (DMU-9000) TFT DISPLAY UNIT (TFT-9000)

When the optional Data Management Unit (DMU-9000) and TFT Display Unit (TFT-9000) are installed, a wide range of informational displays are available on the various pages of the TFT:

- World Clock Page
- Spectrum Scope Page
- Audio Scope/Oscilloscope Page
- Log Book Page
- Temperature and SWR Status Page
- Rotator Control Page
- Memory Channel list Page

The ability to use the TFT display screen makes setup, adjustment, and monitoring of the various operational features of the transceiver easy and efficient. For details of the operation with respect to the TFT and the Data Management Unit, please refer to the “TFT Operating Manual.”

When the TFT is installed, the layout of the front panel of the transceiver changes to conform to the illustration below.

FRONT PANEL CONTROLS

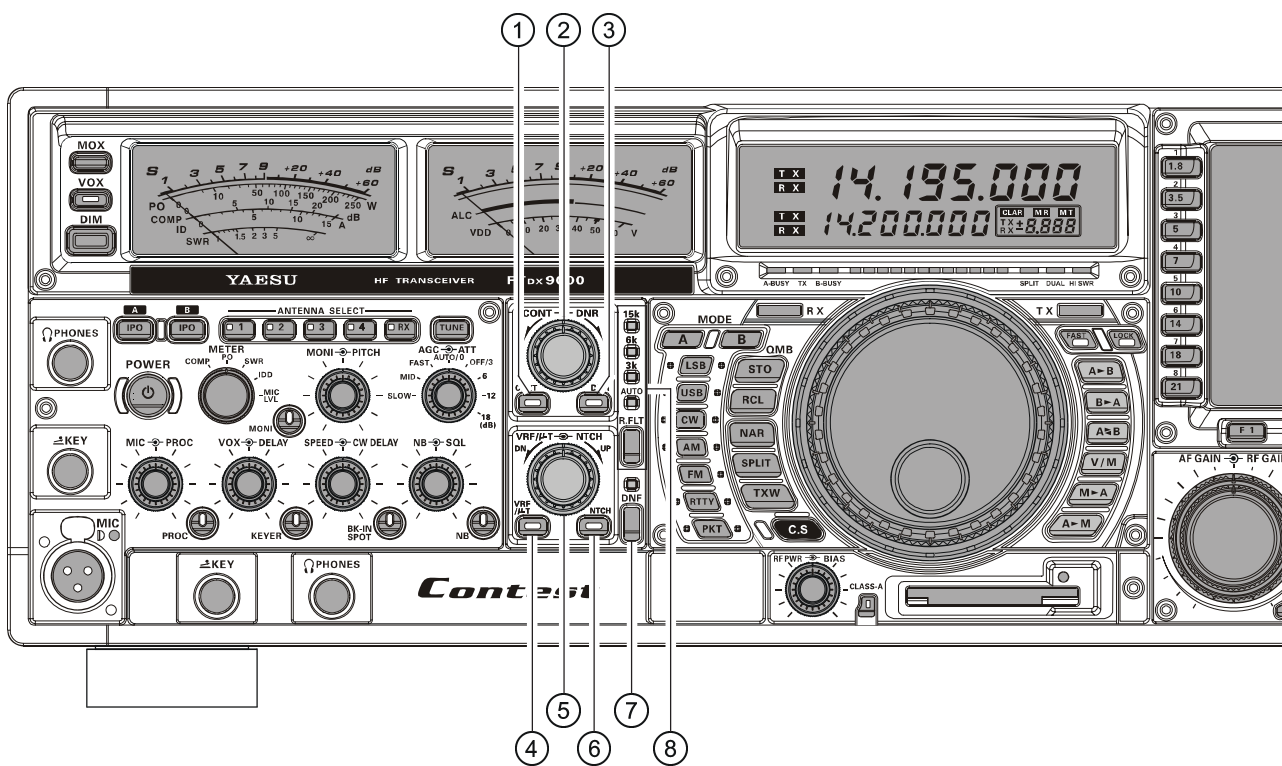

- ① **CONT Button**
This button turns the VFO-A CONTOUR filter on and off.
- ② **CONT-DNR Knob**
CONT Knob
The inner **CONT** knob selects the desired VFO-A CONTOUR filter response.
DNR Knob
The outer **DNR** knob selects the optimum VFO-A Digital Noise Reduction response.
- ③ **DNF Switch**
This button turns the VFO-A Digital Notch Filter on and off.
- ④ **VRF/μ-T Switch**
This button turns the VFO-A receiver’s VRF filter on and off.
『Advice』
When the μ-Tune Unit is installed, this switch serves as the On/Off switch for the μ-Tune feature.
- ⑤ **VRF/μ-T-NTCH Knobs**
VRF/μ-T Knob
The inner **VRF/μ-T** knob provides adjustment of the VRF (Variable RF Filter) preselector circuit.
NTCH Knob
The outer **NTCH** knob adjusts the center frequency of the VFO-A IF notch filter.

FRONT PANEL CONTROLS

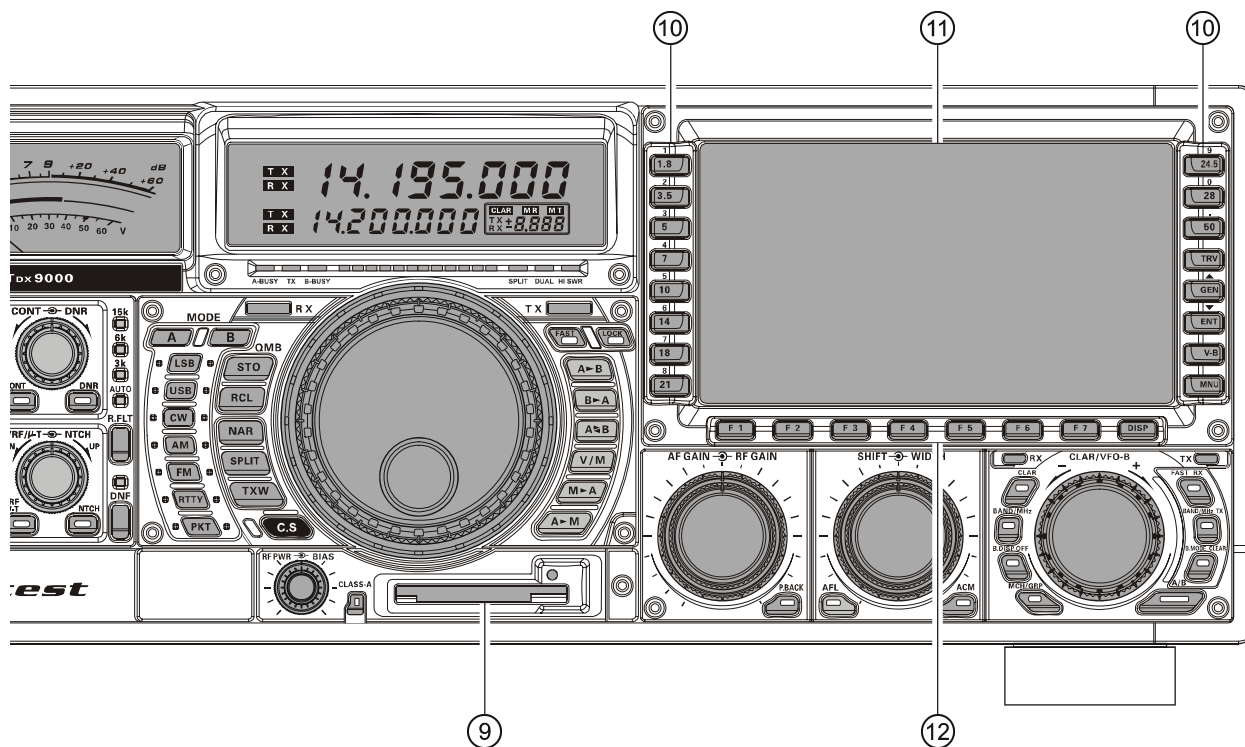

⑥ NTCH Switch

This button turns the VFO-A IF notch filter on and off.

⑦ DNF Switch

This button turns the VFO-A Digital Notch Filter on and off.

⑧ R.FLT Switch

This button selects the bandwidth for the VFO-A receiver's first IF Roofing Filter.

⑨ CF Card Slot

This slot accepts the supplied Compact Flash (CF) Card, which allows storage, transfer, and recall of transceiver configuration data and operator preferences, along with Log Book data, etc. When the CF Card is successfully inserted, the Red LED by the slot will light up.

To remove the card out from slot, press the small push-button at the right hand side of the slot.

『Advice』

If you get the [PLEASE CHECK A DISK] error message to the right of the MEM CARD indication on the TFT, check the position of the CF Card in the slot for proper alignment.

⑩ BAND Key

These keys allow one-touch selection of the desired Amateur band (1.8 ~ 50 MHz).

What's more, the [0] ~ [9] keys may be used for direct entry of a desired operating frequency during VFO operation.

⑪ TFT Display (see next page)

This 6.5-inch TFT display is used for viewing and control of a variety of features, and it includes pages including a World Map, World Clock, Spectrum Scope, SWR and Transmitter Status, Log Book, Audio Scope and Oscilloscope, Memory Channel listing, and Menu listings, plus much more.

⑫ [F1] ~ [F7] / [DISP] Keys

[F1] ~ [F7] Key

These keys are used for selection of a variety of functions, depending on the TFT operation page selected. The actual selection available at any given time is shown on the TFT, just above the function key.

[DISP] (Display) Key

This key is used for selection of the desired TFT operation page.

TFT FEATURE / CONTROL DETAILS

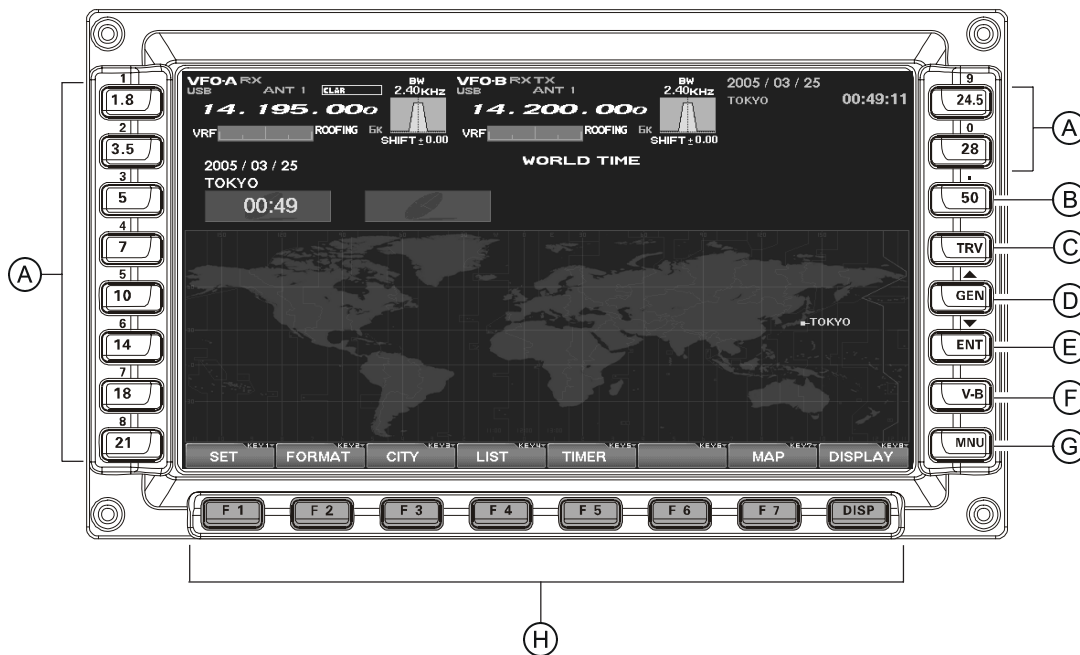

- (A) Pressing any of these keys provides one-touch access to the Amateur bands from 1.8 ~ 28 MHz. When the **【ENT】** key has been pressed first, these keys then serve as the frequency entry digits (“1” ~ “0”) during direct frequency entry.
- (B) Pressing this key provides one-touch access to the 50 MHz Amateur band. When the **【ENT】** key has been pushed first, to engage direct frequency entry, pressing this key sets the decimal point after the “MHz” portion of the frequency.
- (C) This key turns the 28 MHz low-level (0 dBm) output from the rear-panel’s TRV jack ON or OFF. When the Transverter function is turned on, both the TFT and the main frequency display will show the converted frequency’s last two digits of the “MHz” field, according to the band programmed via Menu #034 (for example, if your transverted frequency is 144.200.00 MHz, the display will show “44.200.00” as the operating frequency).
- (D) Pressing this key selects the “General Coverage” VFO register, for reception outside the Amateur bands.
- (E) Pressing this key momentarily engages the “direct frequency entry” mode of operation, whereby the keys described in the (A) and (B) sections above are used for directly programming the operating frequency. Once the frequency has been successfully entered, press the **【ENT】** key once more to exit to the newly-selected frequency.
- (F) For entering a frequency directly into the VFO-B register, press this key. Then use the keys described in sections (A) and (B) above for entering the digits of the desired frequency; when done, press the **【V-B】** key once more to lock the newly- selected frequency into the VFO-B register.
- (G) This key is used for gaining access to the Menu system, for configuring various transceiver characteristics. Menu operation is described in detail, in this manual, beginning on page 110.
『Important note』
Pressing this key momentarily activates the Menu, and the Menu selections will appear on the TFT screen; once you are finished, you must press and hold in the **【MNU】** key for two seconds to save any configuration changes (momentarily pressing **【MNU】** key to exit will not save the changes).
- (H) These are the “Function” keys for the various functions associated with each page of the TFT’s operational capability. The exact function of each key will depend on the page selected.

REAR PANEL CONNECTIONS

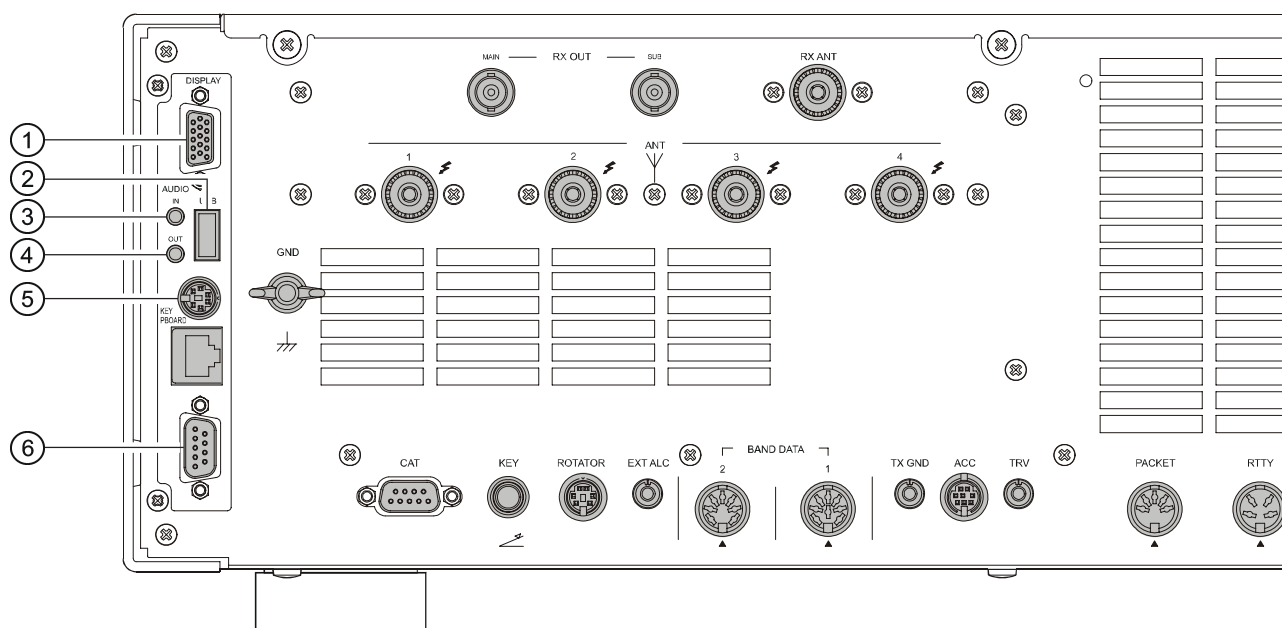

① DISPLAY

Connect an external monitor (not supplied) to this jack. An external monitor makes TFT display information available on a much larger screen, for ease of viewing.

② USB Jack

This jack supports the USB 1.1 protocol, for connection of a USB keyboard.

『Note』

Other types of USB-related accessories (other than a keyboard) are not supported by this jack, and must not be connected here.

③ AUDIO OUT

This terminal is for future expansion of the transceiver's capabilities. It is designed for connection to a computer's sound card input, but at this time it is not supported.

④ AUDIO IN

This terminal is for future expansion of the transceiver's capabilities. It is designed for connection to a computer's sound card output, but at this time it is not supported.

⑤ KEY BOARD

Connect your keyboard (not supplied) to one of these jacks in accordance with your keyboard type ("USB" or "PS/2") to use the Smart Memory Card for storage of logbook data, and for input of your location when setting up the World Clock.

⑥ COM

Connect a GPS receiver capable of supplying NMEA data (not supplied) to this jack. When you connect the GPS receiver to this jack, the "Rotator" page on the TFT display will automatically include a Great Circle map centered on your location.

CONNECTING A GPS RECEIVER

If you connect a properly-equipped after-market GPS receiver (not supplied) to the COM port on the back of the transceiver, the "Rotator" page on the TFT display will automatically include a Great Circle map centered on your location.

Connect a GPS receiver capable of output of NMEA-0183 data to the COM port. The data line connects to Pin 2, and the ground shield connects to Pin 5.

This transceiver can support the GGA, GLL, and RMC Data Sentences from the GPS unit.

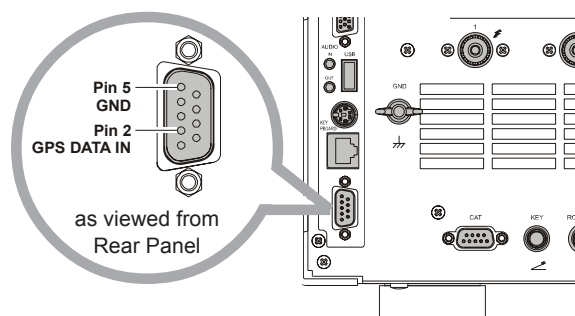

SPECIFICATIONS

General

Rx Frequency Range:	30 kHz - 60 MHz (Operating) 160 - 6 m (Amateur bands only)
Tx Frequency Ranges:	160 - 6 m (Amateur bands only)
Frequency Stability:	±0.03 ppm (after 5 min. @ -10 °C ~ +60 °C [+14 °F ~ +140 °F])
Operating Temperature Range:	-10 °C ~ +60 °C [+14 °F ~ +140 °F]
Emission Modes:	A1A (CW), A3E (AM), J3E (LSB, USB), F3E (FM), F1B (RTTY), F1D (PACKET), F2D (PACKET)
Frequency Steps:	1/10 Hz (SSB, CW, & AM), 100 Hz (FM)
Antenna Impedance:	50 Ω, unbalanced 16.7 - 150 Ω, unbalanced (Tuner ON, 160 - 10 m Amateur bands, TX only) 25 - 100 Ω, unbalanced (Tuner ON, 6 m Amateur band, TX only)
Power Consumption:	Rx (no signal) 100 VA Rx (signal present) 120 VA Tx (200 W) 720 VA
Supply Voltage:	90 VAC - 264 VAC (Universal)
Dimensions (WxHxD):	20.4" x 6.5" x 17.3" (518 x 165 x 438.5 mm)
Weight (approx.):	55 lbs (25 kg)

Transmitter

Power Output:	5 - 200 watts (5 - 75 watts AM carrier), Class A mode (SSB): 5 - 75 watts maximum
Modulation Types:	J3E (SSB): Balanced, A3E (AM): Low-Level (Early Stage), F3E (FM): Variable Reactance
Maximum FM Deviation:	± 5.0 kHz/± 2.5 kHz
Harmonic Radiation:	Better than -60 dB (160 - 10m Amateur bands) Better than -70 dB (6m Amateur band)
SSB Carrier Suppression:	At least 70 dB below peak output
Undesired Sideband Suppression:	At least 80 dB below peak output
Audio Response (SSB):	Not more than -6 dB from 400 to 2600 Hz
3rd-order IMD:	-31 dB @ 200 watts PEP, -50 dB @ 75 watts PEP (Class A mode)
Microphone Impedance:	600 Ω (200 to 10 kΩ)

Receiver

Circuit Type:	Triple-conversion superheterodyne		
Intermediate Frequencies:	40.455 MHz/455 kHz/30 kHz (24 kHz for FM)		
Sensitivity (IPO "OFF"):	SSB (2.4 kHz, 10 dB S+N/N)		
	0.2 μ V (160 - 10 m Amateur bands)		
	0.125 μ V (6 m Amateur band)		
	2 μ V (0.1 - 50 MHz)		
	AM (6 kHz, 10 dB S+N/N, 30 % modulation@400 Hz)		
	3.2 μ V (0.1 - 1.8 MHz)		
	2 μ V (1.8 - 30 MHz)		
	1 μ V (6 m Amateur band)		
	FM (12 dB SINAD)		
	0.5 μ V (10 m Amateur band)		
	0.35 μ V (6 m Amateur band)		
Selectivity (-6/-66 dB):	Mode	-6 dB	-66 dB
	CW/RTTY/PKT	0.5 kHz or better	750 Hz or less
	SSB	2.4 kHz or better	3.6 kHz or less
	AM	9 kHz or better	18 kHz or less
	FM	15 kHz or better	25 kHz or less
	(WIDTH: Center, VRF: OFF)		
Image Rejection:	70 dB or better (160 - 10m Amateur bands)		
Maximum Audio Output:	2.5 W into 4 Ω with 10% THD		
Audio Output Impedance:	4 to 8 Ω (4 Ω : nominal)		

Specifications are subject to change, in the interest of technical improvement, without notice or obligation, and are guaranteed only within the amateur bands.

NOTE

This equipment has been tested and found to comply with the limits for a Class B digital device, pursuant to Part 15 of the FCC Rules. These limits are designed to provide reasonable protection against harmful interference in a residential installation. This equipment generates, uses and can radiate radio frequency energy and, if not installed and used in accordance with the instructions, may cause harmful interference to radio communications. However, there is no guarantee that interference will not occur in a particular installation.

If this equipment does cause harmful interference to radio or television reception, which can be determined by turning the equipment off and on, the user is encouraged to try to correct the interference by one or more of the following measures:

- Reorient or relocate the receiving antenna.
- Increase the separation between the equipment and receiver.
- Connect the equipment into an outlet on a circuit different from that to which the receiver is connected.
- Consult the dealer or an experienced radio/TV technician for help.

1. Changes or modifications to this device not expressly approved by VERTEX STANDARD could void the user's authorization to operate this device.
2. This device complies with part 15 of the FCC Rules. Operation is subject to the following two conditions; (1) this device may not cause harmful interference, and (2) this device must accept any interference including interference that may cause undesired operation.
3. The scanning receiver in this equipment is incapable of tuning, or readily being altered, by the User to operate within the frequency bands allocated to the Domestic public Cellular Telecommunications Service in Part 22.

DECLARATION BY MANUFACTURER

The scanner receiver is not a digital scanner and is incapable of being converted or modified a digital scanner receiver by any user.

WARNING: MODIFICATION OF THIS DEVICE TO RECEIVE CELLULAR RADIOTELEPHONE SERVICE SIGNALS IS PROHIBITED UNDER FCC RULES AND FEDERAL LAW.



VERTEX STANDARD CO., LTD.

4-8-8 Nakameguro, Meguro-Ku, Tokyo 153-8644, Japan

VERTEX STANDARD

US Headquarters

10900 Walker Street, Cypress, CA 90630, U.S.A.

YAESU EUROPE B.V.

P.O. Box 75525, 1118 ZN Schiphol, The Netherlands

YAESU UK LTD.

Unit 12, Sun Valley Business Park, Winnall Close
Winchester, Hampshire, SO23 0LB, U.K.

VERTEX STANDARD HK LTD.

Unit 5, 20/F., Seaview Centre, 139-141 Hoi Bun Road,
Kwun Tong, Kowloon, Hong Kong

VERTEX STANDARD (AUSTRALIA) PTY., LTD.

Normanby Business Park, Unit 14/45 Normanby Road
Notting Hill 3168, Victoria, Australia



Copyright 2006

VERTEX STANDARD CO., LTD.

All rights reserved

No portion of this manual
may be reproduced without
the permission of
VERTEX STANDARD CO., LTD.

Printed in Japan.