

YAESU

The radio

144/430 MHz
DUAL BAND TRANSCEIVER

FT-65R

FT-65E

Operating Manual

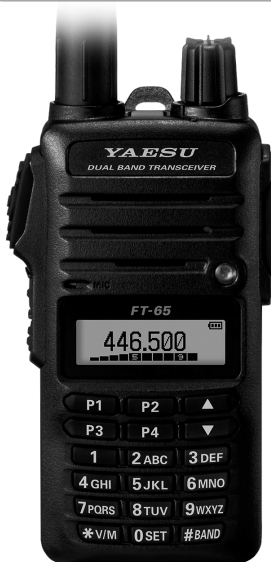

Contents

| | |
|--|----|
| General Description | 1 |
| Features of the FT-65R/E | 1 |
| About this manual | 2 |
| Downloading the "Advance Manual" | 3 |
| Accessories & Options | 4 |
| Supplied Accessories | 4 |
| Available Options | 4 |
| Safety Precautions (Be Sure to Read) | 5 |
| Control & Connections (Top & Front Panel) ... | 11 |
| Controls & Connections (Side Panel) | 12 |
| Controls & Connections (LCD) | 13 |
| Normal operation display | 13 |
| The Set Mode and Preference Mode display | 13 |
| Display of features and settings | 14 |
| Controls & Connections (Keypad) | 15 |
| Installation of Accessories | 16 |
| Antenna Installation | 16 |
| Preparation of SBR-25LI Battery Pack | 16 |
| Installing the Battery Pack | 16 |
| Removing the Battery Pack | 17 |
| Attaching the Belt Clip | 17 |
| Charging the Battery Pack | 18 |
| About Desktop charger lamp | 18 |
| Low Battery Indication | 19 |
| About Battery Indicator Icons | 19 |
| Approximate Operating Time and Remaining | |
| Charge Level Indication | 19 |
| Basic Operation | 20 |
| Turn the Power ON and OFF | 20 |
| Adjust the Audio Volume Level and Squelch | |
| Setting | 20 |
| Changing between VFO mode and Memory | |
| mode | 20 |
| Selecting the Operating Band | 20 |
| Frequency Navigation | 21 |
| 1) Tuning Frequency | 21 |
| 2) Direct Keypad Frequency Entry | 21 |
| 3) Scanning | 21 |
| Transmission | 22 |
| Changing the Transmit Power Level | 22 |
| Activating the Set Mode | 23 |
| How to use the [P1]-[P4] keys | 23 |
| (1) One touch recall of the preferred status | |
| | 23 |
| (2) Set Mode Recall feature | 23 |
| Preset Functions assigned to the [P1] to [P4] | |
| keys | 24 |
| Setting the Preferred Operating Mode | 24 |
| Advanced Operation | 25 |
| Turning the Keylock Feature ON and OFF | 25 |
| Change the key locking scheme | 25 |
| Change the LCD and keypad back light setting .. | |
| | 25 |
| Disabling the Keypad and Scan Stop Beeper | |
| | 26 |
| Repeater Operation | 27 |
| Repeater Shifts | 27 |
| Automatic Repeater Shift (ARS) | 27 |
| Manual Repeater Shift Setting | 28 |
| Tone Calling (1750 Hz) | 29 |
| Memory Mode | 30 |
| Memory Storage | 31 |
| Memory Recall | 32 |
| Changing the memory label (tag) name | 32 |
| HOME Channel Memory Recall | 33 |
| Changing the Home Channel Frequency | |
| | 33 |
| Memory Offset Tuning | 33 |
| Deleting Memories | 34 |
| Weather Broadcast Channels | 35 |
| Severe Weather Alert | 35 |
| Scanning | 36 |
| Setting the Scan-Resume Technique | 36 |
| VFO Scanning | 37 |
| Manual VFO Scan | 37 |
| Programmed Mode (VFO) Scan | 37 |
| Input Character/Symbol List | 39 |
| Set (Menu) Mode | 40 |
| Troubleshooting | 44 |
| The transceiver does not turn on | 44 |
| There is no sound | 44 |
| There is no transmission of radio waves | 44 |
| The keys or DIAL do not respond | 44 |
| The battery pack cannot be charged or | |
| battery power depletes immediately after | |
| charging | 45 |
| Specifications | 46 |
| General | 46 |
| Transmitter | 46 |
| Receiver | 47 |
| "AUTO" Mode Preset Operating Parameter | 47 |
| USA Version | 47 |
| Asian/European Version | 47 |

Features of the FT-65R/E

Congratulations on your purchase of the **FT-65R/FT-65E** Yaesu amateur transceiver!





FT-65R/E is a dual band FM transceiver, ruggedly constructed to meet commercial specifications. It is packed with the following popular and valuable features demanded by Amateur Radio operators around the world.

- Long-Life Battery
 - Supplied 7.4 V 1,950 mAh lithium ion battery.
 - Optional 7.4 V 2,500 mAh lithium ion battery.
- 5 Watts of Reliable RF Power
 - RF Power Output 5.0 W (High) / 2.5 W (Middle) / 0.5 W (Low) (@7.4 V)
- Four Quick Recall Keys (User Programmable) for Individual Preferences
 - Set Mode Recall feature and Quick Memory Feature.
- Powerful Audio
 - Bridged Transless (BTL) amplifier provides One Full Watt of Audio for operation in noisy environments.
- Rugged Body Construction
 - IP54 Rating and MIL-STD-810-C, D, E certified.
- Lockout Capabilities
 - Keypad/PTT Lockout.
- Emergency Features
 - Emergency Operation (Alarm, SOS Flash and HOME channel display), LED Flash light equipped.
- FM Radio Broadcast Receiver Feature

General Description

About this manual

This manual contains symbols and conventions to call attention to important information.

| Symbols | Description |
|---|--|
|  | This icon indicates cautions and alerts the user should be aware of. |
|  | This icon indicates helpful notes, tips and information. |
|  | This icon indicates other pages containing relevant information. |
|  | This icon refers users to the FT-65R/E Advance Manual on the YAESU Website containing relevant information. |

- The settings of the transceiver at the time of purchase are referred to as the “default” or “default setting”.
- The names of Set Mode items that are displayed on the LCD, and the transceiver key names, are printed in bold characters in this manual.

Downloading the “Advance Manual”

The Advance Manual provides detail information and features beyond the scope and descriptions in this manual. Download the **FT-65R/E** Advance Manual from the YAESU website and refer to it along with this Operating Manual.

<http://www.yaesu.com/>

The features described in the **FT-65R/E** Advance Manual are below.

| | |
|---|--|
| RF Squelch | Emergency Channel Operation |
| Checking the Battery Voltage | ARTS (Automatic Range Transponder System) |
| VOX Operation (with earpiece mic or Internal / External mic) | Basic ARTS Setup and Operation |
| VFO Split Mode | DTMF Operation |
| Using the Squelch Feature | Miscellaneous Settings |
| Selecting the Squelch Type | Password |
| Setting CTCSS Tone frequency | Changing the Channel Steps |
| Setting DCS CODE number | TX Battery Saver |
| CTCSS/DCS/PAGER/ARTS Bell Operation | Disabling the TX/BUSY LED Indicator |
| EPCS (Enhanced Paging & Code Squelch) | Automatic Power-Off (APO) Feature |
| Memory Bank Operation | Transmitter Time-Out Timer (TOT) |
| Memory Only Mode | Busy Channel Lock-Out (BCLO) |
| Scanning | Changing the TX deviation Level |
| Memory scanning | Voice Compander Feature |
| Weather Alert Scan | Inversion Scramble (Asian version only) |
| Programmable (Band Limit) Memory Scan (PMS) | Cloning |
| “Priority Channel” Scanning | Set (Menu) Mode |
| Automatic Lamp Illumination on Scan Stop | |

Accessories & Options

Supplied Accessories

- | | |
|--|------------|
| <input type="checkbox"/> 7.4V, 1,950 mAh Rechargeable Li-Ion Battery Pack | SBR-25LI |
| <input type="checkbox"/> AC Adapter (for USA model) | SAD-20B* |
| AC Adapter (for European / Asian model) | SAD-20C/U* |
| AC Adapter (for Chinese model) | SAD-20G* |
| <input type="checkbox"/> Rapid Charger | SBH-22 |
| <input type="checkbox"/> Belt Clip | SHB-18 |
| <input type="checkbox"/> Antenna | SRA-15 |
| <input type="checkbox"/> Operating Manual | |
| <input type="checkbox"/> SBR-25LI/SBR-26LI Manual | |
| <input type="checkbox"/> Warranty Card | |

Available Options

- | | |
|--|------------|
| <input type="checkbox"/> 7.4V, 1,950 mAh Rechargeable Li-Ion Battery Pack | SBR-25LI |
| <input type="checkbox"/> 7.4V, 2,500 mAh Rechargeable Li-Ion Large-Capacity Battery Pack | SBR-26LI |
| <input type="checkbox"/> Rapid Charger | SBH-22 |
| <input type="checkbox"/> AC Adapter (for USA model) | SAD-20B* |
| AC Adapter (for European / Asian model) | SAD-20C/U* |
| AC Adapter (for Chinese model) | SAD-20G* |
| <input type="checkbox"/> Programming cable | SCU-35 |
| <input type="checkbox"/> Cloning Cable | SCU-36 |
| <input type="checkbox"/> VOX Earpiece Microphone | SSM-512B |

*B: for 120 VAC, C: for 220-240 VAC, U: for 220-240 VAC w/BF plug, G: for 230 VAC

Availability of accessories may vary. Some accessories are supplied as standard for specific local requirements, while others may be unavailable in some regions. This product is designed to perform optimally when used with genuine Yaesu accessories. Yaesu shall not be liable for any damage to this product and/or accidents such as fire, leakage or explosion of a battery pack, etc., caused by the malfunction of non-Yaesu accessories. Consult your Yaesu dealer for details regarding these and any newly-available options. Connection of any non-Yaesu-approved accessory, should it cause damage, may void the Limited Warranty on this apparatus.

Safety Precautions (Be Sure to Read)

Be sure to read these important precautions, and use this product safely.

Yaesu is not liable for any failures or problems caused by the use or misuse of this product by the purchaser or any third party. Also, Yaesu is not liable for damages caused through the use of this product by the purchaser or any third party, except in cases where ordered to pay damages under the laws.

Types and meanings of the marks



DANGER

This mark indicates an imminently hazardous situation, which, if not avoided, could result in death or serious injury.



WARNING

This mark indicates a potentially hazardous situation, which, if not avoided, could result in death or serious injury.



CAUTION

This mark indicates a potentially hazardous situation, which, if not avoided, may result in minor or moderate injury or only property damage.

Types and meanings of symbols



These symbols signify prohibited actions, which must not be done to use this product safely. For example:  indicates that the product should not be disassembled.



These symbols signify required actions, which must be done to use this product safely. For example,  indicates that the power plug should be disconnected.

Safety Precautions (Be Sure to Read)



DANGER

 Do not use this product in an area where RF transmitters are prohibited, e.g., inside of a hospital, airplane, or train.

This product can affect electronic or medical devices.

 Do not use this product while riding a bicycle or driving a car. Accidents can result.

Be sure to stop the bicycle or car at a safe place before using this product.

 Do not perform transmission in a crowded place for the safety of persons using a medical device such as a cardiac pacemaker.

The radio wave emitted from this product can cause the medical device to malfunction and result in an accident.

 Do not touch any material leaking from the LCD display or the battery pack with bare hands.

The chemical may adhere to your skin or enter your eye, and cause chemical burns. In such a case, consult the doctor immediately.

 The chemical that has stuck to your skin or entered your eye can cause chemical burns. In such a case, consult the doctor immediately.

The radio wave emitted by the transmitter can cause the medical device to malfunction and result in injury or death.

 Do not use this product or the battery charger anywhere inflammable gas is produced.

A fire or explosion can occur.

 Do not solder or short-circuit the terminals of the battery pack.

A fire, leak, overheating, explosion, or ignition may result.

 Do not carry the battery pack together with a necklace, hairpin, or small metal objects. A short circuit can result.

 If thunder and lightning develop nearby when an external antenna is used, immediately turn this transceiver OFF, and disconnect the external antenna from it.

A fire, electrical shock, or damage may result.

Safety Precautions (Be Sure to Read)

WARNING

 **Do not power this transceiver with a voltage other than the specified power supply voltage.**
A fire, electric shock, or damage may result.

 **Do not use the battery pack for any model other than the specified transceiver.**
A fire, leak, overheating, explosion, or ignition can result.

 **Do not make very long transmissions.**
The main body of the transceiver may overheat, resulting component failure or operator burns.

 **Do not disassemble or make any alteration to this product.**
An injury, electric shock, or failure may result.

 **Keep the terminals of the battery pack clean.**
If terminal contacts are dirty or corroded, a fire, leak, overheating, explosion, or ignition can result.

 **Do not handle the battery pack or charger with wet hands. Do not insert or remove the power plug with wet hands.**
An injury, leak, fire, or failure may result.

If smoke or a strange odor is emitted from the main body, battery pack, or battery charger, immediately turn the transceiver off; remove the battery pack, and remove the power plug from the outlet.





A fire, chemical leak, overheating, component damage, ignition, or failure may result. Contact the dealer from which you purchased this product or Yaesu Amateur Customer Support.

 **Do not use the battery pack which is externally damaged or deformed.**

A fire, leak, heating, explosion, or ignition can result.

 **Do not use any battery charger which is not specified by Yaesu.**
A fire or failure can result.

 **When transmitting, keep the transceiver at least 5.0 mm (3/16 inch) away from your body. Use only the supplied antenna. Do not use modified or damaged antennas.**

 **If charging of the battery pack cannot be completed within the specified charging time, immediately remove the power plug of the battery charger from the outlet.**

A fire, leak, overheating, explosion, or ignition can result.

Safety Precautions (Be Sure to Read)



CAUTION

Do not dangle or throw the transceiver by holding its antenna.



This may injure others and may also result in damage and failure of the transceiver.

Do not use the transceiver in a crowded place.



The antenna may strike others and result in a injury.

Do not place this transceiver in direct sunlight or near a heater.



The case may be deformed or discolored.

Do not place this transceiver in a humid or dusty place.



A fire or failure may result.

While transmitting, keep the antenna as far from you as possible.



Long-time exposure to electromagnetic waves may have a negative impact on your health.

Do not wipe the case using thinner and benzene etc.



Use only a soft, dry cloth to wipe stains from the case.

If the transceiver will not be used for an extended period, turn it OFF and remove the battery pack for safety.



Do not drop, strike, or throw the transceiver.



A failure or damage may result.

Keep magnetic cards and video tape away from the transceiver.



The data recorded on cash cards or videotapes may be erased.

Charge the battery pack within the temperature range from +5 °C to +35 °C (+41 °F to +95 °F).



Charging the battery pack outside this temperature range can cause leak, overheating, decrease in performance, or reduction in service life can result.

When unplugging the power cord of the battery charger, be sure to hold the power plug.



Pulling the power cord can damage it and cause a fire or electronic shock.

Do not use the earpiece microphone, earphones, or headphones at an extremely high volume level.



Hearing impairment can result.

Keep this product out of the reach of children.



Injury to the child, or damage to the transceiver may result.

Install the hand strap and belt clip securely.



Improper installation may cause the FT-65R/E to fall or drop, resulting in an injury or damage.

Safety Precautions (Be Sure to Read)



CAUTION



Do not place a heavy object on the power cord of the battery charger.

The battery cord can be damaged, resulting in a fire or electric shock.



When the battery charger is not in use, remove its power plug from the outlet.



Do not use the included battery charger to charge any battery pack which is not specified for use with the charger.

A fire can result.



Before discarding a depleted battery pack, affix tape or insulating covering to its terminals.



Do not operate the transceiver near the TV or radio.

Radio disturbance can occur in the transceiver, the TV, or the radio.



Be sure to check with the manufacturer of any hybrid or fuel-saving automobile regarding use of the transceiver in that car.

Noise generated by an onboard electrical device (inverter, etc.) can disrupt the normal operation of the transceiver.



Do not use any products other than the specified options and accessories.

Failure or miss operation may result.



This product has splash, water, and dust resistant features and conforms to "IP54" when the included antenna and battery pack are installed and rubber caps are securely attached to the MIC/SP jack. If this transceiver gets wet, dry it with a soft cloth, do not leave it exposed to the moisture.

Exposure to excessive moisture may degrade the transceiver performance, shorten its life, or cause a failure or electrical shock.

About Splash, Water, and Dust Resistant Features Conforming to IP54

When the included antenna and battery pack are installed, and the MIC/SP jack is securely covered with rubber caps, this product is dust and splash resistant. To ensure continued Splash, Water, and Dust Resistant Features be sure to check the following points before each use.

- Check for damages, deterioration, and dirt.**
Antenna rubber, key switch rubber, MIC/SP jack rubber cap, and battery pack seals.
- Cleaning**
When this product is contaminated with seawater, sand, or dirt, rinse with fresh water, and then wipe with a dry cloth immediately.
- Recommended maintenance interval**
To insure continued water resistance and optimal performance, it is recommended that maintenance be performed annually, or when any damage or deterioration is found. Note that the maintenance service is subject to fees.
- Do not immerse this product in the following liquids:**
Sea, pool, hot spring, water containing soap, detergent, or bath additive, alcohol, or chemicals.
- Do not leave this product for an extended time in a very humid location:**
Bathroom, kitchen, or humid place.
- Other precautions**
Do not remove the rubber cap from the battery pack, the MIC/SP jack when water drops have accumulated on the transceiver, or when it is placed in a wet environment. This may result in water penetrating the transceiver, and causing equipment failure.
This product is not totally waterproof, and must never be immersed in water.

Control & Connections (Top & Front Panel)

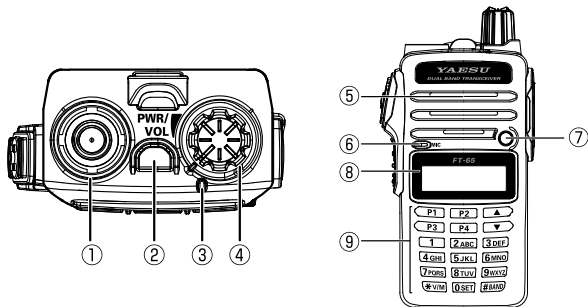

- ① **Antenna Jack** 16
Connect the supplied SMA female antenna (or another antenna presenting a 50-Ohm impedance) here.
- ② **Emergency key**
- Press this switch briefly to turn the LED Flash-Light.
 - Press and hold it for three seconds to enable the Emergency Alarm beep functions.
 - Press the keypad F key, and then press this switch to blink the LED Flash-Light for SOS.
- ③ **TX/BUSY Indicator Lamp**..... 20
This indicator glows green when the squelch opens, and it glows red during transmit.
- ④ **PWR/VOL Knob**..... 20
Turn this control clockwise to turn the transceiver ON and to increase the volume. Counter-clockwise rotation into the click-stop will turn the transceiver OFF.
- ⑤ **Speaker** 20
The internal speaker is located here.
- ⑥ **Microphone**..... 22
The internal microphone is located here.
- ⑦ **LED Flash-Light**
- ⑧ **LCD (Liquid Crystal Display)** 13
The display shows current operating condition.
- ⑨ **Keypad** 15
These 18 keys select the important operating functions of the FT-65R/E.

Controls & Connections (Side Panel)

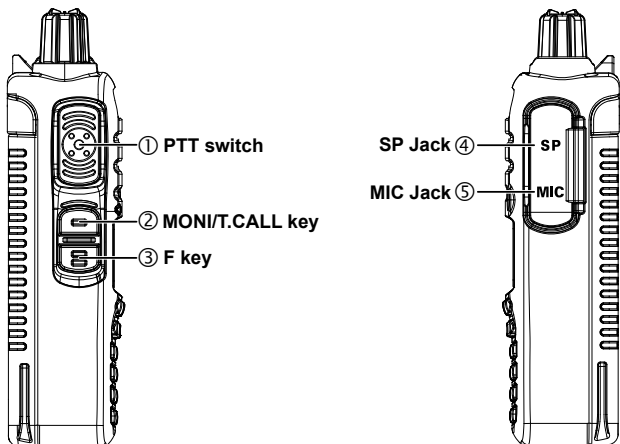

- ① **PTT (Push To Talk) Switch** 22
- Press this switch to transmit, and release it (to receive) after your transmission is completed.
 - In the Set mode, press the PTT switch to save the new setting and return to normal operation.
- ② **MONI/T.CALL Key (Function is selectable from Set mode)** 29
- **USA/Asian Version:**
Press this switch to open the squelch, and listen for very weak signals near the background noise level.
- **European Version:**
Pressing this switch activates the T-CALL (1750 Hz) for repeater access.
- ③ **F key** 23
- Press and hold this key to enter the Set Mode.
- ④ **SP Jack**
This three-conductor miniature jack provides connection for an external speaker.
- ⑤ **MIC Jack**
This three-conductor miniature jack provides connections for microphone audio, earphone audio, PTT, and ground.

Normal operation display

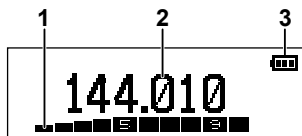

Single Display Mode (Default)

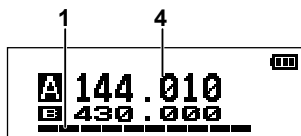

Dual Display Mode

- | | | | |
|---------------------|-----------------------------|---------------------------|-----------------------|
| 1 S & PO Meter..... | 2 Operating Frequency | 3 Battery Indicator | 4 VFO-A / VFO-B |
| 22 | 21 | 19 | 24 |

The Set Mode and Preference Mode display



Set Mode



Preferred Operating Mode

- | | |
|-----------------------|-----------------------------------|
| 5 Set Mode Menu | 6 Preferred Operating Mode Menu.. |
| 23 | 24 |

Control & Connections (LCD)

Display of features and settings

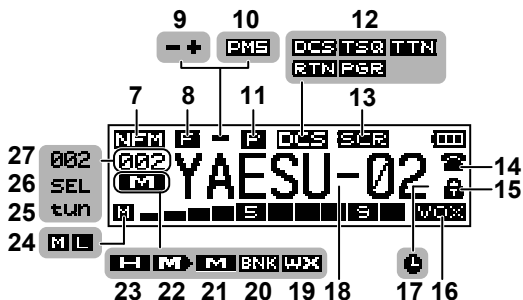

| | | | | | |
|----|---|----|----|--------------------------------|-------|
| 7 | Operating Mode | 20 | 18 | Memory Tag Name | 31,32 |
| 8 | Secondary Keypad Active | 15 | 19 | Weather Channel | 35 |
| 9 | Repeater Shift Direction | 28 | 20 | Memory Bank | 30 |
| 10 | Programmable Memory (Mode (VFO)) Scan | 37 | 21 | Memory Mode | 30 |
| 11 | Priority Channel | 15 | 22 | Skipped Memory Channel | |
| 12 | Squelch Operation | 42 | 23 | Home Channel | 33 |
| 13 | Scramble Feature* | 43 | 24 | TX Power Level Indicator | 22 |
| 14 | DTMF Mode | 41 | 25 | Memory Offset Tuning | 33 |
| 15 | Keypad Lock | 25 | 26 | Selecting ICON indicator | |
| 16 | VOX Feature | 43 | 27 | Memory (BANK) Channel Number | |
| 17 | Automatic Power-Off Feature | 40 | | | |

* This feature is displayed depending on the transceiver version.

Controls & Connections (Keypad)

| Key | Primary Function (PRESS Key) | Secondary Function (PRESS F + Key) | Third Function (Press and Hold Key) |
|---------------|---|---------------------------------------|--|
| 1 | Frequency entry digit "1" | — | Recalls the "Weather" broadcast channel bank |
| 2 ABC | Frequency entry digit "2" | — | Activates the ARTS feature |
| 3 DEF | Frequency entry digit "3" | — | — |
| 4 GHI | Frequency entry digit "4" | — | — |
| 5 JKL | Frequency entry digit "5" | — | — |
| 6 MNO | Frequency entry digit "6" | — | Key Lock feature |
| 7 PQRS | Frequency entry digit "7" | — | — |
| 8 TUV | Frequency entry digit "8" | — | — |
| 9 WXYZ | Frequency entry digit "9" | — | — |
| 0 SET | Frequency entry digit "0" | — | —*1 |
| P1 | recall the stored or assigned setting | HOME (Fixed setting) | store or assign a setting to the key |
| P2 | | TX PWR (Fixed setting) | |
| P3 | | SQL TYPE (Fixed setting) | |
| P4 | | REV (Fixed setting) | |
| *V/M | Switches the frequency control between the VFO and Memory Systems | Activates the Priority function | Memory write mode |
| #BAND | Switches the band control between VHF, UHF and FM RADIO Broadcast | PMS(Program Memory (Mode) Scan) | Program Scan Setting |

*1 : When entering a frequency from the keypad, there is a short-cut for frequencies ending in zero - after the last non-zero digit, press and hold the [0/SET] key to enter all the zeros at once.

Installation of Accessories

Antenna Installation

The supplied antenna provides good results over the entire frequency range of the transceiver. However, for enhanced reception on certain non-Amateur frequencies, you may wish to connect an antenna designed specifically for that frequency range, as the supplied antenna is necessarily a compromise outside the Amateur bands, and cannot be expected to provide high performance at all frequencies.

To install the supplied antenna, hold the bottom end of the antenna, then screw it onto the mating connector on the transceiver until it is snug. Do not over-tighten by using of extreme force.

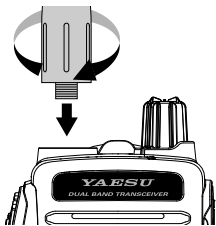

- Never transmit without having an antenna connected.
- When installing the supplied antenna, never hold the upper part of the antenna while screwing it onto the mating connector on the transceiver.
- If using an external antenna for transmission, ensure that the SWR presented to the transceiver is 1.5:1 or lower, to avoid excessive feedline loss.

Preparation of SBR-25LI Battery Pack

The **SBR-25LI** is a high-performance Li-Ion battery providing long operating time in a compact package. Under normal use, the **SBR-25LI** may be used for approximately 300 charge cycles, after which operating time may be expected to decrease. When an old battery pack exhibits diminished capacity, replace the pack with a new one.

Installing the Battery Pack

1. Insert the battery pack into the battery compartment on the back of the transceiver(①).
2. Push the battery in until the battery latch on the lower back side of the transceiver clicks securely(②).

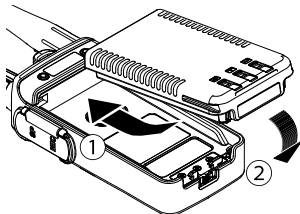

Removing the Battery Pack

To remove the battery, turn the transceiver OFF. While sliding the latch in the direction of the arrow, as shown in the illustration, slide the battery pack downward and out of the transceiver.

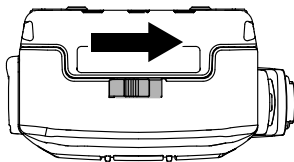

Attaching the Belt Clip

Attach the belt clip on the back of transceiver using the supplied screws (two).

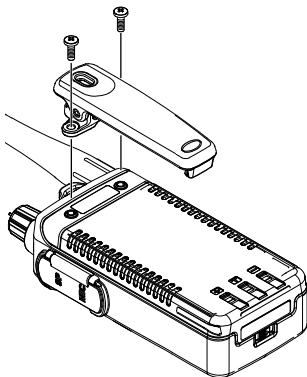

Charging the Battery Pack

If the battery has never been used, or its charge is depleted, it may be charged by placing the **FT-65R/E** in the **SBH-22** Rapid Charger desktop cradle, connected with the **SAD-20B/C/U/G** AC adapter.

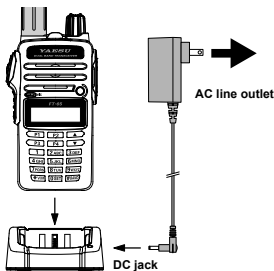

FT-65R/E / SBH-22 with SAD-20B
(Example of USA model)

A fully-discharged **SBR-25LI** Battery Pack will be charged completely in about **3.5 hours** (depending on the battery being charged). Disconnect the **SAD-20B/C/U/G** from the DC jack and the AC line outlet.



- The **SAD-20B/C/U/G** is not designed to power the transceiver for operation (reception or transmission).
- Please be advised that the **SAD-20B/C/U/G** may contribute noise to TV and radio reception in the immediate vicinity, so we do not recommend its use adjacent to such devices.
- It takes about **4.5 hours** to charge the **SBR-26LI** (optional).



About Desktop charger lamp

The battery charging status is indicated by the desktop charger lamp, as shown in the below table:

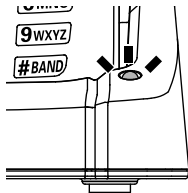
| Lamp Status | Description |
|----------------|-----------------|
| Red lighting | Charging |
| Green lighting | Charge Complete |
| Red blinking | Charge Error |



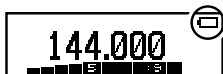

Low Battery Indication

- As the battery discharges during use, the voltage will gradually become lower. When the battery voltage is too low for reliable operation, the “” icon will blink on the LCD display, indicating that the battery pack must be recharged before further use.
- Avoid recharging Li-Ion batteries before the “” indicator is observed, as this can degrade the charge capacity of your Li-Ion battery pack.



About Battery Indicator Icons

Battery charge indicator icons are shown below:

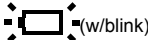
| Icons | Description |
|---|---------------------------------|
|  | Full battery power |
|  | Enough battery power |
|  | Low battery power |
|  (w/blink) | charge (or replace) the battery |

Approximate Operating Time and Remaining Charge Level Indication

Approximate operating time for the transceiver with the fully charged battery pack is as follows.

| Frequency Band | | SBR-25LI | SBR-26LI |
|-------------------|--------------|--------------------|--------------------|
| Amateur Band | 144 MHz band | Approx. 10.0 hours | Approx. 12.5 hours |
| | 430 MHz band | Approx. 9.0 hours | Approx. 11.5 hours |
| FM Broadcast Band | | Approx. 11.5 hours | Approx. 15.0 hours |

Transmit 6 seconds; Receive 6 seconds; Stand by 48 seconds.

Basic Operation

Turn the Power ON and OFF

- Be sure the Battery Pack is installed, and is fully charged. Connect the antenna to the top panel Antenna jack.
- Rotate the **PWR/VOL** knob out of the click-stop to turn the transceiver ON. The current DC supply voltage will be shown on the display for two seconds. After the two second interval, the display will commence the normal operating frequency indication.
- To turn the transceiver OFF, turn the PWR/VOL knob fully counter-clockwise into the click-stop position.

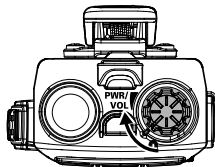

Adjust the Audio Volume Level and Squelch Setting

Rotate the **PWR/VOL** knob to adjust the receiver volume. Listen to the open squelch background noise to adjust the audio to a comfortable level.

1. To set the squelch level, press the **F** key and then press the **MONI/T.CALL** key, to open the SQ LEVEL set mode.
2. Press the [**▲**] or [**▼**] key to adjust to a level at which the background noise is muted.
3. Press the **PTT** switch to save the squelch setting and return to normal operation.

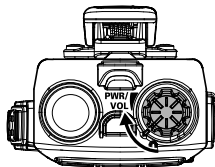

Changing between VFO mode and Memory mode

Press the [***V/M**] key repeatedly to toggle the frequency control between the VFO mode and the Memory mode.

Selecting the Operating Band

- Press the [**#BAND**] key repeatedly to change the operating frequency between the 144 MHz Band, the 430 MHz Band, and the 95 MHz (FM Radio Broadcast) Band.
- Frequency ranges are shown in the table.

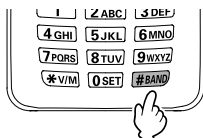

| | Frequency Range | | | |
|-----------------------|-----------------|-------------|-------------|-------------|
| | RX | TX | RX | TX |
| USA model | 136-174 MHz | 144-148 MHz | 400-480 MHz | 430-450 MHz |
| European model | 136-174 MHz | 144-146 MHz | 400-480 MHz | 430-440 MHz |
| Asian model | 136-174 MHz | 136-174 MHz | 400-480 MHz | 400-480 MHz |

Frequency Navigation

The **FT-65R/E** will initially be operating in the “VFO” mode. The VFO permits free tuning throughout the currently-selected operating band in designated frequency steps (operating channels).

Three basic frequency navigation methods are provided on the **FT-65R/E**.

1) Tuning Frequency

Pressing the [▲] key tunes the **FT-65R/E** toward a higher frequency, while pressing the [▼] key will lower the operating frequency, in steps pre-programmed for the current operating band.

2) Direct Keypad Frequency Entry

The operating frequency may be entered directly from the keypad by pressing the numbered digits on the keypad in the proper sequence.

Examples:

To enter 145.560 MHz, press [1] → [4] → [5] → [5] → [6] → [0]

To enter 145.000 MHz*, press [1] → [4] → [5] → [0] → [0] → [0]

*There is a short-cut to enter frequencies ending in zeros - after the last non-zero digit, press and hold the [0/SET] key to enter the remaining zeros.

3) Scanning

Manual VFO Scan:

To manually initiate VFO scanning, press and hold either the [▲] or [▼] key to begin upward or downward scanning, respectively.

Programmed Mode VFO Scan:

To begin scanning within a limited sub-band range from the VFO mode, press and hold the [#BAND] key to select the bandwidth for the Programmed Mode (VFO) scanner. Then press the **F** key and the [#BAND] key to start scanning.

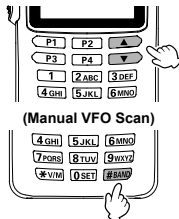

The scanner will stop when it receives a signal strong enough to open the Squelch threshold.

The **FT-65R/E** will then hold on that frequency in accordance with the “RESUME” mode setting (Set Mode Item “**25 RESUME**”).

Press the **PTT** switch momentarily to cancel the scanning (this only stops the scan; it does not cause a transmission to occur).

Basic Operation



The direction of the scan may not reverse while **FT-65R/E** is scanning.



For more details on the scanning, see page 36.

Transmission

- To transmit, press the **PTT** switch, and speak into the front panel microphone (located in the lower left-hand corner of the speaker grille) in a normal voice level. The TX/BUSY indicator will glow red during transmission.
- To return to the receive mode, release the **PTT** switch.
- During transmit, the power level will be indicated relatively on the bar graph at the bottom of the LCD. Full scale deflection confirms “High Power” operation. Five bars indicate “Medium Power” operation, while one bar indicates “Low Power” operation. Additionally, while operating on the “Low Power” or “Medium Power” setting, the “**L**” icon or “**M**” icon will appear at the bottom-left of the display.

Changing the Transmit Power Level

To change the power level:

1. Press the **F** key and then press the [**P2**] key.
 - The present TX power output level will appear on the display.
 - To adjust the TX power in the Set Mode, press and hold the **F** key. Then repeatedly press the [**▲**] or [**▼**] key to select Set Mode item “**32 TX PWR**” and then press the **F** key.
2. Press the [**▲**] or [**▼**] key to select the desired power output level. Available selections are “**HI**” (5 W), “**MID**” (2.5 W), and “**LOW**” (0.5 W).
3. Press the **PTT** switch to save the new setting and return to normal operation.

Activating the Set Mode

Use the following procedure to activate the Set Mode and configure the transceiver parameters.





1. Press and hold the **F** key to enter the Set Mode.
2. Repeatedly press the [**▲**] or [**▼**] key to select the Set Mode Item to be adjusted.
3. Press the **F** key momentarily to enable adjustment of the Set Mode Item.
4. Press the [**▲**] or [**▼**] key to adjust the level, or choose the parameter, of the selected Set Mode Item.
5. After completing the selection and adjustment, press the **PTT** switch to save the new setting and exit to normal operation.

How to use the [P1]-[P4] keys

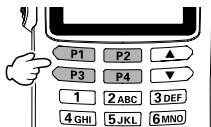
[P1], [P2], [P3] and [P4] keys may be used for the followings:

- One Touch Recall of a preferred setting
- One Touch Recall of the Mode settings



| Key | Store (Press and hold) | Recall (Press) |
|--|--|--|
|     | Store a preferred operating status or a Set Mode | Recall the stored operating status or the Set Mode |

(1) One touch recall of the preferred status

1. To store a preferred setting, Press and hold one of the [P1], [P2], [P3] or [P4] keys.
2. To recall a stored one touch preferred status, press the associated [P1], [P2], [P3] or [P4] key.





(2) Set Mode Recall feature

1. Press and hold the **F** key to enter the Set Mode.
2. Press the [**▲**] or [**▼**] key to select the Set Mode Item you frequently use.
3. When the desired Set Mode item is displayed on the screen, press and hold one of the [P1], [P2], [P3] or [P4] keys to store the Set Mode item.
4. To recall a stored one touch preferred Set Mode, press a [P1], [P2], [P3] or [P4] key to recall the assigned Set Mode Item.

Basic Operation

Preset Functions assigned to the [P1] to [P4] keys

Press the **F** key, then press the [P1], [P2], [P3] or [P4] keys to recall the preset functions as listed in the table at the right. These **F** key functions may not be changed.

| Key | Function |
|---|------------------|
| F key +  | HOME channel |
| F key +  | TX PWR setting |
| F key +  | SQL TYPE setting |
| F key +  | REV |

Setting the Preferred Operating Mode

The following reset or preferred operating modes may be selected.

| Display | Description |
|----------------------|--|
| F1:SET RESET | Reset the Set Mode settings to factory defaults. |
| F2:MEM RESET | Clear the Memory settings to factory defaults. |
| F3:BANK RESET | Clear the Memory Bank assignments. |
| F4:ALL RESET | Clear the All memories and other settings to factory defaults. |
| F5:MEM-ONLY | Operation on the Memory mode only. |
| F6:VHF-ONLY | Operation on the VHF Band only. |
| F7:UHF-ONLY | Operation on the UHF Band only. |
| F8:DUAL DISP | Display both VFO-A and VFO-B. |
| F9:CLONE | Clone mode. |

1. Turn the transceiver OFF.
2. Press and hold the **MONI/T.CALL** key and the **PTT** switch simultaneously, while turning the radio ON.
3. When the LCD backlight comes on, release the **MONI/T.CALL** key and **PTT** switch.
4. Referring to the above table, press the [▲] or [▼] key to select the desired operating mode.

| |
|----------------------|
| F1:SET RESET |
| F2:MEM RESET |
| F3:BANK RESET |
| F4:ALL RESET |

5. Press the **F** key momentarily to activate the selected operating mode.

After becoming familiar with the basic operations of the **FT-65R/E**, you will want to learn about some of the really handy operating and convenience features.

Turning the Keylock Feature ON and OFF

The **FT-65R/E** keypad may be locked to prevent accidental frequency change or inadvertent transmissions,

1. Press and hold the [6] key to lock the keys and switches.

- The  icon will appear on the LCD display.
- To unlock, press and hold the [6] key again.



Change the key locking scheme

The following locking schemes may be selected.

| Display | Description |
|-----------------------------|---|
| KEY(default setting) | Only the front panel keypad is locked out. |
| PTT | The PTT switch is locked out (TX not possible). |
| P+K | Both the PTT switch and the keypad are locked out. |

1. Press and hold the **F** key to enter the Set Mode.
2. Press the [▲] or [▼] key to select Set Mode Item “**15 KEY LOCK**”.
3. Press the **F** key momentarily to enable adjustment of this Item.
4. Press the [▲] or [▼] key to choose one of the above listed locking schemes.

15 KEY LOCK
→KEY

5. Press the **PTT** switch to save the new setting and return to normal operation.

Change the LCD and keypad back light setting

| Display | Description |
|----------------------------------|---|
| 5secKEY (default setting) | Keypad and LCD Lamp lights for 5sec. |
| 10secKEY | Keypad and LCD Lamp lights for 10sec. |
| 30secKEY | Keypad and LCD Lamp lights for 30sec. |
| CONT | Keypad and LCD Lamp lights continually. |
| OFF | Disable the Keypad and LCD Lamp function. |

1. Press and hold the **F** key to enter the Set Mode.
2. Press the [▲] or [▼] key to select Set Mode item “**16 LAMP**”
3. Press the **F** key to enable adjustment of this Item.

Advanced Operation

- Press the [▲] or [▼] key to select one of the modes described above.

16 LAMP
→ **5secKEY**

- Press the **PTT** switch to save the new setting and return to normal operation.

Disabling the Keypad and Scan Stop Beeper

An audible beep tone will sound when a keypad button is pressed, and also when the receiver scanning stops. The beep tone operation may be changed as shown in the below table:

| Display | Description |
|--------------------------------|---|
| KEY | The beeper sounds when a keypad button is pressed. |
| KEY+SC(default setting) | The beeper sounds when a keypad button is pressed, or when the receiver scanning stops. |
| OFF | The beeper does not sound. |

- Press and hold the **F** key to enter the Set Mode.
- Press the [▲] or [▼] key to select Set Mode item "**5 BEEP**".
- Press the **F** key to enable adjustment of this Item.
- Press the [▲] or [▼] key to select "**OFF**".
- Press the [▲] or [▼] key to select one of the modes described above.
- Press the **PTT** switch to save the new setting and return to normal operation.
- To turn the beep back on again, select "**KEY**" or "**KEY+SC** (Default setting)" in step 4 above.

5 BEEP
→ **OFF**

Repeater stations are often located on mountaintops or other high locations, and provide a dramatic extension of the communication range for low-powered hand-held or mobile transceivers. The **FT-65R/E** includes a number of features which make repeater operation simple and enjoyable.

Repeater Shifts

The transceiver has been configured at the factory for the repeater shifts customary in the sales destination country. For the 144 MHz band the repeater shift will be 0.6 MHz. On the 430 MHz band, the shift may be 1.6 MHz, 7.6 MHz, or 5 MHz (depending on the transceiver version).

Automatic Repeater Shift (ARS)

The **FT-65R/E** provides a convenient Automatic Repeater Shift feature, which automatically applies the appropriate repeater frequency shift when tuning in the repeater sub-bands of the designated country. The ARS setting options are listed below:

| Display | Description |
|-----------------------------------|--|
| ARS : ON (default setting) | Enable the Automatic Repeater Shift function. |
| ARS : OFF | Disable the Automatic Repeater Shift function. |

1. Press and hold the **F** key to enter the Set Mode.
2. Press the [**▲**] or [**▼**] key to select Set Mode item “**24 REPEATER**”.
3. Press the **F** key to enable adjustment of this Item.
4. Press the **F** key to enable **ARS**.
5. Press the [**▲**] or [**▼**] key to select “**ON**” or “**OFF**”.
6. Press the **PTT** switch to save the new setting and return to normal operation.

| |
|-----------------------|
| 24 REPEATER |
| → ARS : ON |
| MODE : SIMPLEX |
| SHIFT : 0.60M |

Repeater Operation

Manual Repeater Shift Setting

If the ARS feature has been deactivated, or if a repeater shift direction other than the established ARS setting is desired, the repeater shift direction may be set manually.

1. Press and hold the **F** key to enter the Set Mode.
2. Press the [**▲**] or [**▼**] key to select Set Mode item “**24 REPEATER**”, then press the **F** key to enable this item.
3. Press the [**▲**] or [**▼**] key to select **MODE**, and press **F** key to enable this item.
4. Press the [**▲**] or [**▼**] key to select the Shift Mode, and press the **F** key to enable adjustment of this Item.

| |
|---|
| 24 REPEATER ARS : ON →MODE : SIMPLEX SHIFT : 0.60M |
|---|

| Display | Description |
|---|---|
| MODE : SIMPLEX (default setting) | Disable the Manual Repeater Shift function. |
| MODE : +REP | Enable the Manual Repeater Shift + direction. |
| MODE : -REP | Enable the Manual Repeater Shift - direction. |

5. To change the repeater shift magnitude, press the [**▲**] or [**▼**] key to select **SHIFT**.
6. Press the **F** key to enable adjustment of this Item.
7. Press the [**▲**] or [**▼**] key to select the repeater shift magnitude (0.05 MHz ~ 99.95 MHz).
8. Press the **PTT** switch to save the new setting and return to normal operation.

Tone Calling (1750 Hz)

For operation in counties that require a 1750-Hz burst tone for repeater access (typically in Europe), the **MONI/T.CALL** key may be programmed to serve as a "Tone Call" key instead. Use Set Mode item "**19 MONI/T-CL**", to change the configuration of this key.

| Display | Description |
|---|---|
| MONITOR (default setting (USA and Asian version)) | Pressing the MONI/T.CALL key opens the receiver noise squelch. |
| T-CALL1750 (default setting (European version)) | Pressing the MONI/T.CALL key activates the 1750 Hz burst tone. |
| T-CALL2100 | Pressing the MONI/T.CALL key activates the 2100 Hz burst tone. |
| T-CALL1000 | Pressing the MONI/T.CALL key activates the 1000 Hz burst tone. |
| T-CALL1450 | Pressing the MONI/T.CALL key activates the 1450 Hz burst tone. |

1. Press and hold the **F** key to enter the Set mode.
2. Press the [**▲**] or [**▼**] key to select Set Mode item "**19 MONI/T-CL**".
3. Press the **F** key to enable adjustment of this Item.
4. Press the [**▲**] or [**▼**] key to select a Tone Calling feature.
5. Press the **PTT** switch to save the new setting and return to normal operation.

| |
|--|
| <p>19 MONI/T-CALL →MONITOR</p> |
|--|

To access a tone burst controlled repeater, press and hold in the **MONI/T.CALL** key for the time duration specified by the repeater owner/operator. The transmitter will automatically be activated, and the 1750-Hz audio tone will be superimposed on the carrier. Once the repeater is accessed, release the **MONI/T.CALL** key and use the **PTT** switch to activate the transmitter thereafter.

Memory Mode

The **FT-65R/E** provides a wide variety of memory system resources. These include:

- 200 “Standard” memory channels, numbered “001” through “200”.
- 3 “Home” channels, providing storage and quick recall of one prime frequency on each operating band.
- 10 sets of band-edge memories, also known as “Programmable Memory Scan” channels, labeled “L01/U01” through “L10/U10”
- 10 Memory Banks, labeled “BANK 1” through “BANK10” Each Memory Bank can be assigned up to 200 channels from the “standard” and “PMS” memory channels.
- 10 “Weather Broadcast” Channels.

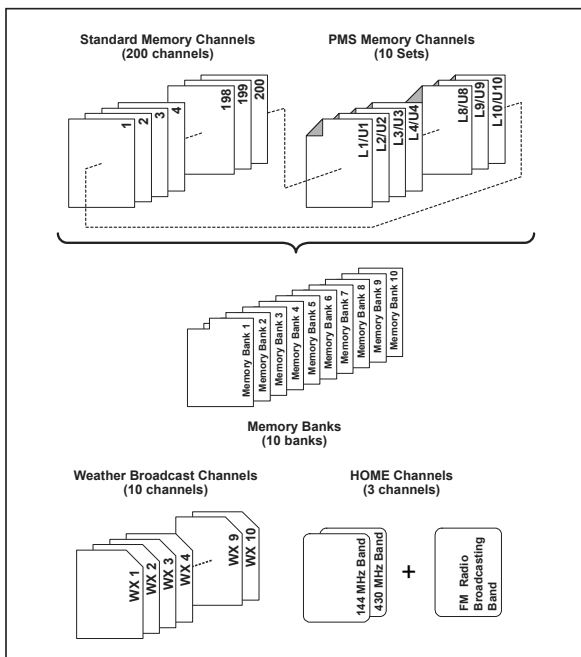

Memory Storage

1. Select the desired frequency, while operating in the VFO mode.
Be sure to set up any desired CTCSS or DCS tones, as well as any desired repeater offset. The power level may also be set at this time, if you wish to store it.
2. Press and hold the [***V/M**] key.
A blank memory channel will be displayed automatically.
3. If it is desired to change to another channel number, press the [**▲**] or [**▼**] key.
4. Press the Alphabet / Numeric keys to input characters and create a "Tag" (label) for the memory channel.



If not inputting a "Tag" (label), proceed to step 5.



- To move the cursor to the next character, press the **F** key.
- To correct a mistake, press the **F** key repeatedly until the cursor returns to the character position.



For more details on the character/symbol, see page 39.

5. Press and hold the [***V/M**] key to store the frequency and settings into the selected memory channel.
"MEM-IN" on the display will blink twice and the tone will sound to complete the memory setting.

Memory Mode

Memory Recall

1. While operating in the VFO mode, press the [***V/M**] key to enter the Memory mode.
2. Press the [**▲**] or [**▼**] key to select the desired memory channel.
3. To return to the VFO mode, press the [***V/M**] key.



When the transceiver is already set to the Memory mode, an easy way to recall a memory channel is to enter the memory channel number using the numeric keypad.

For example: in the Memory Mode to recall memory channel #002, press the [**2**] key.



To recall Memory Channel #200, enter "200". To recall Programmable Memory channels "L1/U1" through "L10/U10" enter "201/202" through "210/220".

Changing the memory label (tag) name

1. Press the [***V/M**] key to recall the memory channel that you wish to label or rename.
2. Press and hold the **F** key to enter the Set Mode.
3. Press the [**▲**] or [**▼**] key to select Set Mode item "20 NAME TAG".
4. Press the **F** key to enter (or edit) the channel name tag.
"NAME-TAG" message will appear.
5. Press the Alphabet / Numeric keys to enter the characters or symbols for the memory channel "Tag" (label).
 - To move the cursor to the next character, press the [**▲**] key.
 - To correct a mistake, press the [**▼**] key repeatedly until the cursor returns to the character position.



For more details on character/symbol input, see page 39.

6. Press the **PTT** switch to save the new setting and return to the memory channel.

HOME Channel Memory Recall

A “HOME” channel memory is provided for each operating band, to allow quick recall of a favorite operating frequency on each band. The default home channels are below:

| Default Home Channels | |
|-----------------------|-------------|
| Band | Frequency |
| 144 MHz Band | 144.000 MHz |
| 430 MHz Band | 430.000 MHz |
| FM Radio Band | 95.000 MHz |

1. Press the **F** key, then press the [**P1**] key.

The default home channel, as listed above, is displayed.



2. Press the **F** key, then press the [**P1**] key to exit to normal operation. Repeat this process to recall the HOME channel on any operating band.

Changing the Home Channel Frequency

The home channel frequencies may be changed from the default settings.

1. While operating in the VFO mode, select the desired frequency.
2. Press and hold the [***V/M**] key.

A blank memory channel will be displayed.

3. Press the [**P1**] key.

- “HOME-IN” will be displayed, and then exit to normal operation.



- The home channel frequency is changed and overwriting is complete.

Memory Offset Tuning

Once a particular memory channel is recalled, it is easy to tune off that channel, as though you were in the “VFO” mode.

1. Recall the memory channel.
2. Press the [**#BAND**] key to activate the “Memory Channel Tuning” feature.

The Memory Channel number on the LCD display will be replaced by “tun”.

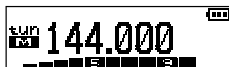

Memory Mode



When an alpha-numeric Tag is shown in place of the memory channel operating frequency display, the display will automatically revert to display the operating frequency along with the “tun” indication. It is not necessary to enter the Menu and change from the alpha-numeric Tag display to the operating frequency display.

3. Press the [▲] or [▼] key to tune to the desired frequency.
4. To return to the original memory frequency, just press the [#BAND] key. The display will revert to a display of the alpha-numeric Tag (if any) that may have originally appeared on the LCD.



To store the new frequency while using Memory Offset Tuning, press and hold the [*V/M] key (per the normal memory storage procedure). The next-available clear memory location will be displayed. Then press and hold the [*V/M] key again to save the new frequency the available memory channel.

Deleting Memories

All except the Memory Channel “001” and the Home Channels may be easily deleted.



Once deleted, the channel data cannot be recovered, so make a note of the information (Memory Channel settings, etc), before deleting the memories.

1. Press and hold the **F** key to enter the Set Mode.
2. Press the [▲] or [▼] key to select Set Mode item “18 MEM DEL”.
3. Press the **F** key to enable adjustment of this Item.
4. Press the [▲] or [▼] key to select the memory channel to be “deleted”.
5. Press the **F** key to delete the selected memory channel.
6. Press the **PTT** switch to return to normal operation.

```
18 MEM DELETE  
→ 24:LONDON  
25:145.215  
26:618590W
```

Weather Broadcast Channels

In the USA, the VHF Weather Broadcast Station Memory Channel Bank has been pre-programmed at the factory for immediate access to NOAA weather information stations.

1. Press and hold the [1] key to recall the Weather Broadcast Memory Bank.
2. Press the [▲] or [▼] key to select the desired Weather Broadcast channel.

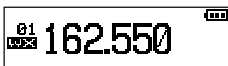

3. To scan for additional or stronger Weather stations, just press the **PTT** switch (or press and hold the [▲] or [▼] key).

When the scanner pauses on a station, press the **PTT** switch once to halt the scan, or press it again to re-start the scan.

| CH | Frequency | CH | Frequency |
|----|-------------|----|-------------|
| 01 | 162.550 MHz | 06 | 162.500 MHz |
| 02 | 162.400 MHz | 07 | 162.525 MHz |
| 03 | 162.475 MHz | 08 | 161.650 MHz |
| 04 | 162.425 MHz | 09 | 161.775 MHz |
| 05 | 162.450 MHz | 10 | 163.275 MHz |

4. To return to normal operation, press the [*V/M] key, or press and hold the [1] key again.

Severe Weather Alert

In the event of extreme weather disturbances, such as severe thunderstorms and hurricanes, the NOAA (National Oceanic and Atmospheric Administration) sends a weather alert accompanied by a 1050 Hz tone and subsequent weather report on one of the NOAA weather channels.

Scanning

The **FT-65R/E** makes available scanning of the stored memory channels, or scanning of the entire operating band, or scanning of a programmable sub band portion. Scanning will halt when signals are encountered, and communication may be initiated on that frequency.

Operation is basically the same in each of the above scanning modes. Before beginning, take a moment to select the way the scanning will resume after it halts on a signal.

Setting the Scan-Resume Technique

Three options for the Scan-Resume mode are available:

| Display | Description |
|----------------------------------|---|
| BUSY (default setting) | In BUSY mode, the scanner will halt on a signal it encounters. Scanning will resume one second after the other station signal ceases transmitting. In the case of constant-carrier signals like Weather Station broadcasts, the scanner will likely remain on this frequency indefinitely. |
| HOLD | In HOLD mode, the scanner will halt on a signal it encounters. Scanning will only resume when it is manually re-initiated. |
| TIME | In TIME mode, the scanner will halt on a signal it encounters, scanning will resume after five seconds even if a signal is still on the frequency. To cancel scanning, press the the PTT switch, [▲] or [▼] key. |

1. Press and hold the **F** key to enter the Set mode.
2. Press the [**▲**] or [**▼**] key to select Set Mode Item "**25 RESUME**".
3. Press the **F** key to enable adjustment of this Set Mode Items.
4. Press the [**▲**] or [**▼**] key to select the desired scan-resume mode.
5. Press the **PTT** switch to save the setting and exit to normal operation.

| |
|-----------------------------------|
| 25 RESUME → BUSY |
|-----------------------------------|

VFO Scanning

The FT-65R/E provides two VFO scanning functions: “Manual VFO Scanning” and “Programmed Mode (VFO) Scanning.”

Manual VFO Scan

1. If necessary, press the [***V/M**] key to change to the VFO mode.
2. Press and hold the [**▲**] or [**▼**] key to initiate upward or downward scanning, respectively.
3. When scanning encounters a signal strong enough to open the squelch, the scanner will halt temporarily; the decimal point of the frequency display will blink to indicate this “Resuming” condition.
4. The scanning will resume according to the Scan-Resume mode selected in the Set Mode Item “**25:RESUME**”.
5. To cancel scanning, press the **PTT** switch, [**▲**] or [**▼**] key.

Programmed Mode (VFO) Scan

1. Press and hold the [**#BAND**] key.
2. Press the [**▲**] or [**▼**] key to select the bandwidth for Programmed Mode (VFO) scanner.

| |
|----------------------|
| PROG VFO SCAN |
| →BAND |

Available selections are +1 MHz, +2 MHz, +5 MHz, ALL, PMS-X, and BAND.

| Display | Description |
|----------------------------------|--|
| BAND (default setting) | The scanner will sweep frequencies on the current operating band. |
| +1MHz | The scanner will sweep ± 1 MHz from the operating frequency. |
| +2MHz | The scanner will sweep ± 2 MHz from the operating frequency. |
| +5MHz | The scanner will sweep ± 5 MHz from the operating frequency. |
| ALL | The scanner will sweep all frequencies. |
| PMS-X | The scanner will sweep frequencies designated by the currently selected PMS (Programmable Memory Scan) frequency pair. |



PMS-X will appear in the [**#BAND**] selections after setting a PMS frequency pair.

Scanning

3. Press the [#BAND] key to save the new setting and return to normal operation.
4. Press the **F** key, then press the [#BAND] key to start scanning.
5. When scanning encounters a signal strong enough to open the squelch, the scanning will halt temporarily; the decimal point of the frequency display will blink during this "Pause" condition.
6. The scanner will then resume according to the Scan-Resume mode selected in the "RESUME" setting.
7. To cancel scanning, press the **PTT** switch, [▲] or [▼] key.

Input Character/Symbol List

On a character inputting display such as the memory mode “tag” display, the characters and symbols may be input as below:

| Key | Key Assignment | Key | Key Assignment |
|--------------|----------------|---------------|-------------------------------------|
| 1 | 1 | 7 PQRS | 7 P Q R S p q r s |
| 2 ABC | 2 A B C a b c | 8 TUV | 8 T U V t u v |
| 3 DEF | 3 D E F d e f | 9 WXYZ | 9 W X Y Z w x y z |
| 4 GHI | 4 G H I g h i | 0 SET | 0 (blank character) |
| 5 JKL | 5 J K L j k l | *V/M | * + - , . / : ; @ (blank character) |
| 6 MNO | 6 M N O m n o | | |

Set (Menu) Mode

The **FT-65R/E** Set Mode, already partially described in the previous chapters, may be activated to select or change various transceiver functions. Many of the useful parameter configurations have not been fully detailed in this manual. Refer to the chart below for a list of the Set Mode Items and their various parameters.

1. Press and hold the **F** key to enter the Set Mode.
2. Press the [**▲**] or [**▼**] key to select the Set Mode Item to be adjusted.
3. Press the **F** key momentarily to enable adjustment of the Set Mode Item.
4. Press the [**▲**] or [**▼**] key to adjust or select the parameter to be changed on the Set Mode Item selected in above step.
5. After completing your selection and adjustment, press the **PTT** switch momentarily to save the new setting and exit to normal operation.



Press and hold the **F** key to move from the lower menu contents to the upper menu contents in the Set Mode.

| Item (lower menu item) | Function | Values | Default Value |
|-----------------------------------|---|--|-------------------------|
| 1 APO | Setting of the Automatic Power-Off feature. | OFF / 0.5H to 12.0H (Step 0.5H) | OFF |
| 2 ARTS | Selects the Beep option and the Polling Interval during ARTS operation. | BEEP= INRANG / ALWAYS / OFF INTV= 25SEC / 15SEC | BEEP=OFF INTV= 25SEC |
| 3 BATTSAVE | Selects the Receive-mode Battery Saver interval ("sleep" ratio) | 200mS / 300mS / 500mS / 1SEC / 2SEC / OFF | 200mS |
| 4 B-CH.L/O | Enables/Disables the Busy Channel Lock-Out feature. | OFF / ON | OFF |
| 5 BEEP | Beep function Enable/Disable on pressing the keypad, or stopping the receiver scanning. | KEY+SC / KEY / OFF | KEY+SC |
| 6 BELL | Select the number of CTCSS/DCS/PAGER/ARTS Bell ringer repetitions. | OFF / 1Time / 3Times/ 5Times / 8Times / CONTINUE | OFF |
| 7 COMPANDE (COMPANDER) | Enables/Disables the Voice Compander feature | OFF / ON | OFF |

Set (Menu) Mode

| Item (lower menu item) | Function | Values | Default Value |
|-------------------------------------|--|--|-------------------------------|
| 8 CTCSS (CTCSS TONE) | Setting the CTCSS Frequency TX and RX | 50 CTCSS tones / OFF | TX=100.0Hz RX=100.0Hz |
| 9 CW ID | CW Identifier during ARTS operation. | TX= OFF / ON ID= ----- (6 characters) | TX= OFF ID= blank |
| 10 DC VOLT | displays Battery DC Voltage. | - | - |
| 11 DCS CODE | Setting the DCS CODE TX and RX | 104 DCS CODEs / OFF | TX=023 RX=023 |
| 12 DTMF SET | Selects the MANUAL or AUTO DTMF tones. Setting the DTMF autodialer sending delay time and Speed. | MODE= MANUAL / AUTO DELAY= 50mS / 250mS / 450mS / 750mS / 1000mS SPEED= 50mS / 100mS | M=MANUAL D=450mS S=50mS |
| 13 DTMF WRT | Programming to DTMF autodialer. | - | - |
| 14 EDG.BEEP | Enables/Disables the Band-edge beeper while selecting the frequency via the [▲] or [▼] key. | BEEP OFF / BEEP ON | BEEP OFF |
| 15 KEY LOCK | Keyboard Lock function | KEY / PTT / P+K | KEY |
| 16 LAMP | Selects the LCD/ Keypad Lamp mode. | 5secKey / 10secKey / 30secKey / CONT / OFF | 5secKey |
| 17 LED | Selects the enable or disable TX/BUSY LED function. | TX= ON / OFF BUSY= ON/ OFF | TX=ON BUSY=ON |
| 18 MEM DEL (MEM DELETE) | Deletes Memory Channel | - | - |
| 19 MON/T-CL (MON/T-CALL) | Selects the MONI or T.CALL switch function. | MONITOR / T-CALL1750 / T-CALL2100 / T-CALL1000 / T-CALL1450 | MONITOR (*) or T-CALL1750 (*) |
| 20 NAME TAG | Renames Alpha-Numeric "Tags" for the Memory channels. | - | - |

Set (Menu) Mode

| Item (lower menu item) | Function | Values | Default Value |
|------------------------------|--|--|--|
| 21 PAGER | Setting the TX CTCSS of 2 tone and the RX CTCSS of 2 tone. Enables/disables the Answer Back function. | TX: ** ** RX: ** ** ACK : ON / OFF | TX=05 47 RX=05 47 ACK=OFF |
| 22 PASSWORD | Enables/disables the Password feature | OFF / ON / | OFF |
| 23 PRI.RVT | Enables/disables the Priority Revert feature. | RVT.OFF / RVT. ON | RVT.OFF |
| 24 REPEATER | ARS / MODE / SHIFT function setting | ARS= ON / OFF MODE=SIMPLEX / +RTP / -RTP SHIFT= 0.05 MHz - 99.95 MHz (per 50KHz) | ARS=ON MODE=SIMPLEX SHIFT=**.**M (*) |
| 25 RESUME | Selects the Scan Resume mode. | BUSY / HOLD / TIME | BUSY |
| 26 RF SQL | Adjusts the RF Squelch threshold level. | S-1 / S-2 / S-3 / S-4 / S-5 / -6 / S-8 / S-FULL / OFF | OFF |
| 27 SCN.LAMP | Enables/Disables the Scan lamp while paused. | ON / OFF | ON |
| 28 SKIP (SKIP SCAN) | Selects the Memory Scan "Skip" channel-selection mode. | - | - |
| 29 SQL TYPE | Selects the Tone Encoder and/or Decoder mode. | OFF / R-TONE / T-TONE / TSQL / REV TN / DCS / PAGER | OFF |
| 30 STEP | Setting of the frequency steps. | 5 / 6.25 / 10 / 12.5 / 15 / 20 / 25 / 50 / 100 kHz, or AUTO | AUTO |
| 31 TOT | Setting of the TOT time. | 1 min - 30 min (per 1 min) or OFF | 3min |
| 32 TX PWR | Selects TX Power | HI(5W) / MID(2.5W) / LOW(0.5W) | HI(5W) |

Set (Menu) Mode

| Item (lower menu item) | Function | Values | Default Value |
|------------------------------|---|--------------------|---------------|
| 33 TX SAVE | Enables/Disables the Transmitter Battery Saver. | SAVE OFF / SAVE ON | SAVE OFF |
| 34 VFO.SPL | Enables or disables "VFO Split" operation. | VSP.OFF / VSP.ON | VSP.OFF |
| 35 VOX | Enable / Disable VOX function. | VOX OFF / VOX ON | VOX OFF |
| 36 WFM.RCV | Broadband FM Radio(WFM) function Enables/Disables | WFM.ON / WFM.OFF | WFM.ON |
| 37 WIDE/NAR | Select Wide (± 5 kHz) or Narrow (± 2.5 kHz) TX Deviation. | WIDE / NARROW | WIDE |
| 38 WX ALERT | Enables/Disables the Weather Alert Scan feature. | ALT.OFF / ALT. ON | ALT.OFF |
| 39 SCRAMBLE(*) | Inversion scrambling (Encryption) | SCRB.OFF/SCRB.ON | SCRB.OFF |

(*) : This function may be displayed, depending on the transceiver version.

Troubleshooting

If you suspect a malfunction, check the following items before requesting a repair.

The transceiver does not turn on.

- Is the battery depleted?
- Charge the battery pack after purchase, and when the transceiver has not been used for a long time.
- Is the battery pack properly attached?
Refer to “Installing the Battery Pack” and securely mount the battery pack.

There is no sound.

- Is the squelch level (or S meter squelch) set too high?
Press the **MONI/T.CALL** key and verify that you can hear white noise. Adjust the squelch level (or S meter squelch) when receiving a weak signal.
- Is the volume low?
Rotate the **PWR/VOL** knob clockwise to increase the volume.
- Is the tone squelch or DCS on?
When the tone squelch or DCS is on, the sound is not output until the transceiver receives a signal containing the same tone frequency or DCS code set.
For more details on the DCS code, refer to the Advance Manual.

There is no transmission of radio waves.

- Are you pressing the **PTT** switch properly?
- Is the PTT lock on?
- Is the Busy TX Block (BCLO function) on?
When the Busy TX Block (BCLO function) is on, transmission is inhibited when receiving a signal, even if the **PTT** switch is pressed. Wait until the signal being received stops and then press the **PTT** switch.
- Is the transmission frequency on a ham radio band?
Transmission cannot be performed on the FM Radio Broadcast Band/Information Radio Band.
- Is the voltage of the battery pack correct?
Check the remaining charge on the battery pack.
In addition, using an inadequate power supply where voltage drops during transmission will prevent the **FT-65R/E** from operating at full capability.

The keys or DIAL do not respond.

- Is the Keypad Lock or PTT Lock on?

The battery pack cannot be charged or battery power depletes immediately after charging.

- Is the battery pack being charged with a charger specified by Yaesu?
Charge the battery pack using the accessory battery charger (SAD-20B/C/U/G) or the rapid charge cradle (SBH-22).
- Is the battery pack in use exhausted?
If the “Charging Error” appears on the desktop charger lamp when charging, there is a chance the battery pack is over discharged. If the error is repeatedly displayed after charging the battery pack several times, the battery pack may have reached its service life or be defective. Battery packs are consumables. Please replace an exhausted battery pack with a new one immediately. Battery packs can be charged and reused up to approximately 300 times.

Some specific combinations of signals may cause internal beats (“birdies”) from high frequencies, caused by the internal oscillator. This is not a malfunction.

(See the calculation formula below: “n” is for the arbitrary integer). Also, depending on the combination of simultaneously received signals, there may be fluctuations in receive sensitivity.

- Receive Frequency = 13 MHz × n multiplicative
- Receive Frequency = 19.2 MHz × n multiplicative

Specifications

General

| | |
|-------------------------------|--|
| Frequency Ranges: | RX 136 - 174 MHz 400 - 480 MHz |
| | TX 136 - 174 MHz (Asian version) 144 - 146 MHz (European version) 144 - 148 MHz (USA version) 400 - 480 MHz (Asian version) 430 - 440 MHz (European version) 430 - 450 MHz (USA version) |
| | FM Broadcast 65-108 MHz |
| Channel Steps: | 5 / 6.25 / 10 / 12.5 / 15 / 20 / 25 / 50 / 100 kHz |
| Frequency Stability: | ±5 ppm (−10 °C to +60 °C, +14 °F to +140 °F) |
| Repeater Shift: | ±600 kHz (144 MHz) ±1.6 / 5.0 / 7.6 MHz (430 MHz) |
| Emission Type: | F2D, F3E |
| Antenna Impedance: | 50 Ohms |
| Supply Voltage: | Nominal: 7.4V DC, Negative Ground |
| Current Consumption: | 205 mA (Receive) 200 mW Output (Approx. @7.4V) 100 mA (Standby, Saver Off) 18 mA (Standby, Saver On) 4 mA (Auto Power Off) 1.5 A (5 W Tx , 144 MHz) 7.4 V DC 1.7 A (5 W Tx , 430 MHz) 7.4 V DC |
| Operating Temperature: | − 4 °F to +140 °F (− 20 °C to + 60 °C) |
| Case Size: | 2.1" (W) x 4.1" (H) x 1.2" (D) (52.5 x 104.5 x 31 mm) (W/O knob and antenna) |
| Weight: | 9.17 oz (260 g) with SBR-25LI and antenna |

Transmitter

| | |
|------------------------------|--|
| RF Power Output: | 5.0 W (High) / 2.5 W (Middle) / 0.5 W (Low) (@ 7.4 V with SBR-25LI) |
| Modulation Type: | Variable Reactance F2D, F3E |
| Maximum Deviation: | ±5.0 kHz (F2D, F3E) |
| Spurious Emission: | At least 60 dB down (@ High and Middle power) At least 40 dB down (@ Low power) |
| Microphone Impedance: | 2 kOhms |

Receiver

| | |
|----------------------|--|
| Circuit Type: | Direct-Conversion |
| Sensitivity : | 0.2 μ V for 12 dB SINAD (140 - 150 MHz, NFM) 0.2 μ V for 12 dB SINAD (420 - 470 MHz, NFM) |
| Selectivity: | 12 kHz / 35 kHz (-6 dB /-60 dB) |
| AF Output: | 0.8 W @ 16 ohms for 10% THD (@ 7.4 V) (Internal SP Max Power 1 W) 0.8 W @ 16ohms for 10%THD (@ 7.4 V) (EXT SP Jack Max Power 1 W) |

Specifications are subject to change without notice, and are guaranteed within the 144 and 430 MHz amateur bands only. Frequency ranges will vary according to transceiver version; check with your dealer.

“AUTO” Mode Preset Operating Parameter

USA Version

| Frequency Range (MHz) | Mode | Step |
|-----------------------|------|----------|
| 136.000-144.000 | FM | 12.5 kHz |
| 144.000-148.000 | FM | 5k Hz |
| 148.000-156.000 | FM | 12.5 kHz |
| 156.000-157.450 | FM | 25 kHz |
| 157.450-160.600 | FM | 12.5 kHz |
| 160.600-160.975 | FM | 25 kHz |
| 160.975-161.500 | FM | 12.5 kHz |
| 161.500-162.900 | FM | 25 kHz |
| 162.900-174.000 | FM | 12.5 kHz |

| Frequency Range (MHz) | Mode | Step |
|-------------------------|------|----------|
| 400.000-420.000 | FM | 12.5 kHz |
| 420.000-450.000 | FM | 25 kHz |
| 450.000-470.000 | FM | 12.5 kHz |
| 470.000-480.000 | FM | 50 kHz |
| 65.000-108.000(RX only) | WFM | 100 kHz |

Asian/European Version

| Frequency Range (MHz) | Mode | Step |
|-----------------------|------|----------|
| 136.000-160.600 | FM | 12.5 kHz |
| 160.600-162.025 | FM | 25 kHz |
| 162.025-174.000 | FM | 12.5 kHz |

| Frequency Range (MHz) | Mode | Step |
|-------------------------|------|----------|
| 400.000-430.000 | FM | 12.5 kHz |
| 430.000-440.000 | FM | 25 kHz |
| 440.000-470.000 | FM | 12.5 kHz |
| 470.000-480.000 | FM | 50k Hz |
| 65.000-108.000(RX only) | WFM | 100 kHz |

1. Changes or modifications to this device that are not expressly approved by YAESU MUSEN could void the user's authorization to operate this device.
2. This device complies with part 15 of the FCC Rules. Operation is subject to the following two conditions: (1) This device may not cause harmful interference, and (2) this device must accept any interference including received, interference that may cause undesired operation.
3. The scanning receiver in this equipment is incapable of tuning, or readily being altered, by the User to operate within the frequency bands allocated to the Domestic public Cellular Telecommunications Service in Part 22.

This device complies with Industry Canada license-exempt RSS standard(s). Operation is subject to the following two conditions: (1) this device may not cause interference, and (2) this device must accept any interference, including interference that may cause undesired operation of the device.

Le présent appareil est conforme aux CNR d'Industrie Canada applicables aux appareils radio exempts de licence. L'exploitation est autorisée aux deux conditions suivantes : (1) l'appareil ne doit pas produire de brouillage, et (2) l'utilisateur de l'appareil doit accepter tout brouillage radioélectrique subi, même si le brouillage est susceptible d'en compromettre le fonctionnement.

DECLARATION BY MANUFACTURER

The Scanner receiver is not a digital scanner and is incapable of being converted or modified to a digital scanner receiver by any user.

WARNING: MODIFICATION OF THIS DEVICE TO RECEIVE CELLULAR RADIOTELEPHONE SERVICE SIGNALS IS PROHIBITED UNDER FCC RULES AND FEDERAL LAW.

Disposal of your Electronic and Electric Equipment

Products with the symbol (crossed-out wheeled bin) cannot be disposed as household waste.

Electronic and Electric Equipment should be recycled at a facility capable of handling these items and their waste byproducts.

In EU countries, please contact your local equipment supplier representative or service center for information about the waste collection system in your country.



Attention in case of use

This transceiver works on frequencies which are not generally permitted.

As for the actual usage, the user has to possess an amateur radio licence.

Usage is allowed only in the frequency bands which are allocated for amateur radios.

| List of national codes | | | | | |
|------------------------|----|----|----|----|----|
| AT | BE | BG | CY | CZ | DE |
| DK | ES | EE | FI | FR | GB |
| GR | HR | HU | IE | IT | LT |
| LU | LV | MT | NL | PL | PT |
| RO | SK | SI | SE | CH | IS |
| LI | NO | -- | -- | -- | -- |

Declaration of Conformity

Nr. YUK-DOC-0304-17

Yaesu UK Ltd. certifies and declares, under our sole responsibility, that the following equipment complies with the essential requirements of the Directive 1999/5/EC and 2011/65/EU.

| | |
|--------------------------|---|
| Type of Equipment | 144/430MHz Dual Band Transceiver |
| Brand Name | YAESU |
| Model Number | FT-65E |
| Manufacturer | YAESU MUSEN CO. LTD. |
| Address of Manufacturer: | Tennozu Parkside Building, 2-5-8 Higashi-Shinagawa, Shinagawa-ku, Tokyo, 140-0002 Japan |

Applicable Standards:

This equipment is tested to, and conforms to the essential requirements of the directive, as included in the following standards:

| | |
|--|--|
| Health 1999/5/EC Art. 3 (1) (a) | EN 50566:2013 |
| Safety 1999/5/EC Art. 3 (1) (a) | EN 60950-1:2006+A2:2013 |
| EMC 1999/5/EC Art. 3 (1) (b) | EN 301 489-01 V1.9.2 EN 301 489-15 V1.2.1 |
| Radio Spectrum 1999/5/EC Art. 3 (2) | EN 301 783-02 V1.2.1 |
| ROHS2 2011/65/EU Art. 7 (b) | EN 50581:2012 |

The technical documentation as required by the Conformity Assessment procedures is kept at the following address:

| | |
|-----------------------------|---|
| Company Address | Yaesu UK Ltd Unit 12, Sun Valley Business Park, Winnall Close Winchester, Hampshire UK SO23 0LB |
| Technical Construction file | Issued by: Yaesu Musen Co. Ltd, Tokyo Japan File No: YETA00438 Drawn up in: Winchester, Hampshire UK Date: 20 th March 2017 |

Signed for and on behalf of Yaesu UK Ltd



Name and position: PCJ Bigwood
Technical Sales Manager

YAESU
The radio

Copyright 2017
YAESU MUSEN CO., LTD.
All rights reserved.

No portion of this manual may be
reproduced without the permission of
YAESU MUSEN CO., LTD.

YAESU MUSEN CO., LTD.

Tennozu Parkside Building
2-5-8 Higashi-Shinagawa, Shinagawa-ku, Tokyo 140-0002 Japan

YAESU USA

6125 Phyllis Drive, Cypress, CA 90630, U.S.A.

YAESU UK

Unit 12, Sun Valley Business Park, Winnall Close
Winchester, Hampshire, SO23 0LB, U.K.



Printed in China

