

YAESU

FT-60R

Technical Supplement

©2005 VERTEX STANDARD CO., LTD. EH017M90B

VERTEX STANDARD CO., LTD.

4-8-8 Nakameguro, Meguro-Ku, Tokyo 153-8644, Japan

VERTEX STANDARD

US Headquarters

10900 Walker Street, Cypress, CA 90630, U.S.A.

International Division

8350 N.W. 52nd Terrace, Suite 201, Miami, FL 33166, U.S.A.

YAESU EUROPE B.V.

P.O. Box 75525, 1118 ZN Schiphol, The Netherlands

YAESU UK LTD.

Unit 12, Sun Valley Business Park, Winnall Close
Winchester, Hampshire, SO23 0LB, U.K.

VERTEX STANDARD HK LTD.

Unit 5, 20/F., Seaview Centre, 139-141 Hoi Bun Road,
Kwun Tong, Kowloon, Hong Kong

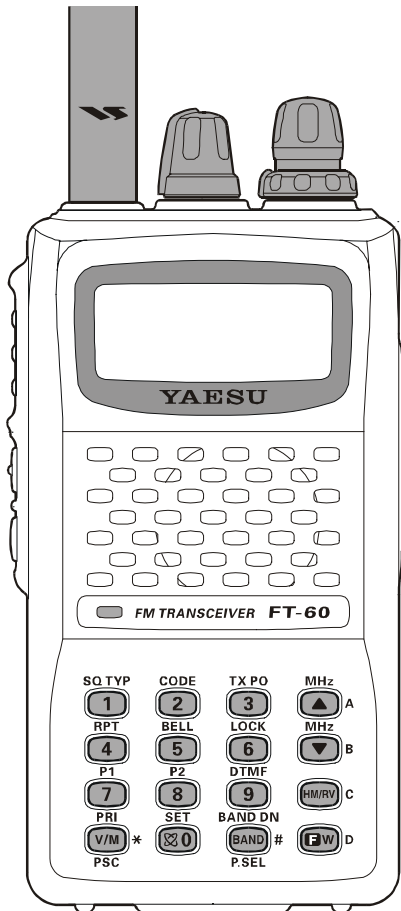

Introduction

This manual provides the technical information necessary for servicing the **FT-60R** VHF/UHF Dual Band Transceiver.

Servicing this equipment requires expertise in handling surface-mount chip components. Attempts by non-qualified persons to service this equipment may result in permanent damage not covered by the warranty, and may be illegal in some countries.

Two PCB layout diagrams are provided for each double-sided board in this transceiver. Each side of the board is referred to by the type of the majority of components installed on that side ("Side A" or "Side B"). In most cases one side has only chip components (surface-mount devices), and the other has either a mixture of both chip and leaded components (trimmers, coils, electrolytic capacitors, ICs, etc.), or leaded components only.

While we believe the information in this manual to be correct, VERTEX STANDARD assumes no liability for damage that may occur as a result of typographical or other errors that may be present. Your cooperation in pointing out any inconsistencies in the technical information would be appreciated.

Contents

Specifications	2
Exploded View & Miscellaneous Parts	4
Block Diagram	5
Circuit Description	7
Alignment	9
Board Units (Schematics, Layouts & Parts)	
MAIN Unit	13
VR Unit	47

Specifications

General

Frequency Ranges: (Cellular Blocked)	RX 108 - 137 MHz (Air Band), 137 - 520 MHz (AM/FM), 700 - 999.990 MHz (FM) TX 144-148 MHz, 430-450 MHz
Channel Steps:	5/10/12.5/15/20/25/50/100 kHz
Frequency Stability:	±5 ppm @ 14 °F to 140 °F (−10 °C to +60 °C)
Repeater Shift:	±600 kHz (144 MHz), ±1.6/5.0/7.6 MHz (430 MHz)
Emission Type:	F2 (F2D), F3 (F3E)
Antenna Impedance:	50 W
Supply Voltage: (Negative Ground)	Nominal: 7.2 V DC, Negative Ground Operating: 6.0 ~ 16.0 V DC (EXT DC Jack) 11.0 ~ 16.0 V DC (EXT DC Jack with Charging)
Current Consumption: (Approx. @7.2 V)	125 mA (Receive) 45 mA (144 MHz, Standby, Saver Off) 47 mA (430 MHz, Standby, Saver Off) 19 mA (Standby, Saver On) 0.8 mA (Auto Power Off) 1.5 A (5 W TX, 144 MHz) 1.6 A (5 W TX, 430 MHz)
Operating Temperature:	−4 °F to 140 °F (−20 °C to +60 °C)
Case Size:	2.3" (W) x 4.3" (H) x 1.2" (D) (58 x 109 x 30 mm) (W/O knob, antenna, and belt clip)
Weight:	13.05 Oz (370 g) with FNB-83, and antenna

Transmitter

RF Power Output:	5.0 W (High) / 2.0 W (Middle) / 0.5 W (Low) (Approx.)
Modulation Type:	Variable Reactance F2 (F2D), F3 (F3E)
Maximum Deviation:	±5.0 kHz (F2D, F3E)
Spurious Emission:	At least 60 dB down (@ High and Middle power) At least 40 dB down (@ Low power)
Microphone Impedance:	2 kW

Receiver

Circuit Type:	Double-Conversion Superheterodyne
Intermediate Frequencies:	1st: 47.25 MHz, 2nd: 450 kHz
Sensitivity : (Cellular Blocked)	0.8 µV TYP for 10 dB SN (108-137 MHz, AM) 0.2 µV for 12 dB SINAD (137-140 MHz, FM) 0.16 µV for 12 dB SINAD (140-150 MHz, FM) 0.2 µV for 12 dB SINAD (150-174 MHz, FM) 0.3 µV TYP for 12 dB SINAD (174-300 MHz, FM) 0.8 µV for 10 dB SN (300-336 MHz, AM) 0.25 µV for 12 dB SINAD (336-420 MHz, FM) 0.2 µV for 12 dB SINAD (400-470 MHz, FM) 0.25 µV for 12 dB SINAD (470-520 MHz, FM) 0.5 µV TYP for 12 dB SINAD (800-900 MHz, FM) 0.8 µV TYP for 12 dB SINAD (800-999.990 MHz, FM)
Selectivity:	12 kHz/35 kHz (−6 dB /−60 dB)
AF Output:	400 mW @ 8 W for 10 % THD (@ 7.5 V)

Specifications are subject to change without notice, and are guaranteed within the 144 and 430 MHz amateur bands only. Frequency ranges will vary according to transceiver version; check with your dealer.

Exploded View & Miscellaneous Parts

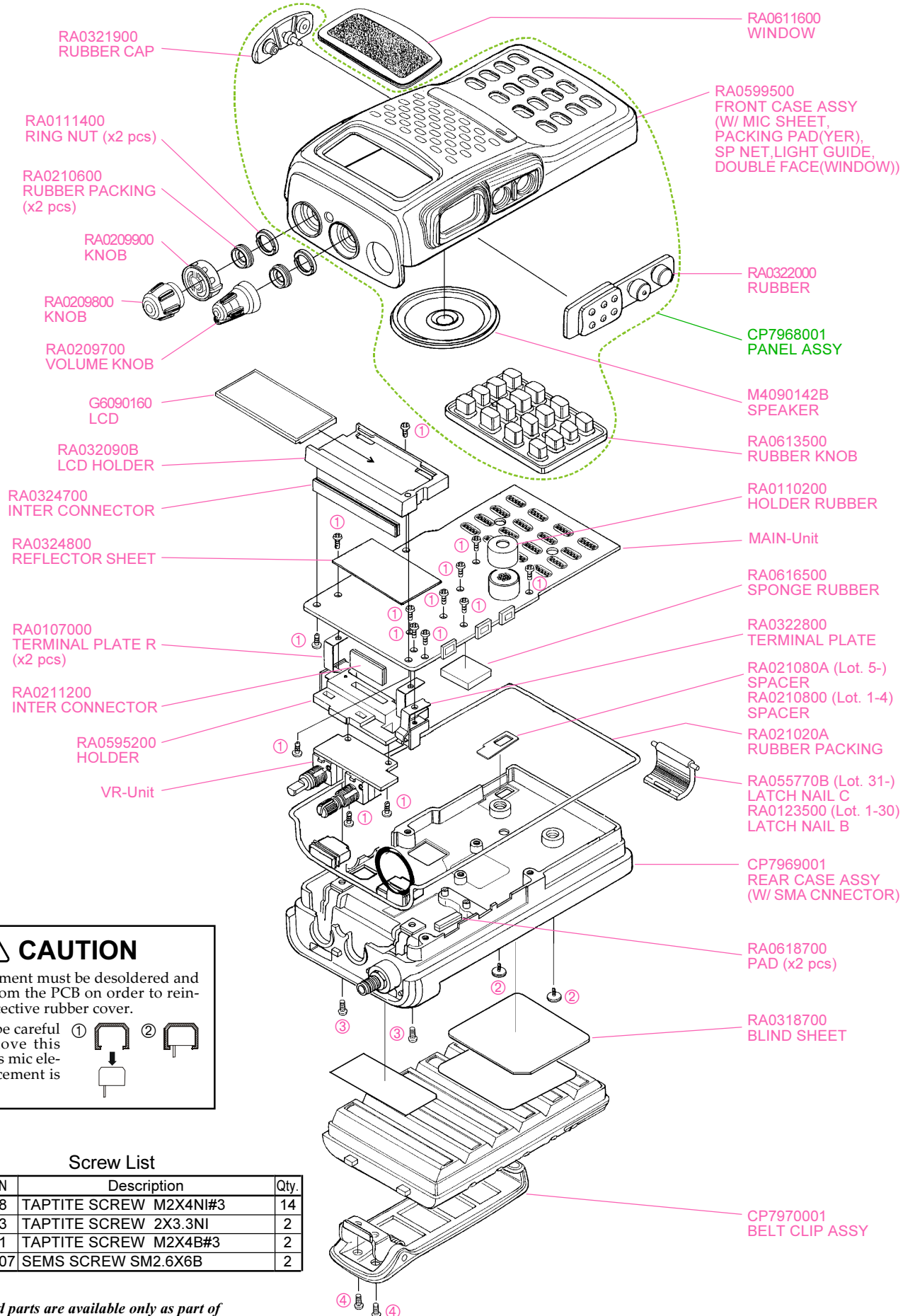

CAUTION

The mic element must be desoldered and removed from the PCB in order to re-install its protective rubber cover. Therefore, be careful not to remove this cover unless mic element replacement is necessary.

Screw List

No.	VXSTD P/N	Description	Qty.
①	U9900068	TAPTITE SCREW M2X4NI#3	14
②	U9900063	TAPTITE SCREW 2X3.3NI	2
③	U9900051	TAPTITE SCREW M2X4B#3	2
④	U02206007	SEMS SCREW SM2.6X6B	2

Non-designated parts are available only as part of a designated assembly.

Exploded View & Miscellaneous Parts

Note

Block Diagram

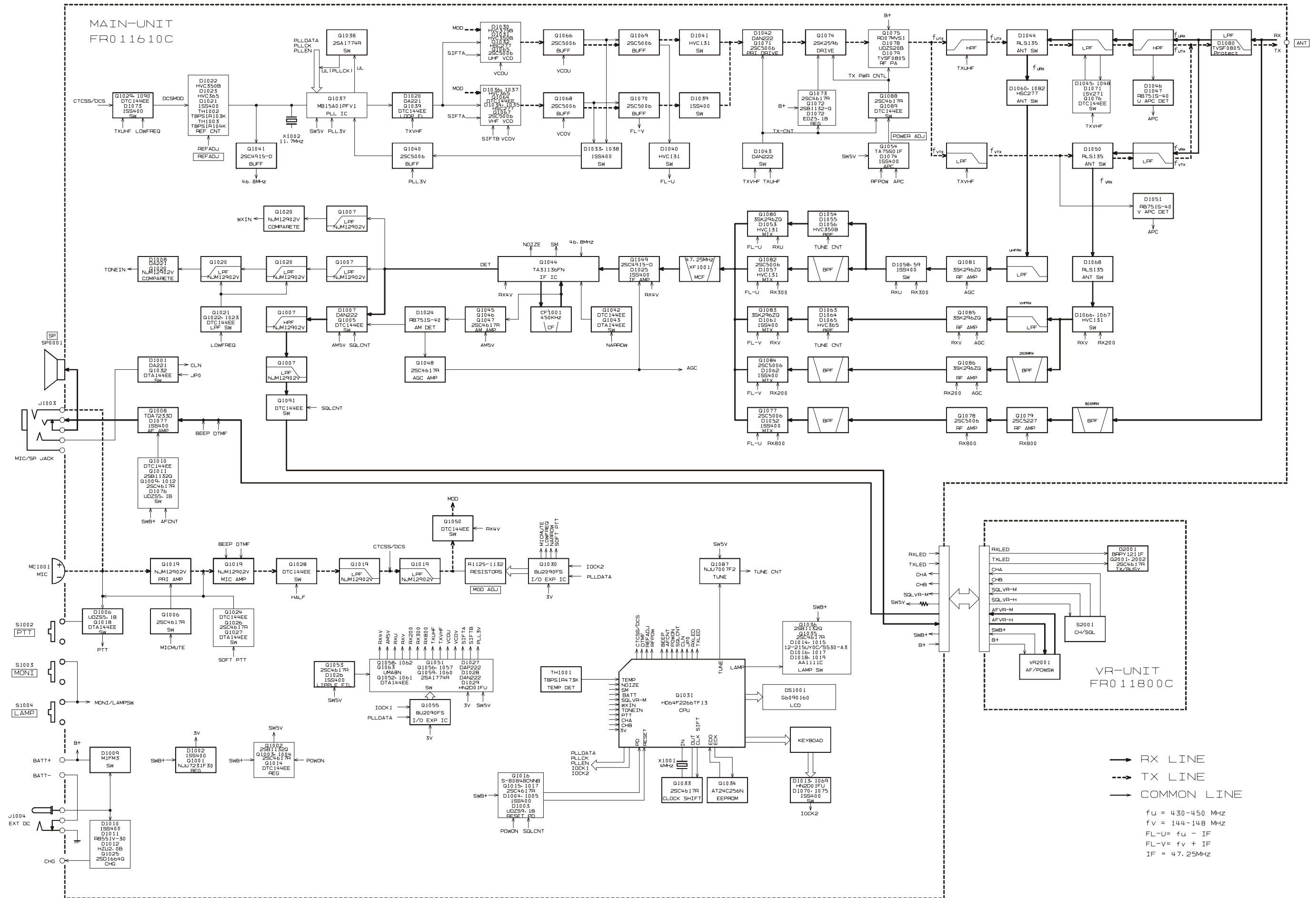

Block Diagram

Note

Circuit Description

VHF Reception

Incoming VHF signal is passed through the low-pass filter network, antenna switching diode **D1066 (HVC131)** and **D1068 (RLS135)**, and low-pass filter network to the RF amplifier **Q1085 (3SK296ZQ)**. The amplified RF signal is passed through band-pass filtered again by varactor-tuned resonators L1060, L1061 and L1062, and **D1063**, **D1064**, and **D1065** (all **HVC365**), then applied to the 1st mixer **Q1083 (3SK296ZQ)** along with the first local signal from the PLL circuit.

The first local signal is generated between 191.25 MHz and 195.25 MHz by the VHF VCO, which consists of **Q1067 (2SC5006)**, switching diodes **D1034**, **D1035** (both **HSC277**), and varactor diodes **D1036**, **D1037** (both **HVC365**) according to the receiving frequency.

UHF Reception

Incoming UHF signal is passed through the low-pass filter network, antenna switching diodes **D1060** and **D1082** (both **HSC277**), and Low-pass filter network to the RF amplifier **Q1081 (3SK296ZQ)**. The amplified RF signal is passed through band-pass filtered again by varactor-tuned resonators L1049, L1050 and L1051, and **D1054**, **D1055**, and **D1056** (all **HVC350B**), then applied to the 1st mixer **Q1080 (3SK296ZQ)** along with the first local signal from the PLL circuit.

The first local signal is generated between 382.75 MHz and 402.75 MHz by the UHF VCO, which consists of **Q1065 (2SC5006)** and varactor diodes **D1030 (HVC375B)**, **D1031 (HVC350B)** and switching diode **D1032 (HSC277)** according to the receiving frequency.

IF and Audio Circuits

The 47.25 MHz first IF signal is applied to the monolithic crystal filters XF1001 which strip away unwanted mixer products, and the IF signal is applied to the first IF amplifier **Q1049 (2SC4915)**. The amplified first IF signal is then delivered to the FM IF subsystem IC **Q1044 (TA31136FN)**, which contains the second mixer, limiter amplifier, noise amplifier, and FM detector.

The second local signal is generated by 46.8 MHz crystal X1002 and **Q1041 (2SC4915)**, produces the 450 kHz second IF signal when mixed with first IF signal within **Q1044 (TA31136FN)**.

The 450 kHz second IF signal is applied to the ceramic filter CF1001 which strip away unwanted mixer products to the ceramic discriminator CD1001 which removes any amplitude variations in the 450 kHz IF signal before detection of speech.

The detected audio passes through the de-emphasis network, low-pass filter consisting of **Q1007 (NJM12902V)**

and associated circuitry, and high-pass filter consisting of **Q1007 (NJM12902V)** and associated circuitry. The filtered audio signal is applied to the audio volume, then passes through the AF amplifier **Q1008 (TDA7233D)** and MIC/SP jack to the internal speaker or an external speaker.

Squelch Control

When no carrier received, noise at the output of the detector stage in **Q1044 (TA31136FN)** is amplified and band-pass filtered by the noise amp section of **Q1044 (TA31136FN)**. The resulting DC voltage is applied to pin 47 of main CPU **Q1031 (HD64F2266)**, which compares the squelch threshold level to that which set by the SQL knob.

While no carrier is received, pin 35 of **Q1031 (HD64F2266)** remains "low," squelch gate **Q1005** and **Q1091** (both **DTC144EE**) to turns off to disable any demodulated audio pass.

Transmit Signal Path

The speech signal from the microphone to AF amplified **Q1019 (NJM12902V)**. The amplified speech signal passes through low-pass filter network **Q1019 (NJM12902V)** to deviation controlled by **Q1030 (BU2090FS)**.

VHF Transmit Signal Path

The adjusted speech signal is delivered to VHF VCO **Q1067 (2SC5006)** which frequency modulates the transmitting VCO made up of **D1037 (HVC365)**.

The modulated transmit signal passes through buffer amplifier **Q1068** and **Q1070** (both **2SC5006**).

The filtered transmit signal applied to the Pre-Drive amplifier **Q1071 (2SC5006)** and Drive amplifier **Q1074 (2SK2596)**, then finally amplified by Power amplifier **Q1075 (RD07MVS1)** up to 5 Watts. This two stages power amplifier's gain is controlled by the APC circuit.

The 5 Watts RF signal passes through low-pass filter network, antenna switch **D1050 (RLS135)**, and another low-pass filter network, and then deliver to the ANT jack.

UHF Transmit Signal Path

The adjusted speech signal is delivered to UHF VCO **Q1065 (2SC5006)** which frequency modulates the transmitting VCO made up of **D1030 (HVC375)**.

The modulated transmit signal passes through buffer amplifier **Q1066** and **Q1069** (both **2SC5006**).

The filtered transmit signal applied to the Pre-Drive amplifier **Q1071 (2SC5006)** and Drive amplifier **Q1074 (2SK2596)**, then finally amplified by Power amplifier **Q1075 (RD07MVS1)** up to 5 Watts. This two stages power amplifier's gain is controlled by the APC circuit.

Circuit Description

The 5 Watts RF signal passes through high-pass filter and high-pass filter network, antenna switch **D1044 (RLS135)**, and another low-pass filter network, and then deliver to the ANT jack.

TX APC Circuit

A portion of the Power amplifier output is rectified by **D1051** (UHF: **D1046** and **D1047**) (all **RB751S**), then delivered to APC **Q1054 (TA75S01F)**, as a DC voltage which is proportional to the output level of the power amplifier.

The APC **Q1054 (TA75S01F)** is compared the rectified DC voltage from the power amplifier and the reference voltage from the main CPU **Q1031 (HD64F2266)**, to produce a control voltage, which regulates supply voltage to the Drive amplifier **Q1074 (2SK2596)** and Power amplifier **Q1075 (RD07MVS1)**, so as to maintain stable output power under varying antenna loading condition.

PLL

A portion of the output from the VCO **Q1065** (UHF: **2SC5006**) and **Q1067** (VHF: **2SC5006**), passes through buffer amplifier **Q1066** (UHF), **Q1068** (VHF), and **Q1040** (all **2SC5006**) programmable divider section of the PLL IC **Q1037 (MB15A01PFV1)**, which divided according to the frequency dividing data that is associated with the setting frequency input from the main CPU **Q1031 (HD64F2266)**. It is then sent to the phase comparator.

The 11.7 MHz frequency of the reference oscillator circuit made up of X1002 is divided by the reference frequency divider section of **Q1037 (MB15A01PFV1)** into 2340 or 1872 parts to become 5 kHz or 6.25 kHz comparative reference frequencies, which are utilized by the phase comparator.

The phase comparator section of **Q1037 (MB15A01PFV1)** compares the phase between the frequency-divided oscillation frequency of the VCO circuit and comparative frequency and its output is a pulse corresponding to the phase difference. This pulse is integrated by the charge pump and loop filter of **Q1037 (MB15A01PFV1)** into a control voltage (VCV) to control the oscillation frequency of the VCOs.

Introduction

The **FT-60R** is carefully aligned at the factory for the specified performance across the amateur band. Realignment should therefore not be necessary except in the event of a component failure. Only an authorized Vertex Standard representative should perform all component replacement and service, or the warranty policy may be void.

The following procedures cover the adjustments that are not normally required once the transceiver has left the factory. However, if damage occurs and some parts subsequently are replaced, realignment may be required. If a sudden problem occurs during normal operation, it is likely due to component failure; realignment should not be done until after the faulty component has been replaced.

We recommend that servicing be performed only by authorized Vertex Standard service technicians who are experienced with the circuitry and fully equipped for repair and alignment. If a fault is suspected, contact the dealer from whom the transceiver was purchased for instructions regarding repair. Authorized Vertex Standard service technicians realign all circuits and make complete performance checks to ensure compliance with factory specifications after replacing any faulty components.

Those who do undertake any of the following alignments are cautioned to proceed at their own risk. Problems caused by unauthorized attempts at realignment are not covered by the warranty policy. Also, Vertex Standard reserves the right to change circuits and alignment procedures in the interest of improved performance, without notifying owners.

Under no circumstances should any alignment be attempted unless the normal function and operation of the transceiver are clearly understood, the cause of the malfunction has been clearly pinpointed and any faulty components replaced, and realignment determined to be absolutely necessary.

Required Test Equipment

The following test equipment (and familiarity with its use) is necessary for complete realignment. Correction of problems caused by misalignment resulting from use of improper test equipment is not covered under the warranty policy. While most steps do not require all of the equipment listed, the interactions of some adjustments may require that more complex adjustments be performed afterwards.

Do not attempt to perform only a single step unless it is clearly isolated electrically from all other steps. Have all test equipment ready before beginning and, follow all of the steps in a section in the order presented.

- RF Signal Generator with calibrated output level at 500 MHz
- Deviation Meter (linear detector)
- In-line Wattmeter with 5% accuracy at 500 MHz
- 50-Ohm 10-W RF Dummy Load
- 8-Ohm AF Dummy Load
- Regulated DC Power Supply adjustable from 6 to 15 VDC, 2A
- Frequency Counter: 0.2-ppm accuracy at 500 MHz
- AF Signal Generator
- AC Voltmeter
- DC Voltmeter: high impedance
- UHF Sampling Coupler
- SINAD Meter

Alignment Preparation & Precautions

A 50-Ohm RF load and in-line wattmeter must be connected to the main antenna jack in all procedures that call for transmission; alignment is not possible with an antenna. After completing one step, read the next step to see if the same test equipment is required. If not, remove the test equipment (except dummy load and wattmeter, if connected) before proceeding.

Correct alignment requires that the ambient temperature be the same as that of the transceiver and test equipment, and that this temperature be held constant between 68 ~ 86° F (20° ~ 30° C). When the transceiver is brought into the shop from hot or cold air, it should be allowed some time to come to room temperature before alignment. Whenever possible, alignments should be made with oscillator shields and circuit boards firmly affixed in place. Also, the test equipment must be thoroughly warmed up before beginning.

Note: Signal levels in dB referred to in the alignment procedure are based on 0dB μ = 0.5 μ V.

Alignment

Test Setup

Set up the test equipment as shown below for transceiver alignment, and apply 9.9 V DC power to the transceiver. Refer to the drawings for Alignment Points.

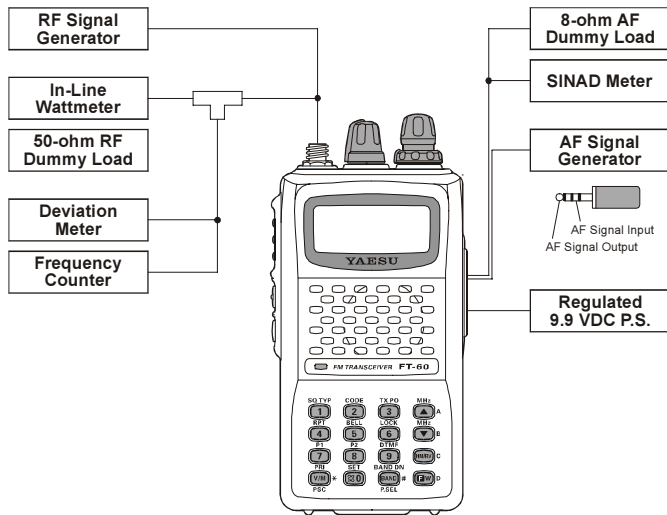

FT-60R ALIGNMENT SETUP

Entering the Alignment Mode

Alignment of the **FT-60R** is performed using a front panel software-based procedure. To perform alignment of the transceiver, it must first be placed in the "Alignment Mode," in which the adjustments will be made and then stored into memory.

To enter the Alignment mode:

1. Press and hold in the **MONI** and **LAMP** switches turning the radio on. Once the radio is on, release these two switches.
2. Press the keypad in the following sequence:
 $[\blacktriangle (MHz)] \rightarrow [0 (\text{SET})] \rightarrow [1 (SQ TYP)] \rightarrow [7 (P1)] \rightarrow [V/M (PRI)]$
3. Press the **[F/W]** key to cause "AO REF.xxx" to appear on the display for five seconds, this signifies that the transceiver is now in the "Alignment Mode."

PLL Reference Frequency

1. Tune the frequency to 435.050 MHz, then set the transmit power level to "LOW."
2. Press the **[F/W]** key, then press the **[BAND(BAND DN)]** key to set the alignment parameter to "AO REF.xxx," if needed.
3. Within five seconds of appearing the "AO REF.xxx" on the display, press the **PTT** switch to activate the transmitter, adjust the **DIAL** knob so that the counter frequency reading is 435.050 MHz (± 100 Hz).

RF Front-end Tuning

1. Connect the DC voltmeter to **TP1015** on the MAIN unit, then inject a 439.050 MHz signal at a level of +10 dB μ (with 1 kHz modulation @ ± 3.5 kHz deviation) from the RF signal generator.
2. Tune the frequency to 439.050 MHz.
3. Press the **[F/W]** key, then press the **[BAND(BAND DN)]** key to set the alignment parameter to "A1 TUN.xxx."
4. Within five seconds of appearing the "A1 TUN.xxx" on the display, adjust the **DIAL** knob so that the DC voltmeter reaches maximum deflection. The **FT-60R**'s RF Front-end has a broad bandwidth. Therefore, prior to adjustment you must adjust the **DIAL** knob to set the frequency to the middle of the band, in step 2, so you can set peak in the DC voltmeter's deflection in the center of the RF passband.
5. Tune the frequency to 145.050 MHz.
6. Inject a 145.050 MHz signal at a level of +10 dB μ (with 1 kHz modulation @ ± 3.5 kHz deviation) from the RF signal generator.
7. Press the **[F/W]** key to recall the alignment parameter to "A1 TUN.xxx."
8. Within five seconds of appearing the "A1 TUN.xxx" on the display, adjust the **DIAL** knob so that the DC voltmeter reaches maximum deflection. As in the previous section, be sure to set the **DIAL** knob for the center of the band prior to making this adjustment.

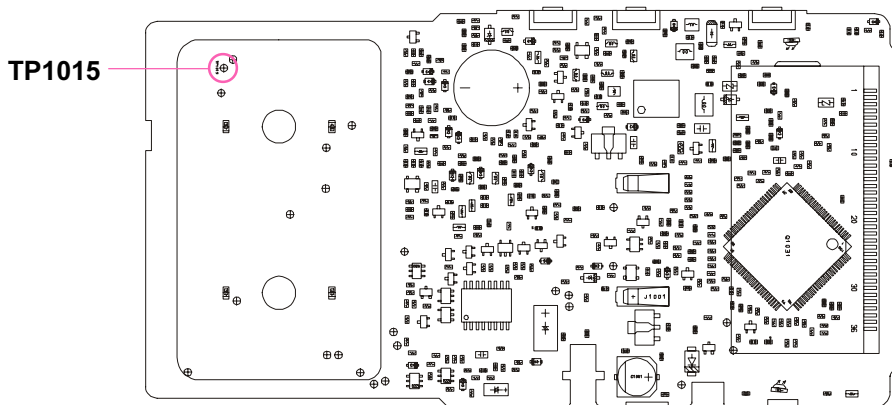

MAIN UNIT TEST POINT

TX Power Output

1. Tune the frequency to 440.050 MHz, then set the transmit power level to "LOW."
2. Press the **[F/W]** key, then press the **[BAND(BAND DN)]** key to set the alignment parameter to "A2 PWR.xxx."
3. Within five seconds of appearing the "A2 PWR.xxx" on the display, press the **PTT** switch to activate the transmitter, adjust the **DIAL** knob so that the wattmeter reading is 0.5 Watts (± 0.05 Watt).
4. Increase the Transmit power level to "MID."
5. Press the **[F/W]** key to recall the alignment parameter "A2 PWR.xxx."
6. Within five seconds of appearing the "A2 PWR.xxx" on the display, press the **PTT** switch to activate the transmitter, adjust the **DIAL** knob so that the wattmeter reading is 2.0 Watts (± 0.1 Watt).
7. Increase the Transmit power level to "HIGH."
8. Press the **[F/W]** key to recall the alignment parameter "A2 PWR.xxx."
9. Within five seconds of appearing the "A2 PWR.xxx" on the display, press the **PTT** switch to activate the transmitter, adjust the **DIAL** knob so that the wattmeter reading is 5.0 Watts (± 0.1 Watt).
10. Tune the frequency to 146.050 MHz, then set the transmit power level to "LOW."
11. Press the **[F/W]** key to recall the alignment parameter "A2 PWR.xxx."
12. Within five seconds of appearing the "A2 PWR.xxx" on the display, press the **PTT** switch to activate the transmitter, adjust the **DIAL** knob so that the wattmeter reading is 0.5 Watts (± 0.05 Watt).
13. Increase the Transmit power level to "MID."
14. Press the **[F/W]** key to recall the alignment parameter "A2 PWR.xxx."
15. Within five seconds of appearing the "A2 PWR.xxx" on the display, press the **PTT** switch to activate the transmitter, adjust the **DIAL** knob so that the wattmeter reading is 2.0 Watts (± 0.1 Watt).
16. Increase the Transmit power level to "HIGH."
17. Press the **[F/W]** key to recall the alignment parameter "A2 PWR.xxx" again.
18. Within five seconds of appearing the "A2 PWR.xxx" on the display, press the **PTT** switch to activate the transmitter, adjust the **DIAL** knob so that the wattmeter reading is 5.0 Watts (± 0.1 Watt).

TX Deviation

1. Tune the frequency to 440.050 MHz, then set the transmit power level to "LOW."
2. Inject a 1 kHz audio tone at a level of 80 mV (-20 dBm) from the audio generator.
3. Press the **[F/W]** key, then press the **[BAND(BAND DN)]** key to set the alignment parameter to "A3 DEV.xxx."
4. Within five seconds of appearing the "A3 DEV.xxx" on the display, press the **PTT** switch to activate the transmitter, adjust the **DIAL** knob so that the deviation meter reading is 4.2 kHz (± 0.2 kHz) (EXP version: 4.5 kHz ± 0.2 kHz).
5. Tune the frequency to 146.050 MHz, then set the transmit power level to "LOW."
6. Press the **[F/W]** key to recall the alignment parameter to "A3 DEV.xxx."
7. Within five seconds of appearing the "A3 DEV.xxx" on the display, press the **PTT** switch to activate the transmitter, adjust the **DIAL** knob so that the deviation meter reading is 4.2 kHz (± 0.2 kHz) (EXP version: 4.5 kHz ± 0.2 kHz).

DCS TX Deviation

1. Tune the frequency to 440.050 MHz, then activate the DCS, and set the transmit power level to "LOW."
2. Press the **[F/W]** key, then press the **[BAND(BAND DN)]** key to set the alignment parameter to "A4 DCS.xxx."
3. Within five seconds of appearing the "A4 DCS.xxx" on the display, press the **PTT** switch to activate the transmitter (with no microphone input), adjust the **DIAL** knob so that the deviation meter reading is 0.7 kHz (± 0.05 kHz).
4. Tune the frequency to 146.050 MHz, then activate the DCS, and set the transmit power level to "LOW."
5. Press the **[F/W]** key to recall the alignment parameter to "A4 DCS.xxx."
6. Within five seconds of appearing the "A4 DCS.xxx" on the display, press the **PTT** switch to activate the transmitter (with no microphone input), adjust the **DIAL** knob so that the deviation meter reading is 0.7 kHz (± 0.05 kHz).

Alignment

CTCSS TX Deviation

1. Tune the frequency to 440.050 MHz, then activate the CTCSS encoder with a “100 Hz” tone, and set the transmit power level to “LOW.”
2. Press the **[F/W]** key, then press the **[BAND(BAND DN)]** key to set the alignment parameter to “A5 CTC.xxx.”
3. Within five seconds of appearing the “A5 CTC.xxx” on the display, press the **PTT** switch to activate the transmitter (with no microphone input), adjust the **DIAL** knob so that the deviation meter reading is 0.7 kHz (± 0.05 kHz).
4. Tune the frequency to 146.050 MHz, then activate the CTCSS encoder with a “100 Hz” tone, and set the transmit power level to “LOW.”
5. Press the **[F/W]** key to recall the alignment parameter to “A5 CTC.xxx.”
6. Within five seconds of appearing the “A5 CTC.xxx” on the display, press the **PTT** switch to activate the transmitter (with no microphone input), adjust the **DIAL** knob so that the deviation meter reading is 0.7 kHz (± 0.05 kHz).

S-meter Sensitivity

1. Tune the frequency to 440.050 MHz.
2. Inject a 440.050 MHz signal at a level of -5 dB μ V (with 1 kHz modulation @ ± 3.5 kHz deviation) from the RF signal generator.
3. Press the **[F/W]** key, then press the **[BAND(BAND DN)]** key to set the alignment parameter to “A6 SM U/D.”
4. Within five seconds of appearing the “A6 SM U/D” on the display, press the **[▼(MHz)]** key.
5. Increase the RF signal generator output level to +23 dB μ V.
6. Press the **[F/W]** key to recall the alignment parameter to “A6 SM U/D.”
7. Within five seconds of appearing the “A6 SM U/D” on the display, press the **[▲(MHz)]** key.
8. Tune the frequency to 850.050 MHz.
9. Inject a 850.050 MHz signal at a level of +5 dB μ V (with 1 kHz modulation @ ± 3.5 kHz deviation) from the RF signal generator.
10. Press the **[F/W]** key to recall the alignment parameter to “A6 SM U/D.”
11. Within five seconds of appearing the “A6 SM U/D” on the display, press the **[▼(MHz)]** key.
12. Increase the RF signal generator output level to +31 dB μ V.
13. Press the **[F/W]** key to recall the alignment parameter to “A6 SM U/D.”
14. Within five seconds of appearing the “A6 SM U/D” on the display, press the **[▲(MHz)]** key.

15. Tune the frequency to 146.050 MHz.
16. Inject a 146.050 MHz signal at a level of -5 dB μ V (with 1 kHz modulation @ ± 3.5 kHz deviation) from the RF signal generator.
17. Press the **[F/W]** key to recall the alignment parameter to “A6 SM U/D.”
18. Within five seconds of appearing the “A6 SM U/D” on the display, press the **[▼(MHz)]** key.
19. Increase the RF signal generator output level to +23 dB μ V.
20. Press the **[F/W]** key to recall the alignment parameter to “A6 SM U/D.”
21. Within five seconds of appearing the “A6 SM U/D” on the display, press the **[▲(MHz)]** key.
22. Tune the frequency to 230.050 MHz.
23. Inject a 230.050 MHz signal at a level of -5 dB μ V (with 1 kHz modulation @ ± 3.5 kHz deviation) from the RF signal generator.
24. Press the **[F/W]** key to recall the alignment parameter to “A6 SM U/D.”
25. Within five seconds of appearing the “A6 SM U/D” on the display, press the **[▼(MHz)]** key.
26. Increase the RF signal generator output level to +23 dB μ V.
27. Press the **[F/W]** key to recall the alignment parameter to “A6 SM U/D.”
28. Within five seconds of appearing the “A6 SM U/D” on the display, press the **[▲(MHz)]** key.
29. Tune the frequency to 350.050 MHz.
30. Inject a 350.050 MHz signal at a level of -5 dB μ V (with 1 kHz modulation @ ± 3.5 kHz deviation) from the RF signal generator.
31. Press the **[F/W]** key to recall the alignment parameter to “A6 SM U/D.”
32. Within five seconds of appearing the “A6 SM U/D” on the display, press the **[▼(MHz)]** key.
33. Increase the RF signal generator output level to +23 dB μ V.
34. Press the **[F/W]** key to recall the alignment parameter to “A6 SM U/D.”
35. Within five seconds of appearing the “A6 SM U/D” on the display, press the **[▲(MHz)]** key.

DC Voltmeter

1. Set the power supply voltage to 9.9 V.
2. Press the **[F/W]** key, then press the **[BAND(BAND DN)]** key to set the alignment parameter to “A7 BAT RV.”
3. Within five seconds of appearing the “A7 BAT RV” on the display, press the **[HM/RV]** key.

To close the alignment mode, just turn the power off by rotating the **VOL** knob fully counter clockwise. The next time the transceiver is turned on, normal operation may resume.

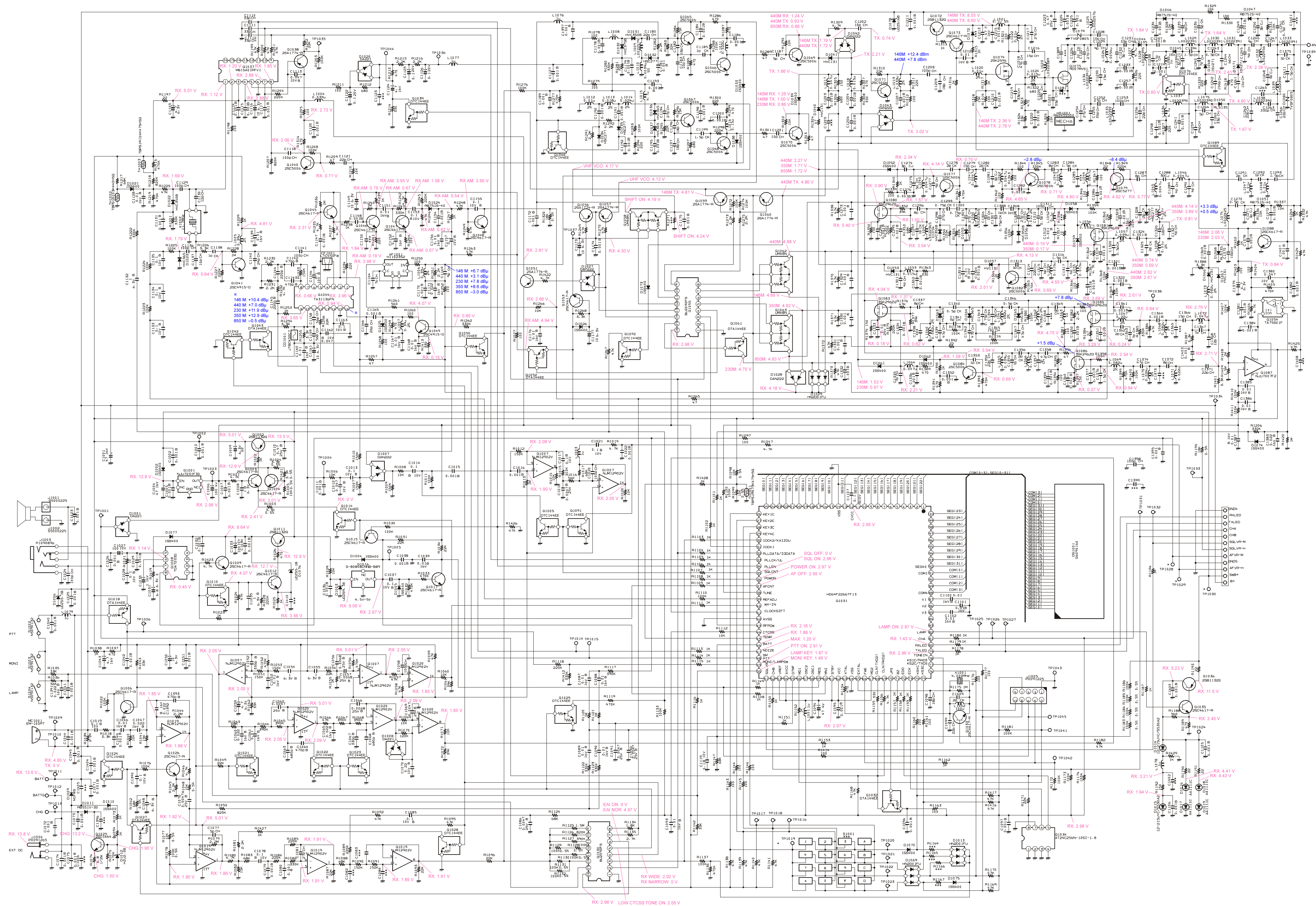

MAIN Unit (Lot. 1 ~ 5)

Note

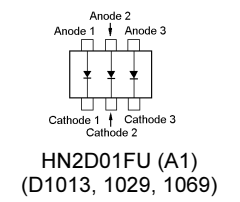
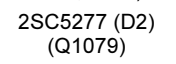
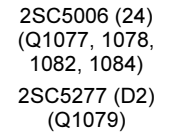
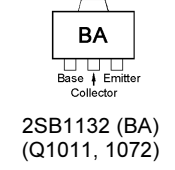
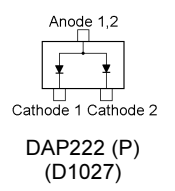
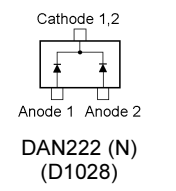
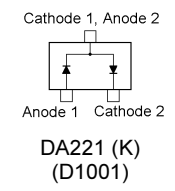
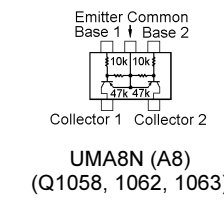
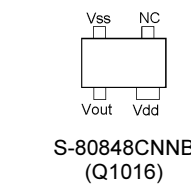
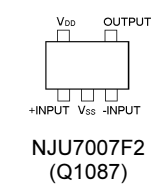
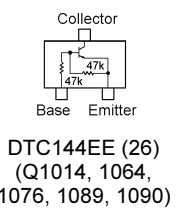
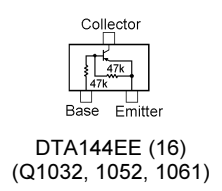
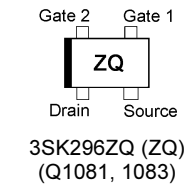
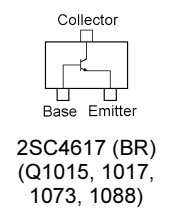
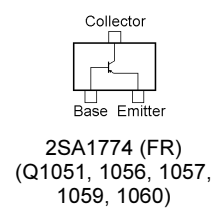
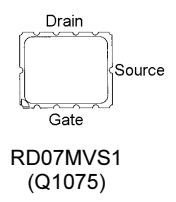
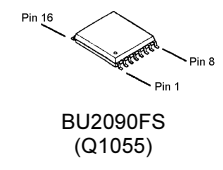
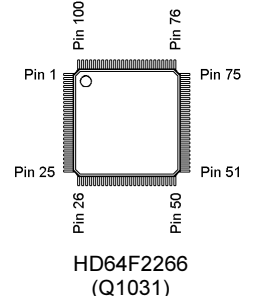
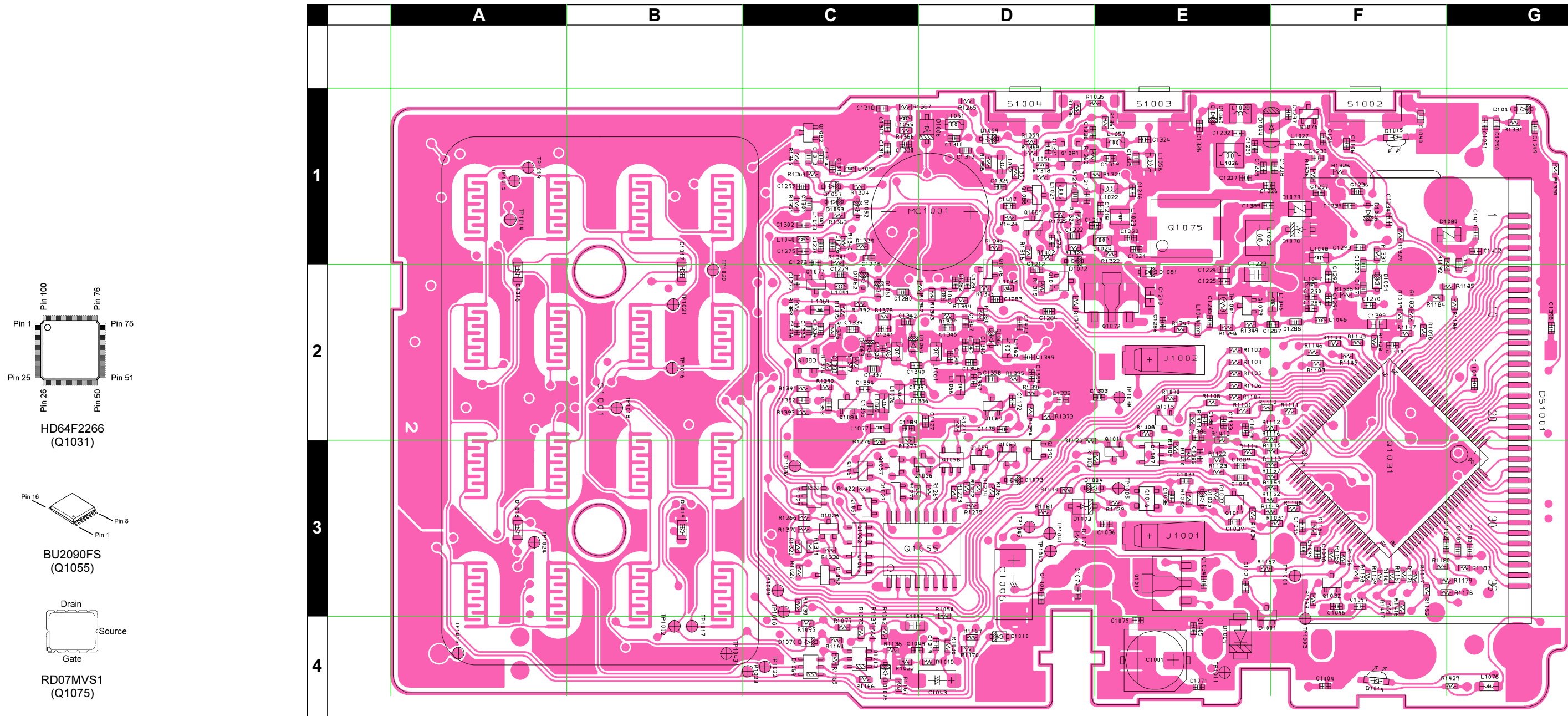

MAIN Unit (Lot. 1 ~ 5)

Parts Layout (Side B)

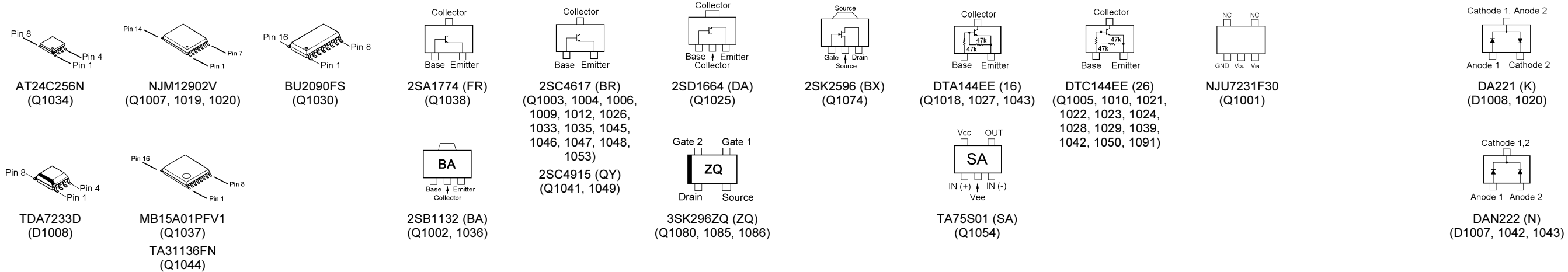
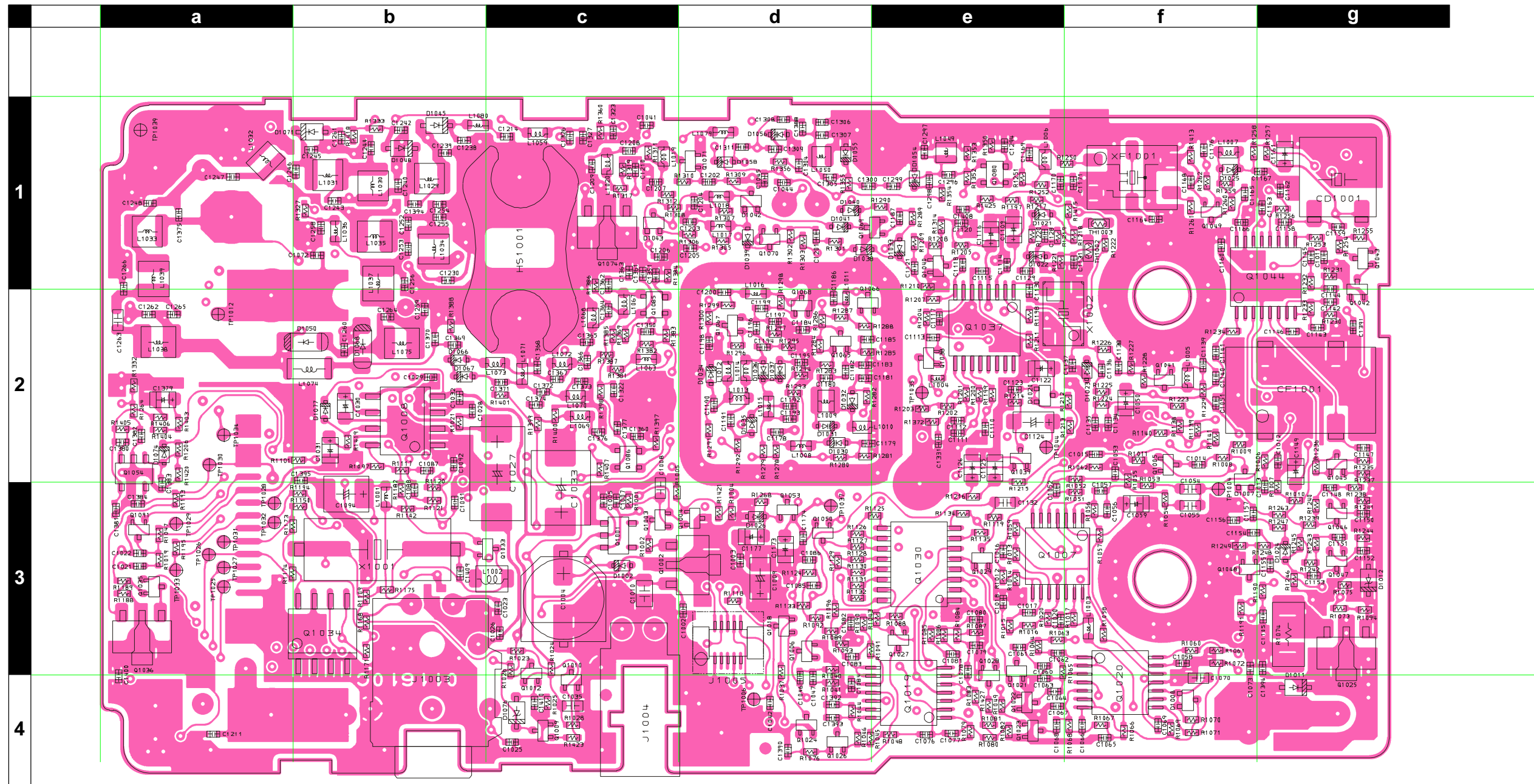

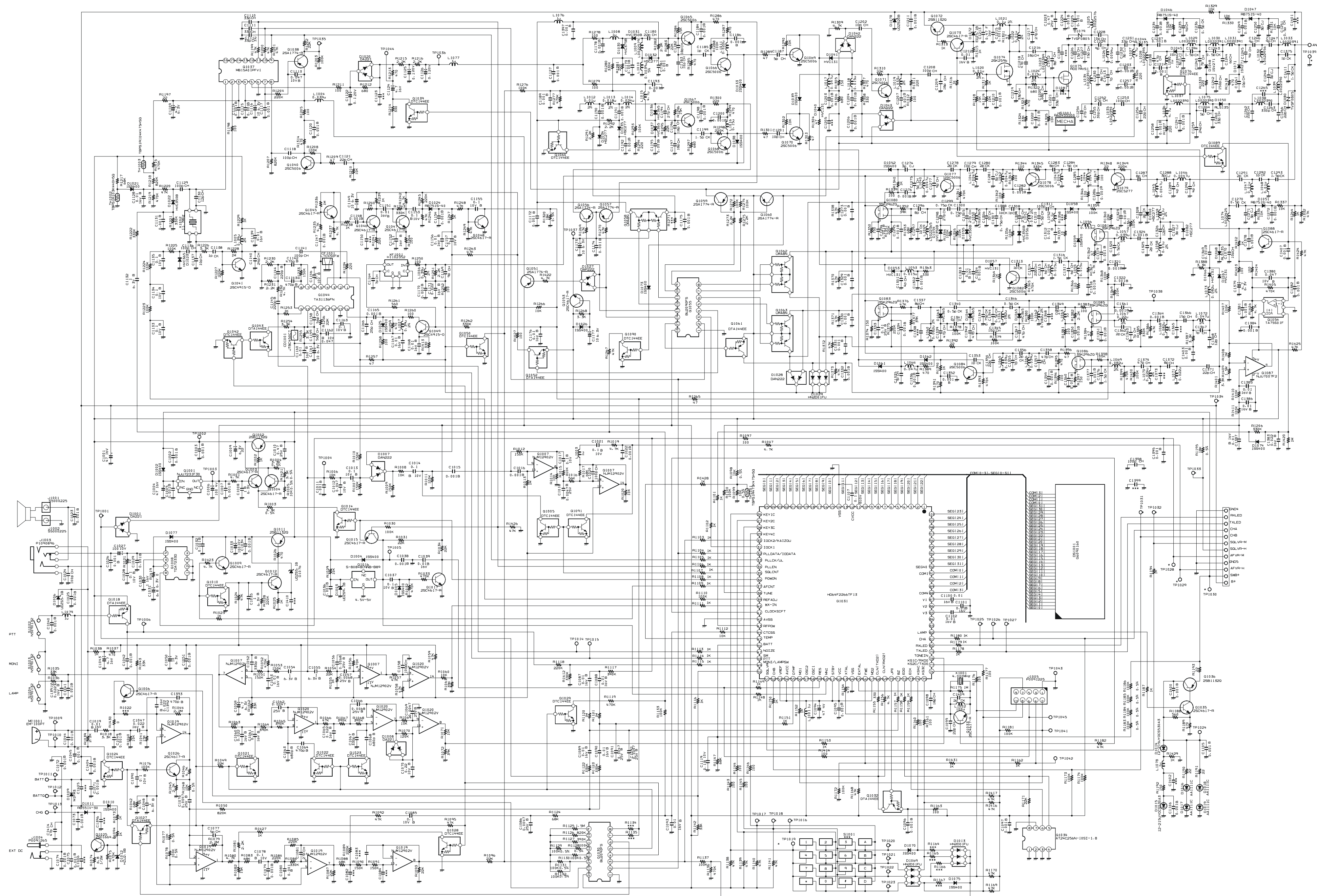

MAIN Unit (Lot. 6 ~ 9)

Note

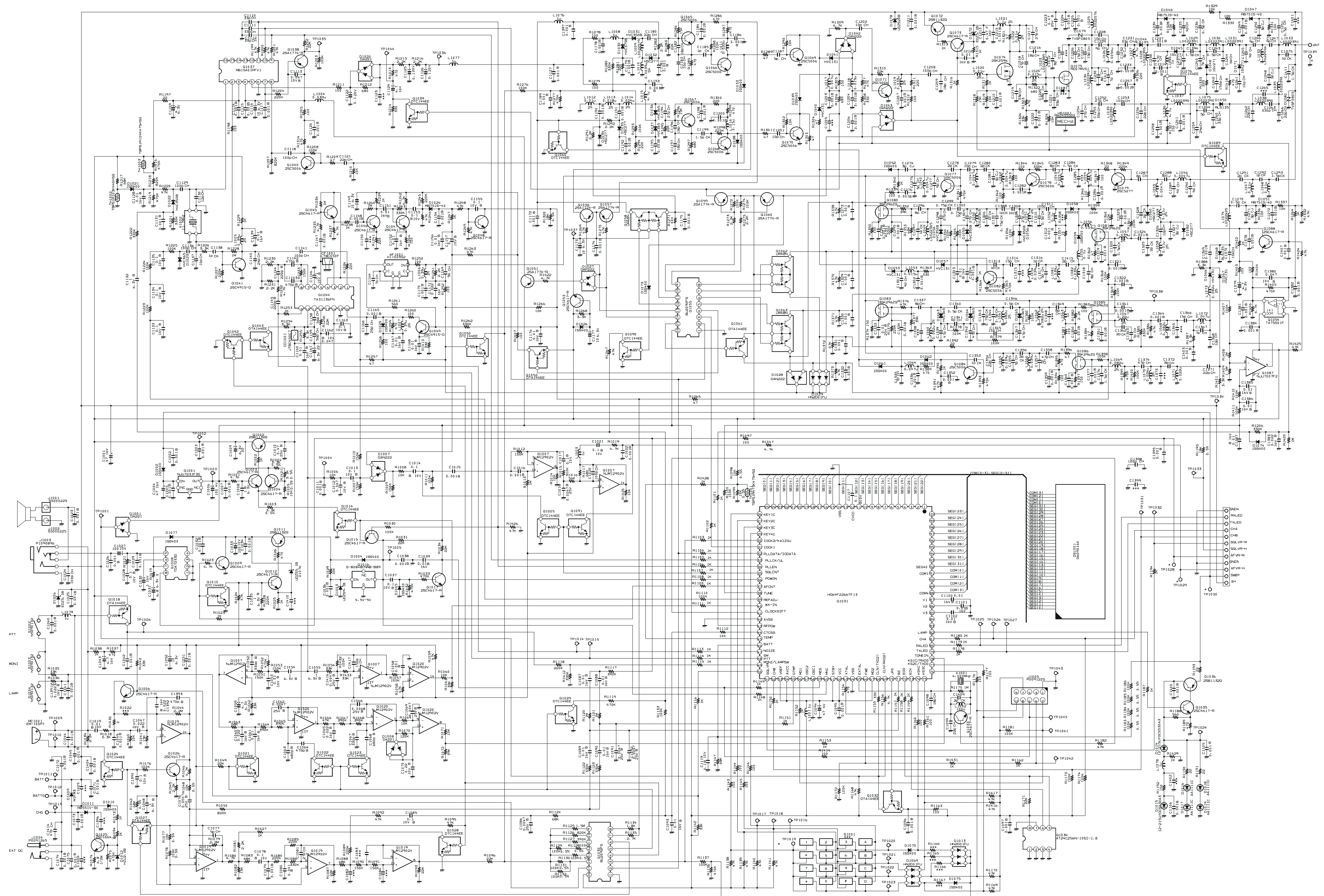

MAIN Unit (Lot. 10 ~ 11)

Note

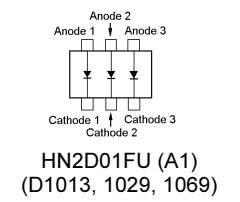
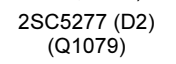
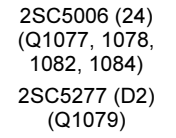
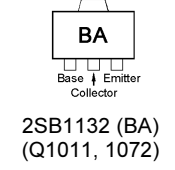
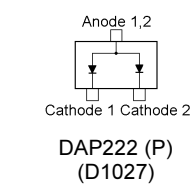
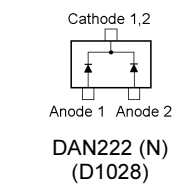
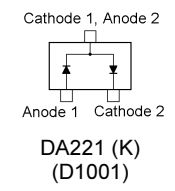
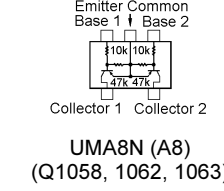
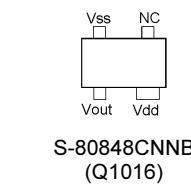
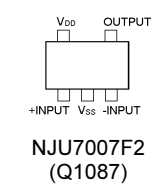
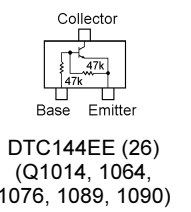
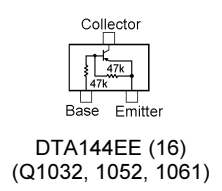
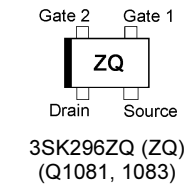
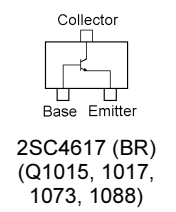
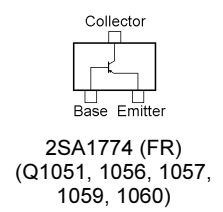
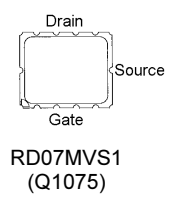
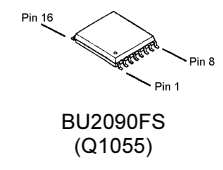
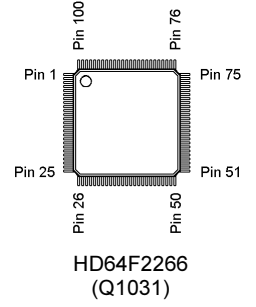
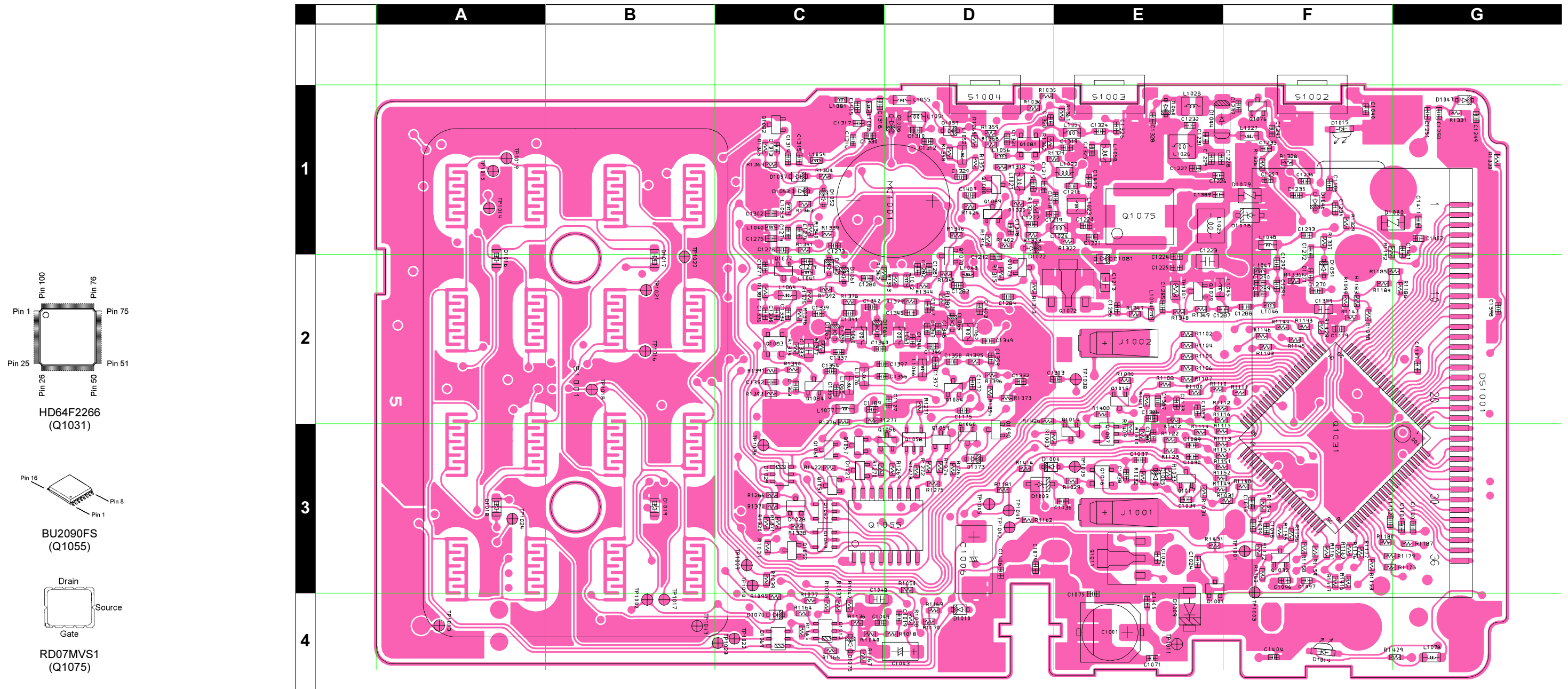

MAIN Unit (Lot. 12 ~)

Note

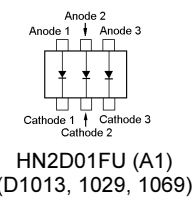
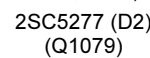
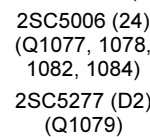
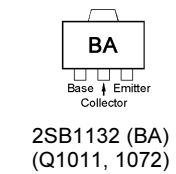
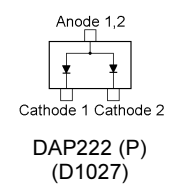
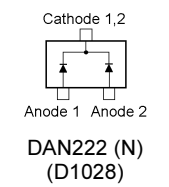
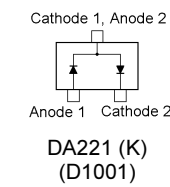
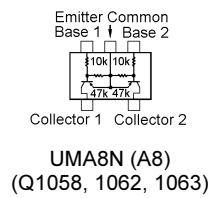
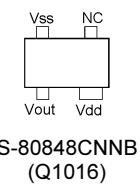
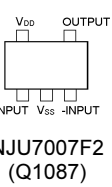
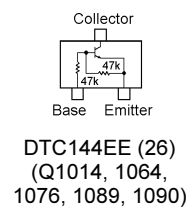
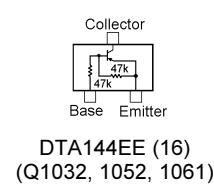
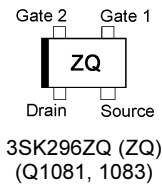
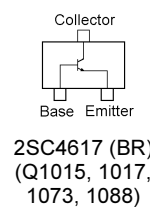
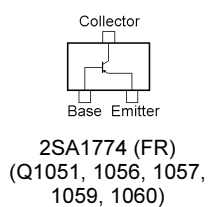
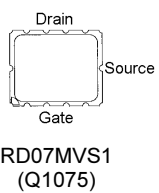
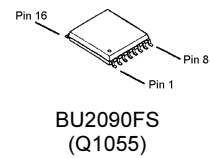
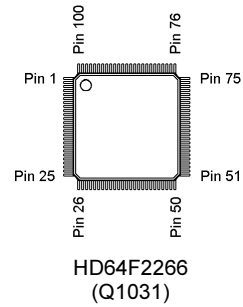
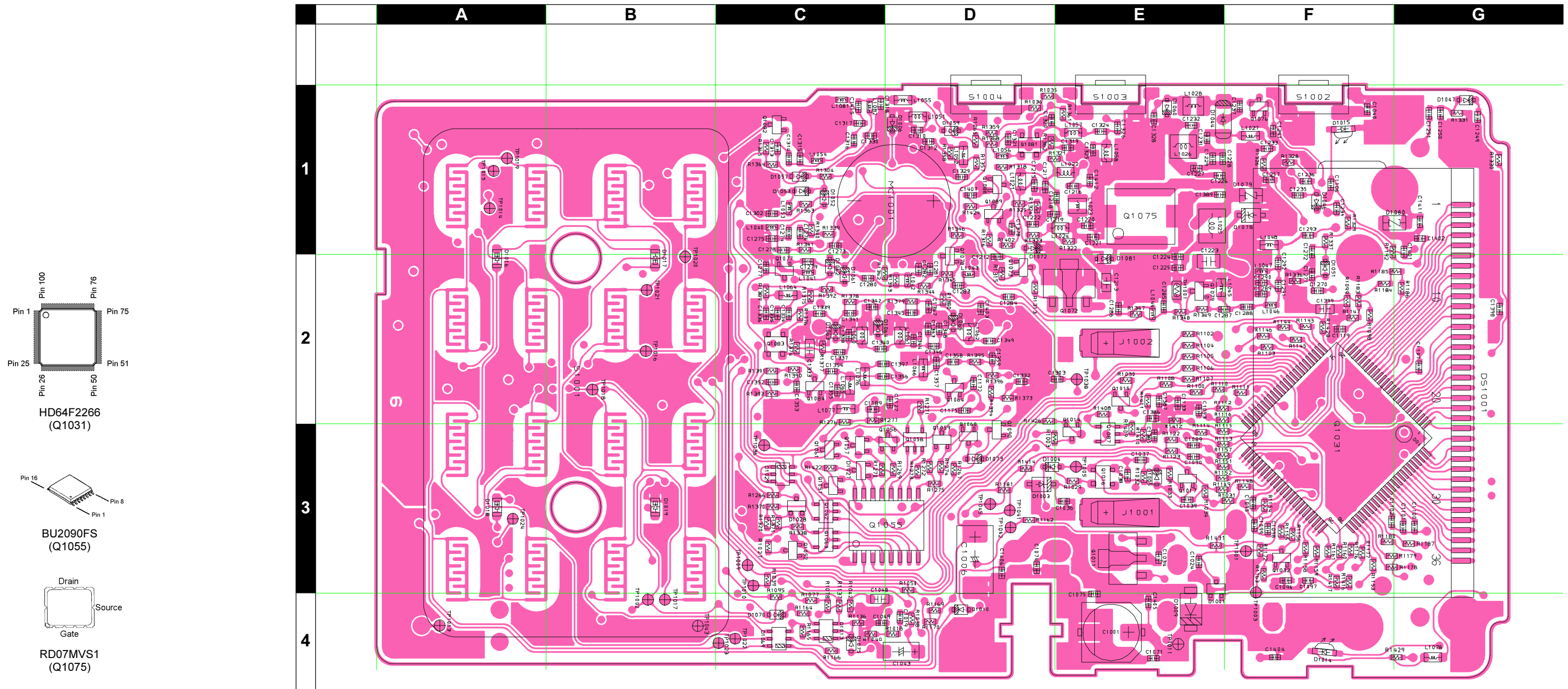

MAIN Unit

Parts List

REF	DESCRIPTION	VALUE	V/W	TOL.	MFR'S DESIG	VXSTD P/N	VERS.	LOT	SIDE	LAY ADR
	PCB with Components (W/ VR Unit)					CP7965002	USA A2U			
	PCB with Components (W/ VR Unit)					CP7965003	EXP A1			
	PCB with Components (W/ VR Unit)					CP7965004	EXP A2			
	PCB with Components (W/ VR Unit)					CP7965005	EXP A3			
	PCB with Components (W/ VR Unit)					CP7965006	EU B1			
	PCB with Components (W/ VR Unit)					CP7965007	EU B2			
	PCB with Components (W/ VR Unit)					CP7965008	EXP B3			
	PCB with Components (W/ VR Unit)					CP7965009	EU C1			
	PCB with Components (W/ VR Unit)					CP7965010	EU C2			
	PCB with Components (W/ VR Unit)					CP7965011	EXP C3			
	PCB with Components (W/ VR Unit)					CP7965012	EU D1			
	PCB with Components (W/ VR Unit)					CP7965013	EU D2			
	PCB with Components (W/ VR Unit)					CP7965014	AUS H1			
	PCB with Components (W/ VR Unit)					CP7965015	AUS H2			
	Printed Circuit Board					FR011840C		1-		
						FR011840D		3-		
						FR011840E		6-		
						FR011840F		10-		
						FR011840G		12-		
C 1001	AL.ELECTRO.CAP.	47uF	16V		ECEV1CA470WR	K48120013		1-	A	E4
C 1002	CHIP CAP.	0.001uF	50V	B	GRM155B11H102KA01D	K22178809		1-	B	d3
C 1003	CHIP CAP.	0.001uF	50V	B	GRM155B11H102KA01D	K22178809		1-	B	d3
C 1004	AL.ELECTRO.CAP.	47uF	16V		RV4-16V470MF46-RR2	K48120019		1-	B	c3
C 1005	CHIP CAP.	0.001uF	50V	B	GRM155B11H102KA01D	K22178809		1-	B	c3
C 1006	CHIP TA.CAP.	100uF	4V		TEMSVC0G107M12R	K78060021		1-	A	D3
C 1007	CHIP CAP.	0.001uF	50V	B	GRM155B11H102KA01D	K22178809		1-	B	c3
C 1008	CHIP CAP.	1uF	6.3V	B	GRM188B10J105KA01D	K22084801		1-	B	c3
C 1009	CHIP TA.CAP.	22uF	6.3V		TEMSVA0J226M-8R	K78080047		1-	B	d3
C 1010	CHIP CAP.	0.47uF	25V	B	GRM40B474K25PT	K22140824		1-	B	c3
C 1011	CHIP CAP.	0.001uF	50V	B	GRM155B11H102KA01D	K22178809		1-	B	g1
C 1012	CHIP CAP.	0.047uF	10V	B	GRM36B473K10PT	K22108801		1-	B	g2
C 1013	CHIP CAP.	0.1uF	10V	B	GRM36B104K10PT	K22108802		1-	B	g3
C 1014	CHIP CAP.	0.1uF	10V	B	GRM36B104K10PT	K22108802		1-	B	f2
C 1015	CHIP CAP.	0.001uF	50V	B	GRM155B11H102KA01D	K22178809		1-	B	f2
C 1016	CHIP CAP.	0.001uF	50V	B	GRM155B11H102KA01D	K22178809		1-	B	e3
C 1017	CHIP CAP.	0.1uF	10V	B	GRM36B104K10PT	K22108802		1-	B	e3
C 1018	CHIP CAP.	0.0047uF	25V	B	GRM36B472K25PT	K22148830		1-	B	e3
C 1019	CHIP CAP.	0.01uF	16V	B	GRM36B103K16PT	K22128804		1-	A	D4
C 1020	CHIP CAP.	100pF	50V	CH	GRM155C1H101JD01D	K22178236		1-	B	e3
C 1021	CHIP CAP.	0.1uF	10V	B	GRM36B104K10PT	K22108802		1-	B	a3
C 1022	CHIP CAP.	0.001uF	50V	B	GRM155B11H102KA01D	K22178809		1-	B	a3
C 1023	CHIP CAP.	0.001uF	50V	B	GRM155B11H102KA01D	K22178809		1-	B	c3
C 1024	CHIP CAP.	100pF	50V	CH	GRM155C1H101JD01D	K22178236		1-	A	E3
C 1025	CHIP CAP.	0.001uF	50V	B	GRM155B11H102KA01D	K22178809		1-	B	c4
C 1026	CHIP CAP.	0.001uF	50V	B	GRM155B11H102KA01D	K22178809		1-	B	c3
C 1027	CHIP TA.CAP.	100uF	10V		TEMSVD1A107M12R	K78100031		1-	B	c2
C 1028	CHIP CAP.	0.1uF	10V	B	GRM36B104K10PT	K22108802		1-	B	b2
C 1029	CHIP CAP.	0.001uF	50V	B	GRM155B11H102KA01D	K22178809		1-	B	b2
C 1030	CHIP TA.CAP.	1uF	16V		TESVSP1C105M-8R	K78120058		1-	B	b2
C 1030	CHIP TA.CAP.	1uF	16V		TEESVP1C105M8R	K78120076		31-	B	b2
C 1031	CHIP TA.CAP.	6.8uF	6.3V		TESVSP0J685M-8R	K78080054		1-	B	b2
C 1032	CHIP CAP.	0.001uF	50V	B	GRM155B11H102KA01D	K22178809		1-	B	b2
C 1033	CHIP TA.CAP.	100uF	10V		TEMSVD21A107M12R	K78100049		1-	B	c3
C 1034	CHIP CAP.	0.001uF	50V	B	GRM155B11H102KA01D	K22178809		1-	A	E3
C 1035	CHIP CAP.	1uF	6.3V	B	GRM188B10J105KA01D	K22084801		1-	B	c4
C 1036	CHIP CAP.	0.001uF	50V	B	GRM155B11H102KA01D	K22178809		1-	A	E3
C 1037	CHIP CAP.	0.1uF	10V	B	GRM36B104K10PT	K22108802		1-	A	E3
C 1038	CHIP CAP.	0.001uF	50V	B	GRM155B11H102KA01D	K22178809		1-	A	E3
C 1039	CHIP CAP.	0.01uF	16V	B	GRM36B103K16PT	K22128804		1-	A	E3
C 1040	CHIP CAP.	0.001uF	50V	B	GRM155B11H102KA01D	K22178809		1-	A	F1
C 1041	CHIP CAP.	0.001uF	50V	B	GRM155B11H102KA01D	K22178809		1-	B	c1
C 1042	CHIP CAP.	0.001uF	50V	B	GRM155B11H102KA01D	K22178809		1-	B	d4
C 1043	CHIP TA.CAP.	4.7uF	16V		TEMSVA1C475M-8R	K78120031		1-	A	D4
C 1044	CHIP CAP.	0.001uF	50V	B	GRM155B11H102KA01D	K22178809		1-	B	d1
C 1045	CHIP CAP.	0.001uF	50V	B	GRM155B11H102KA01D	K22178809		1-	B	d1
C 1047	CHIP CAP.	0.022uF	16V	B	GRM36B223K16PT	K22128806		1-	B	d4
C 1048	CHIP CAP.	1uF	6.3V	B	GRM188B10J105KA01D	K22084801		1-	A	C4
C 1049	CHIP CAP.	0.001uF	50V	B	GRM155B11H102KA01D	K22178809		1-	A	C4
C 1050	CHIP TA.CAP.	10uF	6.3V		TESVSP0J106M-8R	K78080055		1-	B	f2
C 1051	CHIP CAP.	0.001uF	50V	B	GRM155B11H102KA01D	K22178809		1-	B	f2
C 1052	CHIP CAP.	330pF	50V	B	GRM155B11H331KA01D	K22178803		1-	B	e3
C 1053	CHIP CAP.	0.01uF	16V	B	GRM36B103K16PT	K22128804		1-	B	f2
C 1054	CHIP CAP.	1uF	6.3V	B	GRM188B10J105KA01D	K22084801		1-	B	f3

MAIN Unit

Parts List

REF	DESCRIPTION	VALUE	V/W	TOL.	MFR'S DESIG	VXSTD P/N	VERS.	LOT	SIDE	LAY ADR
C 1055	CHIP CAP.	1uF	6.3V	B	GRM188B10J105KA01D	K22084801		1-	B	f3
C 1056	CHIP CAP.	0.0068uF	25V	B	GRM36B682K25PT	K22148803		1-2		
C 1056	CHIP CAP.	0.0068uF	25V	B	GRM36B682K25PT	K22148803	AUSTRALIA	3		
C 1056	CHIP CAP.	0.0068uF	25V	B	GRM36B682K25PT	K22148803	EUROPE	3		
C 1056	CHIP CAP.	0.0068uF	25V	B	GRM36B682K25PT	K22148803	EXPORT	3		
C 1056	CHIP CAP.	470pF	50V	B	GRM155B11H471KA01D	K22178805	JAPAN	3		
C 1056	CHIP CAP.	0.0068uF	25V	B	GRM36B682K25PT	K22148803	USA	3		
C 1057	CHIP CAP.	0.0068uF	25V	B	GRM36B682K25PT	K22148803		1-3		
C 1058	CHIP CAP.	100pF	50V	CH	GRM1552C1H101JD01D	K22178236		1-	B	f3
C 1058	CHIP CAP.	0.001uF	50V	B	GRM155B11H102KA01D	K22178809		4-	B	f3
C 1059	CHIP TA.CAP.	4.7uF	6.3V		TESVSP0J475M-8R	K78080053		1-	B	f3
C 1060	CHIP CAP.	0.022uF	16V	B	GRM36B223K16PT	K22128806		1-	B	e3
C 1061	CHIP CAP.	0.01uF	16V	B	GRM36B103K16PT	K22128804		1-	B	e3
C 1062	CHIP CAP.	0.0047uF	25V	B	GRM36B472K25PT	K22148830		1-	B	e3
C 1063	CHIP CAP.	680pF	50V	B	GRM155B11H681KA01D	K22178807		1-	B	e4
C 1064	CHIP CAP.	470pF	50V	B	GRM155B11H471KA01D	K22178805		1-	B	e4
C 1065	CHIP CAP.	0.022uF	16V	B	GRM36B223K16PT	K22128806		1-	B	f4
C 1066	CHIP CAP.	0.0068uF	25V	B	GRM36B682K25PT	K22148803		1-	B	f4
C 1067	CHIP CAP.	330pF	50V	B	GRM155B11H331KA01D	K22178803		1-	B	e4
C 1068	CHIP CAP.	680pF	50V	B	GRM155B11H681KA01D	K22178807		1-	B	e4
C 1069	CHIP CAP.	0.0047uF	25V	B	GRM36B472K25PT	K22148830		1-	B	f4
C 1070	CHIP CAP.	0.22uF	10V	B	GRM188B11A224KA01D	K22104801		1-	B	f4
C 1071	CHIP CAP.	0.001uF	50V	B	GRM155B11H102KA01D	K22178809		1-	A	E4
C 1072	CHIP CAP.	0.001uF	50V	B	GRM155B11H102KA01D	K22178809		1-	B	b1
C 1073	CHIP CAP.	0.001uF	50V	B	GRM155B11H102KA01D	K22178809		1-	B	f3
C 1074	CHIP CAP.	0.001uF	50V	B	GRM155B11H102KA01D	K22178809		1-	A	D3
C 1075	CHIP CAP.	0.001uF	50V	B	GRM155B11H102KA01D	K22178809		1-	A	E4
C 1076	CHIP CAP.	0.0047uF	25V	B	GRM36B472K25PT	K22148830		1-	B	e4
C 1077	CHIP CAP.	5pF	50V	CH	GRM1552C1H5R0BZ01D	K22178292		1-	B	e4
C 1078	CHIP CAP.	0.1uF	10V	B	GRM36B104K10PT	K22108802		1-	B	e3
C 1079	CHIP CAP.	0.001uF	50V	B	GRM155B11H102KA01D	K22178809		1-	B	e3
C 1080	CHIP CAP.	0.001uF	50V	B	GRM155B11H102KA01D	K22178809		1-	B	e3
C 1081	CHIP CAP.	27pF	50V	CH	GRM1552C1H270JZ01D	K22178222		1-	B	e3
C 1085	CHIP CAP.	0.1uF	10V	B	GRM36B104K10PT	K22108802		1-	B	d3
C 1086	CHIP CAP.	0.0047uF	25V	B	GRM36B472K25PT	K22148830		1-	B	d3
C 1087	CHIP CAP.	0.01uF	16V	B	GRM36B103K16PT	K22128804		1-	B	b2
C 1088	CHIP CAP.	0.01uF	16V	B	GRM36B103K16PT	K22128804		1-	B	b3
C 1089	CHIP CAP.	0.01uF	16V	B	GRM36B103K16PT	K22128804		1-	A	E3
C 1090	CHIP CAP.	0.01uF	16V	B	GRM36B103K16PT	K22128804		1-	A	E3
C 1091	CHIP CAP.	0.0047uF	25V	B	GRM36B472K25PT	K22148830		1-	B	b3
C 1092	CHIP CAP.	0.0047uF	25V	B	GRM36B472K25PT	K22148830		1-	B	b2
C 1093	CHIP CAP.	0.01uF	16V	B	GRM36B103K16PT	K22128804		1-	A	E2
C 1094	CHIP TA.CAP.	47uF	4V		TEMSVB20G476M-8R	K78060020		1-	B	b3
C 1095	CHIP CAP.	0.001uF	50V	B	GRM155B11H102KA01D	K22178809		1-	A	F3
C 1096	CHIP CAP.	0.001uF	50V	B	GRM155B11H102KA01D	K22178809		1-	A	F3
C 1097	CHIP CAP.	0.001uF	50V	B	GRM155B11H102KA01D	K22178809		1-	A	F3
C 1098	CHIP CAP.	18pF	50V	CH	GRM1552C1H180JZ01D	K22178218		1-	A	F3
C 1099	CHIP CAP.	22pF	50V	CH	GRM1552C1H220JZ01D	K22178220		1-	A	F3
C 1100	CHIP CAP.	0.01uF	16V	B	GRM36B103K16PT	K22128804		1-	A	G3
C 1101	CHIP CAP.	0.01uF	16V	B	GRM36B103K16PT	K22128804		1-	A	G3
C 1102	CHIP CAP.	0.01uF	16V	B	GRM36B103K16PT	K22128804		1-	A	F3
C 1105	CHIP CAP.	0.001uF	50V	B	GRM155B11H102KA01D	K22178809		1-	B	g3
C 1106	CHIP CAP.	0.001uF	50V	B	GRM155B11H102KA01D	K22178809		1-	A	F1
C 1107	CHIP CAP.	0.1uF	10V	B	GRM36B104K10PT	K22108802		1-	A	G2
C 1109	CHIP TA.CAP.	4.7uF	6.3V		TESVSP0J475M-8R	K78080053		1-	B	e1
C 1110	CHIP CAP.	33pF	50V	CH	GRM1552C1H330JZ01D	K22178224		1-	B	e2
C 1111	CHIP CAP.	33pF	50V	CH	GRM1552C1H330JZ01D	K22178224		1-	B	e2
C 1112	CHIP CAP.	33pF	50V	CH	GRM1552C1H330JZ01D	K22178224		1-	B	e2
C 1113	CHIP CAP.	0.047uF	10V	B	GRM36B473K10PT	K22108801		1-	B	e2
C 1114	CHIP CAP.	0.001uF	50V	B	GRM155B11H102KA01D	K22178809		1-	B	e1
C 1115	CHIP CAP.	0.001uF	50V	B	GRM155B11H102KA01D	K22178809		1-	B	e1
C 1116	CHIP TA.CAP.	10uF	6.3V		TESVSP0J106M-8R	K78080055		1-	B	e1
C 1117	CHIP CAP.	0.001uF	50V	B	GRM155B11H102KA01D	K22178809		1-	B	e2
C 1118	CHIP CAP.	100pF	50V	CH	GRM1552C1H101JD01D	K22178236		1-	B	e1
C 1119	CHIP CAP.	0.1uF	10V	B	GRM36B104K10PT	K22108802		1-	A	F2
C 1120	CHIP CAP.	0.001uF	50V	B	GRM155B11H102KA01D	K22178809		1-	B	e1
C 1121	CHIP CAP.	22pF	50V	CH	GRM1552C1H220JZ01D	K22178220		1-	B	e1
C 1122	CHIP TA.CAP.	0.1uF	20V		SKF-1D104M-RP	K78130049		1-	B	e2
C 1124	CHIP TA.CAP.	4.7uF	16V		TEMSVA1C475M-8R	K78120031		1-	B	e2
C 1125	CHIP TA.CAP.	0.1uF	20V		SKF-1D104M-RP	K78130049		1-	B	e2
C 1126	CHIP TA.CAP.	0.1uF	20V		SKF-1D104M-RP	K78130049		1-	B	e2
C 1127	CHIP CAP.	0.001uF	50V	B	GRM155B11H102KA01D	K22178809		1-	A	D2
C 1128	CHIP CAP.	0.01uF	16V	B	GRM36B103K16PT	K22128804		1-	B	e1

MAIN Unit

Parts List

REF	DESCRIPTION	VALUE	V/W	TOL.	MFR'S DESIG	VXSTD P/N	VERS.	LOT	SIDE	LAY ADR
C 1129	CHIP CAP.	100pF	50V	CH	GRM1552C1H101JD01D	K22178236		1-	B	e1
C 1130	CHIP CAP.	12pF	50V	CH	GRM1552C1H120JZ01D	K22178214		1-	B	e1
C 1131	CHIP CAP.	0.001uF	50V	B	GRM155B11H102KA01D	K22178809		1-	B	f1
C 1132	CHIP CAP.	1uF	6.3V	B	GRM188B10J105KA01D	K22084801		1-	B	e3
C 1133	CHIP CAP.	0.1uF	10V	B	GRM36B104K10PT	K22108802		1-	A	E2
C 1134	CHIP CAP.	0.1uF	10V	B	GRM36B104K10PT	K22108802		1-	B	f2
C 1135	CHIP CAP.	0.1uF	10V	B	GRM36B104K10PT	K22108802		1-	B	f2
C 1136	CHIP CAP.	100pF	50V	CH	GRM1552C1H101JD01D	K22178236		1-	B	f2
C 1137	CHIP CAP.	10pF	50V	CH	GRM36CH100B50PT	K22178297		1-	B	f2
C 1138	CHIP CAP.	1pF	50V	CK	GRM1554C1H1R0BZ01D	K22178287		1-	B	f2
C 1139	CHIP CAP.	0.01uF	16V	B	GRM36B103K16PT	K22128804		1-	B	f2
C 1140	CHIP CAP.	24pF	50V	CH	GRM1552C1H240JZ01D	K22178221		1-	B	f2
C 1141	CHIP CAP.	100pF	50V	CH	GRM1552C1H101JD01D	K22178236		1-	B	f2
C 1142	CHIP CAP.	470pF	50V	B	GRM155B11H471KA01D	K22178805		1-	B	g2
C 1143	CHIP CAP.	470pF	50V	B	GRM155B11H471KA01D	K22178805		1-	B	g2
C 1144	CHIP CAP.	220pF	50V	B	GRM155B11H221KA01D	K22178801		1-	B	g1
C 1145	CHIP CAP.	220pF	50V	B	GRM155B11H221KA01D	K22178801		1-	B	g1
C 1146	CHIP CAP.	0.1uF	10V	B	GRM36B104K10PT	K22108802		1-	B	g2
C 1147	CHIP CAP.	0.001uF	50V	B	GRM155B11H102KA01D	K22178809		1-	B	g2
C 1148	CHIP CAP.	0.001uF	50V	B	GRM155B11H102KA01D	K22178809		1-	B	g3
C 1149	CHIP TA.CAP.	10uF	6.3V		TESVSP0J106M-8R	K78080055		1-	B	g2
C 1151	CHIP CAP.	0.01uF	16V	B	GRM36B103K16PT	K22128804		1-	B	g3
C 1152	CHIP CAP.	0.01uF	16V	B	GRM36B103K16PT	K22128804		1-	B	g3
C 1153	CHIP CAP.	0.1uF	10V	B	GRM36B104K10PT	K22108802		1-	B	g3
C 1154	CHIP CAP.	0.001uF	50V	B	GRM155B11H102KA01D	K22178809		1-	B	f3
C 1155	CHIP CAP.	0.1uF	10V	B	GRM36B104K10PT	K22108802		1-	B	g3
C 1156	CHIP CAP.	0.01uF	16V	B	GRM36B103K16PT	K22128804		1-	B	f3
C 1157	CHIP CAP.	0.1uF	10V	B	GRM36B104K10PT	K22108802		1-	B	f3
C 1158	CHIP CAP.	56pF	50V	CH	GRM1552C1H560JD01D	K22178230		1-	B	g1
C 1159	CHIP CAP.	56pF	50V	CH	GRM1552C1H560JD01D	K22178230		1-	B	g1
C 1160	CHIP CAP.	0.01uF	16V	B	GRM36B103K16PT	K22128804		1-	B	f1
C 1161	CHIP TA.CAP.	10uF	6.3V		TESVSP0J106M-8R	K78080055		1-	B	g1
C 1161	CHIP TA.CAP.	22uF	6.3V		TEESVP0J226M-8R	K78080082		4-	B	g1
C 1161	CHIP CAP.	10uF	6.3V	B	JMK212BJ106KG-T	K22080802		10-	B	g1
C 1162	CHIP CAP.	0.047uF	10V	B	GRM36B473K10PT	K22108801		1-	B	g1
C 1163	CHIP CAP.	0.1uF	10V	B	GRM36B104K10PT	K22108802		1-	B	g1
C 1164	CHIP CAP.	7pF	50V	CH	GRM1552C1H7R0BZ01D	K22178294		1-	B	f1
C 1165	CHIP CAP.	0.001uF	50V	B	GRM155B11H102KA01D	K22178809		1-	B	f1
C 1166	CHIP CAP.	20pF	50V	CH	GRM1552C1H200JZ01D	K22178219		1-	B	f1
C 1167	CHIP CAP.	0.01uF	16V	B	GRM36B103K16PT	K22128804		1-	B	g1
C 1168	CHIP CAP.	0.01uF	16V	B	GRM36B103K16PT	K22128804		1-	B	f1
C 1169	CHIP CAP.	9pF	50V	CH	GRM1552C1H9R0BZ01D	K22178296		1-	B	e1
C 1170	CHIP CAP.	0.001uF	50V	B	GRM155B11H102KA01D	K22178809		1-	B	e1
C 1171	CHIP CAP.	0.022uF	16V	B	GRM36B223K16PT	K22128806		1-	B	f1
C 1172	CHIP CAP.	0.001uF	50V	B	GRM155B11H102KA01D	K22178809		1-	A	D2
C 1173	CHIP TA.CAP.	10uF	6.3V		TESVSP0J106M-8R	K78080055		1-	B	d3
C 1174	CHIP CAP.	0.001uF	50V	B	GRM155B11H102KA01D	K22178809		1-	B	d3
C 1175	CHIP CAP.	0.001uF	50V	B	GRM155B11H102KA01D	K22178809		1-	A	D2
C 1176	CHIP CAP.	0.01uF	16V	B	GRM36B103K16PT	K22128804		1-	B	f1
C 1177	CHIP TA.CAP.	10uF	6.3V		TESVSP0J106M-8R	K78080055		1-	B	d3
C 1178	CHIP CAP.	0.001uF	50V	B	GRM155B11H102KA01D	K22178809		1-	B	d2
C 1179	CHIP CAP.	0.001uF	50V	B	GRM155B11H102KA01D	K22178809		1-	B	d2
C 1180	CHIP CAP.	22pF	50V	CH	GRM1552C1H220JZ01D	K22178220		1-	B	d2
C 1181	CHIP CAP.	0.001uF	50V	B	GRM155B11H102KA01D	K22178809		1-	B	d2
C 1182	CHIP CAP.	18pF	50V	CH	GRM1552C1H180JZ01D	K22178218		1-	B	d2
C 1183	CHIP CAP.	10pF	50V	CH	GRM36CH100B50PT	K22178297		1-	B	d2
C 1184	CHIP CAP.	0.001uF	50V	B	GRM155B11H102KA01D	K22178809		1-	B	d2
C 1185	CHIP CAP.	1pF	50V	CK	GRM1554C1H1R0BZ01D	K22178287		1-	B	d2
C 1186	CHIP CAP.	0.001uF	50V	B	GRM155B11H102KA01D	K22178809		1-	B	d2
C 1187	CHIP CAP.	5pF	50V	CH	GRM1552C1H5R0BZ01D	K22178292		1-	B	e1
C 1189	CHIP CAP.	0.001uF	50V	B	GRM155B11H102KA01D	K22178809		1-	A	C2
C 1190	CHIP CAP.	0.001uF	50V	B	GRM155B11H102KA01D	K22178809		1-	B	d2
C 1191	CHIP CAP.	0.001uF	50V	B	GRM155B11H102KA01D	K22178809		1-	B	d2
C 1192	CHIP CAP.	0.001uF	50V	B	GRM155B11H102KA01D	K22178809		1-	B	d2
C 1193	CHIP CAP.	0.001uF	50V	B	GRM155B11H102KA01D	K22178809		1-	B	d2
C 1194	CHIP CAP.	27pF	50V	CH	GRM1552C1H270JZ01D	K22178222		1-	B	d2
C 1195	CHIP CAP.	0.001uF	50V	B	GRM155B11H102KA01D	K22178809		1-	B	d2
C 1196	CHIP CAP.	18pF	50V	CH	GRM1552C1H180JZ01D	K22178218		1-	B	d2
C 1197	CHIP CAP.	18pF	50V	CH	GRM1552C1H180JZ01D	K22178218		1-	B	d2
C 1198	CHIP CAP.	0.001uF	50V	B	GRM155B11H102KA01D	K22178809		1-	B	d2
C 1199	CHIP CAP.	1.5pF	50V	CK	GRM1554C1H1R5BZ01D	K22178288		1-	B	d2
C 1200	CHIP CAP.	0.001uF	50V	B	GRM155B11H102KA01D	K22178809		1-	B	d2
C 1201	CHIP CAP.	10pF	50V	CH	GRM36CH100B50PT	K22178297		1-	B	d1

MAIN Unit

Parts List

REF	DESCRIPTION	VALUE	V/W	TOL.	MFR'S DESIG	VXSTD P/N	VERS.	LOT	SIDE	LAY ADR
C 1202	CHIP CAP.	10pF	50V	CH	GRM36CH100B50PT	K22178297		1-	B	d1
C 1203	CHIP CAP.	0.001uF	50V	B	GRM155B11H102KA01D	K22178809		1-	B	d1
C 1204	CHIP CAP.	0.001uF	50V	B	GRM155B11H102KA01D	K22178809		1-	B	d1
C 1206	CHIP CAP.	0.001uF	50V	B	GRM155B11H102KA01D	K22178809		1-	B	c1
C 1207	CHIP CAP.	0.001uF	50V	B	GRM155B11H102KA01D	K22178809		1-	B	c1
C 1208	CHIP CAP.	100pF	50V	CH	GRM1552C1H101JD01D	K22178236		1-	B	c1
C 1209	CHIP CAP.	18pF	50V	CH	GRM1552C1H180JZ01D	K22178218		1-	B	c1
C 1210	CHIP CAP.	0.001uF	50V	B	GRM155B11H102KA01D	K22178809		1-	B	c1
C 1211	CHIP CAP.	0.001uF	50V	B	GRM155B11H102KA01D	K22178809		1-	B	a4
C 1212	CHIP CAP.	0.01uF	16V	B	GRM36B103K16PT	K22128804		1-	A	D2
C 1213	CHIP CAP.	0.47uF	16V	F	ECJ1VF1C474Z	K22125001		1-	A	E2
C 1214	CHIP CAP.	0.001uF	50V	B	GRM155B11H102KA01D	K22178809		1-	B	c1
C 1215	CHIP CAP.	0.001uF	50V	B	GRM155B11H102KA01D	K22178809		1-	A	D1
C 1216	CHIP CAP.	18pF	50V	CH	GRM1552C1H180JZ01D	K22178218		1-	A	E1
C 1217	CHIP CAP.	27pF	50V	CH	GRM1552C1H270JZ01D	K22178222		1-	A	D1
C 1218	CHIP CAP.	47pF	50V	CH	GRM1552C1H470JZ01D	K22178228		1-	A	E1
C 1219	CHIP CAP.	33pF	50V	CH	GRM1552C1H330JZ01D	K22178224		1-	A	D1
C 1220	CHIP CAP.	68pF	50V	CH	GRM1552C1H680JZ01D	K22178232		1-	A	E1
C 1221	CHIP CAP.	33pF	50V	CH	GRM1552C1H330JZ01D	K22178224		1-	A	E1
C 1222	CHIP CAP.	0.001uF	50V	B	GRM155B11H102KA01D	K22178809		1-	A	D1
C 1223	CHIP CAP.	0.47uF	25V	B	GRM40B474K25PT	K22140824		1-	A	E2
C 1224	CHIP CAP.	0.001uF	50V	B	GRM155B11H102KA01D	K22178809		1-	A	E2
C 1225	CHIP CAP.	0.001uF	50V	B	GRM155B11H102KA01D	K22178809		1-	A	E2
C 1226	CHIP CAP.	15pF	50V	CH	GRM1552C1H150JZ01D	K22178216		1-	A	E1
C 1227	CHIP CAP.	15pF	50V	CH	GRM1552C1H150JZ01D	K22178216		1-	A	E1
C 1228	CHIP CAP.	10pF	50V	CH	GRM36CH100B50PT	K22178297		1-	A	E1
C 1229	CHIP CAP.	9pF	50V	CH	GRM1552C1H9R0BZ01D	K22178296		1-	A	E1
C 1230	CHIP CAP.	8pF	50V	CH	GRM1552C1H8R0BZ01D	K22178295		1-	B	b1
C 1231	CHIP CAP.	33pF	50V	CH	GRM1552C1H330JZ01D	K22178224		1-	A	E1
C 1232	CHIP CAP.	3pF	50V	CJ	GRM1553C1H3R0BZ01D	K22178290		1-	A	E1
C 1233	CHIP CAP.	0.001uF	50V	B	GRM155B11H102KA01D	K22178809		1-	A	F1
C 1234	CHIP CAP.	0.001uF	50V	B	GRM155B11H102KA01D	K22178809		1-	A	F1
C 1235	CHIP CAP.	4pF	50V	CH	GRM1552C1H4R0BZ01D	K22178291		1-	A	F1
C 1236	CHIP CAP.	0.5pF	50V	CK	GRM1554C1HR50BZ01D	K22178285		1-	A	F1
C 1237	CHIP CAP.	0.001uF	50V	B	GRM155B11H102KA01D	K22178809		1-	A	F1
C 1238	CHIP CAP.	47pF	50V	CH	GRM1552C1H470JZ01D	K22178228		1-	B	b1
C 1239	CHIP CAP.	3pF	50V	CJ	GRM1553C1H3R0BZ01D	K22178290		1-	B	b1
C 1240	CHIP CAP.	7pF	50V	CH	GRM1552C1H7R0BZ01D	K22178294		1-	B	b1
C 1241	CHIP CAP.	0.001uF	50V	B	GRM155B11H102KA01D	K22178809		1-	A	F1
C 1242	CHIP CAP.	150pF	50V	CH	GRM1552C1H151JA01D	K22178240		1-	B	b1
C 1243	CHIP CAP.	0.5pF	50V	CK	GRM1554C1HR50BZ01D	K22178285		1-	B	b1
C 1244	CHIP CAP.	6pF	50V	CH	GRM1552C1H6R0BZ01D	K22178293		1-	B	b1
C 1245	CHIP CAP.	4pF	50V	CH	GRM1552C1H4R0BZ01D	K22178291		1-	B	b1
C 1246	CHIP CAP.	9pF	50V	CH	GRM1552C1H9R0DZ01D	K22178211		1-	B	a1
C 1247	CHIP CAP.	9pF	50V	CH	GRM1552C1H9R0DZ01D	K22178211		1-	B	a1
C 1248	CHIP CAP.	3pF	50V	CJ	GRM1553C1H3R0BZ01D	K22178290		1-	B	a1
C 1249	CHIP CAP.	0.001uF	50V	B	GRM155B11H102KA01D	K22178809		1-	A	G1
C 1250	CHIP CAP.	3pF	50V	CJ	GRM1553C1H3R0BZ01D	K22178290		1-	A	G1
C 1251	CHIP CAP.	0.5pF	50V	CK	GRM1554C1HR50BZ01D	K22178285		1-	A	G1
C 1252	CHIP CAP.	27pF	50V	CH	GRM1552C1H270JZ01D	K22178222		1-	B	b1
C 1253	CHIP CAP.	100pF	50V	CH	GRM1552C1H101JD01D	K22178236		1-	B	b1
C 1254	CHIP CAP.	27pF	50V	CH	GRM1552C1H270JZ01D	K22178222		1-	B	b1
C 1255	CHIP CAP.	30pF	50V	CH	GRM1552C1H300JZ01D	K22178223		1-	B	b1
C 1256	CHIP CAP.	22pF	50V	CH	GRM1552C1H220JZ01D	K22178220		1-	B	b1
C 1257	CHIP CAP.	0.001uF	50V	B	GRM155B11H102KA01D	K22178809		1-	A	F1
C 1258	CHIP CAP.	0.001uF	50V	B	GRM155B11H102KA01D	K22178809		1-	B	b1
C 1259	CHIP CAP.	24pF	50V	CH	GRM1552C1H240JZ01D	K22178221		1-	B	b2
C 1260	CHIP CAP.	33pF	50V	CH	GRM1552C1H330JZ01D	K22178224		1-	B	b2
C 1261	CHIP CAP.	10pF	50V	CH	GRM36CH100B50PT	K22178297		1-	B	b1
C 1262	CHIP CAP.	22pF	50V	CH	GRM1552C1H220JZ01D	K22178220		1-	B	a2
C 1263	CHIP CAP.	330pF	50V	CH	GRM1882C1H331JA01D	K22174253		1-	B	a2
C 1264	CHIP CAP.	5pF	50V	CH	GRM1552C1H5R0BZ01D	K22178292		1-	B	b2
C 1266	CHIP CAP.	22pF	50V	CH	GRM1552C1H220JZ01D	K22178220		1-	B	a1
C 1270	CHIP CAP.	0.5pF	50V	CK	GRM1554C1HR50BZ01D	K22178285		1-	A	F2
C 1271	CHIP CAP.	3pF	50V	CJ	GRM1553C1H3R0BZ01D	K22178290		1-	A	F2
C 1272	CHIP CAP.	0.001uF	50V	B	GRM155B11H102KA01D	K22178809		1-	A	F1
C 1273	CHIP CAP.	0.001uF	50V	B	GRM155B11H102KA01D	K22178809		1-	A	C1
C 1274	CHIP CAP.	3pF	50V	CJ	GRM1553C1H3R0BZ01D	K22178290		1-	A	C1
C 1275	CHIP CAP.	5pF	50V	CH	GRM1552C1H5R0BZ01D	K22178292		1-	A	C1
C 1276	CHIP CAP.	0.001uF	50V	B	GRM155B11H102KA01D	K22178809		1-	A	C1
C 1277	CHIP CAP.	9pF	50V	CH	GRM1552C1H9R0BZ01D	K22178296		1-	A	C2
C 1278	CHIP CAP.	2pF	50V	CK	GRM1554C1H2R0BZ01D	K22178289		1-	A	C1
C 1279	CHIP CAP.	10pF	50V	CH	GRM36CH100B50PT	K22178297		1-	A	C2

MAIN Unit

Parts List

REF	DESCRIPTION	VALUE	V/W	TOL.	MFR'S DESIG	VXSTD P/N	VERS.	LOT	SIDE	LAY ADR
C 1280	CHIP CAP.	2pF	50V	CK	GRM1554C1H2R0BZ01D	K22178289		1-	A	C2
C 1281	CHIP CAP.	3pF	50V	CJ	GRM1553C1H3R0BZ01D	K22178290		1-	A	D2
C 1282	CHIP CAP.	0.001uF	50V	B	GRM155B11H102KA01D	K22178809		1-	A	D2
C 1283	CHIP CAP.	8pF	50V	CH	GRM1552C1H8R0BZ01D	K22178295		1-	A	D2
C 1284	CHIP CAP.	1.5pF	50V	CK	GRM1554C1H1R5BZ01D	K22178288		1-	A	D2
C 1286	CHIP CAP.	0.001uF	50V	B	GRM155B11H102KA01D	K22178809		1-	A	E2
C 1287	CHIP CAP.	8pF	50V	CH	GRM1552C1H8R0BZ01D	K22178295		1-	A	F2
C 1288	CHIP CAP.	3pF	50V	CJ	GRM1553C1H3R0BZ01D	K22178290		1-	A	F2
C 1289	CHIP CAP.	4pF	50V	CH	GRM1552C1H4R0BZ01D	K22178291		1-	A	F2
C 1290	CHIP CAP.	4pF	50V	CH	GRM1552C1H4R0BZ01D	K22178291		1-	A	F2
C 1291	CHIP CAP.	2pF	50V	CK	GRM1554C1H2R0BZ01D	K22178289		1-	A	F2
C 1292	CHIP CAP.	1pF	50V	CK	GRM1554C1H1R0BZ01D	K22178287		1-	A	F2
C 1293	CHIP CAP.	1.5pF	50V	CK	GRM1554C1H1R5BZ01D	K22178288		1-	A	F1
C 1294	CHIP CAP.	0.001uF	50V	B	GRM155B11H102KA01D	K22178809		1-	B	e1
C 1295	CHIP CAP.	0.001uF	50V	B	GRM155B11H102KA01D	K22178809		1-	B	e1
C 1296	CHIP CAP.	8pF	50V	CH	GRM1552C1H8R0BZ01D	K22178295		1-	B	e1
C 1297	CHIP CAP.	1pF	50V	CK	GRM1554C1H1R0BZ01D	K22178287		1-	B	e1
C 1298	CHIP CAP.	27pF	50V	CH	GRM1552C1H270JZ01D	K22178222		1-	B	e1
C 1299	CHIP CAP.	0.75pF	50V	CK	GRM1554C1HR75BZ01D	K22178286		1-	B	e1
C 1300	CHIP CAP.	0.75pF	50V	CK	GRM1554C1HR75BZ01D	K22178286		1-	B	d1
C 1301	CHIP CAP.	4pF	50V	CH	GRM1552C1H4R0BZ01D	K22178291		1-	B	e1
C 1302	CHIP CAP.	0.001uF	50V	B	GRM155B11H102KA01D	K22178809		1-3	A	C1
C 1302	CHIP CAP.	0.001uF	50V	B	GRM155B11H102KA01D	K22178809	W/ CE	4-	A	C1
C 1302	CHIP CAP.	0.001uF	50V	B	GRM155B11H102KA01D	K22178809	W/O CE	4-	A	C1
C 1303	CHIP CAP.	0.01uF	16V	B	GRM36B103K16PT	K22128804		1-	A	E2
C 1304	CHIP CAP.	0.001uF	50V	B	GRM155B11H102KA01D	K22178809		1-	B	d1
C 1305	CHIP CAP.	27pF	50V	CH	GRM1552C1H270JZ01D	K22178222		1-	B	d1
C 1306	CHIP CAP.	1pF	50V	CK	GRM1554C1H1R0BZ01D	K22178287		1-	B	d1
C 1307	CHIP CAP.	0.75pF	50V	CK	GRM1554C1HR75BZ01D	K22178286		1-	B	d1
C 1308	CHIP CAP.	1pF	50V	CK	GRM1554C1H1R0BZ01D	K22178287		1-	B	d1
C 1309	CHIP CAP.	27pF	50V	CH	GRM1552C1H270JZ01D	K22178222		1-	B	d1
C 1310	CHIP CAP.	0.5pF	50V	CK	GRM1554C1HR50BZ01D	K22178285		1-9	A	D1
C 1311	CHIP CAP.	100pF	50V	CH	GRM1552C1H101JD01D	K22178236		1-	B	d1
C 1312	CHIP CAP.	0.001uF	50V	B	GRM155B11H102KA01D	K22178809		1-	A	D1
C 1313	CHIP CAP.	1pF	50V	CK	GRM1554C1H1R0BZ01D	K22178287		1-	A	C1
C 1314	CHIP CAP.	22pF	50V	CH	GRM1552C1H220JZ01D	K22178220		1-	A	C1
C 1314	CHIP CAP.	15pF	50V	CH	GRM1552C1H150JZ01D	K22178216		10-	A	C1
C 1315	CHIP CAP.	6pF	50V	CH	GRM1552C1H6R0BZ01D	K22178293		1-9	A	C1
C 1316	CHIP CAP.	1.5pF	50V	CK	GRM1554C1H1R5BZ01D	K22178288		1-	A	C1
C 1316	CHIP CAP.	1pF	50V	CK	GRM1554C1H1R0BZ01D	K22178287		10-	A	C1
C 1317	CHIP CAP.	6pF	50V	CH	GRM1552C1H6R0BZ01D	K22178293		1-	A	C1
C 1317	CHIP CAP.	5pF	50V	CH	GRM1552C1H5R0BZ01D	K22178292		10-	A	C1
C 1318	CHIP CAP.	0.001uF	50V	B	GRM155B11H102KA01D	K22178809		10-	A	C1
C 1318	CHIP CAP.	10pF	50V	CH	GRM36CH100B50PT	K22178297		1-	A	C1
C 1319	CHIP CAP.	0.001uF	50V	B	GRM155B11H102KA01D	K22178809		1-	A	E1
C 1320	CHIP CAP.	0.5pF	50V	CK	GRM1554C1HR50BZ01D	K22178285		1-	A	D1
C 1321	CHIP CAP.	0.001uF	50V	B	GRM155B11H102KA01D	K22178809		1-	A	D1
C 1322	CHIP CAP.	0.001uF	50V	B	GRM155B11H102KA01D	K22178809		1-	B	c2
C 1323	CHIP CAP.	0.001uF	50V	B	GRM155B11H102KA01D	K22178809		1-	B	c1
C 1324	CHIP CAP.	0.001uF	50V	B	GRM155B11H102KA01D	K22178809		1-	A	E1
C 1325	CHIP CAP.	2pF	50V	CK	GRM1554C1H2R0BZ01D	K22178289		1-	A	E1
C 1326	CHIP CAP.	12pF	50V	CH	GRM1552C1H120JZ01D	K22178214		1-	A	E1
C 1327	CHIP CAP.	3pF	50V	CJ	GRM1553C1H3R0BZ01D	K22178290		1-	B	c1
C 1328	CHIP CAP.	2pF	50V	CK	GRM1554C1H2R0BZ01D	K22178289		1-	A	E1
C 1329	CHIP CAP.	0.001uF	50V	B	GRM155B11H102KA01D	K22178809		1-	A	D1
C 1330	CHIP CAP.	0.001uF	50V	B	GRM155B11H102KA01D	K22178809		1-	A	C1
C 1331	CHIP CAP.	0.001uF	50V	B	GRM155B11H102KA01D	K22178809		1-	B	e2
C 1332	CHIP CAP.	0.001uF	50V	B	GRM155B11H102KA01D	K22178809		1-	A	D2
C 1333	CHIP CAP.	0.01uF	25V	B	GRM39B103M25PT	K22144802		1-	A	C2
C 1334	CHIP CAP.	0.001uF	50V	B	GRM155B11H102KA01D	K22178809		1-	A	C2
C 1335	CHIP CAP.	7pF	50V	CH	GRM1552C1H7R0BZ01D	K22178294		1-	A	C2
C 1336	CHIP CAP.	0.001uF	50V	B	GRM155B11H102KA01D	K22178809		1-	A	C2
C 1337	CHIP CAP.	8pF	50V	CH	GRM1552C1H8R0BZ01D	K22178295		1-	A	C2
C 1339	CHIP CAP.	47pF	50V	CH	GRM1552C1H470JZ01D	K22178228		1-	A	C2
C 1340	CHIP CAP.	0.5pF	50V	CK	GRM1554C1HR50BZ01D	K22178285		1-	A	C2
C 1341	CHIP CAP.	4pF	50V	CH	GRM1552C1H4R0BZ01D	K22178291		1-	A	C2
C 1342	CHIP CAP.	47pF	50V	CH	GRM1552C1H470JZ01D	K22178228		1-	A	C2
C 1343	CHIP CAP.	0.75pF	50V	CK	GRM1554C1HR75BZ01D	K22178286		1-	A	D2
C 1344	CHIP CAP.	0.5pF	50V	CK	GRM1554C1HR50BZ01D	K22178285		1-	A	D2
C 1345	CHIP CAP.	10pF	50V	CH	GRM36CH100B50PT	K22178297		1-	A	D2
C 1346	CHIP CAP.	0.5pF	50V	CK	GRM1554C1HR50BZ01D	K22178285		1-	A	D2
C 1347	CHIP CAP.	47pF	50V	CH	GRM1552C1H470JZ01D	K22178228		1-	A	D2
C 1349	CHIP CAP.	8pF	50V	CH	GRM1552C1H8R0BZ01D	K22178295		1-	A	D2

MAIN Unit

Parts List

REF	DESCRIPTION	VALUE	V/W	TOL.	MFR'S DESIG	VXSTD P/N	VERS.	LOT	SIDE	LAY ADR
C 1350	CHIP CAP.	0.001uF	50V	B	GRM155B11H102KA01D	K22178809		1-	B	c2
C 1351	CHIP CAP.	0.001uF	50V	B	GRM155B11H102KA01D	K22178809		1-	B	c1
C 1352	CHIP CAP.	0.001uF	50V	B	GRM155B11H102KA01D	K22178809		1-	A	C2
C 1353	CHIP CAP.	1pF	50V	CK	GRM1554C1H1R0BZ01D	K22178287		1-	A	C2
C 1354	CHIP CAP.	22pF	50V	CH	GRM1552C1H220JZ01D	K22178220		1-	A	C2
C 1355	CHIP CAP.	7pF	50V	CH	GRM1552C1H7R0BZ01D	K22178294		1-	A	C2
C 1356	CHIP CAP.	2pF	50V	CK	GRM1554C1H2R0BZ01D	K22178289		1-	A	C2
C 1357	CHIP CAP.	7pF	50V	CH	GRM1552C1H7R0BZ01D	K22178294		1-	A	D2
C 1358	CHIP CAP.	47pF	50V	CH	GRM1552C1H470JZ01D	K22178228		1-	A	D2
C 1359	CHIP CAP.	0.001uF	50V	B	GRM155B11H102KA01D	K22178809		1-	A	D2
C 1360	CHIP CAP.	0.001uF	50V	B	GRM155B11H102KA01D	K22178809		1-	B	c2
C 1361	CHIP CAP.	0.001uF	50V	B	GRM155B11H102KA01D	K22178809		1-	B	c1
C 1362	CHIP CAP.	2pF	50V	CK	GRM1554C1H2R0BZ01D	K22178289		1-	B	c1
C 1363	CHIP CAP.	7pF	50V	CH	GRM1552C1H7R0BZ01D	K22178294		1-	B	c1
C 1364	CHIP CAP.	0.001uF	50V	B	GRM155B11H102KA01D	K22178809		1-	B	c2
C 1366	CHIP CAP.	15pF	50V	CH	GRM1552C1H150JZ01D	K22178216		1-	B	c2
C 1367	CHIP CAP.	7pF	50V	CH	GRM1552C1H7R0BZ01D	K22178294		1-	B	c2
C 1368	CHIP CAP.	12pF	50V	CH	GRM1552C1H120JZ01D	K22178214		1-	B	c2
C 1369	CHIP CAP.	0.001uF	50V	B	GRM155B11H102KA01D	K22178809		1-	B	b2
C 1370	CHIP CAP.	10pF	50V	CH	GRM36CH100B50PT	K22178297		1-	B	b2
C 1371	CHIP CAP.	22pF	50V	CH	GRM1552C1H220JZ01D	K22178220		1-	B	c2
C 1372	CHIP CAP.	8pF	50V	CH	GRM1552C1H8R0BZ01D	K22178295		1-	B	c2
C 1374	CHIP CAP.	47pF	50V	CH	GRM1552C1H470JZ01D	K22178228		1-	B	c2
C 1375	CHIP CAP.	1pF	50V	CK	GRM1554C1H1R0BZ01D	K22178287		1-	B	a1
C 1376	CHIP CAP.	1.5pF	50V	CK	GRM1554C1H1R5BZ01D	K22178288		1-	B	c2
C 1377	CHIP CAP.	0.001uF	50V	B	GRM155B11H102KA01D	K22178809		1-	B	c2
C 1378	CHIP CAP.	0.001uF	50V	B	GRM155B11H102KA01D	K22178809		1-	A	D1
C 1379	CHIP TA.CAP.	4.7uF	6.3V		TESVSP0J475M-8R	K78080053		1-	B	a2
C 1380	CHIP CAP.	0.047uF	10V	B	GRM36B473K10PT	K22108801		1-	B	a2
C 1381	CHIP CAP.	0.001uF	50V	B	GRM155B11H102KA01D	K22178809		1-	B	a3
C 1382	CHIP CAP.	0.001uF	50V	B	GRM155B11H102KA01D	K22178809		1-	B	a2
C 1383	CHIP CAP.	0.022uF	16V	B	GRM36B223K16PT	K22128806		1-	B	a2
C 1384	CHIP CAP.	0.001uF	50V	B	GRM155B11H102KA01D	K22178809		1-	B	a3
C 1385	CHIP CAP.	0.01uF	16V	B	GRM36B103K16PT	K22128804		1-	A	E3
C 1386	CHIP CAP.	0.01uF	16V	B	GRM36B103K16PT	K22128804		1-	A	E2
C 1387	CHIP CAP.	0.01uF	16V	B	GRM36B103K16PT	K22128804		1-	A	E2
C 1388	CHIP CAP.	1pF	50V	CK	GRM1554C1H1R0BZ01D	K22178287		1-	B	d1
C 1390	CHIP CAP.	0.1uF	10V	B	GRM36B104K10PT	K22108802		1-	B	d4
C 1391	CHIP CAP.	0.022uF	16V	B	GRM36B223K16PT	K22128806		1-	B	g2
C 1392	CHIP CAP.	0.022uF	16V	B	GRM36B223K16PT	K22128806		1-	B	d4
C 1393	CHIP CAP.	470pF	50V	B	GRM155B11H471KA01D	K22178805		1-	B	d4
C 1394	CHIP CAP.	1.5pF	50V	CK	GRM1554C1H1R5BZ01D	K22178288		1-	B	b1
C 1395	CHIP CAP.	0.001uF	50V	B	GRM155B11H102KA01D	K22178809		1-	B	b2
C 1397	CHIP CAP.	0.001uF	50V	B	GRM155B11H102KA01D	K22178809		1-	A	C2
C 1398	CHIP CAP.	100pF	50V	CH	GRM1552C1H101JD01D	K22178236		1-	A	G2
C 1398	CERAMIC CAP.	100pF	50V	B	UP050B101K-A-B	K28179004		3-	A	G2
C 1398	CHIP CAP.	100pF	50V	CH	GRM1552C1H101JD01D	K22178236		6-	A	G2
C 1400	CHIP CAP.	0.001uF	50V	B	GRM155B11H102KA01D	K22178809		1-	B	a3
C 1403	CHIP CAP.	0.001uF	50V	B	GRM155B11H102KA01D	K22178809		1-	A	D2
C 1404	CHIP CAP.	0.001uF	50V	B	GRM155B11H102KA01D	K22178809		1-	A	F4
C 1407	CHIP CAP.	0.001uF	50V	B	GRM155B11H102KA01D	K22178809		1-	A	D1
C 1409	CHIP CAP.	2pF	50V	CK	GRM1554C1H2R0BZ01D	K22178289		1-	B	b3
C 1411	CHIP CAP.	1.5pF	50V	CK	GRM1554C1H1R5BZ01D	K22178288		1-	A	G1
C 1412	CHIP CAP.	8pF	50V	CH	GRM1882C1H8R0DZ01D	K22174209		1-	A	E1
C 1412	CHIP CAP.	8pF	50V	CH	GRM1552C1H8R0BZ01D	K22178295		3-	A	E1
C 1413	CHIP CAP.	7pF	50V	CH	GRM1552C1H7R0BZ01D	K22178294		1-	B	b2
C 1414	CHIP CAP.	47pF	50V	CH	GRM1882C1H470JA01D	K22174227		1-	B	a4
C 1414	CHIP CAP.	47pF	50V	CH	GRM1552C1H470JZ01D	K22178228		6-	B	a4
C 1415	CHIP TA.CAP.	10uF	6.3V		TESVSP0J106M-8R	K78080055		2-3	A	C1
C 1415	CHIP CAP.	2pF	50V	CK	GRM1554C1H2R0BZ01D	K22178289		10-	A	C1
C 1416	CHIP CAP.	0.0047uF	25V	B	GRM36B472K25PT	K22148830		4-	B	f2
C 1417	CHIP CAP.	150pF	50V	CH	GRM1552C1H151JA01D	K22178240		4-	B	f3
C 1418	CERAMIC CAP.	0.001uF	50V	B	UP050B102K-A-B	K28179001	W/ CE	4-		
C 1419	CHIP CAP.	0.22uF	10V	B	GRM188B11A224KA01D	K22104801		5-9		
CD1001	CERAMIC DISC				JTBC450C7	H7901500		1-	B	g1
CF1001	CERAMIC FILTER				LTWC450F	H3900563		1-	B	g2
D 1001	DIODE				DA221 TL	G2070178		1-	A	E3
D 1002	DIODE				1SS400 TE61	G2070634		1-	B	c3
D 1003	DIODE				UDZS TE-17 9.1B	G2070868		1-	A	D3
D 1004	DIODE				1SS400 TE61	G2070634		1-	A	D3
D 1005	DIODE				1SS400 TE61	G2070634		1-	A	E3
D 1006	DIODE				UDZS TE-17 5.1B	G2070908		1-	A	D1
D 1006	DIODE				EDZ TE-61 5.1B	G2070998		10-	A	D1

MAIN Unit

Parts List

REF	DESCRIPTION	VALUE	V/W	TOL.	MFR'S DESIG	VXSTD P/N	VERS.	LOT	SIDE	LAY ADR
D 1007	DIODE				DAN222 TL	G2070174		1-	B	f2
D 1008	DIODE				DA221 TL	G2070178		1-	B	f4
D 1009	DIODE				M1FM3-4063	G2070804		1-	A	E4
D 1010	DIODE				1SS400 TE61	G2070634		1-	A	D4
D 1011	DIODE				RB551V-30 TE-17	G2070892		1-	B	g4
D 1012	DIODE				HZU2.0BTRF	G2070844		1-	B	g3
D 1013	DIODE				HN2D01FUTE85R	G2070348		1-	A	C4
D 1014	LED				12-215UYOC/S530-A3/TR8	G2071012		1-	A	F4
D 1015	LED				12-215UYOC/S530-A3/TR8	G2071012		1-	A	F1
D 1016	LED				AA1111C-TR	G2070660		1-	A	A2
D 1017	LED				AA1111C-TR	G2070660		1-	A	B2
D 1018	LED				AA1111C-TR	G2070660		1-	A	A3
D 1019	LED				AA1111C-TR	G2070660		1-	A	B3
D 1020	DIODE				DA221 TL	G2070178		1-	B	e2
D 1021	DIODE				1SS400 TE61	G2070634		1-	B	e1
D 1022	DIODE				HVC350B-TRF	G2070596		1-	B	e1
D 1023	DIODE				HVC365 TRF	G2070902		1-	B	f2
D 1024	DIODE				RB751S-40TE61	G2070850		1-	B	g3
D 1025	DIODE				1SS400 TE61	G2070634		1-	B	f1
D 1026	DIODE				1SS400 TE61	G2070634		1-	B	d3
D 1027	DIODE				DAP222-TL	G2070432		1-	A	C3
D 1028	DIODE				DAN222 TL	G2070174		1-	A	C3
D 1029	DIODE				HN2D01FUTE85R	G2070348		1-	A	C3
D 1030	DIODE				HVC375B-TRF	G2070856		1-	B	d2
D 1031	DIODE				HVC350B-TRF	G2070596		1-	B	d2
D 1032	DIODE				HSC277TRF	G2070584		1-	B	d2
D 1033	DIODE				1SS400 TE61	G2070634		1-	B	e1
D 1034	DIODE				HSC277TRF	G2070584		1-	B	d2
D 1035	DIODE				HSC277TRF	G2070584		1-	B	d2
D 1036	DIODE				HVC365 TRF	G2070902		1-	B	d2
D 1037	DIODE				HVC365 TRF	G2070902		1-	B	d2
D 1038	DIODE				1SS400 TE61	G2070634		1-	B	d1
D 1039	DIODE				1SS400 TE61	G2070634		1-	B	d1
D 1040	DIODE				HVC131TRF	G2070676		1-	B	d1
D 1041	DIODE				HVC131TRF	G2070676		1-	B	d1
D 1042	DIODE				DAN222 TL	G2070174		1-	B	d1
D 1043	DIODE				DAN222 TL	G2070174		1-	B	c1
D 1044	DIODE				RLS135 TE-11	G2070128		1-	A	E1
D 1045	DIODE				1SV271 TPH3	G2070476		1-	B	b1
D 1046	DIODE				RB751S-40TE61	G2070850		1-	A	F1
D 1047	DIODE				RB751S-40TE61	G2070850		1-	A	G1
D 1048	DIODE				1SV271 TPH3	G2070476		1-	B	b1
D 1050	DIODE				RLS135 TE-11	G2070128		1-	B	b2
D 1051	DIODE				RB751S-40TE61	G2070850		1-	A	F2
D 1052	DIODE				1SS400 TE61	G2070634		1-	A	C1
D 1053	DIODE				HVC131TRF	G2070676		1-	A	C1
D 1054	DIODE				HVC350B-TRF	G2070596		1-	B	e1
D 1055	DIODE				HVC350B-TRF	G2070596		1-	B	d1
D 1056	DIODE				HVC350B-TRF	G2070596		1-	B	d1
D 1057	DIODE				HVC131TRF	G2070676		1-	A	C1
D 1058	DIODE				1SS400 TE61	G2070634		1-	B	d1
D 1059	DIODE				1SS400 TE61	G2070634		1-	A	D1
D 1059	DIODE				HVC131TRF	G2070676		10-	A	D1
D 1060	DIODE				HSC277TRF	G2070584		1-	A	E1
D 1061	DIODE				1SS400 TE61	G2070634		1-	A	C2
D 1062	DIODE				1SS400 TE61	G2070634		1-	A	C2
D 1063	DIODE				HVC365 TRF	G2070902		1-	A	C2
D 1064	DIODE				HVC365 TRF	G2070902		1-	A	C2
D 1065	DIODE				HVC365 TRF	G2070902		1-	A	D2
D 1066	DIODE				HVC131TRF	G2070676		1-	B	b2
D 1067	DIODE				HVC131TRF	G2070676		1-	B	b2
D 1068	DIODE				RLS135 TE-11	G2070128		1-	B	b2
D 1069	DIODE				HN2D01FUTE85R	G2070348		1-	A	C4
D 1070	DIODE				1SS400 TE61	G2070634		1-	A	C4
D 1071	DIODE				1SV271 TPH3	G2070476		1-	B	b1
D 1072	DIODE				EDZ TE-61 5.1B	G2070998		1-	A	D1
D 1073	DIODE				1SS400 TE61	G2070634		1-	A	D3
D 1074	DIODE				1SS400 TE61	G2070634		1-	B	a2
D 1075	DIODE				1SS400 TE61	G2070634		1-	A	C4
D 1076	DIODE				UDZS TE-17 5.1B	G2070908		1-	B	c4
D 1077	DIODE				1SS400 TE61	G2070634		1-	B	b2
D 1078	DIODE				UDZS TE-17 20B	G2071016		1-	A	F1
D 1079	SURGE ABSORBER				TVSF0805	Q9000807		1-	A	F1

MAIN Unit

Parts List

REF	DESCRIPTION	VALUE	V/W	TOL.	MFR'S DESIG	VXSTD P/N	VERS.	LOT	SIDE	LAY ADR
D 1080	SURGE ABSORBER				TVSF0805	Q9000807		1-	A	G1
D 1082	DIODE				HSC277TRF	G2070584		1-	B	c1
DS1001	LCD				A15A013X	G6090160		1-	A	F2
HS1001	HEATSINK PLATE					RA0455500		1-	B	c1
J 1001	SHIELD FINGER				4025 3100089	S5000225		1-	A	E3
J 1002	SHIELD FINGER				4025 3100089	S5000225		1-	A	E2
J 1003	CONNECTOR				HSJ1594-010055	P1090896		1-	B	b4
J 1004	CONNECTOR				HEC3604-010120	P0091265		1-	B	c4
J 1005	CONNECTOR				AXK6F10335YP	P0091225		1-	B	d3
L 1001	M.RFC	1uH			LK1608 1R0K-T	L1690687		1-	B	b3
L 1002	M.RFC	100uH			LEM2520T101J	L1690635		1-	B	c3
L 1003	M.RFC	1uH			LK1608 1R0K-T	L1690687		1-	B	f3
L 1004	M.RFC	0.039uH			TFL0510-39N	L1690818		1-	B	e2
L 1005	M.RFC	0.39uH		2%	C1608CB-R39G	L1691107		1-	B	f2
L 1006	M.RFC	0.39uH		2%	C1608CB-R39G	L1691107		1-	B	e1
L 1007	M.RFC	0.39uH		2%	C1608CB-R39G	L1691107		1-	B	f1
L 1008	M.RFC	1uH			LK1608 1R0K-T	L1690687		1-	B	d2
L 1009	COIL				E2 0.3-1.1-3T-R	L0022579		1-	B	d2
L 1010	M.RFC	0.0039uH		5%	C1608CB-3N9J	L1691091		1-	B	d2
L 1011	M.RFC	0.022uH			TFL0510-22N	L1690815		1-	B	d2
L 1012	M.RFC	0.01uH		2%	C1608CB-10NG	L1691032		1-	B	d2
L 1013	M.RFC	0.018uH		2%	C1608CB-18NG	L1691035		1-	B	d2
L 1014	M.RFC	0.024uH		2%	C1608CB-24NG	L1691281		1-	B	d2
L 1015	M.RFC	4.7uH			LK1608 4R7K-T	L1690688		1-	B	d2
L 1016	M.RFC	0.15uH			LK1608 R15K-T	L1690409		1-	B	d2
L 1017	M.RFC	0.047uH			TFL0816-47	L1690499		1-	B	d1
L 1018	M.RFC	0.015uH			TFL0816-15	L1690493		1-	B	d1
L 1019	M.RFC	0.033uH		2%	C1608CB-33NG	L1691038		1-	B	c1
L 1020	M.RFC	0.01uH		2%	C1608CB-10NG	L1691032		1-	B	c1
L 1021	M.RFC	0.1uH		5%	C1608CB-R10J	L1691063		1-	A	D1
L 1021	M.RFC	0.1uH		2%	C1608CB-R10G	L1691045		3-	A	D1
L 1022	M.RFC	0.01uH		2%	C1608CB-10NG	L1691032		1-	A	E1
L 1023	COIL				E2 0.3-0.9-3T-R	L0022389		1-	A	E1
L 1024	M.RFC	0.015uH		2%	C1608CB-15NG	L1691034		1-	A	E1
L 1025	COIL				E2 0.25-1.85-8.5T-L	L0022576		1-	A	E1
L 1026	COIL	0.0054uH			AS050321-5R4NJ	L0022581		1-	A	E1
L 1027	M.RFC	4.7uH			LK1608 4R7K-T	L1690688		1-	A	F1
L 1028	COIL				E2 0.28-1.0-4.5T-R	L0022395		1-	A	E1
L 1029	COIL				E2 0.45-1.4-4T-L	L0022391		1-	B	b1
L 1030	COIL				E2 0.45-1.4-4T-L	L0022391		1-	B	b1
L 1031	COIL				E2 0.45-1.4-4T-L	L0022391		1-	B	b1
L 1032	COIL				E2 0.35-1.6-4T-L	L0022456		1-	B	a1
L 1033	COIL				E2 0.45-1.4-4T-L	L0022391		1-	B	a1
L 1034	COIL				E2 0.45-1.4-4T-L	L0022391		1-	B	b1
L 1035	COIL				E2 0.35-1.6-7T-L	L0022390		1-	B	b1
L 1036	M.RFC	4.7uH			LK1608 4R7K-T	L1690688		1-	B	b1
L 1037	COIL				E2 0.35-1.6-7T-L	L0022390		1-	B	b1
L 1038	COIL				E2 0.35-1.6-7T-L	L0022390		1-	B	a2
L 1039	COIL				E2 0.35-1.6-7T-L	L0022390		1-	B	a1
L 1040	M.RFC	0.0047uH			TFL0510-4N7	L1690807		1-3	A	C1
L 1040	M.RFC	0.0047uH			TFL0510-4N7	L1690807	W/ CE	4-	A	C1
L 1040	M.RFC	0.0047uH			TFL0510-4N7	L1690807	W/O CE	4-	A	C1
L 1041	M.RFC	0.0047uH			TFL0510-4N7	L1690807		1-	A	C2
L 1042	M.RFC	0.0047uH			TFL0510-4N7	L1690807		1-	A	D2
L 1043	M.RFC	0.0047uH			TFL0510-4N7	L1690807		1-	A	D2
L 1044	M.RFC	0.0047uH			TFL0510-4N7	L1690807		1-	A	E2
L 1045	M.RFC	0.0047uH			TFL0816-4N7	L1690487		1-	A	E2
L 1046	M.RFC	0.0047uH			TFL0510-4N7	L1690807		1-	A	F2
L 1047	M.RFC	0.01uH			TFL0510-10N	L1690811		1-	A	F2
L 1048	M.RFC	0.01uH			TFL0816-10	L1690491		1-	A	F1
L 1049	COIL				E2 0.28-1.0-4T-R	L0022365		1-	B	e1
L 1050	COIL				E2 0.28-1.0-4T-R	L0022365		1-	B	d1
L 1051	M.RFC	0.01uH		2%	C1608CB-10NG	L1691032		1-	A	D1
L 1052	M.RFC	0.1uH			TFL0816-100N	L1690981		1-	A	D1
L 1053	M.RFC	0.015uH			TFL0510-15N	L1690813		1-	A	C1
L 1054	M.RFC	0.015uH			TFL0510-15N	L1690813		1-	A	C1
L 1054	M.RFC	0.039uH			TFL0510-39N	L1690818		10-	A	C1
L 1055	M.RFC	0.015uH			TFL0510-15N	L1690813		1-	A	D1
L 1055	M.RFC	0.082uH		2%	C1608CB-82NG	L1691044		10-	A	D1
L 1056	M.RFC	0.033uH			TFL0510-33N	L1690817		1-	A	D1
L 1057	M.RFC	0.039uH		2%	C1608CB-39NG	L1691039		1-	A	E1
L 1058	M.RFC	0.01uH		2%	C1608CB-10NG	L1691032		1-	A	E1
L 1059	M.RFC	0.01uH		2%	C1608CB-10NG	L1691032		1-	B	c1

MAIN Unit

Parts List

REF	DESCRIPTION	VALUE	V/W	TOL.	MFR'S DESIG	VXSTD P/N	VERS.	LOT	SIDE	LAY ADR
L 1060	M.RFC	0.082uH		2%	C1608CB-82NG	L1691044		1-	A	C2
L 1061	M.RFC	0.082uH		2%	C1608CB-82NG	L1691044		1-	A	D2
L 1062	M.RFC	0.082uH		2%	C1608CB-82NG	L1691044		1-	A	D2
L 1063	M.RFC	1uH			LK1608 1R0K-T	L1690687		1-	B	c2
L 1064	M.RFC	0.047uH			TFL0816-47	L1690499		1-	A	C2
L 1065	M.RFC	0.039uH			TFL0816-39	L1690498		1-	A	C2
L 1066	M.RFC	0.039uH			TFL0816-39	L1690498		1-	A	D2
L 1067	M.RFC	0.22uH		2%	C1608CB-R22G	L1691103		1-	B	c2
L 1068	M.RFC	0.082uH		2%	C1608CB-82NG	L1691044		1-	B	c2
L 1069	M.RFC	0.082uH		2%	C1608CB-82NG	L1691044		1-	B	c2
L 1070	M.RFC	0.024uH		2%	C1608CB-24NG	L1691281		1-	B	c2
L 1071	M.RFC	0.022uH			TFL0816-22	L1690495		1-	B	c2
L 1072	M.RFC	0.047uH		2%	C1608CB-47NG	L1691040		1-	B	c2
L 1073	M.RFC	0.082uH		2%	C1608CB-82NG	L1691044		1-	B	c2
L 1074	COIL				E2 0.28-1.0-10TR	L0022425		1-	B	b2
L 1075	COIL				E2 0.35-1.6-7T-L	L0022390		1-	B	b2
L 1076	M.RFC	1uH			LK1608 1R0K-T	L1690687		1-	A	C2
L 1077	M.RFC	1uH			LK1608 1R0K-T	L1690687		1-	A	C2
L 1078	M.RFC	1uH			LK1608 1R0K-T	L1690687		1-	A	G4
L 1079	M.RFC	1uH			LK1608 1R0K-T	L1690687		1-	B	d1
L 1080	M.RFC	1uH			LK1608 1R0K-T	L1690687		1-	B	b1
L 1081	M.RFC	0.039uH			TFL0510-39N	L1690818		10-	A	C1
L 1082	M.RFC	0.039uH			TFL0510-39N	L1690818		10-	A	C1
MC1001	MIC. ELEMENT				EM-100PT	M3290029		1-	A	D1
Q 1001	IC				NJU7231F30-TE1	G1093512		1-	B	c3
Q 1002	TRANSISTOR				2SB1132 T100 Q	G3211327Q		1-	B	d3
Q 1003	TRANSISTOR				2SC4617 TL R	G3346178R		1-	B	c3
Q 1004	TRANSISTOR				2SC4617 TL R	G3346178R		1-	B	d3
Q 1005	TRANSISTOR				DTC144EE TL	G3070075		1-	B	f2
Q 1006	TRANSISTOR				2SC4617 TL R	G3346178R		1-	B	d3
Q 1007	IC				NJM12902V-TE1	G1093592		1-	B	e3
Q 1008	IC				DTA7233D-TR	G1091112		1-	B	b2
Q 1009	TRANSISTOR				2SC4617 TL R	G3346178R		1-	B	c4
Q 1010	TRANSISTOR				DTC144EE TL	G3070075		1-	B	c4
Q 1011	TRANSISTOR				2SB1132 T100 Q	G3211327Q		1-	A	E3
Q 1012	TRANSISTOR				2SC4617 TL R	G3346178R		1-	B	c3
Q 1014	TRANSISTOR				DTC144EE TL	G3070075		1-	A	E3
Q 1015	TRANSISTOR				2SC4617 TL R	G3346178R		1-	A	E2
Q 1016	IC				S-80848CNNB-B89-T2	G1094012		1-	A	E3
Q 1017	TRANSISTOR				2SC4617 TL R	G3346178R		1-	A	E3
Q 1018	TRANSISTOR				DTA144EE TL	G3070074		1-	B	d3
Q 1019	IC				NJM12902V-TE1	G1093592		1-	B	e4
Q 1020	IC				NJM12902V-TE1	G1093592		1-	B	f4
Q 1021	TRANSISTOR				DTC144EE TL	G3070075		1-	B	e3
Q 1022	TRANSISTOR				DTC144EE TL	G3070075		1-	B	e4
Q 1023	TRANSISTOR				DTC144EE TL	G3070075		1-	B	e4
Q 1024	TRANSISTOR				DTC144EE TL	G3070075		1-	B	d4
Q 1025	TRANSISTOR				2SD1664 T100 Q	G3416647Q		1-	B	g3
Q 1026	TRANSISTOR				2SC4617 TL R	G3346178R		1-	B	d4
Q 1027	TRANSISTOR				DTA144EE TL	G3070074		1-	B	e3
Q 1028	TRANSISTOR				DTC144EE TL	G3070075		1-	B	e3
Q 1029	TRANSISTOR				DTC144EE TL	G3070075		1-	B	e3
Q 1030	IC				BU2090FS-E1	G1092187		1-	B	e3
Q 1031	IC				HD64F2266TF13(FLASH)	✖		1-	A	F3
Q 1032	TRANSISTOR				DTA144EE TL	G3070074		1-	A	F3
Q 1033	TRANSISTOR				2SC4617 TL R	G3346178R		1-	B	b3
Q 1034	IC				AT24C256N-10SI-1.8 SL383	G1093837		1-	B	b3
Q 1035	TRANSISTOR				2SC4617 TL R	G3346178R		1-	B	a3
Q 1036	TRANSISTOR				2SB1132 T100 Q	G3211327Q		1-	B	a3
Q 1037	IC				MB15A01PFV1-G-BND-EF	G1092545		1-	B	e2
Q 1038	TRANSISTOR				2SA1774 TL R	G3117748R		1-	B	e2
Q 1039	TRANSISTOR				DTC144EE TL	G3070075		1-	B	e2
Q 1040	TRANSISTOR				2SC5006-T1	G3350068		1-	B	e1
Q 1041	TRANSISTOR				2SC4915-O(TE85L)	G3349158O		1-	B	f2
Q 1042	TRANSISTOR				DTC144EE TL	G3070075		1-	B	g1
Q 1043	TRANSISTOR				DTA144EE TL	G3070074		1-	B	g1
Q 1044	IC				TA31136FN(EL)	G1091605		1-	B	g1
Q 1045	TRANSISTOR				2SC4617 TL R	G3346178R		1-	B	g2
Q 1046	TRANSISTOR				2SC4617 TL R	G3346178R		1-	B	g3
Q 1047	TRANSISTOR				2SC4617 TL R	G3346178R		1-	B	g3
Q 1048	TRANSISTOR				2SC4617 TL R	G3346178R		1-	B	f3
Q 1049	TRANSISTOR				2SC4915-O(TE85L)	G3349158O		1-	B	f1
Q 1050	TRANSISTOR				DTC144EE TL	G3070075		1-	B	d3

✖: Please contact Vertex Standard

MAIN Unit

Parts List

REF	DESCRIPTION	VALUE	V/W	TOL.	MFR'S DESIG	VXSTD P/N	VERS.	LOT	SIDE	LAY ADR
Q 1051	TRANSISTOR				2SA1774 TL R	G3117748R		1-	A	C3
Q 1052	TRANSISTOR				DTA144EE TL	G3070074		1-	A	C3
Q 1053	TRANSISTOR				2SC4617 TL R	G3346178R		1-	B	d3
Q 1054	IC				TA75S01F TE85R	G1091593		1-	B	a2
Q 1055	IC				BU2090FS-E1	G1092187		1-	A	D3
Q 1056	TRANSISTOR				2SA1774 TL R	G3117748R		1-	A	D3
Q 1057	TRANSISTOR				2SA1774 TL R	G3117748R		1-	A	C3
Q 1058	TRANSISTOR				UMA8N TR	G3070270		1-	A	D3
Q 1059	TRANSISTOR				2SA1774 TL R	G3117748R		1-	A	D3
Q 1060	TRANSISTOR				2SA1774 TL R	G3117748R		1-	A	D3
Q 1061	TRANSISTOR				DTA144EE TL	G3070074		1-	A	C3
Q 1062	TRANSISTOR				UMA8N TR	G3070270		1-	A	C3
Q 1063	TRANSISTOR				UMA8N TR	G3070270		1-	A	C3
Q 1064	TRANSISTOR				DTC144EE TL	G3070075		1-	A	D2
Q 1065	TRANSISTOR				2SC5006-T1	G3350068		1-	B	d2
Q 1066	TRANSISTOR				2SC5006-T1	G3350068		1-	B	d2
Q 1067	TRANSISTOR				2SC5006-T1	G3350068		1-	B	d2
Q 1068	TRANSISTOR				2SC5006-T1	G3350068		1-	B	d2
Q 1069	TRANSISTOR				2SC5006-T1	G3350068		1-	B	d1
Q 1070	TRANSISTOR				2SC5006-T1	G3350068		1-	B	d1
Q 1071	TRANSISTOR				2SC5006-T1	G3350068		1-	B	d1
Q 1072	TRANSISTOR				2SB1132 T100 Q	G3211327Q		1-	A	E2
Q 1073	TRANSISTOR				2SC4617 TL R	G3346178R		1-	A	D2
Q 1074	FET				2SK2596BXTL	G3825967		1-	B	c1
Q 1075	FET				RD07MVS1-T12	G3070320		1-	A	E1
Q 1076	TRANSISTOR				DTC144EE TL	G3070075		1-	A	F1
Q 1077	TRANSISTOR				2SC5006-T1	G3350068		1-	A	C2
Q 1078	TRANSISTOR				2SC5006-T1	G3350068		1-	A	D2
Q 1079	TRANSISTOR				2SC5277-D2-TL	G3352778B		1-	A	E2
Q 1080	FET				3SK296ZQ-TL	G4802968		1-	B	e1
Q 1081	FET				3SK296ZQ-TL	G4802968		1-	A	D1
Q 1082	TRANSISTOR				2SC5006-T1	G3350068		1-	A	C1
Q 1083	FET				3SK296ZQ-TL	G4802968		1-	A	C2
Q 1084	TRANSISTOR				2SC5006-T1	G3350068		1-	A	C2
Q 1085	FET				3SK296ZQ-TL	G4802968		1-	B	c2
Q 1086	FET				3SK296ZQ-TL	G4802968		1-	B	c2
Q 1087	IC				NJU7007F2-TE1	G1093617		1-	A	E3
Q 1088	TRANSISTOR				2SC4617 TL R	G3346178R		1-	A	D1
Q 1089	TRANSISTOR				DTC144EE TL	G3070075		1-	A	D1
Q 1090	TRANSISTOR				DTC144EE TL	G3070075		1-	A	D3
Q 1091	TRANSISTOR				DTC144EE TL	G3070075		1-	B	a3
R 1001	CHIP RES.	4.7k	1/16W	5%	RMC1/16S 472JTH	J24189033		1-	B	c3
R 1002	CHIP RES.	1k	1/16W	5%	RMC1/16S 102JTH	J24189025		1-	B	c3
R 1003	CHIP RES.	3.3k	1/16W	0.5%	RR0510P-332-D	J24189131		1-	A	D3
R 1004	CHIP RES.	3.3k	1/16W	0.5%	RR0510P-332-D	J24189131		1-	B	d3
R 1005	CHIP RES.	10k	1/16W	0.5%	RR0510P-103-D	J24189143		1-	B	c3
R 1006	CHIP RES.	10k	1/16W	5%	RMC1/16S 103JTH	J24189037		1-	B	g2
R 1007	CHIP RES.	150k	1/16W	5%	RMC1/16S 154JTH	J24189051		1-	B	g3
R 1008	CHIP RES.	10k	1/16W	5%	RMC1/16S 103JTH	J24189037		1-	B	f2
R 1009	CHIP RES.	150k	1/16W	5%	RMC1/16S 154JTH	J24189051		1-	B	f2
R 1010	CHIP RES.	150k	1/16W	5%	RMC1/16S 154JTH	J24189051		1-	B	g3
R 1011	CHIP RES.	100k	1/16W	5%	RMC1/16S 104JTH	J24189049		1-	B	f2
R 1012	CHIP RES.	150k	1/16W	5%	RMC1/16S 154JTH	J24189051		1-	B	e3
R 1013	CHIP RES.	1M	1/16W	5%	RMC1/16S 105JTH	J24189061		1-	B	e3
R 1014	CHIP RES.	10k	1/16W	5%	RMC1/16S 103JTH	J24189037		1-	B	e3
R 1015	CHIP RES.	10k	1/16W	5%	RMC1/16S 103JTH	J24189037		1-	B	e3
R 1016	CHIP RES.	56k	1/16W	5%	RMC1/16S 563JTH	J24189046		1-	B	e3
R 1017	CHIP RES.	68k	1/16W	5%	RMC1/16S 683JTH	J24189047		1-	B	f3
R 1018	CHIP RES.	3.3k	1/16W	5%	RMC1/16S 332JTH	J24189031		1-	A	D4
R 1019	CHIP RES.	4.7k	1/16W	5%	RMC1/16S 472JTH	J24189033		1-	B	a3
R 1020	CHIP RES.	10k	1/16W	5%	RMC1/16S 103JTH	J24189037		1-	B	e3
R 1021	CHIP RES.	10	1/16W	5%	RMC1/16S 100JTH	J24189001		1-	B	b2
R 1023	CHIP RES.	1k	1/16W	5%	RMC1/16S 102JTH	J24189025		1-	B	c3
R 1024	CHIP RES.	47k	1/16W	5%	RMC1/16S 473JTH	J24189045		1-	B	c3
R 1025	CHIP RES.	1k	1/16W	5%	RMC1/16S 102JTH	J24189025		1-	B	c4
R 1026	CHIP RES.	470	1/16W	5%	RMC1/16S 471JTH	J24189021		1-	B	c3
R 1027	CHIP RES.	100	1/16W	5%	RMC1/16S 101JTH	J24189013		1-	A	C3
R 1028	CHIP RES.	220k	1/16W	5%	RMC1/16S 224JTH	J24189053		1-	B	c4
R 1029	CHIP RES.	10k	1/16W	5%	RMC1/16S 103JTH	J24189037		1-	A	E3
R 1030	CHIP RES.	100k	1/16W	5%	RMC1/16S 104JTH	J24189049		1-	A	E2
R 1031	CHIP RES.	22k	1/16W	5%	RMC1/16S 223JTH	J24189041		1-	A	F3
R 1032	CHIP RES.	470k	1/16W	5%	RMC1/16S 474JTH	J24189057		1-	A	E3
R 1033	CHIP RES.	470k	1/16W	5%	RMC1/16S 474JTH	J24189057		1-	A	E3

MAIN Unit

Parts List

REF	DESCRIPTION	VALUE	V/W	TOL.	MFR'S DESIG	VXSTD P/N	VERS.	LOT	SIDE	LAY ADR
R 1034	CHIP RES.	22k	1/16W	5%	RMC1/16S 223JTH	J24189041		1-	A	E3
R 1035	CHIP RES.	33k	1/16W	5%	RMC1/16S 333JTH	J24189043		1-	A	D1
R 1036	CHIP RES.	56k	1/16W	5%	RMC1/16S 563JTH	J24189046		1-	A	D1
R 1037	CHIP RES.	470	1/16W	5%	RMC1/16S 471JTH	J24189021		1-	B	d3
R 1038	CHIP RES.	1k	1/16W	5%	RMC1/16S 102JTH	J24189025		1-	A	D4
R 1039	CHIP RES.	2.2k	1/16W	5%	RMC1/16S 222JTH	J24189029		1-	A	C3
R 1040	CHIP RES.	10k	1/16W	5%	RMC1/16S 103JTH	J24189037		1-	A	C4
R 1041	CHIP RES.	15k	1/16W	5%	RMC1/16S 153JTH	J24189039		1-	B	d4
R 1042	CHIP RES.	68k	1/16W	0.5%	RR0510R-683-D	J24189163		1-	A	C4
R 1043	CHIP RES.	33k	1/16W	5%	RMC1/16S 333JTH	J24189043		1-	B	e3
R 1044	CHIP RES.	2.2M	1/16W	5%	RMC1/16S 225JTH	J24189065		1-	B	d4
R 1045	CHIP RES.	2.2k	1/16W	5%	RMC1/16S 222JTH	J24189029		1-	B	d4
R 1046	CHIP RES.	4.7k	1/16W	5%	RMC1/16S 472JTH	J24189033		1-	B	d4
R 1047	CHIP RES.	4.7k	1/16W	5%	RMC1/16S 472JTH	J24189033		1-	B	a3
R 1048	CHIP RES.	10k	1/16W	0.5%	RR0510P-103-D	J24189143		1-	B	e4
R 1049	CHIP RES.	22k	1/16W	5%	RMC1/16S 223JTH	J24189041		1-	B	e4
R 1050	CHIP RES.	820k	1/16W	5%	RMC1/16S 824JTH	J24189060		1-	A	D3
R 1051	CHIP RES.	150k	1/16W	5%	RMC1/16S 154JTH	J24189051		1-	B	f3
R 1052	CHIP RES.	470k	1/16W	5%	RMC1/16S 474JTH	J24189057		1-	B	f2
R 1053	CHIP RES.	150k	1/16W	5%	RMC1/16S 154JTH	J24189051		1-	B	f3
R 1054	CHIP RES.	22k	1/16W	5%	RMC1/16S 223JTH	J24189041		1-	B	f3
R 1054	CHIP RES.	33k	1/16W	5%	RMC1/16S 333JTH	J24189043		4-	B	f3
R 1055	CHIP RES.	1k	1/16W	5%	RMC1/16S 102JTH	J24189025		1-2		
R 1055	CHIP RES.	1k	1/16W	5%	RMC1/16S 102JTH	J24189025	AUSTRALIA	3		
R 1055	CHIP RES.	1k	1/16W	5%	RMC1/16S 102JTH	J24189025	EUROPE	3		
R 1055	CHIP RES.	1k	1/16W	5%	RMC1/16S 102JTH	J24189025	EXPORT	3		
R 1055	CHIP RES.	1k	1/16W	5%	RMC1/16S 102JTH	J24189025	USA	3		
R 1056	CHIP RES.	470k	1/16W	5%	RMC1/16S 474JTH	J24189057		1-3		
R 1057	CHIP RES.	47k	1/16W	5%	RMC1/16S 473JTH	J24189045		1-	B	f3
R 1057	CHIP RES.	100k	1/16W	5%	RMC1/16S 104JTH	J24189049		4-	B	f3
R 1058	CHIP RES.	47k	1/16W	5%	RMC1/16S 473JTH	J24189045		1-	B	f3
R 1059	CHIP RES.	47k	1/16W	5%	RMC1/16S 473JTH	J24189045		1-	B	e3
R 1060	CHIP RES.	10k	1/16W	5%	RMC1/16S 103JTH	J24189037		1-	B	f3
R 1061	CHIP RES.	39k	1/16W	5%	RMC1/16S 393JTH	J24189044		1-	B	f3
R 1062	CHIP RES.	33k	1/16W	5%	RMC1/16S 333JTH	J24189043		1-	B	f2
R 1063	CHIP RES.	68k	1/16W	5%	RMC1/16S 683JTH	J24189047		1-	B	e3
R 1064	CHIP RES.	390k	1/16W	5%	RMC1/16S 394JTH	J24189056		1-	B	e3
R 1065	CHIP RES.	390k	1/16W	5%	RMC1/16S 394JTH	J24189056		1-	B	e3
R 1066	CHIP RES.	47k	1/16W	5%	RMC1/16S 473JTH	J24189045		1-	B	f4
R 1067	CHIP RES.	390k	1/16W	5%	RMC1/16S 394JTH	J24189056		1-	B	f4
R 1068	CHIP RES.	390k	1/16W	5%	RMC1/16S 394JTH	J24189056		1-	B	f4
R 1069	CHIP RES.	10k	1/16W	5%	RMC1/16S 103JTH	J24189037		1-	B	f4
R 1070	CHIP RES.	120k	1/16W	5%	RMC1/16S 124JTH	J24189050		1-	B	f4
R 1071	CHIP RES.	10k	1/16W	5%	RMC1/16S 103JTH	J24189037		1-	B	f4
R 1072	CHIP RES.	39k	1/16W	5%	RMC1/16S 393JTH	J24189044		1-	B	f3
R 1073	CHIP RES.	1k	1/16W	5%	RMC1/16S 102JTH	J24189025		1-	B	g3
R 1074	CHIP RES.	6.8	1/2W	5%	RMC1/2 6R8JCTP	J24275689		1-	B	g3
R 1075	CHIP RES.	470k	1/16W	5%	RMC1/16S 474JTH	J24189057		1-	B	g3
R 1076	CHIP RES.	100k	1/16W	5%	RMC1/16S 104JTH	J24189049		1-	B	d4
R 1077	CHIP RES.	10k	1/16W	0.5%	RR0510P-103-D	J24189143		1-	A	C4
R 1078	CHIP RES.	100k	1/16W	0.5%	RR0510R-104-D	J24189167		1-	A	C4
R 1079	CHIP RES.	2.2M	1/16W	5%	RMC1/16S 225JTH	J24189065		1-	B	e4
R 1080	CHIP RES.	4.7k	1/16W	5%	RMC1/16S 472JTH	J24189033		1-	B	e4
R 1081	CHIP RES.	2.2k	1/16W	5%	RMC1/16S 222JTH	J24189029		1-	B	e4
R 1082	CHIP RES.	15k	1/16W	5%	RMC1/16S 153JTH	J24189039		1-	B	e4
R 1083	CHIP RES.	68k	1/16W	5%	RMC1/16S 683JTH	J24189047		1-	B	e4
R 1084	CHIP RES.	220k	1/16W	5%	RMC1/16S 224JTH	J24189053		1-	B	e3
R 1085	CHIP RES.	220k	1/16W	5%	RMC1/16S 224JTH	J24189053		1-	B	e3
R 1086	CHIP RES.	330k	1/16W	5%	RMC1/16S 334JTH	J24189055		1-	B	e3
R 1087	CHIP RES.	22k	1/16W	5%	RMC1/16S 223JTH	J24189041		1-	B	e3
R 1088	CHIP RES.	68k	1/16W	5%	RMC1/16S 683JTH	J24189047		1-	B	e3
R 1089	CHIP RES.	220k	1/16W	5%	RMC1/16S 224JTH	J24189053		1-	B	d3
R 1090	CHIP RES.	150k	1/16W	5%	RMC1/16S 154JTH	J24189051		1-	B	d3
R 1091	CHIP RES.	150k	1/16W	5%	RMC1/16S 154JTH	J24189051		1-	B	d3
R 1092	CHIP RES.	47k	1/16W	5%	RMC1/16S 473JTH	J24189045		1-3	B	d3
R 1092	CHIP RES.	56k	1/16W	5%	RMC1/16S 563JTH	J24189046	AUSTRALIA	4-	B	d3
R 1092	CHIP RES.	56k	1/16W	5%	RMC1/16S 563JTH	J24189046	EUROPE	4-	B	d3
R 1092	CHIP RES.	56k	1/16W	5%	RMC1/16S 563JTH	J24189046	EXPORT	4-	B	d3
R 1092	CHIP RES.	56k	1/16W	5%	RMC1/16S 563JTH	J24189046	JAPAN	4-	B	d3
R 1092	CHIP RES.	47k	1/16W	5%	RMC1/16S 473JTH	J24189045	USA	4-	B	d3
R 1093	CHIP RES.	22k	1/16W	5%	RMC1/16S 223JTH	J24189041		1-	B	d3
R 1094	CHIP RES.	1k	1/16W	5%	RMC1/16S 102JTH	J24189025		1-	B	g3
R 1095	CHIP RES.	47k	1/16W	5%	RMC1/16S 473JTH	J24189045		1-	A	C4

MAIN Unit

Parts List

REF	DESCRIPTION	VALUE	V/W	TOL.	MFR'S DESIG	VXSTD P/N	VERS.	LOT	SIDE	LAY ADR
R 1096	CHIP RES.	22k	1/16W	5%	RMC1/16S 223JTH	J24189041		1-	B	d3
R 1097	CHIP RES.	100	1/16W	5%	RMC1/16S 101JTH	J24189013		1-	B	b2
R 1098	CHIP RES.	10k	1/16W	0.5%	RR0510P-103-D	J24189143		1-	A	F2
R 1099	CHIP RES.	10k	1/16W	0.5%	RR0510P-103-D	J24189143		1-	A	F2
R 1100	CHIP RES.	100k	1/16W	5%	RMC1/16S 104JTH	J24189049		1-	A	E2
R 1101	CHIP RES.	1k	1/16W	5%	RMC1/16S 102JTH	J24189025		1-	B	b2
R 1102	CHIP RES.	1k	1/16W	5%	RMC1/16S 102JTH	J24189025		1-	A	E2
R 1103	CHIP RES.	1k	1/16W	5%	RMC1/16S 102JTH	J24189025		1-	A	F2
R 1104	CHIP RES.	1k	1/16W	5%	RMC1/16S 102JTH	J24189025		1-	A	E2
R 1105	CHIP RES.	1k	1/16W	5%	RMC1/16S 102JTH	J24189025		1-	A	E2
R 1106	CHIP RES.	1k	1/16W	5%	RMC1/16S 102JTH	J24189025		1-	A	E2
R 1107	CHIP RES.	1k	1/16W	5%	RMC1/16S 102JTH	J24189025		1-	A	E2
R 1108	CHIP RES.	1k	1/16W	5%	RMC1/16S 102JTH	J24189025		1-	A	E2
R 1109	CHIP RES.	1k	1/16W	5%	RMC1/16S 102JTH	J24189025		1-	B	b3
R 1110	CHIP RES.	100k	1/16W	5%	RMC1/16S 104JTH	J24189049		1-	A	E2
R 1111	CHIP RES.	1k	1/16W	5%	RMC1/16S 102JTH	J24189025		1-	A	F2
R 1112	CHIP RES.	10k	1/16W	5%	RMC1/16S 103JTH	J24189037		1-	A	E2
R 1113	CHIP RES.	1k	1/16W	5%	RMC1/16S 102JTH	J24189025		1-	A	E3
R 1114	CHIP RES.	1k	1/16W	5%	RMC1/16S 102JTH	J24189025		1-	A	E3
R 1115	CHIP RES.	1k	1/16W	5%	RMC1/16S 102JTH	J24189025		1-	A	E3
R 1116	CHIP RES.	1k	1/16W	5%	RMC1/16S 102JTH	J24189025		1-	A	E2
R 1117	CHIP RES.	390k	1/16W	5%	RMC1/16S 394JTH	J24189056		1-	B	b2
R 1118	CHIP RES.	220k	1/16W	5%	RMC1/16S 224JTH	J24189053		1-	B	d3
R 1119	CHIP RES.	470k	1/16W	5%	RMC1/16S 474JTH	J24189057		1-	B	e3
R 1120	CHIP RES.	1M	1/16W	5%	RMC1/16S 105JTH	J24189061		1-	B	b3
R 1121	CHIP RES.	1M	1/16W	5%	RMC1/16S 105JTH	J24189061		1-	B	b3
R 1122	CHIP RES.	330k	1/16W	5%	RMC1/16S 334JTH	J24189055		1-	A	E3
R 1123	CHIP RES.	330k	1/16W	5%	RMC1/16S 334JTH	J24189055		1-	A	E3
R 1124	CHIP RES.	68k	1/16W	5%	RMC1/16S 683JTH	J24189047		1-	B	d3
R 1125	CHIP RES.	1.5M	1/16W	5%	RMC1/16S 155JTH	J24189063		1-	B	d3
R 1126	CHIP RES.	820k	1/16W	5%	RMC1/16S 824JTH	J24189060		1-	B	d3
R 1127	CHIP RES.	390k	1/16W	5%	RMC1/16S 394JTH	J24189056		1-	B	d3
R 1128	CHIP RES.	100k	1/16W	0.5%	RR0510R-104-D	J24189167		1-	B	d3
R 1129	CHIP RES.	100k	1/16W	0.5%	RR0510R-104-D	J24189167		1-	B	d3
R 1130	CHIP RES.	100k	1/16W	0.5%	RR0510R-104-D	J24189167		1-	B	d3
R 1131	CHIP RES.	100k	1/16W	0.5%	RR0510R-104-D	J24189167		1-	B	d3
R 1132	CHIP RES.	100k	1/16W	0.5%	RR0510R-104-D	J24189167		1-	B	d3
R 1133	CHIP RES.	100k	1/16W	5%	RMC1/16S 104JTH	J24189049		1-	B	d3
R 1134	CHIP RES.	1.8k	1/16W	5%	RMC1/16S 182JTH	J24189028	JAPAN	3	B	e3
R 1134	CHIP RES.	1.8k	1/16W	5%	RMC1/16S 182JTH	J24189028		4-	B	e3
R 1135	CHIP RES.	2.7k	1/16W	5%	RMC1/16S 272JTH	J24189030	JAPAN	3	B	e3
R 1135	CHIP RES.	2.7k	1/16W	5%	RMC1/16S 272JTH	J24189030		4-	B	e3
R 1136	CHIP RES.	470k	1/16W	5%	RMC1/16S 474JTH	J24189057		1-	A	C4
R 1137	CHIP RES.	100k	1/16W	5%	RMC1/16S 104JTH	J24189049		1-	A	C4
R 1138	CHIP RES.	47k	1/16W	5%	RMC1/16S 473JTH	J24189045		1-	B	f2
R 1139	CHIP RES.	47k	1/16W	5%	RMC1/16S 473JTH	J24189045		1-	B	f2
R 1140	CHIP RES.	47k	1/16W	5%	RMC1/16S 473JTH	J24189045		1-	B	f2
R 1141	CHIP RES.	47k	1/16W	5%	RMC1/16S 473JTH	J24189045		1-	B	f2
R 1142	CHIP RES.	33k	1/16W	5%	RMC1/16S 333JTH	J24189043		1-	B	b3
R 1143	CHIP RES.	100	1/16W	5%	RMC1/16S 101JTH	J24189013		1-	A	F2
R 1144	CHIP RES.	100	1/16W	5%	RMC1/16S 101JTH	J24189013		1-	A	F2
R 1145	CHIP RES.	100	1/16W	5%	RMC1/16S 101JTH	J24189013		1-	A	F2
R 1146	CHIP RES.	100	1/16W	5%	RMC1/16S 101JTH	J24189013		1-	A	F2
R 1147	CHIP RES.	68k	1/16W	5%	RMC1/16S 683JTH	J24189047		1-	A	F2
R 1148	CHIP RES.	1k	1/16W	5%	RMC1/16S 102JTH	J24189025		1-	A	F3
R 1149	CHIP RES.	1k	1/16W	5%	RMC1/16S 102JTH	J24189025		1-	A	E3
R 1150	CHIP RES.	1k	1/16W	5%	RMC1/16S 102JTH	J24189025		1-	B	b3
R 1151	CHIP RES.	1k	1/16W	5%	RMC1/16S 102JTH	J24189025		1-	A	E3
R 1152	CHIP RES.	1k	1/16W	5%	RMC1/16S 102JTH	J24189025		1-	A	E3
R 1153	CHIP RES.	1k	1/16W	5%	RMC1/16S 102JTH	J24189025		1-	A	F3
R 1154	CHIP RES.	470	1/16W	5%	RMC1/16S 471JTH	J24189021		1-	A	F3
R 1155	CHIP RES.	330	1/16W	5%	RMC1/16S 331JTH	J24189019		1-	A	F3
R 1156	CHIP RES.	4.7k	1/16W	5%	RMC1/16S 472JTH	J24189033		1-	A	F3
R 1157	CHIP RES.	1k	1/16W	5%	RMC1/16S 102JTH	J24189025		1-	A	E3
R 1158	CHIP RES.	1k	1/16W	5%	RMC1/16S 102JTH	J24189025		1-	A	F3
R 1159	CHIP RES.	1k	1/16W	5%	RMC1/16S 102JTH	J24189025		1-	A	F3
R 1160	CHIP RES.	100	1/16W	5%	RMC1/16S 101JTH	J24189013		1-	A	F3
R 1161	CHIP RES.	100	1/16W	5%	RMC1/16S 101JTH	J24189013		1-	A	F3
R 1162	CHIP RES.	1k	1/16W	5%	RMC1/16S 102JTH	J24189025		1-	A	D3
R 1163	CHIP RES.	100	1/16W	5%	RMC1/16S 101JTH	J24189013		1-	A	F3
R 1164	CHIP RES.	0	1/16W	5%	RMC1/16S JPTH	J24189070	VER. USA A2	1-	A	C4
R 1164	CHIP RES.	0	1/16W	5%	RMC1/16S JPTH	J24189070	VER. A1	2-	A	C4
R 1164	CHIP RES.	0	1/16W	5%	RMC1/16S JPTH	J24189070	VER. A2	2-	A	C4

MAIN Unit

Parts List

REF	DESCRIPTION	VALUE	V/W	TOL.	MFR'S DESIG	VXSTD P/N	VERS.	LOT	SIDE	LAY ADR
R 1164	CHIP RES.	0	1/16W	5%	RMC1/16S JPTH	J24189070	VER. A3	2-	A	C4
R 1164	CHIP RES.	0	1/16W	5%	RMC1/16S JPTH	J24189070	VER. C1	2-	A	C4
R 1164	CHIP RES.	0	1/16W	5%	RMC1/16S JPTH	J24189070	VER. C2	2-	A	C4
R 1164	CHIP RES.	0	1/16W	5%	RMC1/16S JPTH	J24189070	VER. C3	2-	A	C4
R 1164	CHIP RES.	0	1/16W	5%	RMC1/16S JPTH	J24189070	VER. D1	2-	A	C4
R 1165	CHIP RES.	0	1/16W	5%	RMC1/16S JPTH	J24189070	VER. USA A2	1-	A	C4
R 1165	CHIP RES.	0	1/16W	5%	RMC1/16S JPTH	J24189070	VER. A1	2-	A	C4
R 1165	CHIP RES.	0	1/16W	5%	RMC1/16S JPTH	J24189070	VER. A2	2-	A	C4
R 1165	CHIP RES.	0	1/16W	5%	RMC1/16S JPTH	J24189070	VER. A3	2-	A	C4
R 1165	CHIP RES.	0	1/16W	5%	RMC1/16S JPTH	J24189070	VER. B1	2-	A	C4
R 1165	CHIP RES.	0	1/16W	5%	RMC1/16S JPTH	J24189070	VER. B2	2-	A	C4
R 1165	CHIP RES.	0	1/16W	5%	RMC1/16S JPTH	J24189070	VER. B3	2-	A	C4
R 1166	CHIP RES.	0	1/16W	5%	RMC1/16S JPTH	J24189070	VER. A1	2-	A	C4
R 1166	CHIP RES.	0	1/16W	5%	RMC1/16S JPTH	J24189070	VER. A2	2-	A	C4
R 1166	CHIP RES.	0	1/16W	5%	RMC1/16S JPTH	J24189070	VER. B1	2-	A	C4
R 1166	CHIP RES.	0	1/16W	5%	RMC1/16S JPTH	J24189070	VER. B2	2-	A	C4
R 1166	CHIP RES.	0	1/16W	5%	RMC1/16S JPTH	J24189070	VER. C1	2-	A	C4
R 1166	CHIP RES.	0	1/16W	5%	RMC1/16S JPTH	J24189070	VER. C2	2-	A	C4
R 1166	CHIP RES.	0	1/16W	5%	RMC1/16S JPTH	J24189070	VER. F	2-	A	C4
R 1167	CHIP RES.	0	1/16W	5%	RMC1/16S JPTH	J24189070	VER. USA A2	1-	B	d4
R 1167	CHIP RES.	0	1/16W	5%	RMC1/16S JPTH	J24189070	VER. A1	2-	B	d4
R 1167	CHIP RES.	0	1/16W	5%	RMC1/16S JPTH	J24189070	VER. B1	2-	B	d4
R 1167	CHIP RES.	0	1/16W	5%	RMC1/16S JPTH	J24189070	VER. C1	2-	B	d4
R 1167	CHIP RES.	0	1/16W	5%	RMC1/16S JPTH	J24189070	VER. D1	2-	B	d4
R 1167	CHIP RES.	0	1/16W	5%	RMC1/16S JPTH	J24189070	VER. D2	2-	B	d4
R 1167	CHIP RES.	0	1/16W	5%	RMC1/16S JPTH	J24189070	VER. F	2-	B	d4
R 1168	CHIP RES.	47k	1/16W	5%	RMC1/16S 473JTH	J24189045		1-	B	b3
R 1169	CHIP RES.	47k	1/16W	5%	RMC1/16S 473JTH	J24189045		1-	A	D4
R 1170	CHIP RES.	47k	1/16W	5%	RMC1/16S 473JTH	J24189045		1-	A	D4
R 1171	CHIP RES.	22k	1/16W	5%	RMC1/16S 223JTH	J24189041		1-	B	b3
R 1172	CHIP RES.	100k	1/16W	5%	RMC1/16S 104JTH	J24189049		1-	A	F3
R 1173	CHIP RES.	100k	1/16W	5%	RMC1/16S 104JTH	J24189049		1-	B	a3
R 1174	CHIP RES.	100k	1/16W	5%	RMC1/16S 104JTH	J24189049		1-	B	a3
R 1175	CHIP RES.	1M	1/16W	5%	RMC1/16S 105JTH	J24189061		1-	B	b3
R 1176	CHIP RES.	100	1/16W	5%	RMC1/16S 101JTH	J24189013		1-	A	F3
R 1177	CHIP RES.	100	1/16W	5%	RMC1/16S 101JTH	J24189013		1-	A	F3
R 1178	CHIP RES.	1k	1/16W	5%	RMC1/16S 102JTH	J24189025		1-	A	F3
R 1179	CHIP RES.	1k	1/16W	5%	RMC1/16S 102JTH	J24189025		1-	A	F3
R 1180	CHIP RES.	1k	1/16W	5%	RMC1/16S 102JTH	J24189025		1-	A	F3
R 1181	CHIP RES.	100k	1/16W	5%	RMC1/16S 104JTH	J24189049		1-	A	D3
R 1182	CHIP RES.	47k	1/16W	5%	RMC1/16S 473JTH	J24189045		1-	B	b3
R 1183	CHIP RES.	100k	1/16W	0.5%	RR0510R-104-D	J24189167		1-	A	F2
R 1184	CHIP RES.	100k	1/16W	0.5%	RR0510R-104-D	J24189167		1-	A	F2
R 1185	CHIP RES.	100k	1/16W	0.5%	RR0510R-104-D	J24189167		1-	A	G2
R 1186	CHIP RES.	100k	1/16W	0.5%	RR0510R-104-D	J24189167		1-	A	G2
R 1187	CHIP RES.	1k	1/16W	5%	RMC1/16S 102JTH	J24189025		1-	A	G3
R 1188	CHIP RES.	560	1/16W	5%	RMC1/16S 561JTH	J24189022		1-	B	a3
R 1189	CHIP RES.	470	1/16W	5%	RMC1/16S 471JTH	J24189021		1-	B	a3
R 1190	CHIP RES.	22	1/16W	5%	RMC1/16S 220JTH	J24189005		1-	B	g3
R 1191	CHIP RES.	22	1/16W	5%	RMC1/16S 220JTH	J24189005		1-	B	f3
R 1192	CHIP RES.	150	1/16W	5%	RMC1/16S 151JTH	J24189015		1-	A	F1
R 1193	CHIP RES.	22	1/16W	5%	RMC1/16S 220JTH	J24189005		1-	B	a3
R 1194	CHIP RES.	1k	1/16W	5%	RMC1/16S 102JTH	J24189025		1-	B	b3
R 1195	CHIP RES.	18k	1/16W	0.5%	RR0510R-183-D	J24189149		1-	B	a3
R 1197	CHIP RES.	22	1/16W	5%	RMC1/16S 220JTH	J24189005		1-	B	e1
R 1198	CHIP RES.	100	1/16W	5%	RMC1/16S 101JTH	J24189013		1-	B	e2
R 1199	CHIP RES.	47k	1/16W	5%	RMC1/16S 473JTH	J24189045		1-	B	e2
R 1200	CHIP RES.	47k	1/16W	5%	RMC1/16S 473JTH	J24189045		1-	B	e2
R 1201	CHIP RES.	47k	1/16W	5%	RMC1/16S 473JTH	J24189045		1-	B	e2
R 1202	CHIP RES.	22k	1/16W	5%	RMC1/16S 223JTH	J24189041		1-	B	e2
R 1203	CHIP RES.	100k	1/16W	5%	RMC1/16S 104JTH	J24189049		1-	B	e2
R 1204	CHIP RES.	220k	1/16W	5%	RMC1/16S 224JTH	J24189053		1-	B	e2
R 1205	CHIP RES.	100	1/16W	5%	RMC1/16S 101JTH	J24189013		1-	B	e1
R 1206	CHIP RES.	330k	1/16W	5%	RMC1/16S 334JTH	J24189055		1-	B	a2
R 1207	CHIP RES.	820k	1/16W	5%	RMC1/16S 824JTH	J24189060		1-	B	e2
R 1208	CHIP RES.	100k	1/16W	5%	RMC1/16S 104JTH	J24189049		1-	B	e1
R 1209	CHIP RES.	47	1/16W	5%	RMC1/16S 470JTH	J24189009		1-	B	e1
R 1210	CHIP RES.	10k	1/16W	5%	RMC1/16S 103JTH	J24189037		1-	B	e1
R 1211	CHIP RES.	100	1/16W	5%	RMC1/16S 101JTH	J24189013		1-	B	e2
R 1212	CHIP RES.	680	1/16W	5%	RMC1/16S 681JTH	J24189023		1-	B	f2
R 1213	CHIP RES.	470	1/16W	5%	RMC1/16S 471JTH	J24189021		1-	B	f2
R 1214	CHIP RES.	330	1/16W	5%	RMC1/16S 331JTH	J24189019		1-	B	e2
R 1215	CHIP RES.	2.2k	1/16W	5%	RMC1/16S 222JTH	J24189029		1-	B	e2

MAIN Unit

Parts List

REF	DESCRIPTION	VALUE	V/W	TOL.	MFR'S DESIG	VXSTD P/N	VERS.	LOT	SIDE	LAY ADR
R 1216	CHIP RES.	2.2k	1/16W	5%	RMC1/16S 222JTH	J24189029		1-	B	e3
R 1217	CHIP RES.	68k	1/16W	5%	RMC1/16S 683JTH	J24189047		1-	B	e1
R 1218	CHIP RES.	820k	1/16W	5%	RMC1/16S 824JTH	J24189060		1-	B	f1
R 1219	CHIP RES.	470k	1/16W	5%	RMC1/16S 474JTH	J24189057		1-	B	e1
R 1220	CHIP RES.	47k	1/16W	5%	RMC1/16S 473JTH	J24189045		1-	B	e1
R 1221	CHIP RES.	330k	1/16W	5%	RMC1/16S 334JTH	J24189055		1-	B	e1
R 1222	CHIP RES.	330k	1/16W	5%	RMC1/16S 334JTH	J24189055		1-	B	f1
R 1223	CHIP RES.	100k	1/16W	5%	RMC1/16S 104JTH	J24189049		1-	B	f2
R 1224	CHIP RES.	100k	1/16W	5%	RMC1/16S 104JTH	J24189049		1-	B	f2
R 1225	CHIP RES.	100k	1/16W	5%	RMC1/16S 104JTH	J24189049		1-	B	f2
R 1226	CHIP RES.	3.3k	1/16W	5%	RMC1/16S 332JTH	J24189031		1-	B	f2
R 1227	CHIP RES.	220k	1/16W	5%	RMC1/16S 224JTH	J24189053		1-	B	f2
R 1228	CHIP RES.	1M	1/16W	5%	RMC1/16S 105JTH	J24189061		1-	B	f2
R 1229	CHIP RES.	1k	1/16W	5%	RMC1/16S 102JTH	J24189025		1-	B	f2
R 1230	CHIP RES.	2.2k	1/16W	5%	RMC1/16S 222JTH	J24189029		1-	B	g2
R 1231	CHIP RES.	2.2k	1/16W	5%	RMC1/16S 222JTH	J24189029		1-	B	g1
R 1232	CHIP RES.	4.7k	1/16W	5%	RMC1/16S 472JTH	J24189033		1-	B	g1
R 1233	CHIP RES.	150k	1/16W	5%	RMC1/16S 154JTH	J24189051		1-	B	g2
R 1234	CHIP RES.	220	1/16W	5%	RMC1/16S 221JTH	J24189017		1-	B	f2
R 1235	CHIP RES.	4.7k	1/16W	5%	RMC1/16S 472JTH	J24189033		1-	B	g2
R 1236	CHIP RES.	1M	1/16W	5%	RMC1/16S 105JTH	J24189061		1-	B	g2
R 1237	CHIP RES.	4.7k	1/16W	5%	RMC1/16S 472JTH	J24189033		1-	B	g2
R 1238	CHIP RES.	1k	1/16W	5%	RMC1/16S 102JTH	J24189025		1-	B	g3
R 1239	CHIP RES.	1k	1/16W	5%	RMC1/16S 102JTH	J24189025		1-	B	g3
R 1240	CHIP RES.	1M	1/16W	5%	RMC1/16S 105JTH	J24189061		1-	B	g3
R 1241	CHIP RES.	220	1/16W	5%	RMC1/16S 221JTH	J24189017		1-	B	g3
R 1242	CHIP RES.	4.7k	1/16W	5%	RMC1/16S 472JTH	J24189033		1-	B	g3
R 1243	CHIP RES.	330k	1/16W	5%	RMC1/16S 334JTH	J24189055		1-	B	g3
R 1244	CHIP RES.	100	1/16W	5%	RMC1/16S 101JTH	J24189013		1-	B	g3
R 1245	CHIP RES.	220k	1/16W	5%	RMC1/16S 224JTH	J24189053		1-	B	g3
R 1246	CHIP RES.	47k	1/16W	5%	RMC1/16S 473JTH	J24189045		1-	B	g3
R 1247	CHIP RES.	1k	1/16W	5%	RMC1/16S 102JTH	J24189025		1-	B	g3
R 1248	CHIP RES.	47k	1/16W	5%	RMC1/16S 473JTH	J24189045		1-	B	g3
R 1249	CHIP RES.	47k	1/16W	5%	RMC1/16S 473JTH	J24189045		1-	B	f3
R 1250	CHIP RES.	100	1/16W	5%	RMC1/16S 101JTH	J24189013		1-	B	e1
R 1251	CHIP RES.	2.2k	1/16W	5%	RMC1/16S 222JTH	J24189029		1-	B	e1
R 1252	CHIP RES.	100	1/16W	5%	RMC1/16S 101JTH	J24189013		1-	B	e1
R 1253	CHIP RES.	1k	1/16W	5%	RMC1/16S 102JTH	J24189025		1-	B	g1
R 1254	CHIP RES.	3.3k	1/16W	5%	RMC1/16S 332JTH	J24189031		1-	B	g1
R 1255	CHIP RES.	3.3k	1/16W	5%	RMC1/16S 332JTH	J24189031		1-	B	g1
R 1256	CHIP RES.	22k	1/16W	5%	RMC1/16S 223JTH	J24189041		1-	B	g1
R 1257	CHIP RES.	47	1/16W	5%	RMC1/16S 470JTH	J24189009		1-	B	g1
R 1258	CHIP RES.	100	1/16W	5%	RMC1/16S 101JTH	J24189013		1-	B	f1
R 1259	CHIP RES.	470	1/16W	5%	RMC1/16S 471JTH	J24189021		1-	B	f1
R 1260	CHIP RES.	100	1/16W	5%	RMC1/16S 101JTH	J24189013		1-	B	f1
R 1261	CHIP RES.	560	1/16W	5%	RMC1/16S 561JTH	J24189022		1-	B	f1
R 1262	CHIP RES.	330k	1/16W	5%	RMC1/16S 334JTH	J24189055		1-	B	f1
R 1263	CHIP RES.	47k	1/16W	5%	RMC1/16S 473JTH	J24189045		1-	B	g3
R 1264	CHIP RES.	1k	1/16W	5%	RMC1/16S 102JTH	J24189025		1-	B	a2
R 1265	CHIP RES.	47	1/16W	5%	RMC1/16S 470JTH	J24189009		1-	A	D1
R 1266	CHIP RES.	10k	1/16W	5%	RMC1/16S 103JTH	J24189037		1-	A	C3
R 1267	CHIP RES.	47k	1/16W	5%	RMC1/16S 473JTH	J24189045		1-	A	D3
R 1268	CHIP RES.	3.3k	1/16W	5%	RMC1/16S 332JTH	J24189031		1-	B	d3
R 1269	CHIP RES.	47k	1/16W	5%	RMC1/16S 473JTH	J24189045		1-	A	D3
R 1270	CHIP RES.	47k	1/16W	5%	RMC1/16S 473JTH	J24189045		1-	A	C3
R 1272	CHIP RES.	100k	1/16W	5%	RMC1/16S 104JTH	J24189049		1-	A	D3
R 1273	CHIP RES.	2.2k	1/16W	5%	RMC1/16S 222JTH	J24189029		1-	A	D3
R 1274	CHIP RES.	100k	1/16W	5%	RMC1/16S 104JTH	J24189049		1-	A	D3
R 1275	CHIP RES.	2.2k	1/16W	5%	RMC1/16S 222JTH	J24189029		1-	A	D3
R 1276	CHIP RES.	100k	1/16W	5%	RMC1/16S 104JTH	J24189049		1-	A	C2
R 1277	CHIP RES.	470k	1/16W	5%	RMC1/16S 474JTH	J24189057		1-	A	C2
R 1278	CHIP RES.	100	1/16W	5%	RMC1/16S 101JTH	J24189013		1-	B	d2
R 1279	CHIP RES.	100	1/16W	5%	RMC1/16S 101JTH	J24189013		1-	B	d2
R 1280	CHIP RES.	330k	1/16W	5%	RMC1/16S 334JTH	J24189055		1-	B	d2
R 1281	CHIP RES.	220	1/16W	5%	RMC1/16S 221JTH	J24189017		1-	B	d2
R 1282	CHIP RES.	2.2k	1/16W	5%	RMC1/16S 222JTH	J24189029		1-	B	d2
R 1283	CHIP RES.	22k	1/16W	5%	RMC1/16S 223JTH	J24189041		1-	B	d2
R 1284	CHIP RES.	15k	1/16W	5%	RMC1/16S 153JTH	J24189039		1-	B	d2
R 1285	CHIP RES.	470	1/16W	5%	RMC1/16S 471JTH	J24189021		1-	B	d2
R 1286	CHIP RES.	470	1/16W	5%	RMC1/16S 471JTH	J24189021		1-	B	d2
R 1287	CHIP RES.	470	1/16W	5%	RMC1/16S 471JTH	J24189021		1-	B	d2
R 1288	CHIP RES.	100k	1/16W	5%	RMC1/16S 104JTH	J24189049		1-	B	d2
R 1289	CHIP RES.	47	1/16W	5%	RMC1/16S 470JTH	J24189009		1-	B	e1

MAIN Unit

Parts List

REF	DESCRIPTION	VALUE	V/W	TOL.	MFR'S DESIG	VXSTD P/N	VERS.	LOT	SIDE	LAY ADR
R 1290	CHIP RES.	10k	1/16W	5%	RMC1/16S 103JTH	J24189037		1-	B	e1
R 1291	CHIP RES.	2.2k	1/16W	5%	RMC1/16S 222JTH	J24189029		1-	B	d2
R 1292	CHIP RES.	2.2k	1/16W	5%	RMC1/16S 222JTH	J24189029		1-	B	d2
R 1293	CHIP RES.	100k	1/16W	5%	RMC1/16S 104JTH	J24189049		1-	B	d2
R 1294	CHIP RES.	220	1/16W	5%	RMC1/16S 221JTH	J24189017		1-	B	d2
R 1295	CHIP RES.	22k	1/16W	5%	RMC1/16S 223JTH	J24189041		1-	B	d2
R 1296	CHIP RES.	15k	1/16W	5%	RMC1/16S 153JTH	J24189039		1-	B	d2
R 1297	CHIP RES.	680	1/16W	5%	RMC1/16S 681JTH	J24189023		1-	B	d2
R 1298	CHIP RES.	220k	1/16W	5%	RMC1/16S 224JTH	J24189053		1-	B	d2
R 1299	CHIP RES.	470	1/16W	5%	RMC1/16S 471JTH	J24189021		1-	B	d2
R 1300	CHIP RES.	220	1/16W	5%	RMC1/16S 221JTH	J24189017		1-	B	d2
R 1301	CHIP RES.	47	1/16W	5%	RMC1/16S 470JTH	J24189009		1-	B	d1
R 1302	CHIP RES.	10k	1/16W	5%	RMC1/16S 103JTH	J24189037		1-	B	d1
R 1303	CHIP RES.	47	1/16W	5%	RMC1/16S 470JTH	J24189009		1-	B	d1
R 1304	CHIP RES.	47	1/16W	5%	RMC1/16S 470JTH	J24189009		1-3	A	C1
R 1304	CHIP RES.	100	1/16W	5%	RMC1/16S 101JTH	J24189013	W/ CE	4-	A	C1
R 1304	CHIP RES.	47	1/16W	5%	RMC1/16S 470JTH	J24189009	W/O CE	4-	A	C1
R 1305	CHIP RES.	150	1/16W	5%	RMC1/16S 151JTH	J24189015		1-	B	d1
R 1306	CHIP RES.	680	1/16W	5%	RMC1/16S 681JTH	J24189023		1-	B	d1
R 1307	CHIP RES.	470	1/16W	5%	RMC1/16S 471JTH	J24189021		1-	B	d1
R 1308	CHIP RES.	330	1/16W	5%	RMC1/16S 331JTH	J24189019		1-	B	c1
R 1309	CHIP RES.	4.7k	1/16W	5%	RMC1/16S 472JTH	J24189033		1-	B	d1
R 1310	CHIP RES.	22k	1/16W	5%	RMC1/16S 223JTH	J24189041		1-	B	d1
R 1311	CHIP RES.	220	1/16W	5%	RMC1/16S 221JTH	J24189017		1-	B	c1
R 1312	CHIP RES.	100	1/16W	5%	RMC1/16S 101JTH	J24189013		1-	B	c1
R 1313	CHIP RES.	1k	1/16W	5%	RMC1/16S 102JTH	J24189025		1-	A	D2
R 1314	CHIP RES.	470	1/16W	5%	RMC1/16S 471JTH	J24189021		1-	B	e1
R 1315	CHIP RES.	1k	1/16W	5%	RMC1/16S 102JTH	J24189025		1-	A	D2
R 1316	CHIP RES.	1k	1/16W	5%	RMC1/16S 102JTH	J24189025		1-	A	D1
R 1317	CHIP RES.	1k	1/16W	5%	RMC1/16S 102JTH	J24189025		1-	B	c1
R 1318	CHIP RES.	15k	1/16W	5%	RMC1/16S 153JTH	J24189039		1-	A	D1
R 1319	CHIP RES.	10k	1/16W	5%	RMC1/16S 103JTH	J24189037		1-	B	c1
R 1320	CHIP RES.	18k	1/16W	0.5%	RR0510R-183-D	J24189149		1-	A	C3
R 1321	CHIP RES.	47	1/16W	5%	RMC1/16S 470JTH	J24189009		1-	A	D1
R 1322	CHIP RES.	680	1/16W	5%	RMC1/16S 681JTH	J24189023		1-	A	E1
R 1323	CHIP RES.	470	1/16W	5%	RMC1/16S 471JTH	J24189021		1-	A	D1
R 1324	CHIP RES.	33k	1/16W	5%	RMC1/16S 333JTH	J24189043		1-	A	D1
R 1325	CHIP RES.	10k	1/16W	5%	RMC1/16S 103JTH	J24189037		1-	A	D1
R 1326	CHIP RES.	220	1/16W	5%	RMC1/16S 221JTH	J24189017		1-	A	F1
R 1327	CHIP RES.	220	1/16W	5%	RMC1/16S 221JTH	J24189017		1	B	b1
R 1327	CHIP RES.	150	1/16W	5%	RMC1/16S 151JTH	J24189015		2-	B	b1
R 1328	CHIP RES.	10k	1/16W	5%	RMC1/16S 103JTH	J24189037		1-	A	F1
R 1329	CHIP RES.	10k	1/16W	5%	RMC1/16S 103JTH	J24189037		1-	A	F1
R 1330	CHIP RES.	10k	1/16W	5%	RMC1/16S 103JTH	J24189037		1-	A	G1
R 1331	CHIP RES.	10k	1/16W	5%	RMC1/16S 103JTH	J24189037		1-	A	G1
R 1332	CHIP RES.	47k	1/16W	5%	RMC1/16S 473JTH	J24189045		1-	B	a2
R 1333	CHIP RES.	220	1/16W	5%	RMC1/16S 221JTH	J24189017		1-	B	b1
R 1336	CHIP RES.	10k	1/16W	5%	RMC1/16S 103JTH	J24189037		1-	A	F2
R 1337	CHIP RES.	10k	1/16W	5%	RMC1/16S 103JTH	J24189037		1-	A	F1
R 1338	CHIP RES.	47k	1/16W	5%	RMC1/16S 473JTH	J24189045		1-	A	C3
R 1339	CHIP RES.	100	1/16W	5%	RMC1/16S 101JTH	J24189013		1-	A	C1
R 1340	CHIP RES.	1k	1/16W	5%	RMC1/16S 102JTH	J24189025		1-	A	C1
R 1341	CHIP RES.	470k	1/16W	5%	RMC1/16S 474JTH	J24189057		1-	A	C1
R 1342	CHIP RES.	100	1/16W	5%	RMC1/16S 101JTH	J24189013		1-	A	C2
R 1343	CHIP RES.	100	1/16W	5%	RMC1/16S 101JTH	J24189013		1-	A	D2
R 1344	CHIP RES.	100	1/16W	5%	RMC1/16S 101JTH	J24189013		1-	A	D2
R 1345	CHIP RES.	330k	1/16W	5%	RMC1/16S 334JTH	J24189055		1-	A	D2
R 1346	CHIP RES.	100	1/16W	5%	RMC1/16S 101JTH	J24189013		1-	A	D1
R 1347	CHIP RES.	100	1/16W	5%	RMC1/16S 101JTH	J24189013		1-	A	E2
R 1348	CHIP RES.	22	1/16W	5%	RMC1/16S 220JTH	J24189005		1-	A	E2
R 1349	CHIP RES.	220k	1/16W	5%	RMC1/16S 224JTH	J24189053		1-	A	E2
R 1350	CHIP RES.	150	1/16W	5%	RMC1/16S 151JTH	J24189015		1-	B	e1
R 1351	CHIP RES.	220k	1/16W	5%	RMC1/16S 224JTH	J24189053		1-	B	e1
R 1352	CHIP RES.	39k	1/16W	5%	RMC1/16S 393JTH	J24189044		1-	B	e1
R 1353	CHIP RES.	68k	1/16W	5%	RMC1/16S 683JTH	J24189047		1-	B	e1
R 1354	CHIP RES.	100k	1/16W	5%	RMC1/16S 104JTH	J24189049		1-	B	e1
R 1355	CHIP RES.	100k	1/16W	5%	RMC1/16S 104JTH	J24189049		1-	B	d1
R 1356	CHIP RES.	100k	1/16W	5%	RMC1/16S 104JTH	J24189049		1-	B	d1
R 1357	CHIP RES.	10	1/16W	5%	RMC1/16S 100JTH	J24189001		1-	A	D1
R 1359	CHIP RES.	100k	1/16W	5%	RMC1/16S 104JTH	J24189049		1-	A	D1
R 1360	CHIP RES.	22k	1/16W	5%	RMC1/16S 223JTH	J24189041		1-	B	c1
R 1361	CHIP RES.	100k	1/16W	5%	RMC1/16S 104JTH	J24189049		1-	A	E1
R 1362	CHIP RES.	47	1/16W	5%	RMC1/16S 470JTH	J24189009		1-	A	D1

MAIN Unit

Parts List

REF	DESCRIPTION	VALUE	V/W	TOL.	MFR'S DESIG	VXSTD P/N	VERS.	LOT	SIDE	LAY ADR
R 1363	CHIP RES.	330	1/16W	5%	RMC1/16S 331JTH	J24189019		1-	A	C1
R 1364	CHIP RES.	1k	1/16W	5%	RMC1/16S 102JTH	J24189025		1-	A	C1
R 1365	CHIP RES.	470k	1/16W	5%	RMC1/16S 474JTH	J24189057		1-	A	C1
R 1366	CHIP RES.	100	1/16W	5%	RMC1/16S 101JTH	J24189013		1-9		
R 1367	CHIP RES.	4.7k	1/16W	5%	RMC1/16S 472JTH	J24189033		1-9		
R 1368	CHIP RES.	100k	1/16W	5%	RMC1/16S 104JTH	J24189049		1-	A	D1
R 1369	CHIP RES.	100k	1/16W	5%	RMC1/16S 104JTH	J24189049		1-	B	c2
R 1370	CHIP RES.	47k	1/16W	5%	RMC1/16S 473JTH	J24189045		1-	A	C3
R 1371	CHIP RES.	47k	1/16W	5%	RMC1/16S 473JTH	J24189045		1-	A	C3
R 1372	CHIP RES.	47k	1/16W	5%	RMC1/16S 473JTH	J24189045		1-	B	e2
R 1373	CHIP RES.	47k	1/16W	5%	RMC1/16S 473JTH	J24189045		1-	A	D2
R 1374	CHIP RES.	150	1/16W	5%	RMC1/16S 151JTH	J24189015		1-	A	C2
R 1375	CHIP RES.	220k	1/16W	5%	RMC1/16S 224JTH	J24189053		1-	A	C2
R 1376	CHIP RES.	47k	1/16W	5%	RMC1/16S 473JTH	J24189045		1-	A	C2
R 1377	CHIP RES.	39k	1/16W	5%	RMC1/16S 393JTH	J24189044		1-	A	C2
R 1378	CHIP RES.	100k	1/16W	5%	RMC1/16S 104JTH	J24189049		1-	A	C2
R 1379	CHIP RES.	100k	1/16W	5%	RMC1/16S 104JTH	J24189049		1-	A	D2
R 1380	CHIP RES.	100k	1/16W	5%	RMC1/16S 104JTH	J24189049		1-	A	D2
R 1381	CHIP RES.	100	1/16W	5%	RMC1/16S 101JTH	J24189013		1-	B	c2
R 1382	CHIP RES.	2.2k	1/16W	5%	RMC1/16S 222JTH	J24189029		1-	B	c2
R 1383	CHIP RES.	100	1/16W	5%	RMC1/16S 101JTH	J24189013		1-	B	c2
R 1384	CHIP RES.	47	1/16W	5%	RMC1/16S 470JTH	J24189009		1-	B	c1
R 1385	CHIP RES.	330k	1/16W	5%	RMC1/16S 334JTH	J24189055		1-	B	c2
R 1386	CHIP RES.	47k	1/16W	5%	RMC1/16S 473JTH	J24189045		1-	B	c1
R 1387	CHIP RES.	3.3k	1/16W	5%	RMC1/16S 332JTH	J24189031		1-	B	c2
R 1388	CHIP RES.	3.3k	1/16W	5%	RMC1/16S 332JTH	J24189031		1-	B	b2
R 1389	CHIP RES.	470	1/16W	5%	RMC1/16S 471JTH	J24189021		1-	A	C2
R 1390	CHIP RES.	1k	1/16W	5%	RMC1/16S 102JTH	J24189025		1-	A	C2
R 1391	CHIP RES.	470	1/16W	5%	RMC1/16S 471JTH	J24189021		1-	A	C2
R 1392	CHIP RES.	22	1/16W	5%	RMC1/16S 220JTH	J24189005		1-	A	C2
R 1393	CHIP RES.	470k	1/16W	5%	RMC1/16S 474JTH	J24189057		1-	A	C2
R 1394	CHIP RES.	100	1/16W	5%	RMC1/16S 101JTH	J24189013		1-	A	D2
R 1395	CHIP RES.	470	1/16W	5%	RMC1/16S 471JTH	J24189021		1-	A	D2
R 1396	CHIP RES.	47	1/16W	5%	RMC1/16S 470JTH	J24189009		1-	A	D2
R 1397	CHIP RES.	150	1/16W	5%	RMC1/16S 151JTH	J24189015		1-	B	c2
R 1398	CHIP RES.	100k	1/16W	5%	RMC1/16S 104JTH	J24189049		1-	B	c2
R 1399	CHIP RES.	470k	1/16W	5%	RMC1/16S 474JTH	J24189057		1-	B	c2
R 1400	CHIP RES.	100k	1/16W	5%	RMC1/16S 104JTH	J24189049		1-	B	c2
R 1401	CHIP RES.	3.3k	1/16W	5%	RMC1/16S 332JTH	J24189031		1-	B	c2
R 1402	CHIP RES.	1k	1/16W	5%	RMC1/16S 102JTH	J24189025		1-	A	D1
R 1403	CHIP RES.	100	1/16W	5%	RMC1/16S 101JTH	J24189013		1-	B	a2
R 1404	CHIP RES.	100	1/16W	5%	RMC1/16S 101JTH	J24189013		1-	B	a2
R 1405	CHIP RES.	470k	1/16W	5%	RMC1/16S 474JTH	J24189057		1-	B	a2
R 1406	CHIP RES.	4.7k	1/16W	5%	RMC1/16S 472JTH	J24189033		1-	B	a2
R 1407	CHIP RES.	100k	1/16W	5%	RMC1/16S 104JTH	J24189049		1-	B	c2
R 1408	CHIP RES.	1M	1/16W	5%	RMC1/16S 105JTH	J24189061		1-	A	E2
R 1409	CHIP RES.	1.5M	1/16W	5%	RMC1/16S 155JTH	J24189063		1-	A	E3
R 1410	CHIP RES.	100k	1/16W	5%	RMC1/16S 104JTH	J24189049		1-	A	E3
R 1411	CHIP RES.	100k	1/16W	5%	RMC1/16S 104JTH	J24189049		1-	A	E2
R 1412	CHIP RES.	330k	1/16W	5%	RMC1/16S 334JTH	J24189055		1-	A	E2
R 1413	CHIP RES.	330	1/16W	5%	RMC1/16S 331JTH	J24189019		1-	B	f1
R 1414	CHIP RES.	100	1/16W	5%	RMC1/16S 101JTH	J24189013		1-	A	D3
R 1415	CHIP RES.	470k	1/16W	5%	RMC1/16S 474JTH	J24189057		1-	B	f1
R 1416	CHIP RES.	47k	1/16W	5%	RMC1/16S 473JTH	J24189045		1-	A	F3
R 1417	CHIP RES.	47k	1/16W	5%	RMC1/16S 473JTH	J24189045		1-	A	F3
R 1418	CHIP RES.	470	1/16W	5%	RMC1/16S 471JTH	J24189021		1-	B	b1
R 1419	CHIP RES.	0	1/16W	5%	RMC1/16S JPTH	J24189070		1-	B	b2
R 1420	CHIP RES.	1M	1/16W	5%	RMC1/16S 105JTH	J24189061		1-	B	a2
R 1421	CHIP RES.	3.3k	1/16W	0.5%	RR0510P-332-D	J24189131		1-	B	d3
R 1422	CHIP RES.	4.7k	1/16W	5%	RMC1/16S 472JTH	J24189033		1-	A	C3
R 1423	CHIP RES.	4.7k	1/16W	5%	RMC1/16S 472JTH	J24189033		1-	B	c4
R 1424	CHIP RES.	47k	1/16W	5%	RMC1/16S 473JTH	J24189045		1-	A	D1
R 1425	CHIP RES.	47k	1/16W	5%	RMC1/16S 473JTH	J24189045		1-	B	e1
R 1426	CHIP RES.	47k	1/16W	5%	RMC1/16S 473JTH	J24189045		1-	A	D2
R 1427	CHIP RES.	1k	1/16W	5%	RMC1/16S 102JTH	J24189025		1-	B	e4
R 1428	CHIP RES.	1k	1/16W	5%	RMC1/16S 102JTH	J24189025		1-	A	F2
R 1429	CHIP RES.	1k	1/16W	5%	RMC1/16S 102JTH	J24189025		1-	A	G4
R 1430	CHIP RES.	0	1/16W	5%	RMC1/16S JPTH	J24189070		1-	B	d4
R 1431	CHIP RES.	1k	1/16W	5%	RMC1/16S 102JTH	J24189025		6-	A	E3
R 1432	CHIP RES.	100k	1/16W	5%	RMC1/16S 104JTH	J24189049		4-	B	f3
R 1433	CHIP RES.	33k	1/16W	5%	RMC1/16S 333JTH	J24189043		4-	B	f3
S 1002	TACT SWITCH				EVQP4403M	N5090132		1-	A	F1
S 1003	TACT SWITCH				EVQP4403M	N5090132		1-	A	E1

MAIN Unit

Parts List

REF	DESCRIPTION	VALUE	V/W	TOL.	MFR'S DESIG	VXSTD P/N	VERS.	LOT	SIDE	LAY ADR
S 1004	TACT SWITCH				EVQP4403M	N5090132		1-	A	D1
TH1001	THERMISTOR				TBPS1R473K475H5Q	G9090068		1-	A	E2
TH1002	THERMISTOR				TBPS1R103K440H5Q	G9090067		1-	B	f1
TH1003	THERMISTOR				TBPS1R104K475H5Q	G9090069		1-	B	f1
X 1001	XTAL TRS-4.0	4MHz			4.000MHZ	H0103283		1-	B	b3
X 1001	XTL XJNGGIDANF	4MHz			4.000000MHZ	H0103314		31-	B	b3
X 1002	XTAL TSS-6	11.7MHz			TSS-5032A 11.7MHZ	H0103264		1-	B	e2
XF1001	XTAL FILTER				MFT47R 47.25MHZ	H1102352		1-	B	f1
	HOLDER					RA0595200		1-		
	TERMINAL PLATE R					RA010700A		1-		
	TERMINAL PLATE				(ANT)	RA0322800		1-		
	LCD HOLDER					RA032090B		1-		
	REFLECTOR SHEET					RA0324800		1-		
	INTER CONNECTOR				(LCD)	RA0324700		1-		
	INTER CONNECTOR				(PCB)	RA0211200		1-		
	SHIELD CASE					RA0595400		1-		
	TERMINAL PLATE					RA0210700		1-		
	HOLDER RUBBER				(MIC)	RA0110200		1-		
	SHIELD CASE COVER				(FET)	RA0641700	W/ CE	4-		
	SHIELD CASE COVER				(FET)	RA064170A	W/ CE	15-		
	SHIELD CASE COVER				(MIX)	RA0641800	W/ CE	4-		
	SHIELD CASE COVER				(MIX)	RA064180A	W/ CE	15-		

MAIN Unit

Parts List

VR Unit

Circuit Diagram

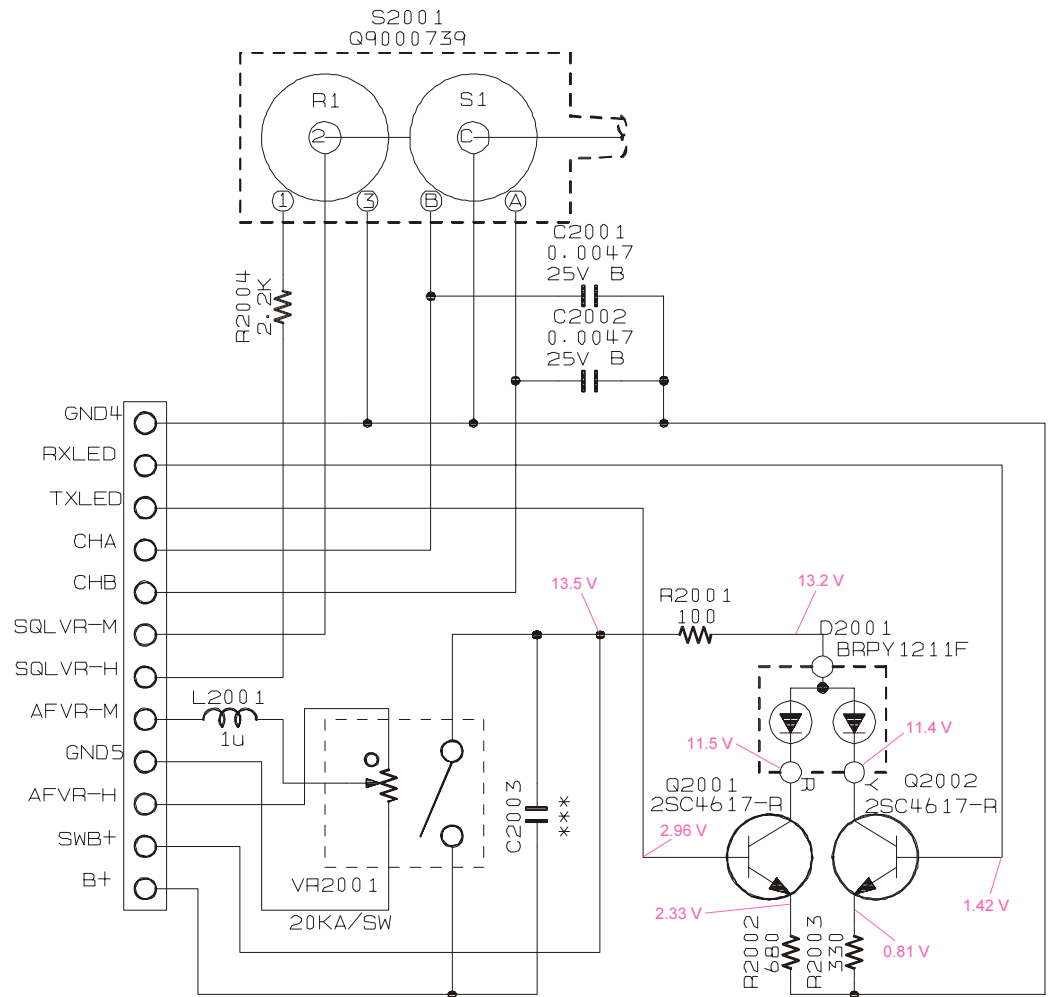

VR Unit

Parts Layout

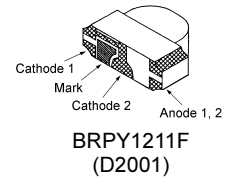
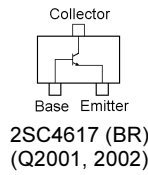
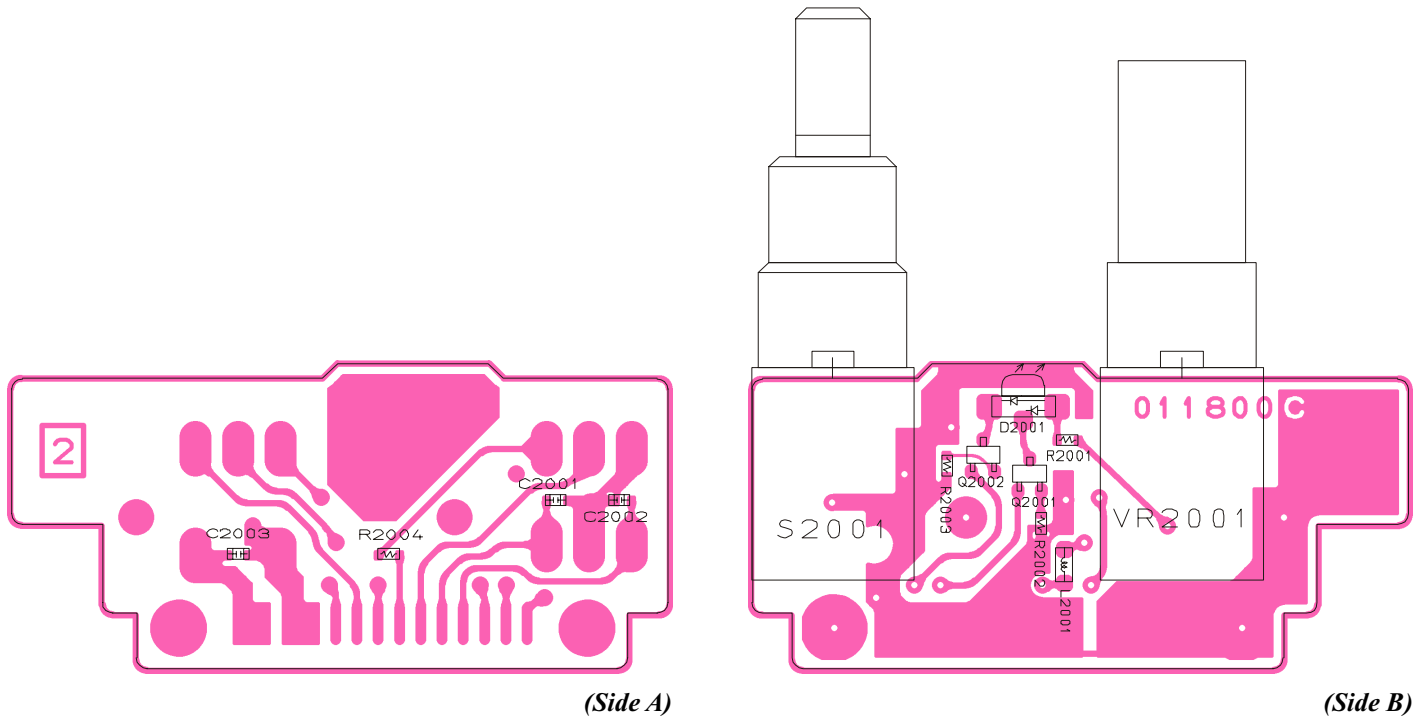

Parts List

REF	DESCRIPTION	VALUE	V/W	TOL.	MFR'S DESIG	VXSTD P/N	VERS.	LOT	SIDE	LAY ADR
	Printed Circuit Board				AH017M000	FR0118000		1-		
C 2001	CHIP CAP.	0.0047uF	25V	B	GRM36B472K25PT	K22148830		1-	A	
C 2002	CHIP CAP.	0.0047uF	25V	B	GRM36B472K25PT	K22148830		1-	A	
D 2001	LED				BRPY1211F-TR	G2070706		1-	B	
L 2001	M.RFC	1uH			LK1608 1R0K-T	L1690687		1-	B	
Q 2001	TRANSISTOR				2SC4617 TL R	G3346178R		1-	B	
Q 2002	TRANSISTOR				2SC4617 TL R	G3346178R		1-	B	
R 2001	CHIP RES.	100	1/16W	5%	RMC1/16S 101JTH	J24189013		1-	B	
R 2002	CHIP RES.	680	1/16W	5%	RMC1/16S 681JTH	J24189023		1-	B	
R 2003	CHIP RES.	330	1/16W	5%	RMC1/16S 331JTH	J24189019		1-	B	
R 2004	CHIP RES.	2.2k	1/16W	5%	RMC1/16S 222JTH	J24189029		1-	A	
S 2001	ROTARY ENCODER				TP76D96E20	Q9000739		1-	B	
VR2001	POT.				TP76N00N 20KA/SW	J60800236		1-	B	



Copyright 2005
VERTEX STANDARD CO., LTD.
All rights reserved

No portion of this manual
may be reproduced without
the permission of
VERTEX STANDARD CO., LTD.