

KENWOOD

144/440 MHz FM DUAL BANDER

TM-V7A

144/430 MHz FM DUAL BANDER

TM-V7A

144/430 MHz FM DUAL BANDER

TM-V7E

INSTRUCTION MANUAL

KENWOOD CORPORATION

THANK YOU!

We are grateful you decided to purchase this **KENWOOD** FM transceiver. This series of mobile transceivers were developed to satisfy the requirement for a compact rig that's simple to operate yet contains numerous sophisticated features. The dual band operation will be appreciated by hams who want access to VHF and UHF bands with a transceiver smaller than some single banders.

KENWOOD believes that the compact size coupled with the reasonable cost will guarantee your satisfaction with this product.

MODELS COVERED BY THIS MANUAL

The models listed below are covered by this manual.

TM-V7A: 144/440 MHz FM Dual Bander
(U.S.A./ Canada)

TM-V7A: 144/430 MHz FM Dual Bander
(General market)

TM-V7E: 144/430 MHz FM Dual Bander
(Europe)

FEATURES

- Enhanced Programmable Memory (PM) channels store virtually entire current operating environments for your quick recall.
- A maximum of 280 memory channels are available, 140 each for VHF and UHF. Up to 180 memory channels can be assigned desired names.
- "Visual Scan" graphically and simultaneously shows the conditions of up to 147 frequency channels.
- The Dual Band RX feature allows two frequencies to be simultaneously received. Simultaneous RX configurations include VHF/UHF, VHF/VHF, and UHF/UHF.
- Transceiver Guide shows how to use the basic functions.
- A large, dot matrix LCD with alpha-numeric display capability is positive and negative reversible.
- Save space with the compact front panel which easily detaches from the main unit and can be mounted in a different place.
- The dedicated DATA connector is available for 1200 bps or 9600 bps Packet operation.
- A data transfer band is selectable separately from a voice communication band.

NOTICES TO THE USER

One or more of the following statements may be applicable:

FCC WARNING

This equipment generates or uses radio frequency energy. Changes or modifications to this equipment may cause harmful interference unless the modifications are expressly approved in the instruction manual. The user could lose the authority to operate this equipment if an unauthorized change or modification is made.

INFORMATION TO THE DIGITAL DEVICE USER REQUIRED BY THE FCC

This equipment has been tested and found to comply with the limits for a Class B digital device, pursuant to Part 15 of the FCC Rules. These limits are designed to provide reasonable protection against harmful interference in a residential installation.

This equipment generates, uses and can generate radio frequency energy and, if not installed and used in accordance with the instructions, may cause harmful interference to radio communications. However, there is no guarantee that the interference will not occur in a particular installation. If this equipment does cause harmful interference to radio or television reception, which can be determined by turning the equipment off and on, the user is encouraged to try to correct the interference by one or more of the following measures:

- Reorient or relocate the receiving antenna.
- Increase the separation between the equipment and receiver.
- Connect the equipment to an outlet on a circuit different from that to which the receiver is connected.
- Consult the dealer for technical assistance.

When condensation occurs inside the transceiver:

Condensation possibly occurs inside the transceiver in such a case where the room is warmed using a heater on cold days or where the transceiver is quickly moved from a cold room to a warm room. When condensation occurs, the microcomputer and/or the transmit/receive circuits may become unstable, resulting in transceiver malfunction. If this happens, turn OFF the transceiver and just wait for a while. When the condensed droplets disappear, the transceiver will function normally.

PRECAUTIONS

Please observe the following precautions to prevent fire, personal injury, and transceiver damage:

- When operating mobile, do not attempt to configure your transceiver while driving because it is simply too dangerous.
- Be aware of local laws pertaining to the use of headphones/headsets while driving on public roads. If in doubt, do not wear headphones while mobiling.
- Do not transmit with high output power for extended periods. The transceiver may overheat.
- Do not modify this transceiver unless instructed by this manual or by **KENWOOD** documentation.
- Do not expose the transceiver to long periods of direct sunlight nor place the transceiver close to heating appliances.
- Do not place the transceiver in excessively dusty areas, humid areas, wet areas, nor on unstable surfaces.
- If an abnormal odor or smoke is detected coming from the transceiver, turn OFF the power immediately. Contact a **KENWOOD** service station or your dealer.
- The transceiver is designed for a 13.8 V power source. Never use a 24 V battery to power the transceiver.

CONTENTS

SUPPLIED ACCESSORIES	1	SELECTING FREQUENCIES	17
CONVENTIONS FOLLOWED IN THIS MANUAL	1	Tuning Control	17
1 PREPERATION FOR MOBILE AND FIXED STATION OPERATION		Microphone [UP]/[DWN] Buttons	17
MOBILE INSTALLATION	2	TRANSMITTING	18
Installation Example	2	Selecting Output Power	18
Installation Steps	2	5 MENU SET-UP	
DC POWER CABLE CONNECTION	3	WHAT IS A MENU?	19
Mobile Operation	3	MENU ACCESS	19
Fixed Station Operation	4	MENU CONFIGURATION	20
Replacing Fuses	5	6 OPERATING THROUGH REPEATERS	
ANTENNA CONNECTION	5	REPEATER ACCESS	22
ACCESSORY CONNECTIONS	6	Selecting Offset Direction	23
External Speakers	6	Selecting Offset Frequency	24
Microphone	6	Activating Tone Function	24
PACKET EQUIPMENT CONNECTIONS	6	Selecting a Tone Frequency	25
2 YOUR FIRST QSO		Automatic Repeater Offset (U.S.A./ Canada/ Europe Only)	26
3 GETTING ACQUAINTED		REVERSE FUNCTION	27
BASIC TRANSCEIVER MODES	8	Automatic Simplex Checker (ASC)	27
BUTTON FUNCTION DISPLAY	9	7 MEMORY CHANNELS	
FRONT PANEL	10	SIMPLEX OR SPLIT MEMORY CHANNEL?	28
REAR PANEL	12	VHF/UHF MEMORY CHANNEL RATIO	29
MICROPHONE	13	STORING DATA IN SIMPLEX CHANNELS	30
INDICATORS	14	STORING DATA IN SPLIT CHANNELS	30
TRANSCEIVER GUIDE	15	RECALLING MEMORY CHANNELS	31
4 OPERATING BASICS		CLEARING MEMORY CHANNELS	31
SWITCHING POWER ON/OFF	16	NAMING MEMORY CHANNELS	32
ADJUSTING VOLUME	16	CALL CHANNEL	33
ADJUSTING SQUELCH	16	Recalling the Call Channel	33
SELECTING A BAND	16		

Changing Call Channel Contents (Simplex)	33	USING CTCSS	49	1
Changing Call Channel Contents (Split)	34	Automatic Tone Frequency ID	49	2
MEMORY → VFO TRANSFER	34	11 DUAL TONE SQUELCH SYSTEM (DTSS)		3
CHANNEL DISPLAY FUNCTION	34	STORING DTSS CODES	50	4
INITIALIZING MEMORY	35	USING DTSS	51	5
Partial Reset (VFO)	35	DTSS and Repeaters	52	6
Full Reset (Memory)	35	12 PAGE		7
8 PROGRAMMABLE MEMORY (PM)		PAGE CODE MEMORY	53	8
PROGRAMMABLE INFORMATION	36	STORING PAGE CODES	54	9
APPLICATION EXAMPLES	37	CALLING	55	10
STORING DATA IN PM CHANNELS	38	RECEIVING	55	11
RECALLING PM CHANNELS	38	Page and Repeaters	56	12
AUTO PM CHANNEL STORING	39	LOCKING OUT PAGE CODES	56	13
RESETTING PROGRAMMABLE MEMORY	39	AUTO PAGE CANCEL	57	14
9 SCAN		PAGE ANSWER BACK (U.S.A./ CANADA ONLY)	57	15
VISUAL SCAN	41	13 DUAL TONE MULTI-FREQUENCY (DTMF) FUNCTIONS		16
Selecting the Number of Channels	41	MAKING DTMF CALLS	58	17
Using Visual Scan	42	Autopatch (U.S.A. and Canada)	58	18
SCAN RESUME METHODS	43	Mic Keypad Confirmation Tones	58	19
Selecting Scan Resume Method	43	STORING DTMF NUMBERS FOR AUTOMATIC		20
VFO SCAN	44	DIALER	59	21
MEMORY SCAN	44	CONFIRMING STORED DTMF NUMBERS	60	
Locking Out Memory Channels	45	TRANSMITTING STORED DTMF NUMBERS	60	
PROGRAM SCAN	46	14 AUXILIARY FUNCTIONS		
Setting Scan Limits	46	TIME-OUT TIMER (TOT)	61	
Using Program Scan	47	AUTOMATIC POWER OFF (APO)	61	
MHz SCAN	47	AUTOMATIC BAND CHANGE (A.B.C.)	62	
CALL/VFO SCAN	48	ADVANCED INTERCEPT POINT (AIP)	62	
CALL/MEMORY SCAN	48	DUAL BAND RX	63	
10 CONTINUOUS TONE CODED SQUELCH SYSTEM (CTCSS)		BLANKING A BAND DISPLAY	63	

PROGRAMMABLE VFO	64	17 REPEATER FUNCTION (U.S.A/ CANADA ONLY)	
SWITCHING AM/FM MODE (SOME VERSIONS ONLY)	64	LOCKED-BAND REPEATER	81
CHANGING FREQUENCY STEP SIZE	65	CROSS-BAND REPEATER	81
CHANGING MULTI-FUNCTION BUTTON LABELS	66	TX HOLD	81
CHANGING BEEP VOLUME	66	18 VS-3 VOICE SYNTHESIZER (OPTIONAL)	
LOCK	67	19 OPTIONAL ACCESSORIES	
Transceiver Lock	67	20 INSTALLING OPTIONS	
All Lock	67	INSTALLING THE VS-3 VOICE SYNTHESIZER UNIT	84
S-METER SQUELCH	68	INSTALLING A DETACHABLE FRONT PANEL KIT (DFK-3C/ DFK-4C/ DFK-7C)	84
Squelch Hang Time	68	Installation Examples	86
POWER-ON MESSAGE	69	21 MAINTENANCE	
DISPLAY DEMONSTRATION MODE	69	GENERAL INFORMATION	87
CHANGING DISPLAY CONDITIONS	70	SERVICE	87
Display Dimmer	70	SERVICE NOTE	87
Auto Dimmer Change	70	CLEANING	87
Display Contrast	71	TROUBLESHOOTING	88
Positive/Negative Reversal	71	SPECIFICATIONS	
CONFIGURING PROGRAM FUNCTION KEYS	72	INDEX	
KEYPAD DIRECT ENTRY	74		
Operating Frequency Entry	74		
Memory Channel Number Entry	75		
Tone Frequency Number Entry	75		
CHANGING SPEAKER CONFIGURATIONS	76		
15 MICROPHONE CONTROL			
ACTIVATING MICROPHONE CONTROL	78		
16 PACKET OPERATION			
ACTIVATING DATA TX/RX BAND	79		
1200/ 9600 bps OPERATION	79		
DATA Connector Pin Functions	80		

SUPPLIED ACCESSORIES

Accessory	Part Number	Quantity
Microphone U.S.A./ Canada/ General (some): MC-53DM ¹ Europe/ General (some): MC-45 ¹	T91-0568-XX T91-0396-XX	1 1
DC power cable	E30-2111-XX	1
Transceiver fuse (15 A)	F51-0017-XX	1
Mounting bracket	J29-0632-XX	1
Mounting bracket screws	N99-0331-XX	1 set
Microphone hanger ² (U.S.A./ Canada only)	J19-1526-XX	1
Microphone hanger screws ² (U.S.A./ Canada only)	N46-3010-XX	2
Warranty card (U.S.A./ Canada/ Europe only)	—	1
Instruction manual	B62-0678-XX	1

¹ The MC-53DM and MC-45 microphones are also sold as optional accessories (page 83).

² Attach the microphone hanger at an appropriate position.

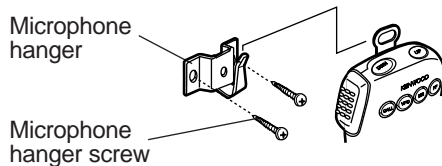

CONVENTIONS FOLLOWED IN THIS MANUAL

The writing conventions described below have been followed to simplify instructions and avoid unnecessary repetition.

ATTENTION: MOST PROCEDURES REQUIRE THAT YOU PRESS AN APPROPRIATE KEY IN EACH STEP WITHIN APPROXIMATELY 10 SECONDS, OR THE PREVIOUS MODE WILL BE RESTORED.

Instruction	What to do
Press [KEY] .	Press and release KEY .
Press [KEY] (1 s) .	Press and hold KEY until the function begins.
Press [KEY1], [KEY2] .	Press KEY1 momentarily, release KEY1 , then press KEY2 .
Press [KEY]+ POWER ON .	With transceiver power OFF, press and hold KEY , then turn ON the transceiver power by pressing [PWR] .
Press [F] (1 s), [KEY] .	Press and hold [F] for 1 second or longer, then press KEY .
Press [F], [KEY] (1 s) .	Press [F] momentarily, release [F] , then press and hold KEY for 1 second or longer.
Press [F] + [KEY] .	Press and hold [F] down, then press KEY .

MOBILE INSTALLATION

Install the transceiver in a safe, convenient position inside your vehicle that minimizes danger to your passengers and yourself while the vehicle is in motion. For example, consider installing the transceiver under the dash in front of the passenger seat so that knees or legs will not strike the radio during sudden braking of your vehicle. Try to pick a well-ventilated location that is shielded from direct sunlight.

■ Installation Example

Use the supplied mounting bracket to install the transceiver inside your vehicle. To enjoy the best viewing angle, you can position the transceiver in the bracket in a number of ways as shown below.

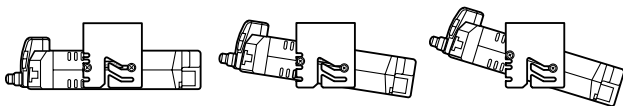

■ Installation Steps

- 1 Install the mounting bracket in the vehicle using the supplied flat washers and self-tapping screws. There are 4 washers and 4 screws supplied.
 - The bracket can be mounted with the bracket opening for the transceiver facing down for underdash mounting, or with the opening facing up.
 - The bracket must be installed so that the 4 screw holes on the edge of each bracket side are facing forward.

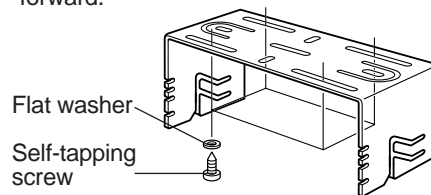

- 2 Position the transceiver, then insert and tighten the supplied hexagon SEMS screws and washers. There are 2 screws and 2 washers supplied for each side of the bracket.
 - Double check that all hardware is tightened to prevent vehicle vibration from loosening the bracket or transceiver.

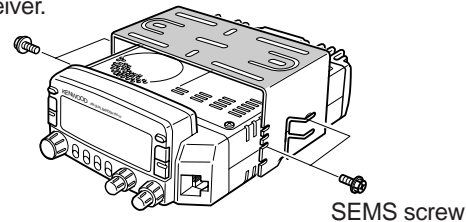

DC POWER CABLE CONNECTION

■ Mobile Operation

The vehicle battery must have a nominal rating of 12 V. Never connect the transceiver to a 24 V battery. Be sure to use a 12 V vehicle battery that has sufficient current capacity. If the current to the transceiver is insufficient, the display may darken during transmission, or transmit output power may drop excessively.

1 Route the DC power cable supplied with the transceiver directly to the vehicle's battery terminals using the shortest path from the transceiver.

- If using a noise filter, it should be installed with an insulator to prevent it from touching metal on the vehicle.
- It is not recommended to use the cigarette lighter socket since some cigarette lighter sockets introduce an unacceptable voltage drop.
- If the power cable must be routed through a hole in the vehicle chassis or body, for example in the firewall at the front of the passenger compartment, use a rubber grommet to protect the cable from abrasion. Dismantle the fuse holder to pass the cable through the firewall.

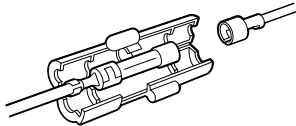

- The entire length of the cable must be dressed so it is isolated from heat and moisture.

- 2 After the cable is in place, wind heat-resistant tape around the fuse holder to protect it from moisture. Tie down the full run of cable.
- 3 To prevent the risk of short circuits, disconnect other wiring from the negative (-) battery terminal before connecting the transceiver.
- 4 Confirm the correct polarity of the connections, and attach the power cable to the battery terminals; red connects to the positive (+) terminal, black connects to the negative (-) terminal.

- Use the full length of the cable without cutting off excess even if the cable is longer than required. In particular, never remove the fuse holders from the cable.

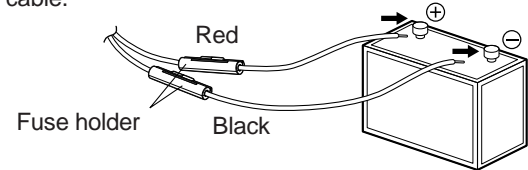

5 Reconnect any wiring removed from the negative terminal.

6 Connect the DC power cable to the transceiver's power supply connector.

- Press the connectors firmly together until the locking tab clicks.

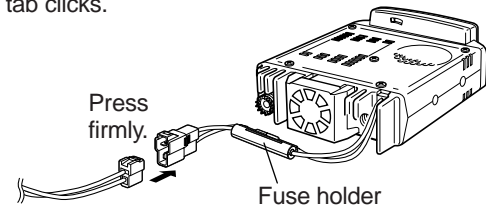

■ Fixed Station Operation

In order to use this transceiver for fixed station operation, you will need a separate 13.8 V DC power supply that must be purchased separately. The recommended current capacity of your power supply is 12 A.

- 1 Connect the DC power cable to the regulated DC power supply and check that polarities are correct (Red: positive, Black: negative).
 - DO NOT directly connect the transceiver to an AC outlet!
 - Use the supplied DC power cable to connect the transceiver to a regulated power supply.
 - Do not substitute a cable with smaller gauge wires.

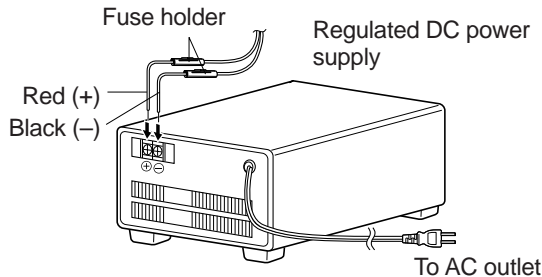

- 2 Connect the transceiver's DC power connector to the connector on the DC power cable.
 - Press the connectors firmly together until the locking tab clicks.

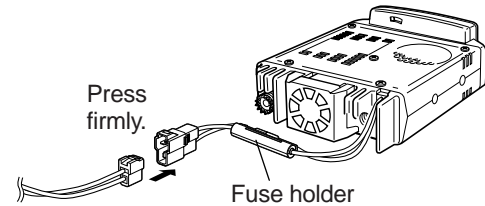

Note:

- ◆ For your transceiver to fully exhibit its performance capabilities, the following optional power supply is recommended: PS-33 (20.5 A, 25% duty cycle).
- ◆ Before connecting the DC power supply to the transceiver, be sure to switch the transceiver and the DC power supply OFF.
- ◆ Do not plug the DC power supply into an AC outlet until you make all connections.

■ Replacing Fuses

If the fuse blows, determine the cause then correct the problem. After the problem is resolved, then replace the fuse. If newly installed fuses continue to blow, disconnect the power cable and contact your dealer or the nearest Service Center for assistance.

Fuse Location	Fuse Current Rating
Transceiver	15 A
Supplied Accessory DC Power Cable	20 A

CAUTION: ONLY USE FUSES OF THE SPECIFIED TYPE AND RATING.

Note: If you use the transceiver for a long period when the vehicle battery is not fully charged, or when the engine is OFF, the battery may become discharged, and will not have sufficient reserves to start the vehicle. Avoid using the transceiver under these conditions.

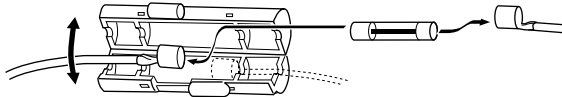

ANTENNA CONNECTION

Before operating, you must first install an efficient, well-tuned antenna. The success of your installation will depend largely on the type of antenna and its correct installation. The transceiver can give excellent results if the antenna system and its installation is given careful attention.

Your choice of antenna should have a 50 Ω impedance to match the transceiver input impedance. Use low-loss coaxial feed line that also has a characteristic impedance of 50 Ω . Coupling the antenna to the transceiver via feed lines having an impedance other than 50 Ω reduces the efficiency of the antenna system, and can cause interference to nearby broadcast television receivers, radio receivers, and other electronic equipment.

CAUTION:

- ◆ TRANSMITTING WITHOUT FIRST CONNECTING AN ANTENNA OR OTHER MATCHED LOAD MAY DAMAGE THE TRANSCEIVER. ALWAYS CONNECT THE ANTENNA TO THE TRANSCEIVER BEFORE TRANSMITTING.
- ◆ ALL FIXED STATIONS SHOULD BE EQUIPPED WITH A LIGHTNING ARRESTER TO REDUCE THE RISK OF FIRE, ELECTRIC SHOCK, AND TRANSCEIVER DAMAGE.

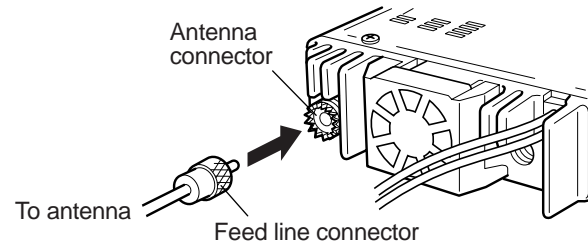

ACCESSORY CONNECTIONS

External Speakers

If you plan to use external speakers, choose speakers with an impedance of $8\ \Omega$. The external speaker jacks accept a 3.5 mm (1/8") diameter mono (2-conductor) plug. Recommended speakers include the SP-50B and SP-41.

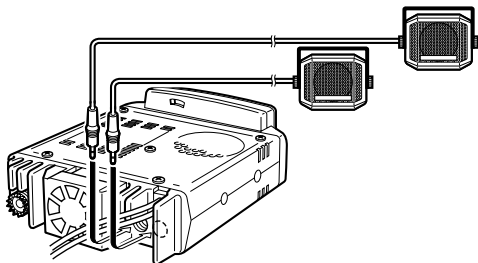

Microphone

To communicate in the voice modes, plug a 600 Ω microphone equipped with an 8-pin modular connector into the modular socket on the front panel of the transceiver. Press firmly on the plug until the locking tab clicks.

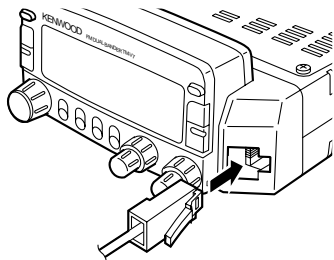

PACKET EQUIPMENT CONNECTIONS

If you intend to use this transceiver for Packet operation, you will need the following equipment.

- Personal computer with communications software
- Terminal Node Controller (TNC)
- TNC power supply
- RS-232C cable
- 6-pin mini DIN plug (optional PG-5A)

For the DATA connector pins, refer to "PACKET OPERATION" {page 79}.

Note:

- ◆ Do not share a single power supply between the transceiver and the TNC.
- ◆ Keep as wide a separation between the transceiver and computer as practical to reduce noise-pickup by the transceiver.
- ◆ One end of the optional PG-5A cable has not been connectorized. Attach the appropriate connector that mates with the TNC connector.

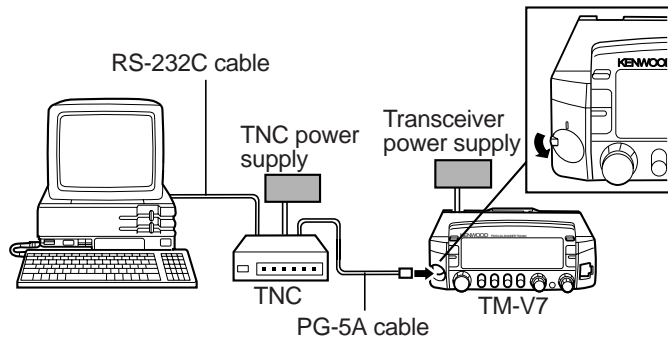

YOUR FIRST QSO

If you tend to discard instruction manuals along with the packaging materialplease don't. The 6 steps given here will get you on the air in your first QSO right away. So, you can enjoy the exhilaration that comes with opening a brand new transceiver.

After trying the rig for a while, settle back in your most comfortable operating chair with this manual and your favorite drink for an hour or two. The time spent will be worthwhile.

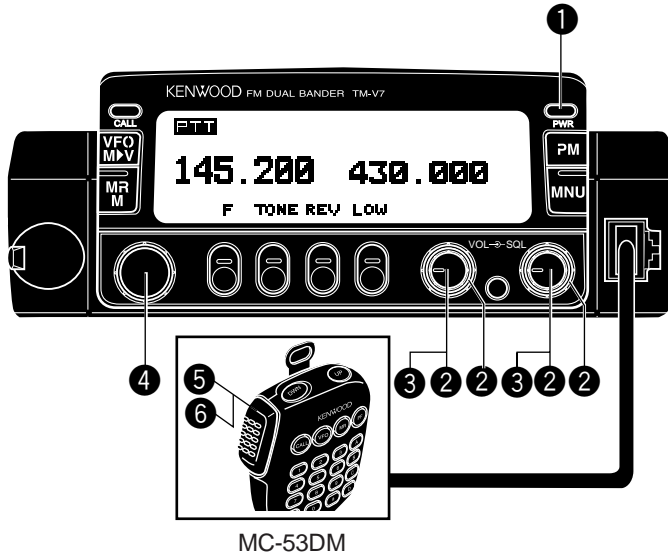

1 Switch ON the DC power supply, then press the **PWR** switch.

2 Turn the **VOL** and **SQL** controls to approximately 9 o'clock.

3 Press [**BAND SEL**] to select the VHF or UHF band.

4 Turn the **Tuning** control to select a frequency.

5 Press and hold Mic [**PTT**], then speak in a normal tone of voice.

6 Release Mic [**PTT**] to receive.

GETTING ACQUAINTED

BASIC TRANSCEIVER MODES

3 This section introduces you to the basic modes you can select, and differences between the TX band and the Control band.

VFO mode

Press **[VFO]** to select. In this mode you can change the operating frequency using the **Tuning** control or Mic **[UP]/[DWN]**.

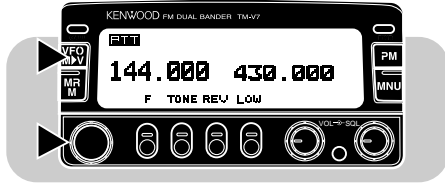

Memory Recall mode

Press **[MR]** to select. In this mode you can change memory channels, using the **Tuning** control or Mic **[UP]/[DWN]**, where you stored frequencies and related data. For further information, refer to "MEMORY CHANNELS" {page 28}.

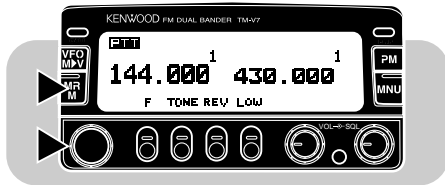

Programmable Memory (PM) mode

Press **[PM]** to select. In this mode you can select the transceiver environment, by pressing **[1]** to **[4]**, that you stored in PM channels {page 36}.

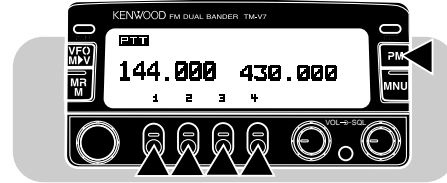

Menu mode

Press **[MNU]** to select. In this mode you can change Menu Nos. using the **Tuning** control or Mic **[UP]/[DWN]**.

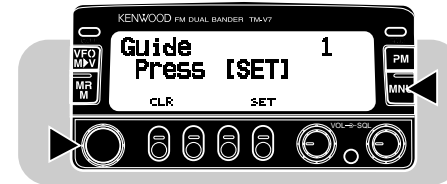

TX-Band

Press the left **[BAND SEL]** (VHF) or the right **[BAND SEL]** (UHF) to select. "PTT" on the display shows which band (VHF or UHF) is currently selected as the transmit (TX) band. You can use the TX band to transmit signals or to control the transceiver.

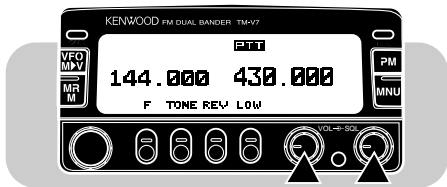

Control Band

Press **[CONT SEL]** to select. On the display "Ctrl" appears to show which band (VHF or UHF) is currently selected as the Control band. Use this function when you want to control the band that is not currently used for TX. After selecting the Control band, you cannot control the TX band.

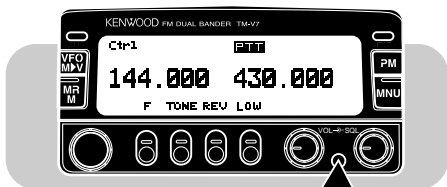

BUTTON FUNCTION DISPLAY

The lower portion of the display has labels that indicate the current function of each of the 4 front panel buttons. The italic font is used to show these 4 buttons in the description of each operation step. After pressing **[F]** or **[F] (1 s)**, pressing **[F]** again or waiting for 10 seconds restores the basic state.

Basic State
Display Labels



Labels after
Pressing **[F]**

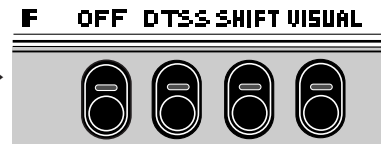

Labels after
Pressing **[F] (1 s)**

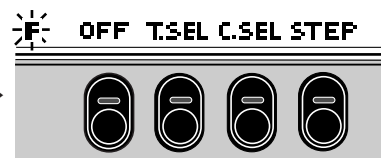

Note:

- ◆ When selecting Program Memory mode, you will also see different labels. See "Programmable Memory mode" (page 8).
- ◆ You can also select different combinations of button labels. Refer to "CHANGING MULTI-FUNCTION BUTTON LABELS" (page 66).
- ◆ After pressing **[F]** or **[F] (1 s)**, press the appropriate key within approximately 10 seconds, or the Basic State display will be restored.

FRONT PANEL

Note: This section describes only the main functions of the front panel controls and buttons. For the functions not described here, you will find explanations in the appropriate sections of this manual.

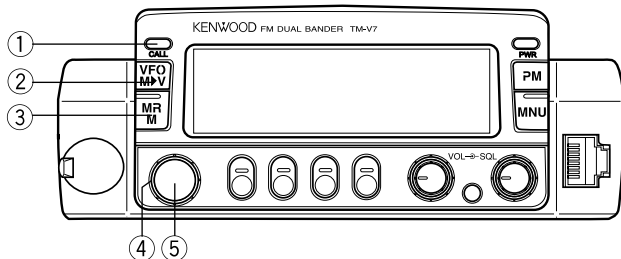

① CALL button

Recalls the Call channel {page 33}. Also starts or stops Call/VFO Scan {page 48} when in VFO mode, or Call/Memory Scan {page 48} when in Memory Recall mode.

② VFO button

Selects the VFO mode {page 8}. In this mode you can change the operating frequency, using the **Tuning** control or Mic **[UP]/[DWN]**. Also provides:

- VFO Scan start/stop to scan the entire VFO range {page 44}.
- Program Scan start/stop to scan a programmed range of frequencies {page 46}.

③ MR button

Selects the Memory Recall mode {page 31}. In this mode you can change memory channels, using the **Tuning** control or Mic **[UP]/[DWN]**. Also starts or stops Memory Scan {page 44}.

④ Tuning control

Selects:

- Operating frequencies when in VFO mode.
- Memory channels when in Memory Recall mode {page 31}.
- Menu Nos. when in Menu mode {page 19}.

This control is used for various other selections.

⑤ MHz button

Selects the MHz mode. In this mode you can change the operating frequency in 1 MHz steps or 10 MHz steps {page 17}, using the **Tuning** control or Mic **[UP]/[DWN]**. Also starts or stops MHz Scan {page 47}.

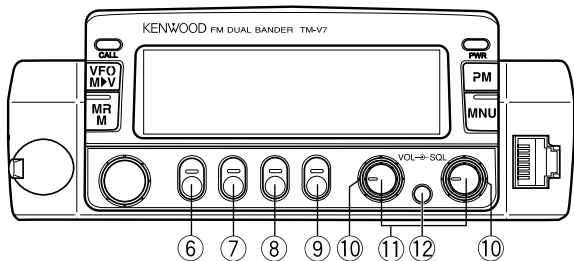

⑥ F (Function) button

Allows you to select the different functions that are available using the multifunction buttons.

⑦ TONE button

Switches the Tone function {page 24} or CTCSS function {page 49} ON or OFF. Also activates or deactivates Automatic Tone frequency ID {page 49}.

⑧ REV button

Switches the transmit frequency and receive frequency when operating with a transmit offset or a split memory channel {page 27}.

⑨ LOW button

Selects High, Mid, or Low transmit output power {page 18}.

⑩ SQL controls

Adjusts the squelch threshold level {page 16}. This allows you to mute speaker output while no stations are being received. Turn the left control (VHF) or the right control (UHF) depending on which band you want to operate.

⑪ VOL controls/ BAND SEL buttons

When turned, these controls adjust the level of receive audio from the speaker {page 16}. Turn the left control (VHF) or the right control (UHF) depending on which band you want to operate.

When pressed, these buttons select the desired TX band. Press the left button (VHF) or the right button (UHF) depending on which band you want to select.

⑫ CONT SEL button

Selects the band that you can control using the front panel buttons or the microphone keys.

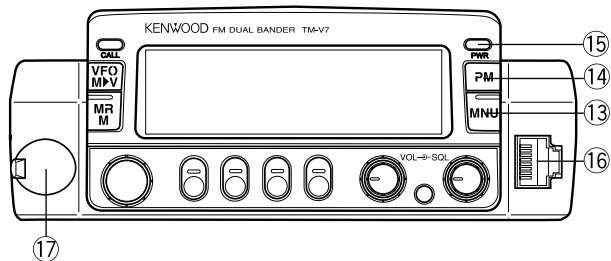

13 MNU button

Selects the Menu mode {page 19}.

14 PM button

Selects the Programmable Memory mode {page 36}.

15 PWR switch

Switches the transceiver ON or OFF {page 16}.

16 Microphone connector

Insert the 8-pin modular connector plug until the locking tab "clicks".

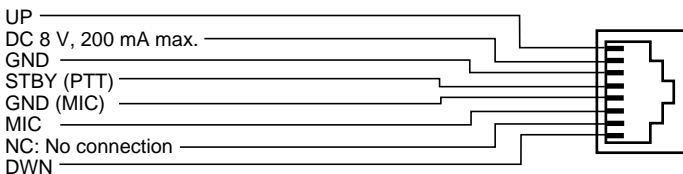

17 DATA connector

Connect a Terminal Node Controller (TNC) for Packet operation. Accepts a 6-pin mini DIN plug {page 6}.

REAR PANEL

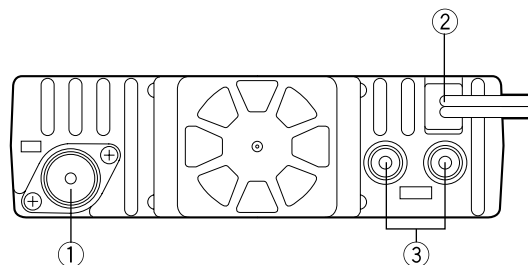

1 Antenna connector

Connect an external antenna {page 5}. When making test transmissions, connect a dummy load in place of the antenna. The antenna system or load should have an impedance of 50 Ω . The TM-V7E accepts a male N-type connector and other versions accept a male PL-259 connector. This transceiver has only one antenna connector because of a built-in duplexer.

2 Power Input 13.8 V DC cable

Connect to a 13.8 V DC power source. Use the supplied DC power cable {pages 3 and 4}.

3 Speaker jacks

If you wish, connect an optional external speaker for clearer audio. These jacks accept a 3.5 mm (1/8") diameter, 2-conductor plug. See page 6 for more information.

MICROPHONE

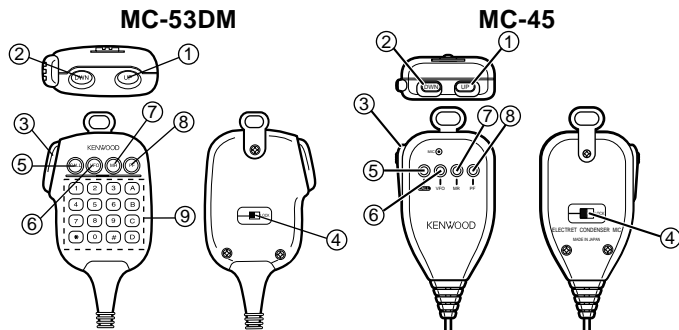

- ① UP button
- ② DWN button

Raises or lowers the operating frequency, the memory channel number, the menu number, etc. Holding either button down causes the action to be repeated. Also, switches between values for functions with multiple choices.

- ③ PTT (Push-to-talk) switch

Press to transmit; release to receive. Also used to cancel various functions such as Scan {page 40} or Automatic Band Change {page 62}.

- ④ LOCK switch

Locks all microphone keys except **[PTT]** and the DTMF keypad, if equipped.

- ⑤ CALL key
- ⑥ VFO key
- ⑦ MR key

Identical to the front panel **CALL**, **VFO**, and **MR** buttons. These keys can be re-programmed, if desired {page 72}.

- ⑧ PF key

Depending on which function you select by accessing "PF1" in Menu No. 16 {page 21}, the function of this key differs. Refer to "CONFIGURING PROGRAM FUNCTION KEYS" {page 72}.

- ⑨ DTMF keypad (MC-53DM only)

The 16-key keypad is used for DTMF functions, or to directly enter a frequency or a memory channel number.

INDICATORS

On the display you will see various indicators that show what you have selected. Sometimes you may not recall what those indicators mean or how you can cancel the current setting. In such a case, you will find this table very useful.

Indicator	What You Selected	What You Press to Cancel
FTT	TX (Transmit) band	Always visible on either band
Ctrl	Control band	[CONT SEL]
CALL	Call channel	[CALL]
M	Medium transmit power	[LOW], [LOW] to select the default (High)
L	Low transmit power	[LOW] to select the default (High)
DT	DTSS	[F], [DTSS], [F], [DTSS]
PAG	Page	[F], [DTSS]
T	Tone function	[TONE], [TONE]
CT	CTCSS	[TONE]
R	Reverse	[REV]
T	Automatic Simplex Checker (ASC)	[REV]

Indicator	What You Selected	What You Press to Cancel
+	Plus offset direction	[F], [SHIFT], [F], [SHIFT] (TM-V7E: one more [F], [SHIFT])
-	Minus offset direction	[F], [SHIFT] (TM-V7E: one more [F], [SHIFT])
= (TM-V7E)	Minus offset direction (-7.6 MHz)	[F], [SHIFT]
±	Split memory channel	[VFO]
A.B.C.	Automatic Band Change (A.B.C.)	[F], [MNU]
LOCK	Transceiver Lock	[F], [MHz]
A.LOCK	All Lock	[MHz]+ POWER ON then [F], [MHz]

When you receive a signal:

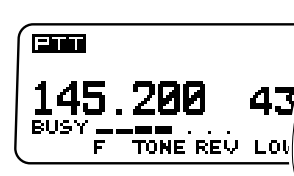

- "BUSY" appears when the squelch {page 16} is open.
- The S-meter shows the strength of received signals.

TRANSCEIVER GUIDE

When you cannot recall how to use a function and you do not have this manual with you, you need not worry. This transceiver shows you the steps for operating the functions that you will often use.

Note: Not all functions are supported by Transceiver Guide.

- 1 Press **[MNU]** to enter Menu mode.
- 2 Select Menu No. 1 (Guide).



- 3 Press **[SET]**, then turn the **Tuning** control to select the desired function.
 - You can also press Mic **[UP]/[DWN]** to select a function.

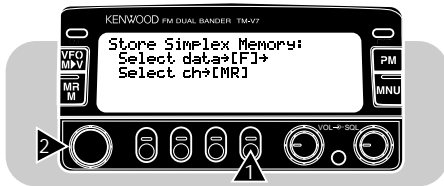

- 4 To exit Guide mode, press **[MNU]** again.

The following table lists the function indexes that you will see on the display.

Function Index	Ref. Page	Function Index	Ref. Page
VFO Scan	44	Transmit Stored DTMF	60
MHz Scan	47	Store Simplex Memory	30
Memory Scan	44	Store Split Memory	30
Call Scan	48	Store Simplex Call Ch	33
MR Ch Clr	31	Store Split Call Ch	34
Ch Disp	34	Assign PF1 key	72
All Reset	35	Assign PF2 key	72
VFO Reset	35	Assign PF3 key	72
PM Reset	39	Assign PF4 key	72
Repeater ¹	81		

¹U.S.A./ Canada only

OPERATING BASICS

SWITCHING POWER ON/OFF

- 1 Switch ON the DC power supply.
 - If operating mobile, skip this step.
- 2 Press the **PWR** switch to switch ON the transceiver.

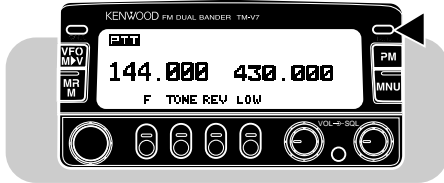

- 3 To switch OFF the transceiver, press the **PWR** switch again.
 - In a fixed installation, after the transceiver has been switched ON, it can then be switched OFF or ON by using only the power switch on the DC power supply.

ADJUSTING VOLUME

Turn the **VOL** control clockwise to increase the audio level and counterclockwise to decrease the audio level.



ADJUSTING SQUELCH

The purpose of squelch is to silence audio output from the speaker when no signals are present. When squelch is set correctly, you will hear sound only while a station is actually being received. The point at which ambient noise on a frequency just disappears, called the squelch threshold, depends on the frequency.

Turn the **SQL** control clockwise to just eliminate the background noise when no signal is present.

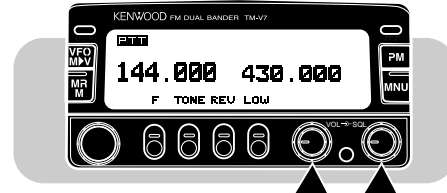

SELECTING A BAND

Press [**BAND SEL**] to select the VHF or UHF band.

- "PTT" appears above the VHF or UHF frequency to show which band you selected.

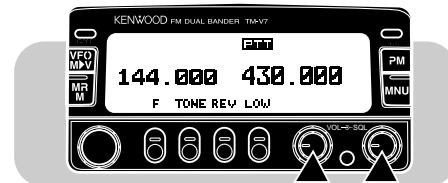

SELECTING FREQUENCIES

■ Tuning Control

Using the **Tuning** control is convenient when you are within easy reach of the transceiver front panel, and the frequencies to be selected lie near the current frequency.

- 1 Press **[VFO]** to select VFO mode.

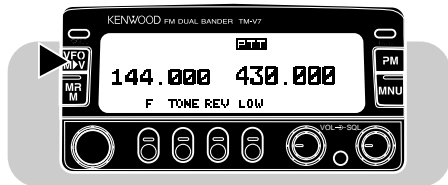

- 2 Turn the **Tuning** control to select a receive frequency.



- Clockwise rotation increases the frequency one frequency step at a time.
- Counterclockwise rotation decreases the frequency one step at a time.
- To change frequencies in steps of 1 MHz, press **[MHz]** first. Pressing **[MHz]** again cancels the 1 MHz function. To change in steps of 10 MHz, press **[F] + [MHz]** first. Pressing **[F]** cancels the 10 MHz function; pressing **[MHz]** starts the 1 MHz function.

- If you cannot select a particular receive frequency, the frequency step size needs to be changed. See "CHANGING FREQUENCY STEP SIZE" {page 65} for further information.
- You can also select frequencies via the microphone keypad (MC-53DM only). See "KEYPAD DIRECT ENTRY" {page 74}.

■ Microphone **[UP]/[DWN]** Buttons

Using Mic **[UP]/[DWN]** for frequency selection is useful when mobiling or any time you are not immediately in front of the transceiver.

Press **[UP]** or **[DWN]** once to change the receive frequency by one frequency step in the direction indicated by the button.

- Pressing and holding either button causes the frequency to step repeatedly in one direction until the button is released.
- To change frequencies in steps of 1 MHz (or 10 MHz), press **[MHz]** (or **[F] + [MHz]**) first.

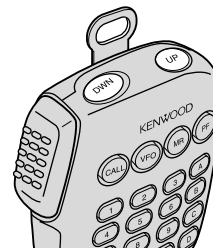

MC-53DM

TRANSMITTING

1 When ready to begin transmitting, press and hold Mic [PTT] and speak in a normal tone of voice.

- "ON AIR" and the RF power meter appear.

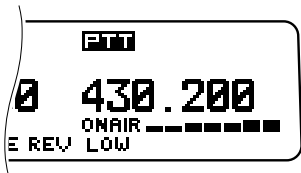

- Speaking too close to the microphone, or too loudly, may increase distortion and reduce intelligibility of your signal at the receiving station.
- The RF power meter shows the relative transmit output power.

2 When you finish speaking, release Mic [PTT].



MC-53DM

■ Selecting Output Power

It's wise, and required by law, to select the lowest power that allows reliable communication. If operating from battery power, lower transmit power will give you more operating time before a charge is necessary. Reducing power lowers the risk of interfering with others on the band.

Press [LOW] to select the transmit power you require.

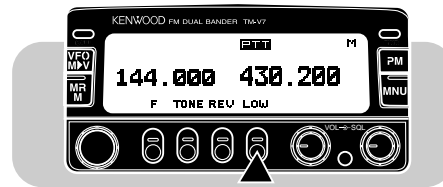

- Each time you press [LOW], the transmit power is changed as shown below.

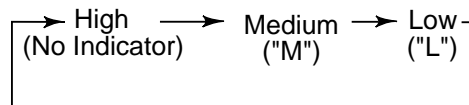

CAUTION:

- ◆ DO NOT TRANSMIT WITH HIGH OUTPUT POWER FOR EXTENDED PERIODS. THE TRANSCEIVER MAY OVERHEAT AND MALFUNCTION.
- ◆ CONTINUOUS TRANSMISSIONS CAUSE THE RADIATOR TO OVERHEAT. NEVER TOUCH THE RADIATOR IN SUCH A SITUATION.

Note: When the transceiver overheats because of ambient high temperature or continuous transmissions, the protective circuit may function to lower transmit output power.

MENU SET-UP

WHAT IS A MENU?

Many functions on this transceiver are selected or configured via a software-controlled Menu instead of physical controls on the transceiver. Once familiar with the Menu system, you will appreciate the versatility it offers.

MENU ACCESS

- 1 Select the desired band.
 - For some Menu Nos., you can select a different setting on each band.
- 2 Press [**MNU**] to enter Menu mode.
 - The last Menu No. used appears.



- 3 Turn the **Tuning** control, or press Mic [**UP**]/**[DWN]**, to select the Menu No.
 - "CLR" and either "▶" or "SET" appear as button labels.
 - To cancel the selection and restore the previous display, press [**CLR**].

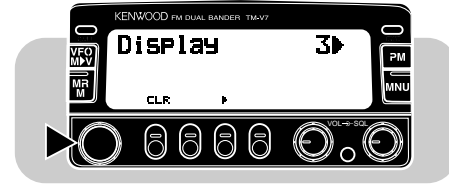

The subsequent steps differ depending on which Menu No. you selected. See the appropriate sections in this manual.

Note:

- ◆ As required, operate keys or the **Tuning** control in each step within approximately 10 seconds, or the previous mode will be restored.
- ◆ After selecting for an Item No. under a Menu No., pressing [**◀**] stores the setting and allows you to select for another Item No.

MENU CONFIGURATION

Note: For the shaded Menu functions, select the appropriate band (VHF or UHF) before entering Menu mode.

Menu No.	Item No.	Description	Selections	Default	Ref. Page
1	—	Transceiver Guide	See reference page		15
2	1	Number of Channels for Visual Scan	25/ 49/ 73/ 147	49	41
	2	Power-ON Message	See reference page	"KENWOOD"	69
	3	Multi-function Button Label	See reference page	<i>F/TONE/REV/LOW</i>	66
3	1	Display Reverse	Positive/ negative	Negative	71
	2	Display Contrast	Level 1 (min.) ~ level 16 (max.)	8	71
	3	Display Dimmer	Level 1 (max.) ~ level 4 (min.)/ OFF	1	70
	4	Auto Dimmer Change	ON/ OFF	OFF	70
4	1	Memory Channel Lockout	ON/ OFF	OFF	45
	2	VHF/UHF Memory Channel Ratio	90:90/ 110:70/ 130:50/ 50:130/ 70:110/ 140:140	90:90	29
	3	Memory Channel Name	See reference page		32
	4	Auto PM Channel Storing	ON/ OFF	OFF	39
5	1	Automatic Repeater Offset (U.S.A./ Canada/ Europe only)	ON/ OFF	ON	26
	2	Offset Frequency	00.00 MHz ~ 29.95 MHz in steps of 50 kHz	See reference page	24
	3	1750 Hz Tone Transmit Hold (TM-V7E only)	ON/ OFF	OFF	73

Menu No.	Item No.	Description	Selections	Default	Ref. Page
6	—	Programmable VFO (Upper/ lower limits)	Frequencies selectable on the band	Upper/lower RX frequency limits on the band	64
7	—	DTMF Number Storing	See reference page		59
8	—	Scan Resume Methods	Time-Operated/ Carrier-Operated	Time-Operated	43
9	—	Advanced Intercept Point (AIP)	ON/ OFF	OFF	62
10	—	Automatic Power Off (APO)	ON/ OFF	OFF	61
11	—	Time-Out Timer (TOT)	3/ 5/ 10 minutes	10 minutes	61
12	1	DTSS/ Page Code Transmit Delay	350 ms/ 550 ms	350 ms	52,56
	2	Auto Page Cancel	Auto (ON)/ manual (OFF)	Manual	57
	3	Page Answer Back (U.S.A./ Canada only)	ON/ OFF	OFF	57
13	1	S-meter Squelch	ON/ OFF	OFF	68
	2	S-meter Squelch Hang Time	125 ms/ 250 ms/ 500 ms/ OFF	OFF	68
14	1	Beep Volume	Level 1 (min.) ~ 7 (max.) / OFF	Level 5	66
	2	Speaker Configuration	Mode 1/ mode 2	Mode 1	76
	3	Voice Synthesizer (Only when the optional VS-3 is installed.)	English/ Japanese/ OFF	English	82
15	1	Data Transfer Rate	1200 bps/ 9600 bps	1200 bps	79
	2	Data TX/RX Band	ON/ OFF	OFF	79
16	1	Microphone Control	ON/ OFF	OFF	77
	2 ~ 5	Programmable Function Keys	See reference page		73
	6	DTMF Monitor	ON/ OFF	OFF	58
17	—	Repeater TX Hold (U.S.A./ Canada only)	ON/ OFF	ON	81

OPERATING THROUGH REPEATERS

Compared to simplex communication, you can usually transmit over much greater distances by using a repeater. Repeaters are typically located on a mountain top or other elevated location. Often they operate at higher ERP (Effective Radiated Power) than a typical station. This combination of elevation and high ERP allows communications over considerable distances.

6

Repeaters are often installed and maintained by radio clubs, sometimes with the cooperation of local businesses involved in the communications industry. During emergencies, repeater networks can be a valuable aid to officials responsible for coordinating communications in a community.

REPEATER ACCESS

Most Amateur Radio voice repeaters use a separate receive and transmit frequency. The transmit frequency may be higher or lower than the receive frequency but the difference in frequencies will be a standard amount, or "standard split". You can set a separate receive and transmit frequency by selecting the offset frequency and offset direction with respect to the receive frequency.

In addition, some repeaters may require the transceiver to transmit a tone before the repeater can be used. To transmit this required tone, activate the Tone function and select a tone frequency. The required tone frequency depends on the repeater you are accessing.

Most repeater configurations fall into one of the following categories:

Offset Direction	TM-V7A/ E VHF	TM-V7A UHF	TM-V7E UHF
+	+600 kHz	+5 MHz	+1.6 MHz
-	-600 kHz	-5 MHz	-1.6 MHz
- ("=")	N/A	N/A	-7.6 MHz

N/A: Not applicable

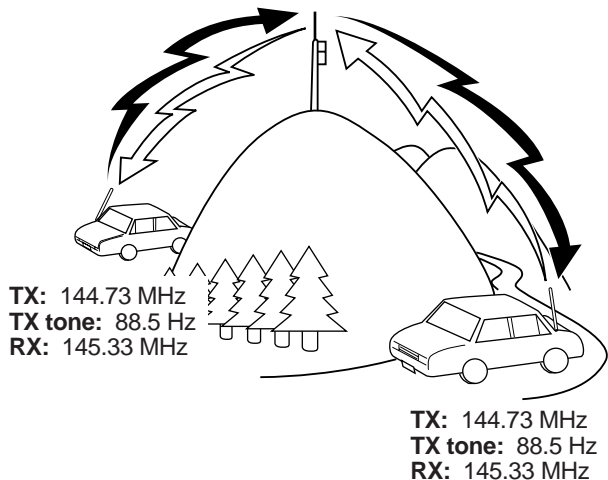

Flow Chart for Repeater Access

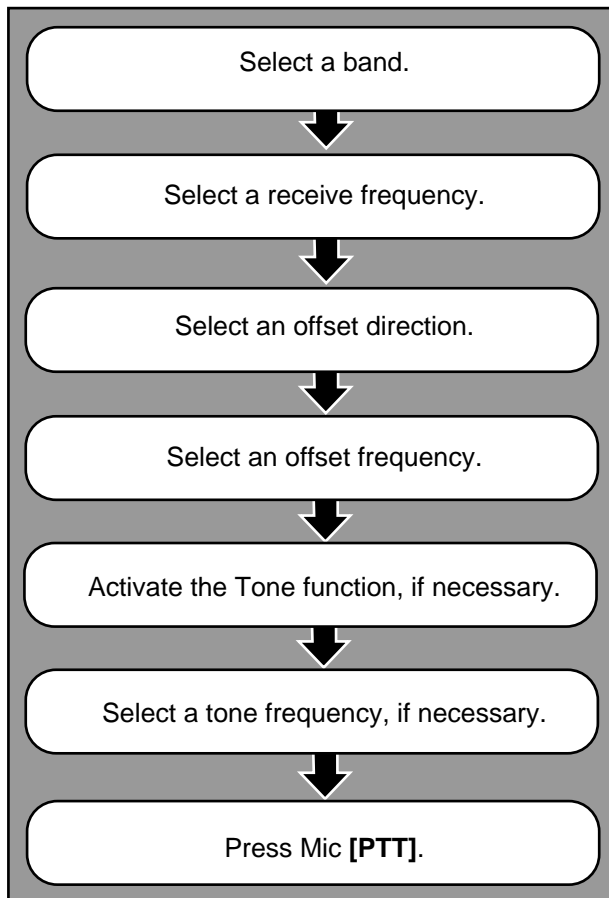

■ Selecting Offset Direction

Select whether the transmit frequency will be higher (+) or lower (-) than the receive frequency.

Press **[F]**, **[SHIFT]**.

- Each time you repeat this key operation, the offset direction changes as shown below.

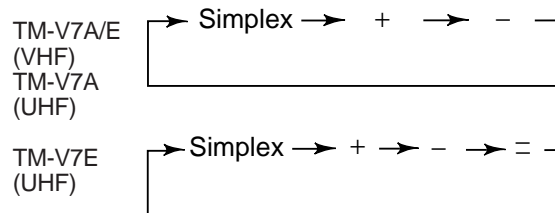

6

If the offset transmit frequency falls outside the allowable transmit frequency range, transmitting is inhibited until the transmit frequency is brought within the band limits by one of the following methods:

- Move the receive frequency further inside the band.
- Change the offset direction.

Note: While using a split memory channel or transmitting, you cannot change the offset direction.

■ Selecting Offset Frequency

Select how much the transmit frequency will be offset from the receive frequency.

- 1 Select the desired band.
- 2 Press **[MNU]** to enter Menu mode.
- 3 Select Menu No. 5 (Repeater).

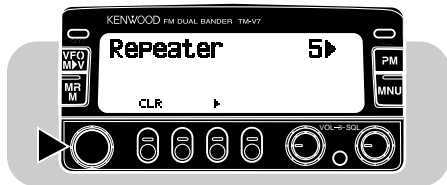

- 4 Press **[>]**, then select Item No. 2 (VHF Offset or UHF Offset).

- The current offset frequency appears.

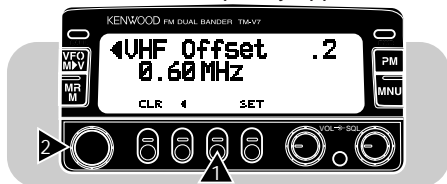

- 5 Press **[SET]**, then select the appropriate offset frequency.
 - The selectable range is from 00.00 MHz to 29.95 MHz in steps of 50 kHz.

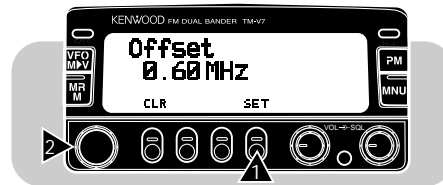

- 6 Press **[SET]** again to complete the setting.
- 7 Press **[MNU]** again to exit Menu mode.

TM-7VE only: If you have selected " = " for the offset direction, you cannot change the default (7.6 MHz).

Note: After changing the offset frequency, the new offset frequency will also be used by Automatic Repeater Offset.

■ Activating Tone Function

Press **[TONE]** to activate the Tone function.

- Each time you press **[TONE]**, the selection changes as shown below.

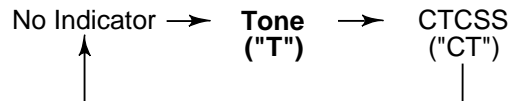

■ Selecting a Tone Frequency

- 1 Press **[TONE]** to activate the Tone function.
- 2 Press **[F] (1 s)**, **[T.SEL]**.
 - The current tone frequency appears.

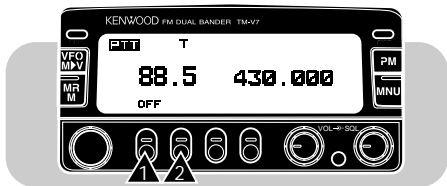

- 3 Turn the **Tuning** control, or Mic **[UP]/[DWN]** to select a tone frequency.
- 4 Press **[OFF]** to complete the setting.

No.	Freq. (Hz)	No.	Freq. (Hz)	No.	Freq. (Hz)	No.	Freq. (Hz)
01	67.0	11	97.4	21	136.5	31	192.8
02	71.9	12	100.0	22	141.3	32	203.5
03	74.4	13	103.5	23	146.2	33	210.7
04	77.0	14	107.2	24	151.4	34	218.1
05	79.7	15	110.9	25	156.7	35	225.7
06	82.5	16	114.8	26	162.2	36	233.6
07	85.4	17	118.8	27	167.9	37	241.8
08	88.5	18	123.0	28	173.8	38	250.3
09	91.5	19	127.3	29	179.9		
10	94.8	20	131.8	30	186.2		

Note: Use Nos. 01 to 38 shown in the table above when selecting tone frequencies via Keypad Direct Entry (page 75).

TM-V7E only: To transmit a 1750 Hz tone, assign the 1750 Hz Tone function to one of the Programmable Function keys of the microphone (page 72).

■ Automatic Repeater Offset (U.S.A./ Canada/ Europe Only)

This function automatically selects an appropriate offset direction according to the frequency that you select on the VHF band. The transceiver is programmed for offset direction as shown below. To obtain an up-to-date band plan for repeater offset direction, contact your national Amateur Radio association.

U.S.A. and Canada versions

This complies with the standard ARRL band plan.

144.0 145.5 146.4 147.0 147.6
145.1 146.0 146.6 147.4 148.0 MHz

S	-	S	+	S	-	+	S	-
---	---	---	---	---	---	---	---	---

S: Simplex

European versions

144.0 145.6 145.8 146.0 MHz

S	-	S
---	---	---

S: Simplex

Note: Automatic Repeater Offset does not function when Reverse or CTCSS is ON. However, pressing **[REV]** after Automatic Repeater Offset has selected an offset (split) status, exchanges the receive and transmit frequencies.

- 1 Select the VHF band.
- 2 Press **[MNU]** to enter Menu mode.
- 3 Select Menu No. 5 (Repeater).



- 4 Press **[▶]**, then select Item No. 1 (Auto Offset).



- 5 Press **[SET]** to toggle the function ON (default) or OFF.
- 6 Press **[MNU]** again to exit Menu mode.

REVERSE FUNCTION

When used while monitoring a repeater, the Reverse function allows you to manually check the signal strength of a station accessing the repeater. If the station's signal is strong, it is best to move to a simplex frequency to continue the contact and free up the repeater.

Press **[REV]** to toggle the Reverse function ON or OFF.

- The receive frequency and the transmit frequency are exchanged.
- "R" appears when the function is ON.

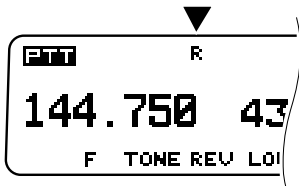

Note:

- ◆ If pressing **[REV]** places the transmit frequency outside the allowable transmit frequency range, an error beep sounds when **[PTT]** is pressed, and transmission is inhibited.
- ◆ If reversal would place the receive frequency outside the receive frequency range, an error beep sounds when **[REV]** is pressed. No reversal occurs.
- ◆ Automatic Repeater Offset does not function while Reverse is ON.
- ◆ You cannot switch Reverse ON or OFF while transmitting.

Automatic Simplex Checker (ASC)

This function automatically monitors the strength of the signal you are receiving from the repeater. If the signal strength is high enough to allow direct contact without a repeater, an indicator on the display begins blinking. This alerts you to move off to a private frequency and release the repeater for other users.

- 1 Press **[REV]** (1 s) to switch the function ON.
 - The ASC indicator appears.

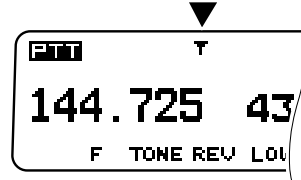

- While direct contact is possible, the ASC indicator blinks.

- 2 To cancel ASC, press **[REV]**.

Note:

- ◆ When direct contact becomes impossible, the ASC indicator stops blinking.
- ◆ ASC does not function if your transmit and receive frequencies are the same (simplex operation).
- ◆ ASC does not function while scanning.
- ◆ If you recall a memory channel or the Call channel that contains Reverse ON status, ASC is switched OFF.

MEMORY CHANNELS

In memory channels, you can store frequencies and related data that you often use. A total of 280 memory channels are available, 140 each for VHF and UHF.

You can also store a name for each memory channel. Using this naming function restricts the total number of memory channels to 180, but allows you to select the ratio of channels between the VHF and UHF bands, from among 5 types. For more information, see "NAMING MEMORY CHANNELS" {page 32}.

SIMPLEX OR SPLIT MEMORY CHANNEL?

There are 2 methods of storing transmit/receive frequencies and related data in memory channels, depending on the relationship of the transmit and receive frequencies. You can use each memory channel either as a simplex channel or split channel. Use as a split channel to store a separate receive and transmit frequency.

- Simplex memory channels:
RX frequency = TX frequency
- Split memory channels:
RX frequency \neq TX frequency

Note: *Not only can you store data in memory channels, but you can also overwrite existing data with new data.*

The data listed below can be stored in each memory channel:

Parameter	Simplex Channel	Split Channel
RX frequency	Yes	Yes
TX frequency		Yes
Tone frequency	Yes	Yes
CTCSS frequency	Yes	Yes
Tone or CTCSS status	Yes	Yes
Frequency step	Yes	Yes
Offset direction	Yes	N/A
Reverse status	Yes	N/A
DTSS code, DTSS status	Yes	Yes
Memory channel lockout	Yes	Yes
Memory channel name	Yes	Yes

Yes: Can be stored in memory.

N/A: Not applicable

VHF/UHF MEMORY CHANNEL RATIO

You can change the ratio of memory channels between the VHF and UHF bands, from the factory default (90 channels each). Changing the ratio requires all memory channels to be cleared. So decide the appropriate ratio before storing data in memory channels.

The selectable ratios are as shown below:

VHF Band	UHF Band	Memory Channel Name
90	90	Yes
110	70	Yes
130	50	Yes
50	130	Yes
70	110	Yes
140	140	N/A

Yes: Memory channel name programmable
N/A: Not applicable

- 1 Press **[MNU]** to enter Menu mode.
- 2 Select Menu No. 4 (Memory).

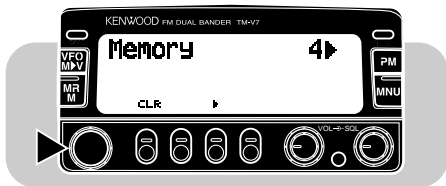

- 3 Press **[▶]**, then select item No. 2 (Channel Ratio).

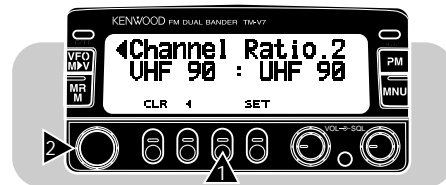

- 4 Press **[SET]**, then select the desired ratio.

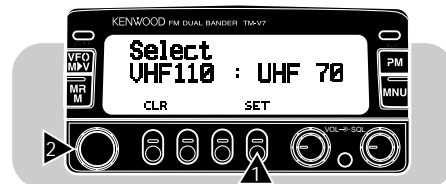

- 5 Press **[SET]** again.
 - A confirmation message appears.
 - To quit changing the ratio, press **[CLR]**.
- 6 Press **[SET]** once again.
 - The memory channels are cleared and the ratio is changed.
 - The previous mode is restored.

STORING DATA IN SIMPLEX CHANNELS

- 1 Select the desired band.
- 2 Select the desired frequency and related data (Tone, CTCSS, DTSS, etc.) using VFO mode, Memory Recall {page 31}, or the Call channel {page 33}.
- 3 Press **[F]**.
 - A memory channel number and an arrow appear.
 - The arrow shows whether the current memory channel contains data ("▶") or not ("▷").

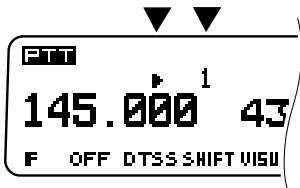

- 4 Turn the **Tuning** control, or press Mic **[UP]/[DWN]**, to select the desired memory channel.
- 5 Press **[MR]**.
 - The selected frequency and related data are stored in the memory channel. The transmit frequency from a split memory channel or split Call channel is not stored.
 - If the memory channel selected in the previous step already contained data, the new data overwrites the previous data.

STORING DATA IN SPLIT CHANNELS

- 1 To select the desired receive frequency, related data and memory channel, use steps 1 to 4 (not 5) given for Simplex Memory Channels.
- 2 Press **[MR]** (1 s).
 - "±" appears.

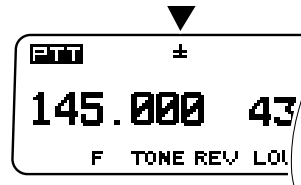

- 3 Select the desired transmit frequency.
- 4 Press **[MR]**.
 - The selected transmit frequency is stored in the memory channel.

Note:

- ◆ If you select an offset direction in step 1, you can also press **[REV]** in step 3 to select a transmit frequency. The transmit frequency separated by the current offset frequency will be stored in the memory channel.
- ◆ In step 2 you cannot use Mic **[MR]**, or Mic **[PF]** programmed with Memory Recall.
- ◆ Transmit Offset status and Reverse status are not stored in a split memory channel.

RECALLING MEMORY CHANNELS

- 1 Select the desired band.
- 2 Press **[MR]** to enter Memory Recall mode.
 - The memory channel used last is recalled.

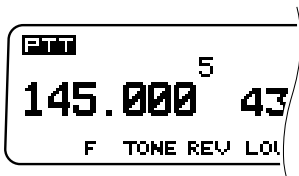

- 3 Turn the **Tuning** control, or press Mic **[UP]/[DWN]**, to select the desired memory channel.
 - Clockwise or Mic **[UP]**:
Increases the channel number.
 - Counterclockwise or Mic **[DWN]**:
Decreases the channel number.
 - Empty memory channels cannot be recalled.
 - To restore the VFO mode, press **[VFO]**.

Note:

- ◆ *Memory channels can also be recalled via the microphone keypad. See "Memory Channel Number Entry" (page 75).*
- ◆ *When a split memory channel is recalled, "±" appears on the display. Press **[REV]** to display the transmit frequency.*

CLEARING MEMORY CHANNELS

- 1 Select the desired band.
- 2 Press **[MR]** to enter Memory Recall mode.
- 3 Turn the **Tuning** control, or press Mic **[UP]/[DWN]**, to select the desired memory channel.
- 4 Switch OFF the power to the transceiver.
- 5 Press **[MHz]+ POWER ON**.
 - A confirmation message appears.
- 6 Press **[MR]** again.
 - The contents of the selected memory channel are erased.

Note: *Memory channel 1 cannot be cleared.*

NAMING MEMORY CHANNELS

You can name memory channels using up to 7 alphanumeric characters. When you recall a named memory channel, its name appears on the display with the stored frequency. Names can be callsigns, repeater names, cities, names of people, etc.

Note:

- ◆ You cannot use this function after having selected 140:140 memory channel ratio.
- ◆ You cannot name the Call, L1 to L3, nor U1 to U3 channels.

- 1 Recall the desired memory channel.
- 2 Press **[MNU]** to enter Menu mode.
- 3 Select Menu No. 4 (Memory).

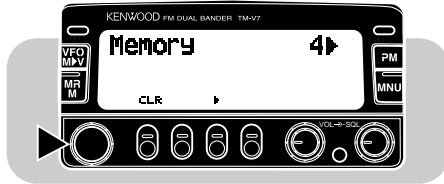

- 4 Press **[▶]**, then select item No. 3 (Memory Name).

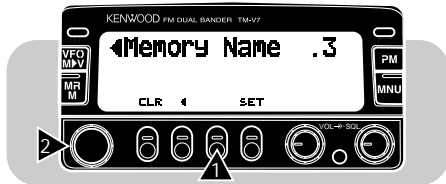

- 5 Press **[SET]**.

- The first digit blinks.

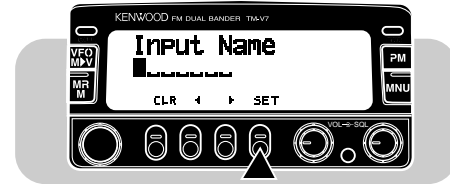

- 6 Turn the **Tuning** control, or press Mic **[UP]/[DWN]**, to select the first digit.

- To skip by four characters when operating the above control or keys, press **[MHz]**. Press **[MHz]** again to quit this jump function.

- 7 Press **[▶]**.

- The second digit blinks.

- 8 Repeat steps 6 and 7 to enter up to 7 digits.

- After entering the 7th digit, pressing **[▶]** causes an error beep to sound.
- To re-enter the preceding digit, press **[◀]**.
- To clear all digits and move back to the first digit, press **[VFO]**.

- 9 Press **[SET]** again to complete the setting.

- 10 Press **[MNU]** to exit Menu mode.

Note:

- ◆ Names can be assigned only to memory channels in which you have stored frequencies and related data.
- ◆ The stored names can be overwritten by repeating steps 1 to 10.
- ◆ The stored names also are erased by clearing memory channels.

CALL CHANNEL

The Call channel can be used to store any frequency and related data that you will recall often. The Call channel can be programmed with a simplex or split frequency as well as related data that can be stored in the memory channels. No matter what mode the transceiver is in, the Call channel can always be selected quickly. You may want to dedicate the Call channel as an emergency channel within your group. In this case, the Call/VFO scan {page 48} will be useful.

The default frequency stored in the Call channel is shown below:

Version	VHF	UHF
U.S.A/ Canada	144 MHz	440 MHz
Europe/ General	144 MHz	430 MHz

The contents of the Call channel cannot be deleted; however, you can overwrite old data with new data as described in the next section.

■ Recalling the Call Channel

- 1 Select the desired band.
- 2 Press **[CALL]** to recall the Call channel.
 - "CALL" appears.



- To restore the previous mode, press **[CALL]** again.
- The **Tuning** control and microphone **[UP]/[DWN]** do not function while the Call channel is selected.

■ Changing Call Channel Contents (Simplex)

- 1 Select the desired band.
- 2 Select the desired frequency and related data (Tone, CTCSS, DTSS, etc.) using VFO mode or Memory Recall {page 31}.
- 3 Press **[F]**, **[CALL]**.
 - The selected frequency and related data are stored in the Call channel. The transmit frequency from a split memory channel is not stored.
 - The previous mode is restored.

Note: Lockout status is not copied from a memory channel to the Call channel.

■ Changing Call Channel Contents (Split)

- 1 Select the desired band.
- 2 Select the desired receive frequency and related data (Tone, CTCSS, DTSS, etc.) using VFO mode or Memory Recall {page 31}.
- 3 Press **[F]**, **[CALL]** (1 s).

- "±" appears.

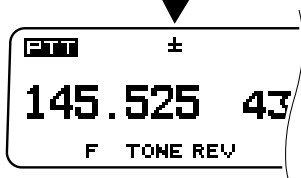

- The channel number is visible if using Memory Recall mode in step 1.
- 4 Turn the **Tuning** control, or press Mic **[UP]**/**[DWN]**, to select the desired transmit frequency.
 - 5 Press **[CALL]** again.

- The selected transmit frequency is stored in the Call channel, and the previous mode is restored.

Note:

- ◆ Transmit Offset status and Reverse status are not stored in a split Call channel.
- ◆ Lockout status is not copied from a memory channel to the Call channel.

MEMORY → VFO TRANSFER

Transferring the contents of a memory channel or the Call channel to the VFO can be useful if you want to search for other stations or a clear frequency, near the selected memory channel or Call channel frequency.

- 1 Recall the desired memory channel or the Call channel.
- 2 Press **[F]**, **[VFO]**.

- The complete contents of the memory channel or the Call channel are copied to the VFO. VFO mode is selected after the transfer is completed.

Note: A transmit frequency from a split memory channel or split Call channel is not transferred to the VFO. To transfer a transmit frequency, press **[REV]**, then press **[F]**, **[VFO]**.

CHANNEL DISPLAY FUNCTION

When this function is switched ON, the transceiver displays only memory channel numbers instead of frequencies.

Press **[LOW]+ POWER ON** to toggle this function ON or OFF.



INITIALIZING MEMORY

If your transceiver seems to be malfunctioning, initializing the transceiver may resolve the problem.

Remember that initializing the memory channels requires that you re-enter memory channel data again after the initialization. On the other hand, initialization is a quick way to erase all data from all channels.

Note: While using the Channel Display or All Lock function, you cannot do Partial Reset nor Full Reset.

VHF Band Defaults

Version	VFO Frequency	Frequency Step	Tone Frequency
U.S.A./ Canada	144 MHz	5 kHz	88.5 Hz
Europe/ General	144 MHz	12.5 kHz	88.5 Hz

UHF Band Defaults

Version	VFO Frequency	Frequency Step	Tone Frequency
U.S.A./ Canada	440 MHz	25 kHz	88.5 Hz
Europe/ General	430 MHz	25 kHz	88.5 Hz

■ Partial Reset (VFO)

Use to initialize all settings except the memory channels, the Call channel, the PM channels, and Memory Channel Lockout.

1 Press **[VFO]+ POWER ON**.

- A confirmation message appears. ("VFO Reset? Press [VFO]")
- To quit resetting, press any key other than **[VFO]**.

2 Press **[VFO]** again.

■ Full Reset (Memory)

Use to initialize all settings.

1 Press **[MR]+ POWER ON**.

- A confirmation message appears. ("All Reset? Press [MR]")
- To quit resetting, press any key other than **[MR]**.

2 Press **[MR]** again.

Note: You can also do Partial Reset or Full Reset by pushing the RESET switch on the transceiver (page 90).

PROGRAMMABLE MEMORY (PM)

Programmable Memory (PM) allows you to store virtually all settings currently set on the transceiver. So you can quickly recall exactly the same environment later. This transceiver provides 4 PM channels. If you are the type who likes the many features offered by modern transceivers, but dislikes remembering how to make all the necessary settings, you will find Programmable Memory particularly useful.

8 PROGRAMMABLE INFORMATION

The following programmable settings are shared by the VHF and UHF bands:

TX band	Control band
Automatic Power Off	Automatic Band Change
Time-Out Timer	Display Dimmer
Auto Dimmer Change	Display contrast
Positive/ Negative Reversal	Beep volume
Transfer rate	DTSS/Page code transmit delay
1750 Hz tone transmit hold (TM-V7E only)	Microphone keypad confirmation tone

The following settings can be separately stored for the VHF and UHF bands:

VFO frequency	VFO mode
Memory Recall mode	Call Channel mode
TX band	Control band
Frequency step	Transmit output power
Tone frequency	CTCSS frequency
Tone status	CTCSS status
Offset direction	Offset status
Automatic Repeater Offset	Reverse status
Upper frequency limit (for Programmable VFO)	Lower frequency limit (for Programmable VFO)
Scan resume method	S-meter Squelch
Automatic Simplex Checker	Advanced Intercept Point
DTSS/Page status	DTSS code
Page code memory channels	Dual Band RX

APPLICATION EXAMPLES

The following are examples of how you might use Programmable Memory. These examples may not represent applications useful to you, but you will understand the flexibility of this function.

Situation 1:

You share your transceiver with other members in your family or club. However, each individual has personal preferences for how they like to set various functions. You have to keep changing many settings each time you use the transceiver.

Solution:

Because 4 PM channels are available, up to 4 persons can separately program the transceiver and store their customized environment. Then each person can quickly change to his or her favorite settings, simply by recalling a PM channel.

It is too much trouble to change the settings after somebody else has reconfigured them. So this application may avoid having a feature-rich transceiver but never using many useful features.

Situation 2:

While operating mobile on the way to work every morning, you prefer a silent transceiver that does not interrupt the morning calm. In addition, you feel that a bright display is a waste of electricity in sunlight.

At night when driving home, you realize the Beep function truly serves a purpose and you acknowledge it is nice to see a bright display after dark.

Solution:

In two PM channels, store the same operating data such as frequency, offset, DTSS code, etc., and store different settings for the Display Dimmer and Beep functions. Then you can quickly recall the best settings for day or night operating.

Situation 3:

You cannot figure out how you can make the transceiver exit the current mode.

Solution:

Simply recall PM channel 1 that contains an exact copy of the transceiver default environment. You will not lose the contents of any memory channels.

STORING DATA IN PM CHANNELS

- 1 Confirm that the following conditions have been satisfied:
 - Both bands are in the receive mode.
 - Scan is not being used on either band.
 - Microphone Control is OFF.
- 2 Select the desired band.
- 3 Select the desired frequency and related data (Tone, CTCSS, DTSS, etc.) using VFO mode.
- 4 If required, select another band, then select the desired frequency and related data.
- 5 Press **[F]**, **[PM]**.
 - The PM channel numbers appear and blink.

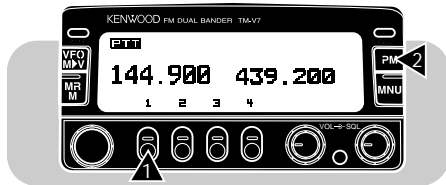

- 6 Press **[1]** to **[4]** corresponding to the desired PM channel.
 - The selected frequency and related data are stored in the PM channel.

RECALLING PM CHANNELS

- 1 Press **[PM]**.
 - The PM channel numbers appear.

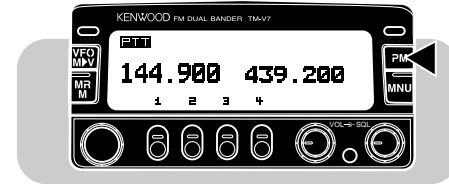

- 2 Press **[1]** to **[4]** corresponding to the desired PM channel.
 - The contents of the selected channel are recalled.
 - The selected channel number appears at the left bottom of the display.
 - To exit PM Recall mode, press **[PM]**, **[VFO]**.

Note: You cannot recall a PM memory channel while transmitting.

AUTO PM CHANNEL STORING

After you recalled a PM channel, this function automatically overwrites the current PM channel with the present operating environment when:

- You recall another PM channel.
- You press **[PM]**, **[VFO]**.
- You switch OFF the transceiver.

Use the following procedures to activate this function:

- 1 Press **[MNU]** to enter Menu mode.
- 2 Select Menu No. 4 (Memory).

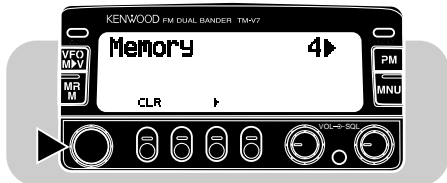

- 3 Press **[▶]**, then select Item No. 4 (PM Auto Store).



- 4 Press **[SET]** to toggle the function ON or OFF (default).
- 5 Press **[MNU]** again to exit Menu mode.

RESETTING PROGRAMMABLE MEMORY

Use this procedure to reset the PM channels to the factory defaults.

- 1 Press **[CALL]+ POWER ON**.

- A confirmation message appears. ("PM Reset? Press [CALL]")
- To quit resetting, press any key other than **[CALL]**.

- 2 Press **[CALL]** again.

SCAN

Scan is a useful feature for hands-off monitoring of your favorite frequencies. After becoming comfortable with how to use all types of Scan, the monitoring flexibility gained will increase your operating efficiency.

This transceiver provides the following conventional scans in addition to “Visual Scan” {page 41} that may be new to you.

Scan Type	Scan Range
VFO Scan	All frequencies tunable on the band
Memory Scan	Frequencies stored in the memory channels
Program Scan	All frequencies in the range selected on the band
MHz Scan	All frequencies within 1 MHz range
Call/VFO Scan	Call channel plus the current VFO frequency
Call/Memory Scan	Call channel plus the memory channel last used

When using with CTCSS and/or DTSS:

- *While using CTCSS, Scan stops and the squelch opens only when received signals contain the matching CTCSS tone.*
- *While using DTSS, Scan stops for any signals received. However, if the signals do not contain the matching DTSS code, the squelch does not open.*
- *When both CTCSS and DTSS are ON, Scan stops for signals that contain the matching CTCSS tone. However, if the signals do not contain the matching DTSS code, the squelch does not open.*

Note:

- ◆ *Remember to adjust the squelch threshold level before using Scan.*
- ◆ *Always turn OFF Monitor {page 73} and Page before using Scan.*
- ◆ *When using S-meter Squelch, Scan stops when the received signal strength matches or exceeds the S-meter setting. Scan resumes 2 seconds after the signal level drops below the S-meter setting.*

VISUAL SCAN

While you are on the air, Visual Scan allows you to monitor frequencies near the current operating frequency. Visual Scan graphically and simultaneously shows how all frequencies in the selected range are busy. You will see up to 14 segments, for each channel, that represent 7 S-meter levels (2 segments per level).

You determine the scan range by selecting the center frequency and the number of channels. The default number of channels is 49.

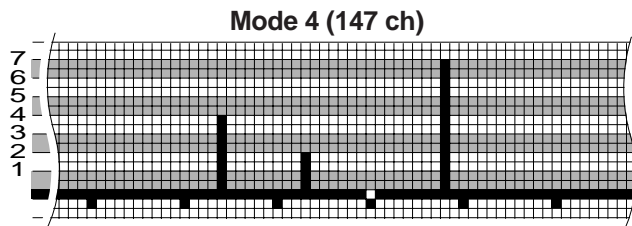
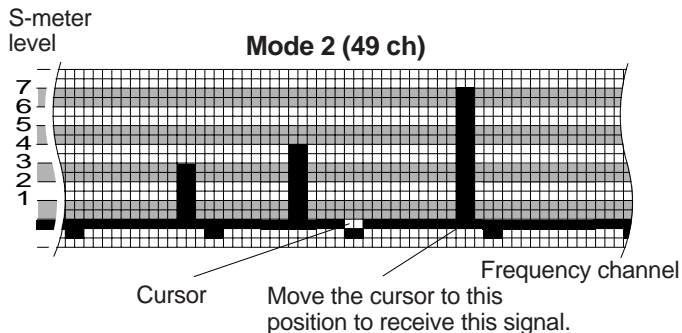

Selecting the Number of Channels

- 1 Press **[MNU]** to enter Menu mode.
- 2 Select Menu No. 2 (Front Panel).

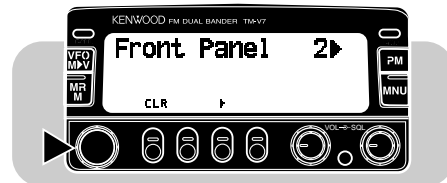

- 3 Press **[>]**, then select Item No. 1 (Visual Scan).



- 4 Press **[SET]** to select 25, 49, 73, or 147.
 - The default is 49.
- 5 Press **[MNU]** to exit Menu mode.

■ Using Visual Scan

- 1 Select the desired band.
- 2 Turn the **Tuning** control, or press Mic **[UP]/[DWN]**, to select the operating frequency.
 - This frequency will also be used as the center frequency.
- 3 Press **[F]**, **[VISUAL]** to start Visual Scan.
 - To halt Scan, press **[PAUSE]**. "P" appears. Press **[PAUSE]** again to resume.



- 4 To change the operating frequency, turn the **Tuning** control or press Mic **[UP]/[DWN]**.
 - The displayed frequency changes and the cursor moves.
 - Press **[SET]** to use the changed operating frequency as the center frequency.
 - Press **[RESET]** to restore the previous operating frequency.
- 5 To quit Visual Scan, press **[OFF]**.

Note:

- ◆ If you start Visual Scan in Memory Recall mode, the memory channel frequencies will be scanned.
- ◆ If you start Visual Scan after recalling the Call channel, the call channel frequency will be used as the center frequency.
- ◆ Visual Scan stops while transmitting.
- ◆ Starting Visual Scan switches Automatic Band Change OFF.
- ◆ If you start Visual Scan in one of the following conditions, you cannot receive in the current operating frequency. To use this frequency, press **[PAUSE]** to halt Scan.
 - Memory Recall or Call Channel mode
 - The VHF band, VFO mode, and a frequency in the range 118 MHz to 136 MHz were selected.
- ◆ Depending on conditions, Visual Scan and the conventional S-meter may indicate different signal strength levels.

SCAN RESUME METHODS

Before using Scans other than Visual Scan, it's necessary to decide under what condition you want your transceiver to continue scanning after detecting and stopping for a signal. You can choose Time-Operated mode or Carrier-Operated mode. The default is Time-Operated mode.

- **Time-Operated mode**

Your transceiver stops scanning after detecting a signal, remains there for approximately 5 seconds, and then continues to scan even if the signal is still present.

- **Carrier-Operated mode**

Your transceiver stops scanning after detecting a signal and remains on the same frequency until the signal drops out. There is a 2 second delay between signal drop-out and scan resumption to allow time for any responding stations to begin transmitting.

Note:

- ◆ Turning the **Tuning** control clockwise, or pressing Mic [**UP**] after a signal that has stopped Scan drops out, causes scanning to resume immediately upward.
- ◆ Turning the **Tuning** control counterclockwise, or pressing Mic [**DWN**] after a signal that has stopped Scan drops out, causes scanning to resume immediately downward.

■ Selecting Scan Resume Method

- 1 Select the desired band.
- 2 Press [**MNU**] to enter Menu mode.
- 3 Select Menu No. 8 (Scan Resume).



- 4 Press [**SET**] to toggle Time-Operated or Carrier-Operated.
- 5 Press [**MNU**] again to exit Menu mode.

VFO SCAN

VFO Scan allows you to scan all frequencies from the lowest frequency to the highest frequency on the band. The current frequency step size is used.

- 1 Select the desired band.
- 2 Press **[VFO] (1 s)**.
 - The 1 MHz decimal blinks while scanning is in progress.
 - Scan starts at the frequency currently displayed.
- 3 To reverse the scan direction, turn the **Tuning** control or press Mic **[UP]/[DWN]**.
 - Upward scan:
Turn the **Tuning** control clockwise or press Mic **[UP]**.
 - Downward scan:
Turn the **Tuning** control counterclockwise or press Mic **[DWN]**.
- 4 To quit VFO Scan, press **[BAND SEL]** for the band being scanned or **[VFO]**.
 - When scanning the TX band, you can also press Mic **[PTT]** to quit Scan.

Note: The squelch must be closed for Scan to function.

MEMORY SCAN

Memory Scan allows all memory channels containing data to be scanned.

- 1 Select the desired band.
- 2 Press **[MR] (1 s)**.
 - The 1 MHz decimal blinks while scanning is in progress.
 - Scan starts with the channel last recalled.
- 3 To reverse the scan direction, turn the **Tuning** control or press microphone **[UP]/[DWN]**.
 - Upward scan:
Turn the **Tuning** control clockwise or press Mic **[UP]**.
 - Downward scan:
Turn the **Tuning** control counterclockwise or press Mic **[DWN]**.
- 4 To quit Memory Scan, press **[BAND SEL]** for the band being scanned or **[MR]**.
 - When scanning the TX band, you can also press Mic **[PTT]** to quit Scan.

Note:

- ◆ At least 2 or more memory channels must contain data and must not be locked out.
- ◆ The squelch must be closed for Scan to function.
- ◆ The L1 to L3 and U1 to U3 memory channels are not scanned.
- ◆ You can also start Memory Scan when in Channel Display mode. While Scan is being interrupted, the channel number blinks.

■ Locking Out Memory Channels

Memory channels that you prefer not to monitor while scanning can be locked out. Lock out any memory channel with the following procedure:

- 1 Select the desired band.
- 2 Press **[MR]** to enter Memory Recall mode.
- 3 Turn the **Tuning** control, or press Mic **[UP]/[DWN]** to select the desired memory channel.
- 4 Press **[MNU]** to enter Menu mode.
- 5 Select Menu No. 4 (Memory).

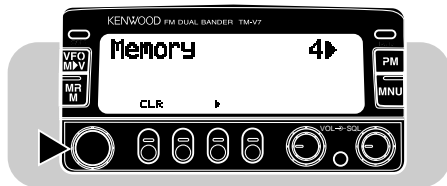

- 6 Press **[>]**, then select item No. 1 (Lock Out).

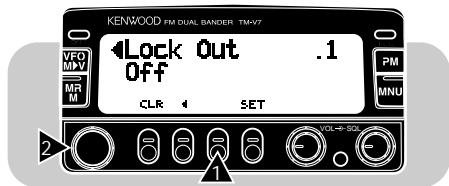

- 7 Press **[SET]** to toggle Lockout ON or OFF (default).

- 8 Press **[MNU]** again to exit Menu mode.

- "L" appears beside the memory channel number to indicate that the channel has been locked out.

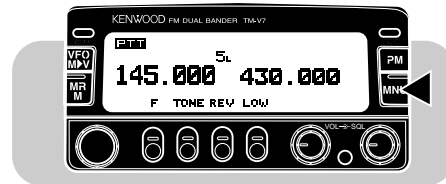

Lockout for an individual channel can be canceled by repeating the above procedure.

Note: The L1 to L3 and U1 to U3 memory channels cannot be locked out.

PROGRAM SCAN

Program Scan is similar to VFO Scan except that you select the frequency range of the scan.

■ Setting Scan Limits

You can store up to three scan ranges on each band, using memory channels L1/U1, L2/U2, and L3/U3.

- 1 Select the desired band.
- 2 Turn the **Tuning** control, or press Mic **[UP]/[DWN]**, to display the desired lower limit.
- 3 Press **[F]**.
- 4 Turn the **Tuning** control, or press Mic **[UP]/[DWN]**, to select channel L1, L2, or L3.

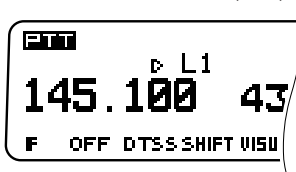

- 5 Press **[MR]**.
 - The lower limit is stored in the channel.

- 6 Turn the **Tuning** control, or press Mic **[UP]/[DWN]**, to display the desired upper limit.
- 7 Press **[F]**.
- 8 Turn the **Tuning** control, or press Mic **[UP]/[DWN]**, to select channel U1, U2, or U3.
 - If you have selected for example L1 in step 4, select U1.

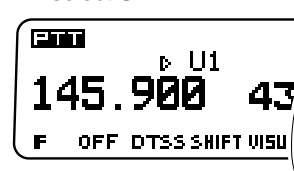

- 9 Press **[MR]**.
 - The upper limit is stored in the channel.
- 10 To confirm the stored scan limits, press **[MR]**, then select the L and U channels.

Note:

- ◆ The lower limit must be lower in frequency than the upper limit.
- ◆ The lower and upper frequency steps must be equal.
- ◆ The lower and upper limits must be selected on the same band.

■ Using Program Scan

- 1 Select a frequency equal to or between the programmed scan limits.
- 2 Press **[VFO] (1 s)**.
 - The 1 MHz decimal blinks while scanning is in progress.
 - Scan starts at the frequency currently displayed.
- 3 To reverse the scan direction, turn the **Tuning** control or press Mic **[UP]/[DWN]**.
 - Upward scan:
Turn the **Tuning** control clockwise or press Mic **[UP]**.
 - Downward scan:
Turn the **Tuning** control counterclockwise or press Mic **[DWN]**.
- 4 To quit Program Scan, press **[BAND SEL]** for the band being scanned or **[VFO]**.
 - When scanning the TX band, you can also press Mic **[PTT]** to quit Scan.

Note:

- ◆ *The squelch must be closed for Scan to function.*
- ◆ *If the frequency step of the current VFO frequency differs from the frequency step of the programmed frequencies, you cannot use Program Scan.*
- ◆ *If the frequency step of the lower limit and upper limit differ, you cannot use Program Scan.*
- ◆ *If the current VFO frequency is within more than one scan range, Scan starts with the range stored in smaller channel numbers.*

MHz SCAN

MHz Scan allows you to scan a 1 MHz segment of the band. The current 1 MHz digit determines the limits of the scan. For example, if the current frequency is 438.400 MHz, then MHz Scan would scan from 438.000 MHz to 438.975 MHz. The exact upper limit depends on the step size selected.

- 1 Select the desired band.
- 2 Start VFO Scan or Program Scan first.
- 3 Press **[MHz]** to start MHz Scan.
- 4 To quit MHz Scan, press **[MHz]** again.
 - If the current frequency is within the program scan range when stopping MHz Scan, Program Scan resumes. Otherwise, VFO Scan resumes.

CALL/VFO SCAN

Use Call/VFO Scan to monitor both the Call channel and the current VFO frequency on the selected band.

- 1 Select the desired band.
- 2 Press **[VFO]** to select VFO mode.
- 3 Press **[CALL] (1 s)** to start Call/VFO Scan.
 - The 1 MHz decimal blinks while scanning is in progress.
- 4 To quit Call/VFO Scan, press **[BAND SEL]** for the band being scanned or **[CALL]**.
 - When scanning the TX band, you can also press Mic **[PTT]** to quit Scan.

9

CALL/MEMORY SCAN

Use Call/Memory Scan to monitor both the Call channel and the memory channel last used.

- 1 Select the desired band.
- 2 Press **[MR]** to enter Memory Recall mode.
- 3 Press **[CALL] (1 s)** to start Call/Memory Scan.
 - The 1 MHz decimal blinks while scanning is in progress.
- 4 To quit Call/Memory Scan, press **[BAND SEL]** for the band being scanned or **[CALL]**.
 - When scanning the TX band, you can also press Mic **[PTT]** to quit Scan.

CONTINUOUS TONE CODED SQUELCH SYSTEM (CTCSS)

CTCSS uses a subaudible tone to control the squelch of transceivers, and by this system you can reject signals from undesired stations. Suppose that only stations "A", "B", and "C" are programmed with the same tone frequency. The squelch in "A" opens only when called by "B" or "C".

USING CTCSS

- 1 Select the desired band.
- 2 Repeatedly press **[TONE]** until "CT" appears.
 - Each time you press **[TONE]**, the selection changes as shown below.

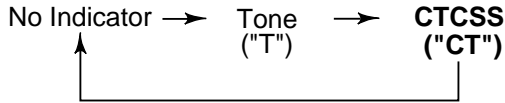

- 3 Select the desired CTCSS frequency.
 - To select this, refer to "Selecting a Tone Frequency" {page 25} and follow steps 2 to 4.
- 4 **When you are called:**

The squelch of your transceiver opens only when the selected tone is received.

When you make a call:

Press and hold Mic **[PTT]**.

Note:

- ◆ You can select a separate tone frequency for the CTCSS and Tone functions.
- ◆ When using DTSS or Page with CTCSS, the squelch opens only if the correct tone is received and the received DTSS code or Page code matches the code stored in your transceiver.
- ◆ If you select a high tone frequency, receiving audio or noise that contains the same frequency portions may cause CTCSS to function incorrectly. To prevent noise from causing this problem, select an appropriate noise squelch level using the **SQL** control.

Automatic Tone Frequency ID

This function automatically identifies the incoming tone frequency on a received signal.

- 1 Press **[TONE] (1 s)** to activate the function.
 - A tone frequency display replaces the frequency display and the 1 Hz decimal begins blinking.
 - When a signal is received, the transceiver begins scanning through all tone frequencies in order to identify the incoming tone frequency. When the frequency is identified, a beep sounds, and the identified frequency appears and blinks. The identified frequency is programmed in place of the currently set CTCSS frequency.
- 2 Press any key to cancel the function.

DUAL TONE SQUELCH SYSTEM (DTSS)

DTSS provides a more refined method than CTCSS to selectively communicate with specific stations. The squelch on the transceiver opens only when the same 3-digit DTMF (Dual Tone Multi-Frequency) code is received that is programmed in this transceiver. You can select a 3-digit code from among 1000 combinations, 000 to 999.

Note:

- ◆ Be aware that audible DTMF tones from other transceivers near you may be picked up by your MC-53DM or MC-45 microphone. If so, this could prevent the functions described in this chapter from working correctly.
- ◆ DTSS does not function while you are storing DTSS codes even if a code is received that matches one already stored in memory.

STORING DTSS CODES

- 1 Select the desired band.
- 2 Press **[F]**, **[DTSS]** to switch the DTSS function ON.
 - "DT" appears.

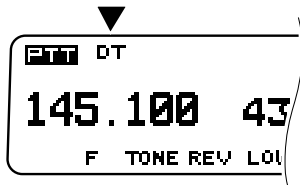

- 3 Press **[F]** (1 s), **[C.SEL]**.

- The current DTSS code appears with the first digit blinking. The default is 000.

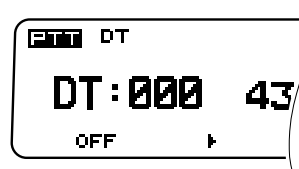

- 4 Use the **Tuning** control or Mic **[UP]/[DWN]** to select the first digit.
 - When using the MC-53DM microphone, you can select three digits by simply pressing numeric keys in sequence.
- 5 Press **[▶]**.
 - The second digit blinks.
- 6 Repeat Steps 4 and 5 to select the second and third digits.
- 7 To switch the DTSS function OFF, repeat pressing **[F]**, **[DTSS]** twice.

Note: The selected DTSS code also can be stored in a memory channel or the Call channel.

USING DTSS

- 1 Select the desired band.
- 2 Press **[F]**, **[DTSS]** to switch the DTSS function ON.

- "DT" appears.

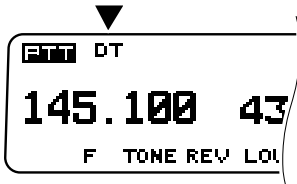

- 3 Select the appropriate DTSS code {page 50}.
- 4 **When you are called:**

The squelch of your transceiver opens only when the stored DTSS code is received.

- If, after DTSS has opened the squelch, no signal is received for more than 2 seconds, the squelch will close.

When you make a call:

Press and hold Mic **[PTT]** to transmit your DTSS code.

- Each time you press **[PTT]**, the DTSS code is transmitted for about 0.5 seconds. After establishing a contact, you can eliminate this by switching the DTSS function OFF.

- 5 To switch the DTSS function OFF, repeat pressing **[F]**, **[DTSS]** twice.

Note:

- ◆ DTSS may not function in the following situations:
 - The other station is using a battery saver function.
 - A repeater ID and the DTSS code are received simultaneously. If difficulty is experienced in these cases, press **[MR]** while in the transmit mode. The DTSS code is re-transmitted.
- ◆ DTSS cannot be used with some repeaters.
- ◆ DTSS also may not function if buttons are pressed or the **VOL** control is turned while a valid DTSS code is received.
- ◆ Both the DTSS status and a DTSS code can be stored in a memory channel or the Call channel. Further, when recalling either a memory channel or the Call channel with DTSS status ON while using the VFO with Page switched ON, page is given priority and the DTSS status switches OFF.

■ DTSS and Repeaters

Pressing Mic **[PTT]** transmits the DTSS signal after a short delay. When using repeaters with long response times, this delay helps the repeater avoid losing a portion of the DTSS code. The delay time is 350 ms during simplex operation.

When using a transmit offset or a split frequency, you can select either 350 ms (default) or 550 ms.

- 1 Press **[MNU]** to enter Menu mode.
- 2 Select Menu No. 12 (Code Squelch).



- 3 Press **[>]**, then select Item No. 1 (CSQ Delay).

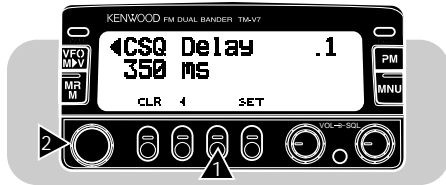

- 4 Press **[SET]** to toggle 350 ms or 550 ms.
- 5 Press **[MNU]** again to exit Menu mode.

Page also uses DTMF codes to address specific stations. When your transceiver transmits a DTMF code, the squelch of only the transceivers that have the same code programmed, opens.

Unlike DTSS, Page allows you to choose whether you will call a single station or a group of stations. In addition, Page offers the added benefit of identifying who called you. When you are called with your Station code, the calling station's code appears on the display. If called with a Group code, the Group code appears.

Note: Be aware that audible DTMF tones from other transceivers near you may be picked up by your MC-53DM or MC-45 microphone. If so, this could prevent the functions described in this chapter from working correctly.

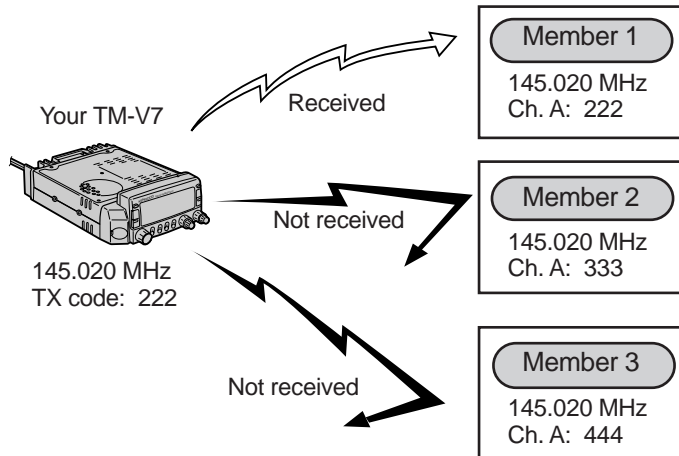

PAGE CODE MEMORY

This transceiver has 7 Page code memory channels on each band. You can select a 3-digit code from among 1000 combinations, 000 to 999 to store in each channel.

Ch. A	Stores your Station code.
Ch. 0	When called, the calling station's code or the Group code is automatically stored.
Ch. 1~5	Stores Group codes or Station codes that you want to call.

Communication Network Example:

Assume that your group members agreed to use 789 as the Group code, and stored DTMF codes as shown:

Your memory	Member 1	Member 2	Member 3
Ch. A: 111	222	333	444
Ch. 1: 222			
Ch. 2: 333	789		
Ch. 3: 444		789	
Ch. 4: 789			789

To call member 1 for example, select channel 1 to transmit 222.

To call members 1, 2, and 3, select channel 4 to transmit 789.

STORING PAGE CODES

Note: Page does not function while you are storing Page codes even if a code is received that matches one already stored in memory.

- 1 Select the desired band.
- 2 Press **[F]**, **[DTSS]** twice to switch Page ON.

- "PAG" appears.



- If DTSS is already ON, press this key combination once.

- 3 Press **[F]** (1 s), **[C.SEL]**.

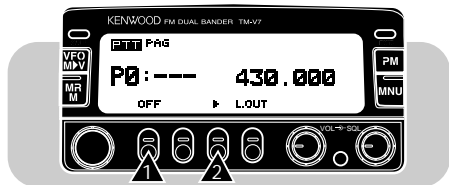

- 4 Use the **Tuning** control or Mic **[UP]**/**[DWN]** to select channel A.

- To quit selection, press **[OFF]**.

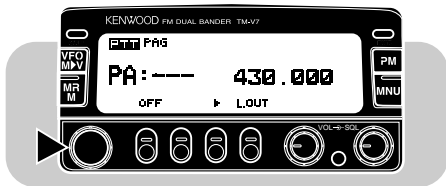

- 5 Press **[▶]**.

- The first digit blinks.
- To quit selection, press **[OFF]**.

- 6 Use the **Tuning** control or Mic **[UP]**/**[DWN]** to select the first digit.

- When using the MC-53DM microphone, you can select three digits by simply pressing numeric keys in sequence.

- 7 Press **[▶]**.

- The second digit blinks.

- 8 Repeat steps 6 and 7 to select the second and third digits.

- 9 Use steps 4 to 8 to store the desired Station codes or Group codes in channels 1 to 5.

- 10 Press **[OFF]** or Mic **[PTT]** to complete the setting.

- You can immediately make a call using the Station code or Group code that you stored last.

- 11 To switch Page OFF, press **[F]**, **[DTSS]**.

CALLING

Note: Before making a call, store your Station code in channel A, and store the desired Station codes or Group codes in channels 1 to 5.

- 1 Select the desired band.
- 2 Tune to the prearranged frequency.
- 3 Press **[F]**, **[DTSS]** twice to switch Page ON.
 - "PAG" appears.
 - If DTSS is already ON, press this key combination once.
- 4 Press **[F]** (1 s), **[C.SEL]**.
- 5 Turn the **Tuning** control, or press Mic **[UP]/[DWN]**, to select the channel that contains the desired Station code or Group code.
- 6 Press **[OFF]** or Mic **[PTT]** to restore the frequency display.
- 7 Press and hold Mic **[PTT]**.
 - The selected Station code or Group code is transmitted along with your Station code.
- 8 To switch Page OFF, press **[F]**, **[DTSS]**.

Note:

- ◆ Each time you press **[PTT]**, the microphone is inhibited and the Page code is transmitted. After establishing a contact, you can eliminate this pause by switching Page OFF.
- ◆ When recalling either a memory channel or the Call channel with DTSS status ON while using the VFO with Page switched ON, page is given priority.

RECEIVING

- 1 Select the desired band, and tune to the prearranged frequency.
- 2 Switch Page ON.
- 3 You are ready to receive a call.
 - When your transceiver receives a signal encoded with your Station code or a Group code, the squelch opens, an alert sounds, and "PAG" blinks.
 - If you are called with your Station code, the display shows the calling station's code.

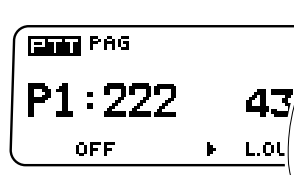

- If called with the Group code, the display shows the group code.



- 4 To respond to the calling station, press Mic **[PTT]** while the Page code is visible on the display.

Note:

- ◆ If, after Page has opened the squelch, no signal is received for more than 2 seconds, the squelch will close.
- ◆ "Err" appears on the display if your transceiver fails to receive the Page code correctly.
- ◆ Page may not function in the following situations:
 - The other station is using a battery saver function.
 - A repeater ID and the Page code are received simultaneously.If difficulty is experienced in these cases, press **[MR]** while in the transmit mode. The Page code is re-transmitted.
- ◆ Page cannot be used with some repeaters.
- ◆ Page also may not function if buttons are pressed or the **VOL** control is turned while a valid Page code is received.
- ◆ When Page is ON, scan cannot be used.

■ Page and Repeaters

Pressing Mic **[PTT]** transmits the Page codes after a short delay. When using repeaters with long response times, this delay helps the repeater avoid losing a portion of the Page codes. The delay time is 350 ms during simplex operation.

When using a transmit offset or a split frequency, you can select either 350 ms (default) or 550 ms.

To select the delay time, use the procedures described in "DTSS and Repeaters" {page 52}. This setting is shared with DTSS.

LOCKING OUT PAGE CODES

This function is useful if you wish to inhibit the transceiver from receiving specific Group codes. When called with your Station code, Page Lockout does not inhibit the transceiver from receiving. After locking out the desired Group codes, you can still use those codes to transmit.

- 1 Select the desired band.
- 2 Switch Page ON.
- 3 Press **[F] (1 s)**, **[C.SEL]**.
- 4 Turn the **Tuning** control, or press Mic **[UP]/[DWN]**, to select the desired channel.
- 5 Press **[L.OUT]** to toggle Lockout ON or OFF.
 - "L" appears beside the Page code to indicate that the Page code has been locked out.

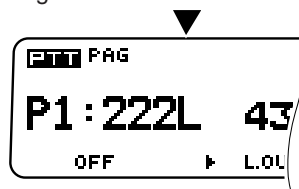

- 6 Press **[OFF]** or Mic **[PTT]** to restore the frequency display.

Repeat the above procedures to unlock the channels.

Note: You cannot lock out memory channel 0.

AUTO PAGE CANCEL

After successfully paging another station, switching Page OFF eliminates sending a Page code each time you transmit. Auto Page Cancel automatically handles this situation when a station you called responds using the correct Page code.

- 1 Press **[MNU]** to enter Menu mode.
- 2 Select Menu No. 12 (Code Squelch).



- 3 Press **[▶]**, then select Item No. 2 (PAG Cancel).



- 4 Press **[SET]** to toggle Manual (default) or Auto.
- 5 Press **[MNU]** again to exit Menu mode.

PAGE ANSWER BACK (U.S.A./ CANADA ONLY)

Page Answer Back informs the other station that you received the Page call. Your transceiver sends the answer back signal only when receiving your station code or a correct Group code.

- 1 Press **[MNU]** to enter Menu mode.
- 2 Select Menu No. 12 (Code Squelch).

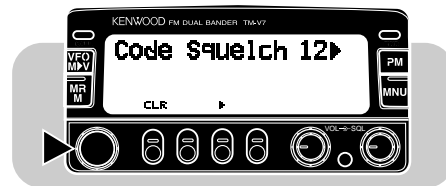

- 3 Press **[▶]**, then select Item No. 3 (Answer Back).



- 4 Press **[SET]** to toggle the function ON or OFF (default).
- 5 Press **[MNU]** again to exit Menu mode.

Note: Once the transceiver sends an answer back signal, it automatically switches Answer Back OFF.

DUAL TONE MULTI-FREQUENCY (DTMF) FUNCTIONS

The following DTMF functions require the MC-53DM or MC-45DM (option) microphone. The keypad on the microphone includes the 12 keys found on a push-button telephone plus an additional 4 keys (A, B, C, D). These additional keys are required for various control operations by some repeater systems.

MAKING DTMF CALLS

- 1 Press and hold Mic **[PTT]**.
- 2 Press the keys in sequence on the keypad to send DTMF tones.
 - The corresponding DTMF tones are transmitted.
 - Your transceiver remains in the transmit mode for 2 seconds after you release each key. So you can release **[PTT]** after beginning to press keys.

Freq. (Hz)	1209	1336	1477	1633
697	1	2	3	A
770	4	5	6	B
852	7	8	9	C
941	*	0	#	D

■ Autopatch (U.S.A. and Canada)

Some repeaters in the U.S.A. and Canada offer a service called Autopatch. Autopatch allows you to access the public telephone network by sending DTMF tones. Some repeaters require a special key sequence to activate Autopatch. Check with the repeater control operator.

■ Mic Keypad Confirmation Tones

When pressing the desired keys on the Mic keypad, this function produces feedback tones for your confirmation.

- 1 Press **[MNU]** to enter Menu mode.
- 2 Turn the **Tuning** control, or press Mic **[UP]/[DWN]**, to select Menu No. 16 (Microphone).
- 3 Press **[▶]**, then select Item No. 6 (DTMF Monitor).

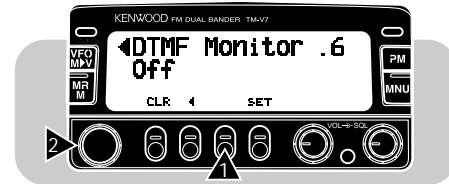

- 4 Press **[SET]** to toggle the function ON or OFF (default).
- 5 Press **[MNU]** again to exit Menu mode.

STORING DTMF NUMBERS FOR AUTOMATIC DIALER

To store a DTMF number with a maximum of 16 digits in any of 10 dedicated DTMF memory channels, follow the procedure below.

Note:

- ◆ Audible DTMF tones from other transceivers near you may be picked up by your MC-53DM or MC-45 microphone. If so, this could prevent the function from working correctly.
- ◆ DTSS or Page does not function while you are storing a DTMF number even if a DTSS or Page code is received that matches one already stored in memory.

- 1 Press **[MNU]** to enter Menu mode.
- 2 Select Menu No. 7 (DTMF Memory).

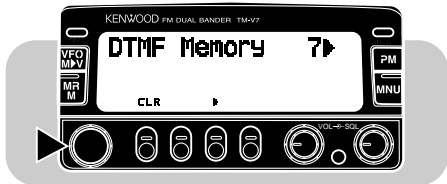

- 3 Press **[▶]**.

 - The memory channel operated last appears.

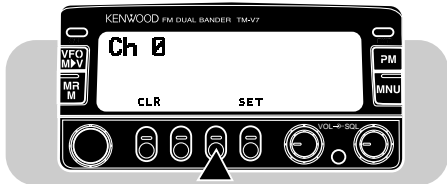

- 4 Press a numeric key 0 to 9 on the Mic keypad to select the desired channel.
- 5 Press **[SET]**.
 - The display for entering a DTMF number appears.

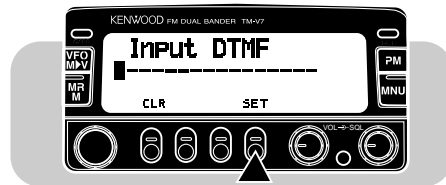

- 6 Use the keypad to enter the digits of the number to be stored.
 - The corresponding DTMF tones are heard.
 - If you enter an incorrect digit, press **[VFO]** to erase all digits entered.
- 7 Press **[SET]** to complete setting.
 - The entered DTMF number appears with the channel number.
- 8 Press **[MNU]** to exit Menu mode.

CONFIRMING STORED DTMF NUMBERS

- 1 Press **[MNU]** to enter Menu mode.
- 2 Select Menu No. 7 (DTMF Memory).

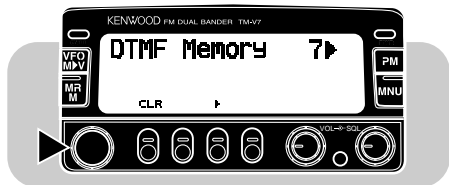

- 3 Press **[▶]**.
 - The memory channel operated last appears.

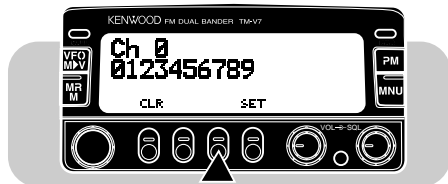

- 4 Press Mic **[0]** to **[9]** to select the desired channel.
- 5 Press **[MNU]** to exit Menu mode.

TRANSMITTING STORED DTMF NUMBERS

To transmit a stored DTMF number, follow the procedure below.

- 1 Press Mic **[PTT]** + **[PF]**.
 - The display for selecting a DTMF memory channel appears.

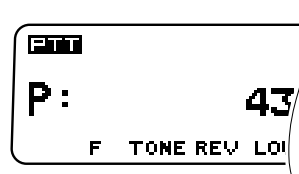

- 2 Press Mic **[0]** to **[9]** to select the desired channel.
 - The number stored in the channel scrolls across the display accompanied by DTMF tones from the speaker.
 - After the transmission, the frequency display is restored.
 - If a memory channel that does not contain DTMF numbers is selected, an error beep sounds.

Note: If the control band differs from the TX band, you cannot transmit stored DTMF numbers.

AUXILIARY FUNCTIONS

TIME-OUT TIMER (TOT)

It is sometimes necessary or desirable to restrict a single transmission to a specific maximum time. This feature can be useful when accessing repeaters to prevent repeater time-outs, or when trying to conserve battery power.

When TOT times out, the transceiver generates beeps and automatically returns to receive mode. To resume transmitting, release and then press Mic **[PTT]** again.

You can change the default TOT time (10 minutes).

- 1 Press **[MNU]** to enter Menu mode.
- 2 Select Menu No. 11 (TOT).

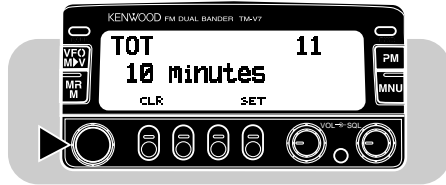

- 3 Press **[SET]** to select the desired TOT time from 3, 5, and 10 (default) minutes.
- 4 Press **[MNU]** again to exit Menu mode.

AUTOMATIC POWER OFF (APO)

Automatic Power Off is a background function that monitors whether any buttons or keys have been pressed, or whether the **Tuning** control has been turned. After 3 hours pass with no operations, APO turns OFF the power. However, 1 minute before the power turns OFF, "APO" appears and blinks, and a series of warning tones sound.

Note: If the squelch opens or any settings are changed during the 3 hour period while APO is ON, the timer resets. When the squelch closes or you stop changing the settings, the timer begins counting again from 0.

- 1 Press **[MNU]** to enter Menu mode.
- 2 Select Menu No. 10 (APO).

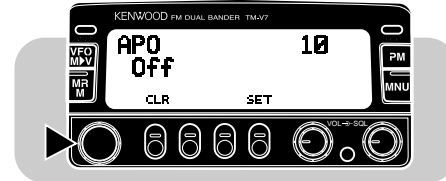

- 3 Press **[SET]** to toggle the function ON or OFF (default).
- 4 Press **[MNU]** again to exit Menu mode.

AUTOMATIC BAND CHANGE (A.B.C.)

A.B.C. will temporarily switch the RX only band to the TX band immediately after a signal is received on the RX only band. This function allows you to reply to a caller without manually selecting the correct band.

Press **[F]**, **[MNU]** to toggle the function ON or OFF.

- "A.B.C." appears when the function is ON.



- Pressing **[BAND SEL]** or Mic **[PTT]** also cancels A.B.C.
- The original TX band is restored 2 seconds after the signal drops out.

Note:

- ◆ You cannot use A.B.C. when in Single-band mode. After activating A.B.C., changing from Dual-band mode to Single-band mode deactivates A.B.C. Switching back to Dual-band mode re-activates A.B.C.
- ◆ After activating A.B.C., starting Visual Scan deactivates A.B.C. Canceling Visual Scan re-activates A.B.C.

ADVANCED INTERCEPT POINT (AIP)

AIP helps eliminate interference and reduce audio distortion caused by intermodulation. This problem is often apparent in urban areas when the RX band is extremely crowded.

- 1 Select the desired band.
- 2 Press **[MNU]** to enter Menu mode.
- 3 Select Menu No. 9 (AIP).

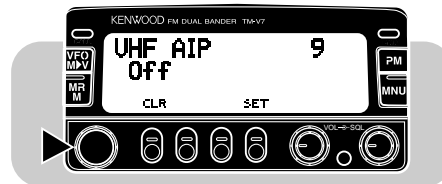

- "VHF AIP" or "UHF AIP" appears depending on which band you selected.
- 4 Press **[SET]** to toggle the function ON or OFF (default).
 - 5 Press **[MNU]** again to exit Menu mode.

Note: While using VHF/VHF RX or UHF/UHF RX, switching the AIP function ON or OFF on the main band also activates or deactivates AIP on the sub band.

DUAL BAND RX

You can select one of three configurations to simultaneously receive two frequencies. Configuration 1 is the default.

Configuration	RX	TX
1	VHF and UHF	VHF or UHF
2	VHF and VHF	VHF
3	UHF and UHF	UHF

- 1 Press the right **[BAND SEL]** to select VHF/VHF RX or the left **[BAND SEL]** to select UHF/UHF RX.
- 2 Press **[F]**, **[CONT SEL]** to toggle the function ON or OFF.

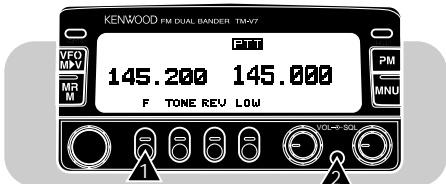

- The above display appears when you selected VHF/VHF RX.
- You can equally use the two bands to transmit (not simultaneously).
- While transmitting on one band in VHF/VHF or UHF/UHF mode, the RX function is OFF on the other band.

Note: Receiver performance, for example image rejection and sensitivity, may be less when using either VHF/VHF or UHF/UHF mode. If you select the same frequency on both bands, the S-meter reading may be affected. Also, receive volume may be lower depending on the position of the **VOL** control.

BLANKING A BAND DISPLAY

If you have no plans to use one of the bands, you may want to quit frequency display on the unused band. This function makes it simpler to read the information you need.

Press **[F]**, **[BAND SEL]** to toggle the function ON or OFF.

- Press the left **[BAND SEL]** to blank the VHF band or the right **[BAND SEL]** to blank the UHF band.



Note: You cannot operate the blanked band nor use this band to receive or transmit.

PROGRAMMABLE VFO

If you want, you can set limits for the minimum and maximum frequencies that are selectable using the **Tuning** control or Mic **[UP]/[DWN]**.

- 1 Select the desired band.
- 2 Press **[MNU]** to enter Menu mode.
- 3 Select Menu No. 6 (Program VFO).

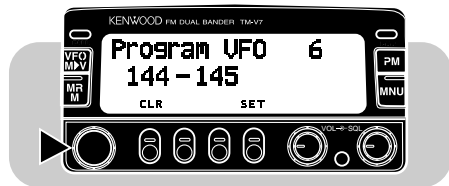

- 4 Press **[SET]**, then select the lower frequency limit.
- 5 Press **[SET]** again, then select the upper frequency limit.
- 6 Press **[SET]** once more to complete the setting.
- 7 Press **[MNU]** to exit Menu mode.

SWITCHING AM/FM MODE (SOME VERSIONS ONLY)

Some versions of the transceiver can also receive in AM mode. The AM mode is automatically selected when any frequency in the range of 118.000 to 135.995 MHz (AIR band) is chosen. Outside this range, the default is FM. However, either mode can be selected manually on any VHF frequency. Crossing the 135.995 MHz boundary restores the default mode.

- 1 Select the VHF band.
- 2 Press **[MHz] (1 s)** to toggle FM or AM.
 - When AM is selected, a bar replaces the 1 MHz decimal on the display.



CHANGING FREQUENCY STEP SIZE

Choosing the correct step size is essential in order to select your exact receive frequency using the **Tuning** control or Mic **[UP]/[DWN]**. The default step size on the VHF band is 5 kHz (U.S.A./ Canada) or 12.5 kHz (Europe/ General). The default on the UHF band is 25 kHz no matter which market version.

- 1 Select the desired band.
- 2 Press **[F]** (1 s), **[STEP]**.

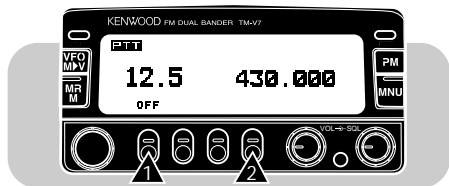

- 3 Turn the **Tuning** control, or press Mic **[UP]/[DWN]**, to select the desired step size.
- 4 Press **[OFF]** to complete the setting.

Changing between step sizes may result in a change of the displayed frequency. For example, assume 144.995 MHz is displayed with a 5 kHz step size selected. Changing to a 12.5 kHz step size alters the displayed frequency. See the accompanying tables.

5, 10, 15, 20 or 50 kHz Step Size → 6.25, 12.5 or 25 kHz Step Size	
Displayed Frequency (10 kHz/ 1 kHz)	Displayed Frequency (10 kHz/ 1 kHz)
00, 05, 10, 15	00
20, 25, 30, 35	25
40, 45, 50, 55	50
60, 65, 70, 75, 80, 85, 90, 95	75

6.25, 12.5 or 25 kHz Step Size → 5, 10, 15, 20 or 50 kHz Step Size	
Displayed Frequency (10 kHz/ 1 kHz)	Displayed Frequency (10 kHz/ 1 kHz)
00, 6.25	00
12.5, 18.75	10
25	20
31.25, 37.5	30
43.75	40
50, 56.25	50
62.5, 68.75	60
75	70
81.25, 87.5	80
93.75	90

CHANGING MULTI-FUNCTION BUTTON LABELS

This transceiver shows button labels on the lower portion of the display. You can also change the default configuration to one of the following types. Select the configuration depending on which functions you use most frequently.

Basic State Display Labels [F] [TONE] [DTSS] [LOW]	Labels after Pressing [F] [OFF] [SHIFT] [REV] [VISUAL]
---	---

or

Basic State Display Labels [F] [VISUAL] [REV] [LOW]	Labels after Pressing [F] [OFF] [TONE] [SHIFT] [DTSS]
--	--

Note:

- ◆ The labels that appear after pressing [F] (1 s) are identical no matter which configuration you select.
- ◆ After selecting the F/TONE/DTSS/LOW configuration, press [F], [REV] (1 s) to activate ASC (page 27) and press [F], [REV] to cancel the function.
- ◆ After selecting the F/VISUAL/REV/LOW configuration, press [F], [TONE] (1 s) to activate Automatic Tone Frequency ID (page 49) and press any key to cancel the function.

- 1 Press [MNU] to enter Menu mode.
- 2 Select Menu No. 2 (Front Panel).
- 3 Press [▶], then select Item No. 3.

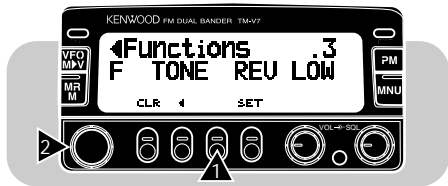

- 4 Press [SET] repeatedly until the desired configuration appears.
- 5 Press [MNU] again to exit Menu mode.

CHANGING BEEP VOLUME

The transceiver beeps each time you press a button or a microphone key. You can change the beep volume or turn it off.

- 1 Press [MNU] to enter Menu mode.
- 2 Select Menu No. 14 (Audio).



- 3 Press [▶], then select Item No. 1 (Beep Volume).

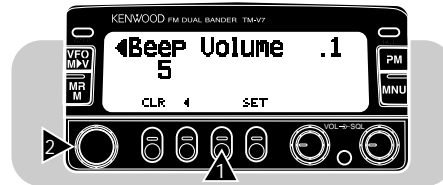

- 4 Press [SET], then select the volume from level 1 (min.) to 7 (max.) and OFF. The default is level 5.

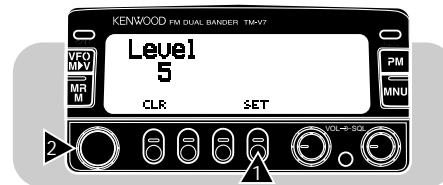

- 5 Press [MNU] again to exit Menu mode.

LOCK

Occasionally, you may want to lock the buttons, keys, or controls to prevent yourself or others from accidentally changing the transceiver settings.

■ Transceiver Lock

Transceiver Lock is suitable for a typical mobile installation where you alter most functions with your microphone. This Lock disables all functions excluding the following:

- PWR switch
- **[F]**
- **[F], [MHz]**
- **SQL** controls
- VOL controls
- Microphone keys

Press **[F], [MHz]** to toggle Transceiver Lock ON or OFF.

- "LOCK" appears when the function is ON.



■ All Lock

All Lock is ideal when you have no plans to transmit but you want to monitor a specific channel. This Lock disables all functions excluding the following two:

- PWR switch
 - **[MHz]+ POWER ON**
- 1 Switch Transceiver Lock ON.
 - 2 Press **[MHz]+ POWER ON** to toggle All Lock ON or OFF.
 - "A.LOCK" appears when the function is ON.



S-METER SQUELCH

By activating S-meter Squelch, the squelch does not open until a signal with the same or greater strength than the S-meter setting is received. This function is useful to eliminate constantly resetting the squelch when receiving weak stations that you have no interest in. You can set a different S-meter value on each band.

- 1 Select the desired band.
- 2 Press **[MNU]** to enter Menu mode.
- 3 Select Menu No. 13 (S-Meter).

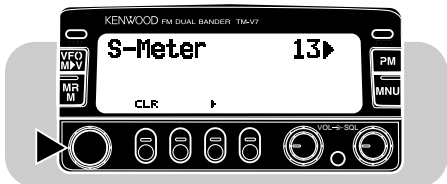

- 4 Press **[>]**, then select Item No. 1 (S-Meter SQL).

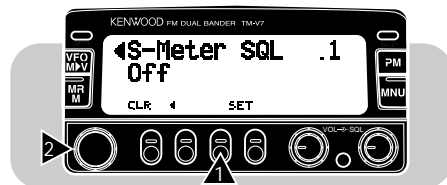

- 5 Press **[SET]** to toggle the function ON or OFF (default).
- 6 Press **[MNU]** again to exit Menu mode.
 - The S-meter setting scale appears.

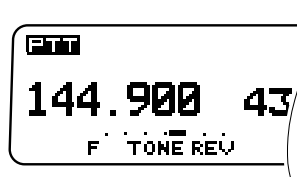

- 7 To select the desired S-meter setting, turn the left (VHF) or right (UHF) **SQL** control depending on which band you selected.

■ Squelch Hang Time

When using S-meter Squelch, you may want to adjust the time interval between when the received signals drop and when the squelch closes.

- 1 Press **[MNU]** to enter Menu mode.
- 2 Select Menu No. 13 (S-Meter).
- 3 Press **[>]**, then select Item No. 2 (Hang Time).



- 4 Press **[SET]** to select from OFF, 125 ms, 250 ms and 500 ms. The default is OFF.
- 5 Press **[MNU]** again to exit Menu mode.

Note: You cannot select Item No. 2 (Hang Time) unless first you switch S-meter Squelch ON.

POWER-ON MESSAGE

Each time you switch the transceiver ON, the factory-default message appears and stays for approximately 2 seconds. You can program your favorite message in place of “KENWOOD”.

- 1 Press **[MNU]** to enter Menu mode.
- 2 Select Menu No. 2 (Front Panel).

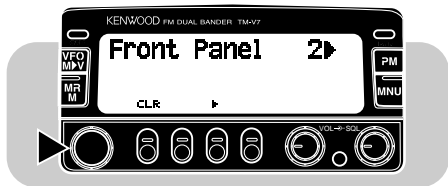

- 3 Press **[▶]**, then select Item No. 2 (Power On Msg).



- 4 Press **[SET]**.
 - The last digit blinks.
- 5 Press **[VFO]**.
 - The cursor moves to the first digit.
- 6 Turn the **Tuning** control, or press Mic **[UP]/[DWN]**, to select the first digit.

- To skip by four characters when operating the above control or keys, press **[MHz]**. Press **[MHz]** again to quit this jump function.

- 7 Press **[▶]**.
 - The second digit blinks.
- 8 Repeat steps 6 and 7 to enter up to 7 digits.
 - After entering the 7th digit, pressing **[▶]** causes an error beep to sound.
 - To re-enter the preceding digit, press **[◀]**.
 - To clear all digits and move back to the first digit, press **[VFO]**.
- 9 Press **[SET]** again to complete the setting.
- 10 Press **[MNU]** to exit Menu mode.

DISPLAY DEMONSTRATION MODE

By initiating this mode, various pre-programmed displays appear. You still can normally use the transceiver in this mode. Pressing buttons or microphone keys, or turning the **Tuning** control restores the operating display immediately. If there is no button/key entry or **Tuning** control adjustment for approximately 12 seconds, the transceiver reverts back to Demonstration mode.

Press **[F]+ POWER ON** to toggle the mode ON or OFF.

CHANGING DISPLAY CONDITIONS

■ Display Dimmer

You can change the display illumination to suit the lighting conditions where you are operating.

- 1 Press **[MNU]** to enter Menu mode.
- 2 Select Menu No. 3 (Display).

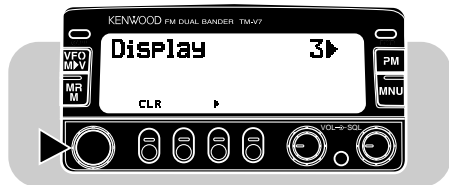

- 3 Press **[>]**, then select Item No. 3 (Dimmer).

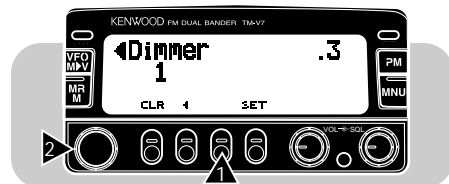

- 4 Press **[SET]**, then select from level 1 (brightest) to 4 (dimmet) and OFF. The default is level 1.

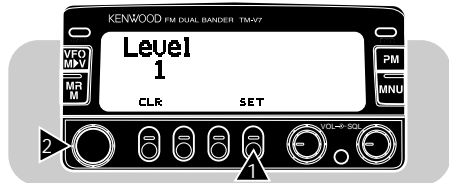

- 5 Press **[MNU]** again to exit Menu mode.

■ Auto Dimmer Change

This function increases the display intensity one step brighter for approximately 5 seconds when you press a front panel button or Mic key, or turn the **Tuning** control. No change occurs if you have selected the brightest level.

- 1 Press **[MNU]** to enter Menu mode.
- 2 Select Menu No. 3 (Display).

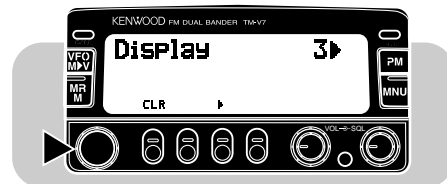

- 3 Press **[>]**, then select Item No. 4 (Auto Dimmer).

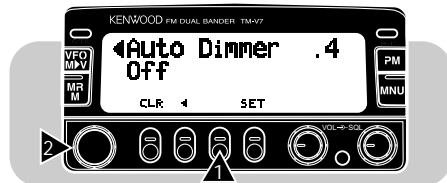

- 4 Press **[SET]** to toggle the function ON or OFF (default).
- 5 Press **[MNU]** again to exit Menu mode.

■ Display Contrast

Select the display contrast that provides the best display visibility. The display visibility changes depending on the front panel mounting angle, display reversal status (positive/negative), and ambient temperature.

- 1 Press **[MNU]** to enter Menu mode.
- 2 Select Menu No. 3 (Display).



- 3 Press **[▶]**, then select Item No. 2 (Contrast).



- 4 Press **[SET]**, then select the contrast level in the range from level 1 to 16. The default is level 8.



- 5 Press **[MNU]** again to exit Menu mode.

■ Positive/Negative Reversal

You can also change the display status between Positive and Negative.

- 1 Press **[MNU]** to enter Menu mode.
- 2 Select Menu No. 3 (Display).



- 3 Press **[▶]**, then select Item No. 1 (Reverse Mode).

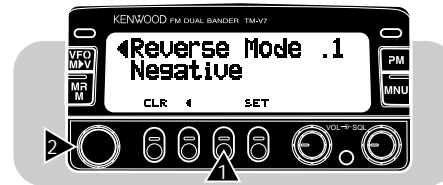

- 4 Press **[SET]** to toggle Negative (default) or Positive.
- 5 Press **[MNU]** again to exit Menu mode.

CONFIGURING PROGRAM FUNCTION KEYS

The Programmable Function keys are **[PF]**, **[MR]**, **[VFO]**, and **[CALL]** located on the face of the microphone. If you prefer, you can change the default functions assigned to these keys.

Programmable Function Key	Default Function
[PF]	TX Band Select
[MR]	Memory Recall
[VFO]	VFO Select
[CALL]	Call Channel Select

To assign a front panel key function:

- 1 Press one of the following key combinations depending on which key you want to re-program:

Mic **[PF]+ POWER ON** ("PF 1" appears)

Mic **[MR]+ POWER ON** ("PF 2" appears)

Mic **[VFO]+ POWER ON** ("PF 3" appears)

Mic **[CALL]+ POWER ON** ("PF 4" appears)

- 2 Press the key or key combination on the front panel that you want to assign.

- The following types of front panel key functions can be assigned:

[KEY]	[KEY] (1 s)	[F], [KEY]	[F] (1 s), [KEY]
--------------	--------------------	-------------------	-------------------------

- The following types of front panel key functions cannot be assigned:

[KEY]+ POWER ON	[F]	[F] (1 s)
[F]+ Mic [KEY]	PWR switch	Tuning control
VOL control	SQL control	

- The front panel key will still function normally after "copying" its function to a Programmable Function key.
- To restore the default functions shown in the table above, do a Full Reset (page 35).

Note:

- ◆ If the **LOCK** switch located on the rear of the microphone is **ON**, you cannot re-program the Programmable Function keys.
- ◆ Pressing the **PTT** switch in step 2 assigns the VFO/MR Switch function.

To assign a function unavailable using the front panel keys:

- 1 Press **[MNU]** to enter Menu mode.
- 2 Select Menu No. 16 (Microphone).



- 3 Press **[▶]**, then select Item No. 2 (PF 1) to No. 5 (PF 4).

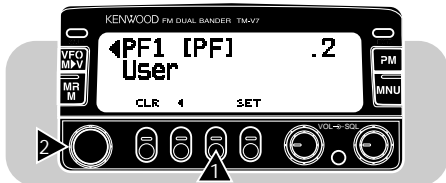

- 4 Press **[SET]** to select the desired function.
 - Each time you press **[SET]**, the selection changes as shown below:
User Setting → Monitor → Enter → Voice → PWR switch
(PF 1 only) → 1750 Hz Tone (TM-V7E only)
- 5 Press **[MNU]** again to exit Menu mode.

User Setting:

Selects the front panel key function you assigned (page 72).

Monitor:

Makes the squelch open and allows you to monitor activity on the current frequency. This function is useful when adjusting the volume or when receiving weak signals.

- Pressing the re-programmed Mic key toggles Monitor ON or OFF.
- Scan will not function if Monitor is ON (squelch open).

Enter:

Allows you to enter digits from the MC-53DM microphone. Refer to "KEYPAD DIRECT ENTRY" (page 74).

Voice:

Activates or deactivates the function that announces the current Control band frequency using beeps of different frequencies. Press any key to stop beeps.

PWR switch:

Turns the transceiver ON or OFF. This function can be assigned only to PF 1.

1750 Hz Tone (TM-V7E only):

Activates the Tone function and transmits a 1750 Hz tone while you are holding down the re-programmed Mic key. You need not press Mic **[PTT]**.

- You can also use Transmit Hold to continuously send a 1750 Hz tone for 2 seconds after releasing the re-programmed Mic key. To activate this function, access item No. 3 (1750 Hz Timer) in Menu No. 5 (Repeater).

KEYPAD DIRECT ENTRY

You can select the desired operating frequency, memory channel, or tone frequency by entering numbers directly from the MC-53DM microphone. To use this function, assign the Enter function to any Programmable Function key first {page 72}.

■ Operating Frequency Entry

- 1 Select the desired band.
- 2 Press **[VFO]** to select VFO mode.
- 3 Press the Mic key re-programmed with Enter.
 - The display for Direct Frequency Entry appears.

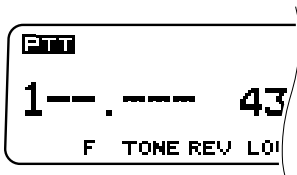

- 4 Use the Mic keypad to enter the desired frequency.
 - Enter the digits in order from the most significant down to the least significant.
 - When the current step size is 5 kHz, 10 kHz, 15 kHz, 20 kHz, 25 kHz, or 50 kHz, enter numeric values down to the 1 kHz digit. Enter either 0 or 5 for the 1 kHz digit.
 - On versions with receiver coverage wider than 10 MHz, enter from the 10 MHz digit. For other versions, begin entering from the 1 MHz digit.

Note:

- ◆ If you press any key other than **[0] ~ [9]** or **[Enter]**, or if you do not make the next entry within 10 seconds, direct entry is canceled and the VFO mode is restored.
- ◆ If you press Mic **[Enter]** while entering a frequency, the new data is accepted for the digits entered and the previous data remains unchanged for the digits not yet entered.
- ◆ Except for the 1 kHz digit, entering a digit that is outside the allowable range causes the nearest digit within range to be displayed. For the 1 kHz digit, pressing **[0] ~ [4]** selects "0" and pressing **[5] ~ [9]** selects "5".
- ◆ When the current step size is 6.25 kHz, 12.5 kHz, or 25 kHz, entering the 10 kHz digit completes frequency setting. The 10 kHz and subsequent digits are set according to which key is pressed for the 10 kHz digit as shown in the table below.

10 kHz Key	Frequency (kHz)	10 kHz Key	Frequency (kHz)
0	00	5	50
1	12.5	6	62.5
2	25	7	75
3	37.5	8	87.5
4	37.5	9	87.5

■ Memory Channel Number Entry

- 1 Select the desired band.
- 2 Press **[MR]** to enter Memory Recall mode.
- 3 Press the Mic key re-programmed with Enter.
 - "--" or "---" appears depending on the number of memory channels available on the current band.

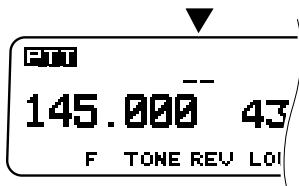

- 4 Use the Mic keypad to enter 2 or 3 digits.
 - To recall channel 3, for example, enter "03" or "003".
 - If you press any key other than **[0]** ~ **[9]**, or if you do not make the next entry within 10 seconds, the previous frequency display will be restored.
 - If you enter a memory channel that does not contain data, an error beep sounds.

■ Tone Frequency Number Entry

- 1 Select the desired band.
- 2 Press **[TONE]** to activate the Tone function.
- 3 Press **[F] (1 s)**, **[T.SEL]**.
 - The current tone frequency appears.
- 4 Press the Mic key re-programmed with Enter.
 - "--" appears.

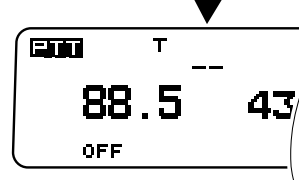

- 5 Use the Mic keypad to enter the Tone No. corresponding to the desired tone frequency.
 - Consult the table given in "Selecting a Tone Frequency" {page 25} to find out how the Tone Nos. correspond to the tone frequencies.
 - To select Tone No. 3 (74.4 Hz), for example, enter "03".
 - If you press any key other than **[0]** ~ **[9]**, or if you do not make the next entry within 10 seconds, the previous frequency display will be restored.

CHANGING SPEAKER CONFIGURATIONS

You can enjoy a variety of speaker configurations by using one or two external speakers. Select either mode 1 or mode 2 depending on which band the internal speaker and/or the external speakers should function.

When using one external speaker connected to speaker jack 1:

Mode 1: VHF band (external)/ UHF band (external)

Mode 2: VHF band (external)/ UHF band (external)

When using one external speaker connected to speaker jack 2:

Mode 1: VHF band (internal)/ UHF band (external)

Mode 2: VHF band (external)/ UHF band (internal)

When using two external speakers:

Mode 1: VHF band (external 1)/ UHF band (external 2)

Mode 2: VHF band (external 2)/ UHF band (external 1)

- 1 Press **[MNU]** to enter Menu mode.
- 2 Select Menu No. 14 (Audio).
- 3 Press **[▶]**, then select Item No. 2 (Speaker).

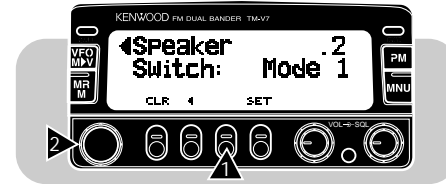

- 4 Press **[SET]** to toggle mode 1 (default) or mode 2.
- 5 Press **[MNU]** again to exit Menu mode.

MICROPHONE CONTROL

You can change numerous transceiver settings with the MC-53DM or MC-45DM microphone without using the transceiver buttons or controls. DTMF tones are used for this remote control operation. First switch Microphone Control ON using Menu Set-up {page 78}.

Note: Audible DTMF tones from other transceivers near you may be picked up by your MC-53DM or MC-45DM microphone. If so, this could prevent the functions from working correctly.

The following table shows what function is switched ON and OFF or which setting is changed by pressing the DTMF keys.

Key	Function	Key	Function
1	Visual Scan	9	Squelch Adjustment ²
2	Tone/ CTCSS	0	TX Power Change
3	Reverse	A	Enter
4	1 MHz Step Change	B	Control Band Select
5	Monitor	C	—
6	Frequency Readout by Beeps ¹	D	[F] key
		*	Frequency Down
7	Volume Change ²	#	Frequency Up
8	Dual Band RX		

¹Transceivers equipped with the optional VS-3 unit announce the displayed information {page 82}.

²After pressing this key, press [*] to lower or [#] to raise the level.

You can also make the following settings by pressing [F] first (ex. [F], Mic [2]).

Key	Function	Key	Function
2	Tone Select ¹	6	DTMF Keypad Unlock
3	Offset Direction Select	C	Repeater Function ²
5	DTMF Keypad Lock		

¹After activating the Tone function, press [F], Mic [2], then press [*] or [#] to change the tone frequency.

²U.S.A./ Canada only

Note:

- ◆ **U.S.A. only:** It is illegal to transmit control codes on the VHF band. Transmit control codes only on the UHF band.
- ◆ You cannot activate both Volume Change and Squelch Adjustment at the same time.
- ◆ When you recall a memory channel containing DTSS or Page ON status after activating Microphone Control, DTSS or Page will not function.

ACTIVATING MICROPHONE CONTROL

- 1 Press **[MNU]** to enter Menu mode.
- 2 Select Menu No. 16 (Microphone).



- 3 Press **[▶]**, then select Item No. 1 (Mic Control).



- 4 Press **[SET]** to toggle the function ON or OFF (default).
- 5 Press **[MNU]** again to exit Menu mode.

PACKET OPERATION

Connect this transceiver to your personal computer via a Terminal Node Controller (TNC) {page 6}. You can send Email to far away stations or obtain a variety of information via your local bulletin boards, or you may enjoy other Packet applications. Reference material for starting Packet operation should be available at any store that handles Amateur Radio equipment.

ACTIVATING DATA TX/RX BAND

If you prefer, you can send or receive data using a RX-only band where "PTT" is invisible. The band with "PTT" is used for voice communications.

- 1 Press **[MNU]** to enter Menu mode.
- 2 Select Menu No. 15 (Data Transfer).
- 3 Press **[▶]**, then select Item No. 2 (Data Band).

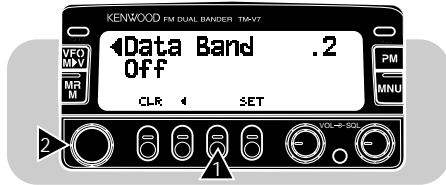

- 4 Press **[SET]** to toggle the function ON or OFF (default).
- 5 Press **[MNU]** again to exit Menu mode.
 - "-Data-" appears for the Data TX/RX band.

1200/ 9600 bps OPERATION

Select 1200 bps or 9600 bps for the data transfer rate, depending on the type of your TNC.

1200 bps:

The Transmit data input (PKD) sensitivity is 40 mV_{P-P}, and the input impedance is 10 kΩ. This is suitable for a typical 1200 bps TNC.

9600 bps:

The Transmit data input (PKD) sensitivity is 2 V_{P-P}, and the input impedance is 10 kΩ. This is suitable for most 9600 bps TNCs. Select 9600 bps if using a TNC with dual speed capability that only has a 2 V_{P-P} output.

- 1 Press **[MNU]** to enter Menu mode.
- 2 Select Menu No. 15 (Data Transfer).
- 3 Press **[▶]**, then select Item No. 1 (Data Speed).

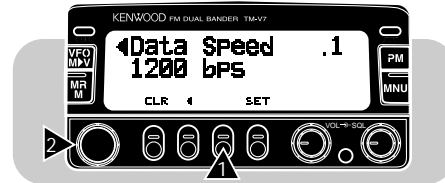

- 4 Press **[SET]** to toggle 1200 bps (default) or 9600 bps.
- 5 Press **[MNU]** again to exit Menu mode.

Note:

- ◆ If the TX delay of your TNC is not long enough, connection errors may occur. If connection errors frequently occur, it is recommended to set the TX delay parameter on the TNC to 300 ms by using your computer.
- ◆ Using a modulator input level that is far different from the optimum 40 mV_{P-P} or 2 V_{P-P} specifications may result in deterioration of the S/N ratio or signal distortion. This could result in increased errors or a complete failure to connect with other stations.
- ◆ If the modulator input level exceeds approximately 3 V_{P-P} the limiter circuit functions to maintain the same transmit bandwidth as that of 3 V_{P-P} .
- ◆ Packet operation, easily affected by transmit and receive conditions, requires a full-scale S-meter reading for reliable communication. When the S-meter reads less than maximum during 9600 bps operation, communication errors are frequent.
- ◆ Inputting 9600 bps GMSK signals at too high a level or inputting significantly distorted signals into the transceiver can cause errors and a wide transmit bandwidth that may interfere with other stations.

■ DATA Connector Pin Functions

This section describes each pin of the DATA connector equipped on this transceiver.

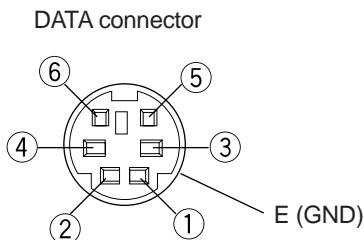

Pin No.	Pin Name	Function
1	PKD	Packet data input <ul style="list-style-type: none"> • TX data from TNC to transceiver
2	DE	Ground for PKD
3	PKS	Packet standby <ul style="list-style-type: none"> • TNC can use this pin to inhibit the transceiver microphone input while transmitting packet signals.
4	PR9	Output of detected 9600 bps data (500 mV_{P-P} , $10\text{ k}\Omega$) <ul style="list-style-type: none"> • Also functions as a common pin for 1200 bps and 9600 bps data output.
5	PR1	Output of detected 1200 bps data (500 mV_{P-P} , $10\text{ k}\Omega$)
6	SQC	Squelch control output <ul style="list-style-type: none"> • Inhibits TNC data transmitting while transceiver squelch is open. • Prevents interference to voice communications on the same frequency. Also prevents retries. • Output Level <ul style="list-style-type: none"> Open squelch: $+5\text{ V}$ (High) Closed squelch: 0 V (Low)

Note:

- ◆ If your TNC has a common pin for 1200 bps and 9600 bps data input, connect this pin to the DATA connector PR9 pin. Shorting the PR9 and PR1 pins will cause the TNC to malfunction.
- ◆ When DC voltage is input to the PR1 pin, the TNC may not function. If this problem happens, add a $10\text{ }\mu\text{F}$ capacitor between the PR1 pin and the TNC. Be careful about the polarity of the capacitor.

REPEATER FUNCTION (U.S.A. / CANADA ONLY)

This transceiver is capable of repeating signals originating from either the VHF or UHF band. For example, a signal received on the VHF band is retransmitted on the UHF band. Similarly, a signal received on the UHF band is retransmitted on the VHF band. You can choose Locked-band Repeater mode or Cross-band Repeater mode.

Note:

- ◆ You cannot activate the Repeater function after switching ON the DTSS or Page, after selecting VHF/VHF or UHF/UHF mode, or while blanking a band display.
- ◆ Activating the Repeater function switches OFF Automatic Band Change (A.B.C.) or Automatic Simplex Checker (ASC).
- ◆ The Time-Out Timer is locked at 3 minutes.

LOCKED-BAND REPEATER

The transceiver always uses the same band to receive or transmit a signal as a repeater.

- 1 Press the right or left **[BAND SEL]** depending on which band will be used for transmitting.
- 2 Press the left **[BAND SEL]+ POWER ON** to enter Locked-band Repeater mode.
 - “PTT” blinks.
 - To exit this mode, repeat the same key operation.

CROSS-BAND REPEATER

Unlike Locked-band Repeater mode, the transceiver can also switch the current RX only band to the TX band when receiving a signal on the TX band.

- 1 Press the right or left **[BAND SEL]**.
- 2 Press **[CONT SEL]**.
- 3 Press the left **[BAND SEL]+ POWER ON** to enter Cross-band Repeater mode.
 - “PTT” blinks.
 - To exit this mode, repeat the same key operation.

TX HOLD

This function keeps the transceiver in transmit mode for approximately 500 ms after signals drop.

- 1 Press **[MNU]** to enter Menu mode.
- 2 Select Menu No. 17 (Repeater).



- 3 Press **[SET]** to toggle the function ON (default) or OFF.
- 4 Press **[MNU]** again to exit Menu mode.

VS-3 VOICE SYNTHESIZER (OPTIONAL)

Install the optional VS-3 unit to use this function {page 84}. Each time you change the transceiver mode such as VFO or Memory Recall, the transceiver automatically announces the new mode.

The table below shows what the transceiver automatically announces when it enters a new mode.

Key Pressed	New Mode	Announcement
[VFO]	VFO	“VFO”
[MR]	Memory Recall	“MR”
[CALL]	Call Channel	“Call”
[PM]	Programmable Memory	“PM”
[MNU]	Menu	“Menu”
[BAND SEL]	New TX/ Control band	Current frequency ¹
Mic PF key programmed with Enter {page 72} ²	Keypad Direct Entry	“Enter”

¹When pressed in Memory Recall mode, the transceiver announces the channel number, “channel”, and the frequency.

²When pressed in VFO or Memory Recall mode.

In addition, the transceiver announces the displayed information as follows when pressing Mic [6] in Microphone Control mode {page 77} or the PF key programmed with Voice {page 72}.

- In VFO mode, announces the VFO frequency on the Control band beginning with the 100 MHz digit. For the MHz decimal point, announces “point”.
- In Memory Recall mode, announces the channel number, “channel”, and the frequency. For the L or U channels, announces “low” or “up”, the channel number, and the frequency.
- In Channel Display mode, announces only the channel number. For the L or U channels, announces “low” or “up” and the channel number.
- In Call Channel mode, announces “call” and the frequency.

Note:

- ◆ To deactivate the Voice Synthesizer function after installing the optional VS-3 unit, access Item No. 3 (Voice) under Menu No. 14 (Audio), and select OFF.
- ◆ While using Transceiver Lock or All Lock, the transceiver makes an announcement only when pressing Mic [6] in Microphone Control mode or the PF key programmed with Voice.
- ◆ The Voice Synthesizer function does not work while transmitting or scanning.

OPTIONAL ACCESSORIES

MC-45
Multi-function
Microphone



MC-45DM
Multi-function
Microphone with DTMF



MC-53DM
Multi-function
Microphone with DTMF



MC-80
Desktop Microphone
(MJ-88 required)



PS-33
Regulated DC Power
Supply



DFK-3C
Detachable Front
Panel Kit (3 m)



DFK-4C
Detachable Front
Panel Kit (4 m)



DFK-7C
Detachable Front Panel
Kit (7 m)



PG-2N
DC Power Cable



PG-3G
DC Line Noise Filter



PG-3B
DC Line Noise Filter



VS-3
Voice Synthesizer Unit

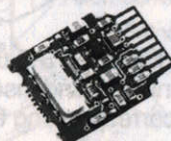

SP-41
Mobile Speaker



SP-50B
Communications
Speaker



PG-5A
Data Cable



MJ-88
Microphone Plug
Adaptor



MJ-89
Modular Plug
Microphone Switch



INSTALLING OPTIONS

INSTALLING THE VS-3 VOICE SYNTHESIZER UNIT

CAUTION: ALWAYS SWITCH OFF THE POWER AND UNPLUG THE DC POWER CABLE FIRST.

- 1 Remove the five screws from the upper cover of the transceiver.

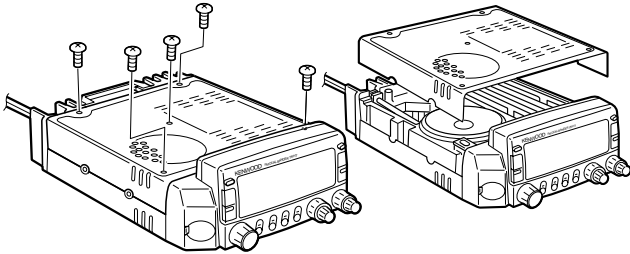

- 2 Hold the VS-3 unit with the component side facing inward, and insert the VS-3 connector into the corresponding transceiver connector.

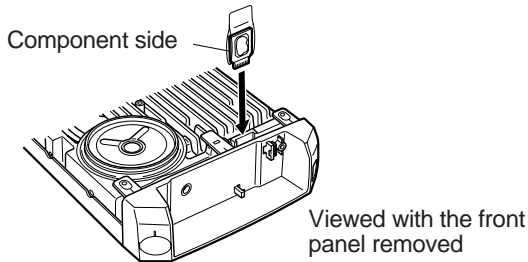

- 3 Replace the upper cover (5 screws).

INSTALLING A DETACHABLE FRONT PANEL KIT (DFK-3C/ DFK-4C/ DFK-7C)

CAUTION: ALWAYS SWITCH OFF THE POWER AND UNPLUG THE DC POWER CABLE FIRST.

- 1 While sliding the spring-loaded release switch on the rear of the front panel, remove the front panel from the main unit.

- Be careful not to drop the front panel when releasing it.

Release switch

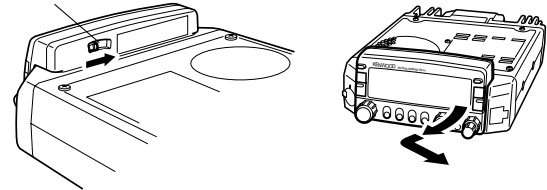

- 2 Hang the connector of the connectorized front panel cable onto the catch on the main unit, and secure the connector using the supplied screw.

- If the screw is loose, the transceiver may not function properly.

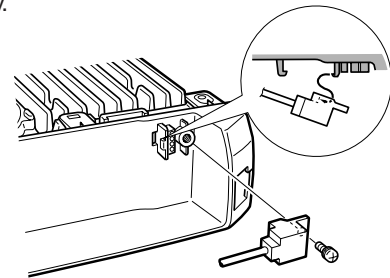

3 Connect the other end of the connectorized front panel cable to the One Touch panel.

- The cut-away corners of the connector should be inserted first into the space such that the corners mate with the positioning tab.

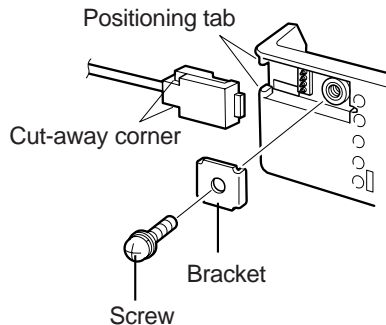

4 Install the front panel onto the One Touch panel by first positioning the left rear edge of the front panel, then pressing the right side of the front panel firmly against the One Touch panel.

- When the release switch clicks, the front panel is secured.

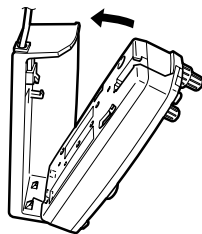

5 Assemble the mounting brackets, and install the front panel on the appropriate place in the vehicle.

- When installing the front panel in the vehicle, use a cushion under the bracket to protect the vehicle.
- Adjust the angle of the front panel before firmly tightening the two Allen screws.
- Route the cable so neither the connections nor the cable are under stress.

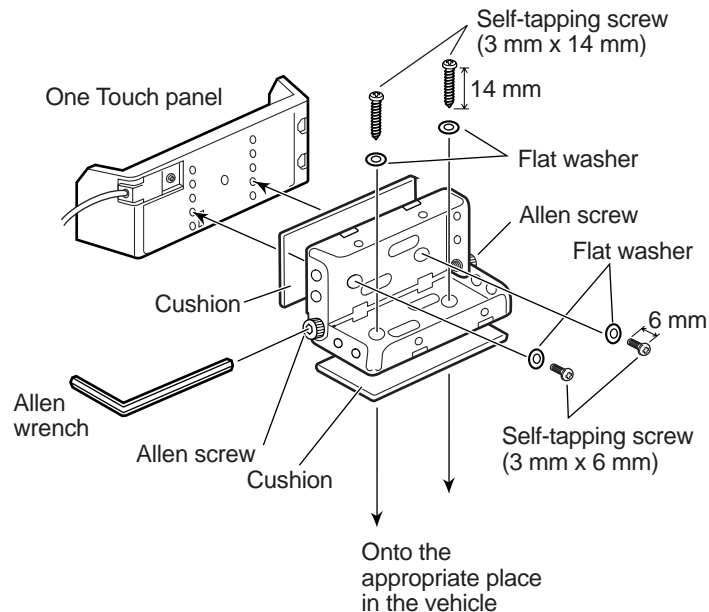

Note: Consider the safety of driver and passengers when deciding where to install the front panel. Tighten all screws firmly.

■ Installation Examples

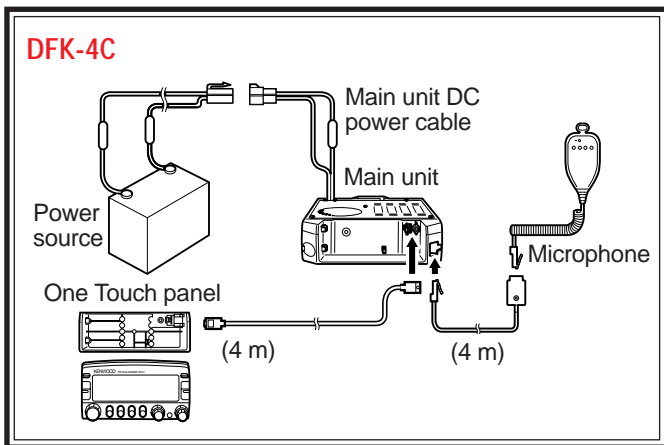
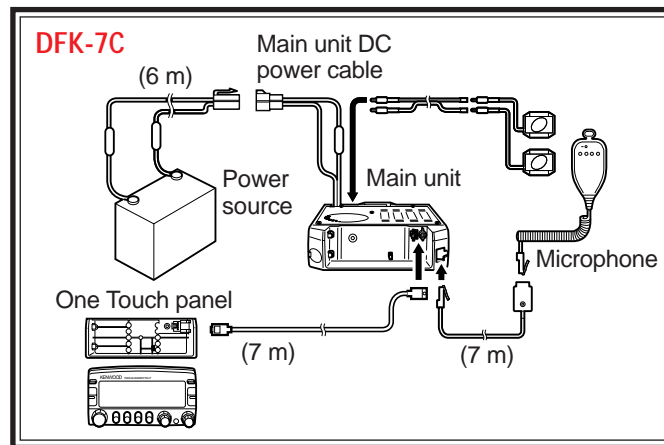
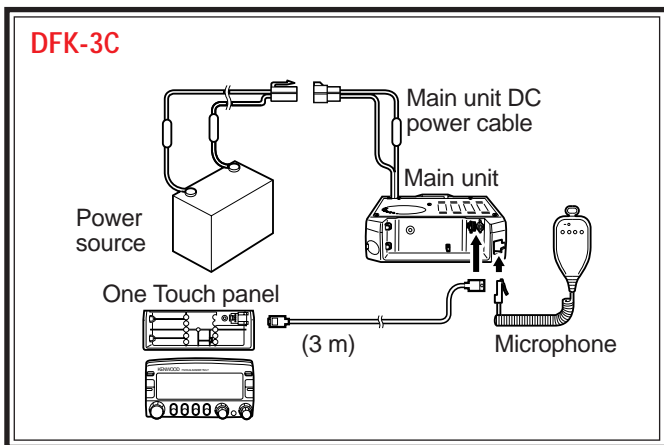

To install the microphone cable included with DFK-4C or DFK-7C, secure the microphone socket at the appropriate position in your vehicle using the long self-tapping screw (3 mm x 25 mm).

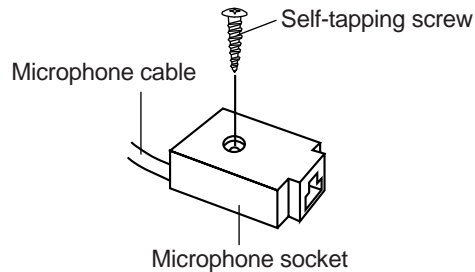

MAINTENANCE

GENERAL INFORMATION

Your transceiver has been factory aligned and tested to specification before shipment. All adjustable trimmers, coils and resistors in the transceiver were preset at the factory. They should only be readjusted by a qualified technician who is familiar with this transceiver and has the necessary test equipment. Attempting service or alignment without factory authorization can void the transceiver warranty.

SERVICE

When returning the equipment to your dealer or service center for repair, pack the transceiver in its original box and packing material. Include a full description of the problems experienced. Include both your telephone number and fax number (if available) along with your name and address in case the service technician needs to call you. Don't return accessory items unless you feel they are directly related to the service problem.

You may return your transceiver for service to the authorized **KENWOOD** dealer from whom you purchased it or any authorized **KENWOOD** service center. A copy of the service report will be returned with the transceiver. Please do not send subassemblies or printed circuit boards. Send the complete transceiver.

Tag all returned items with your name and call sign for identification. Please mention the model and serial number of the transceiver in any communication regarding the problem.

SERVICE NOTE

If you desire to correspond on a technical or operational problem, please make your note short, complete, and to the point. Help us help you by providing the following:

- 1 Model and serial number of equipment
- 2 Question or problem you are having
- 3 Other equipment in your station pertaining to the problem
- 4 Meter readings
- 5 Other information (Menu setup, mode, frequency, button sequence to induce malfunction, etc.)

CAUTION: *DO NOT PACK THE EQUIPMENT IN CRUSHED NEWSPAPERS FOR SHIPMENT! EXTENSIVE DAMAGE MAY RESULT DURING ROUGH HANDLING OR SHIPPING.*

Note:

- ◆ Record the date of purchase, serial number and dealer from whom the transceiver was purchased.
- ◆ For your own information, retain a written record of any maintenance performed on the transceiver.
- ◆ When claiming warranty service, please include a photocopy of the bill of sale, or other proof-of-purchase showing the date of sale.

CLEANING

Remove the controls from the transceiver when they become soiled and clean them with a neutral detergent and warm water. Use a neutral detergent (no strong chemicals) and a damp cloth to clean the case.

TROUBLESHOOTING

The problems described in this table are commonly encountered operational malfunctions. These types of difficulties are usually caused by improper hook-up, accidental incorrect control settings, or operator error due to incomplete programming. These problems are usually not caused by circuit failure. Please review this table, and the appropriate section(s) of this instruction manual, before assuming your transceiver is defective.

Note: When 2 frequencies are received in the same band and these frequencies have relationships per the equation below or other similar relationships, an internal heterodyne may be heard. This is not a defect.

VHF/UHF mode: $(\text{UHF receive frequency} - 45.05 \text{ MHz}) \times 2 - (\text{VHF receive frequency} + 38.85 \text{ MHz}) \times 4 = 38.85 \text{ MHz or } 45.05 \text{ MHz}$
 $(\text{UHF receive frequency} - 45.05 \text{ MHz}) - (\text{VHF receive frequency} + 38.85 \text{ MHz}) \times 2 = 38.85 \text{ MHz}$

VHF/VHF mode: $(\text{VHF receive frequency on the UHF band} + 45.05 \text{ MHz}) \times 5 - (\text{VHF receive frequency on the VHF band} + 38.85 \text{ MHz}) \times 5 = 38.85 \text{ MHz or } 45.05 \text{ MHz}$
 $(\text{VHF receive frequency on the UHF band} + 45.05 \text{ MHz}) \times 4 - (\text{VHF receive frequency on the VHF band} + 38.85 \text{ MHz}) \times 4 = 38.85 \text{ MHz}$
 $(\text{VHF receive frequency on the VHF band} + 38.85 \text{ MHz}) - (\text{VHF receive frequency on the UHF band} + 45.05 \text{ MHz}) \times 0.75 = 38.85 \text{ MHz}$

UHF/UHF mode: $(\text{UHF receive frequency on the VHF band} - 38.85 \text{ MHz}) \times 3 - (\text{UHF receive frequency on the UHF band} - 45.05 \text{ MHz}) \times 3 = 38.85 \text{ MHz or } 45.05 \text{ MHz}$
 $(\text{UHF receive frequency on the VHF band} - 38.85 \text{ MHz}) \times 4 - (\text{UHF receive frequency on the UHF band} - 45.05 \text{ MHz}) \times 4 = 38.85 \text{ MHz or } 45.05 \text{ MHz}$

Problem	Probable Cause	Corrective Action	Page Ref.
The transceiver will not power up after connecting a 13.8 V DC power supply and pressing the PWR switch. Nothing appears on the display.	1 The power cable was connected backwards.	1 Connect the supplied DC power cable correctly: Red → (+); Black → (-).	3, 4
	2 One or more of the power cable fuses are open.	2 Look for the cause of the blown fuse(s). After inspecting and correcting any problems, install a new fuse(s) with the same ratings.	5
	3 The front panel was not connected securely to the main unit of the transceiver.	3 Separate the front panel from the main unit by using the release switch on the rear of the front panel, then lock the front panel securely to the main unit by using the same switch.	84
	4 The connectorized cable was not correctly connected.	4 Connect the connectorized cable correctly.	3, 4

Continued

Problem	Probable Cause	Corrective Action	Page Ref.
The way the transceiver functions or displays information is strange.	The electrical contacts on the front panel and main unit were soiled.	Clean the electrical contacts on both the front panel and the main unit using a clean damp cloth.	—
The display is too dim, even though you selected a high dimmer level.	The supply voltage is too low.	The supply voltage requirement is 13.8 V DC \pm 15% (11.7 V to 15.8 V DC). If the input voltage is outside this range, recharge your battery, adjust your regulated power supply, and/or check all power cable connections.	3, 4
The frequency cannot be selected by turning the Tuning control or by pressing Mic [UP]/[DWN] .	Memory Recall or the Call channel was selected.	Press [VFO] .	8
Most buttons/keys and the Tuning control do not function.	1 One of the Lock functions is ON.	1 Unlock all of the Lock functions.	67
	2 The front panel was not connected securely to the main unit of the transceiver.	2 Separate the front panel from the main unit by using the release switch on the rear of the front panel, then lock the front panel securely to the main unit by using the same switch.	84
Memory channels cannot be selected by turning the Tuning control or by pressing Mic [UP]/[DWN] when using Memory Recall.	1 No data has been stored in any memory channels, or stored data was erased by Full Reset.	1 Store data in some memory channels.	30
	2 The Call channel was selected.	2 Press [MR] to switch to Memory Recall.	31

Continued

Problem	Probable Cause	Corrective Action	Page Ref.
You cannot transmit even though you press Mic [PTT].	1 The microphone plug was not inserted completely into the front panel connector.	1 Switch OFF the power, then insert the microphone plug until the locking tab clicks in place.	6
	2 You selected a transmit offset that places the transmit frequency outside the allowable transmit frequency range.	2 Press [F], [SHIFT] repeatedly so neither "+" nor "-" is visible.	23
Packet operation results in no connects with other stations.	1 Your frequency differs from the target station's frequency.	1 Adjust your frequency using the Tuning control.	17
	2 The modulation level from the TNC is incorrect.	2 Adjust the TNC modulation level according to the TNC instruction manual.	79
	3 There is multi-path distortion.	3 Reorient or relocate the antenna. The strongest signal does not always provide the best operation on packet.	—
	4 The TX delay of your TNC may not be long enough.	4 It is recommended to set the TX delay parameter on the TNC to 300 ms by using your computer.	79

Note: You can also use the RESET switch to initialize settings. Push the switch momentarily to do Partial Reset or press it for 1 second or longer to do Full Reset (page 35). No confirmation message appears. Use this switch when the microcomputer and/or the memory chip malfunction because of ambient factors.

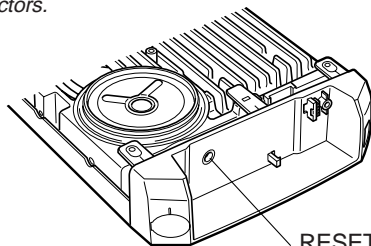

Viewed with the front panel removed

RESET switch

SPECIFICATIONS

Specifications are subject to change without notice due to advancements in technology.

General		VHF Band	UHF Band
Frequency range	U.S.A./ Canada	144 ~ 148 MHz	438 ~ 450 MHz
	General	144 ~ 148 MHz	430 ~ 440 MHz
	Europe	144 ~ 146 MHz	430 ~ 440 MHz
Mode		F3E (FM)	
Antenna impedance		50 Ω	
Usable temperature range		-20°C ~ +60°C (-4°F ~ +140°F)	
Power supply		13.8 V DC ±15% (11.7 ~ 15.8 V)	
Grounding method		Negative ground	
Current	Transmit (max.)	11.0 A or less	10.0 A or less
	Receive (at 2 W output)	1.0 A or less	
Frequency stability (-10°C ~ +50°C)		Within ±3 ppm	
Dimensions (W x H x D projections included)		140 x 54.5 x 205.5 mm / 5.51" x 2.15" x 8.09"	
Weight		1.2 kg / 2.6 lb	

Transmitter		VHF Band	UHF Band
Power output	High	50 W	35 W
	Mid	Approx. 10 W	
	Low	Approx. 5 W	
Modulation		Reactance	
Spurious emissions		-60 dB or less	
Maximum frequency deviation		±5 kHz	
Audio distortion (at 60% modulation)		3% or less	
Microphone impedance		600 Ω	

Receiver		VHF Band	UHF Band
Circuitry		Double conversion	
Intermediate frequency (1st/ 2nd)		38.85 MHz/ 450 kHz	45.05 MHz/ 455 kHz
Sensitivity (12 dB SINAD)	VHF or UHF band	0.16 μV or less	
	Sub VHF or UHF band (in VHF/VHF or UHF/UHF mode)	0.25 μV or less	
Selectivity (-6 dB)		12 kHz or more	
Selectivity (-60 dB)		28 kHz or less	
Squelch sensitivity		0.1 μV or less	
Audio output (8 ohms, 5% distortion)		2 W or higher	
Audio output impedance		8 Ω	

Note: Receiver specifications apply only when using the main VHF or UHF band. They do not apply to the sub VHF or UHF band in VHF/VHF or UHF/UHF mode.

INDEX

Advanced Intercept Point (AIP)	62	Installation		Menu		Reset	
Automatic Band Change (A.B.C.)	62	Antenna	5	Access	19	Full (Memory)	35
Automatic Power Off (APO)	61	DC Power Cable, Fixed Station	4	Configuration	20	Partial (VFO)	35
Automatic Simplex Checker (ASC)	27	DC Power Cable, Mobile	3	Microphone		Reverse Function	27
Autopatch	58	DFK 3C/ 4C/ 7C	84	Connection	6	Scan	
Channel Display Function	34	External Speakers	6	Control	78	Call/Memory	48
Continuous Tone Coded Squelch System (CTCSS) ...	49	Microphone	6	Offset		Call/VFO	48
Display		Packet Equipment	6	Automatic Repeater	26	Carrier-Operated	
Changing Conditions	70	VS-3	84	Direction	23	Resume	43
Demonstration mode	69	Keypad Direct Entry		Frequency	24	Memory	44
Dual Band RX	63	Frequency	74	Packet Operation	79	MHz	47
Dual Tone Multi-Frequency (DTMF) Functions		Memory Channel		Page		Program	46
Confirming Stored		Number	75	Answer Back	57	Time-Operated Resume ...	43
Numbers	60	Tone Frequency		Auto Cancel	57	VFO	44
Making Calls	58	Number	75	Calling	55	Visual	41
Storing Numbers	59	Lock		Locking Out Codes	56	Squelch	
Transmitting Stored		All Lock	67	Memory	53	Adjusting	16
Numbers	60	Transceiver Lock	67	Receiving	55	S-meter	68
Dual Tone Squelch System (DTSS)		Memory Channels		Storing	54	Switching AM/FM	64
Storing Codes	50	Call Channel, Changing		Power-ON Message	69	Time-Out Timer (TOT)	61
Using	51	Simplex	33	Program Function		Tone	
Frequencies, Selecting		Call Channel, Changing		(PF) keys	72	Activating	24
Microphone [UP]/[DWN] ...	17	Split	34	Programmable Memory (PM)		Automatic ID	49
Tuning Control	17	Call Channel, Recalling	33	Auto Storing	39	Direct Number Entry	75
Frequency Step Size	65	Clearing	31	Recalling	38	Selecting	25
Fuses, Replacing	5	Direct Number Entry	75	Resetting	39	Transmit Output Power	18
		Initializing	35	Storing	38	Transceiver Guide	15
		Locking Out	45	Programmable VFO	64	Voice Synthesizer (VS-3)	82
		Naming	32	Repeater Access	22	Volume	
		Recalling	31	Repeater Function		Beep	66
		Storing, Simplex	30	Cross-band	81	Speaker	16
		Storing, Split	30	Locked-band	81		
		Transfer to VFO	34				
		VHF/UHF Ratio	29				

KENWOOD