INTRODUCTION

Thank you for choosing this Icom product. This product is designed and built with Icom's state of the art technology and craftsmanship. With proper care, this product should provide you with years of trouble-free operation.

ABOUT THE CONSTRUCTION OF THE MANUAL

You can use the following manuals to understand and operate this transceiver.

① If necessary, you can download a glossary of HAM radio terms from the Icom website.

TIP: You can download each manual and guide from the Icom website:

<https://www.icomjapan.com/support/>

Enter "IC-T10" into the Search box on the site.

Basic manual (Comes with the transceiver)

Instructions for the basic operations and precautions.

Advanced manual (This manual)

- Battery charging
- Memory operation
- Scan operation
- Repeater and duplex operations
- SET mode
- Other functions
- Options

TRADEMARKS

Icom and the Icom logo are registered trademarks of Icom Incorporated (Japan) in Japan, the United States, the United Kingdom, Germany, France, Spain, Russia, Australia, New Zealand, and/or other countries.

Adobe, Acrobat, and Reader are either registered trademarks or trademarks of Adobe Systems Incorporated in the United States and/or other countries.

All other products or brands are registered trademarks or trademarks of their respective holders.

FUNCTIONS AND FEATURES OF ADOBE® ACROBAT® READER®

The following functions and features can be used with Adobe Acrobat Reader.

• Keyword search

Click “Find” (Ctrl+F) or “Advanced Search” (Shift+Ctrl+F) in the Edit menu to open the search screen. This is convenient when searching for a particular word or phrase in this manual.

① The menu screen may differ, depending on the Adobe Acrobat Reader version.

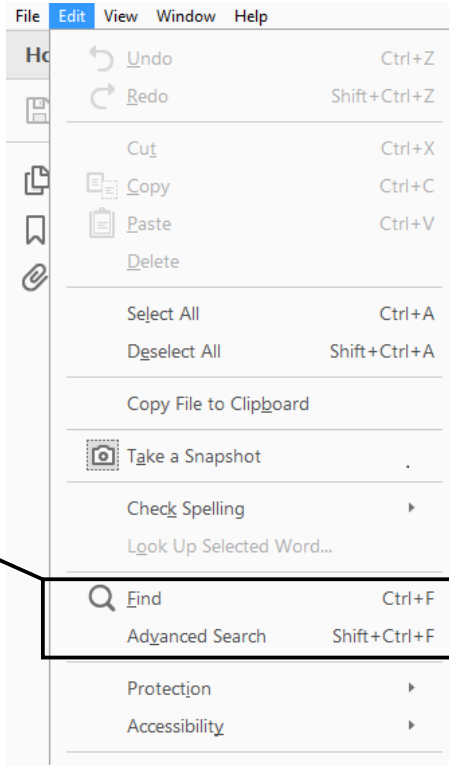

Click to open the find or search screen or advanced search screen.

• Find screen

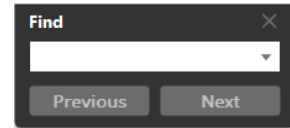

• Advanced search screen

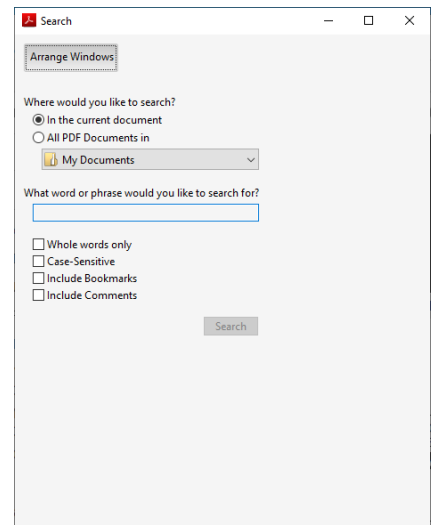

• Printing out the desired pages.

Click “Find (Ctrl+F)” or “Advanced Search (Shift+Ctrl+F)” in the Edit menu to open the search screen.

This is convenient when searching for a particular word or phrase in this manual.

① The menu screen may differ, depending on the Adobe Acrobat Reader version.

① Select the “A4” size to print out the page in the original manual size.

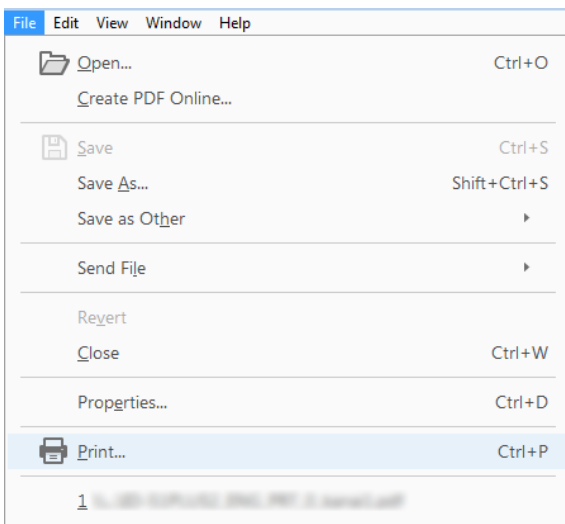

• Read Out Loud feature.

The Read Out Loud feature reads aloud the text in this PDF.

Refer to the Adobe Acrobat Reader Help for the details.

(This feature may not be usable, depending on your PC environment, including the operating system.)

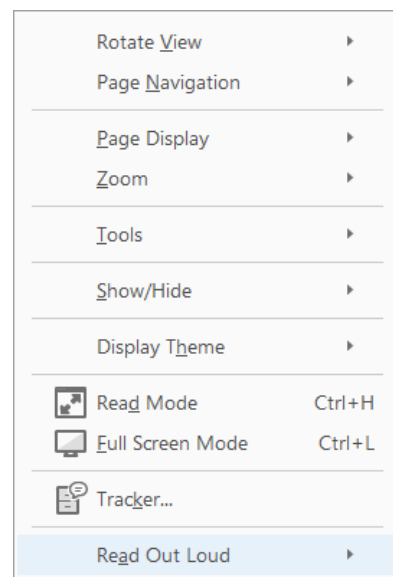

① The screen may differ, depending on the Adobe Acrobat Reader version.

Section 1

BATTERY CHARGING

Battery information	1-2
◇ Battery life	1-2
◇ Battery icon	1-2
◇ Attention to the swelled battery pack	1-2
Charging the battery pack	1-3
◇ Using the BC-213 RAPID CHARGER	1-3
External DC power operation	1-4
◇ Using an external power source	1-4
Specifications for the battery charger and battery packs.....	1-4
◇ BC-213 RAPID CHARGER	1-4
◇ BP-280 Li-ion BATTERY PACK.....	1-4

Battery information

◇ Battery life

The approximate battery life (operating time) as shown below is calculated under the following assumptions:

- Power save setting: Auto
- Duty cycle: TX : RX : Standby = 1 : 1 : 8
(based on operating style)

The approximate battery life of the BP-280:

VHF	11 hours
UHF	10 hours





NOTE: BE SURE to replace the battery pack with a new one approximately five years after purchase, even if it still holds a charge. The material inside the battery cells will become weak after a period of time, even with little use.

The estimated number of times you can charge the pack is between 300 and 500. Even when the pack appears to be fully charged, the operating time of the transceiver may become short when:

- Approximately five years have passed since the pack was manufactured.
- The pack has been repeatedly charged.

TIP: Keep the battery terminals clean. It's a good idea to clean them occasionally.

◇ Battery icon

Icon	Battery status
	The battery has sufficient capacity.
	The battery is exhausted a little.
	The battery is nearing exhaustion.
	The battery is almost fully exhausted. Immediately charge the battery pack. ① After a while, the icon blinks and the transceiver will be turned OFF.

① "" is displayed while using the optional AD-149H EXTERNAL POWER SUPPLY.

◇ Attention to the swelled battery pack

The battery cells may deteriorate and swell due to their characteristics if used in an environment and conditions such as: frequently charged, recharged immediately after full charge, used or saved in a hot place, or charged by methods other than the instructions.

If the battery pack swells, it has reached the end of its life due to deterioration. Replace it with a brand new one.

Charging the battery pack

◇ Using the BC-213 RAPID CHARGER

Before using the transceiver for the first time, the battery pack must be fully charged for optimum life and operation.

Charging note

- **CAUTION: DO NOT** use a battery pack or charger that are not manufactured or approved by Icom.
- **BE SURE** to turn OFF the transceiver. When the transceiver's power cannot be turned OFF because of the battery exhaustion, detach the battery pack from the transceiver. Then charge the battery pack by itself.
- If the charging indicator blinks orange, there may be a problem with the battery pack or charger. Contact your dealer if you have problems charging a new battery pack.

Charging time:

Approximately 4 hours for the BP-280

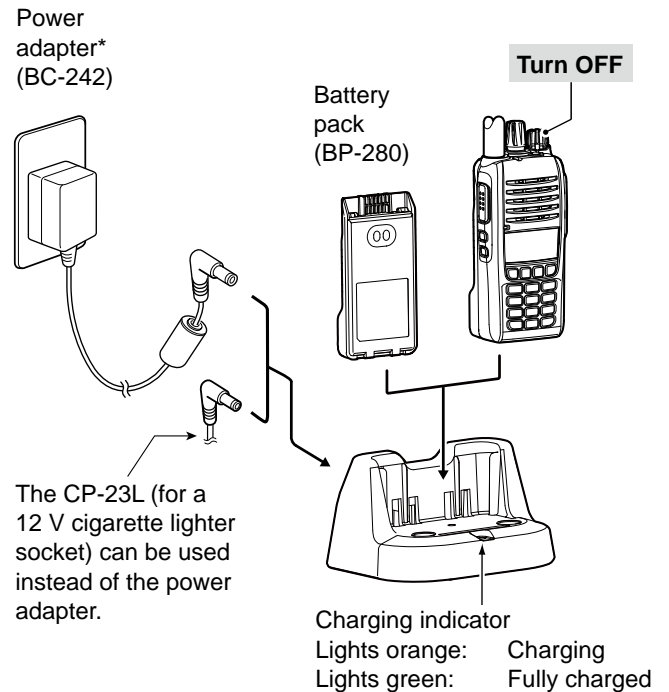

* May not be supplied, or the shape may be different, depending on the transceiver version.

External DC power operation

◇ Using an external power source

The optional AD-149H is an external power supply, that attaches to the transceiver just like a battery pack. Turn OFF the transceiver, and then attach the AD-149H, as shown to the right.

⚠ WARNING! NEVER connect the transceiver to a power source of more than 16 V DC. This could cause a fire or damage the transceiver. The AD-149H accepts the voltage between 10 V and 16 V.

⚠ WARNING! NEVER operate the transceiver connected to an external power source for a long time with High power. The transceiver temperature may increase, and you may get burned.

CAUTION: DO NOT expose the AD-149H to rain, snow, saltwater, or any other liquids. The AD-149H does not meet waterproof protection.

Charging note

- Use an optional CP-12L or OPC-254L to connect an external power source to the AD-149H.
- The CP-12L enables charging through the vehicle's cigarette lighter socket that has a 12 V DC battery.
 - ① A converter is required if your vehicle has a 24 V DC battery.
- The OPC-254L enables charging through a stabilized power source.

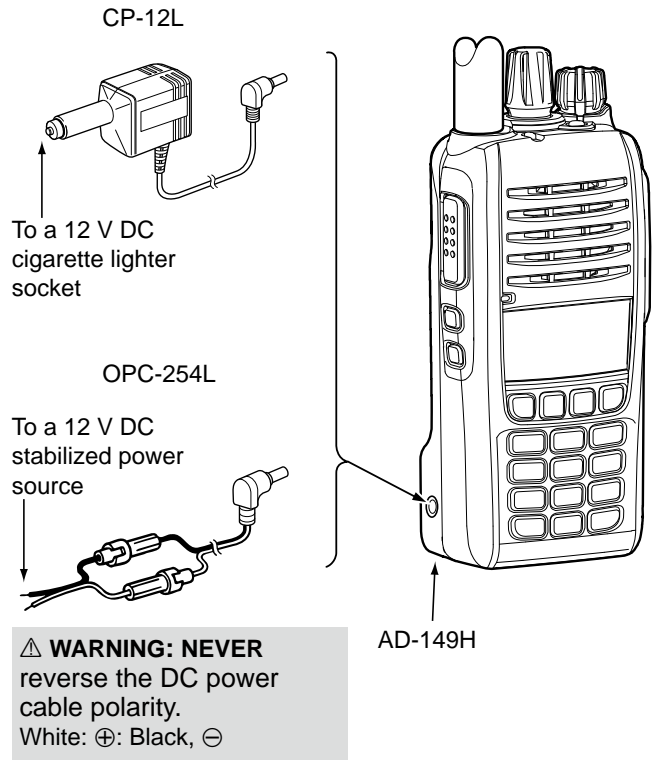

Specifications for the battery charger and battery packs

◇ BC-213 RAPID CHARGER

- Power source requirement: 12 V ~ 16 V DC or the specified Icom power adapter
- Charging temperature range: 10°C ~ 40°C, 50°F ~ 104°F
- Weight: Approximately 84 g, 3.7 oz (without power adapter)
- Dimensions: 77.3 (W) × 46.0 (H) × 66.1 (D) mm, 3.0 (W) × 1.8 (H) × 2.6 (D) inches (projections not included)

◇ BP-280 Li-ion BATTERY PACK

- Voltage: 7.2 V
- Discharge Capacity: 2280 mAh (minimum)
- Usable temperature range: -20°C ~ +60°C, -4°F ~ +140°F
- Charging temperature range: 10°C ~ 40°C, 50°F ~ 104°F
- Storage temperature range:
 - 20°C ~ +50°C, -4°F ~ +122°F (within a month)
 - 20°C ~ +40°C, -4°F ~ +104°F (within 3 months)
 - 20°C ~ +20°C, -4°F ~ +68°F (within a year)
- Dimensions: 52.2 (W) × 104.5 (H) × 17.5 (D) mm, 2.1 (W) × 4.1 (H) × 0.7 (D) inches (projections not included)

Section 2

MEMORY OPERATION

General description	2-2
◇ Memory channel content	2-2
Selecting a Memory channel	2-2
◇ Using [DIAL].....	2-2
◇ Using the Ten-Keypad.....	2-2
Selecting a Call channel.....	2-3
Entering Memory channels.....	2-3
Copying Memory content to the VFO	2-4
Entering a memory name	2-5
◇ Selecting a display mode.....	2-5

General description

In the Memory mode, you can quickly select the saved memory channels.

Channel No.	Usage
0 ~ 199 (M-CH)	Normal memory channels. The transceiver has 200 Memory channels.
1A/1B, 2A/2B, 3A/3B (PROGRAM-CH)	3 pairs of channels used for setting Program scan edges (Except for FM radio band)
C0, C1 (CALL CH)	The Call Channel of each band (C0): For the 144 MHz band (C1): For the 430 MHz band

◇ Memory channel content

The following information can be entered into the Memory channels:

- Operating frequency
- Duplex ON/OFF
- Duplex reverse polarity
- Duplex direction (DUP+ or DUP-)
- Duplex frequency offset
- Output power
- Memory name
- Scan skip setting
- Tuning step
- Operating mode
- Tone squelch setting, tone squelch frequency
- Tone squelch frequency for accessing a repeater
- DTCS code polarity

NOTE: Memory content may be accidentally cleared by static electricity, electric transients, and other causes. In addition, it may be cleared by a malfunction, or during repairs. Therefore, we recommend that you backup the Memory content onto a PC.

① Use the optional CS-T10 PROGRAMMING SOFTWARE to backup your memory content. See its instruction manual for details.

Selecting a Memory channel

◇ Using [DIAL]

1. Repeatedly push [V/M/C] to select the Memory mode.



2. Rotate [DIAL] to select a Memory channel.
 - ① Empty Memory channels are not selectable.

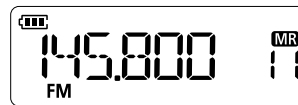

◇ Using the Ten-Keypad

1. Repeatedly push [V/M/C] to select the Memory mode.
2. Enter a channel number, and then push [ENT].
 - ① Empty memory channels are selectable.

Example:

Selecting Channel 25:

Push [0], [2], [5], or push [2], [5], and then push [ENT].

Selecting Channel 8:

Push [0], [0], [8], or push [8], and then push [ENT].

Selecting a Call channel

Call channels are used for quick recall of most often used operating frequencies.

1. Repeatedly push [V/M/C] to select the Call Channel mode.



2. Push [BAND] to toggle between the VHF call channel and UHF call channel.



Entering Memory channels

Example: Entering 145.800 MHz into Channel 11

1. Repeatedly push [V/M/C] to select the VFO mode.
2. Repeatedly push [BAND] to select the VHF band.
3. Set the frequency to 145.800 MHz.

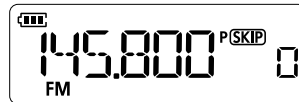

4. Push [S.MW] until two short beeps sound.
 - "MR" and the channel number blink.
 - ① Holding down even after two short beeps sound writes the set frequency to the currently selected channel.



5. Rotate [DIAL] to select Channel 11.



6. Push [S.MW] until two short beeps sound to enter 145.800 MHz to Channel 11.
 - The transceiver returns to the VFO mode.

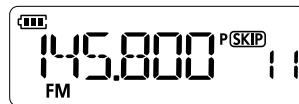

TIP: About the Auto Increment

When entering the frequency to the Memory Channel in Step 6, hold down [S.MW] until three beeps sound, to write to the previous channel of the selected channel.

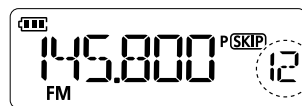
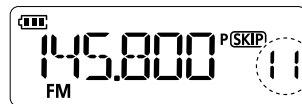

Copying Memory content to the VFO

It is convenient to operate on a frequency near a Memory or Call channel in the VFO mode.

1. Repeatedly push [V/M/C] to select the Memory mode or Call Channel mode.
2. Rotate [DIAL] to select a Memory Channel or Call channel to copy.



3. Hold down [S.MW] until three beeps sound.
 - The transceiver enters the VFO mode with the selected channel copied.



Entering a memory name

Each memory channel can be given a name of up to 6 characters.

Step 1. Selecting a display mode

Select "nAmE" in the Display Mode item in the Initial Set mode, to display the channel name.

1. Rotate [VOL] counter-clockwise to turn OFF the transceiver.
2. While holding down [SET], rotate [VOL] clockwise to turn ON the transceiver.
 - An Initial Set mode item is displayed.
3. Repeatedly push [SET] until "dISP m" is displayed.
 - ① You can also select by pushing [MONI] or [P].

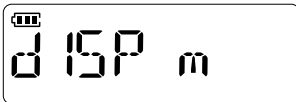

4. Rotate [DIAL] to select "nAmE."

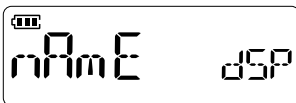

5. Push [V/M/C] or [ENT] to exit the Initial Set mode.
6. Repeatedly push [V/M/C] to select the Memory mode.

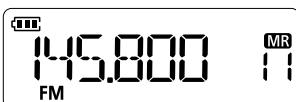

7. Rotate [DIAL] to select the channel that a memory name is given.
 - ① A frequency is displayed for the channel without channel name.

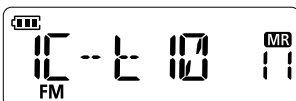

Usable characters:

A	b	C	d	E	F	G	H	I	J	k	L	m
[A]	[b]	[C]	[d]	[E]	[F]	[G]	[H]	[I]	[J]	[k]	[L]	[m]
n	O	P	q	R	S	t	U	V	W	X	Y	Z
[n]	[O]	[P]	[q]	[R]	[S]	[t]	[U]	[V]	[W]	[X]	[Y]	[Z]
1	2	3	4	5	6	7	8	9	0			
[1]	[2]	[3]	[4]	[5]	[6]	[7]	[8]	[9]	[0]			
+	-	=	*	/	[]						
[+]	[-]	[=]	[*]	[/]	[(]	[)]	[]	[:]	[Space]			

Step 2. Entering a memory name

1. Push [S.MW] until two short beeps sound.
 - "MR" and the channel number blink.



2. Rotate [DIAL] to Select a Memory Channel to enter a name.



3. Push [SET].
 - "nAmE" is displayed.

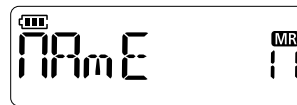

4. Hold down [SET] until two beeps sound.
 - The first digit blinks, and the transceiver enters the Name Entry mode.



5. Rotate [DIAL] to enter the first digit.
 - ① Push [MONI] to move the cursor to the right.
 - ① Push [P] to move the cursor to the left.



6. Repeat Step 5 to enter the rest of the digits.

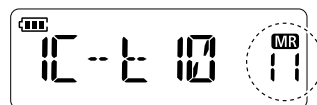

7. Push [S.MW] to apply the entry.
 - "nAmE" is displayed.
8. Push [S.MW].
 - "MR" and the channel number blink.
 - ① Repeat Step 2 to 8 to re-enter a memory name.
9. Push [S.MW] to return to the Memory mode.

Section 3

SCAN OPERATION

Scan Type.....	3-2
◇ VFO scan.....	3-2
◇ Memory scan	3-2
About Scans	3-3
◇ [DIAL] operation during a scan	3-3
◇ Squelch setting for a scan	3-3
◇ Tuning step for a VFO scan	3-3
◇ Scan Skip function	3-3
◇ Operating mode during a scan	3-3
◇ When a signal is received.....	3-3
VFO Scan.....	3-4
◇ Using the Program Skip function	3-4
Memory Scan	3-5
◇ Setting/clearing a Skip channel	3-5

Scan Type

Scanning is a versatile function that can automatically search for signals. A scan makes it easier to locate stations to contact or listen to, or to skip unwanted channels or frequencies.

◇ VFO scan

Scans for signals within the specified frequency range.

Full scan (ALL):

Repeatedly scans the entire VHF and UHF bands.

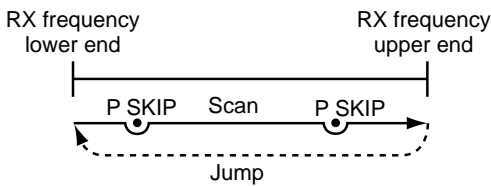

Band scan (BAND):

Repeatedly scans the selected band.

Program scan (1 ~ 3):

Repeatedly scans the set Program Scan range.

① A Program Scan range must be set to start a Program scan.

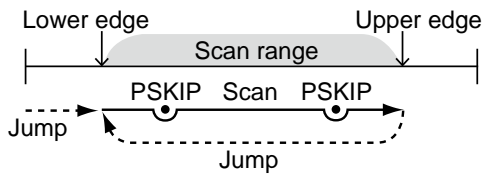

◇ Memory scan

The Memory scan searches signals on the preregistered memory channels.

ALL scan (ALL):

Repeatedly scans all memory channels.

Selected band scan (BAND):

Scans all memory channels on the same frequency band as the selected channel.

Tone scan

The Tone scan searches for signals with tone frequencies or DTCS codes from stations using the Tone Squelch function. (p. 6-7)

- ① A Tone scan is usable in the VFO, Memory, or Call channel modes.
- ① During a scan, rotate [DIAL] to change the scan direction.
- ① See pages 6-5 and 6-6 about the Tone Squelch and DTCS Code Squelch functions.

About Scans

◇ [DIAL] operation during a scan

- Rotate [DIAL] to change the scan direction during a scan.
- Rotate [DIAL] to resume the scan when the scan is paused.

◇ Squelch setting for a scan

You can change the squelch level to suit your operating needs. Set the squelch level to open the squelch, according to the received signal strength.

- ① Rotate [DIAL] while holding down [MONI] to adjust the squelch level during a scan. The scan resumes after releasing [MONI].

◇ Tuning step for a VFO scan

The tuning step selected in the Set mode (p. 5-4) is applied to the scan.

◇ Scan Skip function

The skip function speeds up scanning by not scanning those frequencies set as skip channels (p. 3-5).

In the VFO mode:

Skips the frequency assigned as "P~~SKIP~~" (p. 3-5).

In the Memory mode:

Skips the memory channel assigned as "P~~SKIP~~" or "~~SKIP~~" (p. 3-5).

<p>TIP: Turn OFF the Program Skip function in the Set mode (p. 5-4) to execute a scan, including the skipped frequency.</p>
--

◇ Operating mode during a scan

- The VFO scan uses the selected operating mode.
- During a Memory mode scan, the operating mode entered into the channel is used.

◇ When a signal is received

When a signal is received, the scan pauses for the period of time that is set in the Set mode. (p. 5-4)

When a received signal disappears, the scan resumes after the set period of time.

VFO Scan

The VFO scan searches for signals within the specified frequency range.

1. Repeatedly push [V/M/C] to select the VFO mode.
2. Hold down [SCAN] until a beep sounds to start the scan.
 - ① While scanning, repeatedly push [SET] to select a scan type.

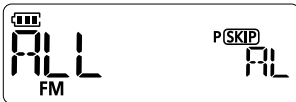

Full scan



Band scan



Program scan

- ① While scanning, the scan type in progress is indicated by two letters.
 - ① While scanning, push [BAND] to change the band to scan, or scope of the Program Scan.
 - ① While receiving a signal, the S-meter displays the received signal strength.
3. Push [SCAN] or [V/M/C] to cancel the scan.

TIP:

- While scanning, rotate [DIAL] to change the scanning direction.
- While scanning, hold down [L/O] to turn the Lock function ON or OFF.

◇ VFO Scan type

There are the following types of VFO scans.

- ALL: Full scan
- bAnd: Band scan
- PROG1 ~ 3: Program scan

TIP: About the Band scan
 While scanning the VHF or UHF band, push [BAND] to switch the scan to the other band.
 ① While scanning the FM radio band, you cannot switch to VHF or UHF.

◇ Using the Program Skip function

You can skip unnecessary frequencies during a scan. Enter the Skip Channel in Memory mode to use the function.

- ① The skipped frequencies will be scanned if the Program Skip function is turned OFF in the Set mode (p. 5-4).



Memory Scan

Enter two or more memory channels to run the Memory Scan (p. 2-3).

1. Repeatedly push [V/M/C] to select the Memory mode.
2. Hold down [SCAN] until a beep sounds to start the scan.
 - ① While scanning, repeatedly push [SET] to select a scan type.

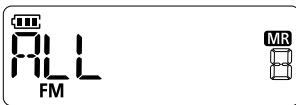

Full scan

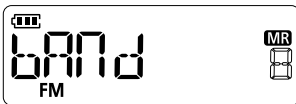

Band scan

- ① While scanning, the scan type in progress is indicated by two letters.
 - ① While scanning, push [BAND] to change the band to scan, or scope of the Program Scan.
 - ① While receiving a signal, the S-meter displays the received signal strength.
3. Push [SCAN] or [V/M/C] to cancel the scan.

TIP:

- While scanning, rotate [DIAL] to change the scanning direction.
- While scanning, hold down [LOCK] to turn the Lock function ON or OFF.

◇ Memory Scan type

There are the following types of Memory scans.

- ① While scanning, the transceiver indicates the currently selected scan type.
 - ALL: Full scan
 - bAnd: Band scan

Setting/clearing a Skip Channel

The channels set as Skip channels are skipped during a scan.

◇ Setting/clearing a Skip channel

1. Repeatedly push [V/M/C] to select the Memory mode.
2. Push [S.MW] until two short beeps sound.
 - "MR" and the channel number blink.
3. Rotate [DIAL] to select a channel to skip, or a channel to set or clear.
4. Push [SET].
 - ① "SKIP" is displayed.
 - ① Push [MONI] or [P] to display "SKIP," if it is not displayed.
5. Rotate [DIAL] to select an option.
 - SKIP: Skips the selected memory channel.



- PSKIP: Skips the selected memory channel in the Memory mode, and skips the same frequency in a VFO scan.

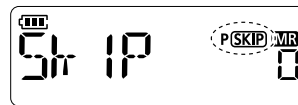

- OFF: Scans the selected memory channel.



6. Push [S.MW].
 - "MR" and the channel number blink.
7. Push [S.MW] to return to the Memory mode.

Section 4

REPEATER AND DUPLEX OPERATION

Accessing a repeater.....	4-2
◇ Checking the Repeater input signal.....	4-3
◇ Using the 1750 Hz tone burst.....	4-3
Duplex operation.....	4-4
◇ Setting the frequency offset.....	4-4
◇ Setting the duplex direction.....	4-4
◇ Duplex operation.....	4-4
◇ Using the Duplex Reverse function.....	4-5
◇ Using the Auto Repeater function.....	4-5
◇ Off band indication.....	4-5

Accessing a repeater

A Repeater receives signals on one frequency, and then retransmits them on a different frequency. When using a Repeater, the transmit frequency is shifted from the receive frequency by a frequency offset.

A Repeater can be accessed using the Duplex function by setting the transceiver's offset to the same value as the Repeater's offset.

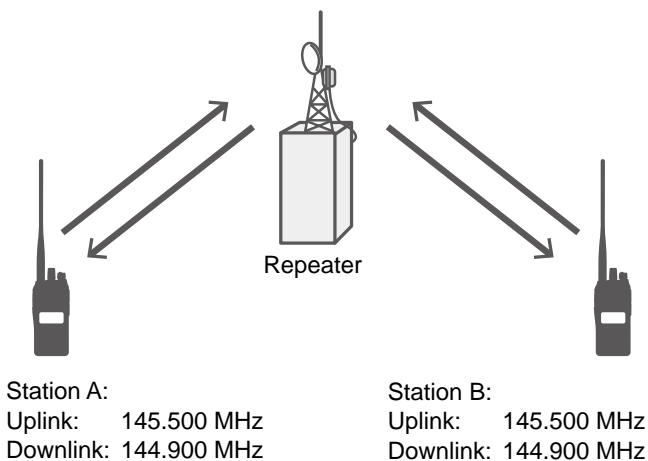

Step 1. Setting the Repeater frequency

1. Repeatedly push [V/M/C] to select the VFO mode.
2. Rotate [DIAL] to set the repeater output frequency.

TIP: For only the USA version

Steps 3 to 5 are not necessary if the Auto Repeater function (p. 5-7) is turned ON since the function automatically sets the repeater settings.

3. Set the repeater tone in the Set mode (p. 5-3).
4. Set the duplex direction in the Set mode (p. 5-4).
5. Set the offset frequency in the Set mode (p. 5-4).

Step 2. Transmitting

1. Hold down [PTT] for 2 seconds.
 - If your transmit signal reached the repeater, after releasing [PTT], you can hear the repeater's call sign in morse codes or its announcement.

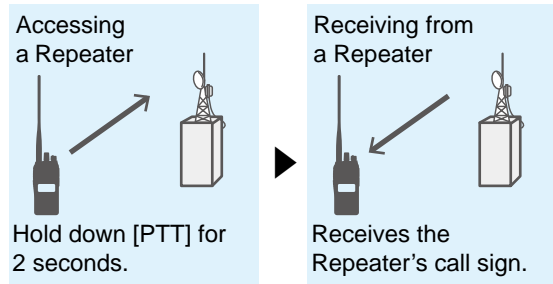

2. Operate in the same way as a simplex call, alternately transmit and receive.

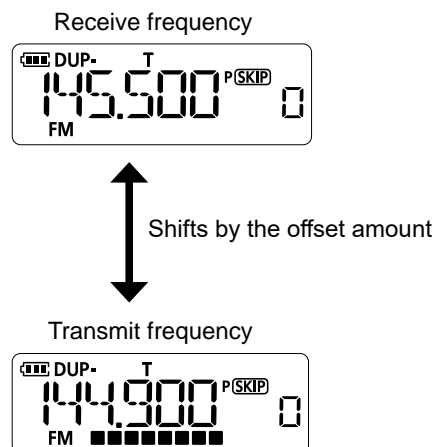

Accessing a repeater

◇ **Checking the Repeater input signal**

You can check whether or not another station's transmit signal can be received directly (not through a repeater) by listening to the repeater input frequency.

- Hold down [MONI] to listen to the repeater input frequency.
 - ① While monitoring, the status indicator lights green, and an S/RF meter dot blinks.
 - ① While monitoring, the displayed frequency automatically changes to the transceiver transmit frequency (repeater input frequency).
 - ① When the other station's signal can be directly received, move to a non-repeater frequency, and use simplex (Duplex OFF).

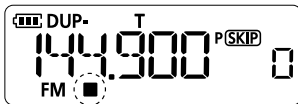

◇ **Using the 1750 Hz tone burst**

A 1750 Hz tone is required to access many European repeaters.

Step 1. Selecting "t-CALL"

1. Push [SET] to enter the Set mode.
 - A Set mode item is displayed.
2. Repeatedly push [SET] to select "dtmF-t."

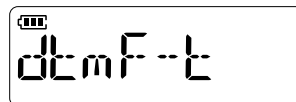

3. Rotate [DIAL] to select "t-CALL."



4. Push [V/M/C] to exit the Set mode.

Step 2. Using the 1750 Hz tone burst

1. Set the receive frequency (repeater output frequency).
2. Set the duplex direction of the transmit frequency (p. 4-4).
3. While holding down [PTT], push [MONI] to transmit a 1750 Hz tone burst signal.
 - The displayed frequency automatically changes to the transmit frequency (repeater input frequency).
 - ① If "OFF" is displayed, check the frequency offset or duplex direction status (p. 4-4).

TIP: For only the EUR version:
Push [PTT] briefly and release, and then hold down [PTT] to transmit a 1750 Hz tone burst signal.

4. Hold down [PTT] to transmit, release [PTT] to receive.
 - ① Hold down [MONI] to check whether the other station's transmit signal can be received or not, by listening on the repeater input frequency.

Duplex operation

The duplex operation shifts the transmit frequency up or down from the receive frequency by an offset amount.

◇ Setting the frequency offset

1. Push [SET] to enter the Set mode.
 - A Set mode item is displayed.
2. Repeatedly push [SET] to select "OFFSEt."

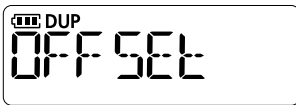

3. Rotate [DIAL] to set the frequency offset.
 - "DUP" blinks.
 - ① Set to between 0.000 and 20.000 (MHz).
 - ① Changes in the tuning step selected in the Set mode.

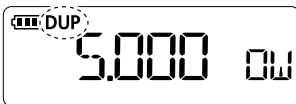

UHF default



VHF default

4. Push [V/M/C] to exit the Set mode.

◇ Setting the duplex direction

1. Push [SET] to enter the Set mode.
 - A Set mode item is displayed.
2. Repeatedly push [SET] to select "dUP."



3. Rotate [DIAL] to set a duplex direction.
 - OFF: The receive and transmit frequencies are the same.
 - -: The transmit frequency shifts down from the receive frequency by the offset amount.
 - +: The transmit frequency shifts up from the receive frequency by the offset amount.



4. Push [V/M/C] to exit the Set mode.
 - "DUP" or "DUP-" is displayed when the duplex direction is set.

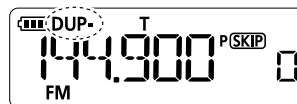

◇ Duplex operation

1. Hold down [MONI] to listen to the transmit frequency to check whether another station is transmitting on it or not.
 - The frequency shifts by the offset amount.
2. Operate in the same way as a simplex call, alternately transmit and receive.

NOTE for the USA version:
The Duplex mode is automatically canceled when the Auto Repeater function (p. 4-5) is ON, and the operating frequency is set out of the repeater output frequency range.

Duplex operation

◇ Using the Duplex Reverse function

When the Duplex Reverse function is ON, the receive and transmit frequencies are reversed.

1. Push [SET] to enter the Set mode.
 - A Set mode item is displayed.
2. Repeatedly push [SET] to select “dUP.REV.”

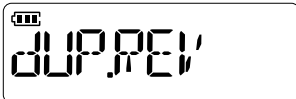

3. Rotate [DIAL] to select “On.”



4. Push [V/M/C] to exit the Set mode.
 - “DUP” blinks while operating.

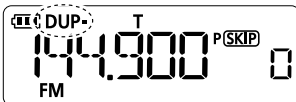

Example:

Offset: 5.000 MHz
 Duplex direction: DUP-

Duplex Reverse	Receive	Transmit
OFF	149.900 MHz	144.900 MHz
On	144.900 MHz	149.900 MHz

◇ Using the Auto Repeater function (For only the USA version)

When the operating frequency falls within the Repeater output frequency range, the Auto Repeater function automatically sets the Repeater settings (Duplex ON/OFF, Duplex direction, Tone encoder ON/OFF).

1. Rotate [VOL] counter-clockwise to turn OFF the transceiver.
2. While holding down [SET], rotate [VOL] clockwise to turn ON the transceiver.
 - An Initial Set mode item is displayed.
3. Repeatedly push [SET] to select “AutoRP.”

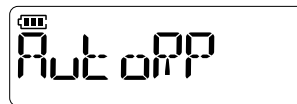

4. Rotate [DIAL] to select an option.



5. Push [V/M/C] or [ENT] to exit the Initial Set mode.

Frequency range and offset direction:

Frequency range	Shift direction
145.200 ~ 145.495 MHz	DUP-
146.610 ~ 146.995 MHz	DUP-
147.000 ~ 147.395 MHz	DUP+
442.000 ~ 444.995 MHz	DUP+
447.000 ~ 449.995 MHz	DUP-

◇ Off band indication

If the transmit frequency is out of the amateur band, the off-band indication, “OFF” is displayed when you push [PTT]. Check the frequency offset or duplex direction in this case.

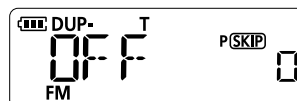

While accessing a repeater

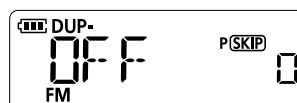

While transmitting in Duplex mode

Section 5 SET MODE

Using Set Mode	5-2
◇ Using the Basic Set mode	5-2
◇ Using the Initial Set mode	5-2
Set Mode items.....	5-3
Initial Set Mode items	5-7

Using Set Mode

You can use the Set mode to set infrequently changed values or function settings. The transceiver has two types of Set modes, as shown below.

◇ Using the Basic Set mode

Example: Selecting a 20 kHz tuning step

1. Push [SET] to enter the Set mode.
 - A Set mode item is displayed.
2. Push [SET] several times to select "tS."
 - ① Alternatively, you can also push [MONI] or [P] to select "tS"

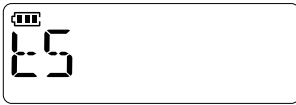

3. Rotate [DIAL] to select "20.0."



4. Push [V/M/C] or [ENT] to exit the Set mode.



◇ Using the Initial Set mode

Example: Setting the Auto Power OFF Timer to 30 minutes

1. Rotate [VOL] counter-clockwise to turn OFF the transceiver.
 - An Initial Set mode item is displayed.
2. While holding down [SET], rotate [VOL] clockwise to turn ON the transceiver.
 - An Initial Set mode item is displayed.
3. Push [SET] several times to select "AP OFF."



4. Rotate [DIAL] to select "30."



5. Push [V/M/C] or [ENT] to exit the Initial Set mode.



Set Mode items

Tone/DTCS (Default: OFF)

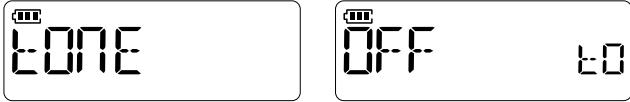

Selects a tone type during FM mode operation.

- OFF: Turns OFF the function
- tOnE: Repeater Tone
- P bEEP: Pocket Beep
- tSqL: Tone Squelch
- tSqL R: Reverse Tone Squelch
- dtCS t: DTCS transmission
- P dtCS: Pocket DTCS code
- dtCS: DTCS
- dtCS R: Reverse DTCS

Repeater tone (Default: 88.5)

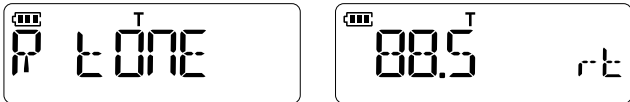

Sets a subaudible tone frequency used to access the repeaters.

- Options: Set to between 67 and 254.1.

CTCSS (Default: 88.5)

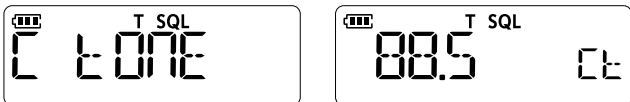

Selects a CTCSS tone Frequency.

- Options: Set to between 67 and 254.1.

CTCSS frequencies (Hz):

67.0	88.5	114.8	151.4	177.3	203.5	250.3
69.3	91.5	118.8	156.7	179.9	206.5	254.1
71.9	94.8	123.0	159.8	183.5	210.7	
74.4	97.4	127.3	162.2	186.2	218.1	
77.0	100.0	131.8	165.5	189.9	225.7	
79.7	103.5	136.5	167.9	192.8	229.1	
82.5	107.2	141.3	171.3	196.6	233.6	
85.4	110.9	146.2	173.8	199.5	241.8	

DTCS (Default: 023)

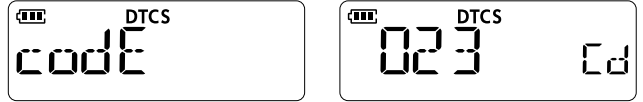

Selects a DTCS code to use for the DTCS squelch function.

DTCS codes:

023	072	152	244	311	412	466	631
025	073	155	245	315	413	503	632
026	074	156	246	325	423	506	654
031	114	162	251	331	431	516	662
032	115	165	252	332	432	523	664
036	116	172	255	343	445	526	703
043	122	174	261	346	446	532	712
047	125	205	263	351	452	546	723
051	131	212	265	356	454	565	731
053	132	223	266	364	455	606	732
054	134	225	271	365	462	612	734
065	143	226	274	371	464	624	743
071	145	243	306	411	465	627	754

DTCS polarity (Default: both n)

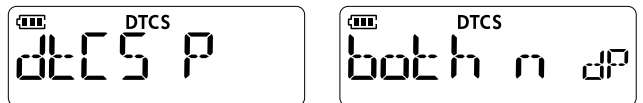

Selects a DTCS polarity for transmit and receive.

- both n: Normal polarity is used for both TX and RX.
- tn-RR: Normal polarity is used for TX and reverse polarity is used for RX.
- tR-Rn: Reverse polarity is used for TX and normal polarity is used for RX.
- both R: Reverse polarity is used for both TX and RX.

Duplex (Default: OFF)

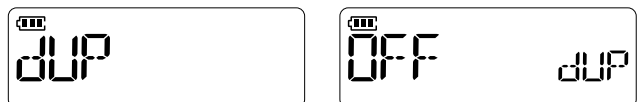

Selects a duplex direction for the Duplex operation.

- OFF: For the simplex operation (The receive and transmit frequencies are the same).
- -: The transmit frequency shifts down from the receive frequency by the offset amount.
- +: The transmit frequency shifts up from the receive frequency by the offset amount.

Set Mode items

Frequency offset (Default: 0.600*)

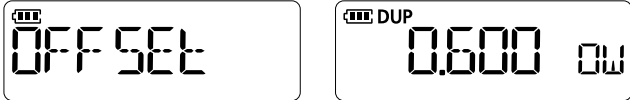

Sets the difference between the transmit and receive frequencies for Repeater operation or Duplex operation.

- Range: Set to between 0.000 and 20.000 (MHz).
*The default value may differ, depending on the frequency band.

Duplex reverse (Default: OFF)

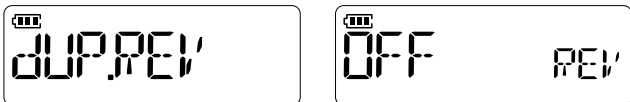

Selects whether or not to reverse the Duplex frequency.

- OFF: Normal Duplex communications.
- On: Reverse the Duplex frequency.

Tuning step (Default: 5.0*)

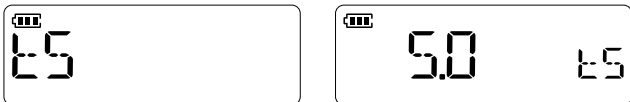

Selects a tuning step. In the VFO mode, when you select the operating frequency by rotating [DIAL], the frequency changes in this selected tuning step. It also applied for a VFO scan.

- Options: 5.0, 10.0, 12.5, 15.0, 20.0, 25.0, 30.0, 50.0, 100.0, 125.0, and 200.0 (kHz)
*A default value may differ, depending on the transceiver version.

Priority scan (Default: OFF)

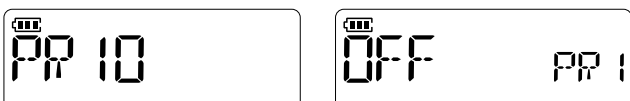

Selects whether or not to enable the Priority Scan function and Priority Bell.

- OFF: Turns OFF the function.
- On: Turn ON the function.
- bELL: When a signal is received while operating the Priority Scan, a bell sounds and "(•)" blinks.

Tone scan (Default: OFF)

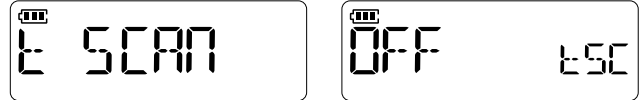

Selects whether or not to enable the Tone Scan function.

- OFF: Turns OFF the function.
- On: Detects the Tone frequency or DTCS code used by the transceiver that communicates using the Tone Squelch function.

Pause timer (Default: 15)

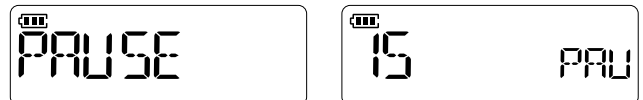

Selects a Scan Pause Timer. When a signal is received during a scan, the scan pauses for the set period of time, and then resumes.

- 5: The scan pauses for 5 seconds, and then resumes.
- 10: The scan pauses for 10 seconds, and then resumes.
- 15: The scan pauses for 15 seconds, and then resumes.
- P-2: The scan pauses until the received signal disappears, and then resumes after 2 seconds.

Program skip scan (Default: On)

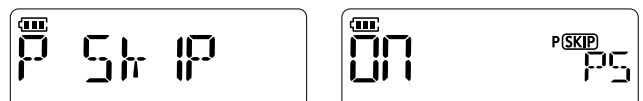

Selects whether or not to enable the Program Skip Scan function for a VFO mode scan.

This function enables the transceiver to skip the unwanted frequencies that are entered as a Memory channel and are set to "PSKIP."

- OFF: The transceiver scans all frequencies.
- On: The transceiver does not scan frequencies set as "PSKIP" frequencies.

Set Mode items

Backlight (Default: Auto)

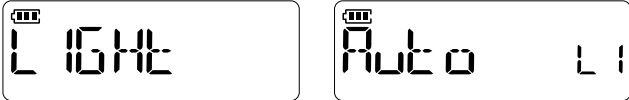

Selects a backlight option.

- OFF: Turns OFF the Backlight.
- On: Turns ON the Backlight.
- Auto: The backlight turns ON when an operation occurs, and turns OFF after 5 seconds.

VOX function (Default: OFF)

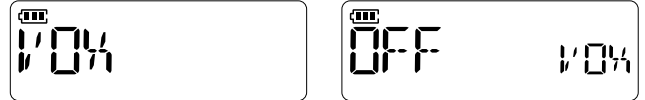

Selects whether or not to enable the VOX function.

- OFF: Turns OFF the function.
- On: Starts transmitting without pushing [PTT] when you speak into the microphone. Automatically returns to receive when you stop speaking.

PTT lock (Default: OFF)

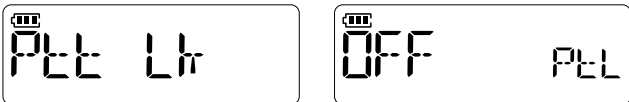

Selects whether or not to enable the PTT Lock function.

- OFF: Turns OFF the function.
- On: Inhibits transmission.

VOX level (Default: 5)

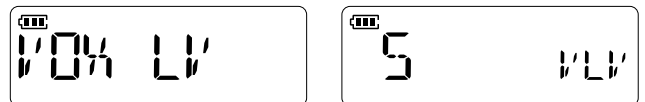

Sets a VOX level.

The VOX function automatically switches between receive and transmit by detecting your voice. Higher values make the VOX function more sensitive to your voice.

- Range: OFF, 1 ~ 10

Weather alert (Default: OFF)

(For only the USA version)

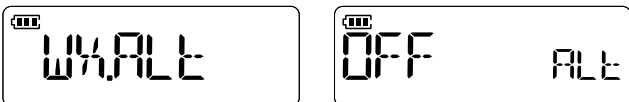

Selects whether or not to enable the Weather Alert function.

- OFF: Turns OFF the function.
- On: Notifies when the alert is received.

VOX delay (Default: 1.0)

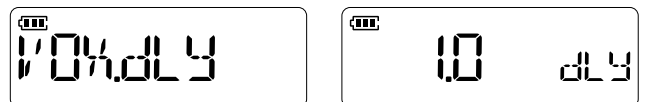

Sets the period of time the transceiver continues transmitting after the user stops speaking, and then the VOX switches to receive.

- Range: 0.5 ~ 3.0 seconds.

MIC gain (Default: 2)

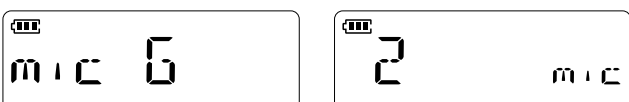

Sets the microphone sensitivity.

Higher values make the microphone more sensitive to the user's voice.

- Options: Set to between 1 (Min) and 4 (Max).

VOX time-out timer (Default: 3)

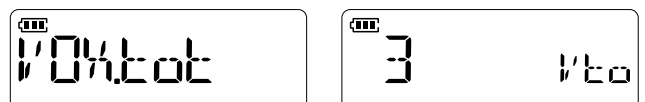

Set the VOX Time-Out Timer to prevent an accidental prolonged transmission.

- OFF: Turns OFF the function.
- 1, 2, 3, 4, 5, 10, and 15: If a continuous transmission exceeds this set period of time, the transmission is cut off.

Set Mode items

DTMF transmission (Default: kEy)

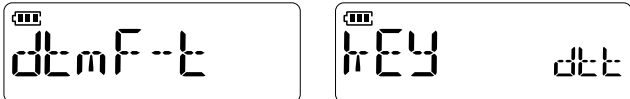

Pushing a key while holding down [PTT] transmits the DTMF code assigned to the key.

- kEy: [0] ~ [9]: Transmits (0) ~ (9).
 [SET]: Transmits (A).
 [BAND]: Transmits (B).
 [H/M/L]: Transmits (C).
 [V/M/C]: Transmits (D).
 [.] : Transmits (*).
 [ENT]: Transmits (#).
- mEm: Transmits the contents entered to the DTMF memory. (p. 6-2)
- t-CALL: Transmits 1750 Hz tone (p. 4-3).

DTMF memory

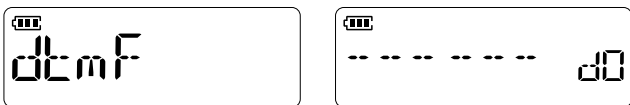

Displays a list of DTMF memory channels.

- Options: d0 ~ dF

Operating mode (Default: WIdE)

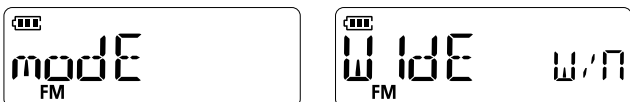

Selects an operating mode.

- WIdE: FM
- nARROW: FM-N

Initial Set Mode items

Beep level (Default: 2)

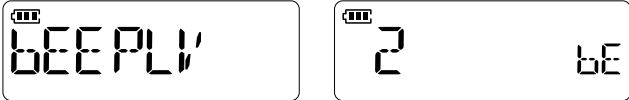

Selects a key-touch beep level.
The key-touch beep level is linked to the audio output level.

- Options: OFF, 1 (Min) ~ 3 (Max)

Time-out timer (Default: 5)

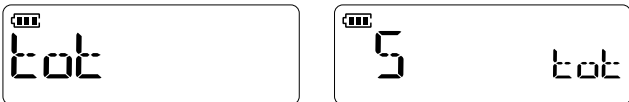

Selects whether or not to enable the Time-Out Timer.
The function inhibits continuous transmissions longer than this set period of time.

- OFF: Turns OFF the function.
- 1 ~ 30: The transmission is cut OFF after the set period of time ends.

Auto repeater (Default: R1)

(For only the USA version)

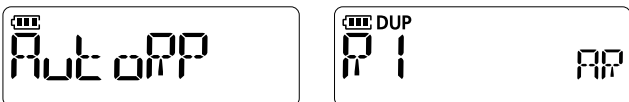

The Auto repeater function automatically turns the duplex operation and tone encoder ON or OFF. The offset and repeater tone settings are not changed by the auto repeater function. Reset these frequencies, if necessary.

- OFF: Turns OFF the function.
- R1: Turns ON only the duplex operation.
- R2: Turns ON the duplex operation and Tone encoder.

Auto power OFF (Default: OFF)

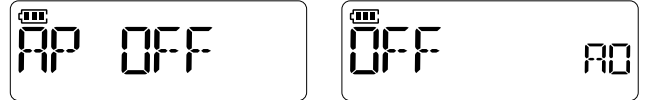

Selects whether or not to automatically turn OFF the transceiver after inactivity for this set period of time.

- OFF: Does not turn OFF the transceiver.
- 30/1H/2H: Turns OFF the transceiver after inactivity for this set period of time.
 - ① "0" is displayed in Standby mode.
 - ② Beeps sound for 5 seconds before turning OFF the transceiver. If you operate the transceiver during this period of time, the Auto Power OFF timer is reset.

Lockout (Default: OFF)

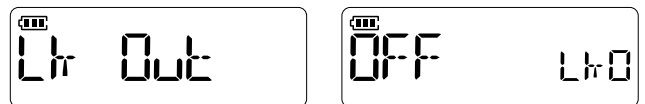

Selects whether or not to enable the Busy Lockout function.

- OFF: Transmittable even while receiving.
- RPT: Inhibits transmission if the received signal does not include the programmed tone.
- bUSy: Inhibits transmission while receiving.

Squelch delay (Default: LOnG)

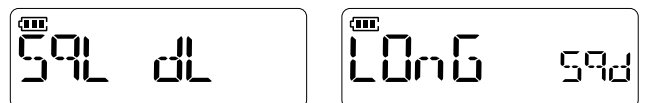

Selects a squelch delay option. The delay prevents the squelch from repeatedly opening and closing, while receiving the same signal.

- LOnG: Long squelch delay.
- SHORt: Short squelch delay.

Initial Set Mode items

DTMF speed (Default: 100)

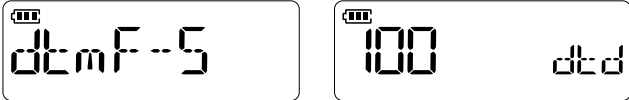

Selects a rate at which DTMF memories send individual DTMF characters to accommodate your operating needs.

- Options: 100, 200, 300, or 500 milliseconds.

Display mode (Default: FREq)

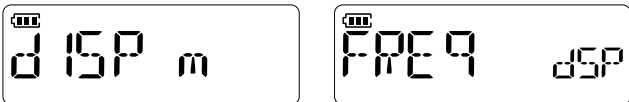

Selects a display mode in the Memory mode.

- nAmE: Displays a memory channel name (p. 2-5)
- CH*: Displays a memory channel number.
- FREq: Displays a memory channel frequency.

*When "CH" is selected, the usable functions and Set mode items will be restricted as shown below.
BM: See the BASIC MANUAL for details.

Usable functions when "CH" is selected:

- Memory Scan (p. 3-5)
- Selecting an output power (BM)
- Monitor function (BM)
- Adjusting the squelch level (BM)
- Using the Lock function (BM)
- Transmitting a DTMF code (p. 6-3)
- Home Channel function (BM)
- Set mode
(Settable items are "PAUSE," "LIGHt," "mic G," "VOX," "VOX LV," "VOX.dLy," "VOX.tot," "dtmF-t," and "dtmF.")

Power save (Default: Auto)

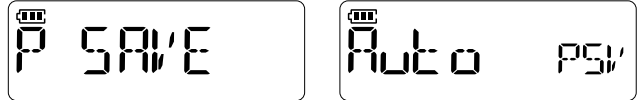

Selects an option for the Power Save function, which conserves the battery life.

- OFF: Turns OFF the function.
- 2: Sets the duty cycle to 1:2. (ON: 0.1 sec, OFF: 0.2 sec)
- 8: Sets the duty cycle to 1:8. (ON: 0.1 sec, OFF: 0.8 sec)
- 16: Sets the duty cycle to 1:16. (ON: 0.1 sec, OFF: 1.6 sec)
- Auto: Automatically sets the duty cycle. When no operation occurs and no signal is received for 5 seconds, the transceiver enters the Power Save mode, and sets the duty cycle to 1:2. After 60 seconds, it sets the duty cycle to 1:16.

Dial speed up (Default: On)

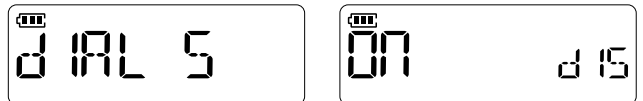

Selects whether or not to accelerate the tuning speed when rapidly rotating [DIAL].

- OFF: Turns OFF the tuning speed acceleration.
- On: Accelerates the tuning speed when rapidly rotating [DIAL].

MIC simple mode (Default: nORm-1)

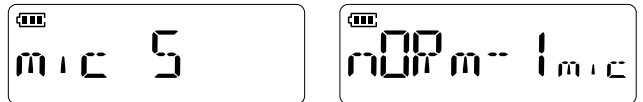

The Simple MIC function is used to assign the essential operations to the remote control unit, which will be connected through [SP] jack. See page 6-9 for details.

- Options: SImPLE, nORm-1, nORm-2

Initial Set Mode items

Voltage indication (Default: On)

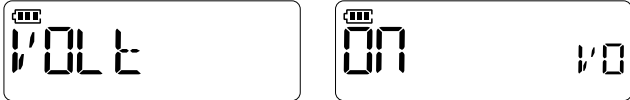

Selects whether or not to display the battery voltage while turning ON the transceiver.

- OFF: The transceiver does not display the battery voltage.
- On: The transceiver displays the battery voltage.

Auto low power (Default: OFF)

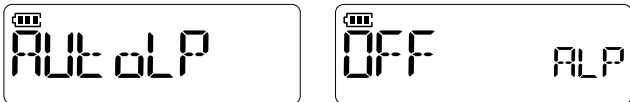

Selects whether or not to enable the Auto Low Power function.

- OFF: Turns OFF the function.
- On: When the temperature goes below 0°C (32°F), the transceiver automatically sets the all output power to low.
① High or Mid power are disabled.

Tone burst (Default: OFF)

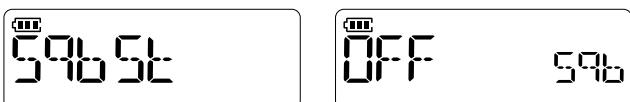

Selects whether or not to enable the Tone Burst function when using the Tone Squelch function.

- OFF: When you transmit a signal that superimposes the CTCSS tone, the other stations may hear a short burst of noise from their receiver, just after you stop transmitting.
- On: When you transmit a signal that superimposes the CTCSS tone, the function mutes the noise from being heard in the other station receiver.

Earphone antenna (Default: OFF)

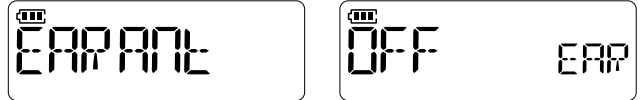

Selects whether or not to use the earphone antenna for FM radio.

- OFF: An earphone antenna is not used.
- On: An earphone antenna is used.

Monitor (Default: PUSH)

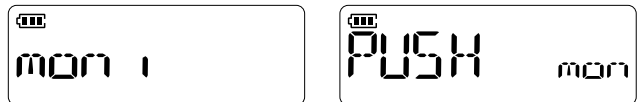

Selects how to use the Monitor function.

- PUSH: Hold down [MONI] to monitor the frequency. Release to stop monitoring.
- HOLD: Push [MONI] momentarily to monitor the frequency and push momentarily again to cancel it.

Using the DTMF memory	6-2
◇ Entering the DTMF code.....	6-2
◇ Monitoring the entered DTMF code	6-2
◇ Clearing the DTMF memory contents	6-2
Transmitting a DTMF code	6-3
◇ Using a DTMF memory channel	6-3
◇ Manual DTMF code transmission	6-3
◇ Selecting the DTMF transmit speed	6-4
Tone squelch operation	6-5
DTCS code squelch operation.....	6-6
◇ About the DTCS polarity	6-6
Using the Tone scan function	6-7
Weather channel operation (For only the USA version)	6-8
◇ Selecting a Weather channel	6-8
◇ Using the Weather Alert function	6-8
Using the VOX function	6-9
◇ Turning ON the VOX function	6-9
◇ Setting the VOX level.....	6-9
◇ VOX-related settings.....	6-9
Using the Simple MIC function	6-10
Cloning	6-11
◇ Cloning between two transceivers	6-11
◇ Cloning using a PC	6-11
Resetting	6-12
◇ Partial Reset	6-12
◇ All Reset	6-12

Using the DTMF memory

The transceiver can save up to 16 memories of a 24 digit DTMF code.

◇ Entering the DTMF code

1. Push [SET] to enter the Set mode.
 - A Set mode item is displayed.
2. Repeatedly push [SET] to select “dtmF.”
 - A DTMF memory channel number blinks.

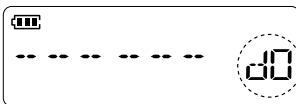

3. Rotate [DIAL] to select a DTMF memory channel.

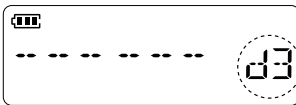

4. Hold down [SET] until two beeps sound.
 - The first digit blinks, and the transceiver enters the DTMF code Entry mode.
5. Enter the DTMF code using the Ten-keypad.
 - ① Push [MONI] to move the cursor to the right.
 - ① Push [P] to move the cursor to the left.
 - ① The following 6 empty digits are displayed when you have entered the 6th digit.
 - ① Up to 24 digits of code can be entered.



6. Push [PTT] to confirm the entry.
 - The DTMF memory channel number blinks.

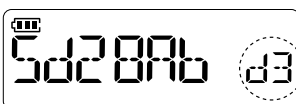

7. Push [V/M/C] to exit the Set mode.

◇ Monitoring the entered DTMF code

You can check and hear the entered DTMF code.

1. Push [SET] to enter the Set mode.
 - A Set mode item is displayed.
2. Repeatedly push [SET] to select “dtmF.”
 - A DTMF memory channel number blinks.
3. Rotate [DIAL] to select a DTMF memory channel to monitor.
4. Push [HOME] to exit the Set mode and start monitoring.

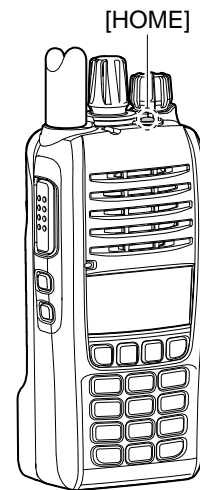

◇ Clearing the DTMF memory contents

You can clear the DTMF code that is no longer in use, as shown below.

1. Push [SET] to enter the Set mode.
 - A Set mode item is displayed.
2. Repeatedly push [SET] to select “dtmF.”
 - A DTMF memory channel number blinks.
3. Rotate [DIAL] to select a DTMF memory channel.
4. Hold down [SET] until two beeps sound.
 - The first digit blinks, and the selected DTMF memory channel content will be deleted.



5. Push [PTT].
 - The DTMF memory channel number blinks.
6. Push [V/M/C] to exit the Set mode.

Transmitting a DTMF code

The transceiver has two ways of transmitting a DTMF code sequence.

◇ Using a DTMF memory channel

Transmit the DTMF memory contents (p. 6-2).

1. Push [SET] to enter the Set mode.
 - A Set mode item is displayed.
2. Repeatedly push [SET] to select “dtmF-t.”

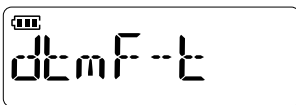

3. Rotate [DIAL] to select “mEm.”



4. Push [V/M/C] to exit the Set mode.
5. While holding down [PTT], push DTMF channel numbers shown below to transmit.

DTMF memory channel number assignment

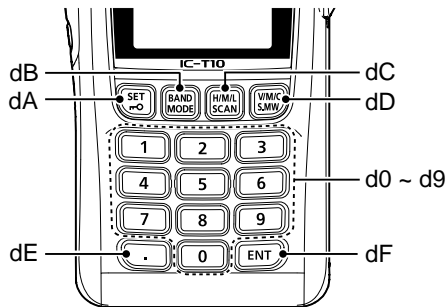

◇ Manual DTMF code transmission

Transmit the DTMF code that you manually entered using the Ten-keypad.

1. Push [SET] to enter the Set mode.
 - A Set mode item is displayed.
2. Repeatedly push [SET] to select “dtmF-t.”

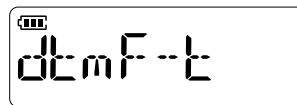

3. Rotate [DIAL] to select “kEy.”



4. Push [V/M/C] to exit the Set mode.
5. While holding down [PTT], push the keys shown below to manually transmit a DTMF code sequence.

DTMF code assignment

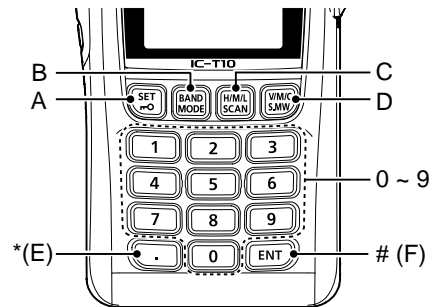

TIP: About the 1750 Hz tone

When you select “t-CALL” in step 3, a 1750 Hz tone can be transmitted.

- While holding down [PTT], push [MONI] to transmit.
 - ① You can hear the 1750 Hz tone from a speaker.

Transmitting a DTMF code

◇ **Selecting the DTMF transmit speed**

You can select the DTMF transmit speed.

1. Rotate [VOL] counter-clockwise to turn OFF the transceiver.
2. While holding down [SET], rotate [VOL] clockwise to turn ON the transceiver.
 - An Initial Set mode item is displayed.
3. Repeatedly push [SET] to select “dtmF-S.”

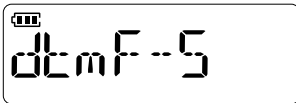

4. Rotate [DIAL] to select an option.



5. Push [V/M/C] or [ENT] to exit the Initial Set mode.

The image of transmitting the DTMF code

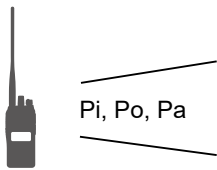

When “100ms” is selected, the DTMF transmit speed is fast.

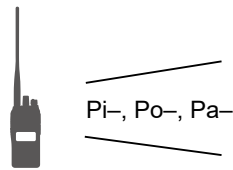

When “500ms” is selected, the DTMF transmit speed is slow.

Tone squelch operation

The tone squelch opens only when you receive a signal that includes a matching subaudible tone in the FM or FM narrow (FM-N) mode. You can silently wait for calls from other stations using the same tone. Also, the reversed tone squelch function mutes the squelch when a signal includes a matching subaudible tone.

Step. 1 Setting the tone squelch frequency

1. Repeatedly push [V/M/C] to select the VFO mode.
2. Hold down [MODE] until two beeps sound to select an operating mode.
3. Set an operating frequency.
4. Push [SET].
5. Repeatedly push [SET] to select "C tOnE."

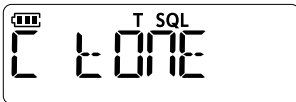

6. Rotate [DIAL] to set the tone squelch frequency.

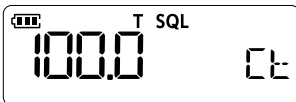

7. Push [V/M/C] to exit the Set mode.

Step. 2 Using the tone squelch

1. Push [SET].
2. Repeatedly push [SET] to select "tOnE."



3. Rotate [DIAL] to select a tone squelch type.



4. Operate normally.
 - ① You will only hear the audio of stations using the same Tone Squelch frequency. All other signals will be muted.

Tone squelch types indication

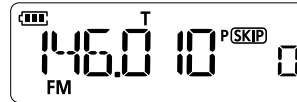

Repeater tone (Example)

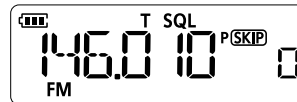

Tone squelch

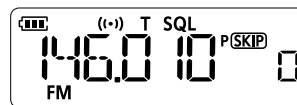

CTCSS Pocket Beep

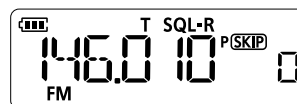

Reverse Tone Squelch

TIP: Using the Pocket Beep function
 When the transceiver receives a signal, a beep sounds for 30 seconds and "(••)" blinks.
 ① Confirm "P bEEP" is selected in the Set mode. (p. 5-3)

DTCS code squelch operation

The tone squelch opens only when you receive a signal that includes a matching DTCS code in the FM or FM narrow (FM-N) mode. You can silently wait for calls from others using the same tone. Also, a reversed tone squelch function mutes the squelch when you receive a signal including a matching DTCS code.

Step. 1 Setting the DTCS code

1. Repeatedly push [V/M/C] to select the VFO mode.
2. Hold down [MODE] until a beep sound to select an operating mode.
3. Set an operating frequency.
4. Push [SET].
5. Repeatedly push [SET] to select "code."

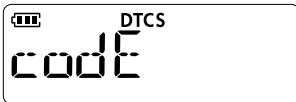

6. Rotate [DIAL] to set the DTCS code.

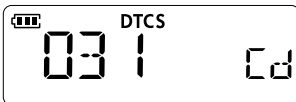

7. Push [V/M/C] to exit the Set mode.

Step. 2 Using the DTCS code squelch

1. Push [SET].
2. Repeatedly push [SET] to select "tOnE."



3. Rotate [DIAL] to select a tone squelch type.

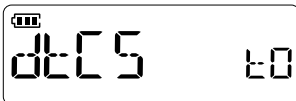

4. Operate normally.
 - ① You will only hear the audio of stations using the same DTCS code. All other signals will be muted.

DTCS codes indication



DTCS code squelch

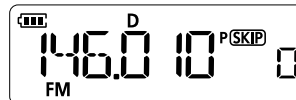

DTCS code transmission

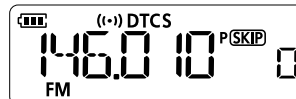

DTCS Pocket Beep

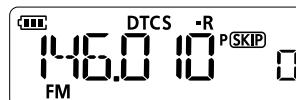

Reverse DTCS

TIP: Using the Pocket Beep function

When the transceiver receives a signal, a beep sounds for 30 seconds and "(••)" blinks.

① Confirm "P dtCS" is selected in the Set mode. (p. 5-3)

◇ About the DTCS polarity

You can select an option for the DTCS polarity in the Set mode (p. 5-3).

Using the Tone scan function

The Tone Scan function detects the subaudible tone frequency and DTCS code in a received signal. By monitoring a signal transmitted on a repeater input frequency, you can determine the tone frequency required to access the repeater.

Step.1 Turning ON the Tone scan function

1. Push [SET] to enter the Set mode.
 - A Set mode item is displayed.
2. Repeatedly push [SET] to select "t SCAN."



3. Rotate [DIAL] to select "On."



4. Push [V/M/C] to exit the Set mode.

Step.2 Using the Tone scan function

- Hold down [SCAN] until a beep sounds to start the scan.
 - ① The transceiver slowly scans while receiving, rapidly scans while no signal is received.
 - ① When the tone frequency or DTCS code is received, the transceiver overwrites the Set mode contents (tone frequency or DTCS code) by the received one, and then continues scanning.
 - ① The transceiver automatically disables the Pocket Beep function, if you start scanning with the function is turned ON.

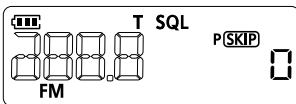

Tone scan

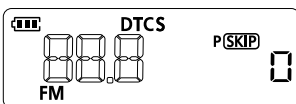

DTCS code scan

Weather channel operation (For only the USA version)

There are ten weather channels for monitoring the National Oceanographic and Atmospheric Administration (NOAA) weather broadcasts.

◇ Selecting a Weather channel

1. Repeatedly push [V/M/C] to select the Weather Channel mode.

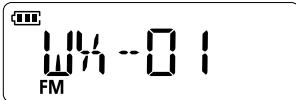

2. Rotate [DIAL] to select a weather channel.
 - Displays the selected weather channel number.

◇ Using the Weather Alert function

NOAA broadcast stations transmit weather alert tones before important weather announcements. When the weather alert function is turned ON, the selected weather channel is monitored every 5 seconds for an announcement.

Step 1. Turning ON the Weather Alert function

1. Push [SET] to enter the Set mode.
 - A Set mode item is displayed.
2. Repeatedly push [SET] to select "WX.ALt."

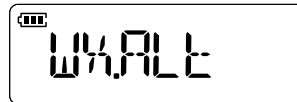

3. Rotate [DIAL] to select "On."

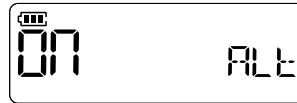

4. Push [V/M/C] to exit the Set mode.

Step 2. Using the Weather Alert function

1. Repeatedly push [V/M/C] to select the Weather Channel mode.
 - "WX" is displayed.

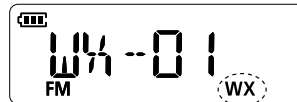

2. Rotate [DIAL] to select a weather channel.
 - Displays the selected weather channel number.
 - When a signal is received, a beep sounds and the "ALT" and "WX" alternately display.

Using the VOX function

The Voice Operated eXchange (VOX) function toggles the transceiver between transmit and receive by your voice. This function provides hands-free operation. You can use the VOX function with the optional HS-94LWP or HS-95LWP.

NOTE: BE SURE to turn OFF the transceiver when plugging or unplugging the headset into or from the [SP] jack.

◇ Turning ON the VOX function

1. Push [SET] to enter the Set mode.
 - A Set mode item is displayed.
2. Repeatedly push [SET] to select "VOX."



3. Rotate [DIAL] to select "On."



4. Push [V/M/C] to exit the Set mode.
 - "VOX" is displayed when an optional headset is attached to the transceiver.

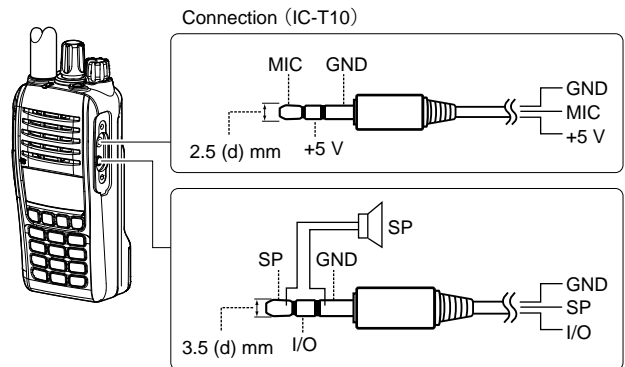
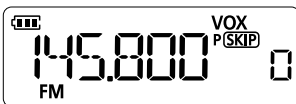

◇ Setting the VOX level

1. Push [SET] to enter the Set mode.
 - A Set mode item is displayed.
2. Repeatedly push [SET] to select "VOX LV."

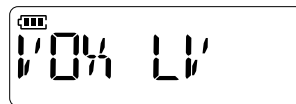

3. While speaking into the headset, rotate [DIAL] to adjust the VOX level.
 - "VOX" is displayed when the TX level audio is input.
 - ① Adjust until "VOX" is continuously displayed.
 - ① Higher values make the VOX function more sensitive to your voice.



4. Push [V/M/C] to exit the Set mode.

◇ VOX-related settings

Adjust the VOX-related settings in the Set mode. See page 5-5 for details.

Using the Simple MIC function

The Simple MIC function enables controlling the transceiver through your control unit attached to the [SP] jack.

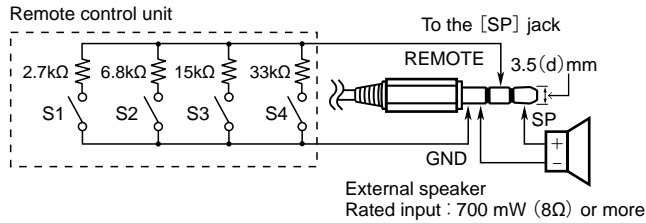

NOTE: BE SURE to turn OFF the transceiver when plugging or unplugging the headset into or from the [SP] jack.

• SImPLE

S1	Selects a Call channel.
S2	Turns the Monitor function ON or OFF.
S3	Selects memory channel 0.
S4	Selects memory channel 1.

• nORm-1

S1	Toggles between the VFO mode and Memory mode.
S2	Selects a Call channel.
S3	Frequency or memory channel "UP."
S4	Frequency or memory channel "DOWN."

• nORm-2

S1	Toggles between the VFO mode and Memory mode.
S2	Turns the Monitor function ON or OFF.
S3	Frequency or memory channel "UP."
S4	Frequency or memory channel "DOWN."

• Common (SImPLE, nORm-1, nORm-2)

S2	Transmits t-CALL (1750 Hz tone) while holding down [PTT].
S3	Enters the Squelch adjustment mode while using the Monitor function.
S4	Enters the Squelch adjustment mode while using the Monitor function.

Cloning

The transceiver has a data copying capability. This function is useful for copying all of the settings and entered contents from one transceiver to another.

◇ Cloning between two transceivers

An optional OPC-474 PROGRAMMING CABLE or 3.5 mm (1/8 inch) stereo jack cable (user supplied) is required.

1. Turn OFF the transceivers, and connect the master and sub-transceivers using the OPC-474 or stereo jack cable through their [SP] jacks.

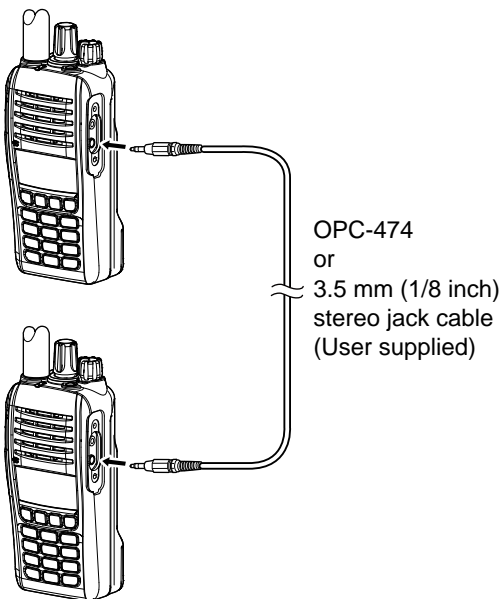

2. Turn ON the sub-transceiver.
3. While holding down [V/M/C], turn ON the master transceiver to enter the Cloning mode.
 - “CLOnE m” is displayed.
4. Push [PTT] on the master transceiver to start cloning.
 - While cloning, “CL Out” is displayed on the master transceiver’s function display.
 - While cloning, “CL In” is displayed on the sub-transceiver’s function display.
 - When the cloning is finished, “CL End” is displayed on the sub-transceiver’s function display.

◇ Cloning using a PC

Copy the data using the optional CS-T10 PROGRAMMING SOFTWARE and an OPC-478UC/OPC-478UC-1 PROGRAMMING CABLE.

Refer to the INSTRUCTIONS and the Help file that come with the programming software, for details.

CAUTION: BE SURE to turn OFF the transceiver, before connecting or disconnecting an optional equipment to or from the [MIC/SP] jack.

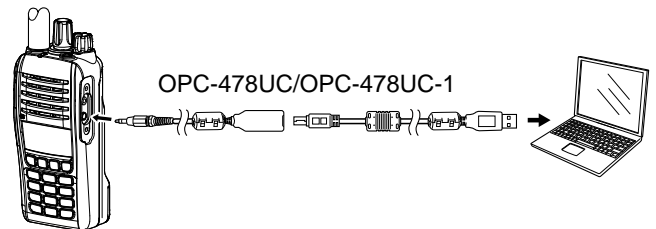

Resetting

If the transceiver has a malfunction caused by an external factor such as static electricity, reset it using the Partial Reset or All Reset function.

BE CAREFUL! An All Reset clears all programming and returns all settings to the factory defaults.

◇ Partial Reset

1. Rotate [VOL] counter-clockwise to turn OFF the transceiver.
2. While holding down [H/M/L], rotate [VOL] clockwise to turn ON the transceiver.
 - "Icom" and the voltage are displayed, and then the operating frequency is displayed.

Icom



8.0 V



145.000 P(SKIP) 0
FM

◇ All Reset

1. Rotate [VOL] counter-clockwise to turn OFF the transceiver.
2. While holding down [SET], [BAND], and [H/M/L], rotate [VOL] clockwise to turn ON the transceiver.
 - "CLEAR," "Icom," and the voltage are displayed, and then the operating frequency is displayed.

CLEAR



Icom



8.0 V



145.000 P(SKIP) 0
FM

TIP: A Partial Reset resets the operating settings to their defaults without clearing the following:

- Memory Channel contents
- Scan Edge contents
- Call Channel contents
- DTMF memory contents
- Home Channel settings

Section 7 OPTIONS

Options	7-2
◇ Microphone	7-2
◇ Battery pack	7-2
◇ Chargers/Adapters/DC cables	7-2
◇ Others	7-2
◇ Detaching/Attaching the jack cover	7-3
◇ Using the optional speaker microphone	7-4
◇ Panel description	7-4

Options

◇ Microphone

- **HM-158LA/HM-159LA/ HM-168LWP/HM-222HLWP** SPEAKER MICROPHONE
Combination speaker microphone that provides convenient operation while the transceiver is hanging on your belt.
- **HM-153LA** EARPHONE MICROPHONE + **EH-15B** EARPHONE/
HM-166LA EARPHONE MICROPHONE
Ideal for hands-free operation. Clip the HM-153LA or HM-166LA (with integrated PTT switch) to your lapel or breast pocket.
- **HS-94LWP/HS-95LWP** HEADSET
HS-94LWP: Ear-hook type
HS-95LWP: Neck-arm type

◇ Battery pack

- **BP-280** BATTERY PACK
Voltage: 7.2 V
Capacity: 2280 mAh (minimum), 2400 mAh (typical)

◇ Chargers/Adapters/DC cables

- **BC-213** DESKTOP CHARGER + **BC-123SA/BC-123SE** AC ADAPTER/
BC-242 AC ADAPTER
To rapidly charge a single battery pack. The supplied power adapter may differ, depending on the charger version.
- **CP-23L** CIGARETTE LIGHTER CABLE
Use when charging the battery pack from a 12 V cigarette lighter socket. (Use with the BC-213)
- **BC-214/BC-214N** MULTI CHARGER + **BC-157S** AC ADAPTER + **AD-130** CHARGER ADAPTER
To rapidly charge up to 6 battery packs.
- **OPC-656** DC POWER CABLE
Use with a 13.8 V power source instead of the power adapter. (Use with the BC-214)
- **AD-149H** EXTERNAL POWER SUPPLY + **CP-12L** CIGARETTE LIGHTER CABLE/
OPC-254L DC POWER CABLE
CP-12L: With noise filter.
Fuse Coding: FUSE 125V 3A
Fuse Voltage Rating: 125 Volts
Fuse Current Rating: 3 Amperes
OPC-254L: Directly connects to a DC power source.
Fuse Coding: FUSE 250V 3A
Fuse Voltage Rating: 250 Volts
Fuse Current Rating: 3 Amperes

◇ Others

- **MB-130** CHARGER BRACKET
Mounts the BC-213 DESKTOP CHARGER on a variety of places in a vehicle.
- **MB-133** BELT CLIP
- **CS-T10** PROGRAMMING SOFTWARE + **OPC-478UC/OPC-478UC-1** PROGRAMMING CABLE
The software to program the transceiver. Use the OPC-478UC or OPC-478UC-1 to connect the transceiver to a PC.

Some options may not be available in some countries. Ask your dealer for details.

Options

◇ Detaching/Attaching the jack cover

The jack cover is attached using the M2 x 6 mm screws.

Detaching:

1. Remove the screws (1).
2. Remove the jack cover (2).

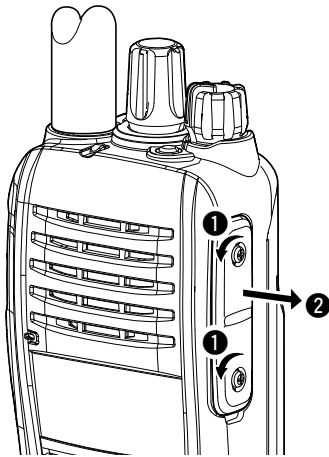

Attaching:

1. Attach the jack cover (1).
2. Attach the screws (2).

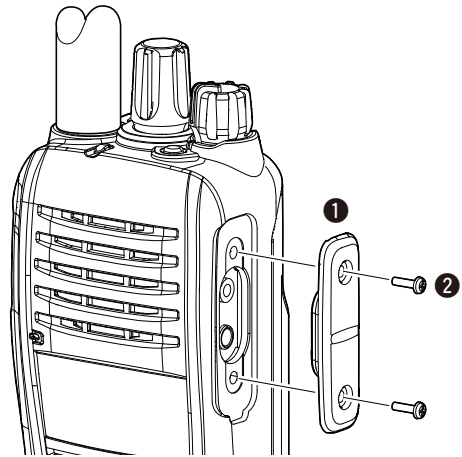

CAUTION:

- **DO NOT** use the transceiver without the jack cover or the optional equipment attached. The transceiver meets IP67 requirements for dust-tight and waterproof protection only when the jack cover or the specified optional speaker microphone is attached.
- **DO NOT** use other than the supplied screws.

Options

◇ Using the optional speaker microphone

Use the optional speaker microphone on page 7-2, as shown below.

Attaching:

- Attach the microphone's plug to the [MIC/SP] jack, and then tighten the screws using your finger.
 - ① Turn OFF the transceiver before attaching or detaching the microphone.
 - ② When tightening the screws, make sure the plug is firmly attached, and the rubber packing is not visible.

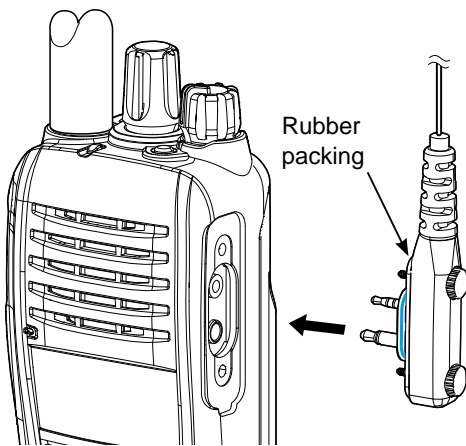

CAUTION: DO NOT expose the plug to rain, snow, saltwater, or any other liquids. If the plug gets wet, be sure to wipe it dry cloth before attaching.

◇ Panel description

HM-168LWP:

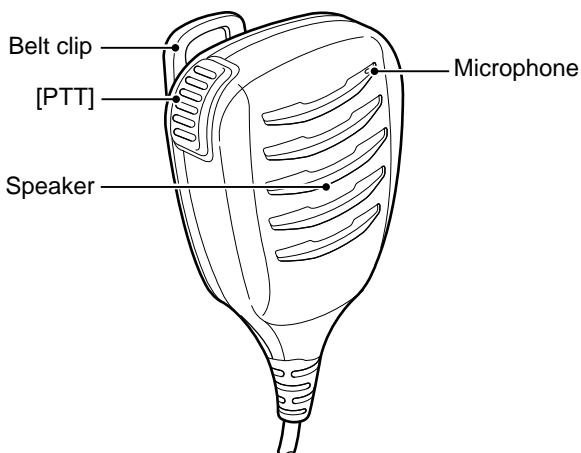

HM-222HLWP:

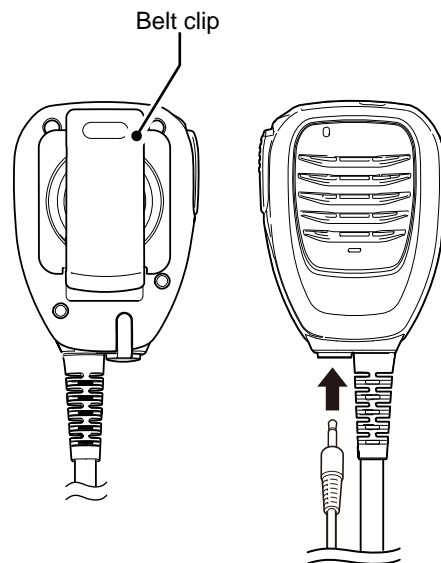
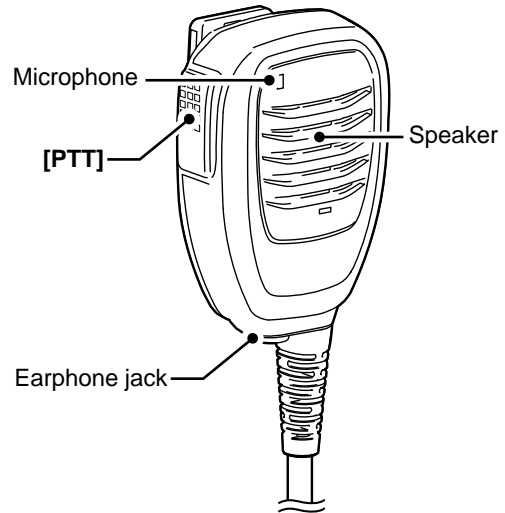

NOTE: Keep the connector cover attached to the transceiver when the speaker microphone is not in use. Water will not get into the transceiver, even if the cover is not attached. However, the terminals (pins) will become rusty, or the transceiver will function abnormally if the connector becomes wet.

TIP: To maximize the readability of your signal:

1. After pushing [PTT], pause briefly before you start speaking.
2. Hold the microphone 5 to 10 cm (2 to 4 inches) from your mouth, then speak at your normal voice level.

