

9097250 TOSHIBA (DISCRETE/OPTO)

56C 07470 DT-33-07

SILICON NPN EPITAXIAL TYPE (PCT PROCESS)

2SC2075

27MHZ POWER AMPLIFIER APPLICATIONS.

Unit in mm

FEATURES:

- Recommended for Output Stage Application of AM 4W Transmitter.
- High Power Gain.
- Wide Area of Safe Operation.

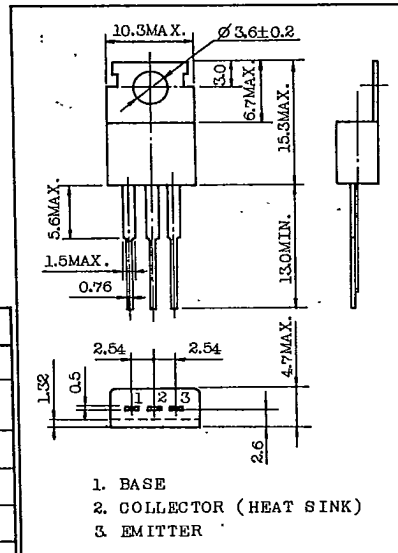

MAXIMUM RATINGS (Ta=25°C)

CHARACTERISTIC	SYMBOL	RATING	UNIT
Collector-Base Voltage	V _{CB0}	80	V
Collector-Emitter Voltage R _{BE} =50Ω	V _{CER}	80	V
Emitter-Base Voltage	V _{EBO}	4.0	V
Collector Current	I _C	4	A
Emitter Current	I _E	- 4	A
Collector Power Dissipation (T _c =25°C)	P _C	10	W
Junction Temperature	T _j	150	°C
Storage Temperature Range	T _{stg}	-55~150	°C

JEDEC	TO - 220 AB
EIAJ	SC - 46
TOSHIBA	2 - 10 A 1 A

Mounting Kit No. AC75
Weight : 1.9g

ELECTRICAL CHARACTERISTICS (Ta=25°C)

CHARACTERISTIC	SYMBOL	TEST CONDITION	MIN.	TYP.	MAX.	UNIT	
Collector Cut-off Current	I _{CBO}	V _{CB} =30V, I _E =0	-	-	10	μA	
Breakdown Voltage	Collector-Emitter	V _{(BR)CER}	I _C =10mA, R _{BE} =50Ω	80	-	-	V
	Emitter-Base	V _{(BR)EBO}	I _E =1.0mA, I _C =0	4.0	-	-	V
DC Current Gain	h _{FE} (1)	V _{CE} =5V, I _C =0.5A	25	-	-		
	h _{FE} (2)	V _{CE} =2V, I _C =3A	15	-	-		
Collector-Emitter Saturation Voltage	V _{CE(sat)}	I _C =3A, I _B =0.3A	-	-	1.5	V	
Transition Frequency	f _T	V _{CE} =5V, I _C =500mA	-	100	-	MHz	
Collector Output Capacitance	C _{ob}	V _{CB} =10V, I _E =0, f=1MHz	-	40	-	pF	
Output Power (Fig. 1)	P _o	V _{CC} =12V, P _i =0.3W, f=27MHz	3.5	-	-	W	

Fig. 1 P_o TEST CIRCUIT

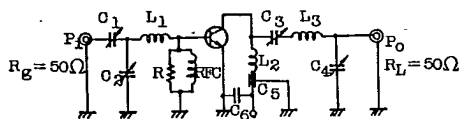

- C₁ : ~100pF, C₂, C₃ : ~150pF, C₄ : ~300pF, C₅ : 1000pF
- C₆ : 0.01μF
- R : 250Ω
- L₁ : 0.8mm∅ UEW, 7T, 8mm I.D
- L₂ : 0.8mm∅ UEW, 5T, 8mm I.D
- L₃ : 0.8mm∅ UEW, 10T, 8mm I.D
- RFC : 0.35mm∅ UEW, 17T, 5mm I.D

TOSHIBA CORPORATION

2SC2075

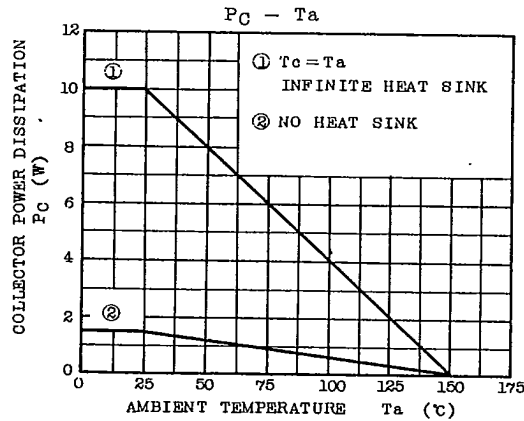
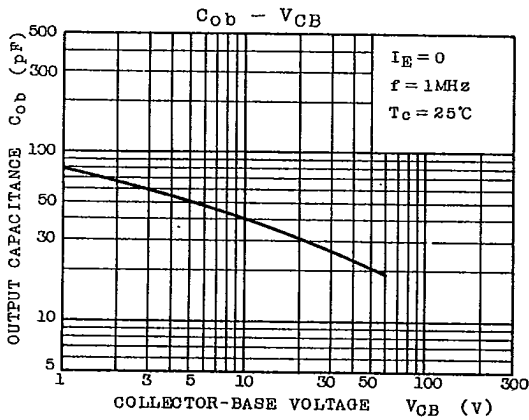
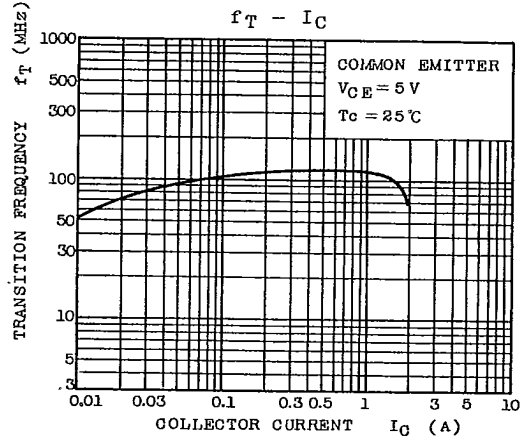
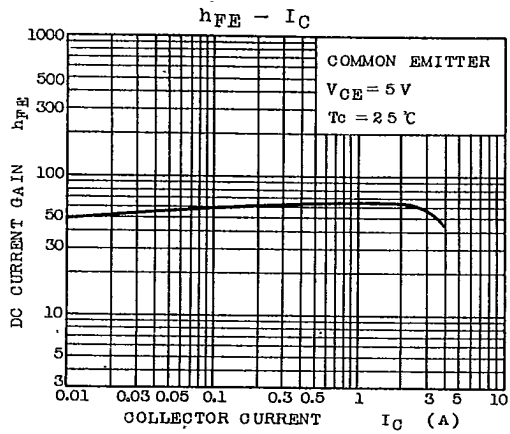
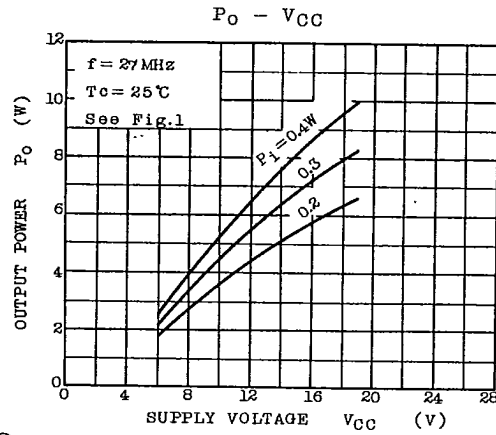
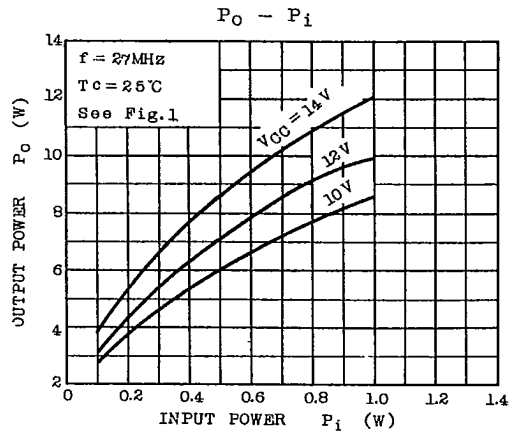

TOSHIBA CORPORATION

2SC2075

FIG.2 27MHz 4W OUTPUT AM TRANSCEIVER CIRCUIT

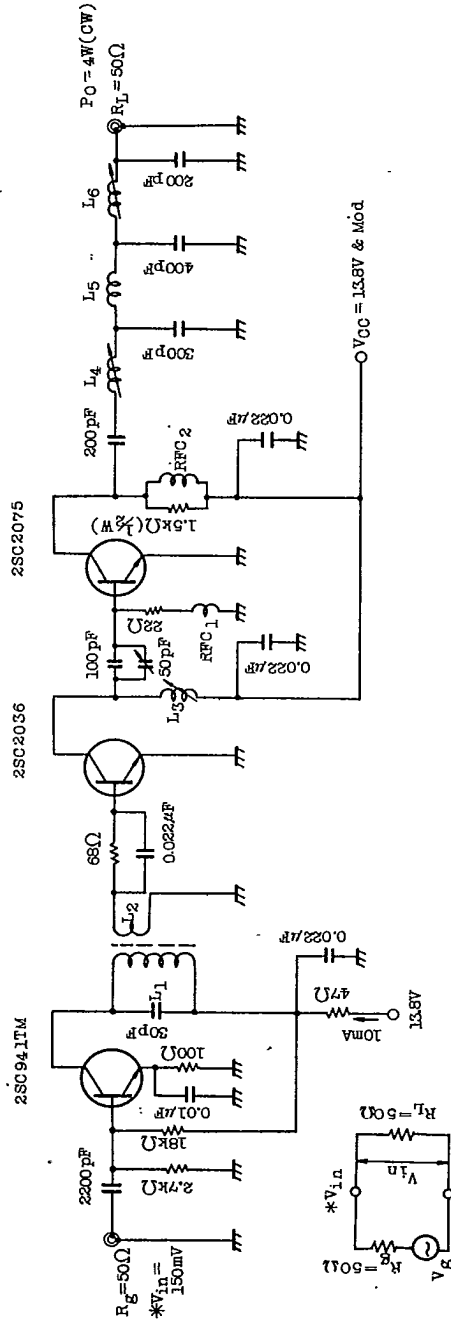

- L₁ : 4mm∅ BOBBIN WITH FERRITE CORE , 0.08mm∅ UEW, 8 TURNS
- L₂ : 4mm∅ BOBBIN WITH FERRITE CORE , 0.08mm∅ UEW, 2 TURNS
- L₃, L₆ : 6.5mm∅ BOBBIN WITH FERRITE CORE , 0.6mm∅ Sn PLATED COPPER WIRE 6½ TURNS
- L₄ : 6.5mm∅ BOBBIN WITH FERRITE CORE , 0.6mm∅ Sn PLATED COPPER WIRE 8½ TURNS
- L₅ : 0.6mm∅ Sn PLATED COPPER WIRE , 6.5mm I.D., 8½ TURNS
- RFC₁ : 47 #H, 7BA-480k (TOKO)
- RFC₂ : 0.2mm∅ UEW, 30 TURNS

RESISTOR : ¼ W CARBON
CAPACITOR : CERAMIC

TOSHIBA CORPORATION

2SC2075

APPLICATION CIRCUIT CHARACTERISTIC

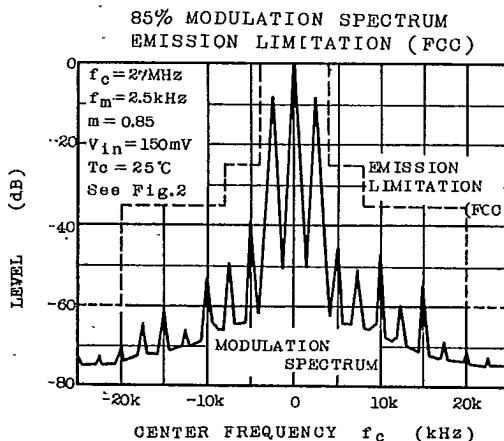
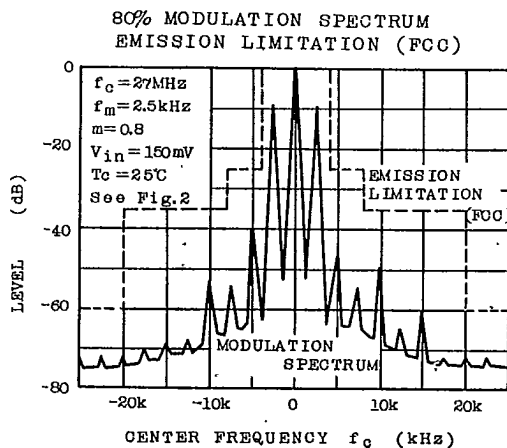
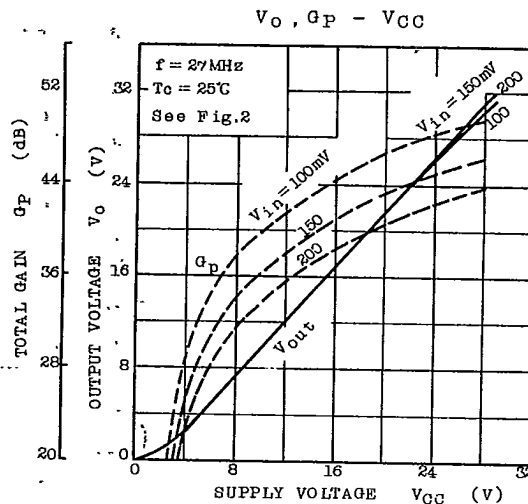
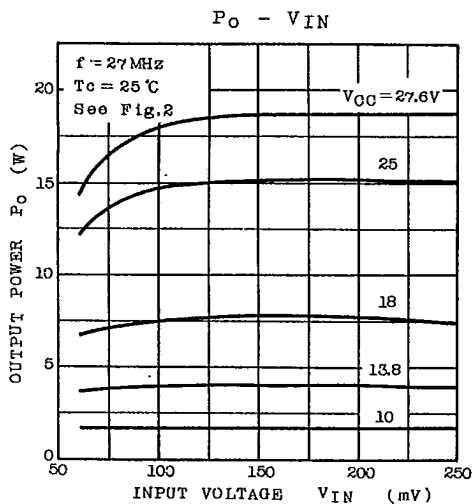

TOSHIBA CORPORATION