

AnyTone[®]

AT-5000

Instruction Manual



WARNING

In order to comply with RF exposure requirements for mobile transmitting devices, a minimum distance of 20cm must be maintained between the antenna and all persons.

CONTENTS

1. FUNCTIONS & FEATURES	1
2. ACCESSORIES	2
2.1 Standard Accessories	2
2.2 Optional Accessories	2
3. INSTALLATION	3
3.1 Microphone Connection	3
3.2 Antenna Connection	3
3.3 Power Connection	4
3.4 Fuse Replacement	4
3.5 Install Microphone Hanger	5
3.6 Install External Speaker	5
4. GETTING ACQUAINTED	6
4.1 Front Panel	6
4.2 Rear Panel	6
4.3 Microphone	7
5. BUTTON FUNCTION INSTRUCTIONS	8
5.1 Power Key	8
5.2 Volume Control Knob	8
5.3 Key Locking Function	8
5.4 Modulation Mode Selection	8
5.5 Weather Channel Function	8
5.6 SQ Level Adjustment	8
5.7 ASQ Level Adjustment	9
5.8 RF Gain Adjustment	9
5.9 Emergency Channel Call	9
5.10 Memory Channel	9
5.11 Store Memory Channel	9
5.12 Delete Memory Channel	9
5.13 Channel Selection	10
5.14 Scan Function	10
5.15 Dual Watch Function	10
5.16 Noise Reduction (NRC) Function	10
5.17 Hands Free VOX Function	10
5.18 SSB Frequency Fine Tuning	10
6. MENU SETTING	11
6.1 Function Menu Setting	11
6.2 Public Menu Setting	14
6.3 Channel Menu Setting	15
6.4 DTMF Menu Setting	16
6.5 Microphone Menu Setting	17
6.6 Time Setting	17
6.7 Weather Channel Menu Setting (optional functions)	18
6.8 Wireless BT Menu Setting (optional functions)	17
6.9 Radio version check	17
7. SPECIFICATIONS	21

1. FUNCTIONS & FEATURES

- TFT LCD display
- 12/24V voltage support
- The aluminium body ensures reliable heat radiation
- CTCSS/DCS encoding and decoding function
- Supports multiple microphones (optional)
- Wireless BT function (optional)
- USB, LSB, CW, AM, FM, PA modes
- Flexible function menu
- DTMF function
- SQ and ASQ functions
- RF gain function
- Scanning function
- Dual watch function
- Programmable RB function
- Emergency channel function
- Storage channel function
- NB/ANL function
- HI-CUT function
- ECHO function
- VOX function
- NRC (noise reduction) function
- Power supply voltage protection function
- Timeout timer (TOT) function
- Backlight brightness adjustment
- Keyboard lock function
- Weather channel function (optional)

2. ACCESSORIES

2.1 Standard Accessories



Radio



Microphone

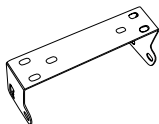

Install bracket



Screws



Pads



Adjusting screws

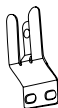

Microphone Hanger



non-slip mat



Fuse(10A 250V)

2.2 Optional Accessories



PC cable



8 ohm speaker

3. INSTALLATION

Choose a ideal location to install the radio.

1. Mark the location for screws to secure the install bracket.
2. Fix the bracket with screws.
3. Fix radio base into install bracket and lock with adjusting screws.

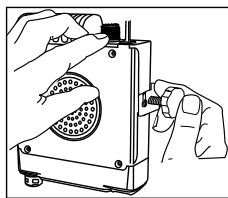
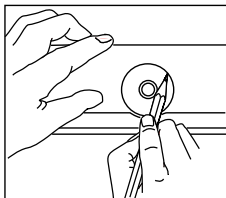

3.1 Microphone Connection

1. Plug microphone connector into jack.
2. Secure the dustproof cover for microphone connector.



3.2 Antenna Connection

 **NOTE** » Never press PTT before installing the antenna. damage to the radio may occur.

1. Screw on the antenna into antenna jack.
 2. To make full use of this radio, it is necessary to locate the antenna in a well grounded place, and ensure it is tuned with a with a low SWR.
- * Please enquire at your local dealer regarding choosing and installing a suitable antenna.

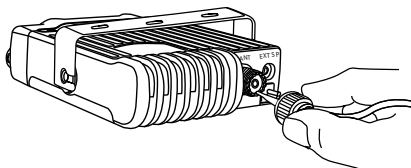

3.3 Power Connection

This radio adopt 13.2V power supply.

Connect the red wire to the positive terminal of the battery, and the black wire to the negative terminal of the battery.

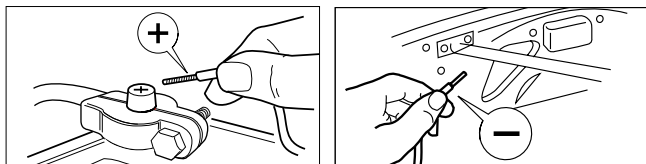

3.4 Fuse Replacement

This radio adopt 10A, 250V fuse

1. Open the fuse holder

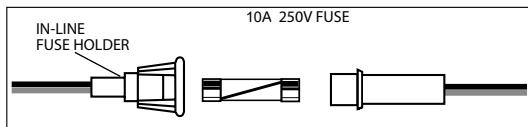

2. Replace the fuse and screw on the holder.

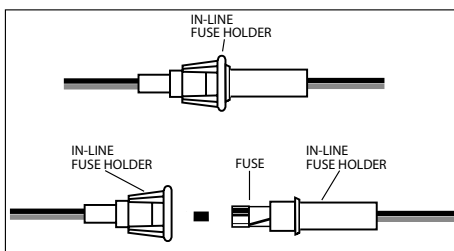

3.5 Install Microphone Hanger

1. Choose ideal location and mark for screw points.
2. Fix the hanger using the screws shown in the accessory list.

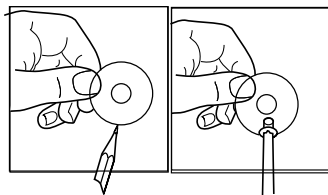

3.6 Install External Speaker (Optional)

This radio can adopt a 4-8 ohm, 4W external speaker.

1. Install the external speaker in idea location.
2. Plug in the speaker connector into jack.

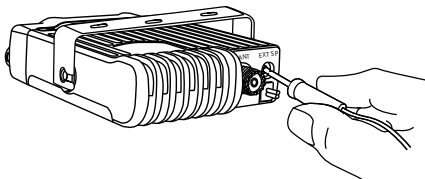

4. GETTING ACQUAINTED

4.1 Front Panel

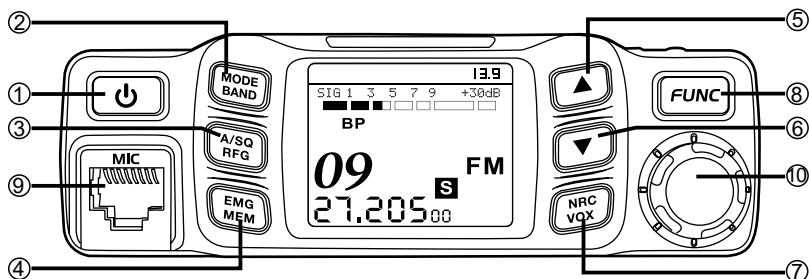

NO.	Key	Functions
1		Power On/Off/Mute
2		Modulation mode / Band switch
3		SQ/ASQ squelch, RF Gain level setting
4		EMG channel / Memory storage channel
5		Channel up
6		Channel down
7		NRC noise reduction function / VOX hands-free
8		Function Menu key
9	MIC	Microphone Jack
10		VOL Switch/Push key/ Key lock

4.2 Rear Panel

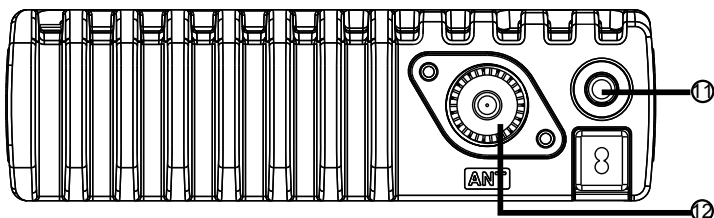

NO.	Functions
11	External Speaker Jack
12	Antenna Jack

4.3 Microphone

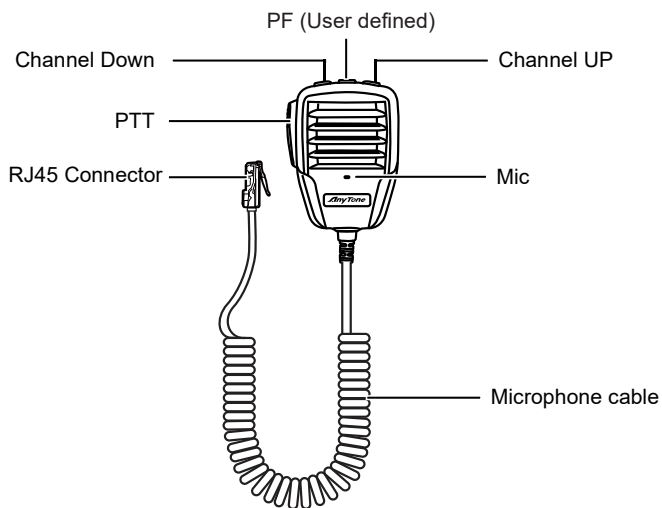



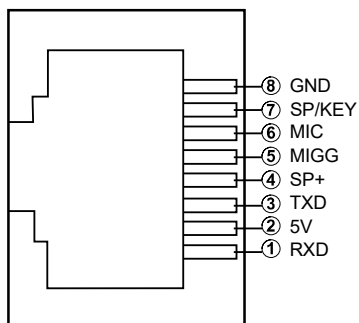

Microphone pin-out



5. BUTTON FUNCTION INSTRUCTIONS

5.1 Power Key

1. Turn on the radio: Short press the  key, to switch the radio ON, the radio may emit a beep depend on if the prompt beep is enabled , and the screen will display startup logo, then enter standby status.
2. Turn off the radio: Long press the  key until the screen displays the startup logo, release the key, the display will off and radio power off.
3. Quick mute: In standby status, Short press the  key, the screen displays " **Speaker Mute On** " , and the **MUTE** icon is displayed in the upper left corner of the the screen, the radio enters the mute state; Short press the  key again, and " **Speaker Mute Off** " will be displayed on the screen. and the **MUTE** icon will disappear,

5.2 Volume Control Knob

When the radio is turned on, turning **VOL** clockwise will increase the Volume level. Turning **VOL** anti-clockwise will reduce the Volume level. Adjust the volume during communication to get suitable level. (NOTE: See the "CH/VOL Swap" menu item to swap this function to the Up/Down keys.)

5.3 Key Locking Function

Press and hold the [PUSH] key to turn on key lock function, the LCD will display key lock icon. Press and hold the [PUSH] key again to unlock the key.



 » *When this function is turned on, only the [PTT] button is valid.*

NOTE

5.4 Modulation Mode Selection

Short press the  key to choose the modulation mode FM → AM → USB → LSB → PA → CW.



5.5 Weather Channel Function

Long press the  key to enter weather channel , long press the  key again to exit weather channel.



5.6 Squelch SQ Level Adjustment

- 1.Short press the  key to display the current SQ level on the screen, and rotate the channel knob to adjust the squelch level;
- 2.Press any key or wait for 3 seconds to automatically save and exit the function settings.

5.7 ASQ Level Adjustment



1. Long press the  key to switch to the ASQ function, and the screen will display the AQ character;
2. Short press the  key to display the current ASQ level on the screen, and rotate the channel knob to adjust the squelch level;
3. Press any key or wait for 3 seconds to automatically save and exit the function settings.

5.8 RF Gain Adjustment





1. Short press the + key to enter the RF gain adjustment menu, and the screen will display Rx Gain Level: **xxx**;
2. Rotate the channel knob to adjust the RF gain level;
3. Press any key or wait for 3 seconds to automatically save and exit the function settings.

5.9 Emergency Channel

Short press the  key to enter emergency channel, the screen will display "EMG".

1. Short press the  key to choose CH9;
2. Short press the  key again to choose CH19 ;
3. Short press the  key again return to last normal channel.

5.10 Memory Channel

1. Press the  key+ key to enter the memory channel mode, rotate the channel switch to choose memory channel, total of 16 channels;
2. Press the  key+ key again to exit the memory channel mode.

5.11 Store memory Channel:

Select the channel which want to be stored, long press the [MEM] key to enter the memory channel mode, rotate the channel switch to select the channel number to be stored, long press the  key until the screen displays the channel that has been stored, and the storage is complete.

-  » 1. When the screen flashes red MEM, it indicates that the current storage channel has stored data:
- » 2. When the screen flashes blue MEM, it indicates that there is no data stored in the current storage channel:

5.12 Delete Memory Channel

Select the channel which want to be deleted, press and hold the  key for 3 seconds, and the radio will emit a "beep" prompt sound. The current storage channel has been deleted.

5.13 Channel Selection

1. Short press the [▲]/[▼] or the [UP]/[DN] keys on the microphone to switch the working channel.
2. Long press the [▲]/[▼] or [UP]/[DN] keys on the microphone to quickly switch between working channels.

5.14 Scan Function

1. Press the **FUNC** key+[▲] key to activate the scan function, and the screen will display the "S" icon;
2. Short press the [▲]/[▼] or [UP]/[DN] keys on the microphone while scanning to change the scanning direction;
3. Press the **FUNC** key+[▲] key again to exit the scanning mode.

5.15 Dual Watch Function

1. Select the dual watch channel, press the **FUNC** key+[▼] key to start the dual watch function, and the screen will display the "DW" icon;
2. Press the **FUNC** key+[▼] key to exit the dual standby state.

5.16 Noise Reduction (NRC) Function

1. Short press the NRC button to turn on or off the NRC function, and the LCD will display the NRC icon;
2. Long press the NRC button for 3 seconds to enter to the NRC menu.

5.17 Hands Free VOX Function

Press the **FUNC** key+**NRC VOX** key, turn on or of VOX function, LCD displays VOX icon.

5.18 SSB Frequency Fine Tuning

When the radio is in the receiving state, push the channel switch to enter the SSB frequency fine adjustment function. Rotate the channel switch to adjust the USB/LSB receiving frequency. Rotate clockwise to increase the frequency, and counterclockwise to decrease the frequency.

6. MENU SETTING

6.1 Function Menu Setting

1. Long press the **FUNC** key to enter the MENU list;
2. Short press the **[▲]/[▼]** keys or rotate the volume knob to move the cursor, and press the **[PUSH]** key to enter the Functions menu;
3. Short press the **[▲]/[▼]** keys or rotate the volume knob to select the desired function option, and press the **[PUSH]** key to enter parameter settings;
4. Press the Back (EMG) button to save and return to the previous menu step by step.

NO.	LCD display	Setting details
1	Key Beep	1-5, OFF, Total 6 levels available. Default: 03.
2	CH/VOL SWAP	Channel/volume Knob setting VOL: Volume Adjustment CH: Channel adjustment Default: VOL
3	Microphone Gain	1-45, Total 45 levels of Microphone Gain available. Default: 33.
4	Microphone Type	Electret: Electret Microphone Dynamic: Dynamic Microphone Default: Electret
5	ECHO Volume	1-32, Total 32 levels available; Default: 28
6	ECHO Delay Time	1-32, Total 32 levels available; Default: 28
7	Time Out Timer	1-600s, OFF, Total of 10 minutes available; Default: 180s
8	SWR Warning	Set the SWR Protection function, 1.0-20.0 available OFF: disable the SWR Protection function Default: 20.0
9	Scan Type	Squelch: Squelch based scan function; Time: Time based scan function; Default: Squelch

NO.	LCD display	Setting details
10	Dimmer	1-5, 5 backlight dimmer levels available; Off: Turn off the backlight; Default: 5
11	DW Setting	Set the Dual Watch channel, mode and band:
12	EMG 1 Setting	Set Emergency Channel 1 and its mode.
13	EMG 2 Setting	Set Emergency Channel 2 and its mode.
14	ASQ Setting	01-09: Total of 9 Automatic Squelch levels; OFF: Turn off ASQ Default: 05.
15	VOX Sensitivity	01-09, Total of 9 VOX sensitivity levels. OFF: turns off the VOX function; Default: 03
16	VOX Delay Time	01-09, Total of 9 VOX Delay Time levels; Default: 03
17	RX NRC	01-05: Total of 5 levels for RX noise reduction; OFF: Turn off RX noise reduction; Default: OFF
18	TX NRC	01-05: Total of 5 levels for TX noise reduction; OFF: Turn off TX noise reduction; Default: OFF
19	SSB TX Audio	HI-4K: 4K audio response; LO-3K: 3K audio response; Default: HI-4K
20	CW Beep	01-63: Adjusts the CW Sidetone level (volume); OFF: CW Sidetone disabled; Default: 31
21	CW Freq	300Hz-3KHz: This menu is to select CW Sidetone frequency; The frequency step is 10Hz; Default: 1050Hz
22	CW RX Setting	USB: select USB for CW RX; LSB: select LSB for CW RX; Default: USB

NO.	LCD display	Setting details
23	CW Delay Time	10-1000MS: TX delay (CW break-in); OFF: No TX delay; Default: 500MS
24	CW Shift	ON: CW RX Shift ON (RX Shift = +/- "CW.FREQ"); OFF: CW RX Shift OFF; Default: OFF
25	S-Meter Response	SLOW: AGC SLOW response; FAST: AGC FAST response; Default: SLOW
26	Talkback	1-32, OFF, Total 33 levels available; Default: OFF (Disable Talkback function)
27	Voltage Protection	OFF: Disable the Voltage Protection function; ON: Enable the Voltage Protection function; Default: ON
28	TX DRC	OFF: Turn off Dynamic Range Compression function; ON: Turn on Dynamic Range Compression function; Default: ON
29	Clarifier	OFF: Disable clarifier adjustment; RX: Enable RX frequency adjustment; TX: Enable TX frequency adjustment RX+TX: Enable both RX and TX frequency adjustment Default: RX
30	Clarifier Freq Range	500Hz: adjustable range $\pm 500\text{Hz}$; 5KHz: adjustable range $\pm 5\text{KHz}$; Default: 500Hz
31	Factory Reset	MENU: Settings/Functions reset to defaults; ALL: Channels and Settings/Functions reset to defaults; Default: ALL

6.2 Public Menu Setting

1. Long press the **FUNC** key to enter the MENU selection list;
2. Short press the [**▲**]/[**▼**] keys or rotate the volume knob to move the cursor, and press the [PUSH] key to enter the PD Para menu;
3. Short press the [**▲**]/[**▼**] keys or rotate the volume knob to select the desired function option, and press the [PUSH] key to enter parameter settings;
4. Press the Back(EMG) button to save and return to the previous menu step by step.

NO.	LCD display	Functional Description
1	HI-CUT	OFF: Disable HI-CUT function; ON: Enable HI-CUT function; Default: OFF.
2	NB/ANL	OFF: Disable NB/ANL function; NB: Enable NB function; ANL: Enable ANL function; NB/ANL: Enable NB/ANL function; Default: OFF.
3	ECHO	OFF: Disable ECHO function; ON: Enable ECHO function; Default: OFF
4	Roger Beep	OFF- 5, Total 6 options. Default: OFF, (RB Disabled)
5	DTMF BOT	BOT: Press PTT to send DTMF encode; <i><u>Note: If the M1-M16 memory storage has no PTT ID's set, the DTMF function will be defaulted to OFF. DTMF groups can only be selected once they have been programmed.</u></i>
6	DTMF EOT	EOT: Release PTT to send DTMF encode; <i><u>Note: If the M1-M16 memory storage has no PTT ID's set, the DTMF function will be defaulted to OFF. DTMF groups can only be selected once they have been programmed.</u></i>
7	DTMF CALL	CALL: Hold PTT+CALL to send DTMF encode; <i><u>Note: If the M1-M16 memory storage has no PTT ID's set, the DTMF function will be defaulted to OFF. DTMF groups can only be selected once they have been programmed.</u></i>

6.3 Channel Menu Setting

1. Long press the **[FUNC]** key to enter the MENU list;
2. Short press the **[▲]/[▼]** keys or rotate the volume knob to move the cursor, and press the **[PUSH]** key to enter the CH Para menu;
3. Short press the **[▲]/[▼]** keys or rotate the volume knob to select the desired function option, and press the **[PUSH]** key to enter parameter settings;
4. Press the Back(EMG) button to save and return to the previous menu step by step.

NO.	LCD display	Functional Description
1	BUSY	OFF: Disable Busy Channel Lockout function; ON: Enable Busy Channel Lockout function; Default: OFF
2	RX CTCSS/DCS	CTCSS/DCS: RX setup OFF: Turn off CTCSS/DCS function; CTCSS: 67.0Hz~250.3Hz, Total 38 tones; DCS: D023N~D754N, Total 104 codes; Default: OFF
3	TX CTCSS/DCS	CTCSS/DCS: TX setup OFF: Turn off CTCSS/DCS function; CTCSS: 67.0Hz~250.3Hz, Total 38 tones; DCS: D023N~D754N, Total 104 codes; Default: OFF
4	RX&TX CTCSS/DCS	CTCSS/DCS: RX+TX setup OFF: Turn off CTCSS/DCS function; CTCSS: 67.0Hz~250.3Hz, Total 38 tones; DCS: D023N~D754N, Total 104 codes; Default: OFF
5	Add to Scan	Add: LCD displays "S", present channel is added to scan list. Skip: LCD does not display "S", present channel is not added to scan list. Default: Add
6	PUBLIC	OFF: Choose independent channel menu; ON: Choose public channel menu; Default: ON <i><u>Note: When OFF is selected, additional hidden public channel menu will appear. These are the same as shown in 'Section 6.2'.</u></i>

6.4 DTMF Menu Setting

1. Long press the **FUNC** key to enter the MENU list;
2. Short press the [**▲**]/[**▼**] keys or rotate the volume knob to move the cursor, and press the [PUSH] key to enter the DTMF Para menu;
3. Short press the [**▲**]/[**▼**] keys or rotate the volume knob to select the desired function option, and press the [PUSH] key to enter parameter settings;
4. Press the Back(EMG) button to save and return to the previous menu step by step.

NO.	LCD display	Functional Description
1	Send Time	DTMF transmit time, This product offers 50 levels ranging from 10ms~500ms for selection; Default: 100ms
2	First Digit Time	First digital delay time, This product offers 11 levels ranging from OFF, 100ms~1000ms for selection; Default: 200ms
3	First Digit Delay	Pre-carrier time, This product offers 25 levels ranging from 100ms~2500ms for selection; Default: 300ms
4	*and# Tone	* and # delay time; This product offers 4 levels ranging from OFF, 100ms~1000ms for selection; Default: OFF
5	D Code Assignment	D code setting time; This product offers 17 levels ranging from OFF, 1s~16s for selection; Default: OFF
6	DTMF Disp	ON: Turn off DTMF sending display OFF: Turn off DTMF sending display Default: ON
7	Autodial Memory	DTMF encode storage list; <u>Note: In the DTMF encode storage list (M1-M16), press PUSH to edit DTMF code. then turn channel knob to choose desired value:</u>

6.5 Microphone Menu Setting

1. Long press the **FUNC** key to enter the MENU list;
2. Short press the [**▲**]/[**▼**] keys or rotate the volume knob to move the cursor, and press the [PUSH] key to enter the KEY Para menu;
3. Short press the [**▲**]/[**▼**] keys or rotate the volume knob to select the desired function option, and press the [PUSH] key to enter parameter settings;
4. Press the Back(EMG) button to save and return to the previous menu step by step.

NO.	LCD display	Functional Description
1	MicrophoneType	TYPE1: The microphone is equipped with a standard RJ45 plug; TYPE2: The microphone is an optional 4-PIN plug microphone (requires a RJ45 to 4-PIN adaptor cable); TYPE3: The microphone is a multifunctional numeric keypad microphone Default: TYPE1
2	MicrophoneKey PF	Customize menu settings for the microphone, press the PUSH key to enter and select the desired function; Default: VOX function

6.6 Time Setting

1. Long press the **FUNC** key to enter the MENU list;
2. Short press the [**▲**]/[**▼**] keys or rotate the volume knob to move the cursor, and press the [PUSH] key to enter the TIME Para menu;
3. Short press the [**▲**]/[**▼**] keys or rotate the volume knob to select the desired function option, and press the [PUSH] key to enter parameter settings;
4. Press the Back (EMG) button to save and return to the previous menu step by step.

NO.	LCD display	Functional Description
1	Clock Setting	Set the time in hours, minutes, seconds, and rotate the channel switch to modify the values.
2	Date Setting	Set the year, month, and day of the date, rotate the channel switch to modify the value.
3	Clock Color	Time/date color display settings,WHITE, YELLOW, RED, GREEN, CYAN, Default: WHITE
4	Power OFF Display	CLOCK: When shutting down, turn on the time/date display OFF: When shutting down, display the shutdown time/date Default: CLOCK

6.7 Weather Channel Menu Setting (optional functions)

1. Long press the **FUNC** key to enter the MENU list;
2. Short press the [**▲**]/[**▼**] keys or rotate the volume knob to move the cursor, and press the [PUSH] key to enter the WX Para menu;
3. Short press the [**▲**]/[**▼**] keys or rotate the volume knob to select the desired function option, and press the [PUSH] key to enter parameter settings;
4. Press the Back(EMG) button to save and return to the previous menu step by step.

NO.	LCD display	Functional Description
1	WX Mode	OFF: Activate the weather channel; ON: Close the weather channel; Default: OFF
2	WX Alert	OFF: Enable weather channel alarm function; ON: Disable the weather channel alarm function; Default: OFF
3	Freq Step	Adjust the default step size in VFO mode. Options: 100Hz, 1KHz, 5KHz, 10KHz, 100KHz, 1MHz; Default: 1KHz.
4	Band Width	25K: Select 25K communication bandwidth 12.5K: Select 12.5K communication bandwidth Default: 25KHz.
5	SQ Level	OFF-09: Total of 10 Automatic Squelch levels; Default: 03.
6	Add to Scan	Add: LCD displays "S", present channel is added to scan list. Skip: LCD does not display "S", present channel is not added to scan list. Default: Add

6.8 Wireless BT Menu Setting (optional functions)

1. Long press the **FUNC** key to enter the MENU list;
2. Short press the **[▲]/[▼]** keys or rotate the volume knob to move the cursor, and press the **[PUSH]** key to enter the BT Para menu;
3. Short press the **[▲]/[▼]** keys or rotate the volume knob to select the desired function option, and press the **[PUSH]** key to enter parameter settings;
4. Press the Back(EMG) button to save and return to the previous menu step by step.

NO.	LCD display	Functional Description
1	BT State	OFF: Turn off BT wireless function; ON: Enable BT wireless function; Default: OFF
2	BT Pair	Seek BT: Search for BT wireless Available BT: Search List Paired List: Paired List Disconnect: Exit pairing
3	BT Name	BT wireless name query, set the desired BT wireless name through PC software or a multifunctional microphone with keyboard or handheld microphone.
4	BT Paired Name	Display the setting name of the current connection.
5	BT HoldTime	BT wireless hold time setting, this product has OFF, 1S~120S, and infinity options to choose from
6	BT DelayTime	BT wireless delay time setting, this product has 30ms, 1s~5.5s to choose from.
7	BT + int Spk	Local speaker switch settings in BT wireless mode OFF: Turn off the local speaker; ON: Turn on the local speaker; Default: OFF
8	BT Mic Gain	BT wireless MIC gain adjustment, this product has 1-5 levels to choose from
9	BT Spk Gain	BT wireless earphone gain adjustment, this product has 1-5 levels to choose from
10	BT Pin Code	BT wireless pairing code query, press the PUSH key to enter the BT wireless pairing code input status and enter the desired pairing code

11	BT PTT Pair	BT wireless PTT pairing menu, this product supports BP-02 BT wireless PTT Connect PTT: BT wireless PTT pairing Disconnect PTT: Disconnect BT wireless PTT pairing
12	BT PTT Hold	BT wireless PTT hold settings OFF: Turn off BT wireless PTT hold; ON: Enable BT wireless PTT hold; Default: OFF
13	BT PTT Sleep	BT wireless PTT sleep setting, choose from infinity and 1min-4min options
14	BT Bat Volt	BT wireless PTT battery level query, displaying the current BT wireless PTT battery level

6.9 Radio Version Check

1. Long press the **FUNC** key to enter the MENU list;
2. Short press the [**▲**]/[**▼**] keys or rotate the volume knob to move the cursor, and press the [PUSH] key to enter the Device Info menu;
3. Short press the [**▲**]/[**▼**] keys or rotate the volume knob to select the desired function option for inquiry;
4. Press the Back(EMG) button to save and return to the previous menu step by step.

NO.	LCD display	Functional Description
1	LCD Soft Ver	Display software version number query
2	RF Soft Ver	Motherboard software version number query
3	Work Mode	Current working mode query
4	Hardware Ver	Hardware version number query
5	Radio Data Ver	Data date query
6	Last Pro Date	Last programming date query
7	BT Soft Ver	BT wireless version number query

7. SPECIFICATIONS

GENERAL		
Modulation Mode	AM/FM/USB/LSB/CW/PA	
Frequency Range	26.965-27.405MHz	
Frequency Tolerance	±5.0ppm	
Input Voltage	12/24V	
Dimensions(in mm)	124(W) x 163(D) x 39(H)	
Weight	0.668kg	
Frequency Control	PLL Synthesizer	
Operating Temperature Range	-20° C TO + 55° C	
Current Drain	Transmit	8.0A MAX
	Receive	Squelched 0.5A
	VOL Max	0.8A
Antenna Connector	UHF,SO-239	
TRANSMITTER		
Power Output	AM/FM/CW:4W;SSB:12W	
Transmission interference	inferior to 4nW(-54dBm)	
Frequency Response	450-2500Hz	
Modulated signal distortion	inferior to 5%	
Output Impedance	50 ohms	
RECEIVER		
Sensitivity	AM: 1.0μV for 10dB(S+N)/N at greater than 1/2watt of audio output. FM: 1.0μV for 20dB (S+N)/N at greater than 1/2 watt of audio output. SSB: 0.25μV for 10dB(S+N)/N at greater than 1/2-watt of audio output.	
IF Frequencies	AM/FM: 10.695MHz 1st IF, 455 KHz 2nd IF SSB: 10.695MHz	
RF Gain Control	48dB adjustable	
Automatic Gain Control(AGC)	Less than 10dB change in audio output for inputs from 10μV to 100,000μV	
Squelch	Adjustable; threshold less than 0.25 μV. Automatic Squelch Control (only AM/FM) 0.5μV	
ANL	Switchable	
Noise Blanker	RF type, effective on AM/FM and SSB	
Audio Output Power	3 watts into 8 ohms	
Frequency Response	300-3000Hz	
Built-in Speaker	ohms, round	
External Speaker(Not Supplied)	8 ohms, disables internal speaker when connected	