

YUPITERU

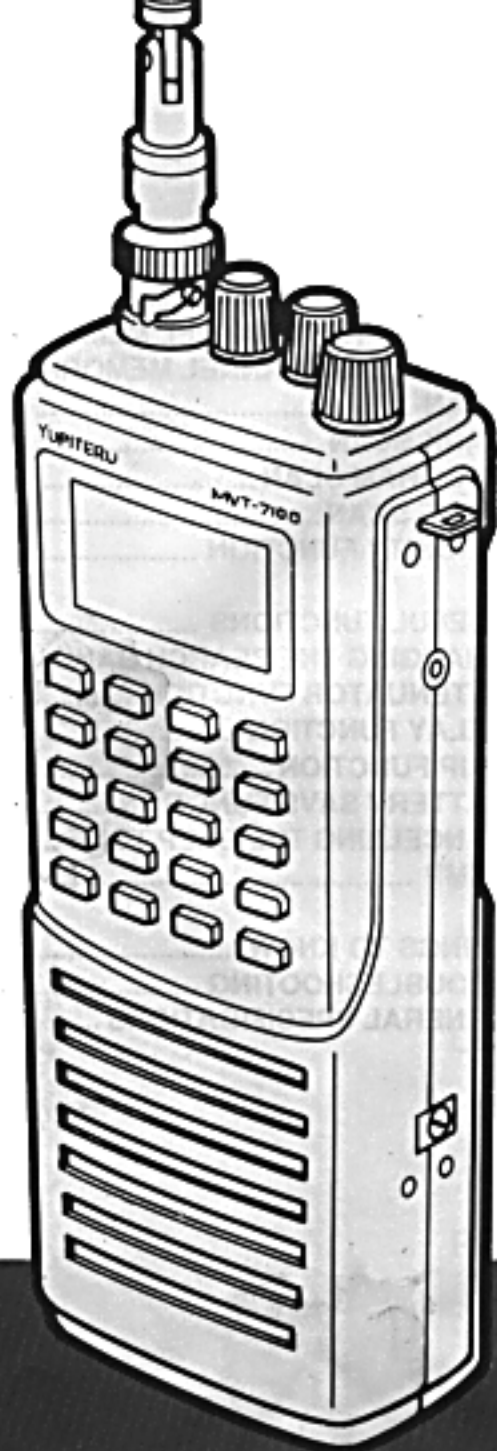

MULTIBAND RECEIVER **MVT-7100**

Owner's Manual

TABLE OF CONTENTS

CHAPTER 1 INTRODUCTION	3	CHAPTER 4 MEMORY AND SCAN	39
MAIN FEATURES	4	SETTING THE CHANNEL MEMORIES	40
ACCESSORIES	5	RECALLING CHANNEL MEMORIES	44
IMPORTANT PRECAUTIONS	6	SCAN	50
CONTROLS, DISPLAYS AND FUNCTIONS	8	BANK SCAN	52
POWER SUPPLY	15	PROGRAM SCAN	54
CHAPTER 2 BASIC OPERATIONS	17	MODE SCAN	58
BEFORE KEY OPERATION	18	PRIORITY FUNCTION	60
SELECTING FREQUENCIES		CHAPTER 5 USEFUL FUNCTIONS	63
THROUGH DIRECT INPUT	20	CHANGING THE SEARCH BAND	64
SELECTING FREQUENCIES		ATTENUATOR FUNCTION	66
WITH THE TUNING DIAL	24	DELAY FUNCTION	67
CORRECTING AND SHIFTING OF		SKIP FUNCTION	67
THE INPUT FREQUENCY	26	BATTERY SAVE FUNCTION	68
MONITOR FUNCTION	30	CANCELLING THE BEEP TONE	70
KEY LOCK FUNCTION	30	LAMP	70
CHAPTER 3 SEARCH	31	CHAPTER 6 THINGS TO KNOW	71
SEARCH FUNCTIONS	32	TROUBLESHOOTING	72
SEARCH PASS MEMORY FUNCTION	34	GENERAL SPECIFICATIONS	74

CHAPTER 1

INTRODUCTION

MAIN FEATURES	4
ACCESSORIES	5
IMPORTANT PRECAUTIONS	6
CONTROLS, DISPLAYS AND FUNCTIONS	8
• MAIN UNIT	8
• DISPLAY	10
• KEYBOARD	12
POWER SUPPLY	15
• CHARGING THE BATTERIES	15
• BATTERY	16

MAIN FEATURES

■ Superior Microprocessor Technology

Whether you are an expert or just a beginner, you can enjoy all of the superior functions offered by microprocessor technology.

■ Wide Range of Frequencies in a Variety of Modes (WFM/NFM/AM/LSB/USB)

You can select a wide range of frequencies ranging from 530 kHz to 1650 MHz in various receiving modes: Wide FM, Narrow FM, AM, LSB and USB.

■ Numerous Frequency Steps

Twelve frequency steps can be selected. Suitable for a broad range of frequencies.

■ 10-band Search Function

This receiver can search for frequencies in over 10 bands including FM and Aeronautical communication (AIR BAND). Moreover, within these bands, you can change the frequencies.

■ 1000-channel Memories

You can store up to 1000 of your favorite channels in memory. This receiver is also equipped with various Channel Memory Scan functions, Bank Scan, Mode Scan, Program Scan and Priority, which increase the efficiency of receiving frequencies.

■ Power Supply Options

This receiver can be powered by either car or ordinary batteries.

■ Various Receiving and Control Functions

- Tuning Dial
- Pass Memory Function
- Key Illumination
- Battery Save Function
- Beep (key touch sound) ON/OFF
- Monitor Switch
- Key Lock Switch

ACCESSORIES

Telescopic Antenna (1)
Car Connector (1)
Hand Strap (1)
Belt Clip (1)

Belt Clip Screws (2)
Earphone (1)
Owner's Manual (1)

Car Connector

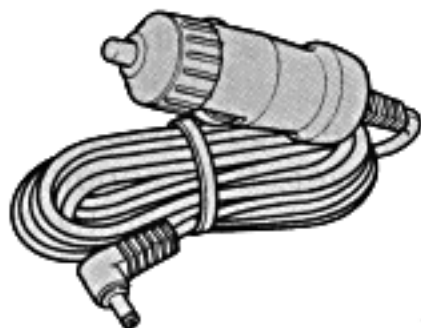

Hand Strap



Attach the Hand Strap to the receiver.

Belt Clip

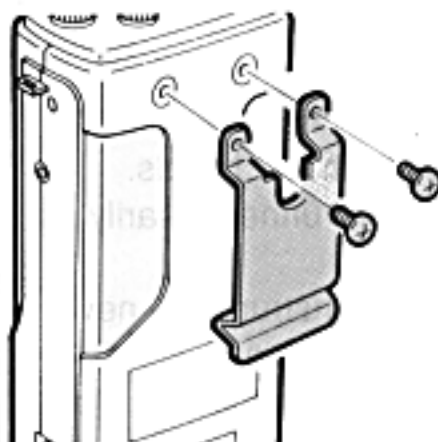

Attach the Belt Clip to the back of the receiver.

IMPORTANT PRECAUTIONS

OPERATING ENVIRONMENT

- Do not place this receiver near heating equipment or in direct sunlight. Do not place it in a car exposed to direct sunlight or in places where the temperature is very high, such as near the heater on the dashboard.
- Do not place this receiver in humid or poorly ventilated areas.
- Do not place this receiver in dusty or smoky places.
- Do not place this receiver in extremely cold places.
- Using the receiver near a transceiver, TV, radio, personal computer, or digital equipment or in a car may cause reception noise.

SAFETY

- Never remove the electric plug with wet hands.
- Never bend the power supply cord unnecessarily or place any heavy objects on it.
- Since this receiver is a precision instrument, never disassemble it or insert any foreign objects into it.
- Never use a car connector other than the specified one.
- If there is a thunder, promptly retract the receiver's antenna.

HANDLING

- Do not apply any shock to the receiver such as dropping or hitting it.
- If the receiver becomes dirty, wipe it with a soft cloth. Never use cleaning liquids, such as benzene, thinner or chemical detergents and material such as polyester which can easily generate static electricity.
- Some internal parts may generate spurious noise which will block out signals. Some of the frequencies may also create noise.

ANTENNA

- Signal reception will vary depending on the location and antenna direction.
- Other types of antennas can be used in place of the telescopic antenna. However, they should be suitable for the frequency range received by this unit.
- The antenna terminal is the BNC type, and the impedance is 50 ohm.
- External booster antennas are not recommended. Strong signals may cause intermodulation.

RESET SWITCH

Press the reset switch with a ball point pen or similar object to initialize the receiver under the following conditions.

- You are going to use the receiver for the first time after purchase.
- You wish to completely erase all of the data in memory.
- The display shows erroneous information.
- The batteries need to be replaced.

If you have any questions regarding this product, please contact the store where it was purchased.

CONTROLS, DISPLAYS AND FUNCTIONS

MAIN UNIT

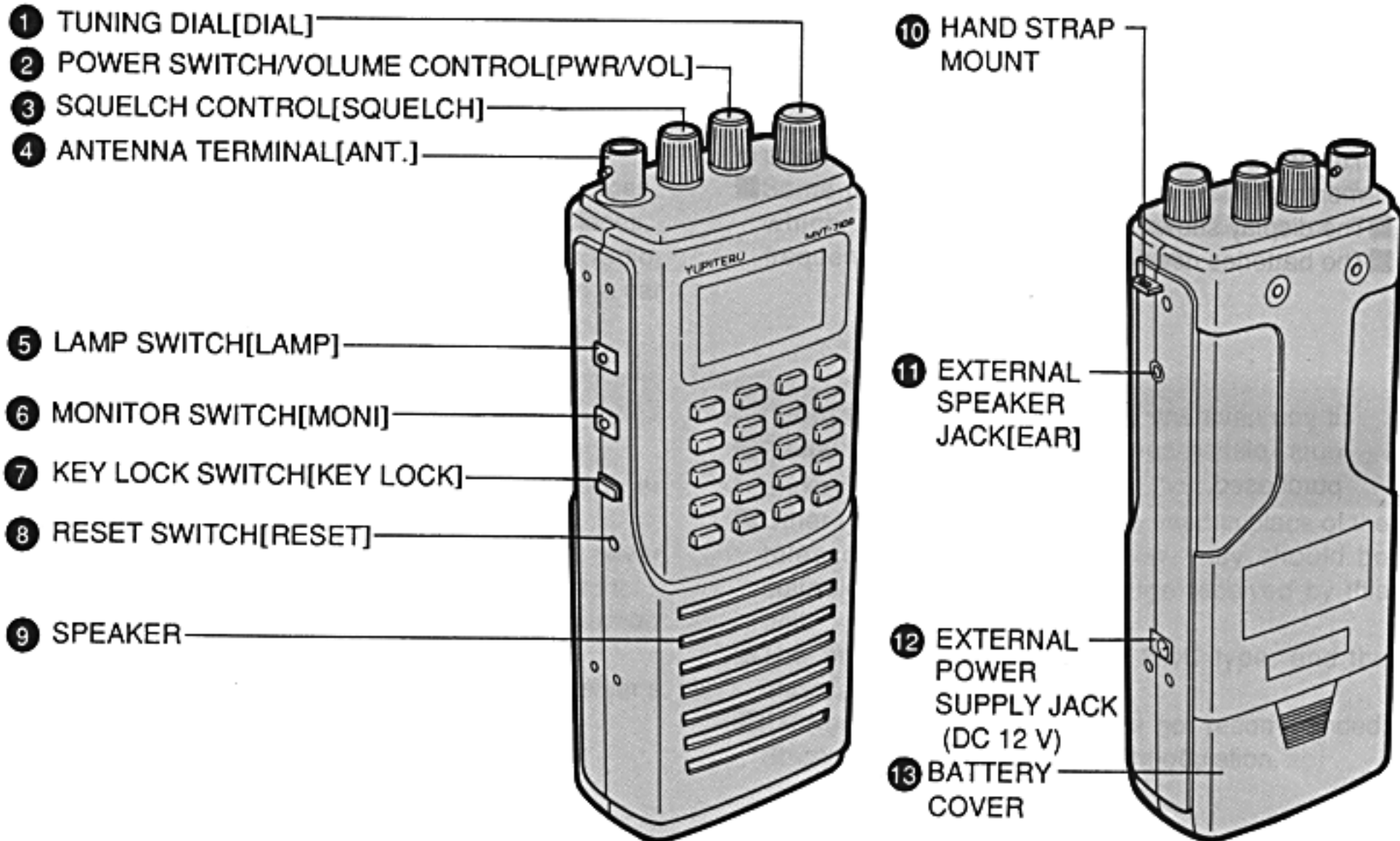

① TUNING DIAL(DIAL)

Use this dial to select the frequency, the channel to be recalled from memory, the receive mode, and frequency step.

② POWER SWITCH/VOLUME CONTROL(PWR/VOL)

Rotate this knob clockwise to turn on the receiver and to increase the volume.

③ SQUELCH CONTROL(SQUELCH)

Rotate this knob clockwise to reduce "white" noise and to improve the condition of the receiving signals.

④ ANTENNA TERMINAL(ANT.)

Connect an external antenna to this terminal.

⑤ LAMP SWITCH(LAMP)

Use this switch to illuminate the display.

The display will remain lit as long as the button is pressed.

⑥ MONITOR SWITCH(MONI)

Press this switch if there is a break in the reception signal of the communications station, or if the signal has become weak.

⑦ KEY LOCK SWITCH(KEY LOCK)

Set this switch to "ON" to lock the keys and TUNING dial.

This feature is particularly useful when carrying the receiver.

⑧ RESET SWITCH(RESET)

Press this switch with a ball point pen or similar object to initialize the microprocessor.

⑨ SPEAKER**⑩ HAND STRAP MOUNT****⑪ EXTERNAL SPEAKER JACK(EAR)**

Connect an external speaker or earphone to this jack. When the jack is connected, the internal speaker will be disconnected.

⑫ EXTERNAL POWER SUPPLY JACK (DC 12 V)

Connect the car connector or an AC adaptor to this jack when you wish to operate the receiver from an external power source (AC outlet or car battery) or charge the Ni-Cd batteries.

⑬ BATTERY COVER

CONTROLS, DISPLAYS AND FUNCTIONS

DISPLAY



1 FUNCTION DISPLAY

Appears when the FUNCTION key is pressed.

2 FREQUENCY STEP DISPLAY

The frequency step selected is displayed. Blinks while the frequency step is being changed and immediately after it is changed. Also, "P" is displayed for the third digit of the search pass frequency.

3 MEMORY CHANNEL DISPLAY

Displays the channel number. "P" is displayed for the first digit of the priority frequency.

4 BAND/BANK NUMBER DISPLAY

Displays the search mode's specified band, the scan mode's bank number, and the number of programs in memory.

5 OPERATION MODE DISPLAY

Indicates the operation mode (search mode, scan mode, etc.). Also, for memory channels registered in a program, "PGM" will be displayed

6 RECEIVE MODE (BAND) DISPLAY

Indicates the receive mode selected. Blinks during mode scan.

7 kHz (KiloHertz) DECIMAL POINT

When a frequency is displayed, the three digits left of this decimal point indicate the kHz, and the digits to the right of the decimal point is the Hz (hertz).

8 MHz (MegaHertz) DECIMAL POINT

When a frequency is displayed, the digits left of this decimal point indicate the MHz.

9 FREQUENCY DISPLAY

Displays the reception frequency or numeric value being entered. It also displays messages such as Error (entry disabled), ALL PASS (scan disabled), and FULL (search pass storage disabled).

The "5" on the extreme right will be displayed depending on the frequency step or the frequency entered.

10 SIGNAL METER DISPLAY

Indicates the strength of the signal being received.

11 BUSY INDICATOR

Displayed when the MONITOR switch is pressed, when a signal is audible, or when the squelch is on.

12 LOW BATTERY INDICATOR

Blinks when the batteries are low and need to be recharged or replaced.

13 MODE INDICATOR

Indicates the mode that was set with the FUNCTION key.

CONTROLS, DISPLAYS AND FUNCTIONS

KEYBOARD

1 ATT	2 DELAY	3 SKIP	SRCH PRI
4 SAVE	5 BEEP	6 PGM	SCAN MW
7 M▶ VFO	8 M-SCAN	9 P-SCAN	STEP MODE
Δ MHz	0 SPR	·	MR BW
▽	C/AC PASS	ENT	FUNC

DIRECT INPUT KEYS

NUMBER KEYS (1 through 9, 0)

These keys are used to enter the frequency, specify the channel memory number, etc. They are also used to specify the search band and scan bank.

CLEAR/ALL CLEAR KEY (C/AC)

If an incorrect frequency or channel memory is entered, press this key to correct the entry. Press this key once to be able to enter the correct frequencies or channel memories. Press this key twice to clear all of the input data.

ENTER KEY (ENT)

Press this key to set the frequencies entered in the microprocessor's memory.

SEARCH KEY (SRCH)

Press this key to search automatically for desired frequencies. Press this key once to begin the search and press it again to stop search mode.

SCAN KEY (SCAN)

Press this key once to scan the channels stored in memory. Press this key again to stop the memory scan.

STEP KEY (STEP)

This is used to set the frequency step. Select the desired step with the UP key, DOWN key, or TUNING dial.

UP KEY (△)

- After entering the frequency, etc., press this key once to change the displayed frequency by one step. When the key is pressed for 1 second or longer, the frequency step will change continuously.
- When the key is pressed once after memory recall or the search pass frequency recall, the next memory channel or search pass frequency will be displayed. When the key is pressed for 1 second or longer, the display will change continuously.
- The key can be used to specify the direction of a search or scan operation.
- When the key is pressed while the frequency step or receive mode is being set, the desired frequency step or receive mode can be selected.
- While the frequency or memory channel is being set, the digit to be corrected can be selected by pressing the CLEAR/ALL CLEAR key once and then the UP key.

DOWN KEY (▽)

The DOWN key works in the same way as the UP key, but in the opposite direction. (i.e. in descending order)

MEMORY READ KEY (MR)

Press this key to recall channels stored in the memory.

FUNCTION KEY (FUNC)

Use this key to execute the extended functions of the same colored. key.

CONTROLS, DISPLAYS AND FUNCTIONS

EXTENDED KEY FUNCTIONS

(Key functions are extended when the following keys are pressed after pressing the FUNCTION key.)

ATTENUATOR KEY (ATT) "1" key

Sets or cancels the attenuator.

DELAY KEY (DELAY) "2" key

Sets or cancels the delay function.

SKIP KEY (SKIP) "3" key

Sets or cancels the skip function.

PRIORITY KEY (PRI) "SRCH" key

Sets or cancels the priority function.

SAVE KEY (SAVE) "4" key

Sets or cancels the save function.

BEEP KEY (BEEP) "5" key

Sets or cancels the key-touch beeping.

PROGRAM KEY (PGM) "6" key

Used for registering or canceling channels subject to program scanning.

MEMORY WRITE KEY (MW) "SCAN" key

Used for storing channels in memory and erasing the memory for a specified channel.

MEMORY VFO KEY (M ▶ VFO) "7" key

Switches the channel's memory to manual mode.

MODE SCAN KEY (M-SCAN) "8" key

Starts or cancels the mode scan.

PROGRAM SCAN KEY (P-SCAN) "9" key

Starts or cancels the program scan.

RECEIVE MODE KEY (MODE) "STEP" key

Changes the receive mode.

MHz key (MHz) "Δ" key

In the manual mode, this key can change the MHz frequency.

SEARCH PASS READ KEY (SPR) "0" key

Recalls the frequency registered for search pass or returns to the frequency before the recall.

BAND WRITE KEY (BW) "MR" key

Writes the desired search bands in memory.

PASS KEY (PASS) "C/AC" key

During a scan, the specified channels stored in memory are skipped. The key also cancels the search pass in memory.

POWER SUPPLY

CHARGING THE BATTERIES

- This receiver operates on Ni-Cd batteries. It can also operate on a car battery through the car connector or an AC adaptor.
- This receiver is supplied with four KR-AA size Ni-Cd batteries.
- Charge the batteries with the attached car connector or with an AC adaptor (output: 12V 200mA, connector: TYPE III).
- The batteries should be charged before the receiver is used for the first time. When "BATT" appears on the display, the batteries should be recharged immediately.

1

Be sure to turn the "PWR/VOL" off.



2

Connect the car connector or an AC adaptor to the external power supply jack.

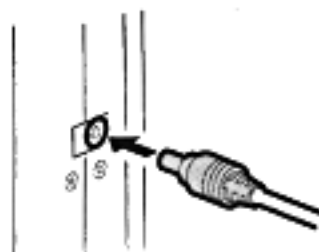

3

Charge the batteries for a maximum of 15 hours.

◆ IMPORTANT

- Only use the car connector in a car using a 12V battery.
- If "PWR/VOL" is on, you cannot recharge the batteries.
- Do not overcharge the batteries as this will shorten the life of your receiver and may cause a fire.

POWER SUPPLY

BATTERY

◆ IMPORTANT

- Alkaline and Manganese batteries can be used with this receiver. However, they cannot be recharged, as doing so might damage the receiver.
- As it is rather difficult to recharge fully discharged batteries, charge the batteries before they are completely discharged.
- Do not mix batteries with different kinds of batteries or used batteries.
- PWR/VOL should be off when replacing the batteries.
- Remove the batteries if you are not going to use the receiver for a long time.

■ Installing batteries

1

Open the battery cover.

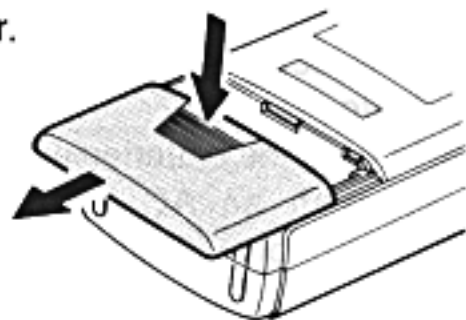

2

Insert the four batteries into the battery case, making sure that the (+) and (-) terminals match the (+) and (-) signs indicated inside the case.

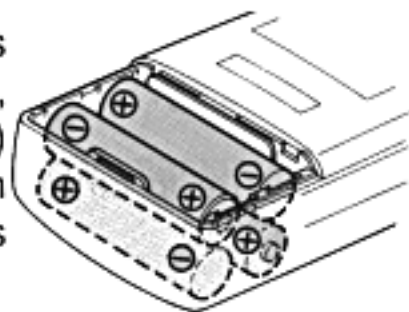

3

Close the battery cover.



CHAPTER 2

BASIC OPERATIONS

BEFORE KEY OPERATION	18
• ENTERING MANUAL MODE	19
SELECTING FREQUENCIES THROUGH DIRECT INPUT	20
• SETTING THE RECEIVE MODE	20
• SELECTING STEP FREQUENCIES	21
• ENTERING FREQUENCIES	22
SELECTING FREQUENCIES WITH THE TUNING DIAL	24
• ONE STEP FREQUENCY AND QUICK STEP FREQUENCY ...	24
CORRECTING AND SHIFTING OF THE INPUT FREQUENCY	26
• CORRECTING OF THE INPUT FREQUENCY	26
• SHIFTING FREQUENCIES IN MHz UNITS	28
MONITOR FUNCTION	30
KEY LOCK FUNCTION	30

BEFORE KEY OPERATION

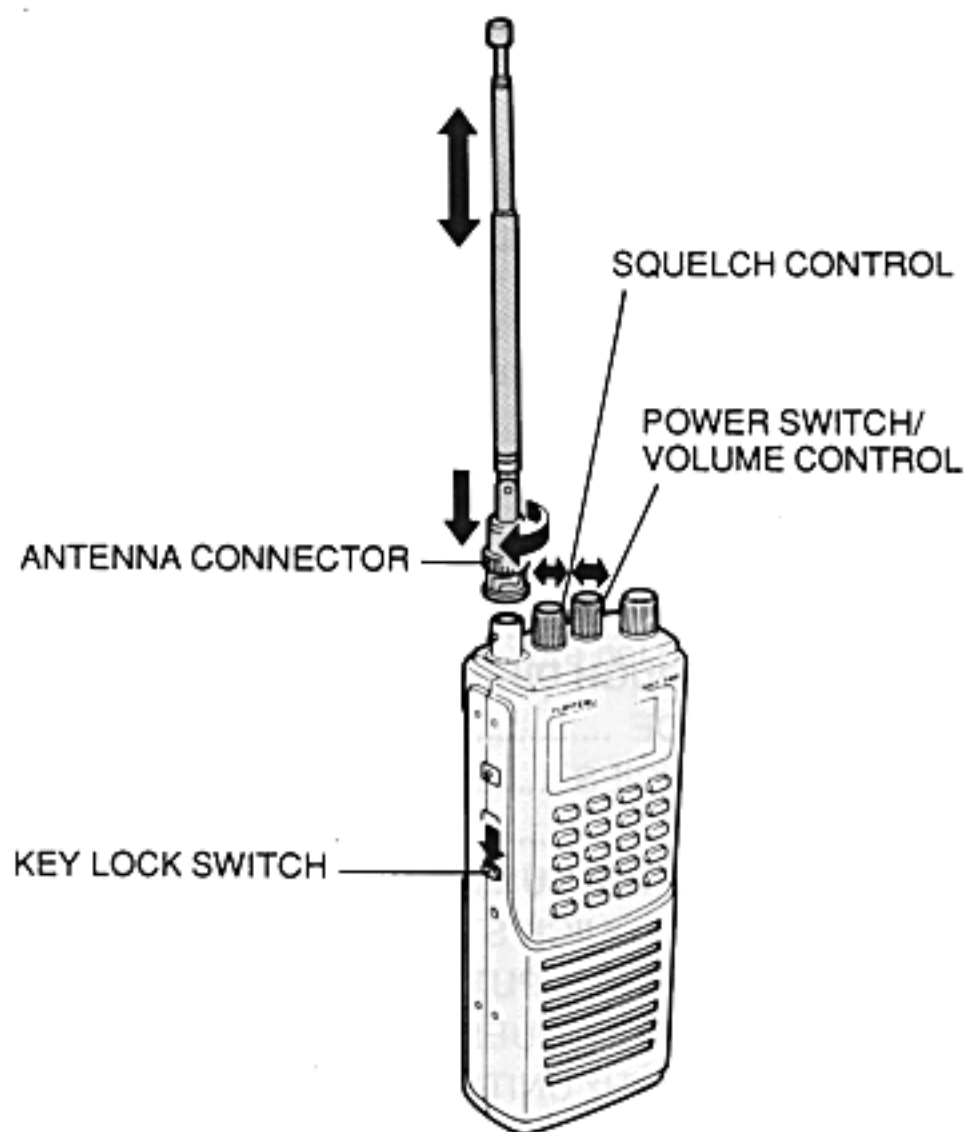

- 1** Attach the telescopic antenna (or any other suitable antenna) to the antenna jack and turn the antenna connector 45 degrees clockwise to lock it.
- 2** Turn off the KEY LOCK switch.
- 3** Rotate the SQUELCH control counter-clockwise until it stops.
- 4** Rotate the PWR/VOL control clockwise to turn on the receiver. The display will light to indicate that the receiver is on.
- 5** Continue to rotate the PWR/VOL control clockwise until the desired volume level is reached.
- 6** If you hear radio interference over the speaker, turn the SQUELCH control clockwise until you can no longer hear the interference. When you hear a signal over the speaker, turn the SQUELCH control back to the center.

- After pressing the RESET switch, the frequency 144.000.0 will appear on the display. This is the initialized condition of the receiver.
- When there are no signals and radio interference is removed, the busy will disappear.

◆ IMPORTANT

- If "BATT" is displayed when turning on the receiver, recharge or replace the batteries.
- Set the SQUELCH control according to the strength of the received signal. A weak signal cannot be received if the SQUELCH control is fully rotated clockwise. More radio interference will be received if the control is fully rotated counter-clockwise.
- When adjusting the SQUELCH control, do not press the MONITOR switch.

ENTERING MANUAL MODE

- When SEARCH, or SCAN, or P, or Channel Number is not shown on the display, the receiving mode is manual mode.



To enter Manual Mode

- **When SEARCH is displayed:**
Press the SEARCH Key. SRCH
PRI
- **When SCAN or PGM-SCAN is displayed:**
Press the MEMORY READ key twice. MR ×2.
BW
- **When the Channel Number is displayed:**
Press the MEMORY READ key. MR
BW
- **When "P" is blinking on the display:** C/AC
Press the CLEAR/ALL CLEAR key. PASS

SELECTING FREQUENCIES THROUGH DIRECT INPUT

SETTING THE RECEIVE MODE

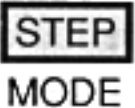
- You can select the receive mode while in manual or search modes. (See pages 32 & 33)
- Reception modes WFM (wide FM), FM (narrow FM), AM, LSB, and USB can be selected.

- Press the FUNCTION key. 
- Press the MODE key. 
- Use the TUNING dial, UP key, or DOWN key to select the desired receive mode. 
- Press the ENTER key to complete this operation. 

- If the receiving mode is not select correctly, sometimes no sound can be heard or it will become hard to hear.
- When the receive mode is changed, the last frequency step that was selected in that mode will be displayed. Also, if the reception frequency does not match the frequency step, it will be changed to match the frequency step.

[Example] Changing from the FM mode to the WFM mode

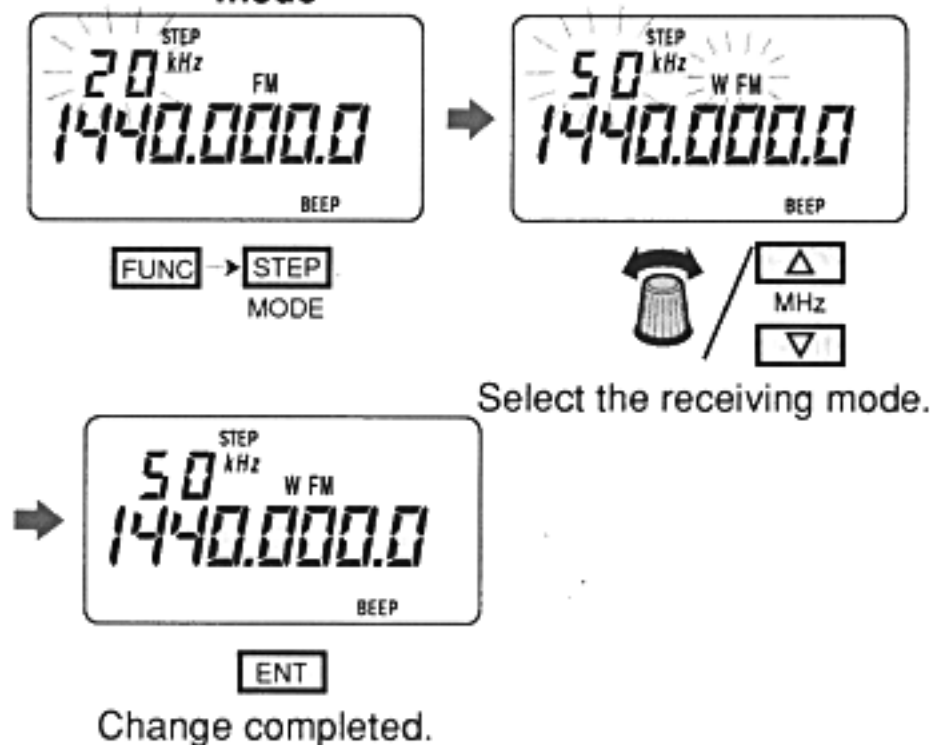

SELECTING STEP FREQUENCIES

- You can select the frequency steps when in the manual mode or the search mode. (See pages 32 & 33)
- The receiver has the following frequency steps: 50 Hz, 100 Hz, 1 kHz, 5 kHz, 6.25 kHz, 9 kHz, 10 kHz, 12.5 kHz, 20 kHz, 25 kHz, 50 kHz, 100 kHz.

1 Press the STEP key.



2 Use the TUNING dial, UP key, or DOWN key to select the desired frequency step.



3 Press the ENTER key.



- The step frequency display blinks until the setting is completed.
- If you attempt to enter a frequency which is not within the step frequency range, the nearest step frequency will be entered instead.
- To receive the LSB mode or USB mode, set the frequency step to 100 Hz or 50 Hz.
- The 50 Hz and 100 Hz steps can be selected only when the LSB or USB mode has been set.
- When the WFM mode is set, only the 50 kHz or 100 kHz step can be selected.

SELECTING FREQUENCIES THROUGH DIRECT INPUT

ENTERING FREQUENCIES

- For medium wave frequencies 100 kHz and higher, press the 0 key and decimal point key, then enter the frequency.
- When the same frequency is to be entered for MHz, press the decimal point key, then press the NUMBER keys to enter the kHz digits first. (See page 11)

1 Enter the desired frequencies using the NUMBER keys starting from the highest digit. During input, the displayed frequency will flash.

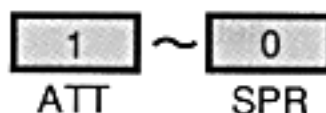

2 After entering the desired frequency, press the ENTER key. During input, the displayed frequency will flash. After pressing the ENTER key, the frequency will be displayed and entered.



- If you enter a frequency which is outside of the receiving range, an "error" indicator will appear for one second and the display will return to the previously entered frequency.
- During frequency input, if you wait more than 10 seconds before pressing the ENTER key, the display will return to the previously entered frequency. After entering the frequency, be sure to press the ENTER key within 10 seconds.
- If you enter a frequency which is not within the step frequency range, the nearest step frequency will be entered instead.
[Example] When the frequency step is 100 kHz.
142.050.0 → 142.000.0
- Adjust the antenna length to obtain the best reception. For low frequencies, extend the antenna more. For high frequencies, shorten the antenna. This will make tuning easier.

[Example] Receiving a 81.3 MHz FM station at the 100 kHz step. (First see page 20 to set the WFM mode.)



Current Display



STEP

MODE

Press the STEP key.



▲

MHz

▼

Selecting the frequency step.



ENT

Press the ENTER key.



8 **1** **.** **3**
M-SCAN ATT SKIP

Input the frequency.



ENT

Input completed.

SELECTING FREQUENCIES WITH THE TUNING DIAL

■ When you turn the TUNING dial in the manual mode, the frequencies will jump to the next frequency according to the step frequency on the display.

1 Set the receiver to the manual mode.
(See page 19)

2 Set the receive mode.
(See page 20)

3 Select the step frequency.
(See page 21)

4 Turn the TUNING dial clockwise to increase the frequency according to the step displayed.

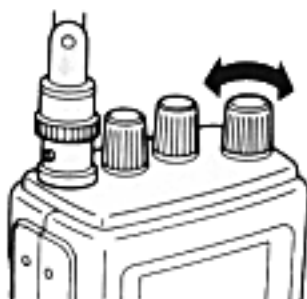

ONE STEP FREQUENCY AND QUICK STEP FREQUENCY

■ When in the manual mode, use the TUNING dial, UP key, or DOWN key to increment or decrement the frequency step selected by the reception frequency. Also, when the UP or DOWN key is pressed for 1 second or longer, the reception frequency range will be incremented or decremented quickly.

[Example] Incrementing and decrementing the frequency with the TUNING dial and keys.

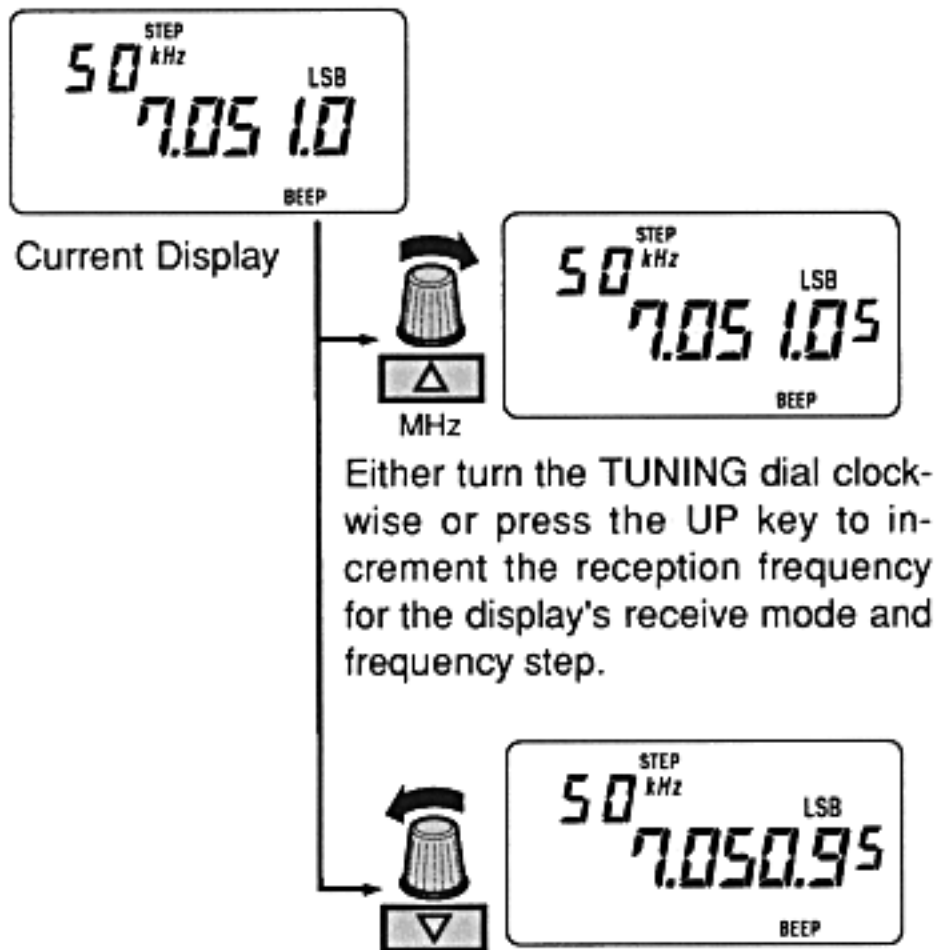

- All transmitted signals have a band width, which is called "occupied frequency band width". Signals may be received if they are within the band width, but may not always be received at the strongest point.
- If the step frequency interval is too large, you may not catch the desired frequency. Therefore, set the step frequency at smaller intervals. While looking at the SIGNAL METER, turn the TUNING dial until the station frequency shows the strongest signal.

Strong Signal



Weak Signal



- When receiving the LSB mode or USB mode, select the 50 Hz and 100 Hz steps. Use the TUNING dial, UP key, or DOWN key to adjust the frequency for optimum reception.

Either turn the TUNING dial counterclockwise or press the DOWN key to decrement the reception frequency for the display's receive mode and frequency step.

CORRECTING AND SHIFTING OF THE INPUT FREQUENCY

CORRECTING OF THE INPUT FREQUENCY

When an incorrect frequency has been entered, press the ENTER key and store again from the beginning or press the CLEAR/ALL CLEAR key once, and correct the numerical value.

1 Press the CLEAR/ALL CLEAR key once.

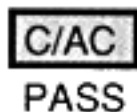

2 Press the UP key and specify the digit to be corrected.



3 Enter the correct numerical value using either TUNING dial or the NUMBER keys.



4 When you press the ENTER key, the correction is completed.

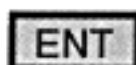

5 • To enter another frequency, enter the numerals.

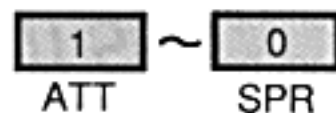

• After entering all the desired frequencies, press the ENTER key.



IMPORTANT

- After the ENTER key is pressed, or the CLEAR/ALL CLEAR key is pressed twice, the frequency cannot be corrected.

[Example] When you want to enter the intended 128.8 MHz but 138 was input by mistake.

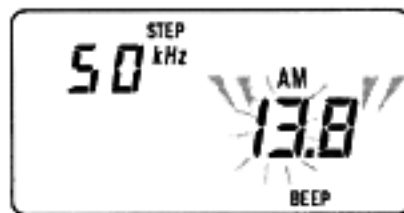
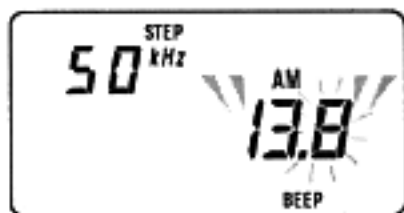

C/AC
PASS

When you press the CLEAR/ALL CLEAR key once, the maximum digit will start blinking very fast.

Δ
MHz

With the UP key specify the digit you wish to correct.

2
DELAY

Enter the correct numerical value.

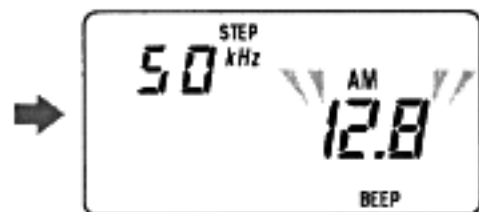

ENT

Press the ENTER key.



. **8** → **ENT**
M-SCAN

Enter the remaining numerals and press the ENTER key.

CORRECTING AND SHIFTING OF THE INPUT FREQUENCY

SHIFTING FREQUENCIES IN MHz UNITS

■ After pressing the FUNCTION key and the MHz key in manual mode, you can enter the frequency in the MHz position using either the NUMBER keys or the TUNING dial.

1 Set the receiver to the manual mode.
(See page 19)

2 Press the FUNCTION key. 

3 Press the MHz key. 
MHz

4 Press the UP key to select the digit to be changed.



- Press the DOWN key to shift the flashing digit to the 1 MHz position.

5 Enter the shift value you wish by using either the TUNING dial or the NUMBER keys.

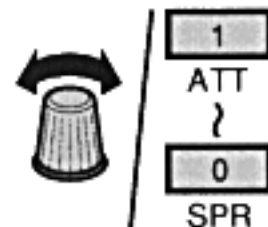

6 Press the ENTER key to complete this operation.



[Example] The frequency 144.0 MHz is shown on the display and you wish to shift to the 10 MHz position to enter a new digit, 194.0 MHz.

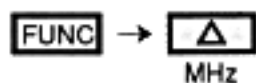

Press the FUNCTION key and press the MHz key.



Press the UP key to move to the 10 MHz position.



Use the TUNING dial or numeric keys to change the value.



Press the ENTER key.

MONITOR FUNCTION

■ If the reception signal from the transmitting station is weak or interrupted, press the MONITOR switch to make the weak signal more audible.

1 While pressing the MONITOR switch, the weak signal can be picked up and heard more easily.



◆ IMPORTANT

Do not press MONITOR switch while adjusting the squelch.

KEY LOCK FUNCTION

■ This disables the TUNING dial and keys. It is useful when the receiver is carried around.

1 Turn on the KEY LOCK switch on the side of the receiver. This disables the TUNING dial and keys.

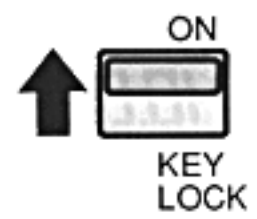

CHAPTER 3

SEARCH

SEARCH FUNCTIONS	32
• BAND SEARCH	32
• CONTINUOUS SEARCH	32
• SPECIFYING THE DIRECTION	33
SEARCH PASS MEMORY FUNCTION	34
• USING THE SEARCH PASS MEMORY	34
• RECALLING THE SEARCH PASS MEMORY	36
• VERIFYING THE SEARCH PASS MEMORY CONTENTS	37
• CANCELLING THE SEARCH PASS MEMORY	38

SEARCH FUNCTIONS

BAND SEARCH

- Even without knowing the desired frequency, you can directly enter to one of the ten bands (already containing data for air band, amateur radio, etc.) and search for stations automatically.
- The contents of a search band (corresponding to a NUMBER key) can be overwritten with frequencies within the reception range.

- 1 Turn the SQUELCH control clockwise until no noise is heard from the speaker.



- 2 Press the NUMBER keys applicable to the band you wish to listen to.

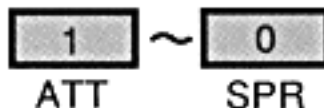

- 3 Press the SEARCH key. The automatic search for the stations will begin. "SEARCH" and band indicators as well as one of the band numbers will be displayed during this operation.



CONTINUOUS SEARCH

- This automatically searches for stations within the reception frequency range. It is useful when you do not know the station's frequency.

- 1 Turn the SQUELCH control clockwise until no noise is heard from the speaker.



- 2 Select the receive mode and the step frequency.

- 3 Press the SEARCH key. The receiver will begin to automatically search for stations.



- The search will start from the manual mode frequency in the receive mode and frequency step already set.
- When the SEARCH key is pressed, the receiver will search for stations incrementally within the reception frequency range starting with the manual mode frequency. When a signal is detected, it will be received for 2 seconds (4 seconds during a delay). The receiver will then continue and search for the next station.
- If you press the SEARCH key during search, the search mode will be canceled.

[Example] When starting the search from the frequencies in the manual mode.



Current Display



SRCH
PRI

Press the SEARCH key.

The receiver will automatically jump to the next frequency based on the step frequency displayed and begin to search for a signal until some signal is received.

SPECIFYING THE DIRECTION

If you press the UP/DOWN keys or turn the TUNING dial during the search, it will send the first step of the frequency, and do the search in the direction specified afterward.

SEARCH PASS MEMORY FUNCTION

USING THE SEARCH PASS MEMORY

■ During a continuous search or a band specified search, you will find frequencies where there is noise or the ordinary signal wave picked up is from a weak station. By using the search pass memory, those frequencies will no longer be received in the search mode, allowing for more efficient searches.

1 Enter the frequency to be deleted or search and stop at the frequency to be deleted. Then press the FUNCTION key.

FUNC

2 Press the PASS key. A beeping sound will indicate the elimination of the frequency.

C/AC
PASS

3 During a search mode, the deleted frequency will be passed over automatically.

- You can register a maximum of 500 frequencies with the search pass memory.
- When the search pass memory goes over 501, "FULL" will be displayed for about one second, and the key operation will return to the previous condition.
- Those frequencies registered in the search pass memory will only be passed over in the search mode.

◆ IMPORTANT

- When you wish to register a frequency where the signal is weak or where only the BUSY display will light up, register while pressing the MONITOR switch.

[Example] When you wish to search pass the channel, 353.2 MHz, being received during the continuous search.



FUNC → **C/AC**
PASS

The registration is completed.

After one second the "P" display will go out and the search will begin.

[Example] Registering 128.8 MHz in the search pass memory.

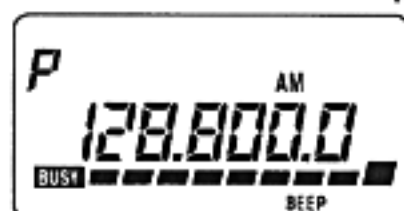

1 **2** **8** **.**
ATT DELAY M-SCAN

8 → **ENT**
M-SCAN

FUNC → **C/AC**
PASS

The registration is completed.

The display returns to the manual mode.

Enter the frequency to be passed over in a search mode.

SEARCH PASS MEMORY FUNCTION

RECALLING THE SEARCH PASS MEMORY

- It is possible to recall the frequencies in the search pass memory in the manual mode or during the search stop.

1 Press the FUNCTION key.

FUNC

2 If you press the SEARCH PASS READ key, you can recall the frequencies in the search pass memory.

0
SPR

- The first time the search pass memory is recalled, the frequency which is the closest to the Up direction in the manual mode frequency will be displayed.
- When you recall the search pass memory, the "P" on the display will blink on and off.
- After you recall the search pass memory, press again the FUNCTION key and the SEARCH PASS READ key to restore the manual mode frequency.

◆ IMPORTANT

- If you do not register any search pass memory, you cannot recall any frequencies.

[Example] When you wish to recall a frequency registered in the search pass.



FUNC

Press the FUNCTION key.

0

SPR

The recall is completed.

VERIFYING THE SEARCH PASS MEMORY CONTENTS

- After recalling the search pass memory, use the TUNING dial, UP key, or DOWN key to recall other search pass frequencies.

◆ IMPORTANT

If only one frequency is registered in the search pass memory, the frequency recalled will not change even when the TUNING dial, UP key, or DOWN key is used.

SEARCH PASS MEMORY FUNCTION

CANCELLING THE SEARCH PASS MEMORY

1 Call up the search pass memory.

2 Use the TUNING dial, UP key, or DOWN key to specify the frequency to be deleted from the search pass memory.



3 Press the FUNCTION key.



4 Press the PASS key to cancel the search pass. At this time, the next frequency in the search pass memory will be shown on the display.

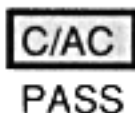

- After the cancellation, press the FUNCTION key and the SEARCH PASS READ key again, or press the CLEAR/ALL CLEAR key in order to return to the frequency in the manual mode.
- If you cancel everything in the search pass memory, it will go to the manual mode.

CHAPTER 4

MEMORY AND SCAN

SETTING THE CHANNEL MEMORIES	40
• SETTING THE CHANNEL MEMORIES	40
• CONTINUOUS MEMORY	42
RECALLING CHANNEL MEMORIES	44
• RECALLING CHANNEL MEMORIES	44
• CHANGING THE FREQUENCY IN THE MEMORY CHANNEL	45
• RETURNING TO MANUAL MODE	46
• PASS MEMORY	47
• ERASING THE CHANNEL MEMORY	48
• MEMORY BACKUP	49
SCAN	50
• CHANNEL MEMORY SCAN	50
• SPECIFYING THE DIRECTION	51
BANK SCAN	52
PROGRAM SCAN	54
• REGISTERING THE PROGRAM SCAN	54
• PROGRAM SCAN	56
MODE SCAN	58
• MODE SCAN OPERATION	58
PRIORITY FUNCTION	60
• REGISTERING THE PRIORITY CHANNEL	60
• RECEIVING THE PRIORITY CHANNEL	62

SETTING THE CHANNEL MEMORIES

SETTING THE CHANNEL MEMORIES

■ There are 1000 channel memories (0 ch through 999 ch) available in this receiver. In manual mode or when a search is stopped, you can register the channel memories.

■ In this receiver, 100 channels can be grouped as one bank in the memory. Therefore, 10 banks are equal to 1000 channels. If the channel memories are grouped according to the bank stored in the memory, you can use the bank scan function when using channel memories. (See page 52)

1 During a search or receive mode, select the frequency step and enter the desired frequency.

2 Set the desired memory channel (0ch through 999ch) with the NUMBER keys. The memory channel you select will flash on the display.

3 Press the FUNCTION key.

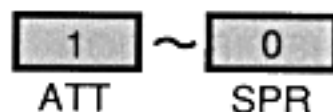

4 Press the MEMORY WRITE key. Two beeps will be heard to indicate the end of memory channel registration.

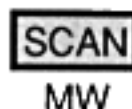

- The receive mode and frequency step displayed will be stored in memory.
- If you try to register more than 1001 channels in the memory, "Error" will be indicated on the display for one second and the receiver will return to the previous operation. If you select a channel that is already stored in the memory, the data will be erased and replaced with new data.
- The 1000 stored channels will become priority channels displayed with "PCH". (See page 60)

◆ IMPORTANT

- After the registered 999 channels, the registered contents will be overwritten in order from the 0 channel unless you specify a channel.

[Example] Storing airline frequency 123.5 MHz in channel 13.

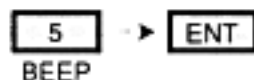

First select the receive mode and frequency step, then enter the frequency.



Select the channel memory.

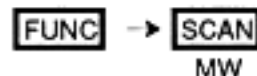

Press the FUNCTION key, then the MEMORY WRITE key to complete registration.



After one second, the channel number display will go out and the frequency step will be displayed for the manual mode.

SETTING THE CHANNEL MEMORIES

CONTINUOUS MEMORY

■ When search is stopped or in manual mode, you can register channels continuously without setting channel numbers.

4
MEMORY AND SCAN
1

Select the receive mode and the frequency step, then enter the desired frequency.

2

Press the FUNCTION key.

FUNC

3

Press the MEMORY WRITE key. Two beeps will be heard to indicate the completion of continuous memory.

SCAN
MW

- Starting with the last recalled channel, it will be stored in the memory.
- When recalling memory channel during memory channel mode, the last recalled channel plus one will be recalled.
- Entering a frequency and setting a reception mode and a frequency step are not required when receiving a station in search mode. The frequency indicated on the display will be registered both as the receive mode and frequency step.

◆ IMPORTANT

- When you operate the continuous memory after registering 999 channels, the registered contents will be overwritten in sequence from channel 0.

[Example] When a searched station is stored without specifying a memory channel after registration of channel 13.



SRCH
PRI

Start searching for a station.



FUNC → **SCAN**
MW

Press the FUNCTION key, then the MEMORY WRITE key to complete registration of the signal as a memory channel.



After one second, the channel number will go out and the receiver will return to the search mode.

RECALLING CHANNEL MEMORIES

RECALLING CHANNEL MEMORIES

1

Enter the channel you wish to recall with the NUMBER keys. The displayed digits will flash.

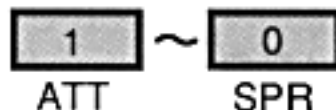

2

Press the MEMORY READ key.

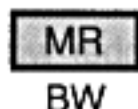

- The preceding channel will be recalled if the MEMORY READ key is pressed without specifying any channel number.
- When you press the MEMORY READ key during memory channel mode, the channel following the last channel stored in memory will be recalled.
- From memory you can recall channels having no frequencies. However, the frequency will be displayed as "000.000.0"
- If you try to register more than 1001 channels in memory, "Error" will be displayed for one second and the receiver will return to the previous operation.
- When you recall the channel in the pass memory mode, the "CH" on the display will flash.
- Priority channel is recalled if 1000 channel is recalled.
- When a channel having a stored program is recalled, "PGM" will blink. (See page 54)
- If you press the MEMORY READ key again after recalling the channels from memory, the receiver will return to the preceding station in the manual mode.

[Example] How to recall channel 13 (frequency 123.5 MHz)from memory.

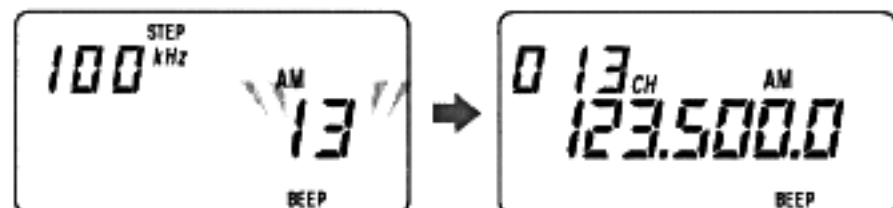

Specify the channel to recall using the NUMBER keys.



Press the MEMORY READ key.

CHANGING THE FREQUENCY IN THE MEMORY CHANNEL

- After recalling a frequency, use the TUNING dial, UP key, or DOWN key to switch to the preceding or following channel. When the UP or DOWN key is held down, the channels will be scanned continuously in sequence or reverse sequence.

RECALLING CHANNEL MEMORIES

RETURNING TO MANUAL MODE

The frequency in memory channel mode can be moved to manual mode (VFO).

1 Recall the desired memory channel.

2 Press the FUNCTION key.

FUNC

3 Press the MEMORY VFO key to enter manual mode.

7
M▶VFO

- The priority channel cannot be moved to the manual mode. (See page 60)

[Example] To recall channel 13 (frequency 123.5 MHz) from memory and shift to the manual mode.

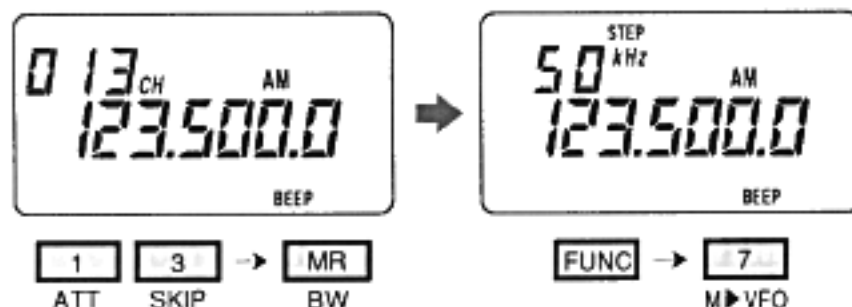

Recall channel 13 from memory.

Press the FUNCTION key and then press the MEMORY VFO key to return to the manual mode.

PASS MEMORY

- If you set the pass memory mode after recalling the channels from memory or during the scan mode (See page 50), the channel in the memory will be skipped afterwards during scanning.

1 Recall the channel from memory that you wish to skip.

2 Press the FUNCTION key. **FUNC**

3 Press the MEMORY PASS key. **C/AC**
PASS

- Pass memory will not accept those channels not stored in memory.
- The "CH" indicator for channels that have been selected to be passed will flash when such channels are recalled.
- To cancel the pass memory mode after recalling the channel from memory, press the FUNCTION and PASS key again.
- Any station received during scan mode (scan halt mode) will be treated as a channel recalled from memory.

[Example] To pass channel 13 during the Scan mode.

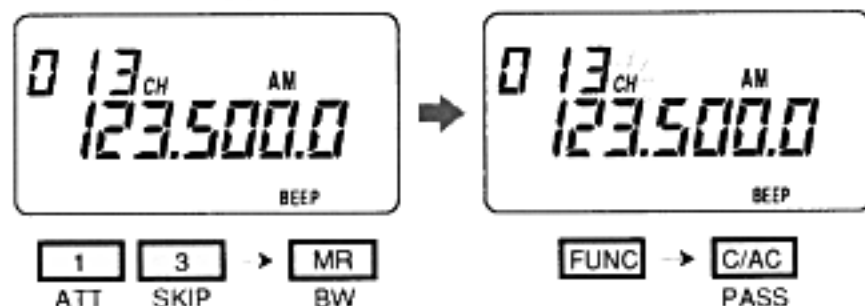

To recall channel 13 from memory, press the NUMBER keys first, and then the MEMORY READ key.

To specify channel 13 as the pass memory channel, press the FUNCTION key first and then the MEMORY PASS key.

RECALLING CHANNEL MEMORIES

ERASING THE CHANNEL MEMORY

■ Follow the steps below to erase data from the memory channel.

1 Recall the memory channel that you wish to erase.

2 Press the FUNCTION key.

FUNC

3 Press the MEMORY WRITE key.

SCAN
MW

- If you erase a channel from memory, "000.000.0" will appear.
- If you erase a channel from memory while receiving a signal, the signal will be received even after the channel is erased from memory.

⚠ IMPORTANT

- The priority channel cannot be erased from the memory.

[Example] To erase the data from channel 13.



First, recall channel 13 from memory by pressing NUMBER keys 13 and then pressing the MEMORY READ key.

Press the FUNCTION key and MEMORY WRITE key. Channel 13 will be erased from memory.

MEMORY BACKUP

- The receiver has a Ni-Cd battery and other power sources for memory backup.
- The contents stored in memory will be retained for 7 days after the receiver's main batteries are completely exhausted.

- The memory backup battery is recharged when an external power source is used for at least an hour or when the receiver is recharged.

◆ IMPORTANT

If the main batteries are exhausted for about 7 days or longer or if the main batteries are removed and the backup battery cannot be charged, the contents in memory will be lost.

SCAN

CHANNEL MEMORY SCAN

■ Pressing the SCAN key enables the receiver to scan the channels (0 through 999ch) until it receives a signal. If the signal is cut, the receiver will start scanning again until it receives a new signal.

1 Turn the SQUELCH control clockwise until no noise is heard from the speaker.



2 Press the SCAN key to start selecting channels automatically. The display will show the channel numbers and bank numbers registered for scanning. When the display stops, the bank number for the channel received will blink.



- To cancel the scan, press the SCAN key again. The receiver will return to the memory recall mode.
- To return to the manual mode frequency during the scan, press the SCAN key and then the MEMORY READ key or press the MEMORY READ key twice.

◆ IMPORTANT

- You can only scan those channels which have been registered. When nothing has been registered "Error" will be displayed for a one second, and you cannot go into the scan mode.
- When the registered channels have all been through the pass memory, ALL PASS will be shown for a one second on the display and you cannot go into the scan mode.

[Example] Scanning the channel memories.

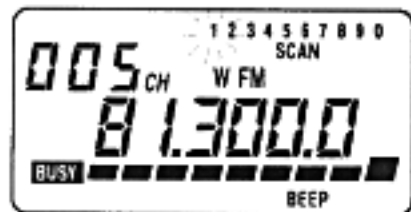

SCAN

MW

Press the SCAN key. "SCAN" will appear on the display. The receiver will automatically begin to scan the channel memories until it receives a signal.

SPECIFYING THE DIRECTION

If you press the UP/DOWN keys or turn the TUNING dial during the scan, you can move up or down one channel and the receiver will begin scanning in the same direction.

BANK SCAN

BANK SCAN

In this receiver, 100 channels can be grouped as one bank in the memory. Therefore, 10 banks are equal to 1000 channels. To scan a specific bank, specify the bank number you wish to scan with the NUMBER keys and press the SCAN key.

1 Turn the SQUELCH control clockwise until no noise is heard from the speaker.



2 Specify the bank you wish to scan with the NUMBER keys. You can specify up to four banks by pressing the NUMBER keys in order. The bank numbers you specify will flash on the display.

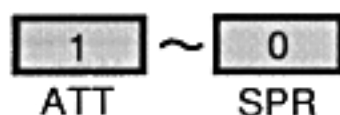

3 Press the SCAN key. The receiver will begin to scan the specified banks.

SCAN

MW

- See the chart below for the relationship between the bank numbers and the channel memories.

Bank Number	1	2	...	9	0
Memory Channel(ch)	0-99	100-199	...	800-899	900-999

- To return to the manual mode frequency during the scan, press the SCAN key and then the MEMORY READ key or press the MEMORY READ key twice.
- The bank scan specified by the NUMBER keys will be canceled when you start next operation.
- Only banks which are in memory can be specified.
- If all the channels stored in banks are in the Pass Memory mode, the "ALL PASS" indicator will appear on the display for one second and the receiver will return to the previous receive mode.

[Example] Scanning bank 1 (0 through 11ch), bank 2 (100 through 199) and bank 0 (900 through 999) from the 10 banks in which channels have already been stored.

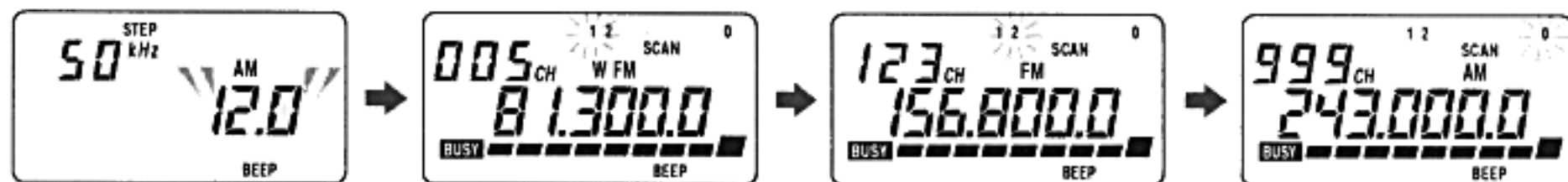

1 2 0
ATT DELAY SPR

SCAN
MW

Specify the bank to scan by entering the bank numbers with the NUMBER keys.

Press the SCAN key to scan the specified banks. During bank scan, bank numbers 1, 2 and 0 will appear on the display. When a signal is received, the bank scan number will begin to flash.

PROGRAM SCAN

REGISTERING THE PROGRAM SCAN

■ There is a program scan function for scanning the memory channels stored. Up to 100 channels (from ten banks holding ten channels each) can be scanned.

1 Recall the channel you wish to store in the program scan.

2 Press the FUNCTION key.

FUNC

3 Press the PROGRAM key. Two beeps will be heard to indicate the completion of program scan.

6
PGM

- The channels to be scanned can also be registered in a program.
- When channels are being registered in a bank, the upper right of the display will show the number for each channel, 1 to 9, then 0. If more than ten channels are registered, this numeric sequence will be repeated.
- For channels registered in a program, "PGM" will blink on the display.
- The contents of a program can be checked by holding down the MONITOR switch during the program scan (see page 56) and using the TUNING dial, UP key, or DOWN key.
- To cancel a program, recall a memory channel registered in the program, then press the FUNCTION key and then the PROGRAM key.

[Example] Registering channel 5 (78 MHz in the Wide FM receive mode) in the program scan.

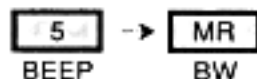

Recall channel 5 from memory.

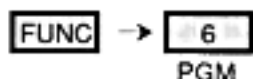

Number registered in the bank and "PGM" will be displayed.

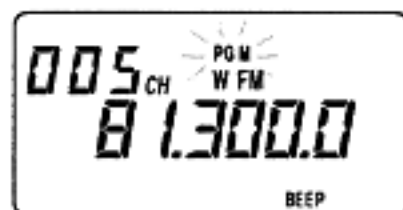

After one second, the number registered in the bank will disappear and "PGM" will blink. This indicates that the channel has been registered in the program.

[Example] Canceling channel 5's registration in the program.

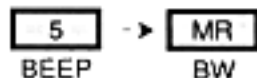

Recall channel 5 from memory.

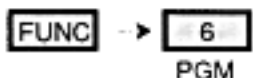

The blinking "PGM" will disappear and the channel's program registration will be canceled.

PROGRAM SCAN

PROGRAM SCAN

■ Only the channels registered in a program can be scanned.

1

Turn the SQUELCH control clockwise until no noise is heard from the speaker.



2

Press the FUNCTION key.



3

Press the PROGRAM SCAN key. "PGM-SCAN" will be displayed and the receiver will begin the program scan.

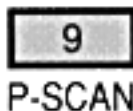

- To cancel the program scan and return to the memory recall mode during the program scan, press the FUNCTION key and then the PROGRAM SCAN key.
- To return to the manual mode's frequency during the program scan, press the MEMORY READ key twice.
- To specify up to four banks for a program scan, press the appropriate NUMBER keys, the FUNCTION key, and the PROGRAM SCAN key.

◆ IMPORTANT

- If nothing is registered in a program, a program scan cannot be executed.
- The program scan can also detect channels set for pass memory. However, it cannot set or cancel a pass memory for a channel.

[Example] Program scan of all the channels registered in a program.



FUNC

Press the FUNCTION key.

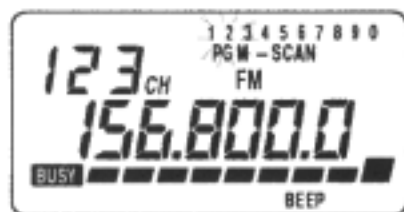

9

P-SCAN

Press the PROGRAM SCAN key to start the program scan. When a signal is received, the signal's bank number will blink.

[Example] Program scan of bank 9 (channels 800 to 899) and bank 0 (channels 900 to 999).



9 **0**
P-SCAN SPR

Specify the bank.

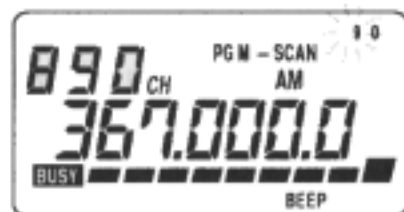

FUNC > **9**
P-SCAN

Press the FUNCTION key then the PROGRAM SCAN key to program scan the specified bank.

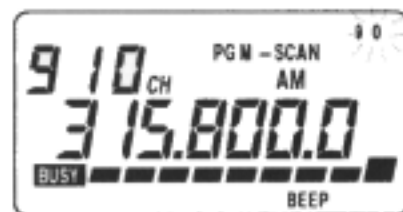

MODE SCAN

MODE SCAN OPERATION

■ Among the memory channels registered, only those in the same mode as the receive mode selected in the manual mode can be scanned.

1 Select the desired receive mode in the manual mode. (See pages 19 and 20)

2 Turn the SQUELCH control clockwise until no noise is heard from the speaker.



3 Press the FUNCTION key.



4 Press the MODE SCAN key. "SCAN" will appear on the display and the receive mode will blink. The mode scan will start.

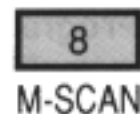

- To cancel the mode scan and return to the memory recall mode, press the FUNCTION key and then the MODE SCAN key.
- To return to the manual mode's frequency during the mode scan, press the MEMORY READ key twice.
- To specify up to four banks for a mode scan, press the appropriate NUMBER keys, the FUNCTION key, and the MODE SCAN key.
- If there is no channel registered in the receive mode for the corresponding memory channel, "Error" will be displayed for one second and the receiver will return to the preceding mode.
- If all the relevant channels are registered for pass memory, "ALL PASS" will be displayed for one second and the receiver will return to the preceding mode.
- For the channels registered in a program, "PGM" will blink on the display.

[Example] Scanning memory channels which were registered in the WFM mode.



In the manual mode, select the WFM mode.



FUNC → **8**
M-SCAN

The mode scan will start and the receive mode will blink. When a signal is received, the number of the bank being received will blink.



When a channel registered in a program is received, "PGM" will also blink.

PRIORITY FUNCTION

REGISTERING THE PRIORITY CHANNEL

This receiver can store certain frequencies in the 1000 channel as priority channels, which are monitored every five seconds during any of the scan, search, memory recalling, and manual modes.

MEMORY AND SCAN 4

1 First select the receive mode and frequency step, then enter the frequency which is to be a priority channel. (See pages 20 to 22)

2 Enter "1000" with the NUMBER keys.

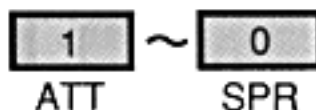

3 Press the FUNCTION key.



4 Press the MEMORY WRITE key, You will hear two beeps when the priority channel has been stored.



- The priority channel is stored in the memory as the 1000 channel.
- To check which priority channel is registered, recall channel 1000.
- For priority channels, "PCH" will be displayed.
- The initial setting for a priority channel will be 144.0 MHz, FM mode, and 20 kHz step.

◆ IMPORTANT

Priority channels cannot be registered for pass memory. (See page 47)

[Example] Registering FM mode, 158.35 MHz as a priority channel.



Select the FM mode and set 10 kHz for the frequency step.



[1] [5] [8] [.]
ATT BEEP M-SCAN

[3] [5] → [ENT]
SKIP BEEP

Enter the frequency.



[1] [0] [0] [0]
ATT SPR SPR SPR

Enter "1000".



[FUNC] → [SCAN]
MW

The registration is complete.



After one second, "PCH" will disappear and the receiver will return to the manual mode.

PRIORITY FUNCTION

RECEIVING THE PRIORITY CHANNEL

1 Press the FUNCTION key .

FUNC

2 Press the PRIORITY key to receive the priority channel. "PRI" will appear on the display.

SRCH
PRI

- To cancel the priority function, press the FUNCTION key and the PRIORITY key.
- When a priority channel is received, the reception will continue until the signal goes out.

◆ IMPORTANT

- The priority channel cannot be shifted to the manual mode. (See page 46)
- Priority channels cannot be registered for pass memory. (See page 47)

[Example] Setting the priority function.



FUNC → **SRCH**
PRI

The setting is complete.



A priority channel will be checked every 5 seconds.

CHAPTER 5

USEFUL FUNCTIONS

CHANGING THE SEARCH BAND	64
ATTENUATOR FUNCTION	66
DELAY FUNCTION	67
SKIP FUNCTION	67
BATTERY SAVE FUNCTION	68
CANCELLING THE BEEP TONE.....	70
LAMP	70

CHANGING THE SEARCH BAND

CHANGING THE SEARCH BAND

The contents of a search band (corresponding to a NUMBER key) can be overwritten with frequencies within the reception range.

1 While in the manual mode, select the step frequency and receive mode.

2 Press the FUNCTION key.

FUNC

3 Press the BAND WRITE key.

MR
BW

4 Enter the lower limit of the band frequency.

1 ~ **0**
ATT **SPR**

5 Press the ENTER key.

ENT

6 Enter the upper limit of the band frequency.

1 ~ **0**
ATT **SPR**

7 Press the ENTER key.

ENT

8 Press the SEARCH BAND key to change the searching range.

1 ~ **0**
ATT **SPR**

9 Press the ENTER key. You will hear two beeps when the searching range has been changed.

ENT

- Although in the above steps you enter the lower and then the upper limit of the band frequencies, you can reverse the order if you like.

[Example] Overwriting the search band (corresponding to the “6” key) 422.2 MHz to 422.3 MHz with the FM mode, 12.5 kHz step.



Select the receive mode and frequency step.



FUNC → **MR**
BW

Press the FUNCTION key and then the BAND WRITE key.



4 **2** **2** **.**
SAVE DELAY DELAY

2 → **ENT**
DELAY

Enter the lower-limit frequency. After the entry is completed, the frequency displayed will disappear.



4 **2** **2** **.**
SAVE DELAY DELAY

3 → **ENT**
SKIP

Enter the upper-limit frequency. After the entry is completed, the frequency displayed will disappear.



6
PGM

Specify the search band.



ENT

Press the ENTER key to complete the operation. The receiver will return to the initial frequency.

ATTENUATOR FUNCTION

- This function weakens the signal received.
- Use this function if a signal is so strong that the receiver suffers from radio interference when the radio station is too close. This function can be registered in the channel memory.

1 Press the FUNCTION key. 

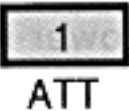
2 Press the ATTENUATOR key to activate the attenuator function. 

- To cancel the attenuator function, press the FUNCTION key and then the ATTENUATOR key again.
- When the attenuator function is set, "ATT" will be displayed.
- The attenuator function can be set or canceled during a scan or memory recall.
- The attenuation will be about -15 dB (at 108 MHz).

◆ IMPORTANT

If the attenuator function is always set, weak signals will not be received. Use the attenuator function only when necessary.

DELAY FUNCTION

- It takes two seconds to move up or down from one channel to another during scanning or searching signals. With the delay function, this timing can be delayed to four seconds.

1 Press the FUNCTION key. 

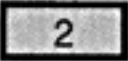
2 Press the DELAY key to activate the delay function. 
DELAY

- To cancel the delay function, press the FUNCTION key and the DELAY key again.
- While the delay function is on, "DELAY" will be displayed.

◆ IMPORTANT

The delay function cannot be set while the NUMBER keys are pressed (entry blinking) or during search pass memory recall.

SKIP FUNCTION

- With the skip function set during a scan or search, the receiver receives a station for 5 seconds before going to the next station.

1 Press the FUNCTION key. 

2 Press the SKIP key to start the skip function. 
DELAY

- To cancel the skip function, press the FUNCTION key and the SKIP key again.
- "SKIP" will light when the skip function is on.

◆ IMPORTANT

The skip function cannot be set or canceled while the NUMBER keys are pressed (entry blinking) or during search pass memory recall.

BATTERY SAVE FUNCTION

- If there is no operation or no signal reception for 5 seconds, the receiver will enter the reception standby and non-operation conditions in a repetitive cycle to conserve battery power.
- The time ratio of the reception standby and non-operation conditions in the cycle can be selected with the NUMBER keys.

Numeric key	Standby time	Non-operation time	Ratio
1	0.3 seconds	0.3 seconds	1:1
2	0.3 seconds	0.9 seconds	1:3
3	0.3 seconds	1.5 seconds	1:5

- 1 The manual mode will become the memory channel recall mode. (See pages 44, 45, and 46)
- 2 Use a NUMBER key to specify the time ratio. If a NUMBER key is not used to specify the ratio, "1" will be specified automatically.

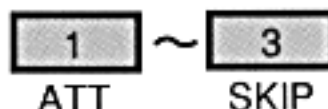

- 3 Press the FUNCTION key.



- 4 Press the SAVE key to activate the battery save function.



- To cancel the battery save function, press the FUNCTION key and then the SAVE key. If another time ratio is specified, the new time ratio will take effect.
- When the battery save function is activated, "SAVE" and the time ratio will be displayed as "1", "2", or "3".

◆ IMPORTANT

- The battery save function operates only during the manual mode and memory channel recall.
- The battery save function will be canceled automatically when a search or scan is done.

[Example] Setting battery save with a 1:5 time ratio.



Set the manual mode or memory channel recall.



3
SKIP
Use the NUMBER keys to specify the desired time ratio.



FUNC → **4**
SAVE
"SAVE" and the time ratio number will appear and the setting will be completed.

CANCELLING THE BEEP TONE

1 Press the FUNCTION key. 

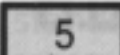
2 Press the BEEP key to cancel the beep tone. 
BEEP

- To activate the beep tone function, press the FUNCTION key again and then the BEEP key again.
- When the beep tone function is on, "BEEP" will be displayed.
- The beep tone indicates if you are doing the correct key operation or not.
- The following beeps indicate three different operations:
 - One beep indicates input from a NUMBER key or an individual key.
 - Two beeps indicate the completion of memory operations (storing and erasing operations).
 - Three beeps indicate an error.

◆ IMPORTANT

- The beep tone cannot be canceled during direct entry (when numbers are flashing on the display) using the NUMBER keys.

LAMP

- To use the receiver in the dark area, the display and keyboard can be illuminated.

1 Press the LAMP switch, the lamp will light while the switch is pressed.

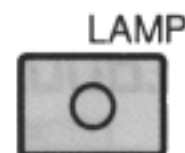

CHAPTER 6

THINGS TO KNOW

TROUBLESHOOTING	72
GENERAL SPECIFICATIONS	74

TROUBLESHOOTING

■ Before requesting repair services, check the following. If the problem cannot be resolved after the check, then consult the dealer where you purchased the receiver.

Problem	Cause	What to do
Nothing is shown on the display.	The batteries are used up.	Recharge the batteries or replace them. (See pages 15, 16)
PCH is displayed from time to time.	The priority function is working.	Cancel the priority function. (See page 62)
"P" blinks.	Search pass memory is being recalled	Set the manual mode. (See pages 19, 36)
Reception is interrupted.	Squelch adjustment is wrong.	Do the squelch adjustment correctly. (See page 18)
	The signal wave from the transmitting station is weak.	Press the MONITOR switch. (See page 30)
	The attenuator function is activated.	Cancel the attenuator function. (See page 66)
The proper signal cannot be received.	An improper receive mode was selected.	Select the proper receive mode. (See pages 19, 20)
No operation even when the key is pressed.	The KEY LOCK switch is ON.	Turn the KEY LOCK switch OFF. (See page 30)
Cannot input the frequency.	A frequency not in the reception frequency range was entered.	Input a frequency in the reception frequency range. (See page 22)

Problem	Cause	What to do
Cannot do the search.	The squelch adjustment is wrong.	Do the squelch adjustment correctly. (See page 18)
	You are pressing the MONITOR switch.	Release the MONITOR switch. (See page 30)
Cannot do the scan.	The squelch adjustment is wrong.	Do the squelch adjustment correctly. (See page 18)
	You are pressing the MONITOR switch.	Release the MONITOR switch. (See page 30)
	All of the memory channels are in the pass memory.	Cancel the pass memory. (See page 47)
	Nothing is registered for any of the memory channels.	Do the channel memory. (See page 40)
Cannot recharge.	The "PWR/VOL" is ON.	Recharge after turning the "PWR/VOL" OFF. (See page 15)
	The connector fuse is blown.	Replace the fuse.

GENERAL SPECIFICATIONS

FREQUENCY RANGE

530 kHz ~ 1650 MHz

(Displayed frequency range: 0.1 MHz ~ 1650 MHz)

RECEIVE MODE

WFM, FM, AM, LSB, USB

STEP FREQUENCY

50 Hz, 100 Hz, 1 kHz, 5 kHz, 6.25 kHz, 9 kHz, 10 kHz, 12.5 kHz, 20 kHz, 25 kHz, 50 kHz, 100 kHz

(For the WFM mode, 50 kHz or 100 kHz is selected.)

(50 Hz and 100 Hz can be selected in the LSB and USB modes.)

SENSITIVITY

0.53 MHz ~ 2.0 MHz

AM 10 μ V or less (S/N 10 dB)

2.0 MHz ~ 30 MHz

AM 1.5 μ V or less (S/N 10 dB)

USB/LSB 1.0 μ V or less (S/N 10 dB)

FM 1.5 μ V or less (SINAD 12 dB)

30 MHz ~ 1000 MHz

AM 0.5 μ V or less (S/N 10 dB)

USB/LSB 0.5 μ V or less (S/N 10 dB)

FM 0.5 μ V or less (SINAD 12 dB)

WFM 0.75 μ V or less (SINAD 12 dB)

1000 MHz ~ 1300 MHz

FM 1.0 μ V or less (SINAD 12 dB)

NUMBER OF MEMORIES

Channel memory: 1000

Search pass memory: 500

Band memory: 10

Priority channel memory: 1

SCAN/SEARCH SPEED

Approx. one second per 30 channels / 30 steps

ANTENNA IMPEDANCE/TYPE

50 Ω / BNC

POWER SUPPLY

KR-AA Size Ni-Cd battery \times 4 (4.8V)

12 V DC external power source (also for battery charging)

SPECIFICATION FOR AC ADAPTOR

Output: 12 V 200 mA

Connector: Type III

MAXIMUM SPEAKER OUTPUT

100 mW or more (4.8 V 8 Ω)

CURRENT CONSUMPTION

During rated output: 140 mA (nominal)

During standby: 100 mA (nominal)

During save: 10 mA or less

OPERATING TEMPERATURE RANGE

0 $^{\circ}$ C ~ 50 $^{\circ}$ C

DIMENSIONS

64.4 (W) x 155 (H) x 38.2 (D) mm
(Excluding protruded parts)

WEIGHT

320 g (Excluding the antenna)

INITIAL SEARCH BAND ENTRIES

BAND	FREQUENCY LIMITS (MHz)		STEP FREQUENCY (kHz)	RECEIVE MODE
	LOWER LIMIT	UPPER LIMIT		
1	76	107.75	50	WFM
2	108.0	142.0	50	AM
3	144.0	146.0	20	NFM
4	146.01	154.65	10	NFM
5	156.0	162.05	12.5	NFM
6	175.75	221.75	50	WFM
7	430.0	440.0	20	NFM
8	450.0125	451.5	12.5	NFM
9	850.0125	859.9875	6.25	NFM
10	903.0375	904.9875	12.5	NFM

YUPITERU INDUSTRIES CO., LTD.
12-33 Shibaura 4-chome Minato-ku
Tokyo 108 Japan