

YAESU

The radio

FTM-3100R/E

Operating Manual

VHF FM TRANSCEIVER

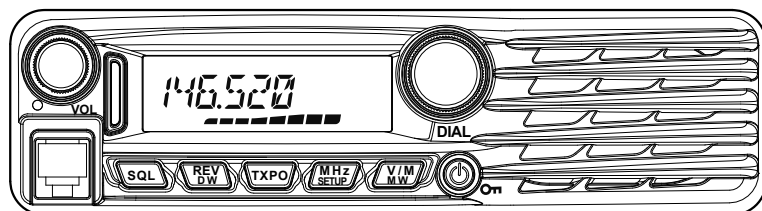

Contents

FTM-3100R/E Quick Reference Guide	3	Memory Operation	22
Introduction	4	Memory Storage	22
Features of this radio	4	Split Memory	22
Accessories & Options	5	Naming a Memory Channel.....	22
Supplied Accessories	5	Memory Recall.....	23
Optional Accessories	5	Memory Recall from the Microphone Keypad.....	23
Installation	6	Moving Memory Data to the VFO	23
Connecting the Microphone.....	6	Memory Only Mode	23
Connecting the Antenna	6	Masking Memories	24
Mobile Installation.....	7	Unmasking Memories.....	24
Power connection	8	HOME Channel Memory	24
Base Station Installation	9	Changing the frequency of the home channel.....	24
AC Power Supplies	9	Scanning	25
Front Panel Controls & Switches	10	Basic Scanner Operation.....	25
Front Panel	10	Scan Resume Options	25
Microphone Switches	12	Memory Skip Scanning.....	25
Microphone (MH-48A6JA)	12	Preferential Memory Scan	25
[P1] button (SQL OFF).....	12	Programmable Memory Scan (PMS).....	25
[P2] button (HOME)	12	Priority Channel Scanning (Dual Watch)	25
[P3] button (CD SRCH).....	12	Reset Procedure/Clone	26
[P4] button (WX CH/T.CALL)	12	Reset Procedure.....	26
Rear Panel Connectors	13	Microprocessor Resetting	26
Rear Panel.....	13	Set Mode Resetting	26
Basic Operation	14	Clone	26
Turning the Transceiver ON and OFF	14	Miscellaneous Settings	27
Adjusting the Audio Volume Level	14	Programming the Key Assignments	27
Adjusting the Squelch Setting.....	14	Keyboard Beeper.....	27
Frequency Navigation.....	15	Display Brightness.....	27
Using the Dial	15	Time-Out-Timer (TOT).....	27
Using the MH-48A6JA Microphone.....	15	Automatic Power Off (APO).....	27
Channel Step Selection	15	Busy Channel Lock-Out (BCLO)	27
Transmission	16	TX Deviation Level	27
Adjusting the transmit power	17	MIC Gain Setting	27
Lock Feature.....	17	Displaying the Supply Voltage	28
Advanced Operation	18	Displaying the Temperature.....	28
Repeater Operation	18	Band Edge Beeper	28
Checking the Repeater Uplink (Input)		Setup (Menu) Mode	29
Frequency.....	18	Maintenance	32
Tone Calling (1750 Hz)	18	Care and maintenance	32
Weather Broadcast Reception.....	19	Replacing the fuse	32
Severe Weather Alert Feature	19	Replacing the fuse of the	
CTCSS Operation.....	20	DC power supply cable.....	32
Tone Search.....	20	Specifications	33
DCS Operation	20		
DCS Search.....	21		
EPCS (Enhanced Paging & Code Squelch)			
Operation.....	21		
Split Tone Operation	21		
DTMF Operation.....	21		

② VOL Knob

Adjusts the audio volume level.

③ Frequency DIAL Knob

Selects the operating Frequency.

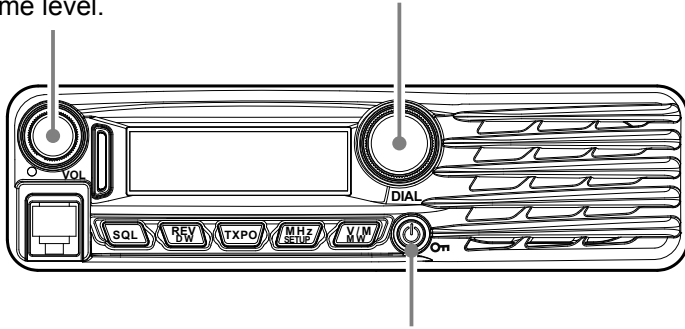

① Power Switch

Press and hold for one second.

④ Transmission Switch

Speak into the microphone in a normal voice level while pressing this switch.

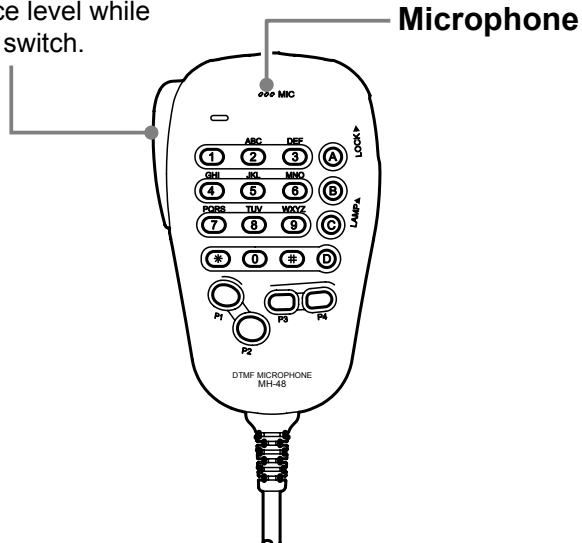

Features of this radio

- 65 Watts of power output, with selection of three power levels for every operating situation
- Expanded receiver coverage: 136-174 MHz
- Keyboard entry of operating frequencies from the microphone
- 220 memories (199 “basic” memory channels, 10 sets of band-edge memory channels, and one “Home” channel) which can store repeater shifts, odd repeater shifts, CTCSS/DCS tones, and 8-character Alpha-Numeric labels for easy channel recognition
- 10 NOAA Weather Broadcast Channels, with Weather Alert and a Volume Control for the Weather Alert tone
- Built-in CTCSS and DCS Encoder/Decoder circuits
- Extensive Menu system, which allows customization of a number of transceiver performance characteristics

Additional features include a transmit Time-Out-Timer (TOT), Automatic Power-Off (APO), and Automatic Repeater Shift (ARS). Also included is an RF Squelch circuit that allows the owner to set the squelch to open at a programmed setting of the S-Meter, thus reducing guesswork in setting the squelch threshold.

Congratulations on your purchase of the FTM-3100R/E. Whether this is your first rig, or if Yaesu equipment is already the backbone of your station, the Yaesu organization is committed to ensuring your enjoyment of this high-performance transceiver. It should provide you with many years of satisfying operation. Our dealer network and technical support personnel stand behind every product we sell, and we invite you to contact us should you require technical advice or assistance.

We recommend that you read this manual in its entirety prior to installing the FTM-3100R/E, so that you fully understand the capabilities of your new transceiver.

Supplied Accessories

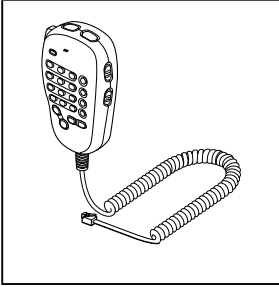

DTMF Microphone
MH-48A6JA

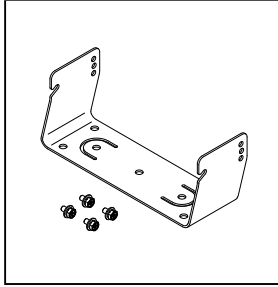

Mobile Mounting Bracket
(Attachment screw set)

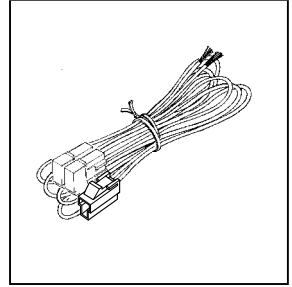

DC power cable w/Fuse

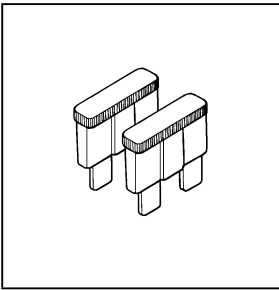

Spare fuse (25 A)
(20 A, European version)

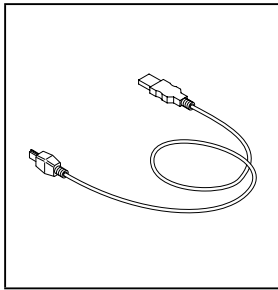

USB cable

Operating Manual
Safety Guide
Warranty Card

Optional Accessories

MH-42C6J	Microphone
MH-48A6JA	DTMF Microphone
MLS-100	High-Power External Speaker
FP-1023	AC Power Supply (USA market only)
FP-1030A	AC Power Supply (USA/EXP market only)

Installation

Connecting the Microphone

Connect the supplied MH-48A6JA microphone to the FTM-3100R/E.

Plug the microphone connector into the MIC jack on the front panel until it clicks.

Note: When disconnecting the microphone, pull the cable while pressing the connector latch.

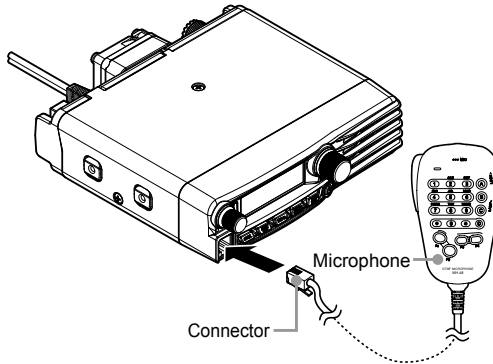

Connecting the Antenna

Connect the coaxial cable to the body.

Plug the coaxial cable jack into the ANT terminal on the rear panel of the body, then rotate and tighten it.

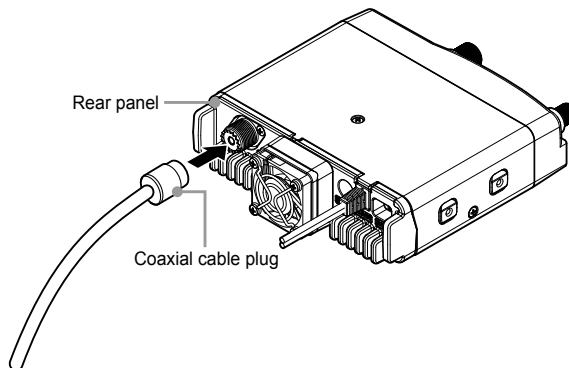

Mobile Installation

The FTM-3100R/E must only be installed in vehicles having a 13.8 Volt negative ground electrical system. Mount the transceiver where the display, controls, and microphone are easily accessible, using the supplied mounting bracket.

The transceiver may be installed in almost any location, but should not be positioned near a heating vent nor anywhere where it might interfere with driving (either visually or mechanically).

Make sure to provide plenty of space on all sides of the transceiver so that air can flow freely around the radio's case. Refer to the diagrams showing proper installation procedures.

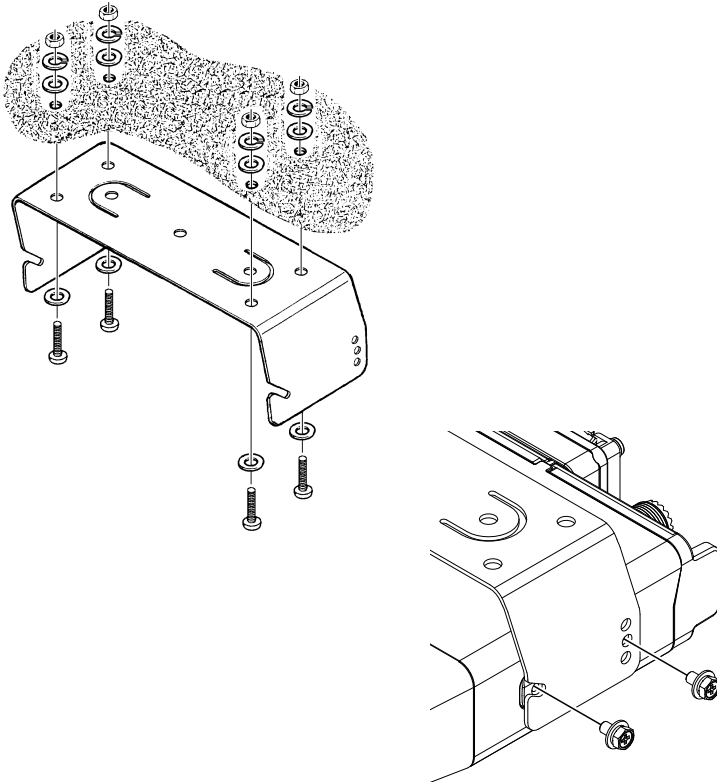

Installation

Power connection

To minimize voltage drop and avoid blowing the vehicle's fuses, connect the supplied DC power cable directly to the battery terminals. Do not attempt to defeat or bypass the DC cable fuse - it is there to protect you, your transceiver, and your vehicle's electrical system.

Warning!

Never apply AC power to the power cable of the FTM-3100R/E, nor DC voltage greater than 15.8 Volts. When replacing the fuse, only use a 25-A (20-A, European version) fuse. Failure to observe these safety precautions will void the Limited Warranty on this product.

- Before connecting the transceiver, check the voltage at the battery terminals while revving the engine. If the voltage exceeds 15 Volts, adjust the vehicle's voltage regulator before proceeding with installation.
- Connect the **RED** power cable lead to the **POSITIVE (+)** battery terminal, and the **BLACK** power cable lead to the **NEGATIVE (-)** terminal. If you need to extend the power cable, use #12 AWG or larger insulated, stranded copper wire. Solder the splice connections carefully, and wrap the connections thoroughly with insulating electrical tape.
- Before connecting the cable to the transceiver, verify the voltage and polarity at the voltage at the transceiver end of the DC cable, using a DC voltmeter. Now connect the transceiver to the DC cable.

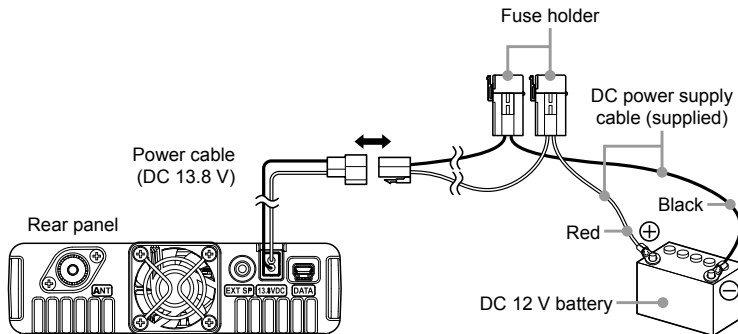

Warning!

- ***Do not use a DC power supply cable other than the one that is supplied or specified.***
- ***Do not place anything on the DC power supply cable or step on it.***
- ***Do not use the DC power supply cable with the fuse holder cut off.***
- ***Do not reverse the polarity (positive and negative) when connecting the battery.***

Base Station Installation

The FTM-3100R/E is ideal for base station use as well as in mobile installations. The FTM-3100R/E is specifically designed to integrate into your station easily, using the following information as a reference.

AC Power Supplies

Operation of the FTM-3100R/E from an AC line requires a power source capable of providing at least 20 Amps continuously at 13.8 Volts DC. The FP-1023 (USA market only) and FP-1030A (USA/EXP market only) AC Power Supplies are available from your Yaesu dealer to satisfy these requirements. Other well-regulated power supplies may be used as well, if they meet the above voltage and current specifications.

Use the DC power cable supplied with the transceiver to make the power connection to the power supply. Connect the **RED** power cable lead to the **POSITIVE (+)** power supply terminal, and connect the **BLACK** power cable lead to the **NEGATIVE (-)** power supply terminal.

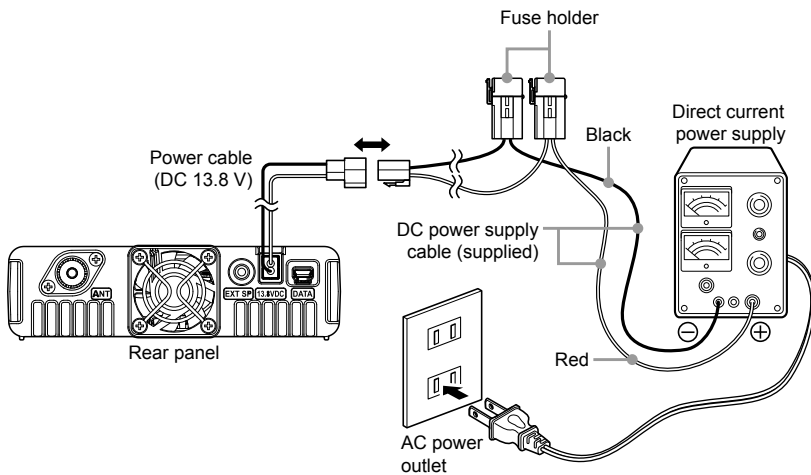

Front Panel Controls & Switches

Front Panel

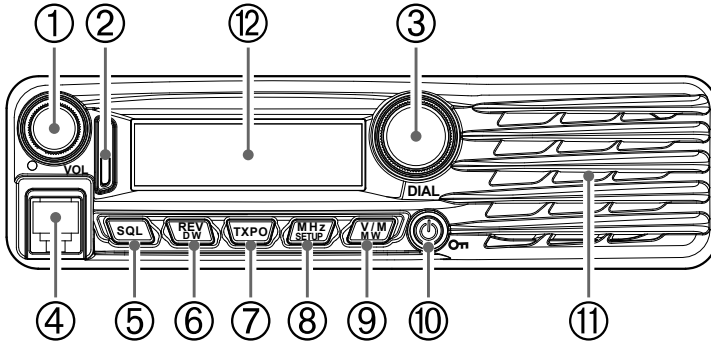

① VOL knob

Turning the knob clockwise increases the volume, whereas turning it counterclockwise decreases the volume.

② Mode/Status indicator

Indicates the transmission/reception status with a two-color combination on the upper and lower portions of the mode/status indicator.

Communication status	Upper portion	Lower portion
Receiving audio	Green	Green
Transmitting audio	Red	Red
Receiving signals with unmatched audio conditions*	Green	Blink in Blue

- * • Receiving signals with unmatched tone frequency or DCS code.
- Receiving a signal level less than the RF Squelch S-meter level setting.

③ DIAL Knob

- Allows setting the operating band frequency.
Turning clockwise increases the frequency, whereas turning counterclockwise decreases the frequency.
- Allows selecting the desired items for setup, memory registration, etc.

④ MIC Jack

Connect the provided microphone cable.

Front Panel Controls & Switches

⑤ [SQL] key

Press the key briefly and rotating the **DIAL** knob to sets the squelch level.

⑥ [REV(DW)] key

During split-frequency operation, such as through a repeater, this key reverses the transmit and receive frequencies.

Press and hold the key in for over one second to activate the Dual Watch feature.

Note: For details, refer to the Advanced Manual (download from the Yaesu website).

⑦ [TXPO] key

Press the key briefly and rotating the **DIAL** knob to select the transmit power (HIGH: 65 W / MID: 30 W / LOW: 5 W).

⑧ [MHz(SETUP)] key

This key allows tuning in 1 MHz steps (the MHz digits will blink on the display).

Press and hold this key in for over one second to activate the Setup (Menu) Mode.

⑨ [V/M(MW)] key

Pressing this key briefly, switches between VFO mode and memory mode. Press and hold the key for over one second to display the memory registration screen.

⑩ Power/Lock key

Press and hold in this key for over one second to switch the power between ON and OFF. Briefly pressing the key while the transceiver is turned ON engages or releases the key lock.

⑪ Speaker

The internal speaker is located here.

⑫ LCD Display

The main digits on the display may show the operating frequency, memory name, or any of many parameters during Menu setup.

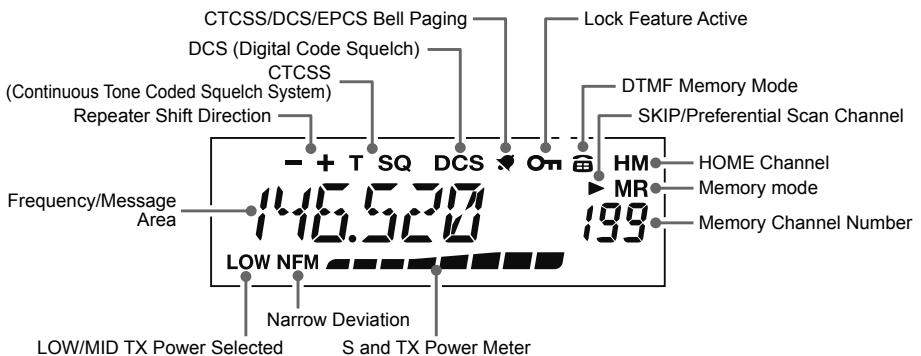

Microphone Switches

Microphone (MH-48A6JA)

① PTT Switch

Press this switch to transmit, and release it to receive.

② KEY Pad

These 16 keys generate DTMF tones during transmission.

In the receive mode, these 16 keys can be used for direct frequency entry and/or direct numeric recall of the Memory channels.

③ [P1] / [P2] / [P3] / [P4] keys

These four keys are user programmable, allowing quick access to features used often. The default functions are described below.

[P1] button (SQL OFF)

Press this button to disable the noise and tone squelch systems.

[P2] button (HOME)

Press this button to recall the receiver HOME channel.

[P3] button (CD SRCH)

Press this button to activate the Tone or DCS Search feature.

[P4] button (WX CH/T.CALL)

In the USA version, pressing this button recalls the “Weather” broadcast channel bank. In the EXP/European version, pressing this button activates T.CALL (1750 Hz) for repeater access.

You can reprogram the [P1], [P2], [P3], and [P4] buttons for other functions, if desired.

Note: For details, refer to the Advanced Manual (download from the Yaesu website).

④ MIC

Speak into this port during transmission.

⑤ [UP] / [DWN] keys

Press (or hold in) either of these buttons to tune (or scan up or down) the operating frequency or through the memory channels. In many ways, these buttons emulate the function of the (rotary) DIAL knob.

⑥ LOCK switch

This switch locks out the Microphone buttons (except for the keypad and PTT switch).

⑦ LAMP switch

This switch illuminates the Microphone keypad.

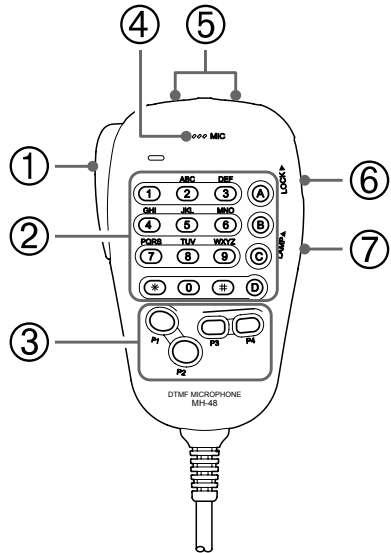

Rear Panel Connectors

Rear Panel

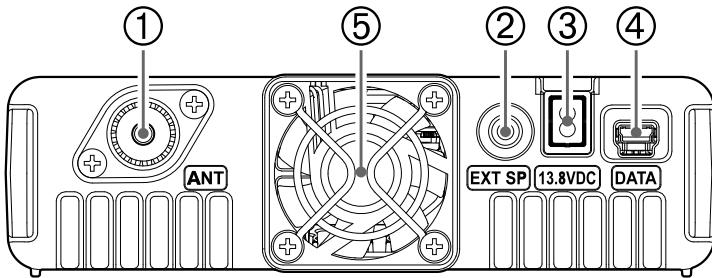

① ANT Coaxial Socket

Connect a 144 MHz antenna to this type-M (SO-239) socket using 50-Ohm coaxial cable and a type-M (PL-259) plug. Make sure the antenna is designed specifically for use on the operating frequency.

② EXT SP Jack

This 2-contact 3.5-mm mini phone jack provides receiver audio output for an optional external speaker. The audio impedance is 4 Ohms, and the level varies according to the setting of the front panel **VOL** control. Inserting a plug into this jack disables audio from the transceiver's internal speaker.

③ 13.8 V DC Cable

Connect the provided DC power supply cable (with fuse attached).

④ DATA Jack

Use this jack when updating the firmware. When a new firmware update for the FTM-3100R/E is available, go to the YAESU website to download the programming data and update the FTM-3100R/E to its newest state.

⑤ Cooling Fan

Basic Operation

Turning the Transceiver ON and OFF

1. To turn the transceiver ON, press and hold the **PWR/LOCK** key for one second.
2. To turn the transceiver OFF, again press and hold the **PWR/LOCK** key for one second.

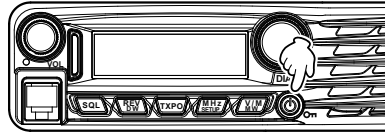

You can compose any desired Opening Message (up to 8 characters) via Setup Menu Item “**20 OPEN MSG**” see page 30 for details.

Adjusting the Audio Volume Level

Rotate the **VOL** knob to adjust the receiver volume. Clock-wise rotation increases the audio output level.

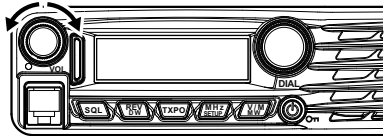

Adjusting the Squelch Setting

1. Press the **[SQL]** key, and then rotate the **DIAL** knob to select the Squelch level.
2. Press the **[SQL]** key again.

Note: A special “RF Squelch” feature is provided on this radio. This feature allows setting the squelch so that only signals exceeding a certain S-meter level will open the squelch. For details, refer to the Advanced Manual (download from the Yaesu website).

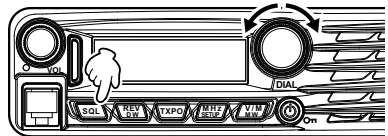

Frequency Navigation

Using the Dial

Rotating the **DIAL** knob allows tuning in the pre-programmed steps. Clockwise rotation tunes the frequency upwards, whereas counterclockwise rotation tunes the frequency downwards.

- Press the [**MHz(SETUP)**] key momentarily, and then rotate the **DIAL** knob, to change the frequency steps to 1 MHz per step.

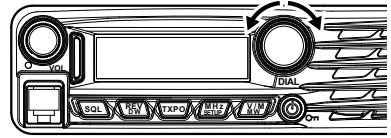

Using the MH-48A6JA Microphone

Using the [UP] and [DWN] key:

Pressing [**UP**] momentarily, tunes the frequency upwards. Whereas pressing [**DWN**] momentarily tunes the frequency in the downward direction.

Using the number keys:

Use the [0] to [9] number keys to directly input the frequency.

There is no “decimal point” key on the MH-48A6JA keypad. However, there is a short-cut for frequencies ending in zero: press the [#] key after the last non-zero digit.

- Examples:** To enter 146.520 MHz, press [1] ➡ [4] ➡ [6] ➡ [5] ➡ [2] ➡ [0]
 To enter 146.000 MHz, press [1] ➡ [4] ➡ [6] ➡ [#]

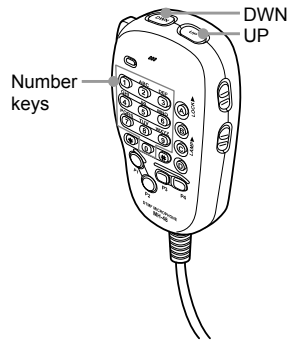

Channel Step Selection

The frequency tuning step of the **DIAL** and the microphone [**UP**]/[**DWN**] keys can be changed.

Note: See Setup Menu Item “**35 STEP**” on page 30

Basic Operation

Transmission

1. Press and hold **PTT** on the microphone.
Both the upper and lower portions of the PTT mode/status indicator light red.

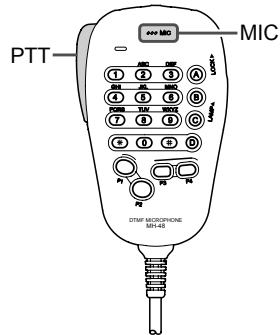

Both the upper and lower portions light red

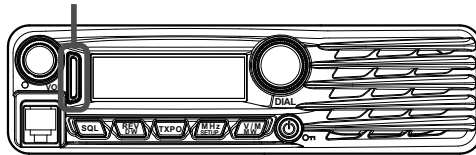

2. Speak into **MIC** on the microphone.
Note: Keep the microphone about 5 cm away from your mouth.
The sensitivity (gain) of the microphone can be adjusted. For details, refer to the Advanced Manual (download from the Yaesu website).
3. Release **PTT**.
The transmit mode/status indicator turns off and the transceiver returns to the receive mode.
Caution: Do not continue transmitting for a prolonged period. The transceiver may overheat, resulting in malfunction or injury.
Note: "ERROR" appears if you attempt to transmit on an unavailable frequency.

Adjusting the transmit power

When communicating with a nearby station, the transmit power level may be lowered to reduce the battery power consumption.

1. Press the [TXPO] key.
2. Rotate the **DIAL** to select the transmit power.

Note: The default setting: HIGH

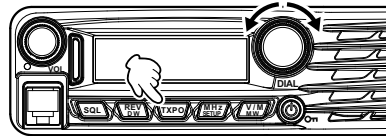

HIGH (65 W)



MID (30 W)



LOW (5 W)

3. Press the [TXPO] key to save the new setting and exit to normal operation.

Lock Feature

To activate the key-lock feature, press the [Power(Lock)] key. The “**On**” icon will appear on the LCD.

To cancel key-lock, press the [Power(Lock)] key again.

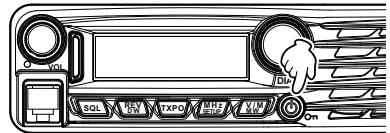

To select which keys are locked, use the Setup Menu Item “**16 LOCK**” see page 30 for details.

Repeater Operation

The FTM-3100R/E includes the ARS (Automatic Repeater Shift) function, which permits communication through repeaters automatically, by simply setting the receiver to the repeater frequency.

1. Tune to the repeater frequency.
2. Press the **PTT** to transmit.

During transmission, radio waves having an 100.0 Hz* tone signal are emitted on the frequency offset from the receive frequency by 0.6 MHz*.

*: Depends on the transceiver version.

Note: From the Setup Menu, you can change the repeater setting.

28 RPT ARS ➡ Deactivates the ARS function.

29 RPT FREQ ➡ Allows changing the repeater shift frequency offset.

30 RPT SFT ➡ Allows setting the repeater shift direction.

Checking the Repeater Uplink (Input) Frequency

It is often helpful to be able to check the uplink (input) frequency of a repeater, to see if the calling station is within direct (“Simplex”) range.

To do this, just press the **[REV(DW)]** key. You’ll notice that the display has shifted to the repeater uplink frequency. Press the **[REV(DW)]** key again to cause operation to revert to normal monitoring of the repeater downlink (output) frequency. While listening on the repeater input frequency using the **[REV(DW)]** key, the repeater offset icon will blink.

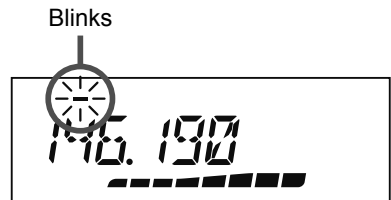

Tone Calling (1750 Hz)

If your transceiver is FTM-3100E (European version), press and hold in the program key **[P4]** of the microphone (MH-48) to generate a 1750 Hz burst tone to access the European repeater. The transmitter will automatically be activated, and a 1750 Hz audio tone will be superimposed on the carrier. Once access to the repeater has been gained, you may release the **[P4]** key, and use the **PTT** for activating the transmitter thereafter.

Weather Broadcast Reception

The FTM-3100R/E includes a unique feature which allows reception of weather broadcasts in the 160 MHz frequency range. Ten standard Weather Broadcast channels are preloaded into a special memory bank.

To listen to a Weather Broadcast Channel (Example: When “WX” is assigned to [P4]):

1. Press the Microphone [P4] button to recall the Weather Broadcast channels.

Note: In the USA model, the [P4] key one of the programmable keys, is assigned (default setting) as the “WX Broadcast” one-touch access key. Please note that if you change/assign another function to the [P4] key, one-touch access to the WX channel will be unavailable.

2. Turn the **DIAL** knob to select the desired Weather Broadcast channel.
3. To scan the other channels for activity, press the Microphone **PTT** switch.
4. To exit to normal operation, press the [P4] button again. Operation will return to the VFO or Memory channel in operation before you began Weather Broadcast operation.

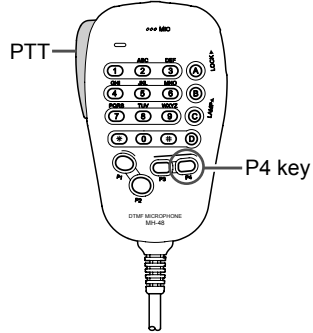

CH	Frequency	CH	Frequency
1	162.550 MHz	6	162.500 MHz
2	162.400 MHz	7	162.525 MHz
3	162.475 MHz	8	161.650 MHz
4	162.425 MHz	9	161.775 MHz
5	162.450 MHz	10	163.275 MHz

Severe Weather Alert Feature

In the event of extreme weather disturbances, such as storms and hurricanes, NOAA (the National Oceanic and Atmospheric Administration) sends a weather alert accompanied by a 1050 Hz tone and subsequent weather report on one of the NOAA weather channels. You may enable this feature via Setup Menu Item “**42 WX ALERT**” see page 31 for details.

Advanced Operation

CTCSS Operation

This radio is equipped with the CTCSS (Continuous Tone-coded Squelch System) that allows audio to be heard only when receiving signals containing a tone corresponding to the tone squelch menu setting. By matching the CTCSS tone with the partner station in advance, quiet standby monitoring is possible.

1. Press and hold the **[MHz(SETUP)]** key for over one second.

The Setup menu appears.

2. Rotate the **DIAL** knob to select “**SQL TYPE 34**”, then press the **[MHz(SETUP)]** key.
3. Rotate the **DIAL** knob to select “**TSQL**”, then press and hold the **[MHz(SETUP)]** key for over one second.

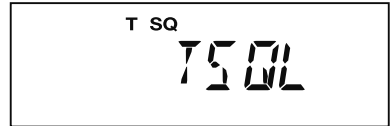

“**T SQ**” is displayed on the screen. Now the squelch opens only when receiving tone signals of the set frequency.

Note: From the Setup Menu, you can change the CTCSS setting.

37 TONE FRQ ➡ The tone frequency can be selected from 50 frequencies.

5 BELL ➡ A bell tone (beep) may be set to sound when signals containing a corresponding CTCSS tone are received.

Tone Search

When the CTCSS tone being transmitted by another station is not known, you can tune the radio to the incoming signal and activate tone scan to search for and identify the tone being used.

Note: For details, refer to the Advanced Manual (download from the Yaesu website).

DCS Operation

This radio is equipped with a DCS (Digital Coded Squelch) function that allows audio to be heard only when signals containing the corresponding DCS code are received. By matching the DCS code with the partner stations beforehand, a quiet receive standby is possible.

1. Press and hold the **[MHz(SETUP)]** key for over one second.

The Setup menu appears.

2. Rotate the **DIAL** knob to select “**SQL TYPE 34**”, then press the **[MHz(SETUP)]** key.
3. Rotate the **DIAL** knob to select “**DCS**”, then press and hold the **[MHz(SETUP)]** key for over one second.

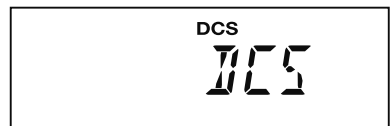

Displays “**DCS**” on the screen. The squelch opens only when receiving a signal containing the corresponding DCS code.

Note: From the Setup Menu, you can change the DCS setting.

8 DCS CODE ➡ The DCS code can be selected from 104 codes.

5 BELL ➡ A bell tone (beep) may be set to sound when signals containing a corresponding DCS code are received.

DCS Search

When the DCS code being transmitted by another station is not known, you can tune the radio to the incoming signal and activate DCS code scan to search for and identify the DCS code being used.

Note: For details, refer to the Advanced Manual (download from the Yaesu website).

The following features are also available:

EPCS (Enhanced Paging & Code Squelch) Operation

Use the pager code consisting of two CTCSS tones to exchange communications with specified stations.

Note: For details, refer to the Advanced Manual (download from the Yaesu website).

Split Tone Operation

The FTM-3100R/E can be operated in a “Split Tone” configuration that enables operation on repeaters using a mix of both CTCSS and DCS control via the Setup menu.

Note: For details, refer to the Advanced Manual (download from the Yaesu website).

DTMF Operation

DTMF tones (Dual Tone Multi Frequencies) are the tones you hear when dialing from a telephone keypad. The FTM-3100R/E transceiver can transmit the DTMF codes by using the keys on the microphone or recalling registered number strings from memories.

The maximum of 16-digit DTMF codes can be registered in up to 10 memory channels.

It is convenient to register telephone patch numbers, and network linking sequences to the DTMF memory channels.

Note: For details, refer to the Advanced Manual (download from the Yaesu website).

Memory Operation

The FTM-3100R/E provides a wide variety of memory system resources. These include:

- 199 “basic” memory channels, numbered “1” through “199”.
- A “Home” channel, providing storage and quick recall of one prime frequency.
- 10 sets of band-edge memories, also known as “Programmable Memory Scan” channels, labeled “L0/U0” through “L9/U9”.

Each memory may be appended with an alphanumeric label of up to 8 characters, for quick channel recognition.

Memory Storage

1. In the VFO mode, select the desired frequency, repeater shift, CTCSS/DCS tone, and TX power level.
2. Press and hold the [V/M(MW)] key for one second.

A memory number will appear in the bottom right corner of the display.

Note: If the channel number is blinking, there currently is no data stored on that channel; if the channel number is not blinking, that channel is currently “occupied” by other frequency data.

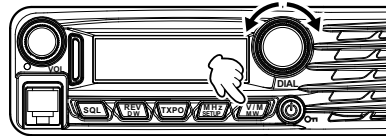

3. Within five seconds of pressing the [V/M(MW)] key, use the **DIAL** knob to select the desired memory into which you wish to store the frequency.

Note: While operating in the Memory Storage mode, the keypad of the MH-48A6JA Microphone may be used to enter the memory channel number directly.

To do this, enter the desired Channel Number on the keypad and then press the [#] key. Refer to the “For example” of the “Memory Recall from the Microphone Keypad” on next page.

4. Press the [V/M(MW)] key again, this time momentarily, to store the displayed data into the selected memory channel slot.
5. To store additional frequencies, repeat steps 1 through 4, remembering to set the repeater shift, CTCSS/DCS tone, and TX power level, as appropriate.

Split Memory

A separate transmit frequency may be registered to a memory channel to which a receive frequency has already been registered.

Note: For details, refer to the Advanced Manual (download from the Yaesu website).

Naming a Memory Channel

You may also append an alphanumeric “Tag” (label) to each memory, to aid in recollection of the channel’s use (such as club name, etc.).

Note: For details, refer to the Advanced Manual (download from the Yaesu website).

Memory Recall

Once the desired frequencies are stored into memory channels, switch from the “VFO” mode to the “Memory Recall” mode, to operate on the just-stored memory channels.

1. Press the [V/M(MW)] key, repeatedly if necessary, until the “MR” icon and a memory channel number appear on the display; this indicates that the “Memory Recall” mode is now engaged.
2. When more than one memory has been stored, use the **DIAL** knob to select any of the programmed memories for operation.

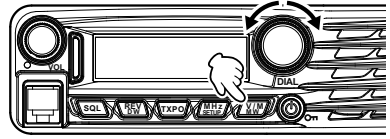

Note: Alternatively, the microphone [UP] or [DWN] button may be used to step or scan through the available memories. When using the microphone buttons, press the button momentarily to move one step up or down; press and hold the [UP] or [DWN] button for one second to begin memory scanning.

Memory Recall from the Microphone Keypad

While operating in the Memory Recall mode, the keypad of the MH-48A6JA Microphone may be used for direct recall of memory channels.

To do this, enter the desired Channel Number on the keypad and then press the [#] key.

For example:

To recall Memory Channel “5”, press [5] ➡ [#]

To recall Memory Channel “123”, press [1] ➡ [2] ➡ [3] ➡ [#]

You may also recall Programmable Memory Scan (PMS) channels (“L0/U0” through “L9/U9”) by entering the channel numbers listed in the below table:

L1	201	L3	205	L5	209	L7	213	L9	217
U1	202	U3	206	U5	210	U7	214	U9	218
L2	203	L4	207	L6	211	L8	215	L0	219
U2	204	U4	208	U6	212	U8	216	U0	220

Moving Memory Data to the VFO

Data stored on memory channels can easily be moved to the VFO.

Note: For details, refer to the Advanced Manual (download from the Yaesu website).

Memory Only Mode

Once memory channel programming has been completed, you may place the radio in a “Memory Only” mode, whereby VFO operation is impossible.

Note: For details, refer to the Advanced Manual (download from the Yaesu website).

Memory Operation

Masking Memories

There may be situations where you want to “Mask” memories so they are not visible during memory selection or scanning. (except for Memory Channel “1”, the Priority Channel, and the Home Channel).

1. In the Memory Recall mode, press and hold the [V/M(MW)] key for one second, then rotate the **DIAL** knob to select the memory channel you wish to mask.
2. Press the [SQL] key.
The erase confirmation screen appears.
3. Press the [SQL] key.
The previously selected memory will be “masked”.

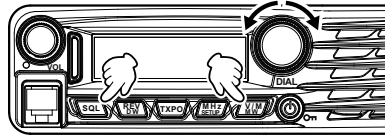

Note: Press any key, other than [SQL], to cancel the memory mask.

Unmasking Memories

1. To Unmask a hidden memory, in the Memory Recall mode, press and hold the [V/M(MW)] key for one second.
2. Rotate the **DIAL** knob to select the masked memory number.
3. Press the [SQL] key to restore the memory channel data.

HOME Channel Memory

A convenient one-touch “Home” channel memory is available to simplify returning to an often used frequency.

To recall the Home channel, just press the [V/M(MW)] key, repeatedly if necessary, until the “**HM**” icon appears on the display; this indicates that the Home Channel has been recalled.

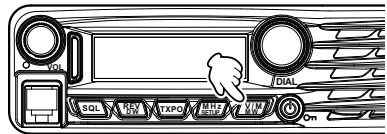

Note: When shipped from the factory, the Home Channel is set to 146.520 MHz (USA version) or 145.000 MHz (EXP/ European version).

Changing the frequency of the home channel

The default frequency setting of the home channel can be changed.

1. In the VFO mode, tune to the desired Home channel frequency.
2. Press and hold the [V/M(MW)] key for one second, and then press the [REV(DW)] key.
The overwrite confirmation screen appears.
3. Press the [REV(DW)] key.
The home channel frequency is overwritten.

Basic Scanner Operation

Before activating the scanner, make sure that the Squelch is set to silence the background noise when no signal is present. Scanning is not possible while the Squelch is open (if noise or signals are being heard).

Scanning may be started or stopped using the microphone **[UP]** or **[DWN]** button.

The following techniques are used for scanning:

- in the **VFO mode**, press and hold either the **[UP]** or **[DWN]** button for one second, to start upward or downward scanning of the band.
- In the **Memory mode**, press and hold either the **[UP]** or **[DWN]** button for one second to start channel scanning toward a higher or lower-numbered memory channel, respectively.

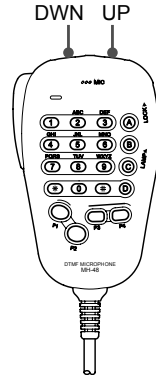

- Scanning pauses when a signal opens the squelch, and the decimal point on the display will blink. You can choose one of three scan-resume modes (described later).
- To halt the scan manually, the easiest way is to push the **PTT** switch on the microphone momentarily (no transmission will occur while you are scanning). The scan may also be halted manually by pressing the microphone **[UP]** or **[DWN]** button, or the **[V/M(MW)]** key.

Scan Resume Options

Select which of the three resume scan modes is to be performed after the scanning stops.

Note: For details, refer to the Advanced Manual (download from the Yaesu website).

Memory Skip Scanning

Memory channels which you do not want to receive can be skipped during scanning.

Note: For details, refer to the Advanced Manual (download from the Yaesu website).

Preferential Memory Scan

Set up a "Preferential Scan List" of channels which you can "flag" within the memory system.

Note: For details, refer to the Advanced Manual (download from the Yaesu website).

Programmable Memory Scan (PMS)

Using the dedicated PMS memory channels, only the frequencies within the specified frequency range will be scanned.

Note: For details, refer to the Advanced Manual (download from the Yaesu website).

Priority Channel Scanning (Dual Watch)

Scanning features include a two-channel scanning capability which allows you to operate on a VFO, Memory channel, or Home channel, while periodically checking a user defined Memory Channel for activity.

Note: For details, refer to the Advanced Manual (download from the Yaesu website).

Reset Procedure/Clone

Reset Procedure

In some instances of erratic or unpredictable operation, the cause may be corruption of data in the microprocessor (due to static electricity, etc.). If this happens, resetting the microprocessor may restore normal operation. Note that all memories will be erased if you do a complete microprocessor reset, as described below.

Microprocessor Resetting

To clear all memories and other settings to factory defaults:

1. Turn the radio OFF.
2. Press and hold the [TXPO], [MHz(SETUP)], and [V/M(MW)] keys while turning the radio on. The “ALL RESET PUSH V/M KEY” notation will scroll on the display.



ALL RESET PUSH V/M KEY

3. Press the [V/M(MW)] key momentarily to reset all settings to their factory defaults (press any other key to cancel the Reset procedure).

Set Mode Resetting

To reset the Set (Menu) mode settings to their factory defaults, while leaving other settings unchanged:

1. Turn the radio OFF.
2. Press and hold the [TXPO] and [MHz(SETUP)] keys while turning the radio on. The “SET MODE RESET PUSH V/M KEY” notation will scroll on the display.



SET MODE RESET PUSH V/M KEY

3. Press the [V/M(MW)] key momentarily to reset the Set (Menu) mode settings to their factory defaults (press any other key to cancel the Reset procedure).

Clone

The FTM-3100R/E includes a convenient “Clone” feature, which allows the memory and configuration data from one transceiver to be transferred to another FTM-3100R/E.

This can be particularly useful when configuring a number of transceivers for a public service operation.

Note: For details, refer to the Advanced Manual (download from the Yaesu website).

Programming the Key Assignments

Default FTM-3100R/E key functions have been assigned to the Microphone [P1]/[P2]/[P3]/[P4] keys at the factory. The user may change these key function assignments, if quick access to another function is desired.

Note: For details, refer to the Advanced Manual (download from the Yaesu website).

Keyboard Beeper

A key/button beeper provides useful audible feedback whenever a key/button is pressed. If you want to turn the beeper off (or back on again).

Note: If you want to turn the beeper off (or back on again), see Setup Menu Item “**3 BEP KEY**” on page 29.

Display Brightness

You can adjust the display brightness.

Note: See Setup Menu Item “**15 LCD DMMR**” on page 30.

Time-Out-Timer (TOT)

The “Time-Out Timer” (TOT) feature is designed to force the transceiver into the “receive” mode after a preset time period of continuous transmission (the default is 3 minutes).

Note: See Setup Menu Item “**38 TOT**” on page 30.

Automatic Power Off (APO)

The “Automatic Power-Off” (APO) feature will turn the radio completely off after a user defined period of PTT or key/button inactivity.

Note: See Setup Menu Item “**1 APO**” on page 29.

Busy Channel Lock-Out (BCLO)

The BCLO feature prevents the transmitter from being activated whenever a signal strong enough to break through the “noise” squelch is present on the frequency.

Note: See Setup Menu Item “**2 BCLO**” on page 29.

TX Deviation Level

You can reduce the receiver bandwidth and transmit deviation when operating on closely spaced frequencies (channel spacing of 12.5 or 15 kHz). The reduced transmitter deviation will minimize adjacent channel interference to other users.

Note: See Setup Menu Item “**44 W/N DEV**” on page 31.

MIC Gain Setting

At the factory, the microphone gain has been programmed so that it should be satisfactory for the supplied MH-48A6JA Microphone. If you use an after-market microphone or connect a TNC, you may wish to set a different Mic Gain level.

Note: See Setup Menu Item “**17 MIC GAIN**” on page 30.

Miscellaneous Settings

Displaying the Supply Voltage

Display the Power Supply voltage.

Note: See Setup Menu Item “**7 DC VOLT**” on page 29.

Displaying the Temperature

Indicates the current temperature inside the transceiver.

Note: See Setup Menu Item “**36 TEMP**” on page 30.

Band Edge Beeper

The FTM-3100R/E will automatically “beep” when the receiver’s band edge is encountered during scanning (either in standard VFO scanning or during PMS operation). You may additionally enable this feature (band edge beeper) when the frequency reaches the band edge while selecting the VFO frequency manually, using the **DIAL** knob.

Note: For details, refer to the Advanced Manual (download from the Yaesu website).

Setup (Menu) Mode

The FTM-3100R/E Setup (Menu) mode, already described in parts of many previous chapters, is easy to activate and setup. The Menus may be used to configure many of transceiver parameters, some of which have not been detailed previously. Use the following procedure to activate the Setup (Menu) mode:

1. Press and hold the **[MHz(SETUP)]** key for one second to enter the Setup menu.
2. Rotate the **DIAL** knob to select the Menu Item to be adjusted.
3. Press the **[MHz(SETUP)]** key momentarily to enable adjustment of the selected Menu item, and then rotate the **DIAL** knob to perform the actual adjustment.
4. After completing your selection and adjustment, press and hold the **[MHz(SETUP)]** key for one second to exit the Setup menu and resume normal operation.

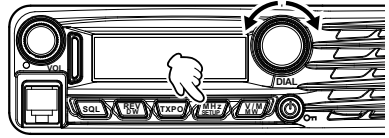

Note: For details, refer to the Advanced Manual (download from the Yaesu website).

Menu Item	Function	Available Values	Default
1: APO	Enables/Disables the Automatic Power Off feature.	0.5H to 12H (0.5H step)/ OFF	OFF
2: BCLO	Enables/Disables the Busy Channel Lock-Out feature.	ON/OFF	OFF
3: BEP KEY	Enables/Disables the key beeper.	KEY+SCAN/KEY/OFF	KEY+SCAN
4: BEP EDGE	Enables/Disable the Band-edge beeper while scanning.	ON/OFF	OFF
5: BELL	Selects the CTCSS/DCS/EPCS Bell Ringer repetitions.	1 to 20/CONTINUE/OFF	OFF
6: CLK TYPE	Shifting of the CPU clock frequency.	A/B	A
7: DC VOLT	Indicates the DC Supply Voltage.	---	---
8: DCS CODE	Setting of the DCS code.	104 standard DCS codes	023
9: DCS INV	Select a combination of DCS inversion codes in terms of communication direction.	NORMAL / INVERT / BOTH	NORMAL
10: DT AUTO	Enables/Disables the DTMF Autodialer feature.	MANUAL/AUTO	MANUAL
11: DT DELAY	Setting of the DTMF Autodialer TX Delay Time.	50/250/450/750/1000	450 MS
12: DT SET	Loading of the DTMF Autodialer Memories.	---	---
13: DT SPEED	Setting of the DTMF Autodialer Sending Speed.	50/100	50 MS
14: DW RVRT	Enables/Disables the "Priority Channel Revert" feature.	ON/OFF	OFF

Setup (Menu) Mode

Menu Item	Function	Available Values	Default
15: LCD DMMR	Setting of the front panel display illumination level.	LEVEL 1/2/3/4	LEVEL 4
16: LOCK	Selects the Control Locking Lockout combination.	KEY + DIAL / PTT / KEY+PTT/DIAL+PTT / ALL/KEY/DIAL	KEY+DIAL
17: MIC GAIN	Adjust the microphone gain level.	LEVEL 1 to 9	LEVEL 5
18: MEM NAME	Programming an Alpha/Numeric label for a Memory Channel.	---	---
19: MW MODE	Selects the method of selecting of channels for Memory Storage.	NEXT CH/LOWER CH	NEXT CH
20: OPEN MSG	Selects the Opening Message that appears when the radio is powered ON.	OFF/DC/MESSAGE	MESSAGE
21: PAG CD-R	Setting the Receiver Pager Code for the Enhanced CTCSS Paging & Code Squelch function.	---	05 47
22: PAG CD-T	Setting the Transmitting Pager Code for the Enhanced CTCSS Paging & Code Squelch function.	---	05 47
23: PRG P1	Programming the function assigned to Microphone [P1] key.	SQL OFF HOME WX CH CD SRCH SCAN T CALL TX POWER Setup Menu Item #1 to 44	SQL OFF
24: PRG P2	Programming the function assigned to Microphone [P2] key.		HOME
25: PRG P3	Programming the function assigned to Microphone [P3] key.		CD SRCH
26: PRG P4	Programming the function assigned to Microphone [P4] key.		※
27: RF SQL	Adjusts the RF Squelch threshold level.	OFF/S1 to S8	OFF
28: RPT ARS	Activates/Deactivates the Automatic Repeater Shift feature.	ON/OFF	ON
29: RPT FREQ	Sets the magnitude of the Repeater Shift.	0.00 - 150.00 (MHz)	0.60 MHz
30: RPT SFT	Sets the Repeater Shift direction.	-RPT/+RPT/SIMPLEX	SIMPLEX
31: SCAN RSM	Selects the Scan Resume mode.	BUSY/HOLD/2-10 (SEC)	5.0 SEC
32: SCAN SKP	Selects the Memory Scan mode.	OFF/SKIP/SELECT	OFF
33: SQL EXP	Sets the squelch type separately for transmission and reception.	ON/OFF	OFF
34: SQL TYPE	Selects the Tone Encoder and/or Decoder mode.	TONE/TSQL/DCS/ RV TONE/PAGER/OFF	OFF
35: STEP	Sets the frequency synthesizer steps.	AUTO/5/6.25/10/12.5/15/ 20/25/50/100 (kHz)	AUTO
36: TEMP	Indicates the current temperature inside the transceiver.	---	---
37: TONE FRQ	Setting of the CTCSS Tone Frequency.	67.0 to 254.1 (Hz)	100.0 HZ
38: TOT	Sets the Time-Out Timer.	0.5 to 10.0 (MIN)/OFF	3.0 MIN

※: Depends on the transceiver version.

Setup (Menu) Mode

Menu Item	Function	Available Values	Default
39: TS MUTE	Enables/Disables the receiver audio output while the Tone Search or DCS Search Scanner is activated.	ON/OFF	ON
40: TS SPEED	Selects the Tone Search or DCS Search Scanner speed.	FAST/SLOW	FAST
41: VER DISP	Displays the transceiver software version	CPU x.xx	---
42: WX ALERT	Enables/Disables the Weather Alert feature.	ON/OFF	OFF
43: WX VOL	Selects the audio output level of the Weather Alert.	NOR VOL/MAX VOL	NOR VOL
44: W/N DEV	Reduction of the Microphone Gain/Deviation and receiver bandwidth.	WIDE/NARROW	WIDE

Care and maintenance

Turn the power OFF before wiping away any dust and stains on the transceiver with a dry soft cloth. For stubborn stains, slightly moisten a soft cloth and wring it out before using it to wipe away the stains.

Caution: Never use washing detergents and organic solvents (thinner, benzene, etc.). Doing so may result in paint flaking or damage to the transceiver finish.

Replacing the fuse

When the fuse of the DC power supply cable blows and the transceiver becomes inoperable, correct the cause of the problem, and then replace the fuse with a new one of the correct rating (USA version: 25 Amp, EXP/European version: 20 Amp).

Caution: When replacing the fuse, be sure to disconnect the power supply cable from the transceiver and from the external DC power supply.

Replacing the fuse of the DC power supply cable

1. Prepare a new fuse.

Use a fuse with a rating of 25 A or 20 A.

Caution: Never attempt to use a fuse that is not of the specified rating.

USA version: 25 Amp

EXP/European version: 20 Amp

2. Open the fuse holder as shown in the diagram on the right.
3. Remove the blown fuse.
4. Attach the new fuse.
5. Close the fuse holder.

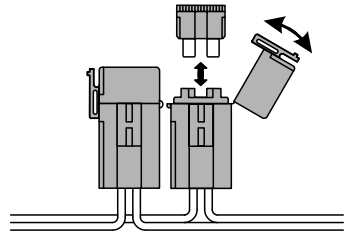

Disposal of your Electronic and Electric Equipment

Products with the symbol (crossed-out wheeled bin) cannot be disposed as household waste.

Electronic and Electric Equipment should be recycled at a facility capable of handling these items and their waste by products.

In EU countries, please contact your local equipment supplier representative or service center for information about the waste collection system in your country.



General

Frequency Range:	Tx 144 - 146 MHz or 144 - 148 MHz Rx 136 - 174 MHz
Channel Step:	5/6.25/10/12.5/15/20/25/50/100 kHz
Standard Repeater Shift:	±600 kHz
Frequency Stability:	±10 ppm [-4 °F to +140 °F (-20 °C to +60 °C)]
Modes of Emission:	F3E
Antenna Impedance:	50 Ohms, unbalanced
Supply voltage:	13.8 V DC ±15%, negative ground
Current Consumption (typical):	Rx: less than 0.7 A, less than 0.5 A (squelched) Tx: 15 A (65 W) /10 A (30 W) /5 A (5 W)
Operating Temperature Range:	-4° F to +140° F (-20° C to +60° C)
Case Size (WxHxD):	6.1" x 1.7" x 6.1" (154 x 43 x 155 mm) (w/o knobs)
Weight (Approx.):	2.86 lb (1.3 kg)

Transmitter

Output Power:	65/30/5 W
Modulation Type:	Variable Reactance
Maximum Deviation:	±5 kHz (Wide) ±2.5 kHz (Narrow)
Spurious Radiation:	Better than -60 dB Better than -61.1 dB (European version, 65 W)
Microphone Impedance:	2k Ohms

Receiver

Circuit Type:	Double Conversion Superheterodyne
Iffs:	1st 47.25 MHz, 2nd 450 kHz
Sensitivity (for 12dB SINAD):	0.20 µV (Ham band, wide) 0.22 µV (Ham band, narrow)
Selectivity (-6/-60dB):	12 kHz/28 kHz
Maximum AF Output:	3 W @ 13.8 V, 10% THD

Rated values are at normal temperature and pressure.
Ratings and specifications are subject to change without notice.

Attention in case of use

This transceiver works on frequencies which are not generally permitted.

As for the actual usage, the user has to possess an amateur radio licence.

Usage is allowed only in the frequency bands which are allocated for amateur radios.

List of national codes					
AT	BE	BG	CY	CZ	DE
DK	ES	EE	FI	FR	GB
GR	HR	HU	IE	IT	LT
LU	LV	MT	NL	PL	PT
RO	SK	SI	SE	CH	IS
LI	NO	-	-	-	-

1. Changes or modifications to this device that are not expressly approved by YAESU MUSEN could void the user's authorization to operate this device.
2. This device complies with part 15 of the FCC Rules. Operation is subject to the following two conditions: (1) This device may not cause harmful interference, and (2) this device must accept any interference including received, interference that may cause undesired operation.
3. The scanning receiver in this equipment is incapable of tuning, or readily being altered, by the User to operate within the frequency bands allocated to the Domestic public Cellular Telecommunications Service in Part 22.

This device complies with Industry Canada license-exempt RSS standard(s). Operation is subject to the following two conditions: (1) this device may not cause interference, and (2) this device must accept any interference, including interference that may cause undesired operation of the device.

Le présent appareil est conforme aux CNR d'Industrie Canada applicables aux appareils radio exempts de licence. L'exploitation est autorisée aux deux conditions suivantes : (1) l'appareil ne doit pas produire de brouillage, et (2) l'utilisateur de l'appareil doit accepter tout brouillage radioélectrique subi, même si le brouillage est susceptible d'en compromettre le fonctionnement.

DECLARATION BY MANUFACTURER

The Scanner receiver is not a digital scanner and is incapable of being converted or modified to a digital scanner receiver by any user.

WARNING: MODIFICATION OF THIS DEVICE TO RECEIVE CELLULAR RADIOTELEPHONE SERVICE SIGNALS IS PROHIBITED UNDER FCC RULES AND FEDERAL LAW.

CAN ICES-3 (B) / NMB-3 (B)

This equipment has been tested and found to comply with the limits for a Class B digital device, pursuant to part 15 of the FCC Rules. These limits are designed to provide reasonable protection against harmful interference in a residential installation. This equipment generates uses and can radiate radio frequency energy and, if not installed and used in accordance with the instructions, may cause harmful interference to radio communications. However, there is no guarantee that interference will not occur in a particular installation.

If this equipment does cause harmful interference to radio or television reception, which can be determined by turning the equipment off and on, the user is encouraged to try to correct the interference by one or more of the following measures:

- Reorient or relocate the receiving antenna.
- Increase the separation between the equipment and receiver.
- Connect the equipment into an outlet on a circuit different from that to which the receiver is connected.
- Consult the dealer or an experienced radio/TV technician for help.

Declaration of Conformity

Nr. YUK-DOC-0304-16

We, Yaesu UK Ltd. certify and declare under our sole responsibility that the following equipment complies with the essential requirements of the Directive 1999/5/EC and 2011/65/EU.

Type of Equipment	VHF Digital/Analogue and VHF Analogue Transceiver
Brand Name	YAESU
Model Number	FTM-3200DE / FTM-3100E
Manufacturer	YAESU MUSEN CO. LTD.
Address of Manufacturer	Tennozu Parkside Building, 2-5-8 Higashi-Shinagawa, Shinagawa-ku, Tokyo, 140-0002 Japan

Applicable Standards:

This equipment is tested to and conforms to the essential requirements of directive, as included in following standards:

Health 1999/5/EC Art. 3 (1) (a)	EN 62311:2008
Safety 1999/5/EC Art. 3 (1) (a)	EN 60950-1:2006 + A2:2013
EMC 1999/5/EC Art 3 (1) (b)	EN 301 489-01 V1.9.2 EN 301 489-15 V1.2.1 EN 50498:2010
Radio Spectrum 1999/5/EC Art 3 (2)	EN 301 783-02 V1.2.1
ROHS2 2011/65/EU Art. 7 (b)	EN 50581:2012

The technical documentation as required by the Conformity Assessment procedures is kept at the following address:

Company
Address
Technical Construction file

Yaesu UK Ltd
Unit 12, Sun Valley Business Park, Winnall Close

Winchester, Hampshire UK SO23 0LB
Issued by: Yaesu Musen Co. Ltd, Tokyo Japan
File No: YETA00410
Drawn up in: Winchester, Hampshire UK
Date: 23rd March 2016



Signed for and on behalf of Yaesu UK Ltd

Name and position:
Technical Sales Manager

PCJ Bigwood

YAESU

The radio

Copyright 2016
YAESU MUSEN CO., LTD.
All rights reserved.
No portion of this manual may be
reproduced without the permission of
YAESU MUSEN CO., LTD.

YAESU MUSEN CO., LTD.
Tennozu Parkside Building
2-5-8 Higashi-Shinagawa, Shinagawa-ku, Tokyo 140-0002 Japan

YAESU USA
6125 Phyllis Drive, Cypress, CA 90630, U.S.A.

YAESU UK
Unit 12, Sun Valley Business Park, Winnall Close
Winchester, Hampshire, SO23 0LB, U.K.



1606D-DO
Printed in Japan

