

# YAESU

**HF/50 MHz TRANSCEIVER**

**FTDX5000 SERIES**

**OPERATING MANUAL**



**VERTEX STANDARD CO., LTD.**

4-8-8 Nakameguro, Meguro-Ku, Tokyo 153-8644, Japan

**VERTEX STANDARD U.S.A. Inc.**

6125 Phyllis Drive, Cypress, California 90630, U.S.A.

**YAESU UK LTD.**

Unit 12, Sun Valley Business Park, Winnall Close  
Winchester, Hampshire, SO23 0LB, U.K.

**VERTEX STANDARD HK LTD.**

Unit 1306-1308, 13F., Millennium City 2, 378 Kwun Tong Road,  
Kwun Tong, Kowloon, Hong Kong

**VERTEX STANDARD (AUSTRALIA) PTY., LTD.**

Tally Ho Business Park, 10 Wesley Court, East Burwood, VIC, 3151

---

---

## ABOUT THIS MANUAL . . .

---

---

The **FTDx5000** is a leading-edge transceiver with a number of new and exciting features, some of which may be unfamiliar to you. In order to gain the most enjoyment and operating efficiency from your **FTDx5000**, we recommend that you read this manual in its entirety, and keep it handy for reference as you explore the many capabilities of your new transceiver.

This operating manual is the common manual to the **FTDx5000**, **FTDx5000D**, and **FTDx5000MP**. Before using your **FTDx5000**, be sure to read and follow the instructions in the “Before You Begin” section of this manual.

Congratulations on your purchase of the **FTdx5000** Yaesu amateur transceiver!

Whether this is your first rig, or Yaesu equipment is already the backbone of your station, rest assured this transceiver will provide many hours of operating pleasure for years to come.

The **FTdx5000** is an elite-class HF transceiver and will provide exceptional transmit and receive performance. The **FTdx5000** is designed for the most competitive operating situations, whether you operate in contests, DX, or digital-mode environments.

Built on the foundation of the popular **FTdx9000** transceiver, and carrying on the proud tradition of the **FT-1000** series, the **FTdx5000** provides up to 200 Watts of power output on SSB, CW, and FM (50 Watts AM carrier). Digital Signal Processing (DSP) is utilized throughout the design, providing leading edge performance on both transmit and receive.

Available as an option, the **DMU-2000** Data Management Unit will provide extensive display capabilities via a user-supplied computer monitor: Band Scope, Audio Scope, X-Y Oscilloscope, World Clock, Rotator Control, extensive transceiver status displays, and station logging capability.

The Yaesu-exclusive VRF (Variable RF Front-End Filter) provides exceptional protection from strong nearby signals, and serves as a high-performance Preselector, ideal for multi-operator contest environments. The filter is manually tuned, allowing the operator to optimize sensitivity or signal rejection with the turn of a knob. For the ultimate in receiver RF selectivity, the optional RF  $\mu$ -Tuning Kits may be connected via the rear panel, providing extraordinarily sharp selectivity and receiver protection from close-in interference on a crowded band.

Superb receiver performance is a direct legacy from the legendary **FTdx9000**, **FT-1000D**, and **FT-1000MP** transceivers. In the VFO-A receive front end, you may select one of two RF preamplifiers, or one of two IPO (Intercept Point Optimization) settings, and/or three levels of RF attenuation in 6-dB steps. The IPO settings provide direct feed to the first mixer (VFO-B has one IPO setting), Dual Receives are built into every **FTdx5000**. Both VFO-A and VFO-B receivers utilize DSP filtering, and incorporate many of the features of the **FTdx9000**, such as Variable Bandwidth, IF Shift, and Passband Contour tuning. Digital Noise Reduction and Digital Auto-Notch Filtering are also provided, along with a manually-tuned IF Notch filter. The Sub receiver, used for monitoring within the same band as the Main receiver, is ideal for watching both sides of a pile-up, or keeping an ear on a DX station that is working stations by call area, etc.

On the transmit side, the Yaesu-exclusive Three-Band Parametric Microphone Equalizer allows precise and flexible adjustment of the wave-form to complement your voice. The microphone Amplitude, Center Frequency, and Bandwidth may be adjusted independently for the low-frequency, mid-range, and high-audio-frequency spectra. The transmitted bandwidth may be adjusted, as well.

Advanced features include: Direct Keyboard Entry of frequency and Band Change, Speech Processor, IF Monitor for Voice modes, CW Pitch control, CW Spot switch, Full CW

QSK, adjustable IF Noise Blanker, and all-mode Squelch. Four TX/ RX antenna ports, plus a receive-only antenna port, are provided on the rear panel. The front and rear key jacks may be configured independently, for paddle input, connection to a straight key, or computer-driven keying interface. Both Digital Voice Recording and CW Message Memory are provided.

Three unique windows on the right side of the front panel, display the VFO-B frequency and graphically show the VFO-A and VFO-B DSP settings. In Menu Mode operation, these windows display the menu values, for easy setting.

Set up of frequency, band and mode is especially convenient on the **FTdx5000**. Besides direct frequency entry for both the Main and Sub VFOs, separate keys are provided for band selection. Each band key accesses three independent VFO frequency/mode/filter settings per band. You can establish separate VFO settings for three different parts of each band. The two (Main and Sub) VFOs allow simultaneous reception and display of two different frequencies, even in different modes and with different IF bandwidths. The Dual Receiver audio can be combined, or partially mixed in each headphone, or monitored separately in each ear.

In addition, 99 memories are provided to store: frequency, IF filter selection, clarifier offset, and scan-skip status. What's more, five quick-recall ("QMB") memories can instantly store operational settings at the push of a button.

The built-in automatic antenna tuner includes 100 memories of its own, to automatically store antenna matching settings for quick recall later.

Dedicated AFSK and FSK connection jacks on the rear panel provide simple Interfacing for digital modes. Optimization of the Passband filters, DSP settings, carrier insertion point, and display offset are all possible via the Menu programming system.

The Yaesu CAT system provides a direct link to the transceiver CPU for computer control and customization of tuning, scanning, and other operating functions. The **FTdx5000** includes a built-in data level converter for direct connection to a personal computer serial port. Yaesu products are supported by most of the leading contest and DX logging programs. The extensive programming protocol is described in the CAT System, if you wish to write your own software!

Advanced technology is only part of the **FTdx5000** story. Vertex Standard stands behind our products with a worldwide network of dealers and service centers. We greatly appreciate your investment in the **FTdx5000**, and we look forward to helping you get the most enjoyment from your new transceiver.

Please feel free to contact your nearest dealer, or one of Vertex Standard's national headquarters offices, for technical advice, interfacing assistance, or accessory recommendation.

Watch the Vertex Standard U.S.A. Home Page for late breaking information about Vertex, Standard Horizon, and Yaesu products: <http://www.vertexstandard.com>.

Please read this manual thoroughly, to gain maximum understanding of the full capability of the **FTdx5000**. We thank you again for your purchase!

# TABLE OF CONTENTS

<b>General Description</b> .....	1	<b>Advanced Interference-Suppression Features:</b>	
<b>Accessories &amp; Options</b> .....	4	<b>RF Front End</b> .....	54
Supplied Accessories .....	4	Using the VRF (Variable RF Front-end Filter) .....	54
Available Options .....	4	<b>Interference Rejection</b>	
<b>Before You Begin</b> .....	6	<b>(Signals Off Frequency by Just a Few kHz)</b> .....	56
Connecting AC Power .....	6	R.FLT (Roofing Filters) .....	56
Extending the Front Feet .....	6	<b>Interference Rejection (Signals within 3 kHz)</b> .....	58
Adjusting the Main Tuning Dial Torque .....	6	CONTOUR Control Operation .....	58
Resetting the Microprocessor .....	7	IF SHIFT Operation .....	60
Resetting Memories (Only) .....	7	WIDTH (IF DSP Bandwidth) Tuning .....	61
Menu Resetting .....	7	Using IF Shift and Width Together .....	62
Full Reset .....	7	IF Notch Filter Operation .....	63
<b>Installation and Interconnections</b> .....	8	Digital Noise Reduction (DNR) Operation .....	64
Antenna Considerations .....	8	Digital Notch Filter (DNF) Operation .....	64
About Coaxial Cable .....	8	NARROW (NAR) One-Touch IF Filter Selection .....	65
Grounding .....	9	IF Noise Blanker (NB) Operation .....	66
Connection of Antenna and Power Cables .....	10	<b>Tools for Comfortable and Effective Reception</b> .....	67
Connection of Microphone and Headphone .....	11	AGC (Automatic Gain Control) .....	67
Key, Keyer, and Computer-Driven Keying		SLOPED AGC Operation .....	68
Interconnections .....	12	Mute Feature (VFO-A Band) .....	69
VL-1000 Linear Amplifier Interconnections .....	13	Adjustable Receiver Audio Filter .....	69
Interfacing to Other Linear Amplifiers .....	14	<b>SSB/AM Mode Transmission</b> .....	70
<b>Plug/Connector Pinout Diagrams</b> .....	15	<b>Using the Automatic Antenna Tuner</b> .....	72
<b>Front Panel Controls &amp; Switches</b> .....	16	ATU Operation .....	72
<b>Display Indications</b> .....	30	About ATU Operation .....	73
<b>Rear Panel</b> .....	33	<b>Enhancing Transmit Signal Quality</b> .....	74
<b>FH-2 Switches</b> .....	36	Parametric Microphone Equalizer .....	74
<b>Basic Operation: Receiving on Amateur Bands</b> .....	37	Using the Speech Processor .....	76
CLAR (Clarifier) Operation on Main (VFO-A) .....	40	Adjusting the SSB Transmitted Bandwidth .....	77
LOCK .....	41	Low-Distortion CLASS-A Operation .....	78
DIM .....	41	<b>Transmitter Convenience Features</b> .....	80
Operation on 60-Meter (5 MHz) Band		Voice Memory .....	80
(U.S. and U.K. versions only) .....	41	VOX (Automatic TX/RX Switching using Voice Control) .....	81
<b>Convenience Features</b> .....	42	MONITOR .....	81
Dual Receive .....	42	Split Operation Using the TX Clarifier .....	82
Using Headphones for Dual Receive .....	43	Split-Frequency Operation .....	83
Sideband Diversity Reception .....	43	VFO Tracking Feature .....	84
Bandwidth Diversity Reception .....	44	Quick Split Operation .....	85
P.BACK (Audio Playback) from			
Main (VFO-A) Receiver .....	45		
“MY Bands” Operation .....	46		
Band Stack Operation .....	47		
C.S (Custom Switch) .....	47		
Rotator Control Functions .....	48		
More Frequency Navigation Techniques .....	49		
Keyboard Frequency Entry .....	49		
Using the [▲(UP)]/[▼(DOWN)] Buttons .....	49		
Using the UP/DOWN switches of			
the supplied MH-31B8 Hand Microphone .....	49		
Using the [◀]/[▶]/[▲]/[▼] switches of			
the supplied FH-2 Remote Control Keypad .....	49		
Receiver Operation (Front End Block Diagram) .....	50		
IPO (Intercept Point Optimization) .....	51		
ATT .....	52		
RF Gain (SSB/CW/AM Modes) .....	53		



# TABLE OF CONTENTS

<b>CW Mode Operation</b> .....	<b>86</b>	<b>VFO and Memory Scanning</b> .....	<b>107</b>
Setup for Straight Key		VFO Scanning .....	107
(and Straight Key emulation) Operation .....	86	Memory Scan .....	108
Using the Built-in Electronic Keyer .....	88	<b>PMS</b> .....	<b>109</b>
Full Break-in (QSK) Operation .....	89	<b>Packet Operation</b> .....	<b>110</b>
Setting the Keyer Weight		Packet Setup (Including Subcarrier Frequency) ..	110
(Dot/Space:Dash) Ratio .....	90	Basic Setup .....	110
Selecting the Keyer Operating Mode .....	90	<b>RTTY (Radio Teletype) Operation</b> .....	<b>111</b>
<b>CW Convenience Features</b> .....	<b>91</b>	Setting Up for RTTY Operation .....	111
CW Spotting (Zero-Beating) .....	91	Basic Setup .....	111
Using CW Reverse .....	92	<b>Miscellaneous AFSK-Based Data Modes</b> .....	<b>112</b>
Audio Peak Filter .....	92	<b>About the Transverter Output Terminal</b> .....	<b>114</b>
CW Delay Time Setting .....	93	Setup .....	114
CW Pitch Adjustment .....	93	Operation .....	115
Contest Memory Keyer .....	94	<b>Menu Mode</b> .....	<b>116</b>
Message Memory .....	94	Using the Menu .....	116
Transmitting in the Beacon Mode .....	95	Menu Mode Reset .....	116
TEXT Memory .....	96	AGC Group .....	121
Contest Number Programming .....	97	DISPLAY Group .....	121
Decrementing the Contest Number .....	97	DVS Group .....	122
<b>FM Mode Operation</b> .....	<b>98</b>	KEYER Group .....	123
Basic Operation .....	98	GENERAL Group .....	124
Repeater Operation .....	99	MODE-AM Group .....	125
<b>Memory Operation</b> .....	<b>100</b>	MODE-CW Group .....	126
Convenient Memory functions .....	100	MODE-DAT Group .....	127
QMB (Quick Memory Bank) .....	101	MODE-FM Group .....	128
Regular Memory Operation .....	102	MODE-RTY Group .....	128
Memory Storage .....	102	MODE-SSB Group .....	129
Memory Channel Recall .....	102	RX AUDIO Group .....	130
Checking a Memory Channel's Status .....	103	RX GNRL Group .....	130
Erasing Memory Channel Data .....	103	RX DSP Group .....	131
Moving Memory Data to the VFO-A .....	104	SCOPE Group .....	132
Memory Tune Operation .....	104	TUNING Group .....	133
Memory Groups .....	105	TX AUDIO Group .....	134
Memory Group Assignment .....	105	TX GNRL Group .....	136
Choosing the Desired Memory Group .....	105	<b>Specifications</b> .....	<b>138</b>
<b>Operation on Alaska Emergency Frequency:</b>		<b>Installation of the Optional Roofing Filter</b> .....	<b>140</b>
<b>5167.5 kHz (U.S. Version Only)</b> .....	<b>106</b>	<b>Index</b> .....	<b>142</b>
		<b>FCC Notice</b> .....	<b>144</b>

# ACCESSORIES & OPTIONS

---

---

## SUPPLIED ACCESSORIES

---

---

Hand Microphone ( <b>MH-31B8</b> )	1 pc	A07890001
Remote Control Keypad ( <b>FH-2</b> )	1 pc	AAF22X001
AC Power Cord	1 pc	T9017882: USA T9013285: Europe T9013283A: Australia
4-pin DIN Plug	1 pc	P0091004
5-pin DIN Plug	1 pc	P0091006
1/4-inch 3-contact Plug	1 pcs	P0091513
3.5 mm 3-contact Plug	1 pcs	P0091046
3.5 mm 2-contact Plug	1 pcs	P0090034
RCA Plug	2 pcs	P0091365
Operating Manual	1 pc	
Warranty Card	1 pc	
<b>SM-5000</b> Station Monitor	1 pc	( <b>FTDx5000MP</b> and <b>FTDx5000D</b> version only)

---

---

## AVAILABLE OPTIONS

---

---

<b>MD-200A8X</b>	Ultra-High-Fidelity Desk-Top Microphone
<b>YH-77STA</b>	Lightweight Stereo Headphone
<b>SM-5000</b>	Station Monitor (It is attached with <b>FTDx5000MP</b> and <b>FTDx5000D</b> )
<b>SP-2000</b>	External Speaker with Audio Filter
<b>VL-1000/VP-1000</b>	Linear Amplifier/AC Power Supply
<b>DMU-2000</b>	Data Management Unit
<b>RF <math>\mu</math>Tuning Kit A</b>	For 160 m Band
<b>RF <math>\mu</math>Tuning Kit B</b>	For 80/40 m Bands
<b>RF <math>\mu</math>Tuning Kit C</b>	For 30/20 m Bands
<b>XF-126CN</b>	CW Narrow Filter (C/F: 9 MHz, B/W: 300 Hz) (It is installed with <b>FTDx5000MP</b> )
<b>T9101556</b>	Antenna Rotator Connection Cable



# BEFORE YOU BEGIN

## CONNECTING AC POWER

The **FTDx5000** is equipped with a universal power supply supporting 100 V to 264 V AC.

Therefore, the **FTDx5000** will operate on a voltage range from 100V to 264 V without changing a voltage select switch. Just use the power plug that matches your wall outlet.

## EXTENDING THE FRONT FEET

In order to elevate the front panel for easy viewing, the front left and right feet of the bottom case may be extended.

- ① Pull the front legs outward from the bottom panel.
- ② Rotate the legs counter-clockwise to lock them in the extended position. Be sure the legs have locked securely in place, because the transceiver is quite heavy and an unlocked leg could result in damage, should the transceiver move suddenly.

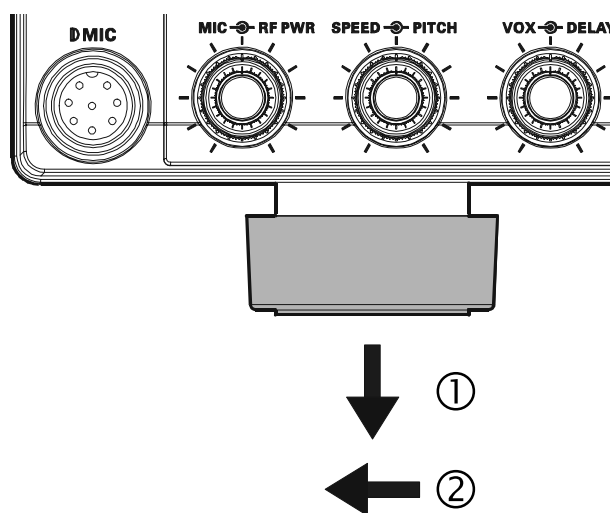

### Retracting the Front Feet

- ① Rotate the legs clockwise, and push them inward while rotating to the right.
- ② The front feet should now be locked in the retracted position.

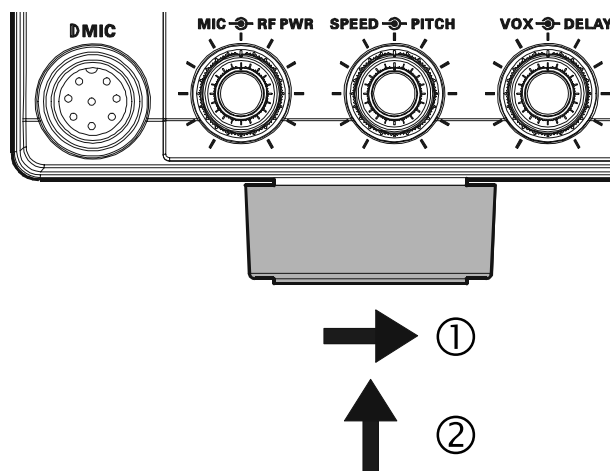

## ADJUSTING THE MAIN TUNING DIAL TORQUE

The torque (drag) of the Main Tuning Dial knob may be adjusted according to your preferences. Simply hold down the rear skirt of the knob, and while holding it in place rotate the knob itself to the right to reduce the drag or to the left to increase the drag.

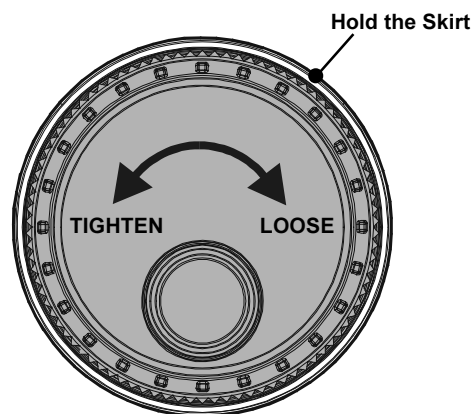

## RESETTING THE MICROPROCESSOR

### RESETTING MEMORIES (ONLY)

Use this procedure to reset (clear out) the previously stored Memory channels, without affecting any configuration changes you may have made to the Menu settings.

1. Press the front panel **[POWER]** switch to turn the transceiver off.
2. Press and hold in the **[A▶M]** button; while holding it in, press and hold in the front panel **[POWER]** switch to turn the transceiver on. Once the transceiver comes on, release the buttons.

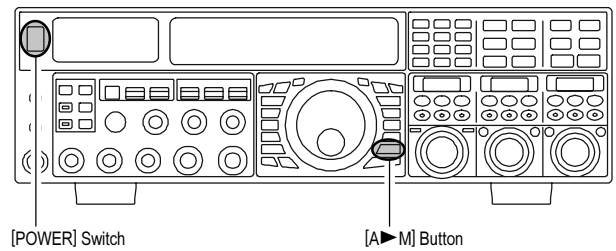

### MENU RESETTING

Use this procedure to restore the Menu settings to their factory defaults, without affecting the memories you have programmed.

1. Press the front panel **[POWER]** switch to turn the transceiver off.
2. Press and hold in the **[MENU]** button; while holding it in, press and hold in the front panel **[POWER]** switch to turn the transceiver on. Once the transceiver comes on, release the buttons.

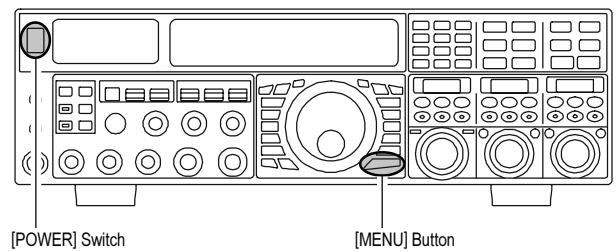

### FULL RESET

Use this procedure to restore all Menu and Memory settings to their original factory defaults. All Memories will be cleared out by this procedure.

1. Press the front panel **[POWER]** switch to turn the transceiver off.
2. Press and hold in the **[FAST]** and **[LOCK]** buttons; while holding them in, press and hold in the front panel **[POWER]** switch to turn the transceiver on. Once the transceiver comes on, release the switches.

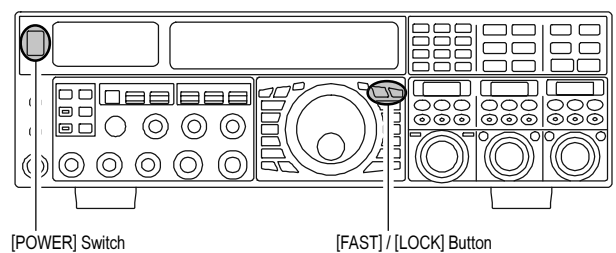

# INSTALLATION AND INTERCONNECTIONS

## ANTENNA CONSIDERATIONS

The **FTDx5000** is designed for use with any antenna system providing a 50 Ohm resistive impedance at the desired operating frequency. While minor excursions from the 50-Ohm specification are of no consequence, if the Standing Wave Ratio (SWR) present at the Antenna jack is greater than 3:1, the Antenna Tuner may not be able to reduce the impedance mismatch to an acceptable value.

It is very important, therefore, to ensure that the impedance of the antenna system utilized with the **FTDx5000** be as close as possible to the specified 50-Ohm value.

Note that the "G5RV" type antenna does not provide a 50-Ohm impedance on all HF Amateur bands, and an external wide range antenna coupler must be used with this antenna type.

Any antenna to be used with the **FTDx5000** must, ultimately, be fed with 50 Ohm coaxial cable. Therefore, when using a "balanced" antenna such as a dipole, remember that a balun or other matching/balancing device must be used to ensure proper antenna performance.

The same precautions apply to any additional (receive-only) antennas connected to the RX ANT jack; if your receive-only antennas do not have an impedance near 50 Ohms at the operating frequency, you may need to install an external antenna tuner to obtain optimum performance.

## ABOUT COAXIAL CABLE

Use high-quality 50-Ohm coaxial cable for the lead-in to your **FTDx5000** transceiver. All efforts at providing an efficient antenna system will be wasted if poor quality, lossy coaxial cable is used. This transceiver utilizes standard "M" ("PL-259") type connectors, except for the "RX OUT" BNC connector.

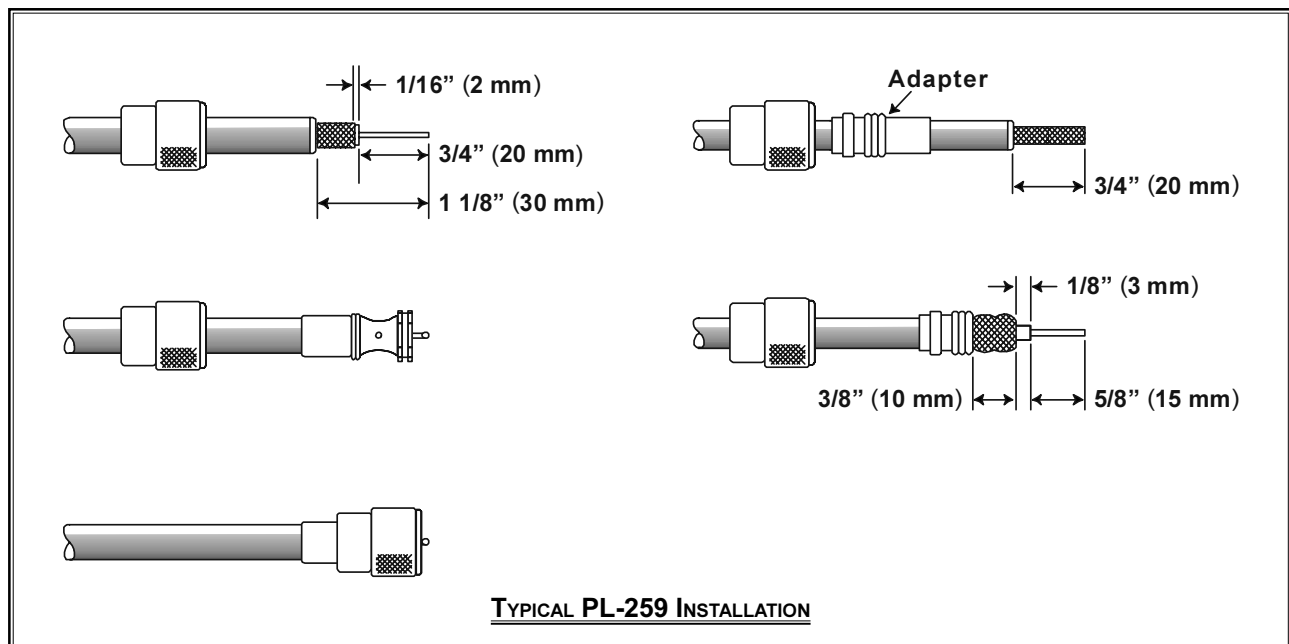

# INSTALLATION AND INTERCONNECTIONS

## GROUNDING

The **FTdx5000** transceiver, like any other HF communications apparatus, requires an effective ground system for maximum electrical safety and best communications effectiveness. A good ground system can contribute to station efficiency in a number of ways:

- ❑ It can minimize the possibility of electrical shock to the operator.
- ❑ It can minimize RF currents flowing on the shield of the coaxial cable and the chassis of the transceiver; such currents may lead to radiation which can cause interference to home entertainment devices or laboratory test equipment.
- ❑ It can minimize the possibility of erratic transceiver/accessory operation caused by RF feedback and/or improper current flow through logic devices.

An effective earth ground system may take several forms; for a more complete discussion, see an appropriate RF engineering text. The information below is intended only as a guideline.

Typically, the ground connection consists of one or more copper-clad steel rods, driven into the ground. If multiple ground rods are used, they should be positioned in a “V” configuration, and bonded together at the apex of the “V” which is nearest the station location. Use a heavy, braided cable (such as the discarded shield from type RG-213 coaxial cable) and strong cable clamps to secure the braided cable(s) to the ground rods. Be sure to weatherproof the connections to ensure many years of reliable service. Use the same type of heavy, braided cable for the connections to the station ground bus (described below).

Inside the station, a common ground bus consisting of a copper pipe of at least 25 mm (1”) diameter should be used. An alternative station ground bus may consist of a wide copper plate (single-sided circuit board material is ideal) secured to the bottom of the operating desk. Grounding connections from individual devices such as transceivers, power supplies, and data communications devices (TNCs, etc.) should be made directly to the ground bus using a heavy, braided cable.

Do not make ground connections from one electrical device to another, and thence to the ground bus. This so-called “Daisy-Chain” grounding technique may nullify any attempt at effective radio frequency grounding. See the drawing below for examples of proper grounding techniques.

Inspect the ground system inside and outside of the station, on a regular basis to ensure maximum performance and safety.

Besides following the above guidelines carefully, note that household or industrial gas lines must never be used in an attempt to establish an electrical ground. Cold water pipes may, in some instances, help in the grounding effort, but gas lines represent a significant explosion hazard, and must never be used.

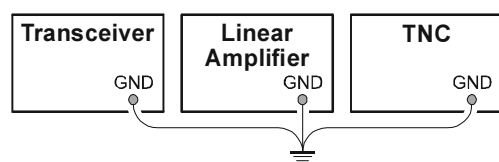

**PROPER GROUND CONNECTION**

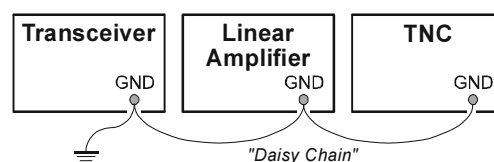

**IMPROPER GROUND CONNECTION**

# INSTALLATION AND INTERCONNECTIONS

## CONNECTION OF ANTENNA AND POWER CABLES

Follow the below illustration and advice regarding the proper connection of antenna coaxial cables, ground cable, and the AC power cable.

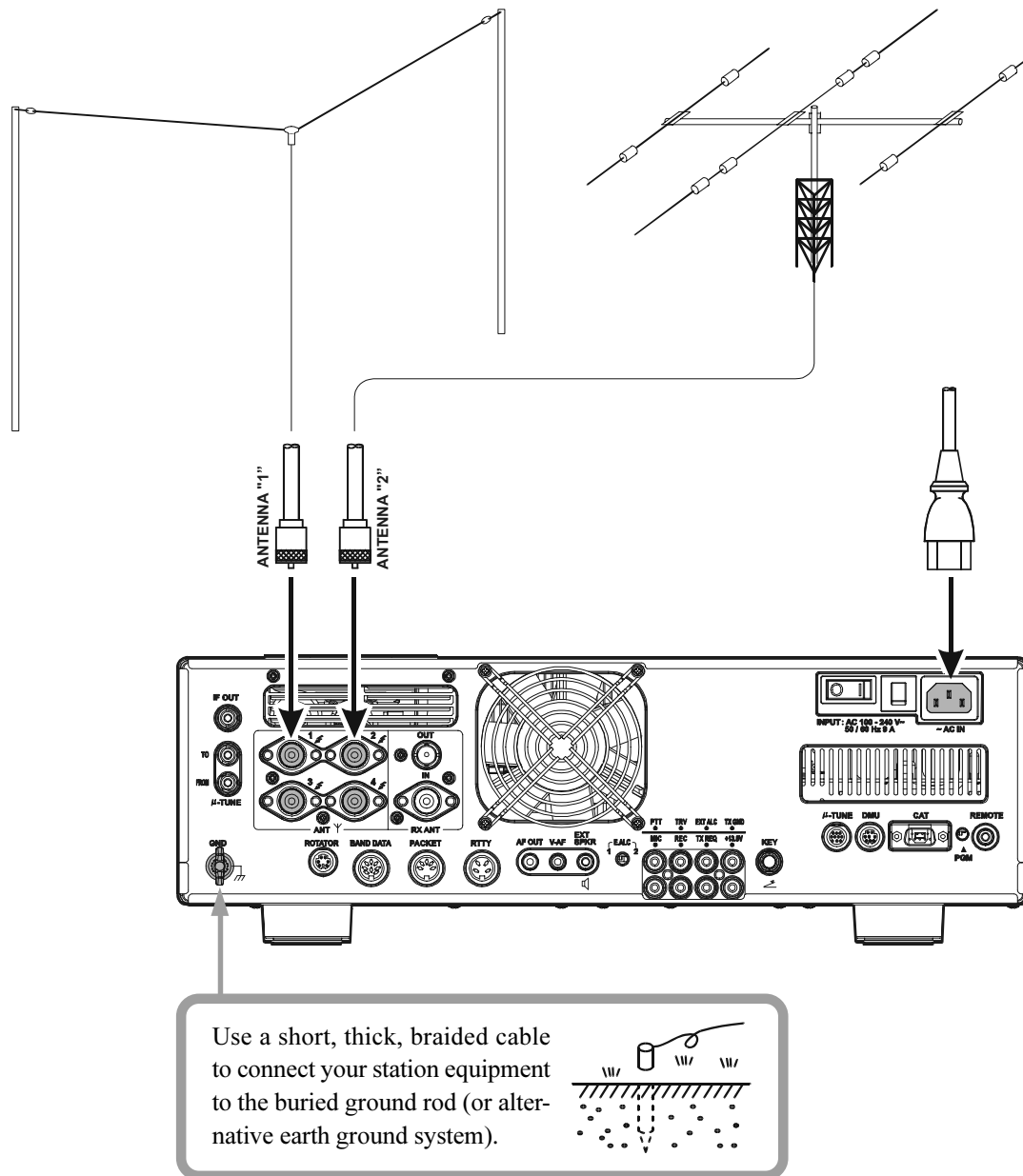

### ADVICE:

- Do not place the transceiver in a location with direct exposure to sunshine.
- Do not place the transceiver in a location exposed to dust and/or high humidity.
- Ensure adequate ventilation around the transceiver, to prevent heat build-up and possible reduction of performance due to high heat.
- Do not install the transceiver in a mechanically-unstable location, or where objects may fall onto this product from above.
- To minimize the possibility of interference to home entertainment devices, take all precautionary steps including separation of TV/FM antennas from Amateur transmitting antennas to the greatest extent possible. Keep transmitting coaxial cables separated from cables connected to home entertainment devices.
- Ensure that the AC power cord is not subject to undue stress or bending, which could damage the cable or cause it to be accidentally unplugged from the rear panel AC input jack.
- Be absolutely certain to install your transmitting antenna(s) such that they cannot possibly come in contact with TV/FM radio or other antennas, nor with outside power or telephone lines.



# INSTALLATION AND INTERCONNECTIONS

## CONNECTION OF MICROPHONE AND HEADPHONE

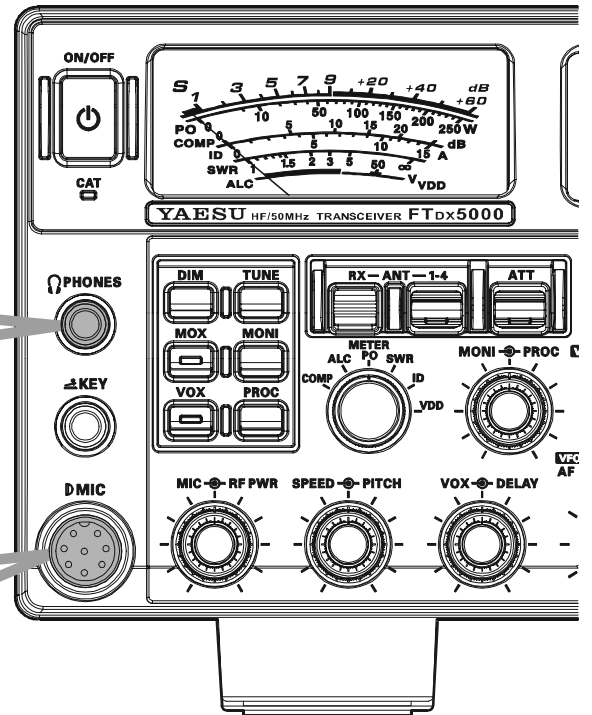
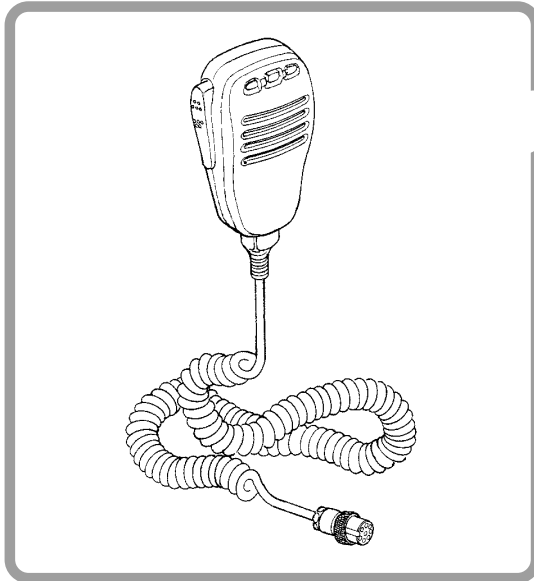

# INSTALLATION AND INTERCONNECTIONS

## KEY, KEYSER, AND COMPUTER-DRIVEN KEYING INTERCONNECTIONS

The **FTDx5000** includes a host of features for the CW operator. These functions will be detailed in the “Operation” section later. An Electronic Keyer is built-in, and two key jacks are provided, one on the front and one on the rear panel, for convenient connection to keying devices.

The Menu system allows you to configure the front and rear panel **KEY** jacks according to the device you wish to connect. For example, you may connect your keyer paddle to the front panel **KEY** jack, and use Menu item “054 A1A F-TYPE” for paddle input, while connecting the rear panel **KEY** jack to the keying line from your personal computer (which emulates a “straight key” for connection purposes), and configure the rear panel jack using Menu item “056 A1A R-TYPE”.

Both **KEY** jacks on the **FTDx5000** utilize “Positive” keying voltage. Key-up voltage is approximately +5V DC, and key-down current is approximately 1 mA. When connecting a key or other device to the **KEY** jacks, **use only a 3-pin (“stereo”) 1/4” phone plug; a 2-pin plug will place a short between the ring and (grounded) shaft of the plug, resulting in a constant “key-down” condition in some circumstances.**

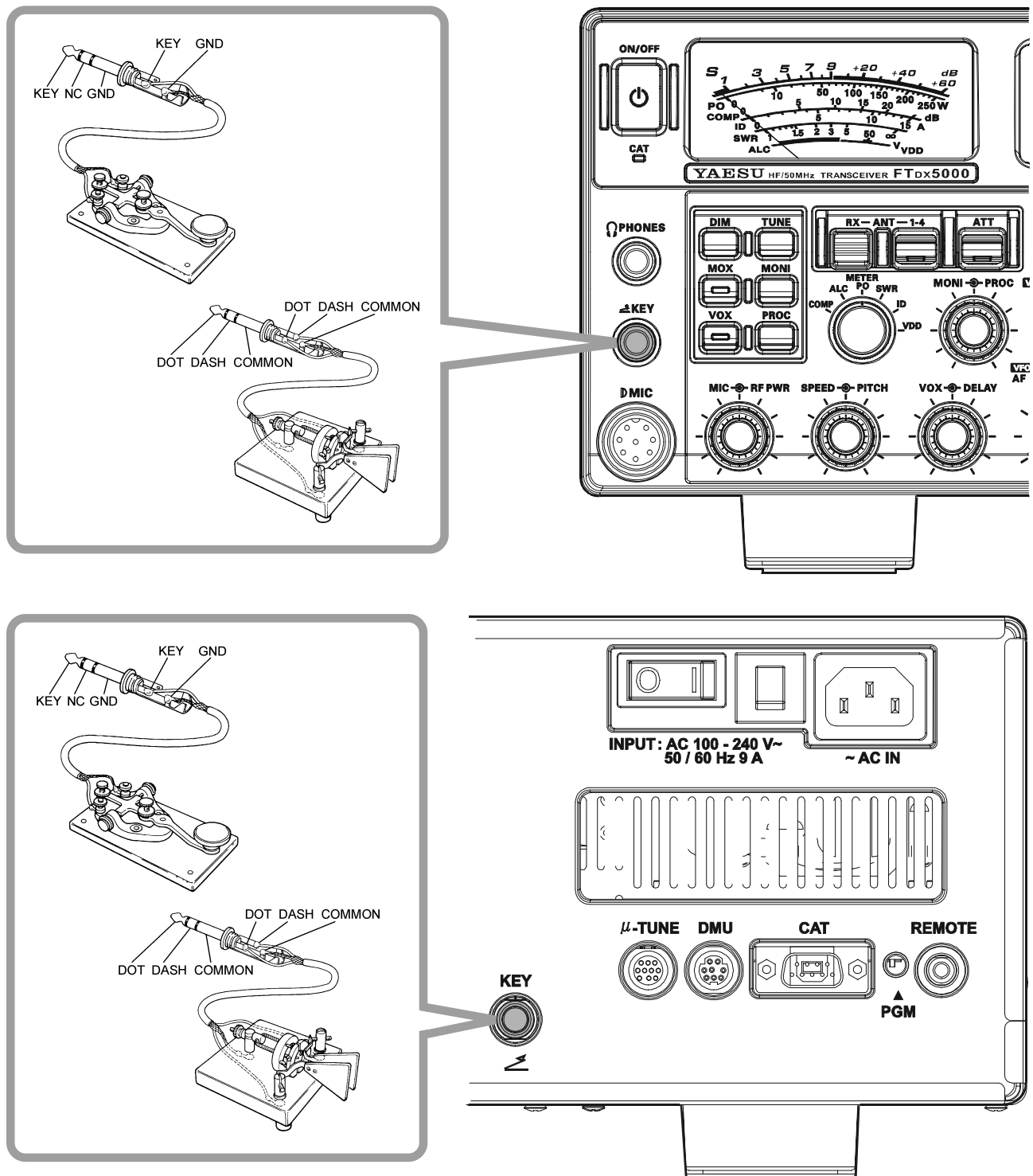

# INSTALLATION AND INTERCONNECTIONS

## VL-1000 LINEAR AMPLIFIER INTERCONNECTIONS

Be sure both the **FTDx5000** and **VL-1000** are turned off, then follow the installation recommendations contained in the illustration.

### NOTE:

- ❑ Refer to the **VL-1000** Operating Manual for details regarding amplifier operation.
- ❑ Do not attempt to connect or disconnect coaxial cables when your hands are wet.

### About the CONTROL Cable

The VL-1000 may be operated with the FTDx5000 whether or not the CONTROL Cable is connected; however, the CONTROL Cable allows you to tune up the amplifier automatically by just pressing the [F SET] or [TUNE] key on the VL-1000, to transmit a carrier for tuning purposes.

To link the FTDx5000 and VL-1000 Power switches, set the VL-1000 REMOTE switch to the "ON" position.

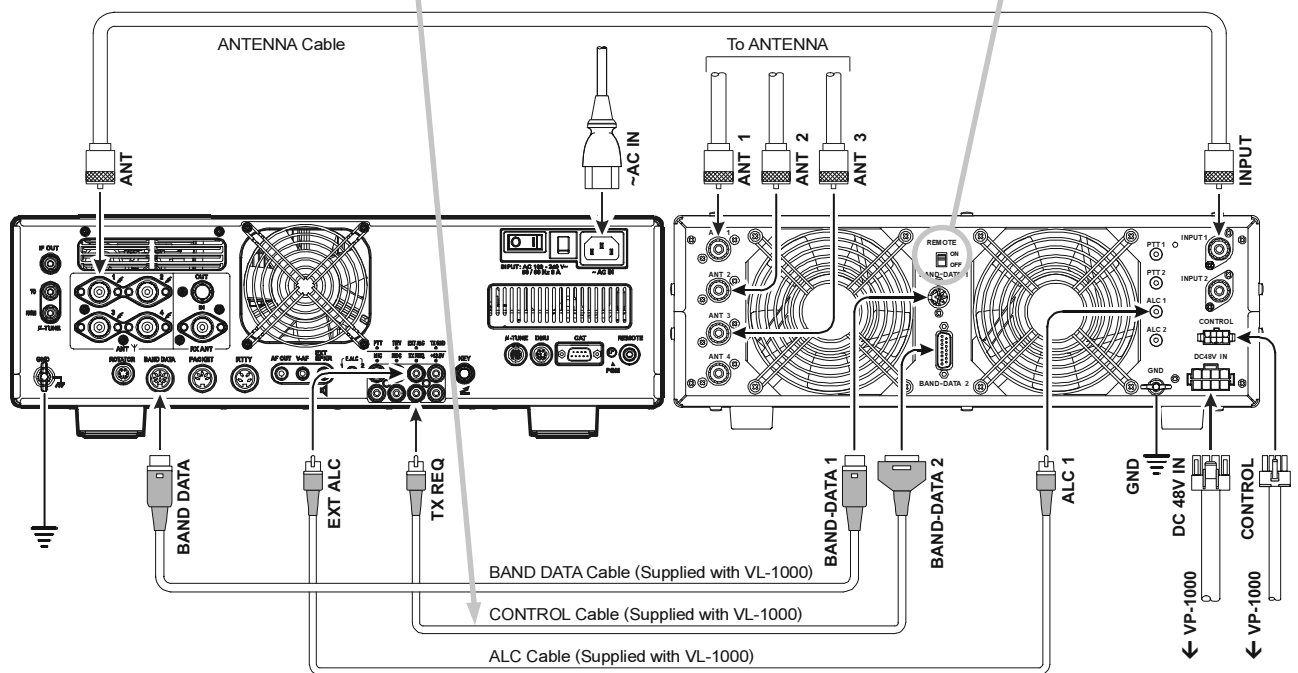

# INSTALLATION AND INTERCONNECTIONS

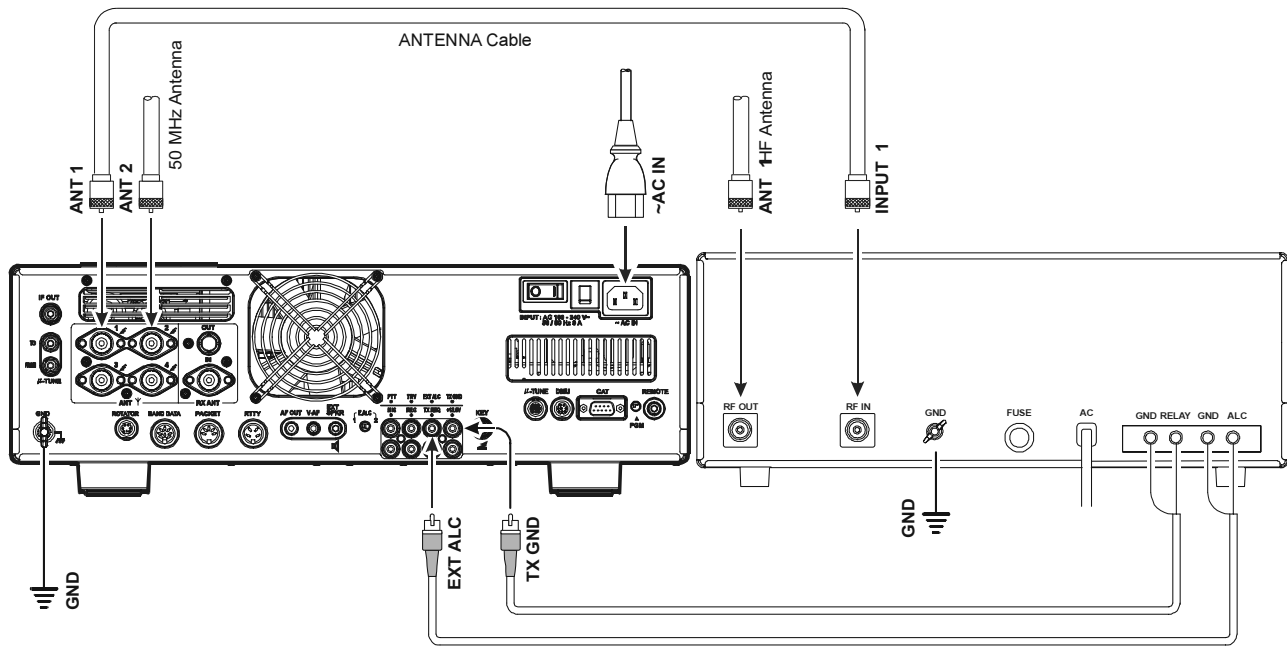

## INTERFACING TO OTHER LINEAR AMPLIFIERS



### NOTE

- ❑ The TX/RX switching in the linear amplifier is controlled by switching components in the transceiver. The relay circuit of the **FTdx5000** used for this switching is capable of switching AC voltage of 100 Volts at up to 300 mA, or DC voltages of 60 V at 200 mA or 30 V at up to 1 Amp. To activate the amplifier switching relay, set Menu item “172 TGEN ETX-GND” to “ENABLE”.
- ❑ The specified range for ALC voltage to be used with the **FTdx5000** is 0 to -4 Volts DC.
- ❑ Amplifier systems utilizing different ALC voltages will not work correctly with the **FTdx5000**, and their ALC lines must not be connected if this is the case.

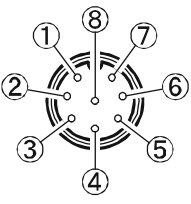
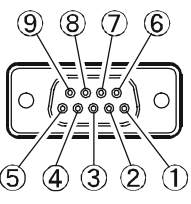
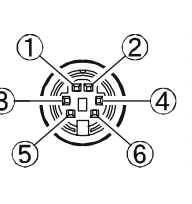
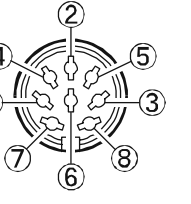
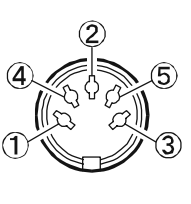
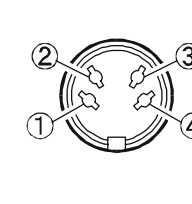
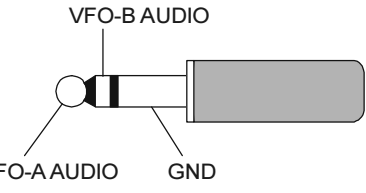
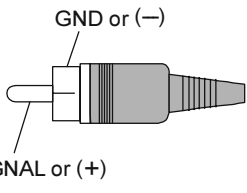
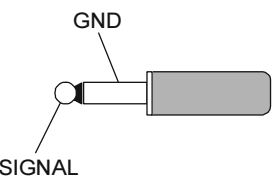
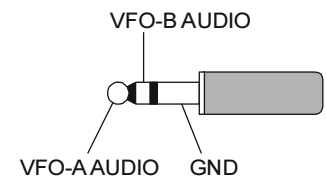
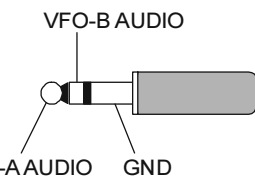
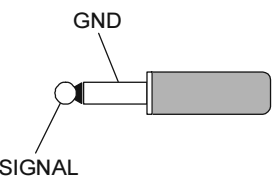
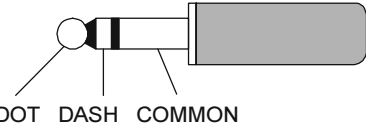
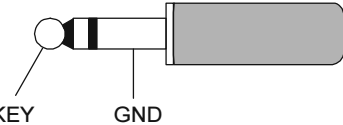
# PLUG/CONNECTOR PINOUT DIAGRAMS

MIC	CAT	ROTATOR
 <ul style="list-style-type: none"> <li>① UP</li> <li>② +5V</li> <li>③ DOWN</li> <li>④ FAST</li> <li>⑤ GND</li> <li>⑥ PTT</li> <li>⑦ MIC GND</li> <li>⑧ MIC</li> </ul> <p>(as viewed from front panel)</p>	 <ul style="list-style-type: none"> <li>① N/A</li> <li>② SERIAL OUT</li> <li>③ SERIAL IN</li> <li>④ N/A</li> <li>⑤ GND</li> <li>⑥ N/A</li> <li>⑦ RTS</li> <li>⑧ CTS</li> <li>⑨ NC</li> </ul> <p>(as viewed from rear panel)</p>	 <ul style="list-style-type: none"> <li>① CW ROTATION</li> <li>② CCW ROTATION</li> <li>③ SPEED</li> <li>④ DIRECTION</li> <li>⑤ GND</li> <li>⑥ NC</li> </ul> <p>(as viewed from rear panel)</p>
BAND DATA	PACKET	RTTY
 <ul style="list-style-type: none"> <li>① +13V</li> <li>② TX GND</li> <li>③ GND</li> <li>④ BAND DATA A</li> <li>⑤ BAND DATA B</li> <li>⑥ BAND DATA C</li> <li>⑦ BAND DATA D</li> <li>⑧ TX INH</li> </ul> <p>(as viewed from rear panel)</p>	 <ul style="list-style-type: none"> <li>① DATA IN</li> <li>② GND</li> <li>③ PACKET PTT</li> <li>④ DATA OUT</li> <li>⑤ BUSY</li> </ul> <p>(as viewed from rear panel)</p>	 <ul style="list-style-type: none"> <li>① SHIFT</li> <li>② RX OUT</li> <li>③ PTT</li> <li>④ GND</li> </ul> <p>(as viewed from rear panel)</p>
PHONE	RCA PLUG	REMOTE
 <p>VFO-B AUDIO</p> <p>VFO-A AUDIO      GND</p>	 <p>GND or (-)</p> <p>SIGNAL or (+)</p>	 <p>GND</p> <p>SIGNAL</p>
V-AF	AF OUT	EXT SPKR
 <p>VFO-B AUDIO</p> <p>VFO-A AUDIO      GND</p>	 <p>VFO-B AUDIO</p> <p>VFO-A AUDIO      GND</p>	 <p>GND</p> <p>SIGNAL</p>
KEY		
<p><b>For Internal Keyer</b></p>  <p>DOT      DASH      COMMON</p>		<p><b>For Straight Key</b></p>  <p>KEY      GND</p>
<p style="text-align: right;"> Do not use 2-conductor type plug</p>		

## IMPORTANT NOTE:

The  $\mu$ -TUNE and DMU use special connectors for this transceiver. Do not connect any accessory or other device not specifically approved by Vertex Standard. Failure to observe this precaution may cause damage not covered by the Limited Warranty on this apparatus.

# FRONT PANEL CONTROLS & SWITCHES

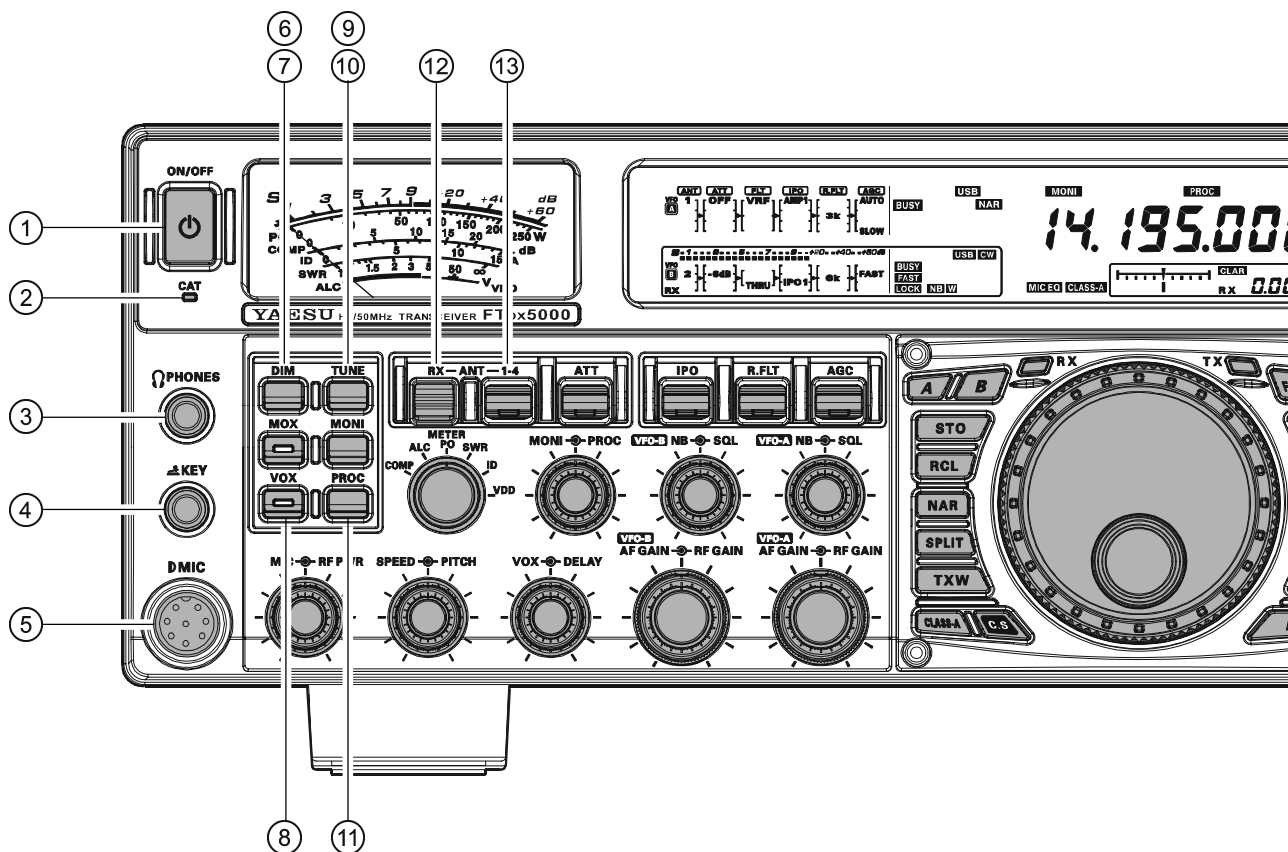

## ① [POWER] Switch

Press this switch in for two seconds to turn the transceiver on. Alternately, press this switch for two seconds to turn the transceiver off. If the rear panel [MAIN POWER] switch is set to the “O” (OFF) position, the front panel [POWER] switch will not function.

### ADVICE:

- ❑ If you press this switch briefly while the transceiver is turned on, the transceiver audio will be muted for three seconds.
- ❑ This is the actual power On/Off switch for turning the transceiver on. In the MP version, when the rear panel [MAIN POWER] switch is set to the “I” (ON) position, power is supplied to the OCXO to stabilize the reference oscillator. The remainder of the transceiver is set in a “stand-by” mode. For further information on the rear panel [MAIN POWER] switch, please see the discussion on page 35.

## ② CAT Indicator

This LED indicator will flash red when serial CAT command signals are being exchanged.

### ADVICE:

You may disable the LED CAT command signal flashing function, via Menu item “035 GENE CAT IND.” See page 124 for details.

## ③ PHONES Jack

A 1/4-inch, 3-contact jack accepts either monaural or stereo headphones with 2- or 3-contact plugs. When a plug is inserted, the loudspeaker is disabled. With stereo headphones such as the optional YH-77STA, you can monitor both VFO-A and VFO-B receiver channels at the same time during Dual Receive operation.

### NOTE:

When wearing headphones, we recommend that you turn the AF Gain levels down to their lowest settings before turning power on, to minimize the impact of any audio “pops” on your hearing during switch-on.

## ④ KEY Jack

This 1/4-inch, 3-contact jack accepts a CW key or keyer paddles (for the built-in electronic keyer), or output from an external electronic keyer. Pinout is shown on page 15. Key up voltage is 5 V, and key down current is 1 mA. This jack may be configured for keyer, “Bug,” “straight key,” or computer interface keying operation via Menu item “057 A1A F-TYPE” (see page 126). There is another KEY jack on the rear panel, and it may be configured independently for Internal Keyer or pseudo-straight-key operation.

### NOTE:

**You cannot use a 2-contact plug in this jack (to do so produces a constant “key down” condition).**

## ⑤ Microphone Connector

This 8-pin jack accepts input from a microphone utilizing a traditional YAESU HF-transceiver pinout.

# FRONT PANEL CONTROLS & SWITCHES

## ⑥ [DIM] Switch

Press this button to lower the illumination intensity of the analog meter and the frequency display. Press it once more to restore full brightness.

### ADVICE:

The following Menu items allow you to configure the dimming levels of each display independently to customize the brightness levels.

**008 DISP DIM MTR:** for analog meter

**009 DISP DIM VFD:** for frequency display

**010 DISP DIM OLE:** **SUB DISPLAY** windows

**011 DISP DIM ELCD:** for Spectrum Scope display of the optional **SM-5000** Station Monitor

## ⑦ [MOX] Switch

Pressing this button engages the PTT (Push to Talk) circuit, to activate the transmitter. The LED inside the button will glow red during transmit. It must be turned off (the red LED will be off) for reception. This button replicates the action of the Push to Talk (PTT) switch on the microphone. When engaging the [MOX] button or otherwise starting a transmission, be certain you have either an antenna or 50-Ohm dummy load connected to the selected Antenna jack.

## ⑧ [VOX] Switch

This button enables automatic voice-actuated transmitter switching in the SSB, AM, and FM modes. While activated, the LED inside the button glows red. Proper adjustment of the front panel [VOX] and [DELAY] knobs will make hands-free voice-actuated operation possible.

## ⑨ [TUNE] Switch

This is the on/off switch for the **FTDx5000**'s Automatic Antenna Tuner.

Pressing this button briefly, places the antenna tuner in line between the transmitter final amplifier and the antenna jack (The "**TUNER**" icon will appear in the display). Reception is not affected.

Pressing this button for 1/2 second, while receiving in an amateur band, activates the transmitter for a few seconds while the automatic antenna tuner rematches the antenna system impedance for minimum SWR. The resulting setting is automatically stored in one of the antenna tuner's 100 memories, for instant automatic recall later when the receiver is tuned near the same frequency.

Pressing this button briefly, while the Tuner is engaged, will take the Automatic Antenna tuner out of the transmit line.

### NOTE:

A signal is being transmitted while the tuner is matching the antenna impedance. Therefore, be certain there is a dummy load or antenna connected to the selected antenna jack before initiating the tuning sequence.

## ⑩ [MONI] (Monitor) Switch

This button enables the transmit monitor in all modes. While activated, the "**MONI**" icon appears in the display. Use the [MONI] knob to adjust the Monitor level.

### ADVICE:

The Monitor is highly useful for making adjustments to the Parametric Equalizer, or other voice characteristic adjustments, while listening with headphones. The voice quality heard in the headphones is a "natural" reproduction of the transmitted audio.

## ⑪ [PROC] (Processor) Switch

This button enables the Speech Processor for SSB transmission. While activated, the "**PROC**" icon appears in the display. Adjustment of the Processor level is accomplished using the [PROC] knob.

### ADVICE:

The Speech Processor uses a compression technique to increase the average power output. However, if the [PROC] knob is advanced too far, the increase in compression becomes counter-productive, and intelligibility will suffer. We recommend that you monitor the sound of your signal using the Monitor (with headphones).

When the optional **DMU-2000** Data Management Unit is connected, you may use the Audio Scope/Oscilloscope function to help you adjust the setting of the Speech Processor compression level for optimum performance with your voice and microphone.

## ⑫ [RX ANT] Switch

Press this button to use an antenna connected to the RX ANT jack on the rear panel for receive.

The "**RX**" icon appears in the display when the RX ANT is used.

## ⑬ [ANT 1-4] Switch

Move this knob up or down to conveniently select one of the four antenna jacks on the rear panel. The selected antenna jack is indicated in the ANT column of the Block Diagram Display.

### ADVICE:

Press this knob in briefly to quickly select the ANT 1 jack.

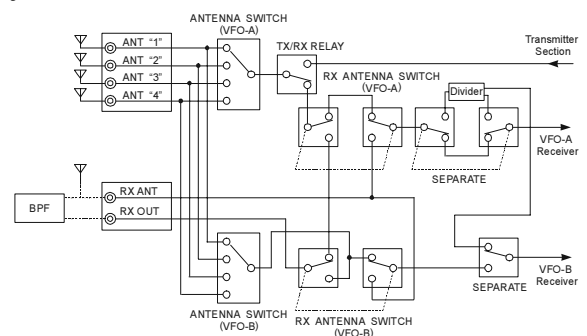

# FRONT PANEL CONTROLS & SWITCHES

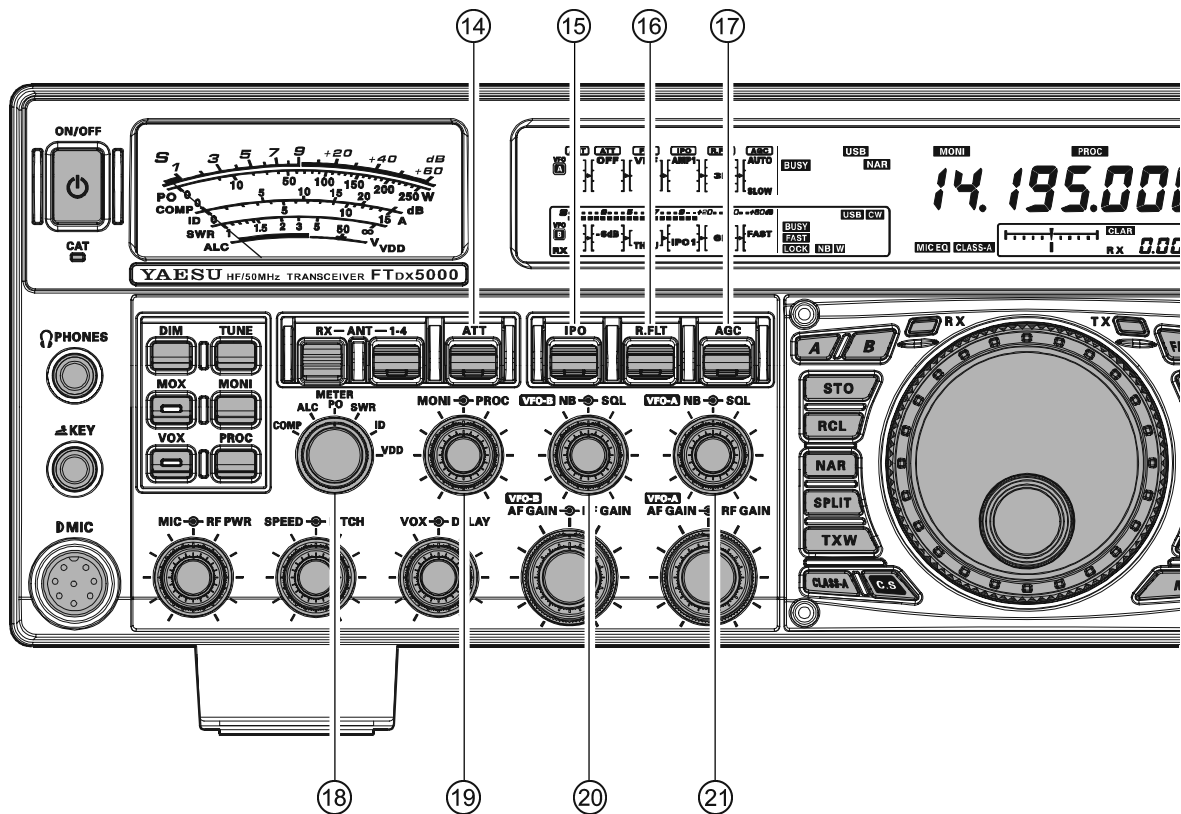

## 14 [ATT] Switch

Move this knob up or down to select the degree of Attenuation to be applied to the receiver input. Available selections are “-6 dB”, “-12 dB”, “-18 dB”, or “OFF”. The selected attenuation level appears in the ATT column of the Block Diagram Display.

### ADVICE:

- Press this knob in briefly, to quickly turn the attenuation level off.
- The Attenuator may be used in conjunction with the [IPO] switch to provide additional gain reduction when an extremely strong signal is being received.

## 15 [IPO] (INTERCEPT POINT OPTIMIZATION) Switch

Move this knob up or down to select the optimum front end characteristics of the receiver circuit. Available selections are “AMP 1”, “AMP 2”, “IPO 1”, or “IPO 2”.

Normally, IPO is set to “AMP1”. If you want to increase the sensitivity, use “AMP2”. When set to “IPO1”, the IPO performance of the receivers is improved. When set to “IPO2”, the RF preamplifier is bypassed, yielding direct feed to the first mixer. As a result, the IPO is improved more.

### ADVICE:

- Press this knob in briefly to quickly select the “AMP1” IPO setting.
- “IPO 2” can not be selected for VFO-B.

## 16 [R.FLT] Switch

Move this knob up or down to select the bandwidth of the first IF Roofing Filter. Available selections are “300 Hz”, “600 Hz”, “3 kHz”, “6 kHz”, “15 kHz”, or “AUTO” (“300 Hz” and “600 Hz” are available only in VFO-A. The “300 Hz” filter is optional, except in the MP version). The selected bandwidth appears in the R.FLT column of the Block Diagram Display.

### ADVICE:

- Press this knob in briefly to quickly select “AUTO”.
- Because the roofing filter is in the first IF, the protection it provides against interference is quite significant. When set to “AUTO”, the SSB bandwidth is 6 kHz, CW is 3 kHz, and FM/RTTY are 15 kHz. However, on a crowded SSB band, you may wish to select the 3 kHz filter, for the maximum possible interference rejection.



# FRONT PANEL CONTROLS & SWITCHES

## 17 [AGC] Switch

Move this knob up and down to select the receiver AGC characteristics (receiver-recovery time). Available selections are FAST, MID, SLOW, or AUTO, and the selected receiver-recovery time appears in the AGC column of the Block Diagram Display.

Hold this knob up or down for two seconds to disable the AGC (for testing or weak-signal reception).

### ADVICE:

- Press this knob in briefly to quickly select “AUTO”.
- If the AGC is disabled by holding the [AGC] knob up or down, the S-meter will no longer deflect. Additionally, you will likely encounter distortion on stronger signals, as the IF amplifiers and the following stages may be overloaded.

## 18 [METER] Switch

This control switch determines the function of the meter during transmission.

**COMP:** Indicates the speech compression level (SSB mode only).

**ALC:** Indicates the relative ALC voltage.

**PO:** Indicates the average power output level.

**SWR:** Indicates the Standing Wave Ratio (Forward: Reflected).

**ID:** Indicates the final amplifier drain current.

**VDD:** Indicates the final amplifier drain voltage.

## 19 [MONI] → [PROC] Knobs

### [MONI] Knob

The inner [MONI] knob adjusts the audio level of the transmit RF monitor during transmission (relative to the AF GAIN control), when activated by the [MONI] button.

### [PROC] Knob

The outer [PROC] knob sets the compression (input) level of the transmitter Speech Processor in the SSB, AM, and FM modes, when activated by the [PROC] button.

### ADVICE:

The relative compression level of the Speech Processor will show for 3-seconds in the lower right corner of the Main Display whenever the outer [PROC] knob is turned.

Alternately, the 3-second display feature may be changed to show in the **SUB DISPLAY-III** window via Menu item “018 DISP INDI”. Additionally, you may disable the 3-second display feature via Menu item “017 DISP LVL IND” See page 122 for details.

## 20 (VFO-B) [NB] → [SQL] Knobs

### [NB] Knob

The inner [NB] knob adjusts the noise blanking level when the VFO-B (analog) IF noise blanker is activated by pressing the [NB] button.

### [SQL] Knob

The outer [SQL] knob sets the signal level threshold at which the VFO-B receiver audio is muted, in all modes. The squelch is very useful during local rag-chews, to eliminate noise between incoming transmissions. This control is normally kept fully counter-clockwise (off), except when scanning and during FM operation.

## 21 (VFO-A) [NB] → [SQL] Knobs

### [NB] Knob

The inner [NB] knob adjusts the noise blanking level when the VFO-A (analog) IF noise blanker is activated by pressing the [NB] button.

### [SQL] Knob

The outer [SQL] knob sets the signal level threshold at which the VFO-A receiver audio is muted, in all modes. The squelch is very useful during local rag-chews, to eliminate noise between incoming transmissions. This control is normally kept fully counter-clockwise (off), except when scanning and during FM operation.

# FRONT PANEL CONTROLS & SWITCHES

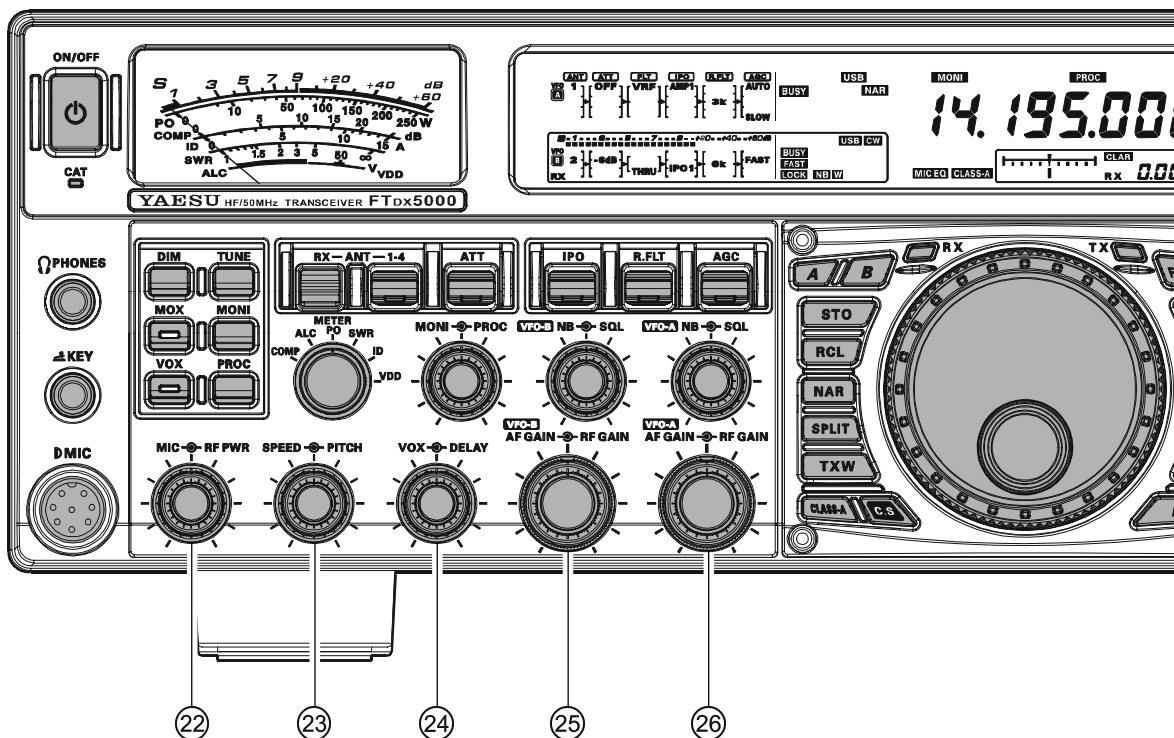

## 22 [MIC] ↔ [RF PWR] Knobs

### [MIC] Knob

The inner [MIC] knob adjusts the microphone input level for (non-processed) SSB transmission.

#### ADVICE:

- ❑ Adjust the MIC Gain while speaking in a somewhat-louder-than-normal voice. Watch the ALC level and adjust the MIC Gain so that the ALC indication reaches just to the right edge of the scale. Then, when you speak in a normal voice level, you will not over-driving the mic amplifier stage.
- ❑ The relative Microphone Gain level will show for 3-seconds in the lower right corner of the Main Display whenever the inner [MIC] knob is turned.

Alternately, the 3-second display feature may be changed to show in the **SUB DISPLAY-III** window via Menu item “018 DISP INDI”. Additionally, you may disable the 3-second display feature via Menu item “017 DISP LVL IND” See page 122 for details.

### [RF PWR] Knob

The outer [RF PWR] knob is the main RF Power output control for the transceiver. It is active in all operating modes. Clockwise rotation increases the power output. Adjust this control for the desired power output from the **FTDX5000**.

#### ADVICE:

The RF Power output will show for 3 seconds in the lower right corner of the Main Display whenever the outer [RF PWR] knob is turned. Alternately, the 3-second display feature may be changed to show in the **SUB DISPLAY-III** window via Menu item “018 DISP INDI”. Additionally, you may disable the 3-second display feature via Menu item “017 DISP LVL IND” See page 122 for details.

# FRONT PANEL CONTROLS & SWITCHES

## ②③ [SPEED]↔[PITCH] Knobs

### [SPEED] Knob

The inner [SPEED] knob adjusts the keying speed of the internal CW keyer (4 ~ 60 WPM). Clockwise rotation increases the sending speed.

The keying speed will show for 3 seconds in the lower right corner of the Main Display while the [KEYER] button is held depressed for more than one second.

#### **ADVICE:**

The keying speed will show for 3 seconds in the lower right corner of the Main Display whenever the outer [SPEED] knob is turned.

Alternately, the 3-second display feature may be changed to show in the **SUB DISPLAY-III** window via Menu item “018 DISP INDI”. Additionally, you may disable the 3-second display feature via Menu item “017 DISP LVL IND” See page 122 for details.

### [PITCH] Knob

The outer [PITCH] knob selects your preferred CW tone pitch (from 300 ~ 1050 Hz, in 50 Hz increments). The TX sidetone, the receiver IF passband, and the display offset from the BFO (carrier) frequency are all affected simultaneously. The Pitch control setting also affects the operation of the CW Tuning Indicator, as the center frequency of the CW Tuning Indicator will follow the setting of this control.

#### **ADVICE:**

The CW tone pitch frequency will show for 3 seconds in the lower right corner of the Main Display whenever the outer [SPEED] knob is turned.

Alternately, the 3-second display feature may be changed to show in the **SUB DISPLAY-III** window via Menu item “018 DISP INDI”. Additionally, you may disable the 3-second display feature via Menu item “017 DISP LVL IND” See page 122 for details.

## ②④ [VOX]↔[DELAY] Knobs

### [VOX] Knob

The inner [VOX] knob sets the level of microphone audio needed to activate the transmitter during voice operation when the [VOX] switch is actuated.

### [DELAY] Knob

The outer [DELAY] knob sets the hang time of the VOX circuit for voice operation, and the keying delay for CW operation.

For voice operation, this knob sets the hang time, between the moment you stop speaking, and the time the transmit is switched back to receive. For smooth operation, adjust the VOX so the transmit switches to receive when your comments have ended.

For CW, this knob sets the automatic transmit to receive keying delay for “Semi-break-in” operation. Adjust this just long enough to prevent the receiver from being restored during word spaces at your preferred sending speed.

#### **ADVICE:**

The hang time of the VOX circuit will show for 3 seconds in the lower right corner of the Main Display whenever the outer [SPEED] knob is turned. Alternately, the 3-second display feature may be changed to show in the **SUB DISPLAY-III** window via Menu item “018 DISP INDI”. Additionally, you may disable the 3-second display feature via Menu item “017 DISP LVL IND” See page 122 for details.

## ②⑤ (VFO-B)[AF GAIN]↔[RF GAIN] Knobs

### [AF GAIN] Knob

The inner [AF GAIN] knob sets the audio level of the VFO-B receiver. Typically, you will operate with this control set between the 9 o'clock and 10 o'clock positions.

### [RF GAIN] Knob

The outer [RF GAIN] knob sets the gain of the RF and IF amplifier stages of the VFO-B receiver. This control is normally left in the fully clockwise position.

## ②⑥ (VFO-A) [AF GAIN]↔[RF GAIN] Knobs

### [AF GAIN] Knob

The inner [AF GAIN] knob sets the audio level of the VFO-A receiver. Typically, you will operate with this control set between the 9 o'clock and 10 o'clock positions.

### [RF GAIN] Knob

The outer [RF GAIN] knob sets the gain of the RF and IF amplifier stages of the VFO-A receiver. This control is normally left in the fully clockwise position.

# FRONT PANEL CONTROLS & SWITCHES

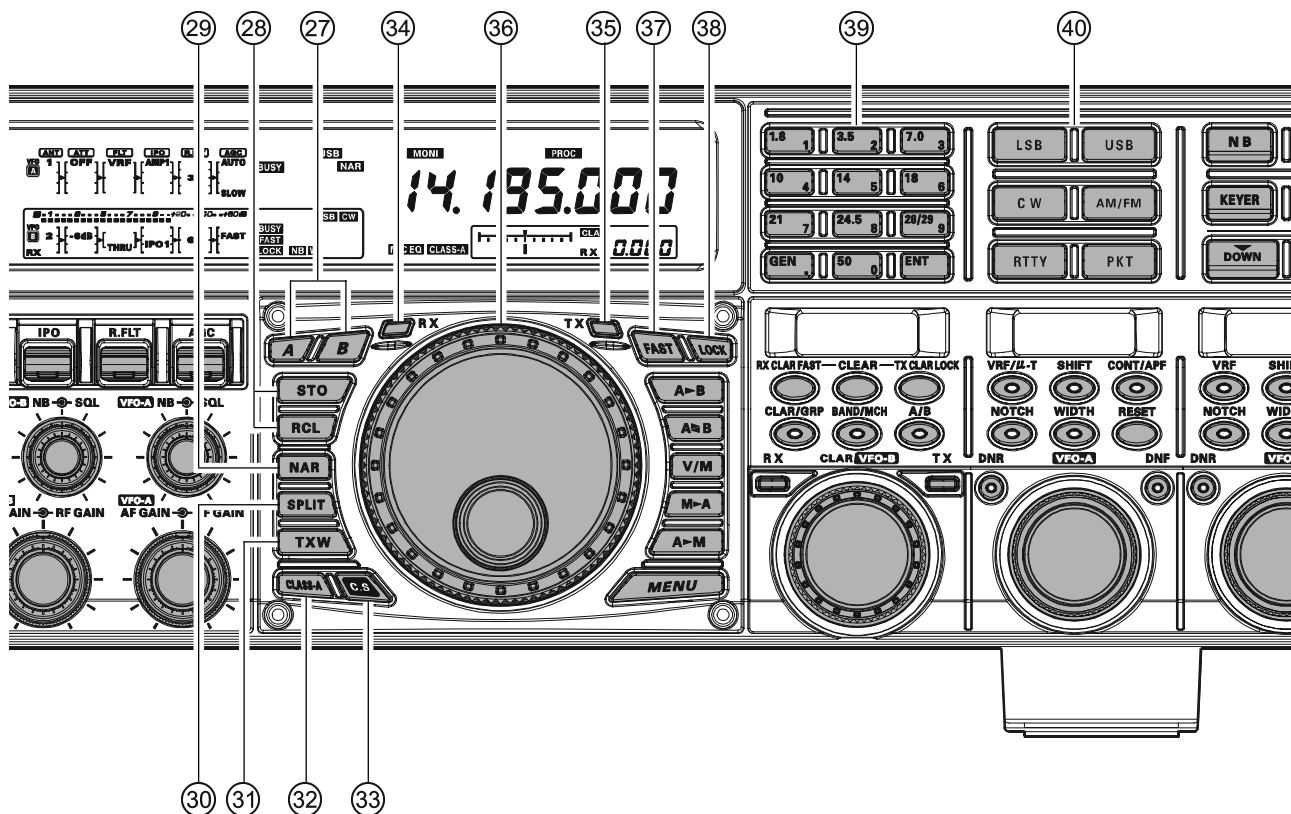

## 27 [A], [B] Switches

Pressing the [A] or [B] button will illuminate the respective switch, and allow adjustment of the major functions (such as mode and band selection etc) on the VFO-A or VFO-B receiver. Usually, the [A] button will glow red, and the VFO-A functions may be adjusted. Similarly, pressing the [B] button will cause its indicator glow orange, signifying the VFO-B functions may be adjusted.

### ADVICE:

The [A]/[B] switches affect the following functions:

- [RX ANT] switch
- [ANT 1-4] switch
- [ATT] switch
- [IPO] switch
- [R.FLT] switch
- [AGC] switch
- [NAR] switch
- [BAND] switches
- [MODE] switches
- [NB] switch
- [RX ANT] switch

## 28 QMB (Quick Memory Bank) Switches

### [STO] (Store) Button

Pressing this button, copies the operating information for frequency, mode, and bandwidth, into consecutive QMB Memories. Repeater shift/direction, frequency and CTCSS functions, are also copied in the FM mode.

### [RCL] (Recall) Button

Pressing this button recalls one of the five Quick Memory Bank memories for operation.

## 29 [NAR] (Narrow) Switch

This button is used to set the DSP (digital) filters to narrow bandwidths. The default values are as follows:

MODE	NAR SWITCH	
	OFF	ON
LSB/USB	2.4 kHz* (1.8 kHz - 4.0 kHz / 16 steps)	1.8 kHz* (200 Hz - 1.8 kHz / 9 steps)
CW	2.4 kHz* (500 Hz - 2.4 kHz / 7 steps)	500 Hz* (50 Hz - 500 Hz / 10 steps)
RTTY (LSB)	500 Hz* (500 Hz - 2.4 kHz / 7 steps)	300 Hz* (50 Hz - 500 Hz / 10 steps)
PKT (LSB/USB)	500 Hz* (500 Hz - 2.4 kHz / 7 steps)	300 Hz* (50 Hz - 500 Hz / 10 steps)
PKT (FM)	25 kHz (±5.0 kHz Deviation)	12.5 kHz (±2.5 kHz Deviation)
AM	9 kHz	6 kHz
FM	25 kHz (±5.0 kHz Deviation)	12.5 kHz (±2.5 kHz Deviation)

\*: You may enable the [WIDTH] knob to adjust the bandwidth.

# FRONT PANEL CONTROLS & SWITCHES

## ③⑩ [SPLIT] Switch

Press this button briefly to activate split frequency operation between the VFO-A receiver and the VFO-B, transmit. Press and hold in this button for two seconds to engage the “Quick Split” feature, whereby VFO-B will automatically be set to a frequency 5 kHz higher than the VFO-A frequency with the same operating mode, and the transceiver will be placed in the Split mode.

## ③① [TXW] (TX Watch) Switch

Press and hold this button to monitor the transmit frequency when split frequency operation is engaged. Release the button to return to normal operation.

## ③② [CLASS-A] Switch

Press this button to engage the Class-A transmit capability. The power output will be reduced to a maximum of 75 Watts. However, Class-A operation provides an ultra-clean SSB waveform. When Class-A operation is engaged, the “CLASS-A” icon appears in the display. Press this button once more to return to Class-AB operation at a maximum power output of 200 Watts; the “CLASS-A” icon disappears to confirm Class-AB operation.

### ADVICE:

You may adjust the bias level between “Class-AB” and “Class-A” via Menu item “169 TGEN BAIS”. See page 136 for details.

## ③③ [C.S] Switch

Press this button briefly to recall a favorite Menu Selection directly.

To assign a Menu selection as the short-cut, press the [MENU] button to enter the Menu, then select the Menu item. Now press and hold in the [C.S] button for two seconds to lock the selected Menu item as the short-cut.

## ③④ (VFO-A)[RX] Indicator/Switch

Press this button to engage the VFO-A receiver; the button will glow green when the VFO-A receiver is active.

When the VFO-A receiver is active, pressing this button briefly will mute the receiver, and the indicator will blink. Pressing the button once more will restore receiver operation, and the indicator will glow green steadily.

## ③⑤ (VFO-A)[TX] Indicator/Switch

When this button is pressed, the button indicator will glow red and the transmitter frequency and mode will be controlled by VFO-A (subject to any Clarifier offset, of course).

### ADVICE:

If this indicator is not illuminated, it means that VFO-B TX has been selected (In this case, The VFO-B TX indicator will glow red and the transmitter frequency and mode will be controlled by VFO-B).

## ③⑥ Main Tuning Dial Knob

This large knob adjusts the operating frequency of VFO-A or a recalled memory. Clockwise rotation of the knob increases the frequency. Default tuning increments are 10 Hz (100 Hz in FM mode); when the [FAST] button is pressed, the tuning steps increase. The available steps are:

OPERATING MODE	1 STEP	1 DIAL ROTATION
LSB/USB/CW/RTTY/PKT(SSB)/AM	10 Hz (100 Hz)	10 kHz (100 kHz)
FM/PKT(FM)	100 Hz (1 kHz)	100 kHz (1 MHz)

Numbers in parentheses indicate steps when the [FAST] button is On.

### ADVICE:

- The tuning steps for the Main Tuning Dial knob are set, at the factory, to 10 Hz per step. Via Menu item “142 TUN DIAL STEP”, however, you may change this setting from 10 Hz to 5 Hz or 1 Hz instead. When the [FAST] button is pressed, the tuning step change to 100 Hz.
- You may lock the Main Tuning Dial knob in the AM and FM mode via Menu items “147 TUN AM D.LCK” and “148 TUN FM D.LCK”.

## ③⑦ [FAST] Switch

Pressing this button will change the VFO-A tuning step to 100 Hz.

When this function is activated, the “FAST” icon appears in the display.

## ③⑧ [LOCK] Switch

This button toggles locking of the Main Tuning Dial knob, to prevent accidental frequency changes. When the button is active, the Main Tuning Dial knob can still be turned, but the VFO-A frequency will not change, and the “LOCK” icon appears in the display.

## ③⑨ [BAND] Keys

These buttons allow one-touch selection of the desired amateur band (1.8 ~ 50 MHz).

What’s more, these buttons may be used for direct entry of a desired operating frequency during VFO operation.

## ④⑩ [MODE] Switches

Pressing one of these buttons, selects the operating mode. Repeated presses of a particular switch will toggle to the alternate mode, or step through the available selections, as shown in the chart below.

SWITCH	VARIABLE MODE SELECTION
LSB	LSB
USB	USB
CW	CW (LSB)↔CW (USB)
AM/FM	AM↔FM
RTTY	RTTY (LSB)↔RTTY (USB)
PKT	PKT (LSB)→PKT (USB)→PKT (FM) ……

# FRONT PANEL CONTROLS & SWITCHES

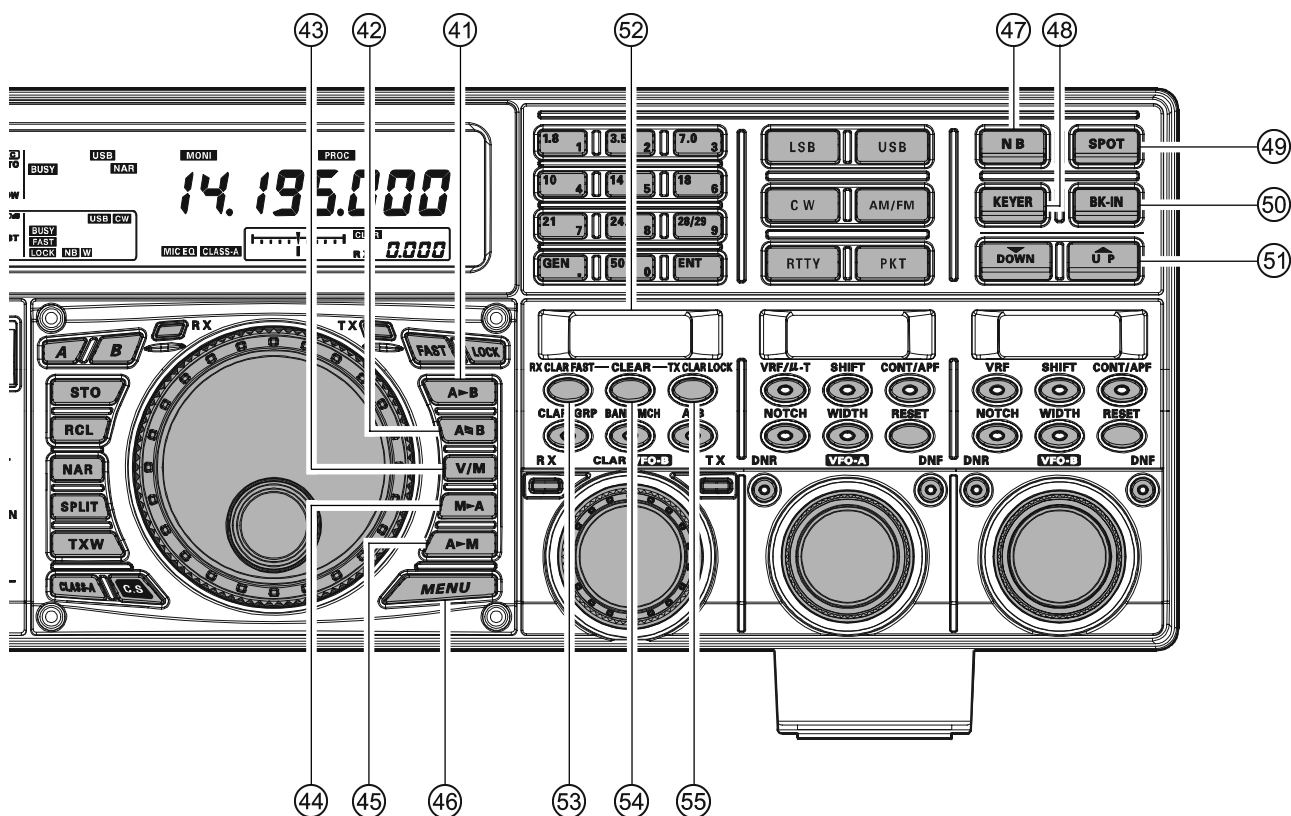

## 41 [A▶B] Switch

Press this button briefly to transfer data from the VFO-A frequency (or a recalled memory channel) to VFO-B, overwriting any previous contents in VFO-B. Use this button to set both VFO-A and VFO-B receivers to the same frequency and mode.

## 42 [A▶B] Switch

Pressing this button briefly, exchanges the contents of the VFO-A (or a recalled memory channel) and the VFO-B.

## 43 [V/M] Switch

This button toggles VFO-A receiver operation between the memory system and the VFO. Either “**MR**” or “**MT**” will be displayed under the main frequency display field to indicate the current selection. If you have tuned off of a Memory channel frequency (MT), pressing this button returns the display to the original memory contents (MR), and pressing it once more returns operation to VFO-A (no icon).

## 44 [M▶A] Switch

Press this button briefly, to display the contents of the currently-selected memory channel for three seconds. Holding this button in for 2 seconds copies the data from the currently-selected memory to VFO-A, as two beeps sound. Previous data in VFO-A will be overwritten.

## 45 [A▶M] Switch

Pressing and holding in this button for 1/2 second (until the double beep), copies the current operating data from VFO-A into the currently selected memory channel, overwriting any previous data stored there. See page 102 for details.

Also, pressing and holding in this button after recalling a memory, without first retuning, causes the memory channel to be “masked,” and repeating the process restores the masked memory.

## 46 [MENU] Switch

This button is used to access the Menu system, for configuring various transceiver characteristics. Menu operation is described in detail, in this manual, beginning on page 116.

### IMPORTANT NOTE:

Pressing this button briefly activates the Menu, and the Menu items will appear on the **SUB DISPLAY** windows. Once you are finished, you must press and hold in the [MENU] button for two seconds to save any configuration changes (briefly press the [MENU] button to exit without saving the changes).

# FRONT PANEL CONTROLS & SWITCHES

## ④7 [NB] Switch

This button turns the IF Noise Blanker on and off. Press this button briefly to reduce a short-duration pulse noise; the “**NB**” icon will appear in the display. Press this button once more to reduce a longer-duration man-made pulse noise; the “**W**” icon will appear at the right of the “**NB**” icon. Press this button again to disable the noise blanker; the “**NB**” and “**W**” icon will disappear.

## ④8 [KEYER] Switch

This button toggles the internal CW keyer on and off. While activated, the “**KEYER**” icon appears in the display. The keyer sending speed is adjusted via the front panel [SPEED] knob, and the CW Hang Time is adjusted via the front panel [DELAY] knob.

### **ADVICE:**

When this button is held for more than one second, the keying speed will be displayed in the lower right corner of the Main Display until the button is released. Alternately, the 3-second display feature may be changed to show in the **SUB DISPLAY-III** window via Menu item “**018 DISP INDI**”. See page 122 for details.

## ④9 [SPOT] Switch

This button turns on the CW receiver spotting tone; by matching the SPOT tone to that of the incoming CW signal (precisely the same pitch), you will be “zero beating” your transmitted signal with the frequency of the other station.

### **ADVICE:**

The offset tone frequency will be displayed in the lower right corner of the Main Display when this button is pressed. Alternately, the 3-second display feature may be changed to show in the **SUB DISPLAY-III** window via Menu item “**018 DISP INDI**”. See page 122 for details.

## ⑤0 [BK-IN] Switch

This button turns the CW break-in capability on and off. While the CW break-in is activated, the “**BK-IN**” icon appears in the display.

## ⑤1 [▼(DOWN)]/[▲(UP)] Switches

These buttons adjust the operating frequency of the VFO or a recalled memory in 100 kHz steps.

## ⑤2 SUB DISPLAY-I

This OLED (Organic Light Emitting Diode) display shows the VFO-B frequency, and it indicates the Menu List while the Menu Mode is active.

## ⑤3 [RX CLAR(FAST)] Switch

The function of this button differs with the setting of the [A/B] button (described later).

*When the LED in the [A/B] button is turned off*, pressing this button activates the RX Clarifier, to allow offsetting the VFO-A receiving frequency temporarily. Press this button once more to return the Main receiver to the frequency shown on the main frequency display field; the Clarifier offset will still be present, though, in case you want to use it again. To cancel the Clarifier offset, press the [CLEAR] button.

*When [A/B] button glows orange*, pressing this button will change the VFO-B tuning step to 100 Hz.

When this function is activated, the “**FAST**” icon appears in the display.

## ⑤4 [CLEAR] Switch

Pressing this button clears out any frequency offset you have programmed into the Clarifier register (thereby setting the offset to “Zero”).

## ⑤5 [TX CLAR/LOCK] Switch

The function of this button is changed by the setting of the [A/B] button (described later).

*When the [A/B] button is turned off*, pressing the [TX CLAR/LOCK] button activates the TX Clarifier, to allow offsetting the VFO-A transmit frequency temporarily. Press the button once more to return the transmitter to the VFO-A frequency shown on the main frequency display field; the Clarifier offset will still be present, though, in case you want to use it again. To cancel the Clarifier offset, press the [CLEAR] button.

*When the [A/B] button glows orange*, the [TX CLAR/LOCK] button toggles locking of the [CLAR(VFO-B)] knob, to prevent accidental frequency changes. When the lock is active, the [CLAR(VFO-B)] knob can still be turned, but the VFO-B frequency will not change, and the “**LOCK**” icon appears in the display.

# FRONT PANEL CONTROLS & SWITCHES

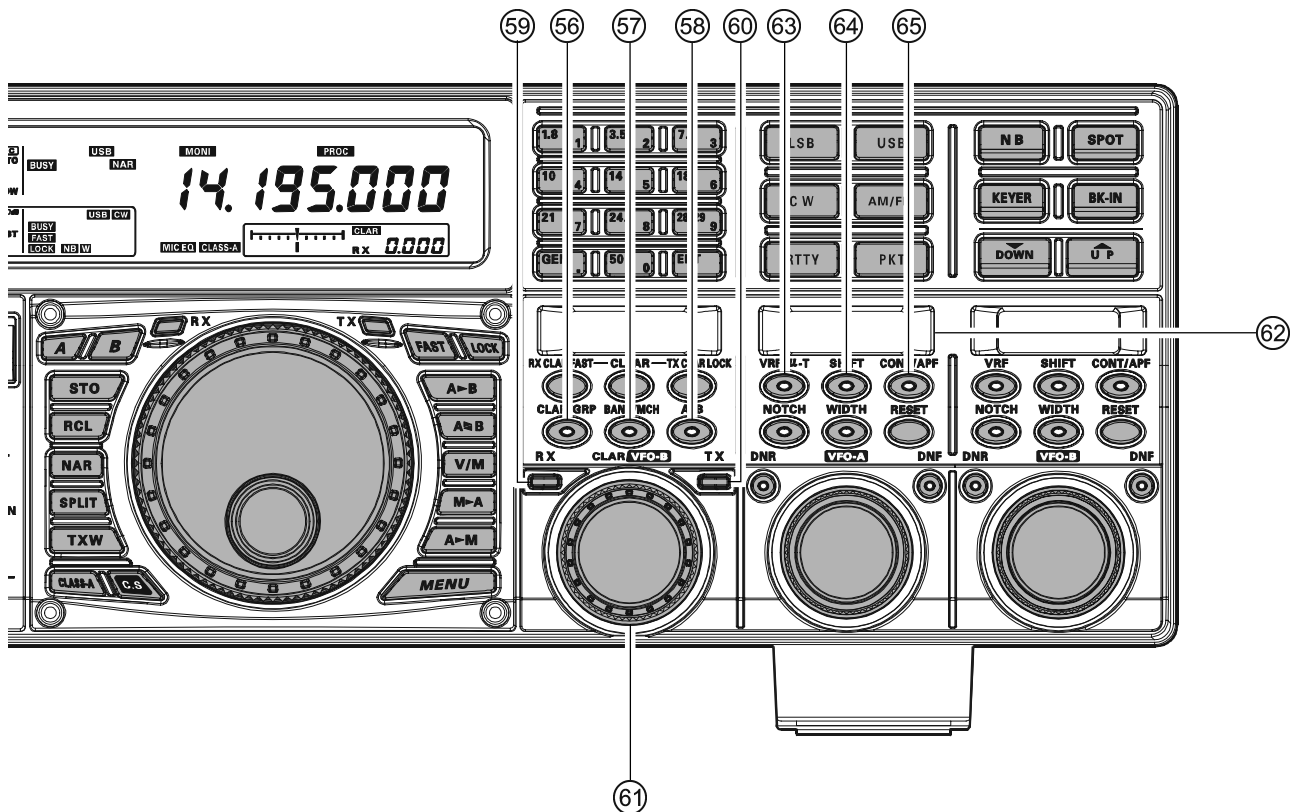

## 56 [CLAR/GRP] Switch

This button has two functions.

**Press this button briefly**, the [CLAR/VFO-B] knob will be enabled as an “offset tuning” control to allow tuning away from the VFO-A frequency, and the [CLAR/GRP] button will glow red.

**Pressing and holding this button for one second**, allows you to select the memory group using the [CLAR(VFO-B)] knob, and the [CLAR/GRP] button will glow yellow.

## 57 [BAND(MCH)] Switch

This button has two functions.

**Pressing this button briefly**, enables the [CLAR(VFO-B)] knob to select the VFO-A operating Amateur Band. The [CLAR/GRP] button glows red.

**Pressing and holding this button for one second**, allows you to select the memory channel using the [CLAR(VFO-B)] knob, and the [CLAR/GRP] button is glows yellow.

## 58 [A/B] Switch

This button switches the actions of the [CLAR(VFO-B)] knob between VFO-A and VFO-B.

Pressing this button once causes the button to glow yellow; in this case, rotation of the [CLAR(VFO-B)] knob affects operation on VFO-B (tuning, etc.). Pressing this button once more causes the button to turn off; in this instance, rotation of the [CLAR(VFO-B)] knob affects operations associated with the VFO-A (Clarifier function, etc.).

## 59 (VFO-B)[RX] Indicator/Switch

This is the button that turns the VFO-B receiver “On” and “Off”. When the VFO-B receiver is active, the button will glow green. Pressing this button again will disable VFO-B receiver, and the imbedded green LED will turn off. Press and hold in this button for two seconds to activate the VFO Traking feature.

## 60 (VFO-B)[TX] Indicator/Switch

This button turns the VFO-B transmitter “On” and “Off”. When this button is pressed, it will glow red and VFO-B will control the transmitter frequency and mode. Pressing this button once more will transfer frequency/mode control back to VFO-A, and the red LED in the button will turn off.

## 61 [CLAR(VFO-B)] Knob

The function of this knob differs according to the settings of the three switches located above the knob. See the next page for details.

## 62 SUB DISPLAY-II

This OLED (Organic Light Emitting Diode) display shows the characteristics of the VFO-A receiver DSP functions selected by five of the buttons located below of this display. The (VFO-A)[SELECT] knob located below this window is an adjustment knob for the function displayed in this window. Alternately, when the Menu Mode is activated, this OLED displays the selected Menu item.



# FRONT PANEL CONTROLS & SWITCHES

## 63 (VFO-A)[VRF/μ-T] Switch

This button turns the VFO-A receiver VRF filter “on” and “off”, and allows you to adjust the center frequency of the VRF filter with the (VFO-A)[SELECT] knob. While activated, the red LED in this button will light up, and the “**VRF**” icon will appear in the FLT column of the Block Diagram Display.

### ADVICE:

When an optional RF μTuning Kit is connected, pressing this button will engage the μ-Tuning filter. The μTuning Kit provides much better RF selectivity than any other RF filter in the Amateur industry, yielding outstanding protection from high RF levels not far removed from the current operating frequency.

## 64 (VFO-A)[SHIFT] Switch

Pressing this button allows you to move the IF DSP bandwidth of VFO-A “higher” or “lower” with the (VFO-A)[SELECT] knob. When the IF passband is shifted, the red LED imbedded in this button will light up. To the contrary, when the IF passband is just centered, the red LED in this button turns off.

## 65 (VFO-A) [CONT/APF] Switch

*In the SSB, AM, and FM modes*, this button turns the VFO-A receiver contour filter “on” and “off”, and allows you to adjust the center frequency of the contour filter with the (VFO-A)[SELECT] knob. When the contour filter is activated, the red LED in this button will light up.

*In the CW mode*, this button turns the VFO-A receiver APF (Audio Peak Filter) “on” and “off”, and allows you to adjust the bandwidth of the APF filter with the (VFO-A)[SELECT] knob. When the APF filter is activated, the red LED in this button will light up.

## [CLAR(VFO-B)] Knob Functions

### When the LED in the [A/B] button is turned “off”

In this case, the [CLAR(VFO-B)] knob is used for Clarifier tuning, as well as Up/Down selection of the Amateur band, Memory Channels, 1 MHz tuning steps, or Memory Groups.

#### Clarifier Operation

When the [CLAR/GRP] button is pressed briefly, the imbedded LED in the button will glow red, and the [CLAR(VFO-B)] knob may be used to program an offset of up to  $\pm 9.999$  kHz from the VFO-A frequency. However, this offset is only applied to the receive or transmit frequency if the [RX CLAR/FAST] button and/or [TX CLAR/LOCK] button, respectively, have been pushed.

To apply the programmed frequency offset to the Receive frequency, press the [RX CLAR/FAST] button briefly. To return to the VFO-A frequency, without the offset, press the [RX CLAR/FAST] button once more. To apply the programmed frequency offset to the Transmit frequency, press the [TX CLAR/LOCK] button briefly. To return the transmitter to the VFO-A frequency, without the offset, press the [TX CLAR/LOCK] button once more.

To reset the Clarifier frequency offset to “0”, press the [CLEAR] button.

#### BAND Up / Down Control

When the [BAND/MCH] button is pressed briefly, the LED in the button will glow red, and enable the use of the [CLAR(VFO-B)] knob to select the desired amateur band. If you have engaged the “My Bands” feature via Menu #145, the [CLAR(VFO-B)] knob will select just from the amateur bands that you have included in the “My Bands” list.

#### Memory Channel / Memory Group Control

Press and hold in the [BAND/MCH] button for two seconds, the LED in the button will glow yellow, and the [CLAR(VFO-B)] knob may be used to select the desired Memory Channel.

Press and hold in the [CLAR/GRP] button for two seconds, the LED in the button will glow yellow, and you may use the [CLAR(VFO-B)] knob to select the desired Memory Group.

### When the LED in the [A/B] button glows orange

When the [A/B] button is pressed, the LED in the button will glow orange, and the [CLAR(VFO-B)] knob will control functions associated with the VFO-B frequency control register.

#### VFO-B FAST Tuning

When the [RX CLAR/FAST] button is pressed, the “**FAST**” icon appears in the display, and the VFO-B tuning step changes to 100 Hz. Press the [RX CLAR/FAST] button once more to return to the normal tuning rate.

#### VFO-B Dial Lock

When the [TX CLAR/LOCK] button is pressed, the “**LOCK**” icon appears in the display, and the [CLAR(VFO-B)] knob is locked. Press the [RX CLAR/FAST] button once more to disable the lock feature.

# FRONT PANEL CONTROLS & SWITCHES

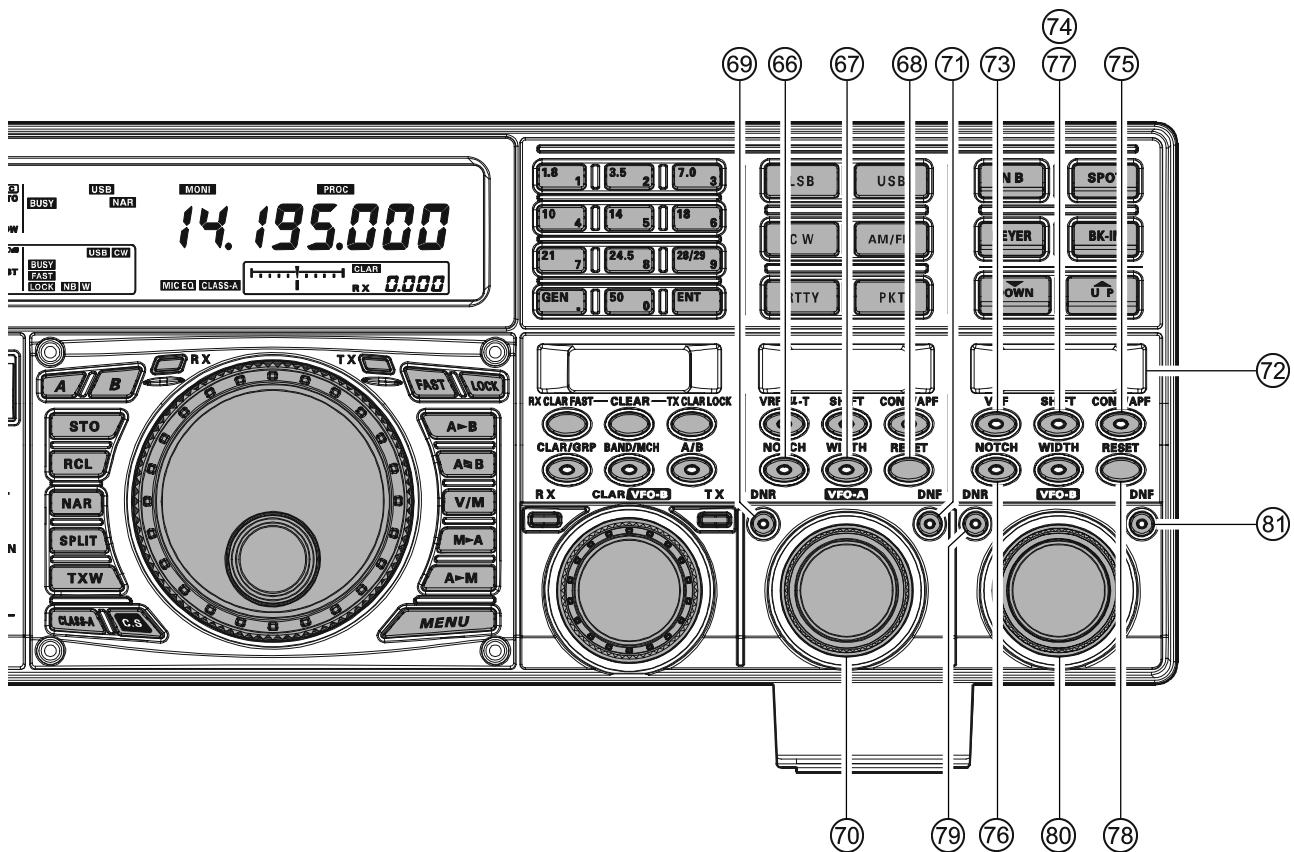

## 66 (VFO-A)[NOTCH] Switch

This button turns the VFO-A receiver IF notch filter “on” and “off”, and allows you to adjust the center frequency of the notch filter with the (VFO-A)[SELECT] knob. When the notch filter is activated, the red LED in this button will light up.

## 67 (VFO-A)[WIDTH] Switch

Pressing this button allows you to adjust the overall bandwidth of the VFO-A receiver IF DSP filter with the (VFO-A)[SELECT] knob. When the bandwidth is set to other than the factory default, the red LED in this button will light up. When the bandwidth is set to default, the red LED in this button turns off.

## 68 (VFO-A)[RESET] Switch

Pressing this button will reset the function selected by the five buttons located above and left of the button to the factory default function.

## 69 (VFO-A)[DNR] Switch

This button toggles the VFO-A Receiver Digital Noise Reduction circuit “on” and “off”, and allows you to adjust the noise reduction level with the (VFO-A)[SELECT] knob. When the Digital Noise Reduction is activated, the red LED in the button will light up.

## 70 (VFO-A)[SELECT] Knob

This knob is used to adjust status of the functions selected by the five buttons located above the knob.

## 71 (VFO-A)[DNF] Switch

This button toggles the VFO-A Receiver Digital Notch Filter “on” and “off”. When the Digital Notch Filter is activated, the red LED in the button will light up. This is an automatic circuit, and there is no adjustment knob for the DNF.

## 72 SUB DISPLAY-III

This OLED (Organic Light Emitting Diode) display shows the characteristics of the VFO-B Receiver DSP functions selected by the five buttons located below of the display. Use the (VFO-B)[SELECT] knob located below this window to adjust the function displayed in the window. Alternately, when the Menu Mode is activated, this OLED displays the current menu selection.

## 73 (VFO-B)[VRF] Switch

This button turns the VFO-B Receiver VRF Filter “on” and “off”, and permits adjustment of the VRF Filter center frequency, using the (VFO-B)[SELECT] knob. While activated, the orange LED in the button will light up, and the “VRF” icon will appear in the FLT column of the Block Diagram Display.

## 74 (VFO-B)[SHIFT] Switch

Pressing this button allows you to move the IF DSP bandwidth of VFO-B “higher” or “lower” with the (VFO-B)[SELECT] knob. When the IF passband is shifted, the orange LED in the button will light up. Alternately, when the IF passband is centered, the LED in the button turns off.

# FRONT PANEL CONTROLS & SWITCHES

## 75 (VFO-B)[CONT/APF] Switch

*In the SSB, AM, and FM modes*, this button turns the VFO-B Receiver Contour Filter “on” and “off”, and enables adjustment of the Contour Filter center frequency with the (VFO-B)[SELECT] knob. When the Contour Filter is activated, the orange LED in the button will light up.

*In the CW mode*, this button turns the VFO-B Receiver APF (Audio Peak Filter) “on” and “off”, and allows you to adjust the bandwidth of the APF filter with the (VFO-B)[SELECT] knob. When the APF filter is activated, the orange LED in the button will light up.

## 76 (VFO-B)[NOTCH] Switch

This button turns the VFO-B Receiver IF notch filter “on” and “off”, and enables adjustment of the notch filter center frequency with the (VFO-B)[SELECT] knob. When the notch filter is activated, the orange LED in the button will light up.

## 77 (VFO-B)[WIDTH] Switch

Pressing this button allows you to adjust the overall bandwidth of the VFO-B receiver IF DSP filter with the (VFO-B)[SELECT] knob. When the bandwidth is set to other than the factory default, the orange LED in the button will light up. Alternately, when the bandwidth is set to default, the orange LED in the button turns off.

## 78 (VFO-B)[RESET] Switch

Pressing this button will reset the function selected by the five buttons above and left of the button to factory default.

## 79 (VFO-B)[DNR] Switch

This button toggles the VFO-B Receiver Digital Noise Reduction circuit “on” and “off”, and allows you to adjust the noise reduction level with the (VFO-B)[SELECT] knob. When the Digital Noise Reduction is activated, the orange LED in the button will light up.

## 80 (VFO-B)[SELECT] Knob

This knob is used to adjust status of the functions selected by the five buttons located above the knob.

## 81 (VFO-A)[DNF] Switch

This button toggles the VFO-A Receiver Digital Notch Filter “on” and “off”. When the Digital Notch Filter is activated, the orange LED in the button will light up. This is an automatic circuit, and there is no adjustment knob for the DNF.

# DISPLAY INDICATIONS (LEFT SIDE)

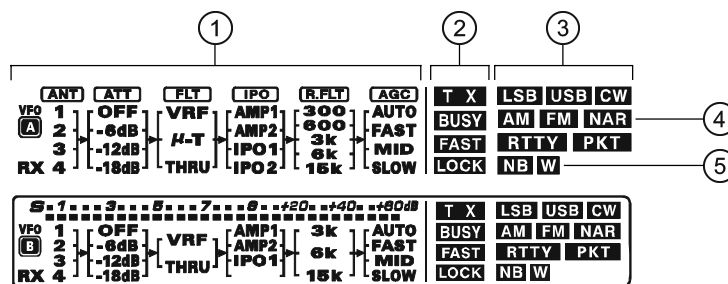

## ① (VFO-A) Block Diagram Display

### ANT (1, 2, 3, 4, RX):

Indicates the antenna selected for operation by the front panel [ANT 1-4] and [RX ANT] switches.

### ATT (OFF, -6 dB, -12 dB, -18 dB):

Indicates the attenuation level selected for operation by the front panel [ATT] button.

### FLT (VRF, $\mu$ -TUNE, THRU):

Indicates the RF filter selected for operation by the front panel (VFO-A)[VRF/ $\mu$ -T] button.

#### ADVICE:

The  $\mu$ -TUNE filter is an option. The “ $\mu$ -T” icon will not appear when the optional  $\mu$ -TUNE unit is not connected.

### IPO (AMP1, AMP2, IPO1, IPO2):

Indicates the front end RF amplifier selected for operation by the front panel [IPO] button.

### R.FLT (300, 600, 3k, 6k, 15k):

Indicates the 1st IF Roofing Filter selected for operation with the front panel [R.FLT] button.

#### ADVICE:

The 300 Hz Roofing Filter is an option except the MP version. The “300” icon will not appear when the optional 300 Hz Roofing Filter is not installed.

### AGC (AUTO, FAST, MID, SLOW):

Indicates the AGC decay time selected for operation by the front panel [AGC] switch.

## ② (VFO-A) Status Indicator

### T X :

This indicator appears during transmission on the VFO-A frequency.

### BUSY :

This indicator appears whenever the VFO-A receiver squelch is open. If this indicator is not showing, and reception seems to have been lost on the VFO-A receiver for no apparent reason, check the position of the (VFO-A)[SQL] knob, and rotate it fully counter-clockwise to restore reception.

### FAST :

This indicator appears when the Main Tuning Dial tuning rate is selected to fast.

### LOCK :

This indicator appears when the Main Tuning Dial knob is locked.

## ③ LSB, USB, CW, AM, FM, RTTY, PKT

Displays the currently-selected operating mode for VFO-A.

## ④ NAR

This indicator appears whenever the VFO-A receiver’s narrow IF DSP filter is engaged.

## ⑤ NB W

The “NB” icon appears when the VFO-A receiver’s (short duration) Noise Blanker is activated.

The “NB W” icon appears when the VFO-A receiver’s (longer-pulse) Noise Blanker is activated.

### IMPORTANT NOTE

The FTDX5000 uses a Vacuum Fluorescent Display (VFD).

With long-term use, it is normal for the indication color to change and the brightness level to decrease.

The 50 % brightness level is rated more than 30 thousand hours.

# DISPLAY INDICATIONS (LEFT SIDE)

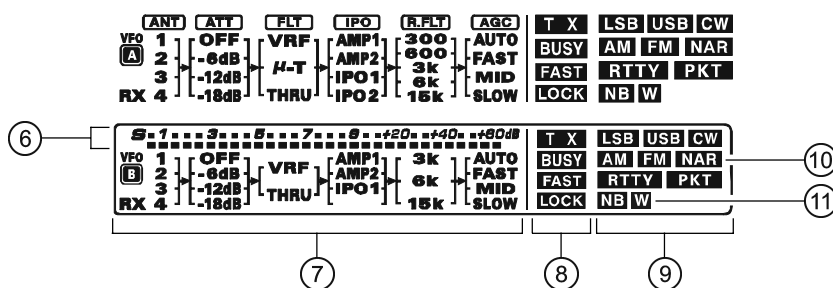

## ⑥ (VFO-B) Receiver S-Meter

Displays the strength of signals received on VFO-B.

## ⑦ (VFO-B) Block Diagram Display

**ANT (1, 2, 3, 4, RX):**

Indicates the antenna selected for operation by the front panel [ANT 1-4] and [RX ANT] switches.

**ATT (OFF, -6 dB, -12 dB, -18 dB):**

Indicates the attenuation level selected for operation by the front panel [ATT] button.

**FLT (VRF, THRU):**

Indicates the RF filter selected for operation by the front panel (VFO-B)[VRF] button.

**IPO (AMP1, AMP2, IPO1):**

Indicates the front end RF amplifier selected for operation by the front panel [IPO] button.

**R.FLT (3k, 6k, 15k):**

Indicates the 1st IF Roofing Filter selected for operation by the front panel [R.FLT] button.

**AGC (AUTO, FAST, MID, SLOW):**

Indicates the AGC decay time selected for operation by the front panel [AGC] switch.

This indicator appears whenever the Digital Noise Reduction feature is activated.

## ⑧ (VFO-B) Status Indicator

**T X:**

This indicator appears during transmission on the VFO-B frequency.

**BUSY:**

This indicator appears whenever the VFO-B receiver squelch is open. If this indicator is not showing, and reception seems to have been lost on the VFO-B receiver for no apparent reason, check the position of the (VFO-B)[SQL] knob and rotate it fully counter-clockwise to restore reception.

**FAST:**

This indicator appears when the [CLAR(VFO-B)] knob's tuning rate is selected to fast.

**LOCK:**

This indicator appears when the [CLAR(VFO-B)] knob is locked.

## ⑨ LSB, USB, CW, AM, FM, RTTY, PKT

Displays the currently-selected operating mode for VFO-B.

## ⑩ NAR

This indicator appears whenever the VFO-B receiver's narrow IF DSP filter is engaged.

## ⑪ NB W

The “NB” icon appears when the VFO-B receiver's (short duration) Noise Blanker is activated.

The “NB W” icon appears when the VFO-B receiver's (longer-pulse) Noise Blanker is activated.

# DISPLAY INDICATIONS (RIGHT SIDE)

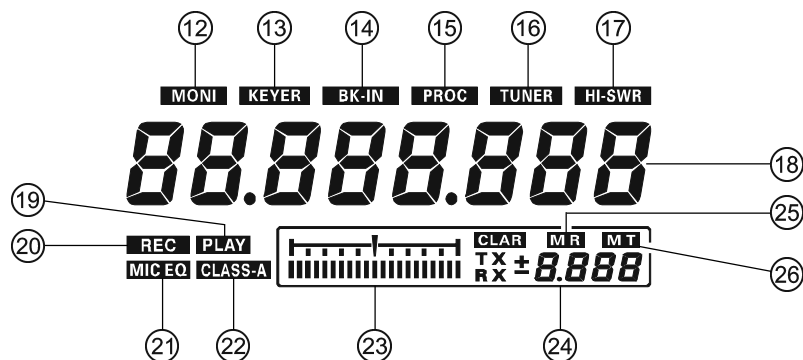

## 12 MONI

This indicator appears when the transmit monitor circuit is activated.

## 13 KEYER

This indicator appears when the internal CW keyer is activated.

## 14 BK-IN

This indicator appears when CW break-in operation is activated.

## 15 PROC

This indicator appears when the DSP Speech Processor is activated.

## 16 TUNER

This indicator appears when the internal Automatic Antenna Tuner is activated.

## 17 HI-SWR

This indicator appears if the directional coupler and microprocessor detect an abnormally high SWR condition (over 3.0:1) that cannot be resolved by the Automatic Antenna Tuner.

### NOTE:

If this indicator appears, check to be sure that you have the correct antenna selected on the current operating band. If so, you will need to check the condition of the antenna, its coaxial cable, and/or the connectors on the cable, to locate and correct the fault.

## 18 VFO-A Frequency Display

This is the VFO-A frequency display.

## 19 PLAY

This indicator appears while the voice recorder is playing back the recorded audio, and/or the memory is playing back the recorded CW or voice message.

## 20 REC

This indicator appears while the voice recorder is recording the receiver audio, and/or the memory is recording your CW or voice message.

## 21 MICEQ

This indicator appears when the Three-Band Parametric Microphone Equalizer is activated via the Menu.

## 22 CLASS-A

This indicator appears when Class-A operation is engaged.

## 23 Tuning Offset Indicator

This is a tuning scale that, as configured from the factory, provides a visual CW tuning indication of the incoming signal's offset from your transceiver's CW carrier frequency, as programmed by the relative clarifier offset, or the peak position of the VRF/ $\mu$ -TUNE filter.

## 24 CLAR

This indicator appears when the Clarifier function is activated.

### ADVICE:

When adjusting some knobs, the current value will appear in this area.

## 25 MR

This indicator appears when the transceiver is in the Memory Recall mode.

## 26 MT

This indicator appears when the transceiver is in the Memory Tune mode to indicate that the memory contents have been temporarily changed.

# REAR PANEL CONNECTIONS

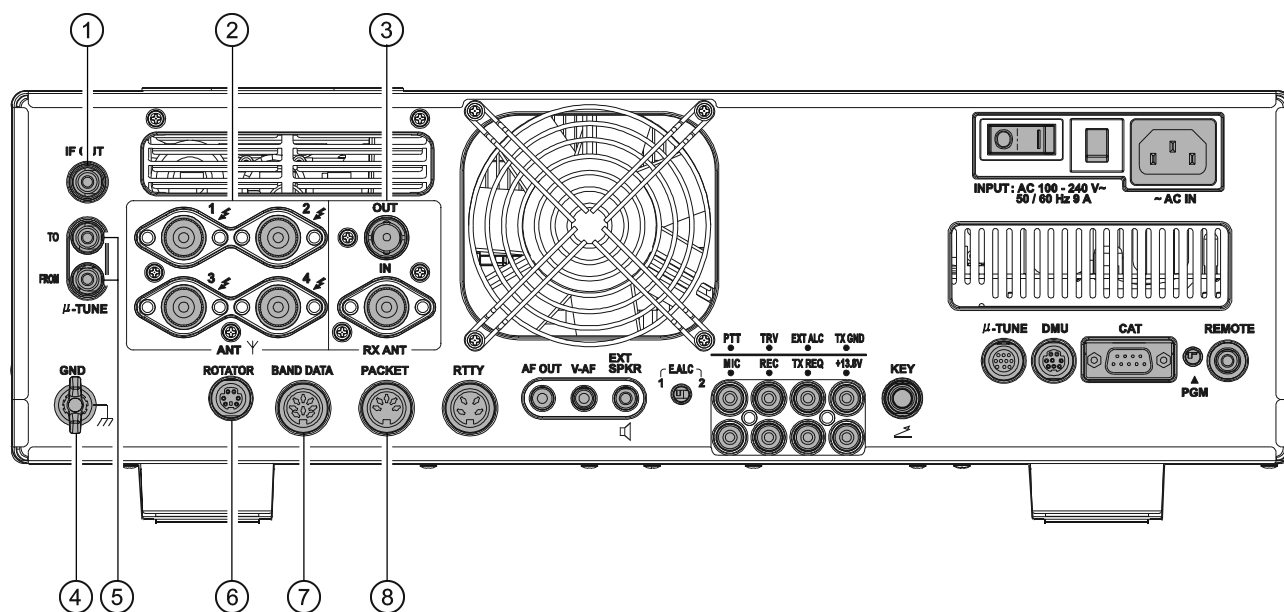

## ① IF OUT Jacks

This RCA jack outputs the 9 MHz IF signal of the received signal when Menu item “109 RGEN IF OUT” is set to “ENABLED”. This signal does not pass through the roofing filter.

## ② ANT 1, 2, 3, 4 Jacks

Connect your main antenna(s) here, using a type-M (PL-259) plug and coaxial feedline for each. These antenna ports are always used for transmission. They are also used for reception, unless a separate receive antenna is connected to the **RX ANT IN** jack and used for the receiver. The internal antenna tuner affects only the antenna(s) connected here, and only during transmission.

### ⚠ Warning!

The 141V RF voltage (@200 W/50 Ω) is applied to the TX RF section of the transceiver while transmitting. Do not touch the TX RF section absolutely while transmitting.

## ③ RX ANT IN Jack

The BNC jack provides output of the receiver signal from the Antenna jacks, which are connected to the “RX” side of the transceiver T/R switching circuitry. The type-M jack is for a separate, receive-only antenna. An antenna connected here can be used when the [**RX ANT**] button on the front panel is pressed.

If you want to use some special kind of external bandpass filter or preamplifier, you may connect it between the “RX ANT OUT” and “RX ANT IN” jacks.

## ④ GND

Use this terminal to connect the transceiver to a good earth ground, for safety and optimum performance. Use a large diameter, short braided cable for making ground connections. Please refer to page 9 for other notes about proper grounding.

## ⑤ μ-TUNE Jacks

These jacks are used for signal input/output of the optional RF μTuning Kits.

## ⑥ ROTATOR Jack

This 6-pin MINI-DIN Jack accepts a cable connected to a YAESU **G-800DXA/-1000DXA/-2800DXA** (for USA/EXP market) or **G-800DXC/-1000DXC/-2800DXC** (for European market) Antenna Rotator (listed models are current as of early 2010). You may control the antenna azimuth rotation (and rotation speed) using the Function buttons on the front panel.

## ⑦ BAND DATA Jack

This 8-pin output jack provides band selection data which may be used for control of optional accessories such as the **VL-1000** Solid-state Linear Amplifier.

## ⑧ PACKET Jack

This 5-pin input/output jack provides receiver audio and squelch signals, and accepts transmit (AFSK) audio and PTT control, from an external Packet TNC. Pinout is shown on page 15. The receiver audio level at this jack is approximately 100 mVp-p (@600 Ohms).

# REAR PANEL CONNECTIONS

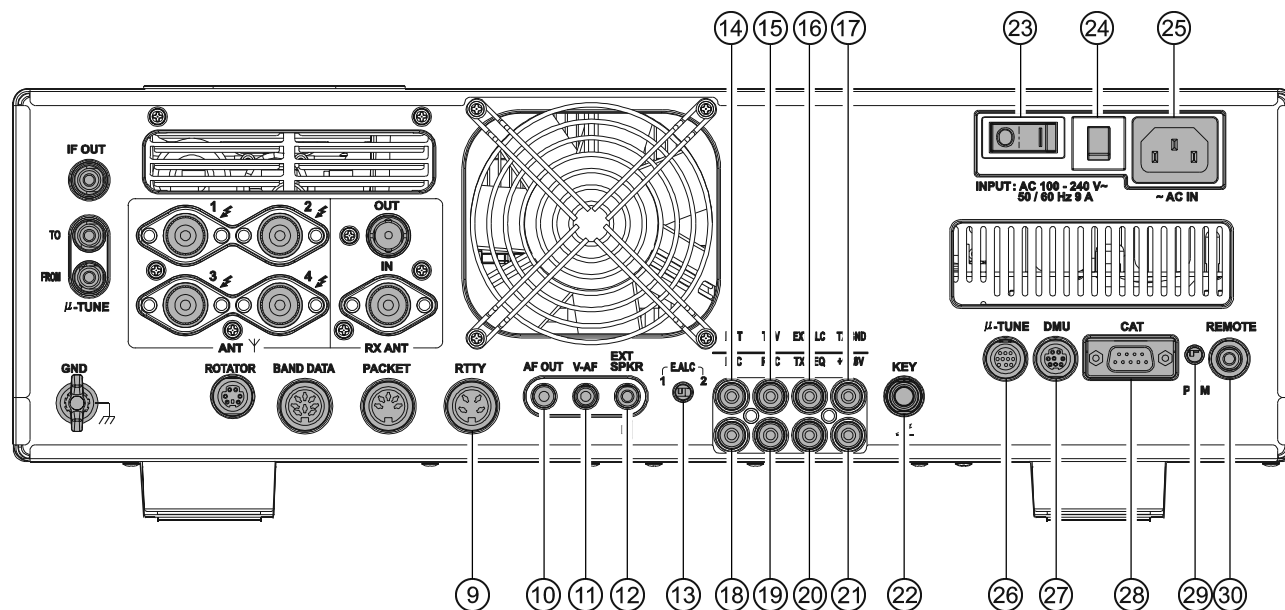

## ⑨ RTTY Jack

This 4-pin input/output jack provides connections for an RTTY terminal unit. Pinout is shown on page 15. The receiver audio level at this jack is at a constant 100-mV (@600 Ohms) level. FSK keying at this jack is accomplished by a closure of the SHIFT line to ground by the terminal unit.

## ⑩ AF OUT Jack

This 3.5-mm, 3-contact jack provides dual-channel low-level receiver output, for recording or external amplification. Peak signal level is 300 mVp-p at 10 k-Ohms. The VFO-A receiver audio is on the left channel (tip), and the VFO-B receiver audio is on the right channel (ring). A stereo amplifier or recorder is recommended, to record each receiver's audio separately when dual reception is enabled (audio from either receiver, or both, may be used). The front panel [AF GAIN] knobs do not affect the signals at this jack.

## ⑪ V-AF Jack

This 3.5-mm, 3-contact jack is used for connection to the optional **SM-5000** Station Monitor.

## ⑫ EXT SPKR Jack

This 3.5-mm, 2-contact jack provides receiving audio output from the VFO-A and VFO-B receivers for an external loudspeaker or speakers, such as the **SP-2000**. Inserting a plug into the jack disables the internal loudspeaker. Impedance is 4 ~ 8 Ohms.

## ⑬ E.ALC Switch

This slide switch is used to select the ALC gain; it is normally set to position "1". Slide the switch to position "2", if the ALC gain is too high for the connected linear amplifier.

## ⑭ PTT Jack

This RCA input jack may be used to provide manual transmitter activation using a footswitch or other switching device. Its function is identical to the [MOX] button on the front panel. The same line is available at the **PACKET** and **RTTY** jacks for TNC control. Open circuit voltage is +13.5 VDC, and closed-circuit current is 5 mA.

## ⑮ TRV Jack

This RCA jack provides a low level RF output for use with a transverter. Maximum output is approximately -10 dBm (0.1 mW) at 50 Ohms.

*In the UK version*, 135.7 - 137.8 kHz TX signal is output from this terminal. Output level is +10 dBm at 50 Ohms.

## ⑯ EXT ALC Jack

This RCA input jack accepts negative-going external ALC (Automatic Level Control) voltage from a linear amplifier, to prevent over-excitation by the transceiver. Acceptable input voltage range is 0 to -4 VDC.

## ⑰ TX GND Jack

This RCA jack is closed to ground while the transmitter is engaged. It may be used for control of a peripheral device, most typically a linear amplifier. To enable the jack, set Menu item "172 TGEN ETX-GND" to the "ENABLE".

The relay circuit used for this jack is capable of switching an AC voltage of 100 Volts at up to 300 mA, or a DC voltage of 60 V at 200 mA, or DC 30 V at up to 1 Amp.



## ⑱ MIC (PATCH) Jack

This RCA input jack accepts either AFSK or voice audio, for transmission. This line is mixed with the microphone audio input line, so the microphone should be disconnected if using this jack and mixing is not desired. The optimum impedance is 500 ~ 600 Ohms, and the nominal input level should be 5 mV.

## ⑲ REC Jack

This RCA jack provides low-level receiver audio output and transmit (monitor) audio (requires the [MONI] button is turned on), for external recording or external amplification. Peak signal level is 30 mVp-p at 10 k-Ohms.

## ⑳ TX REQ Jack

When this RCA jack is shorted to ground, it puts the transceiver into the transmit mode, and sends out a steady CW carrier, for linear amplifier or manual antenna tuner adjustment.

## ㉑ +13.8 V Jack

This RCA output jack provides regulated, separately fused 13.8 VDC at up to 200 mA, to power an external device such as a packet TNC. Make sure your device does not require more current (if it does, use a separate power source).

## ㉒ KEY Jack

This 1/4-inch, 3-contact jack accepts a CW key or keyer paddle. Key-up voltage is +5 V, and key-down current is 1 mA. Plug wiring is shown on page 15, and the jack may be configured for keyer, “Bug,” “straight key,” or computer keying interface operation via Menu item “059 A1A R-TYPE.”

### NOTE:

**You cannot use a 2-contact plug in this jack (to do so produces a constant “key down” condition).**

## ㉓ Main Power Switch

This is the main power “on” (I) / “off” (O) switch of the transceiver. Always turn this switch on before turning on the front panel [POWER] button.

If this switch is not turned “on”, the front panel [POWER] switch will not function.

## ㉔ Circuit Breaker Switch

This circuit breaker shuts off in the event of dangerously high current consumption by the transceiver.

### ADVICE:

If the Circuit Breaker interrupts power, by all means try to determine the cause of the over-current condition before re-applying power. To restore the Circuit Breaker after verifying that all is normal, push the switch in until you hear a “click”.

## ㉕ ~AC IN Jack

Connect the supplied 3-wire AC line cord to this socket. AC voltages of 100-240 V may be accommodated by the transceiver without any sort of modification (universal voltage input).

## ㉖ μ-TUNE Jack

This 10-pin MINI-DIN jack is used for control of the optional RF μTuning Kits.

## ㉗ DMU Jack

This 8-pin MINI-DIN jack accepts a cable connected to an optional **DMU-2000** Data Management Unit or **SM-5000** Station Monitor.

## ㉘ CAT Jack

This 9-pin serial DB-9 jack allows external computer control of the transceiver. Connect a serial cable here and to the RS-232C COM port on your personal computer (no external interface is required).

## ㉙ PGM (PROGRAM) Switch

This slide switch is used for updating the transceiver’s firmware. The update software and instructions are available for download from the Vertex Standard website (<http://www.yaesu.com/>).

## ㉚ REMOTE Jack

By plugging the supplied **FH-2** Remote Control Keypad into this jack, direct access to the CPU is provided, for control of functions such as the audio playback feature, and the contest memory keyer, plus frequency and function control.

# FH-2 SWITCHES

The supplied Remote Control Keypad “**FH-2**” can be used to control the voice memory capability for the SSB/AM/FM modes, and the contest memory keyer for the CW mode. You can also play-back up to 15 seconds of incoming received audio, for verification of a missed callsign or other purposes. Some specific capabilities of the **FH-2** are:

- On SSB/AM/FM modes, five channels of storage and playback of voice memory (20 seconds each), using your own voice for recording (see page 80).
- On CW mode, the **FH-2** provides storage and recall of CW messages for repetitive CQ and contest number transmissions (see pages 94 and 96).
- Play-back of the last 15 seconds of incoming receiver audio (see page 45).

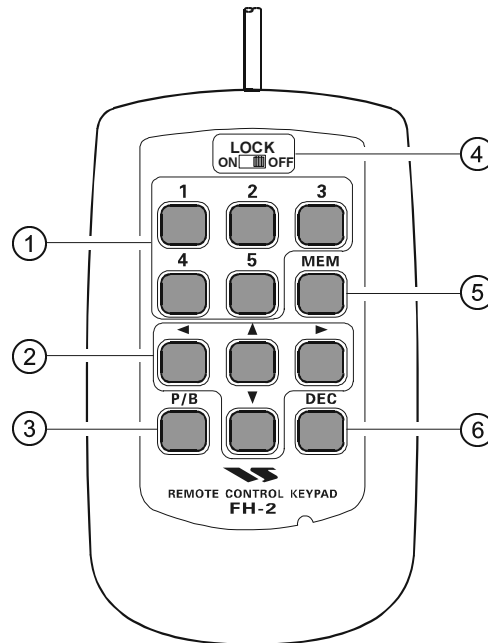

## ① [1], [2], [3], [4], [5] Switches

These buttons work as the Voice Memory and CW Message Memory Selection Key.

In the case of Voice Memory, up to 20 seconds of audio may be stored on each channel.

For CW Messages and CW Text Messages, up to 50 characters (“PARIS” specification) may be stored into each channel.

## ② [◀], [▶], [▲], [▼] Switches

Usually, these buttons are used for tuning the VFO frequency. Press the [▲]/[▼] buttons to change the frequency in the same increments as the microphone [UP]/[DWN] switches. Press the [◀]/[▶] buttons to change the frequency by 100 kHz steps.

When programming the Contest Memory Keyer, these buttons are used to move the cursor and select the text characters.

## ③ [P/B] Switch

This button is used for playing back the last 15 seconds of recorded receiver audio.

## ④ [LOCK] Switch

This button may be used to lock out the **FH-2** key buttons, to prevent accidental activation of **FH-2** operations.

## ⑥ [MEM] Switch

Press this button to store either a Voice Memory, or a Contest Keyer Memory.

## ⑦ [DEC] Switch

When utilizing the sequential contest number capability of the Contest Keyer, press this button to decrement (decrease) the current Contest Number by one digit (i.e. to back up from #198 to #197, etc.).

# ***BASIC OPERATION: RECEIVING ON AMATEUR BANDS***

---



Before turning on main power, please verify the following precautions once more.

- Verify all ground connections are secure. See page 9 for details.
- Connect the antenna(s) to the rear-panel Antenna jack(s). See page 10 for details.
- Connect the microphone (and/or key or paddle). See pages 11 and 12 for details.
- If using a linear amplifier, verify the interconnections have been successfully completed? See pages 13 and 14 for details.
- Rotate both [**AF GAIN**] controls to their fully counter-clockwise positions, to avoid a loud blast of audio when the transceiver turns on. See page 21 for details.
- Rotate the [**RF PWR**] control fully counter-clockwise, to set minimum power to begin. See page 20 for details.
- If your AC mains power should suffer a significant fluctuation or interruption, we recommend that you go through a complete power-up cycle, in order to ensure that all circuits are properly initialized. To do this, be sure the front panel [**POWER**] switch is turned off, then set the rear panel main power switch to the “**●**” position. Now unplug the AC cable from the rear panel, and wait ten seconds before continuing with the start-up procedure described on the next page.

# BASIC OPERATION: RECEIVING ON AMATEUR BANDS

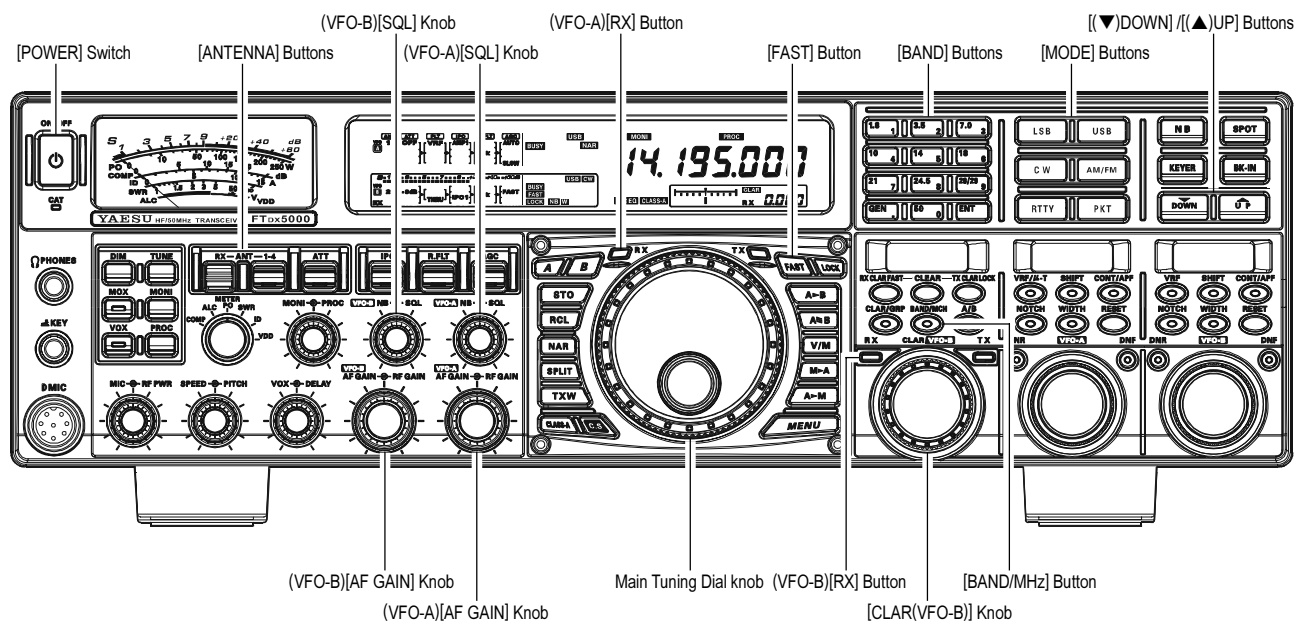
Here is the typical start-up procedure for normal operation:



1. Plug the AC cable back in, set the rear panel main power switch to the “I” position. 
2. Press and hold in the front panel [POWER] switch for one second to turn the transceiver on. 
3. The transceiver will start up on 7.000.00 MHz LSB, and normal operation may begin.

**NOTE:**

To turn power off, press and hold in the front panel [POWER] switch for one second.

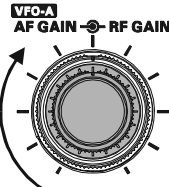
4. Rotate the (VFO-A)[AF GAIN] knob to set a comfortable audio level on incoming signals or noise. Clockwise rotation of the (VFO-A)[AF GAIN] knob increases the volume level. 

**NOTE:**

When using headphones, start by rotating the (VFO-A)[AF GAIN] knob counter-clockwise, then bring the volume level up after you put the headphones on. This will minimize the chance of damage to your hearing caused by an unexpectedly-high audio level.

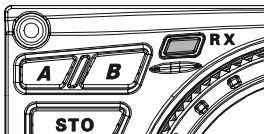
5. Press the (VFO-A)[RX] button to engage the VFO-A receiver; the imbedded LED will glow green. 

**ADVICE:**

- If you press the (VFO-A)[RX] button when the LED is already glowing green, the LED will begin blinking; this indicates that the VFO-A receiver is temporarily muted. Press the (VFO-A) [RX] button once more to restore VFO-A receiver operation.

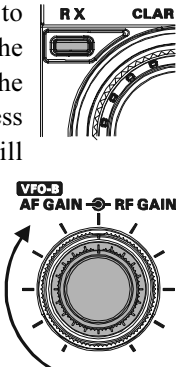
- Press the (VFO-B)[RX] button to engage Dual Reception (using the VFO-B receiver in addition to the VFO-A receiver). When you press the (VFO-B)[RX] button, it will glow green; pressing the button once more will turn the VFO-B receiver off, and the LED will go dark. Use the (VFO-B)[AF GAIN] knob to adjust the VFO-B receiver volume level. 

6. Press the [BAND] button corresponding to the Amateur band you wish to operate on. 

**ADVICE:**

- One-touch selection of each Amateur band between 1.8 and 50 MHz is provided.
- The FTdx5000 utilizes a triple band-stack VFO selection technique. This permits you to store up to three favorite frequencies and modes for each band in the VFO registers. For example, you may store one frequency for 14 MHz CW, one for RTTY, and one for USB, then recall each VFO by successive, momentary presses of the [14] MHz band button. Each Amateur band button has three frequency/mode settings associated with it.

# BASIC OPERATION: RECEIVING ON AMATEUR BANDS

- ❑ If you press the [BAND/MCH] button briefly, the button glows red, and the [CLAR(VFO-B)] knob may be used as the band selection knob.

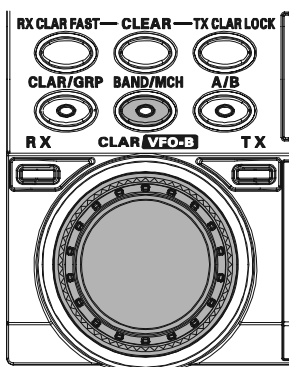

- Press the [▼(DOWN)]/[▲(UP)] buttons to tune the VFO-A frequency in 1 MHz



**ADVICE:**

You may change the tuning step to 100 kHz via Menu item “144 TUN MHz SEL”. See page 133.

- Move the [ANT 1-4] button up or down to select the appropriate antenna for the band in use. Alternatively, you may also press the [RX ANT] button to select the receive antenna, if one is connected. Up to four TX/RX antennas and one RX-only antenna may be connected.

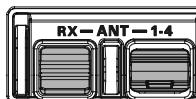

**ADVICE:**

- ❑ Your antenna selection is “remembered” (in conjunction with the frequency and mode) in the VFO register in use, when you choose that particular antenna.
- ❑ When VFO-A and VFO-B are switched to the same antenna jack, VFO-B receiver will be automatically connected to the RX ANT jack.
- ❑ When both VFO-A and VFO-B are switched to the RX ANT, the signal output from the RX OUT jack is connected to the VFO-A receiver.

- Press the appropriate [MODE] button to select the desired operating mode.

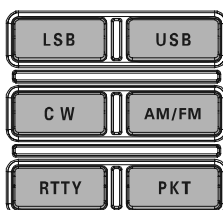

**ADVICE:**

- ❑ By convention in the Amateur bands, LSB is used on the 7 MHz and lower bands (with the exception of 60 meters), while USB is utilized on the 14 MHz and higher bands.
- ❑ When changing modes from SSB to CW, you will observe a frequency shift on the display. This shift represents the BFO offset between the “zero beat” frequency and the audible CW pitch (tone) you can hear (the pitch is programmed by the [PITCH] knob), even though the actual tone that you hear is not changing. If you do not want this frequency shift to appear when changing modes, you may change the BFO offset setting in Menu item “066 A1A FRQ DISP”, described on page 127.

- ❑ When operating on the FM mode in the VFO-A, rotate the (VFO-A)[SQL] (Squelch) knob clockwise just to the point where the background noise is silenced. This is the point of maximum sensitivity to weak signals. Excessive advancement of the Squelch knob will degrade the ability of the receiver to detect weak signals. Adjustment of the VFO-B Squelch is accomplished using the (VFO-B)[SQL] knob.

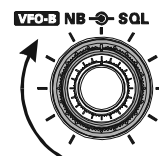
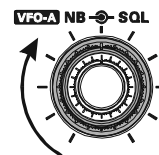

- Rotate the Main Tuning Dial knob to tune around the band, and begin normal operation.

**ADVICE:**

- ❑ Clockwise rotation of the Main Tuning Dial knob increases the operating frequency, one “step” of the synthesizer at a time; similarly, counter-clockwise rotation of the Main Tuning Dial knob will decrease the frequency.

A “normal” and a “fast” step choice is available on each operating mode. Pressing the [FAST] button engages the “Fast” tuning selection.

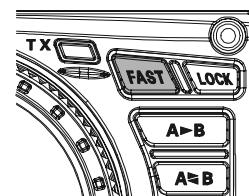

OPERATING MODE	1 STEP	1 DIAL ROTATION
LSB, USB, CW, RTTY, PKT(LSB)	10Hz [100Hz]	10kHz [100kHz]
AM, FM, PKT(FM)	100Hz [1kHz]	100kHz [1MHz]

[ ] : [FAST] switch set to “ON”

- ❑ It is possible to set the frequency dial rotation steps separately, solely for CW mode operation, using Menu items “142 TUN DIALSTP”, and “143 TUN CW FINE”. See page 133.
- ❑ If you want to navigate frequency change quickly, there are several techniques available:
  - Direct keyboard entry of the frequency (see page 49).
  - Use of the microphone [UP]/[DWN] scanning keys, if your microphone is so equipped (see page 49).

## ANTENNA CIRCUIT DIAGRAM

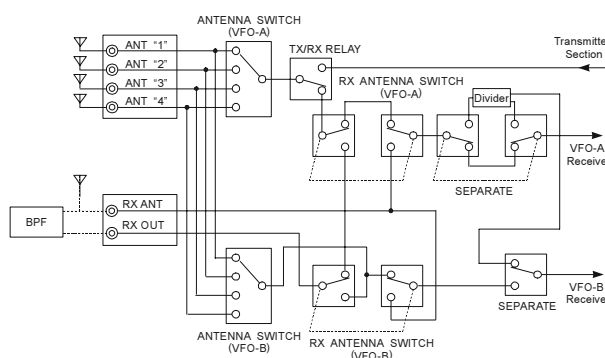

# BASIC OPERATION: RECEIVING ON AMATEUR BANDS

## CLAR (CLARIFIER) OPERATION ON VFO-A

The [RX CLAR/FAST], [CLEAR], [TX CLAR/LOCK] buttons, and the [CLAR(VFO-B)] knob are used to offset the receive, the transmit, or both frequencies from their settings on VFO-A (the Clarifier does not affect VFO-B). The four small numbers on the LCD display show the current Clarifier offset. The Clarifier controls on the FTdx5000 are designed to allow you to preset an offset up to  $\pm 9.999$  kHz without actually retuning, and then activate it using the Clarifier [RX CLAR/FAST] and [TX CLAR/LOCK] buttons. This feature is ideal for following a drifting station, or for setting the small frequency offsets sometimes utilized in DX “Split” operation.

Here is the technique for utilizing the Clarifier:

1. Press the [RX CLAR/FAST] button. The “**CLAR**” and “**RX**” icons will appear in the display, and the programmed offset will be applied to the receive frequency.



### ADVICE:

If the “**CLAR**” and “**RX**” icons do not appear, check to see if the [A/B] button glows orange. If so, press the [A/B] button to cause the LED in the [A/B] button to go out. Now, press the [RX CLAR/FAST] button to begin clarifier operation.

2. Rotation of the [CLAR(VFO-B)] knob will allow you to modify the initial offset on the fly. Offsets of up to  $\pm 9.999$  kHz may be set using the Clarifier.



To cancel Clarifier operation, press the [RX CLAR/FAST] button. The “**CLAR**” and “**RX**” icons will disappear from the display.

### ADVICE:

Turning the clarifier “off” simply cancels the application of the programmed offset from the receive and/or transmit frequencies. To clear out the programmed clarifier offset altogether, and reset it to “zero,” press the [CLEAR] button.

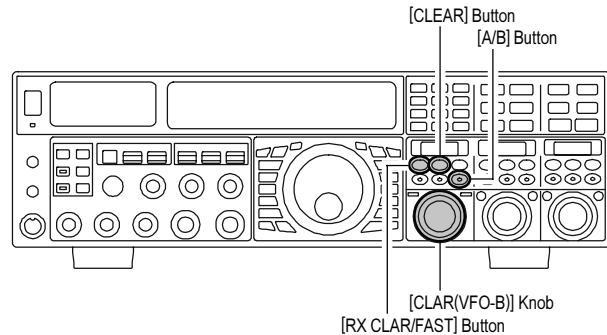

### TX CLAR

Without changing the receive frequency, you may alternatively apply the Clarifier offset to the transmit frequency (typically, for “split” DX pile-ups). See page 82 for details.

### The Tuning Offset Indicator provides a graphical representation of the Clarifier offset.

In CW mode, the Tuning Offset Indicator depicts the CW Center Tuning, instead of the Clarifier Offset, this is the factory default setting. If you wish to change this, so that the Clarifier Offset is also displayed on CW, use the following procedure:

1. Press the [MENU] button to enter the Menu mode.
2. Rotate the (VFO-A)[SELECT] knob to select Menu item “012 DISP BAR SEL”.
3. Rotate the (VFO-B)[SELECT] knob to select “CLAR (Clarifier)” (replacing the default “CW TUNE (CW TUNING)” selection).
4. Press and hold in the [MENU] button for two seconds to save the new setting and exit to normal operation.

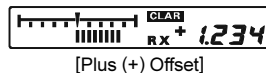

[Plus (+) Offset]



[Zero Offset]



[Minus (-) Offset]

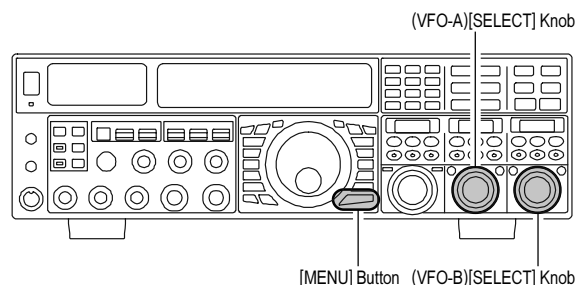

# BASIC OPERATION: RECEIVING ON AMATEUR BANDS

## LOCK

You may lock the setting of the Main Tuning Dial knob, to prevent accidental frequency change.

To lock out the Main Tuning Dial knob, just press the **[LOCK]** button that is located to the right of the Main Tuning Dial knob. To unlock the Dial setting, and restore normal tuning, just press the **[LOCK]** button once more.

When the Main Tuning Dial knob is “locked”, the blue **“LOCK”** icon will appear on the display.

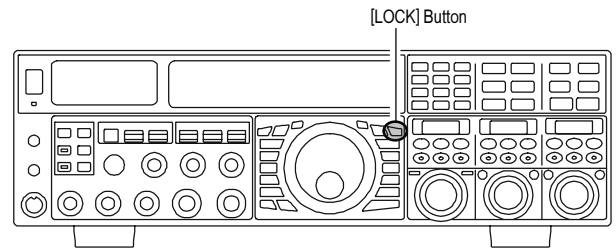

## DIM

The illumination level of the analog meter and frequency display may be reduced, if you are using the transceiver in a dark environment where high brightness is not desired.

To reduce the illumination level, press the **[DIM]** button, located to the left of the analog meter. To restore full brightness, press the **[DIM]** button once more.

### ADVICE:

The amount of brightness may be customized for different front panel areas. The following menu settings are effective when the **[DIM]** button is depressed:

- 008 DISP DIM MTR:** for analog meter
- 009 DISP DIM VFD:** for frequency display
- 010 DISP DIM OLE:** **SUB DISPLAY** windows
- 011 DISP DIM ELCD:** for Spectrum Scope display of the optional **SM-5000** Station Monitor

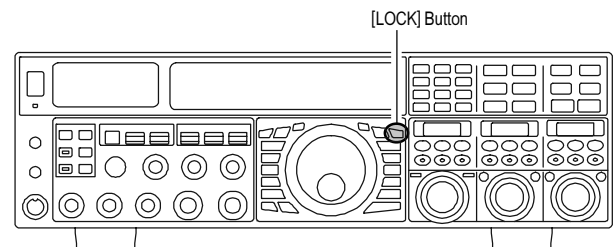

## OPERATION ON 60-METER (5 MHz) BAND (U.S. AND U.K. VERSIONS ONLY)

The recently-released 60-meter band is covered, in the **FTDX5000**, by fixed memory channels. These channels are set to USB, and they appear between the “last” PMS channel (“P-9U”) and the first “regular” memory channel (Channel 1).

To operate on the 60-meter (5 MHz) band:

1. Press the **[V/M]** button once, if necessary, to enter the “Memory” mode (the **“MR”** icon will appear on the display).
2. Press and hold in the **[BAND/MCH]** button for two seconds. The button will glow yellow to signify that rotation of the **[CLAR(VFO-B)]** knob will allow selection of the memory channel.
3. Memory channels (“US-1” through “US-5”: U.S. version or “US-1” through “US-7”: U.K. version) are pre-programmed, at the factory, with the permitted frequencies in the 5 MHz band, and the USB mode is automatically selected on these channels.
4. To exit from 60-meter operation and return to the VFO mode, just press the **[V/M]** button.

### NOTE:

The frequencies and operating mode for 5 MHz band operation are both fixed, and may not be changed.

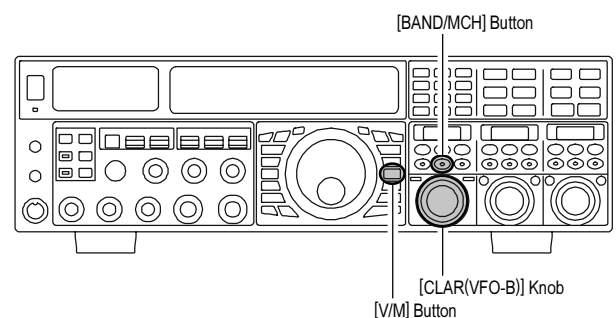

CHANNEL NUMBER	FREQUENCY	
	U.S. VERSION	U.K. VERSION
US-1	5.332000 MHz	5.260000 MHz
US-2	5.348000 MHz	5.280000 MHz
US-3	5.368000 MHz	5.290000 MHz
US-4	5.373000 MHz	5.368000 MHz
US-5	5.405000 MHz	5.373000 MHz
US-6	—	5.400000 MHz
US-7	—	5.405000 MHz

# CONVENIENCE FEATURES

## DUAL RECEIVE

The **FTdx5000** is capable of simultaneous reception, using the VFO-A and VFO-B receivers, in what is called the “Dual Receive” mode. This is especially useful for DX work, here is the operating procedure for Dual Receive operation.

1. While receiving on VFO-A, engage the VFO-B receiver by pressing the **(VFO-B)[RX]** button, located to the upper left of the **[CLAR(VFO-B)]** knob. You will now be receiving on the two frequencies shown on the LCD display (for VFO-A) and **SUB DISPLAY-1** (for VFO-B).
2. Adjusting the volume:  
To adjust the VFO-A audio level, rotate the **(VFO-A)[AF GAIN]** knob. To adjust the VFO-B audio level, rotate the **(VFO-B)[AF GAIN]** knob. In both cases, clockwise rotation of the knob will increase the volume level.
3. Press the **[B]** button, located to the upper left of the Main Tuning Dial knob. The **[B]** button will glow orange, and you may now change the operating mode of the VFO-B receiver by pressing the appropriate **[MODE]** selection button.
4. You may also press the **[BAND]** buttons to select the operating band for the VFO-B receiver.
5. To return the mode and band selections to VFO-A, press the **[A]** button, located to the left of the **[B]** button. The **[A]** button will glow red, and you may now change the operating mode and band of the VFO-A receiver.
6. Rotate the Main Tuning Dial knob to adjust the Main VFO-A frequency, and rotate the **[CLAR(VFO-B)]** knob to adjust the VFO-B frequency.

### ADVICE:

If the VFO-B frequency does not change, check to see if the orange LED in the **[A/B]** button is illuminated. If not, pressing the **[A/B]** button will cause the **[A/B]** button to glow orange. Now, rotate the **[CLAR(VFO-B)]** knob to adjust the VFO-B frequency.

7. To cancel Dual Receive operation, and receive only on the VFO-A receiver, press the **(VFO-B)[RX]** button; the imbedded green LED will go out, and monoband operation on the VFO-A receiver will resume.

### NOTE:

Remember that, while the **[B]** button glows orange, any mode or band changes will still be applied to the VFO-B receiver, whether or not Dual Receive is engaged.

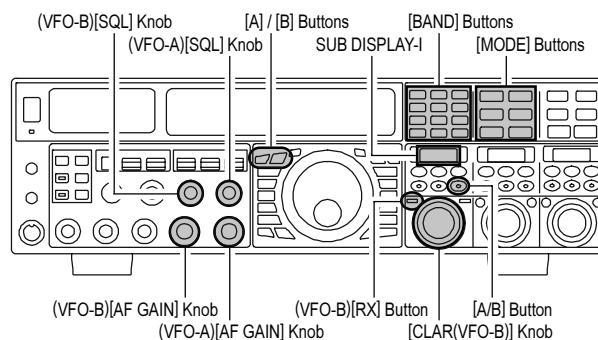

### QUICK POINT:

By convention in the amateur bands, LSB is used on the 7 MHz and lower bands (with the exception of 60 meters), while USB is utilized on the 14 MHz and higher bands.

### ADVICE:

- When operating in Dual Receive, the manner in which the audio is fed to the left and right headphones (Stereo, Monaural, or Mixed) may be configured using Menu item “**108 ROUT HEADPHN**” (see page 130).
- When changing modes from SSB to CW, you will observe a frequency shift on the display. This shift represents the BFO offset between the “zero beat” frequency and the audible CW pitch (tone) you can hear (the pitch is programmed by the **[PITCH]** knob), even though the actual tone that you hear is not changing. If you do not want this frequency shift to appear when changing modes, you may change the BFO offset setting in Menu item “**066 A1A FRQ DISP**”, described on page 127.
- When operating on the FM mode on the VFO-B receiver, rotate the **(VFO-B)[SQL]** knob clockwise just to the point where the background noise is silenced. This is the point of maximum sensitivity to weak signals. Excessive advancement of the **(VFO-B)[SQL]** knob will degrade the ability of the receiver to detect weak signals. Adjustment of the VFO-A squelch is accomplished using the **(VFO-A)[SQL]** knob.



---

---

## DUAL RECEIVE

---

---

### Using Headphones for Dual Receive

To take advantage of dual reception, you will want to connect stereo headphones to the **PHONES** jack. In addition to the **AF GAIN** controls, headphone audio mixing can also be configured as desired from Menu item “**108 ROUT HEADPHN**”. Three audio mixing schemes are selectable as follows:

**SEPARATE:** Audio from the VFO-A receiver is heard only in the left ear, and VFO-B receiver audio solely in the right ear.

**COMBINE1:** Audio from both VFO-A and VFO-B receivers can be heard in both ears, but VFO-B audio is attenuated in the left ear and VFO-A audio is attenuated in the right ear.

**COMBINE2:** Audio from both VFO-A and VFO-B receivers are combined and heard equally in both ears (“Monaural” mode).

### VFO Tracking Feature

You may lock VFO-B to track in unison with VFO-A when the main tuning dial is adjusted. See page 84 for details.

Go to Menu item “**038 GENE TRACK**” to set the tracking function as follows:

**OFF:** VFO-A and VFO-B tune independently (Default)

**BAND:** Band Change operations will be applied to VFO-A and VFO-B simultaneously.

**FREQ:** VFO-A and VFO-B tune in unison when The Main Tuning dial is adjusted. However, VFO-B may be adjusted separately.

### Sideband Diversity Reception

Here you receive a single AM signal through the two receivers, each receiving the opposite sideband. Skywave-propagated signals often show phase distortion in this mode, but it gives you a view of the entire passband, from which you can then select the best sideband for listening (or for SWL Dx’ing, you may want to listen to both sidebands at the same time, to get the best copy). On groundwave signals, where the phase of the sidebands is likely to be the same, there is an interesting sense of depth to the signal.

To tune in a signal using this mode, you should have stereo headphones connected to the front panel **PHONES** jack.

- Set VFO-A to either LSB or USB mode, and tune for zero beat on the desired signal.
- Press the [**A►B**] button to copy this mode and frequency into VFO-B, then press the [**MODE**] button to select the opposite sideband for VFO-A.
- If using headphones, set the headphone mixing scheme to the “COMBINE1” mode via Menu item “**108 ROUT HEADPHN**”, and activate dual reception.
- Adjust the [**AF GAIN**] knob(s) to balance the volume of the two receivers.
- If interference is present on one of the channels, you may have to turn its [**AF GAIN**] knob to suppress that channel (or press the green [**RX**] button to disable the receiver with the sideband experiencing interference). Otherwise, try changing the headphone audio mixing scheme to “COMBINE2” or “SEPARATE” in the Menu item “**108 ROUT HEADPHN**”, for different effects (or try settings with similar effects, if you use an external audio amplifier). Although you don’t get the “stereophonic” effect in the monaural mode, the two signals are still mixed, offering the potential for much better copy than in regular AM or even single-sideband ECSS modes.

# CONVENIENCE FEATURES

## DUAL RECEIVE

### Bandwidth Diversity Reception

This mode involves receiving the same signal through two different bandpass filters. The frequency and mode of both VFO-A and VFO-B are the same. VFO-A can be set up for a wide bandpass, using the **[WIDTH]** knobs, and VFO-B for a narrow bandpass, resulting in a spatial perception of the channel. Although any mode (except FM) can be used, CW offers the widest array of choices, and perhaps the most startling effects on crowded channels.

Stereo headphones or external stereo speakers are recommended for this mode. To set up the transceiver for bandwidth diversity reception:

- Select the desired mode on VFO-A.
- Tune to the signal of interest.
- Press the **[A▶B]** button to copy this mode and frequency into the VFO-B.
- If using headphones, set the headphone mixing scheme to the "COMBINE1" mode via Menu item "**108 ROUT HEADPHN**", and activate dual reception.
- Adjust the **[AF GAIN]** knob(s) to balance the volume of the two receivers.
- Now try manipulating the **[SHIFT]** and **[WIDTH]** knobs to observe the interesting effects of bandwidth diversity.

### Polarity Diversity

Similar in concept to the bandwidth diversity just described, another interesting capability of the **FTDX5000** dual reception, is the ability to use two different antennas on the same frequency. For example, you might have a horizontal Yagi on the main band, and a vertical antenna on the sub band, then lock the two frequencies together and engage dual reception.

Frequently, the fading observed on the HF bands is not so much a change in ionization level, but rather a shift in the polarization of the signal as it travels to and from the ionosphere. Having an opposite-polarization antenna available can fill in the signal during deep fades. You may then transmit on whichever antenna is providing the strongest signal at the moment (see the discussion below on Split Frequency operation).

## P.BACK (AUDIO PLAYBACK) FROM MAIN (VFO-A) RECEIVER

When Audio Playback is engaged by the operator, the **FTdx5000** begins automatically recording the last 15 seconds of incoming receiver audio on VFO-A. Recording is controlled with the supplied **FH-2** Remote Control Keypad, plugged into the rear panel **REMOTE** jack. This capability is especially useful for confirming a callsign that may have been difficult to copy due to noise or QRM, etc.

### Recording

- ❑ Press and hold in the **FH-2**'s **[P/B]** key for two seconds to initiate recording. The "**REC**" icon will appear in the display to confirm that recording is in progress.
- ❑ Press the **FH-2**'s **[P/B]** key briefly to halt recording; the "**REC**" icon will go out.

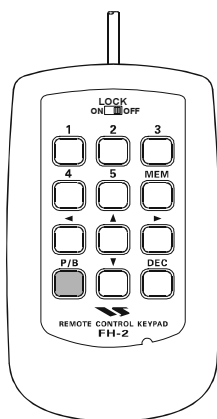

### Playback

- ❑ Press the **FH-2**'s **[P/B]** key *briefly*, after recording has been halted, to begin playback of the recorded audio; the "**PLAY**" icon will appear in the display to confirm that playback is in progress. The last 15 seconds of audio will be heard in the speaker or headphones. If you do not intervene, the entire 15 seconds will be played back, repeating endlessly.
- ❑ To halt playback at any time, just press the **[P/B]** key briefly again. The next time you press the **[P/B]** key, it will pick up the playback where you left off.

### ADVICE

You may adjust the playback level of the recording with the main **[AF GAIN]** knob.

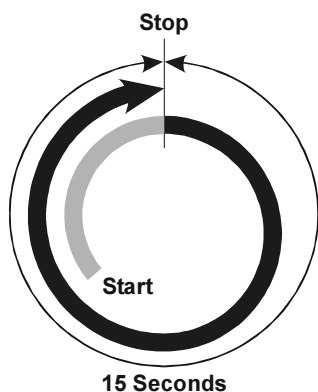

# CONVENIENCE FEATURES

## “MY BANDS” OPERATION

When operating on an amateur band, it is possible to use the [CLAR(VFO-B)] knob to change the selected operating band. The “My Bands” feature allows you to designate several amateur bands, and make *only* those bands available for selection with the [CLAR(VFO-B)] knob.

This feature can be *very* useful in a contest, where the 10/18/24 MHz bands are not used, or if you do not have antennas for some bands.

### “My Bands” Setup

1. Press the [MENU] button to engage the Menu mode.
2. Rotate the (VFO-A)[SELECT] knob to select Menu item “150 TUN MY BAND”.
3. Rotate the (VFO-B)[SELECT] knob to choose a band that you wish to *skip* (omit) from the band-selection loop (when using the [CLAR(VFO-B)] knob for band selection). The available choices are 1.8M/3.5M/7M/10M/14M/18M/21M/24M/28M/50M/GEN(General Band)/T14M(Transverter “1”)/T28M(Transverter “2”)/T50M(Transverter “3”).
4. Press the [ENT] button (one of the [BAND] buttons) to set the selected band to “skipped”. The “ON” notation at the right of the band notation will change to “OFF”.
5. Repeat steps 3 and 4 to select (“ON”) or deselect (“OFF”) as many bands as you like.
6. Press and hold in the [MENU] button for two seconds to lock in the new configuration and exit to normal operation.

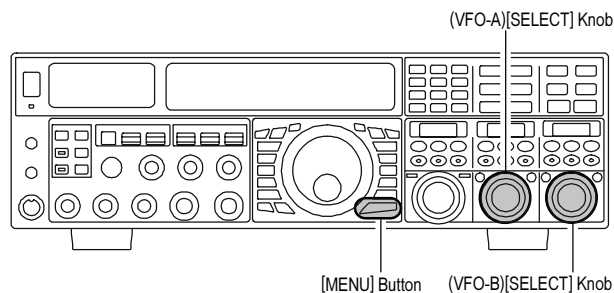

### ADVICE:

The “My Band” feature affects *only* VFO-A band.

### “My Band” Operation

1. Press the [V/M] button once, if necessary, to enter the “VFO” mode.
2. Press the [BAND/MCH] button briefly; the button will glow Red.
3. Rotate the [CLAR(VFO-B)] knob to choose the amateur band on which you wish to operate. Only those amateur bands that have not been skipped will appear as you scroll through the bands.

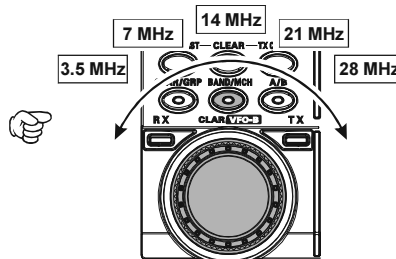
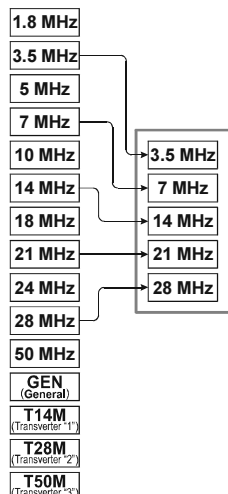
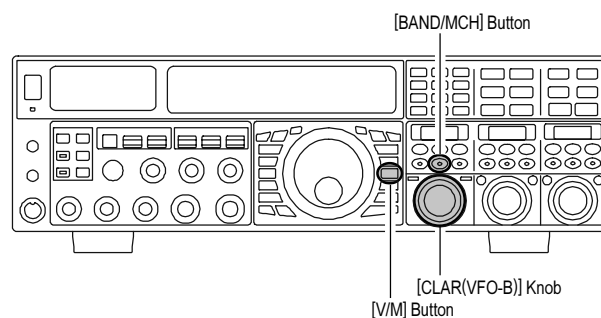

## BAND STACK OPERATION

The **FTdx5000** utilizes a triple band-stack VFO selection technique that permits you to store up to three favorite frequencies and modes onto each band's VFO register. For example, you may store one frequency each on 14 MHz CW, RTTY, and USB, then recall each VFO by successive, momentary presses of the [**14**] MHz band button. Each Amateur band key may similarly have up to three frequency/mode settings applied. Both the VFO-A and VFO-B systems have their own, independent, band stacks.

A typical setup, for the 14 MHz band, might be arranged like this:

1. Program 14.025 MHz, CW Mode, then press the [**14**] MHz band button;
2. Program 14.080 MHz, RTTY Mode, then press the [**14**] MHz band button;
3. Program 14.195 MHz, SSB Mode, then press the [**14**] MHz band button.

With this configuration, successive momentary presses of the [**14**] MHz band button will allow you to toggle sequentially through these three VFO configurations.

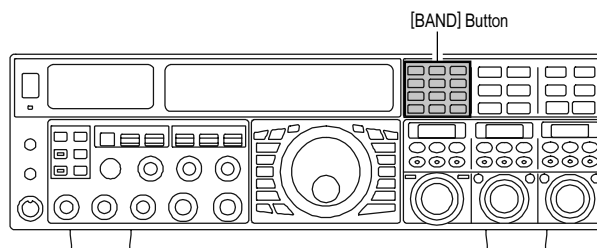

## C.S (CUSTOM SWITCH)

An often-used Menu mode selection may be programmed to the front panel [**C.S**] button.

### C.S Setup

1. Press the [**MENU**] button to engage the Menu mode; the Menu list will appear on the **SUB DISPLAY** windows.
2. Rotate the (**VFO-A**)[**SELECT**] knob to select the Menu item you want to be able to access via the [**C.S**] button.
3. Press and hold in the [**C.S**] button for two seconds to lock in your selection.
4. Press and hold in the [**MENU**] button for two seconds to save the new configuration and exit to normal operation.

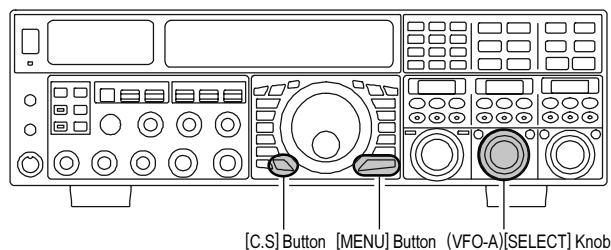

### Menu Selection Recall via [**C.S**] button

1. Press the [**C.S**] button. The programmed Menu item will appear on the display.
2. You may now rotate the (**VFO-B**)[**SELECT**] knob to change the setting of this menu item.
3. Press the [**MENU**] button for two seconds, when you are done, to save the new configuration and exit to normal operation.

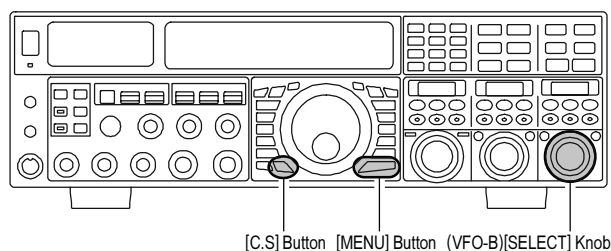

# CONVENIENCE FEATURES

## ROTATOR CONTROL FUNCTIONS

When using a YAESU model **G-800DXA**, **G-1000DXA**, **G-2800DXA** (for USA/EXP market) or **G-800DXC**, **G-1000DXC**, **G-2800DXC** (for European market) Antenna Rotator (not supplied), it is possible to control it from the front panel of the **FTdx5000**.

- 1 Press and hold in the **[ENT]** button (one of the **[BAND]** buttons) for two seconds. The **SUB DISPLAY** windows will change, and display the “Rotator Control” configuration.
- 2 Press either the **[3.5(2)]** button or the **[7.0(3)]** button to rotate the antenna. Pressing the **[3.5(2)]** button will cause rotation to the left (counter-clockwise), while pressing the **[7.0(3)]** button will cause rotation to the right (clockwise).
- 3 Press the **[14(5)]** button or the **[18(6)]** button to control the speed of rotation. Pressing the **[14(5)]** button will cause slower rotation, while pressing the **[18(6)]** button will speed up rotation. Usually, you will be using the “100%” setting.

When you are through exercising rotator control, press the **[ENT]** button briefly. The **SUB DISPLAY** windows will return to the normal display.

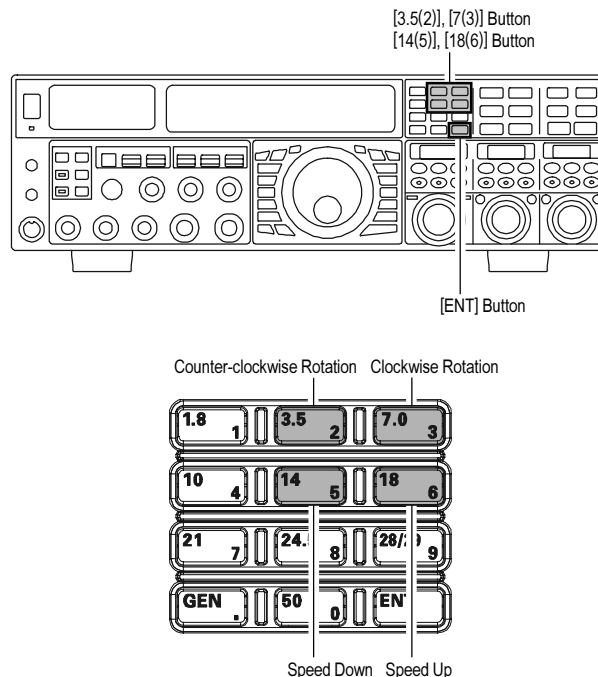

### IMPORTANT NOTE

- ❑ Set the **FTdx5000** to match the starting point of your rotator control indicator needle via Menu item “**014 DISP RTR STU**”. The default setting is “0” (north). If your controller starting point is south, the Menu item “**014 DISP RTR STU**” must be set to “180”. If not set properly the **FTdx5000** display will not show the correct direction.
- ❑ When the rotator control indicator needle does not indicate the precise antenna direction, adjust the indicator needle precisely to the antenna direction via Menu item “**015 DISP RTR ADJ**”.

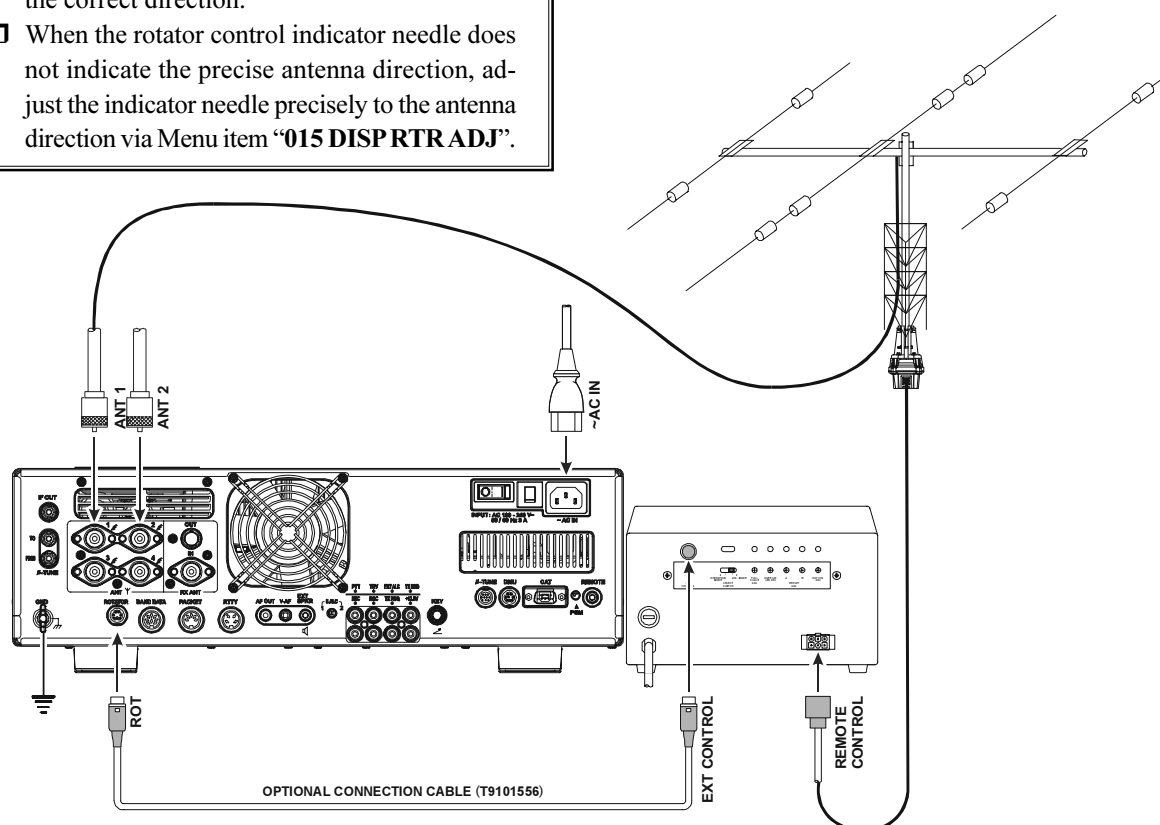

## MORE FREQUENCY NAVIGATION TECHNIQUES

### Keyboard Frequency Entry

You may enter operating frequencies, for either the VFO-A or VFO-B bands, using the front panel band/frequency selection keys.

#### Example 1: Enter 14.250.000 MHz into VFO-A

1. Press the [ENT] button to engage the direct frequency entry process. Now, beginning with the “10 MHz” digit of the frequency (the leftmost digit), we will enter the required digits of the frequency. 
2. Press, in order, the digits of the operating frequency, using the [BAND] buttons (which have the frequency-entry digit or decimal point on the right side of the slash bar). In this example, enter [1.8/1] → [10/4] → [GEN./.] → [3.5/2] → [14/5] → [50/0] → [50/0] → [50/0] → [50/0]  
The decimal point after the “MHz” portion of the frequency must be entered, but no decimal point is required after the “kHz” portion.
3. Press the [ENT] button once more. A short “beep” will confirm that the frequency entry was successful, and the new operating frequency will appear on the Main (VFO-A) frequency display fields.

#### Example 2: Enter 7.100.000 MHz into VFO-B

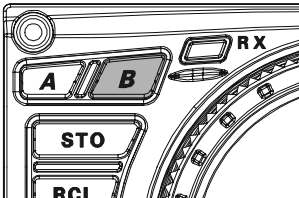
1. Press the [B] button, located to the upper left of the Main Tuning Dial knob. The [B] button will glow orange. 
2. Press the [ENT] button to engage the direct frequency entry process. Now, beginning with the “10 MHz” digit of the frequency (the leftmost digit), we will enter the required digits of the frequency to be entered into the VFO-B register.
3. Press, in order, the digits of the operating frequency, using the [BAND] buttons (which have the frequency-entry digit or decimal point on the right side of the slash bar). In this example, enter [21/7] → [GEN./.] → [1.8/1] → [50/0] → [50/0] → [50/0] → [50/0] → [50/0]
4. Press the [ENT] button once more. A short “beep” will confirm that the frequency entry was successful, and the new operating frequency will appear on the VFO-B frequency display, **SUB DISPLAY-I** window.

#### ADVICE:

If you attempt to enter a frequency outside the operating range of 30 kHz ~ 60 MHz, the microprocessor will ignore the attempt, and you will be returned to your previous operating frequency. If this happens, please try again, taking care not to repeat the error in the frequency entry process.

### Using the [▼(DOWN)]/[▲(UP)] Buttons

- To tune the VFO-A frequency in 100 kHz step. Press the [▲(UP)] or [▼(DOWN)] button. 
- To tune the VFO-B frequency in 100 kHz step. Press the [B] button first (The [B] button will glow orange), then press the [▲(UP)] or [▼(DOWN)] button.

#### ADVICE:

You may change the tuning step of the [▲(UP)]/[▼(DOWN)] buttons to 1 MHz via the Menu item “144 TUN MHz SEL”. See page 133.

### Using the [UP]/[DWN] Switches of the Supplied MH-31B8 Hand Microphone

The [UP]/[DWN] switches on the supplied MH-31B8 Hand Microphone may also be used for manually scanning upward or downward in frequency.

The microphone [UP]/[DWN] switches utilize the tuning steps of the Main Tuning Dial knob; moreover, when the microphone [FAST] key is pressed, the tuning rate will change to 100 Hz, similar to the effect of the transceiver front-panel [FAST] button.

#### ADVICE:

In the AM and FM modes, you may independently set the tuning steps when using the [UP]/[DWN] switches. To set new tuning steps, use Menu items “145 TUN AM STEP” and “146 TUN FM STEP”.

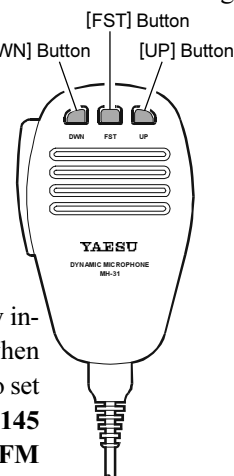

### Using the [◀]/[▶]/[▲]/[▼] Switches of the Supplied FH-2 Remote Control Keypad

The [◀]/[▶]/[▲]/[▼] switches on the supplied FH-2 Remote Control Keypad may also be used for manually changing of the VFO-A frequency.

Press the [▲]/[▼] buttons to change the frequency in the same increments as the microphone [UP]/[DWN] switches. Press the [◀]/[▶] buttons to change the frequency by 100 kHz steps.

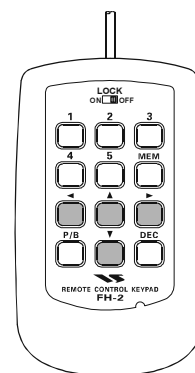

# CONVENIENCE FEATURES

## RECEIVER OPERATION (FRONT END BLOCK DIAGRAM)

The **FTDx5000** includes a wide range of special features to suppress the many types of interference that may be encountered on the HF bands. However, real world interference conditions are constantly changing, so optimum setting of the controls is somewhat of an art, requiring familiarity with the types of interference and the subtle effects of some of the controls. Therefore, the following information is provided as a general guideline for typical situations, and a starting point for your own experimentation.

Yaesu provides the optional RF- $\mu$ TUNING Unit (Narrow-bandwidth High-Q RF Filter) for additional protection from strong signal interference.

### VRF (SEE PAGE 54)

On the 1.9 - 28 MHz amateur bands, Yaesu's powerful VRF (Variable RF Filter) preselector circuit provides excellent suppression of out-of-band interference. The pass-band is much narrower than that provided by traditional fixed bandpass filters.

### R. FLT (IF Roofing Filters) (SEE PAGE 56)

On the VFO-A receiver, Roofing filters, in bandwidths of 15 kHz, 6 kHz, 3 kHz, 600Hz, and 300 Hz (optional in some models), are provided in the 9 MHz First IF, right after the first mixer. These filters provide narrow-band selectivity to protect the following IF and DSP stages. The 15 kHz, 6 kHz, or 3 kHz filters are automatically selected for typical operating modes, and may be manually changed by the operator, if desired, for special operating circumstances.

The VFO-B receiver 40 MHz IF includes three Roofing filters, with bandwidths of 15 kHz, 6 kHz, and 3 kHz.

### CONTOUR Filter (SEE PAGE 58)

The DSP Contour filter is a unique capability of the **FTDx5000**, providing either nulling or peaking of tunable segments of the receiver passband. The Contour filter can suppress interference, or excessive frequency components on an incoming signal, or it can peak those tunable frequency segments. The amount of nulling/peaking, and the bandwidth over which it is applied, are adjustable via the Menu.

### IF SHIFT (SEE PAGE 60)

The passband center frequency response of the IF DSP filtering may be adjusted using this control.

### IF WIDTH (SEE PAGE 61)

The width of the IF DSP filtering may be adjusted using this control.

### IF NOTCH (SEE PAGE 63)

The IF Notch filter is a high-Q notch filter that can significantly reduce, or eliminate, an interfering carrier. The Q (sharpness) of the filter may be adjusted using the Menu.

### DNR (DIGITAL NOISE REDUCTION) (SEE PAGE 64)

The DSP's Digital Noise Reduction (DNR) feature utilizes sixteen different mathematical algorithms to analyze and suppress different noise profiles encountered on the HF/50 MHz bands. Choose the selection that provides the best noise suppression, which concurrently will allow the signal to rise up out of the noise.

### DNF (DIGITAL NOTCH FILTER) (SEE PAGE 64)

When multiple interfering carriers are encountered during reception, the Digital Notch Filter can significantly reduce the level of these signals.

### AGC (SEE PAGE 67)

The AGC system is highly adaptable to changing signal and fading characteristics, making reception possible under the most difficult conditions.

### SLOPED AGC (SEE PAGE 68)

Instead of limiting a wide range of audio output signals to a fixed upper bound, the sloped AGC system actually allows the audio output to rise, very gently, with ever-increasing signal strength. This capability allows you to mentally separate signals, according to signal strength, in addition to slight frequency differences.

### IF Filter Quality Adjustment (SEE PAGE 131)

The "Q" (quality factor) of the IF DSP filters may be adjusted using the Menu.

### Variable IF Filter Shape Factor (SEE PAGE 131)

You may adjust the shape factor of the receiver IF DSP filters using the Menu.

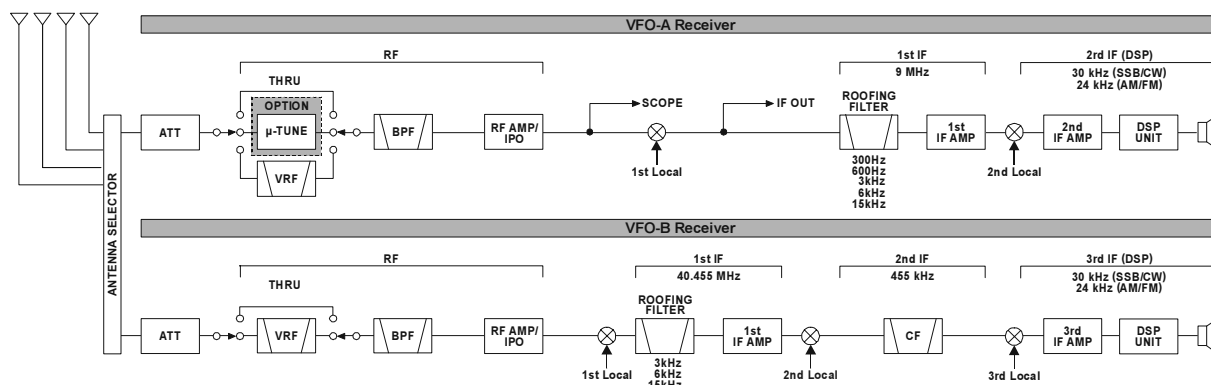



## IPO (INTERCEPT POINT OPTIMIZATION)

The IPO feature allows the operator to optimize the characteristics of the receiver front end, depending on the current noise level and the strength of incoming signals.

### VFO-A IPO Setup

- Press the **[A]** button to activate VFO-A receiver (The **[A]** button will glow red).
- Move the **[IPO]** knob up or down to set the desired characteristic of the VFO-A receiver front end, per the chart below.

**AMP1:** Amplifies the incoming signal, using a low distortion RF preamplifier (normally, the IPO is set to this position).

**AMP2:** Increases receiver sensitivity.

**IPO1:** Improves the IPO.

**IPO2:** Bypasses the RF preamplifier, yielding direct feed to the first mixer. As a result, the IPO is improved more.

The selected receiver RF preamplifier will be indicated in the IPO column of the Block Diagram Display.

ANT	ATT	FLT	IPO	R.FLT	AGC
VFO 1	OFF	VRF	AMP1	300	AUTO
VFO 2	-6dB	H-T	AMP2	600	FAST
VFO 3	-12dB	THRU	IPO1	3k	MID
RX 4	-18dB		IPO2	15k	SLOW

- Press the **[IPO]** knob briefly, to quickly set the IPO to "AMP1".

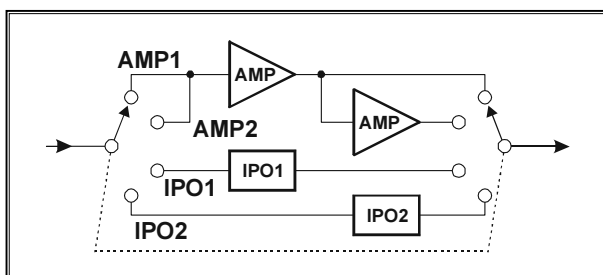
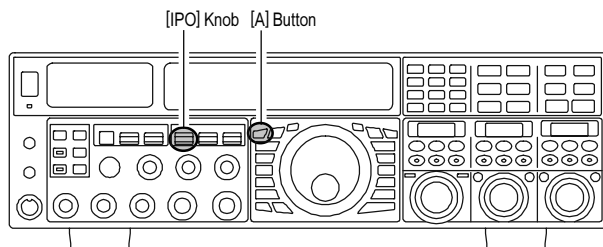

### VFO-B IPO Setup

- Press the **[B]** button to activate VFO-B receiver (The **[B]** button will glow orange).
- Move the **[IPO]** knob up or down to set the desired characteristic of the VFO-B receiver front end, per the chart below.

**AMP1:** Amplifies the incoming signal, using a low distortion RF preamplifier (normally, the IPO is set to this position).

**AMP2:** Increases receiver sensitivity.

**IPO1:** Improves the IPO.

The selected receiver RF preamplifier will be indicated in the IPO column of the Block Diagram Display.

S	1	3	5	7	9	+20	+40	+60dB
VFO	1	OFF	VRF	AMP1	3k	AUTO		
VFO	2	-6dB	H-T	AMP2	6k	FAST		
VFO	3	-12dB	THRU	IPO1	15k	MID		
RX	4	-18dB		IPO2		SLOW		

- Press the **[IPO]** knob briefly, to quickly set the IPO to "AMP1".

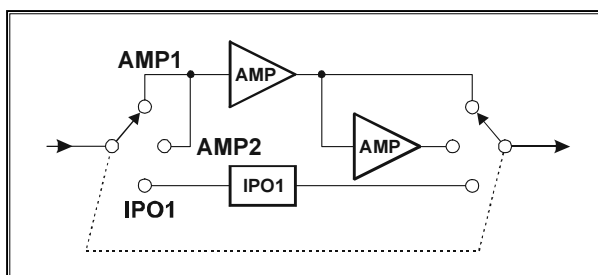
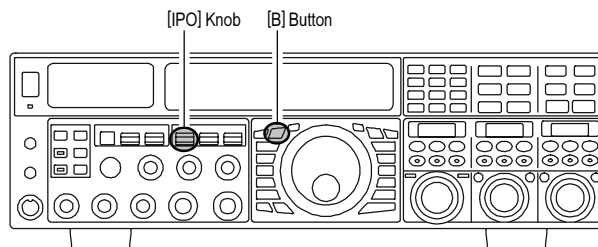

### ADVICE:

On the 10 MHz and lower bands, it generally is not necessary to use any preamplifier at all; selecting the "IPO" position as described above will increase the strong-signal-handling capability of the receiver, and usually result in more pleasant reception due to reduced noise. If you can hear band noise with the preamplifiers disengaged, then a preamplifier is generally not needed.

# CONVENIENCE FEATURES

## ATT

Even with the IPO function on, extremely strong local signals or high noise can still degrade reception. In such situations, you can use the [ATT] button to insert 6, 12, or 18-dB of RF attenuation in front of the RF amplifier.

### VFO-A ATT Setup

- Press the [A] button to activate VFO-A receiver (The [A] button will glow red).
- Move the [ATT] knob up or down to set the desired attenuation level of the VFO-A receiver, per the chart below.

OFF: Attenuator is Off  
 -6 dB: The incoming signal power is reduced by 6 dB (Signal voltage reduced by 1/2)  
 -12 dB: The incoming signal power is reduced by 12 dB (Signal voltage reduced to 1/4)  
 -18 dB: The incoming signal power is reduced by 18 dB (Signal voltage reduced to 1/8)

The selected attenuation level will be indicated in the ATT column of the Block Diagram Display.



- To quickly restore full signal strength through the Attenuator circuit, press the [ATT] knob in briefly to restore the ATT display to the “OFF”.

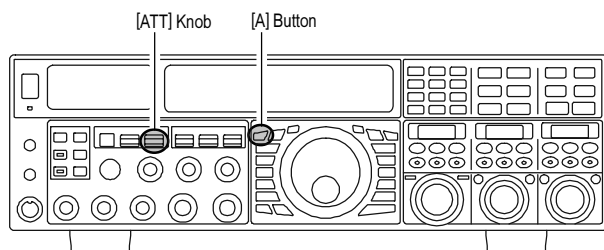

### VFO-B ATT Setup

- Press the [B] button to activate VFO-B receiver (The [B] button will glow orange).
- Move the [ATT] knob up or down to set the desired attenuation level of the VFO-B receiver, per the chart below.

OFF: Attenuator is Off  
 -6 dB: The incoming signal power is reduced by 6 dB (Signal voltage reduced by 1/2)  
 -12 dB: The incoming signal power is reduced by 12 dB (Signal voltage reduced to 1/4)  
 -18 dB: The incoming signal power is reduced by 18 dB (Signal voltage reduced to 1/8)

The selected attenuation level will be indicated in the ATT column of the Block Diagram Display.

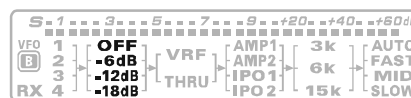

- To quickly restore full signal strength through the Attenuator circuit, press the [ATT] knob in briefly to restore the ATT display to the “OFF”.

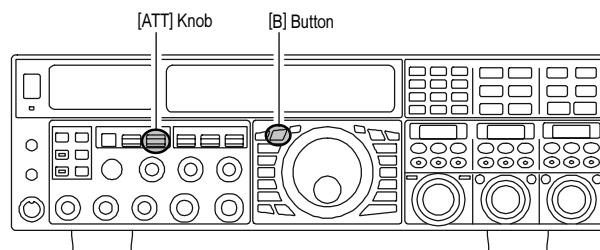

### ADVICE:

If background noise causes the S-meter to deflect on clear frequencies, move the [ATT] knob until the S-meter drops to about “S-1”. This setting optimizes the trade-offs between sensitivity, noise, and interference immunity. Also, once you have tuned in a station you want to work, you may want to reduce sensitivity further (or add more attenuation) by moving the [ATT] knob to a greater setting. This reduces the strength of all signals (and noise) and can make reception more comfortable, important especially during long QSOs. When looking for weak signals on a quiet band, you will want maximum sensitivity, so the IPO should be disabled and the [ATT] knob should be set to “OFF” by pressing the [ATT] knob. This situation is typical during quiet times on frequencies above 21 MHz, and when using a small or negative-gain receiving antenna on other bands.

## RF GAIN (SSB/CW/AM MODES)

The RF Gain controls permit manual adjustment of the receiver RF and IF stages gain levels, to account for noise and/or signal strength conditions.

### VFO-A Receiver RF GAIN Adjustment

The **(VFO-A)[RF GAIN]** knob should, be rotated, initially, to the clockwise position. This is the point of maximum sensitivity, and counter-clockwise rotation will gradually reduce the receiver RF gain.

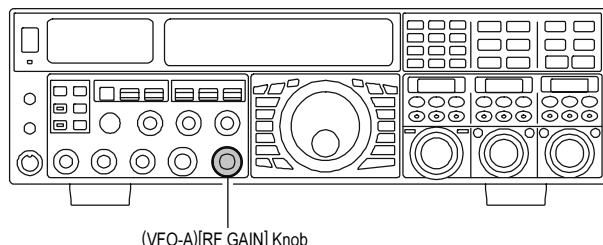

### VFO-B Receiver RF GAIN Adjustment

The VFO-B receiver RF Gain operates identically to the VFO-A receiver RF Gain.

- Press the **(VFO-B)[RX]** button to engage the Dual Receive operation. The **(VFO-B)[RX]** button will glow green.
- Always utilize the fully clockwise position of the **(VFO-B)[RF GAIN]** knob as the starting point for operation.

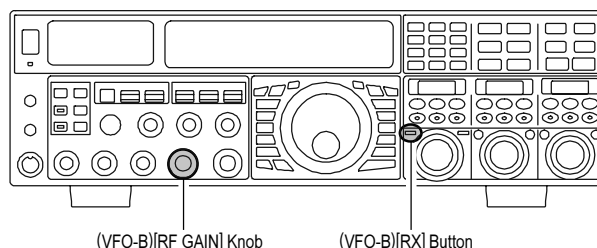

### ADVICE:

- As the **[RF GAIN]** knob is rotated counterclockwise to reduce the gain, the S-meter reading will rise. This indicates that the AGC voltage being applied to the receiver is increasing (which causes a *reduction* in receiver gain).
- Rotating the **[RF GAIN]** knob control to the fully counter-clockwise position will essentially disable the receiver, as the gain will be greatly reduced. In this case, as well, the S-meter will appear to be “pegged” against the right edge of the analog S-meter scale.
- The **(VFO-B)[RF GAIN]** knob operates identically to the **(VFO-A)[RF GAIN]** knob. The effects of counter-clockwise rotation of the VFO-B receiver RF Gain control may be observed visually on the VFO-B S-meter.

### QUICK POINT:

- Reception can often be optimized by rotating the **[RF GAIN]** knob slightly counter-clockwise, to the point where the S-meter stationary needles position is just about the same as the receiver noise level. This setting ensures incoming signals will be heard with minimal noise. The S/N (signal to noise) of the receiver will be improved, without so much gain reduction that weak signals cannot be heard.
- The RF GAIN control, along with the IPO and ATT (attenuator) features, all affect the system receiver gain in different ways. As a first step in dealing with high noise or a crowded, high-level signal environment, the IPO generally should be the first feature engaged, if the frequency is low enough to allow the preamplifier to be bypassed. Thereafter, the RF GAIN and ATT (attenuator) features may be employed to provide precise, delicate adjustment of the receiver, and fully optimize performance.

# ADVANCED INTERFERENCE-SUPPRESSION FEATURES: RF FRONT END

The **FTDX5000** includes an unmatched array of RF selectivity-enhancing features. Please study the following material carefully, to understand the many interference tools and techniques completely.

## USING THE VRF (VARIABLE RF FRONT-END FILTER)

The VRF system is a high-performance RF front-end preselector that has a high Q factor and low insertion loss. VRF provides outstanding rejection of out-of-band signals, it can also significantly improve receiver performance when located near other transmitters, such as a contest or DX-pedition station. The **FTDX5000** VRF system affects the 1.8 - 28 MHz amateur bands only.

### VFO-A VRF Setup

- Press the **(VFO-A)[VRF]** button. The button will glow red, and the “**VRF**” icon will appear at the FLT column of the Block Diagram Display. The VRF system will be engaged and centered on the currently operating amateur band. The **(VFO-A)[SELECT]** knob will now function as the VRF adjusting knob.

ANT	ATT	FLT	IPO	R.FLT	AGC
VFO 1	OFF	<b>VRF</b>	AMP1	300	AUTO
A 2	-6dB	H-T	AMP2	600	FAST
3	-12dB	THRU	IPO1	3k	MID
RX 4	-18dB		IPO2	6k	SLOW
				15k	

- You may rotate the **(VFO-A)[SELECT]** knob to change the VRF system tuning, relative to your operating frequency.

#### ADVICE:

- You may observe the relative skew of the VRF system in the **SUB DISPLAY-II** window.
- After moving the passband of the VRF system manually, you may re-center it on the current Amateur band by pressing the **(VFO-A)[RESET]** button.
- To switch VRF off, press the **(VFO-A)[VRF]** button until the “**VRF**” icon shows “**THRU**” in the FLT column of the Block Diagram Display; this confirms that the VRF circuit has been removed from the incoming received signal path.

### VFO-B VRF Setup

- Press the **(VFO-B)[RX]** button to engage Dual Receive operation. The button will glow green.
- Press the **(VFO-B)[VRF]** button. The **(VFO-B)[VRF]** button will glow red, and the “**VRF**” icon will appear at the FLT column of the Block Diagram Display. The VRF system will be engaged and centered on the current operating amateur band. The **(VFO-B)[SELECT]** knob will now function as the VRF adjusting knob.

S	1	3	5	7	9	20	40	60dB
VFO 1	OFF	<b>VRF</b>	AMP1	3k	AUTO			
B 2	-6dB	THRU	AMP2	6k	FAST			
3	-12dB		IPO1	15k	MID			
RX 4	-18dB		IPO2		SLOW			

- You may rotate the **(VFO-B)[SELECT]** knob to change the VRF system tuning, relative to your operating frequency.

#### ADVICE:

- You may observe the relative skew of the VRF system in the **SUB DISPLAY-III** window.
- After moving the passband of the VRF system manually, you may re-center it on the current Amateur band by pressing the **(VFO-B)[RESET]** button.
- To switch VRF off, press the **(VFO-B)[VRF]** button. The “**VRF**” icon shows “**THRU**” in the FLT column of the Block Diagram Display; this confirms that the VRF circuit has been removed from the incoming received signal path.

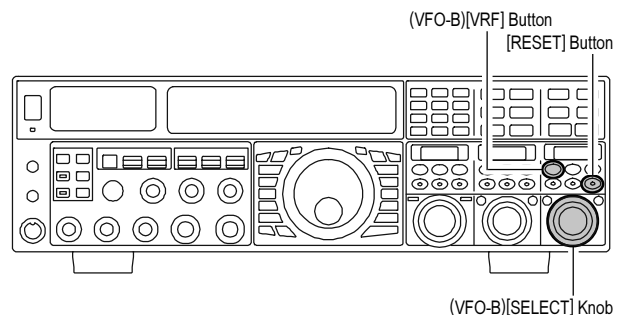
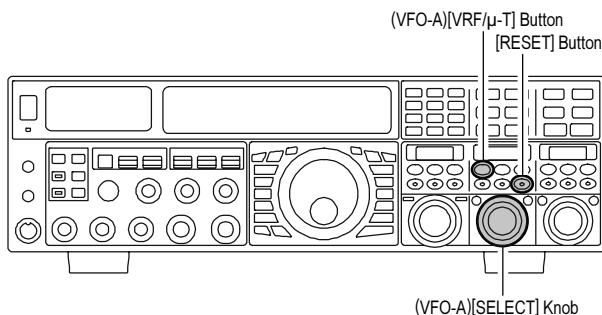

## USING THE VRF (VARIABLE RF FRONT-END FILTER)

### ADVICE:

- ❑ The VRF system tuning is relatively broad, although it is still much narrower than the fixed bandpass filter. You may not hear much difference in the background noise or signal quality when you make minor adjustments. However, if you have receiving problems associated with a very strong signal, rotation of the **[SELECT]** knob may help reduce the strength of the interfering station, allowing improved reception of the desired signal, if receiver overload was degrading reception.
- ❑ The VRF Filter operational status will be memorized independently on each VFO in the VFO stack.
- ❑ You may select the display pattern shown in the **SUB DISPLAY** window from three patterns via Menu item **"019 DISP SELECT"**. See page 122 for details.

### QUICK POINT:

The VRF filter utilizes high-quality coils and capacitors that provide high Q, and yield a passband that is approximately 20% to 30% the width of a traditional, fixed bandpass filter. As a result, significantly more "unwanted" signal rejection is provided. Within each amateur band, the following adjustment steps are provided, if you wish to skew the response in a particular direction to enhance interference rejection even more. The actual "sound" of the signal you are listening to will remain unchanged, however.

AMATEUR BAND	VRF ADJUSTMENT STEPS
1.8 MHz	62 steps
3.5 MHz	62 steps
5 MHz	62 steps
7 MHz	62 steps
10 MHz	30 steps
14 MHz	30 steps
18 MHz	20 steps
21 MHz	20 steps
24.5 MHz	20 steps
28 MHz	20 steps

# INTERFERENCE REJECTION (SIGNALS OFF FREQUENCY BY JUST A FEW KHZ)

## R.FLT (ROOFING FILTERS)

Narrow-band Roofing Filters of 15 kHz, 6 kHz, 3 kHz, 600 Hz\*, and 300 Hz\* bandwidths are provided in the first IF, right after the first mixer. These filters provide protection for the 2nd mixer, DSP, and other circuitry that follow. The roofing filter can dramatically improve reception on a very crowded band (during a contest, etc.). Typically, the AUTO selection mode is satisfactory for most operating situations, but in an extremely crowded phone or CW band you may wish to select a narrower filter. For example, the 3 kHz roofing filter for SSB operation, or the 600 Hz filter for CW.

※: The 600 Hz roofing filter is only available on VFO-A. The 300Hz filter for VFO-A on the **FTdx5000**, is optional on other versions.

### VFO-A Roofing Filter Setup

- Press the **[A]** button (the button will glow red), to activate the VFO-A receiver.
- Move the **[R.FLT]** knob up and down to set the desired bandwidth of the VFO-A Roofing Filter. The selected bandwidth of the Roofing Filter will be indicated in the R.FLT column of the Block Diagram Display.



- Press the **[R.FLT]** knob in briefly, to quickly set the Roofing Filter to the “AUTO” selection. The “AUTO” mode selects the optimum Roofing Filter, determined by a combination of the operating mode and the IF bandwidth. The indicated bandwidth will blink for three seconds in the Roofing Filter Display, and thereafter will appear continuously. Typically, the filter will be set to “AUTO”, but may be easily changed when needed.

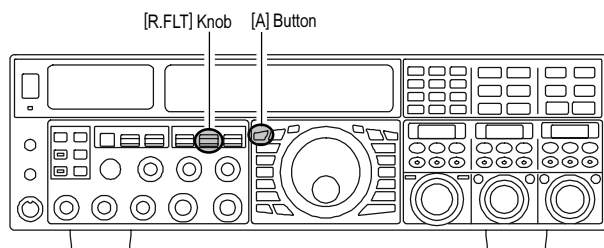

### VFO-B Roofing Filter Setup

- Press the **[B]** button (the button will glow orange), to activate the VFO-B receiver.
- Move the **[R.FLT]** knob up and down to set the desired bandwidth of the VFO-B Roofing Filter. The selected bandwidth of the Roofing Filter will be indicated in the R.FLT column of the Block Diagram Display.

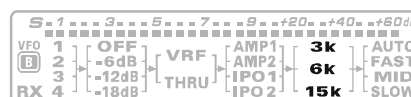

- Press the **[R.FLT]** knob in briefly, to quickly set the Roofing Filter to the “AUTO” selection. The “AUTO” mode selects the optimum Roofing Filter, determined by a combination of the operating mode and the IF bandwidth. The indicated bandwidth will blink for three seconds in the Roofing Filter Display, and thereafter will appear continuously. Typically, the filter will be set to “AUTO”, but may be easily changed when needed.

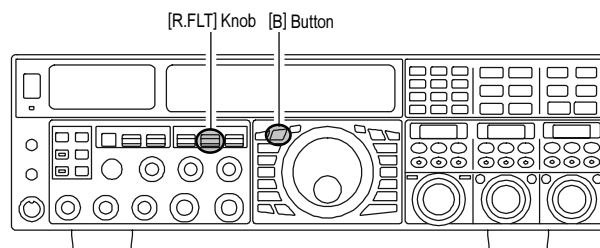

### ADVICE:

- The Roofing Filter selection will be memorized independently on each VFO memory in the VFO stack.

### TERMINOLOGY:

A “Roofing Filter,” as its name implies, places a “Roof” over the receiver’s IF system bandwidth. This “Roof” protects the circuitry downstream from strong signal overload interference, just as a roof on a house protects the contents from rain and snow.

# *INTERFERENCE REJECTION (SIGNALS OFF FREQUENCY BY JUST A FEW KHZ)*

---

## **NOTE**

---

---

## CONTOUR CONTROL OPERATION

The Contour Filter system produces a gentle perturbation of the IF filter passband. The different frequency components of the signal can be suppressed or enhanced, thus improving the sound and/or readability of the received signal.

### VFO-A Contour Operation

- Press the **(VFO-A)[CONT/APF]** button. The button will glow red and the position of the “null” (or “Peak”) of the contour filter will be indicated in the **SUB DISPLAY-II** window. The **(VFO-A)[SELECT]** knob will now function as the contour knob.
- Rotate the **(VFO-A)[SELECT]** knob to achieve the most pleasing audio reproduction of the incoming signal.
- Press the **(VFO-A)[RESET]** button in briefly, to quickly move the “null” (or “Peak”) position to center.
- To cancel Contour tuning, press the **(VFO-A)[CONT/APF]** button once more.

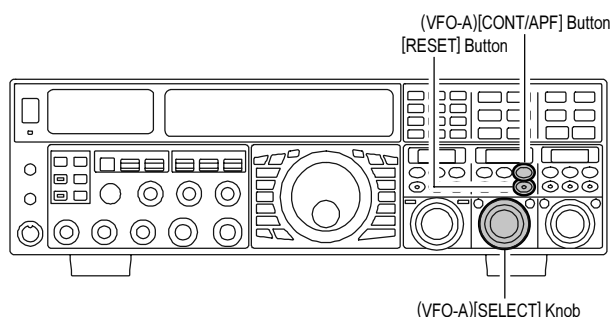

### VFO-B Contour Operation

- Press the **(VFO-B)[CONT/APF]** button. The button will glow red and the current “null” (or “Peak”) position of the contour filter will be indicated in the **SUB DISPLAY-III** window. The **(VFO-B)[SELECT]** knob will now function as the contour knob.
- Rotate the **(VFO-B)[SELECT]** knob to achieve the most natural-sounding audio reproduction of the incoming signal.
- Press the **(VFO-B)[RESET]** button in briefly, to quickly move the “null” (or “Peak”) position to center.
- To cancel Contour tuning, press the **(VFO-B)[CONT/APF]** button once more.

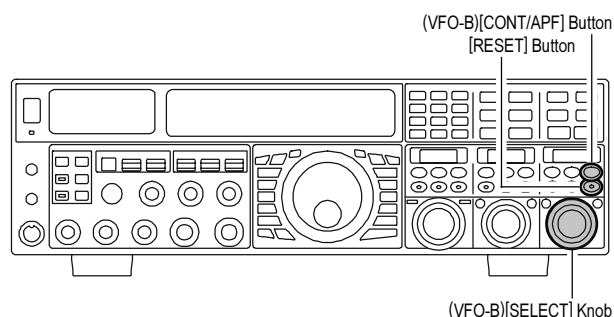

### ADVICE:

- The contour filter null or peaking level may be adjusted using Menu item “**112 RDSP CNTR LV**”. The factory default null setting is “-15” (dB).
- The bandwidth over which the contour null or peaking affect is applied may be adjusted using Menu item “**113 RDSP CNTR WI**”. The factory default setting is “10”.
- You may select the display pattern shown in the **SUB DISPLAY** window from three patterns via Menu item “**019 DISP SELECT**”. See page 122 for details.
- When the optional **DMU-2000** Data Management Unit is connected, the Audio Scope (on the **DMU-2000** “Oscilloscope” page) is particularly useful when adjusting the Contour controls. You can see the affect of the Contour system on the signal levels, and the position of the null/peak with respect to frequency components of interest. On the Audio Scope, you may visually observe the affect of the Contour Controls while listening to the signal, this will help build your intuition on how best to use Contour tuning in the future.

### NOTE:

When receiving a single tone signal, such as CW, with the Contour gain set to a high level (adjusted by Menu item “**112 RDSP CNTR LV**”), the receive signal may occasionally be heard at a low volume, even if the **AF GAIN** knob is set to minimum.

### QUICK POINT:

When adjusted aggressively, the steep slopes of the DSP filtering can impart an unnatural sound to an incoming signal. Often, a narrow bandwidth is not the key to improved copy. The incoming signal itself may have undesirable or excessive frequency components, especially in the low frequency range around 100-400 Hz. By judicious use of the Contour filter, the “shoulder” of the passband response may be altered, or components removed from within the passband, allowing the desired signal to rise above the background noise and interference in a manner not obtainable with other filtering systems.



## CONTOUR CONTROL OPERATION

Refer to Figure “B”, and notice the initial position of the contour when the [CONT] button is pushed. Observe the “indentation” in the receiver passband where the contour filter is placing a low-Q “notch” (according to the setting of Menu item “112 RDSP CNTR LV”, as described on the previous page). Counterclockwise rotation of the [SELECT](contour) knob causes the indentation to move toward a lower frequency (to the left) within the passband, while clockwise rotation causes the indentation to move toward a higher frequency (to the right) within the passband. By removing the interference or unwanted frequency components on the incoming signal, it is possible to make the desired signal rise out of the background noise/interference, and significantly enhance intelligibility.

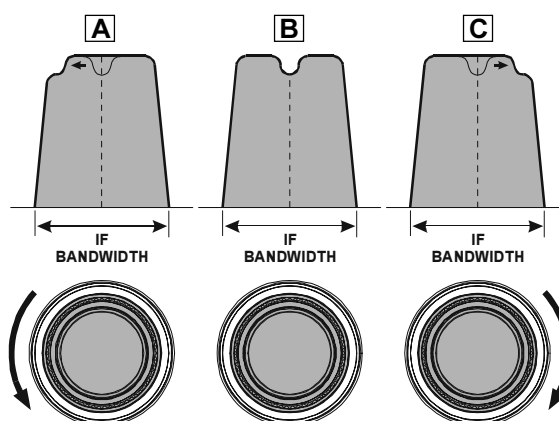

# INTERFERENCE REJECTION (SIGNALS WITHIN 3 KHZ)

## IF SHIFT OPERATION (SSB/CW/RTTY/PKT MODES)

The IF Shift allows you to vary the DSP filter passband higher or lower, (without changing the pitch of the incoming signal) to reduce or eliminate interference. Because the carrier tuning frequency is not varied, there is no need to re-tune the operating frequency when using the IF Shift to eliminating the interference. The total passband tuning range for the IF Shift system is  $\pm 1$  kHz.

### VFO-A IF SHIFT Operation

- Press the **(VFO-A)[SHIFT]** button. The **(VFO-A)[SHIFT]** button glows red, and the center position of the IF passband will be indicated in the **SUB DISPLAY-II** window. The **(VFO-A)[SELECT]** knob will now function as the IF SHIFT knob.
- Rotate the **(VFO-A)[SELECT]** knob to the left or right to reduce the interference.
- Press the **(VFO-A)[RESET]** button briefly to quickly move the filter passband to center.
- To turn the IF SHIFT operation “off”, press the **(VFO-A)[SHIFT]** button again. The red LED of the **(VFO-A)[SHIFT]** button turns off, and the filter passband will move to the center. However, the last setting of the IF SHIFT control will be retained until you change it again.

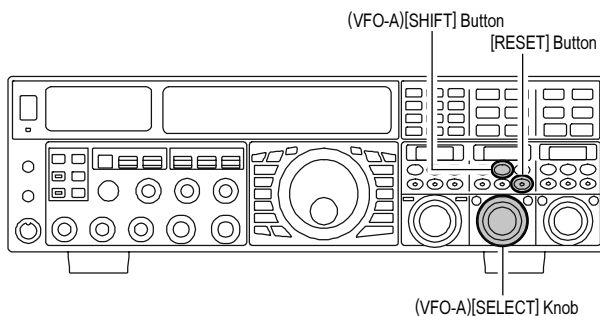

### VFO-B IF SHIFT Operation

- Press the **(VFO-B)[SHIFT]** button. The **(VFO-B)[SHIFT]** button glows red, and the center position of the IF passband will be indicated in the **SUB DISPLAY-III** window. The **(VFO-B)[SELECT]** knob will now function as the IF SHIFT knob.
- Rotate the **(VFO-B)[SELECT]** knob to the left or right to reduce the interference.
- Press the **(VFO-B)[RESET]** button briefly to quickly move the filter passband to center.
- To turn the IF SHIFT operation “off”, press the **(VFO-B)[SHIFT]** button again. The red LED of the **(VFO-B)[SHIFT]** button turns off, and the filter passband will move to the center. However, the last setting of the IF SHIFT control will be retained until you change it again.

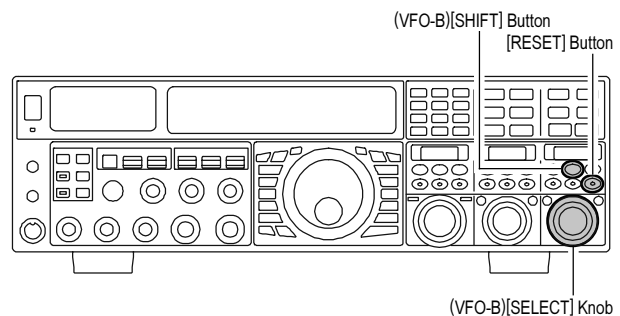

Refer to Figure “A” and notice the depiction of the IF DSP filter as a thick line in the center of the passband, no shift (the [SHIFT] button glows red). In Figure “B”, an interfering signal has appeared inside the original passband. In Figure “C”, you can see the effect of rotating the [SELECT](shift) knob and moving the filter so that the interference is outside of the passband.

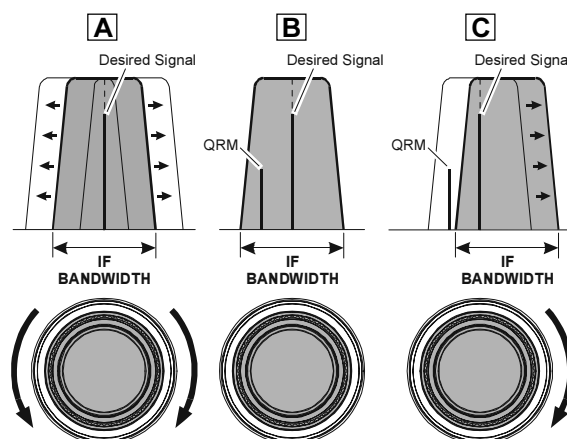

### ADVICE:

You may select the display pattern shown in the **SUB DISPLAY** window from three patterns via Menu item “019 **DISP SELECT**”. See page 122 for details.

## WIDTH (IF DSP BANDWIDTH) TUNING (SSB/CW/RTTY/PKT MODES)

The IF Width tuning system allows you to vary the width of the DSP IF filter passband, to eliminate interference. Moreover, the bandwidth may actually be *expanded* from its default setting, should you wish to enhance incoming signal fidelity when interference on the band is low.

### VFO-A WIDTH Operation

- ❑ Press the (VFO-A)[WIDTH] button. The (VFO-A)[WIDTH] button glows red, and the center position of the IF passband will be indicated in the SUB DISPLAY-II window. The (VFO-A)[SELECT] knob will now function as the IF WIDTH knob.
- ❑ Rotate the (VFO-A)[SELECT] knob to the left or right to reduce the interference.
- ❑ Press the (VFO-A)[RESET] button briefly to set the bandwidth to default.
- ❑ To turn the IF WIDTH operation “off”, press the (VFO-A)[WIDTH] button again. The red LED of the (VFO-A)[WIDTH] button turns off, and the bandwidth will be set to default. However, the last setting of the IF WIDTH control will be retained until you change it again.

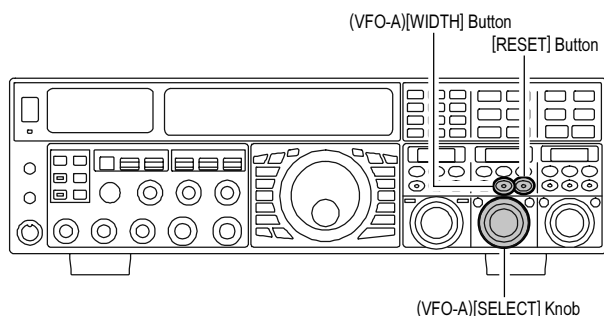

### VFO-B WIDTH Operation

- ❑ Press the (VFO-B)[WIDTH] button. The (VFO-B)[WIDTH] button glows red, and the center position of the IF passband will be indicated in the SUB DISPLAY-III window. The (VFO-B)[SELECT] knob will now function as the IF WIDTH knob.
- ❑ Rotate the (VFO-B)[SELECT] knob to the left or right to reduce the interference.
- ❑ Press the (VFO-B)[RESET] button briefly to set the bandwidth to default.
- ❑ To turn the IF WIDTH operation “off”, press the (VFO-B)[WIDTH] button again. The red LED of the (VFO-B)[WIDTH] button turns off, and the bandwidth will be set to default. However, the last setting of the IF WIDTH control will be retained until you change it again.

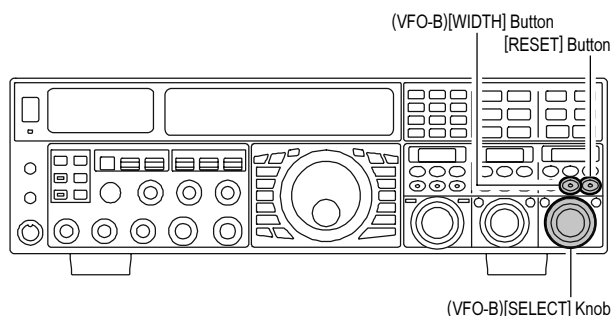

Referring to Figure “B”, you can see the default bandwidth (the [WIDTH] button glows red).

By rotating the [SELECT](width) knob to the left, the bandwidth will narrow (see Figure “A”). Rotation of the [SELECT](width) knob to the right, as depicted in Figure “C,” will widen the bandwidth.

The default bandwidth, and total bandwidth adjustment range, will vary according to the operating mode and the [NAR] button setting:

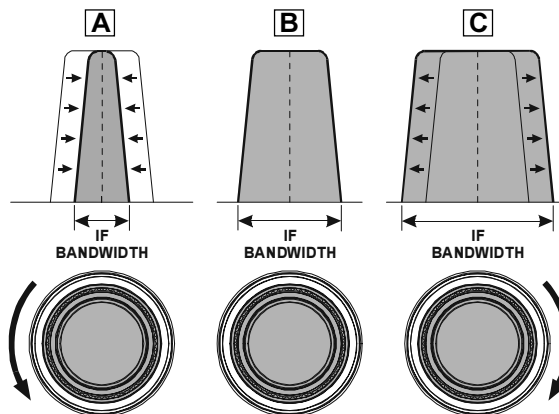

MODE	NAR SWITCH	
	OFF	ON
LSB/USB	1.8 kHz - 4.0 kHz / 16 steps (2.4 kHz <sup>*</sup> )	200 Hz - 1.8 kHz / 9 steps (1.8 kHz <sup>*</sup> )
CW	500 Hz - 2.4 kHz / 7 steps (2.4 kHz <sup>*</sup> )	50 Hz - 500 Hz / 10 steps (500 Hz <sup>*</sup> )
RTTY(LSB) / PKT(LSB/USB)	500 Hz - 2.4 kHz / 7 steps (500 Hz <sup>*</sup> )	50 Hz - 500 Hz / 10 steps (300 Hz <sup>*</sup> )

<sup>\*</sup>: Default (the [WIDTH] button glows red)

#### ADVICE:

You may select the display pattern shown in the SUB DISPLAY window from three patterns via Menu item “019 DISP SELECT”. See page 122 for details.

#### NOTE:

When rotating the [SELECT](WIDTH) knob counter-clockwise, the transition between 50 Hz and 25 Hz bandwidth may be accompanied by a “ping” sound, depending on the amount of noise present. This is a normal condition, and you should turn down the volume, when wearing headphones, to minimize the amplitude of this momentary sound.

# INTERFERENCE REJECTION (SIGNALS WITHIN 3 KHZ)

## USING IF SHIFT AND WIDTH TOGETHER (SSB/CW/RTTY/PKT/AM MODES)

The IF Shift and Variable IF Width features, together, form a very effective interference-fighting filter system.

For example, in Figure “A” you can see how interference has appeared both on the high and low sides of the desired signal. By pressing the [WIDTH] button (the button will glow red) and then rotating the [SELECT](width) knob, as shown in Figure “B”, the interference from one side can be eliminated, then press the [SHIFT] button to change the function of the [SELECT] knob to the SHIFT knob (the [SHIFT] button glows red. However, the IF Width adjustment is not changed). Now, by re-positioning the [SELECT](shift) knob (Figure “C”), the interference on the opposite side can be removed, without re-introducing the interference previously eliminated in Figure “B”.

### ADVICE:

The Width and Shift features are the primary tools you should use for best interference reduction. After narrowing the bandwidth (width) and/or adjusting the center of the passband (shift), the Contour control may also yield further signal-enhancement benefits on the net residual bandwidth. Additionally, the IF Notch Filter (see the next section) may be utilized, in conjunction with the three other filter systems, to significant advantage.

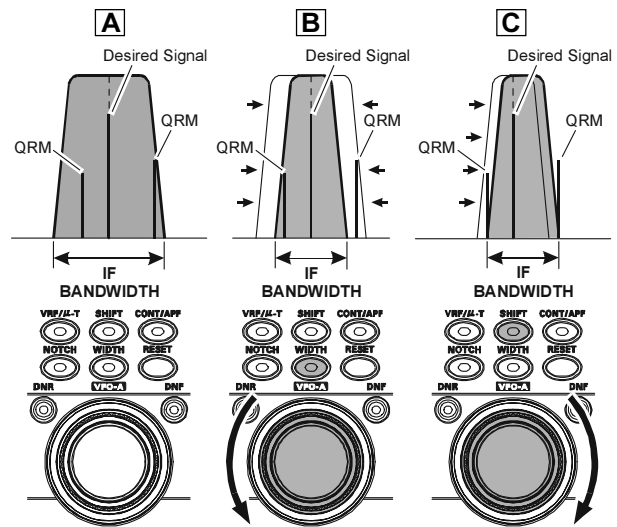

## IF NOTCH FILTER OPERATION (SSB/CW/RTTY/PKT/AM MODES)

The IF Notch filter is a highly effective system that allows you to slice out an interfering beat note or other carrier signal from inside the receiver passband.

### VFO-A IF Notch Operation

- Press the **(VFO-A)[NOTCH]** button. The **(VFO-A)[NOTCH]** button glows red, and the current “null” (or “Peak”) position of the IF notch filter will appear in the **SUB DISPLAY-II** window. The **(VFO-A)[SELECT]** knob will now function as the notch adjustment knob.
- Rotate the **(VFO-A)[SELECT]** knob to adjust the center frequency of the IF notch filter.
- Press the **(VFO-A)[RESET]** button to move the “null” position to center.
- To switch the IF notch filter off, press the **(VFO-A)[NOTCH]** button once more.

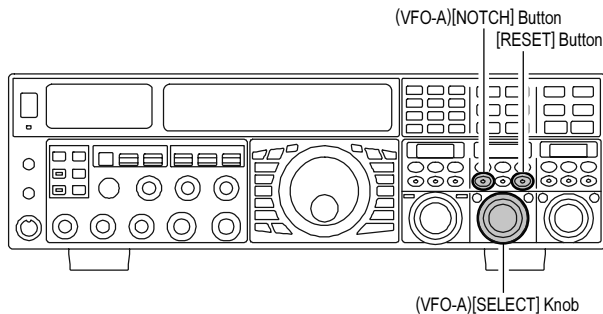

### VFO-B IF Notch Operation

- Press the **(VFO-B)[NOTCH]** button. The **(VFO-B)[NOTCH]** button glows red, and current “null” (or “Peak”) position of the IF notch filter will be indicated in the **SUB DISPLAY-III** window. The **(VFO-B)[SELECT]** knob will now function as the notch adjustment knob.
- Rotate the **(VFO-B)[SELECT]** knob to adjust the center frequency of the IF notch filter.
- Press the **(VFO-B)[RESET]** button to move the “null” position to center.
- To switch the IF notch filter off, press the **(VFO-B)[NOTCH]** button once more.

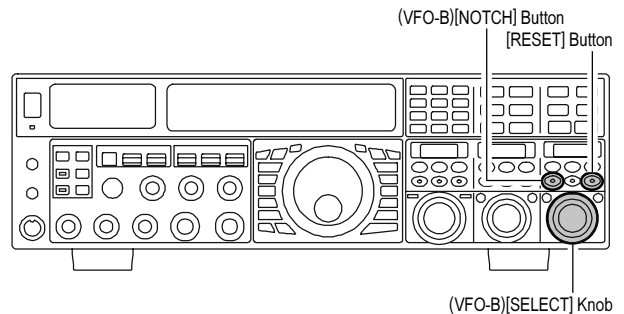

### ADVICE:

- The width of the IF notch null may be adjusted using Menu item “**110 RDSP NOTCH WI**”. Both “Wide” and “Narrow” selections are available, with “Narrow” providing the least disruption of the “desired” signal.
- You may select the display pattern shown in the **SUB DISPLAY** window from three patterns via Menu item “**019 DISP SELECT**”. See page 122 for details.
- When the optional **DMU-2000** Data Management Unit is connected, the effect of the IF notch filter may be observed using the Audio Scope (on the “Oscilloscope” page). The notch will be seen as a “dip” in the noise platform observed. What’s more, the “Waterfall” display may be used to observe the effect of the IF notch filter, which will appear as a white area in the colored background. The tuning rate for the IF notch is somewhat slow while you adjust the **[SELECT]**(notch) knob, so the use of the Waterfall display to confirm proper adjustment is highly recommended.

The affect of rotation of the **[SELECT]**(notch) knob on the performance of the IF notch filter is depicted in Figure “**A**”. In Figure “**B**”, you can see the notching effect of the IF notch filter as you rotate the **[SELECT]**(notch) knob to eliminate the incoming interference.

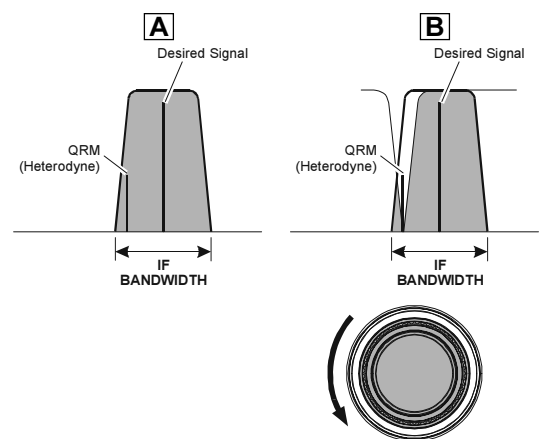

# INTERFERENCE REJECTION (SIGNALS WITHIN 3 KHZ)

## DIGITAL NOISE REDUCTION (DNR) OPERATION

The Digital Noise Reduction (DNR) system is designed to reduce the level of random noise found on the HF and 50 MHz bands. It is especially effective during SSB operation. By rotating the [DNR] knob, any of 15 different noise-reduction algorithms can be selected; each of these algorithms was created for dealing with a different noise profile, and you will want to experiment with the DNR system to find the best setting according to the noise currently being experienced.

### VFO-A DNR Operation

- Press the (VFO-A)[DNR] button. The button will glow red, and the current noise-reduction algorithm will appear in the **SUB DISPLAY-II** window. The (VFO-A)[SELECT] knob will now function as the notch adjustment knob.
- Rotate the (VFO-A)[SELECT] knob to select the setting that most effectively reduces the noise level.
- Press the (VFO-A)[RESET] button to set the noise-reduction algorithm to default.
- To switch the DNR system off, press the (VFO-A)[NOTCH] button once more.

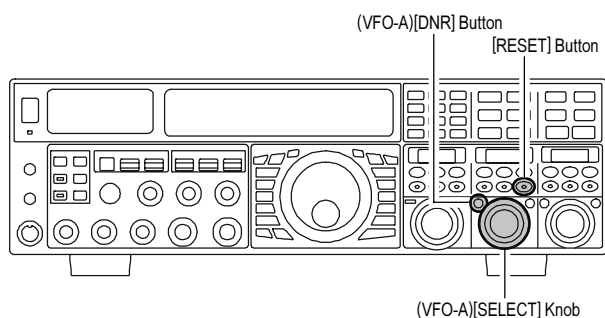

### VFO-B DNR Operation

- Press the (VFO-B)[DNR] button. The (VFO-B)[DNR] button glows red, and the current noise-reduction algorithm will appear in the **SUB DISPLAY-II** window. The (VFO-B)[SELECT] knob will now function as the notch adjustment knob.
- Rotate the (VFO-B)[SELECT] knob to select the setting that most effectively reduces the noise level.
- Press the (VFO-B)[RESET] button to set the noise-reduction algorithm to default.
- To switch the DNR system off, press the (VFO-B)[NOTCH] button once more.

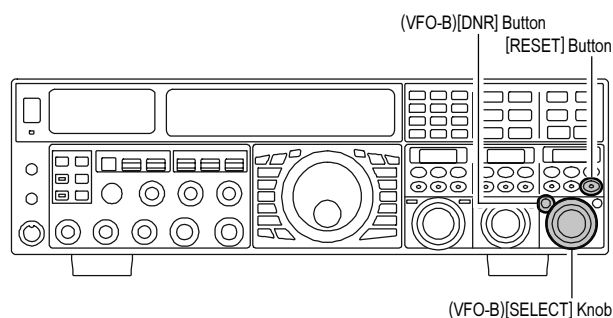

#### ADVICE:

You may select the display pattern shown in the **SUB DISPLAY** window from three patterns via Menu item "019 DISP SELECT". See page 122 for details.

## DIGITAL NOTCH FILTER (DNF) OPERATION

The Digital Notch Filter (DNF) is an effective beat-canceling filter that can null out a number of interfering beat notes inside the receiver passband. Because this is an Auto-Notch feature, there is no adjustment knob associated with this filter.

#### ADVICE:

If a very strong interfering carrier is encountered, we recommend you first use the IF notch filter, as it is the most effective notching tool in the receiver section.

### VFO-A DNF Operation

- Press the (VFO-A)[DNF] button. The button glows red, confirming that the DNF system is engaged.
- To switch the DNF system off, press the (VFO-A)[DNF] button once more.

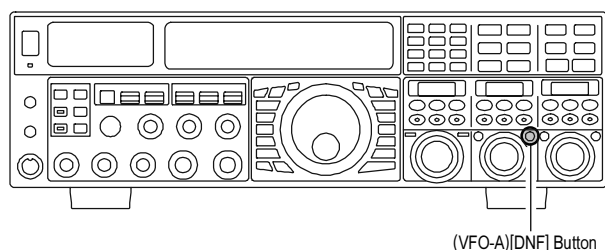

### VFO-B DNF Operation

- Press the (VFO-B)[DNF] button. The button glows red, confirming that the DNF system is engaged.
- To switch the DNF system off, press the (VFO-B)[DNF] button once more.

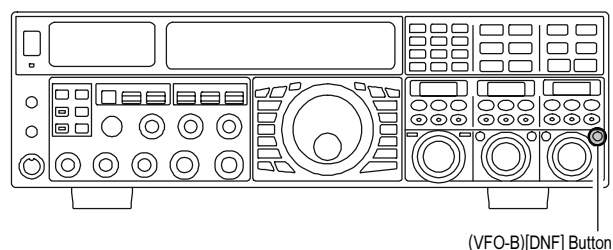

## NARROW (NAR) ONE-TOUCH IF FILTER SELECTION

### VFO-A “One-Touch Narrow” Operation

- Press the [A] button to activate VFO-A (the button will glow red).
- Pressing the [NAR] button engages a narrow IF DSP filter.
- Pressing the [NAR] button once more returns the bandwidth control to the Width/Shift system. The factory default of the bandwidth is as shown below.

**ADVICE:**

When the narrow bandwidth is selected, the “**NAR**” icon will appear in the display, and the bandwidth depiction in the **SUB DISPLAY-II** window will be narrowed (if **SUB DISPLAY-II** window is showing the bandwidth).

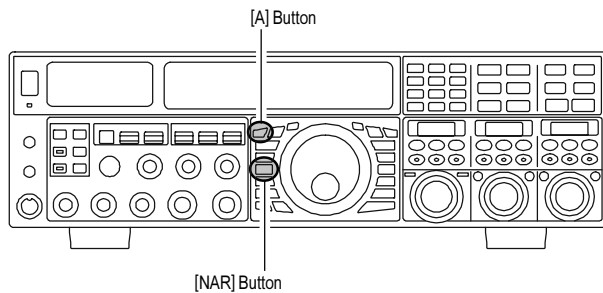

### VFO-B “One-Touch Narrow” Operation

- Press the [B] button (the button glows orange).
- Pressing the [NAR] button engages a narrow IF DSP filter.
- Pressing the [NAR] button once more returns bandwidth control to the Width/Shift system. The factory default settings of the bandwidth are as shown in the table below.

**ADVICE:**

When the narrow bandwidth is selected, the “**NAR**” icon will appear in the display, and the bandwidth on the **SUB DISPLAY-III** will be reduced, (if the **SUB DISPLAY-III** window indicates the bandwidth).

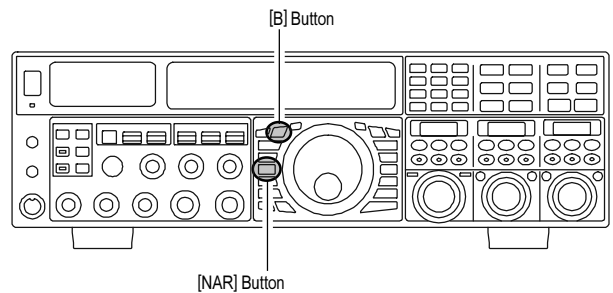

MODE	NAR BUTTON	
	OFF	ON
LSB/USB	2.4 kHz (1.5 kHz - 4.0 kHz / 17 steps*)	1.5 kHz (200 Hz - 1.5 kHz / 8 steps*)
CW	2.4 kHz (500 Hz - 2.4 kHz / 7 steps*)	500 Hz (50 Hz - 500 Hz / 10 steps*)
RTTY(LSB)	500 Hz (500 Hz - 2.4 kHz / 7 steps*)	300 Hz (50 Hz - 500 Hz / 10 steps*)
PKT(LSB/USB)	500 Hz (500 Hz - 2.4 kHz / 7 steps*)	300 Hz (50 Hz - 500 Hz / 10 steps*)
PKT(FM)	25 kHz (±5.0 kHz Deviation)	12.5 kHz (±2.5 kHz Deviation)
AM	9 kHz	6 kHz
FM	25 kHz (±5.0 kHz Deviation)	12.5 kHz (±2.5 kHz Deviation)

**ADVICE:**

You may select the display pattern shown in the **SUB DISPLAY** window from three patterns via Menu item “**019 DISP SELECT**”. See page 122 for details.

## IF NOISE BLANKER (NB) OPERATION

The **FTdx5000** includes an effective IF Noise Blanker, which can significantly reduce pulse noise like that caused by automotive ignition systems.

### VFO-A NB Operation

- Press the **[A]** button (the button glows red), if needed to enable VFO-A.
- Press the **[NB]** button briefly to reduce *short duration pulse noise* such as from switching transients, automobile ignitions and power lines. The “**NB**” icon will appear in the display to confirm that the Narrow-NB is operating.
- Press the **[NB]** button again to reduce *longer-duration man-made pulse noise*. The “**NB W**” icon will blink for three seconds, and thereafter will appear continuously, to confirm that the Wide-NB is operating.
- Rotate the **(VFO-A)[NB]** knob to the point where the offending noise is best reduced or eliminated.
- To end Noise Blanker operation, press the **[NB]** button once more. The “**NB**” (or “**NB W**”) icon will turn off, confirming that the Noise Blanker is no longer in operation.

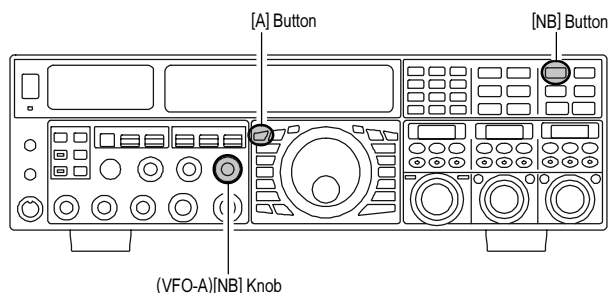

### VFO-B NB Operation

- Press the **[B]** button (the **[B]** button glows orange).
- Press the **[NB]** button briefly to reduce *short duration pulse noise* such as from switching transients, automobile ignitions and power lines. The “**NB**” icon will appear in the display to confirm that the Narrow-NB is operating.
- Press the **[NB]** button again to reduce *longer-duration man-made pulse noise*. The “**NB W**” icon will blink for three seconds, and thereafter will appear continuously, to confirm that the Wide-NB is operating.
- Rotate the **(VFO-B)[NB]** knob to the point where the offending noise is best reduced or eliminated.
- To end Noise Blanker operation, press the **[NB]** button once more. The “**NB**” (or “**NB W**”) icon will turn off, confirming that the Noise Blanker is no longer in operation.

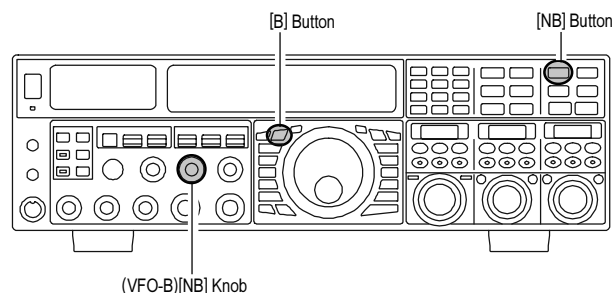



# TOOLS FOR COMFORTABLE AND EFFECTIVE RECEPTION

## AGC (AUTOMATIC GAIN CONTROL)

The AGC system is designed to help compensate for fading and other propagation effects, with characteristics that can be of particular value on each operating mode. The basic objective of AGC is to maintain a constant audio output level once a certain minimum threshold of signal strength is achieved.

### VFO-A AGC Selection

- Press the **[A]** button briefly to enable VFO-A (the LED in the **[A]** button will glow red).
- Move the **[AGC]** knob up or down to set the desired receiver recovery time constant of the VFO-A receiver. The selected recovery time will be indicated in the AGC column of the Block Diagram Display.
- Hold the **[AGC]** knob up or down for two seconds to disable the AGC (for testing or weak-signal reception).
- For most operations, we recommend using the “AUTO” mode by pressing the **[AGC]** knob in briefly, or moving the **[AGC]** knob to set the ATT display to the “AUTO” position.

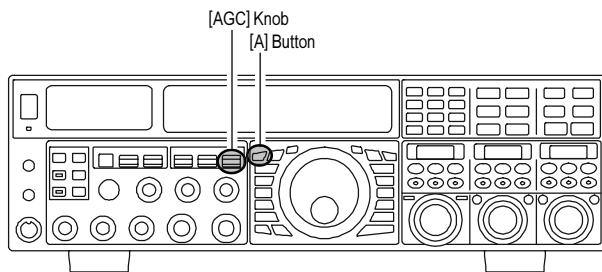

### VFO-B AGC Selection

- Press the **[B]** button (the **[B]** button glows orange).
- Move the **[AGC]** knob up and down to set the desired receiver recovery time constant of the VFO-B receiver. The selected recovery time will be indicated in the AGC column of the Block Diagram Display.
- Hold the **[AGC]** knob up or down for two seconds to disable the AGC (for testing or weak-signal reception).
- For most operations, we recommend using the “AUTO” mode by pressing the **[AGC]** knob in briefly, or moving the **[AGC]** knob to set the ATT display to the “AUTO” position.

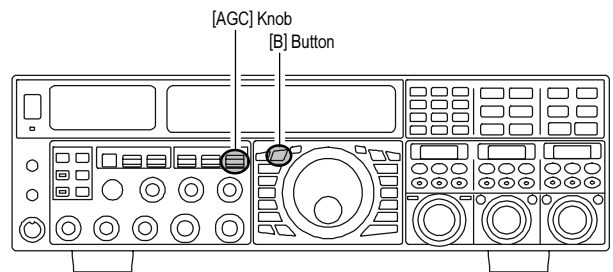

### NOTE:

- When the AGC receiver recovery time is set to “OFF”, the S-meter will no longer deflect. Additionally, you will likely encounter distortion on stronger signals, as the IF amplifiers and the following stages are probably being overloaded.
- Normally, the AGC “AUTO” selection is satisfactory for most situations, but in the event of operation on a crowded band where you wish to receive a weak signal, you may change the setting (to “FAST”, for example). The AGC “AUTO” mode selections are:

OPERATING MODE	AUTO AGC SELECTION
LSB	SLOW
USB	SLOW
CW	FAST
AM	FAST
FM	FAST
RTTY	SLOW
PKT (FM)	FAST
PKT (LSB)	SLOW

### ADVICE:

When a received signal becomes degraded due to pulse type noise, you may improve signal readability by setting Menu items “002 AGC FST HLD”, “004 AGC MID HLD”, and “006 AGC SLW HLD” to “0 msec”.

### QUICK POINT

Several aspects of AGC performance may be configured via the Menu. However, because AGC can have such a profound impact on overall receiver performance, we generally do not recommend any changes to the AGC Menu selections until you are thoroughly familiar with the performance of the FTDX5000.

### TERMINOLOGY:

Automatic Gain Control, or AGC, is a circuit that senses the incoming signal strength, and then limits the gains of the RF and IF stages, to maintain the output audio volume at a more-or-less constant level. AGC also protects the RF, IF, Audio, and DSP stages from overload, by limiting the signal strength applied to circuits, regardless of the input signal level.

## AGC (AUTOMATIC GAIN CONTROL)

### SLOPED AGC Operation

In traditional AGC systems, the audio output from the transceiver becomes essentially constant, once the threshold for AGC action is reached (usually several dozen dB above the no-signal noise floor). The **FTDX5000**, however, includes an innovative Sloped AGC system on the VFO-A receiver that allows the audio volume to rise and fall slightly according to signal strength. Although the rise/fall slope is not dramatic, it is sufficient to allow you to use your ear to discern and separate signals according to signal strength, not just audio frequency.

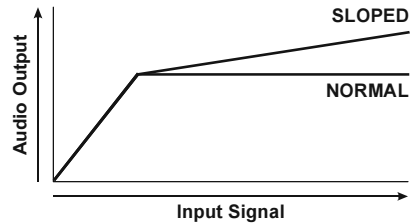

#### Using Sloped AGC

1. Press the **[MENU]** button briefly to enter the Menu mode.
2. Use the **(VFO-A)[SELECT]** knob to select Menu item “**107 ROUT AGC SLP**”.
3. Rotate the **(VFO-B)[SELECT]** knob to change the setting to “**SLOPE**”.
4. Press and hold in the **[MENU]** button for two seconds to save the new setting and exit to normal operation. You will now be using the Sloped AGC system.

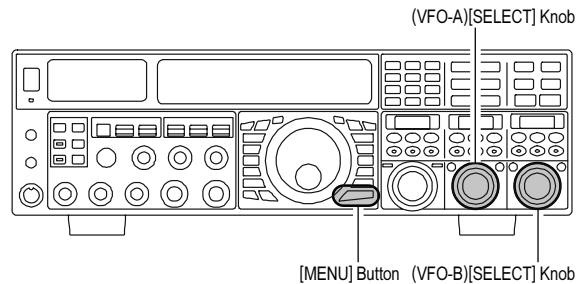

# TOOLS FOR COMFORTABLE AND EFFECTIVE RECEPTION

## MUTE FEATURE (VFO-A BAND)

There may be occasions during Dual Receive operation when you want to silence the VFO-A receiver temporarily, to concentrate on the signal being received on the VFO-B receiver. The Mute feature makes this simple to accomplish.

Press the **(VFO-A)[RX]** button briefly, located to the upper left of the Main Tuning Dial knob. The VFO-A receiver will be silenced, and the green LED in the **(VFO-A)[RX]** button will blink.

To restore reception on the VFO-A receiver, just press the blinking **(VFO-A)[RX]** button once more.

### ADVICE:

If you press the **[POWER]** switch briefly while the transceiver is turned on, the transceiver audio will be muted for three seconds.

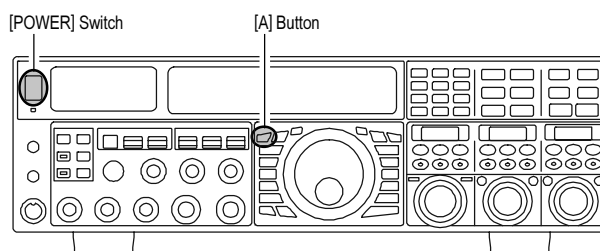

## ADJUSTABLE RECEIVER AUDIO FILTER

The **FTDX5000** includes an adjustable receiver audio filter, that provides precise, independent control of the low- and upper-ranges.

1. Press the **[MENU]** button briefly, to enter the Menu mode.
2. Rotate the **(VFO-A)[SELECT]** knob to find Menu items "047" through "050"; these parameters apply to the adjustment of the receiver audio filter in the AM mode, Menu items "053" through "056" apply to the adjustment of the RX audio filter in the CW mode, Menu items "075" through "078" apply to the adjustment of the RX audio filter in the FM mode, Menu items "089" through "092" apply to the adjustment of the RX audio filter in the RTTY mode, and Menu items "099" through "102" apply to the adjustment of the RX audio filter in the SSB mode.
3. Rotate the **(VFO-B)[SELECT]** knob to perform adjustments to a particular Menu item.

You may confirm the change of the sound quality from the speaker or headphones.

4. When you have completed all adjustments, press and hold in the **[MENU]** button for two seconds to save the new settings and exit to normal operation. If you only press the **[MENU]** button momentarily to exit, any changes you performed will not be stored.

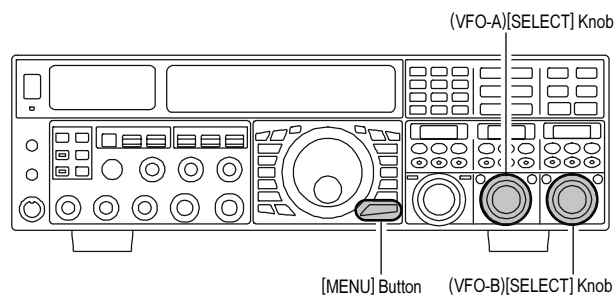

AM	047 A3E LCUT FRQ	OFF / 100 (Hz) ~ 1000 (Hz)
	048 A3E LCUT SLP	6dB/oct or 18dB/oct
	049 A3E HCUT FRQ	700 (Hz) ~ 4000 (Hz) / OFF
	050 A3E HCUT SLP	6dB/oct or 18dB/oct
CW	053 A1A LCUT FRQ	OFF / 100 (Hz) ~ 1000 (Hz)
	054 A1A LCUT SLP	6dB/oct or 18dB/oct
	055 A1A HCUT FRQ	700 (Hz) ~ 4000 (Hz) / OFF
	056 A1A HCUT SLP	6dB/oct or 18dB/oct
FM	075 F3E LCUT FRQ	OFF / 100 (Hz) ~ 1000 (Hz)
	076 F3E LCUT SLP	6dB/oct or 18dB/oct
	077 F3E HCUT FRQ	700 (Hz) ~ 4000 (Hz) / OFF
	078 F3E HCUT SLP	6dB/oct or 18dB/oct
RTTY	089 RTTY LCUT FRQ	OFF / 100 (Hz) ~ 1000 (Hz)
	090 RTTY LCUT SLP	6dB/oct or 18dB/oct
	091 RTTY HCUT FRQ	700 (Hz) ~ 4000 (Hz) / OFF
	092 RTTY HCUT SLP	6dB/oct or 18dB/oct
SSB	099 A3J LCUT FRQ	OFF / 100 (Hz) ~ 1000 (Hz)
	100 A3J LCUT SLP	6dB/oct or 18dB/oct
	101 A3J HCUT FRQ	700 (Hz) ~ 4000 (Hz) / OFF
	102 A3J HCUT SLP	6dB/oct or 18dB/oct

# SSB/AM MODE TRANSMISSION

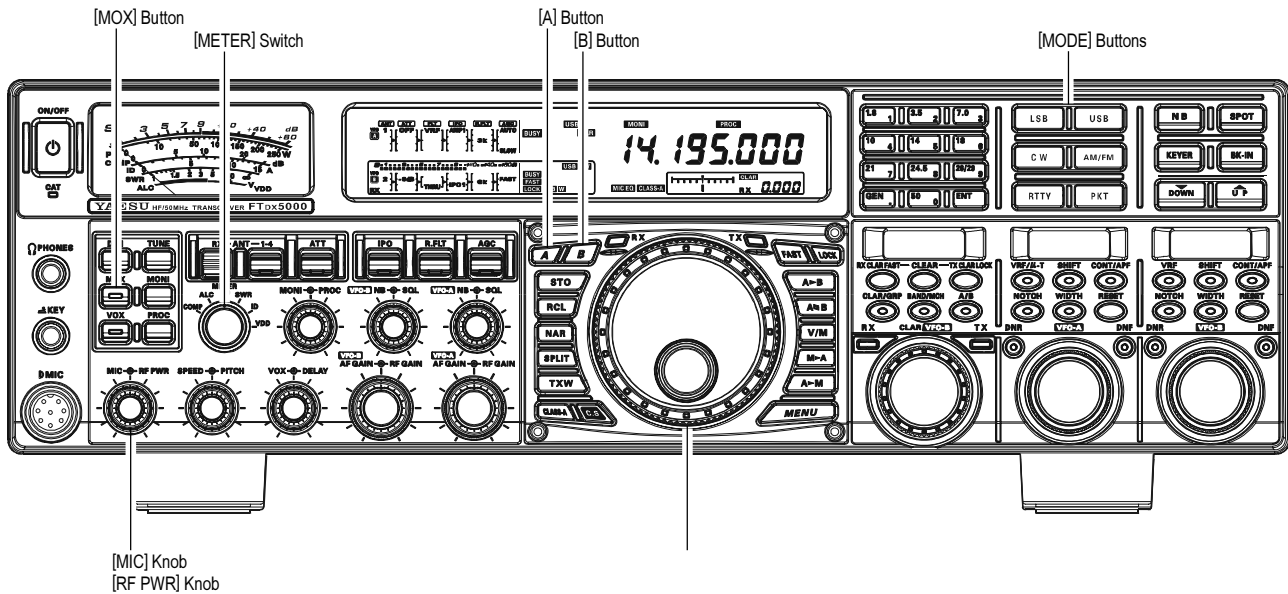

1. The operating mode is selected using the **[MODE]** buttons. The VFO (A or B) to which the selection is applied is selected by the **[A]** or **[B]** button located to the upper left of the Main Tuning Dial knob. Usually, the **[A]** button glows red, signifying that VFO-A is being adjusted. Similarly, pressing the **[B]** button will cause the **[B]** button to glow orange, signifying VFO-B adjustment. Press the **[A]** or **[B]** button to select the desired VFO. Then press the **[LSB]** or **[USB]** button briefly to select one of the SSB modes. For AM operation, press the **[AM/FM]** button repeatedly until the “**AM**” icon appears in the display.

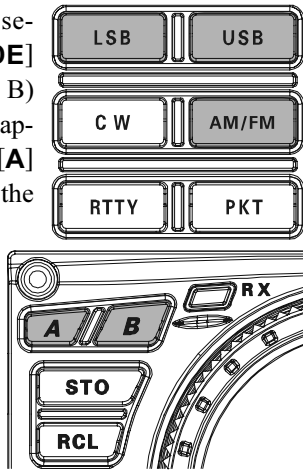

### QUICK POINT:

By convention, LSB is used in the 7 MHz and lower Amateur bands for SSB communication, and USB is used on the 14 MHz and higher bands (the 10 MHz band is used for CW and data modes only).

2. Rotate the Main Tuning Dial knob to adjust the operating frequency. Alternatively, you may use the **[UP]/[DWN]** scanning buttons on the **MH-31B8** Hand Microphone to sweep up or down the current band.
3. Press the microphone's **PTT** (Push To Talk) switch to begin transmission; speak into the microphone in a normal voice level.

### ADVICE:

- The “**TX**” indicator will light up in the frequency display area, confirming that transmission is in progress.
- When transmitting in the AM mode, rotate the **[RF PWR]** knob to set a maximum (carrier) power output of 50 Watts.

4. In the SSB mode, adjust the microphone amplifier gain to match the microphone and your voice level. set the **[METER]** switch to the “**ALC**” position and close the **PTT** switch. Speak into the microphone in a normal voice level, and adjust the **[MIC]** (gain) knob so that the ALC voltage stays within the blue ALC zone of the meter (up to 2/3 of full scale deflection) on voice peaks.

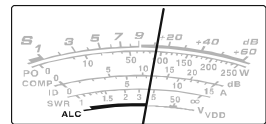
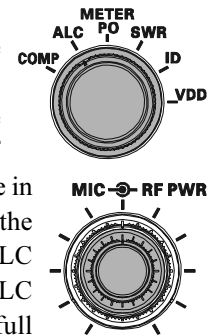

### ADVICE:

- The microphone gain of the AM mode has been programmed at the factory to a level that should be satisfactory for most situations. However, using Menu item “**051 A3E MIC GAIN**”, you may set a different fixed value, or choose the “**MCVR**” option, which then lets you use the front panel **[MIC]** knob to set the microphone gain in the AM mode. In this case, the **[MIC]** knob should not be advanced to the point where the ALC meter deflects. In many cases, the same setting used on SSB will be satisfactory.
  - The relative Microphone Gain level will show for 3 seconds in the lower right corner of the Main Display whenever the inner **[MIC]** knob is turned. Alternately, the 3-second display feature may be changed to show in the **SUB DISPLAY-III** window via Menu item “**018 DISP INDI**”. Additionally, you may disable the 3-second display feature via Menu item “**017 DISP LVL IND**” See page 122 for details.
5. Release the **PTT** switch at the end of your transmission. The transceiver will return to the receive mode.

# SSB/AM MODE TRANSMISSION

## ADVICE:

- ❑ ALC meter deflection may be caused by excessive drive power, and also by reflected power detected in the antenna system. If the impedance presented to the transceiver is other than 50 Ohms, the ALC meter action observed may not be related to the proper setting of the **[MIC]** (gain) knob. Therefore, we recommend that you make **[MIC]** gain adjustments into a dummy load or an antenna system presenting an impedance very close to 50 Ohms.

- ❑ Rotate the **[RF PWR]** knob to set the desired power output. Clockwise rotation of the **[RF PWR]** knob will increase the power. The adjustment range is between 10 Watts and 200 Watts, and you should always use the minimum power necessary for maintaining reliable communications.

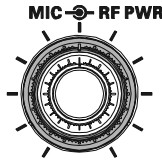

The RF Power Output will show for 3 seconds in the lower right corner of the Main Display whenever the outer **[RF PWR]** knob is turned.

Alternately, the 3-second display feature may be changed to show in the **SUB DISPLAY-III** window via Menu item "**018 DISP INDI**". Additionally, you may disable the 3-second display feature via Menu item "**017 DISP LVL IND**". See page 122 for details.

- ❑ The analog PO meter indicates the average power output level. SSB transmit average talk power is normally 10% to 50% of the peak power output. Voice characteristics, microphone qualities, parametric equalizer and compression settings affect actual talk power output.
- ❑ When performing transmitter tests for setup of the **[MIC]** or **[RF PWR]** knobs, be sure to monitor the frequency before transmitting, to avoid interference to others who may already be using the frequency.
- ❑ Four techniques for initiating Transmit/Receive control are provided on the **FTDx5000**. You may choose the technique(s) that best suit your operating needs:
  - Pressing the microphone **PTT** switch will engage the transmitter.
  - The rear panel **PTT** jack may be connected to a foot switch or other manual switching device in order to engage the transmitter.
  - Pressing the front panel **[MOX]** button will lock the transmitter on. Press the **[MOX]** button again to return to receive.
  - The VOX (Voice Operated Xmit) circuit will engage the transmitter automatically when you speak into the microphone. For VOX operation details, see page 81.

# USING THE AUTOMATIC ANTENNA TUNER

The Automatic Antenna Tuner (“ATU”) built into each **FTDx5000** is crafted to ensure a 50-Ohm load for the final amplifier stage of the transmitter. We recommend the ATU be used whenever you operate the **FTDx5000**.

## ADVICE:

- ❑ The ATU of the **FTDx5000**, being located inside the station, only adjusts the impedance presented to the transmitter at the station end of your coaxial cable feedline. It does not “tune” the SWR at the antenna feedpoint itself. When designing and building your antenna system, we recommend that every effort be made to ensure a low SWR at the antenna feedpoint.
- ❑ The ATU of the **FTDx5000** includes 100 memories for tuning data. Eleven of these memories are allocated, one per Amateur band, so that each band has at least one setting preset for use on that band. The remaining 89 memories are reserved for the 89 most-recent tuning points, allowing quick frequency change without the need to retune the ATU.
- ❑ The ATU in the **FTDx5000** is designed to match impedances within the range of 16.5 Ohms to 150 Ohms, corresponding to an SWR of 3:1 or less on the HF amateur bands (6 meter amateur band: 25 Ohms to 100 Ohms, corresponding to an SWR of 2:1 or less). Accordingly, simple non-resonant whip antennas, along with random-length wires and the “G5RV” antenna (on most bands) may not be within the impedance matching range of the ATU.

---

## ATU OPERATION

---

1. Rotate the [RF PWR] knob fully clockwise (to the right).
2. Use the Main Tuning Dial knob to set the radio to the desired operating frequency within the Amateur band.
3. Press the [TUNE] button briefly to place the ATU in the transmit line (no adjustment/tuning will occur yet). The “**TUNER**” icon will appear in the display.

### QUICK POINT:

The brief press of the [TUNE] button will turn the tuner on, and the microprocessor will automatically select the tuning point closest to the current operating frequency.

4. Press and hold in the [TUNE] button for two seconds to begin automatic tuning. The transmitter will be engaged, and the “**TUNER**” icon will blink while tuning is in progress. When the optimum tuning point has been reached, the radio will return to receive, and the “**TUNER**” icon will again glow steadily (instead of blinking).
5. To disconnect the ATU from the transmit line, press the [TUNE] button briefly. The “**TUNER**” icon will turn off, confirming that the ATU has been turned off. In the “Off” mode, the transceiver will be directly connected to the coaxial cable connected to your antenna, and it will operate based on whatever impedance is present at the station end of the coax.

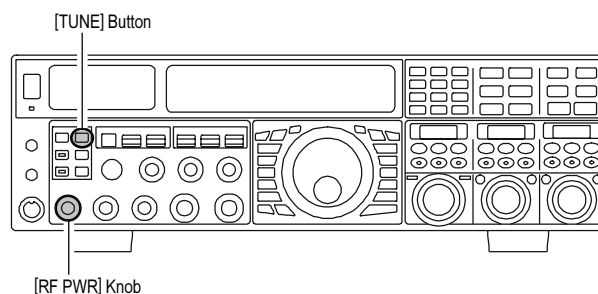

### ADVICE:

The ATU circuit is located between the final amplifier and the rear-panel antenna jack; reception is not affected by the ATU.

### QUICK POINT:

As shipped from the factory, only one ATU alignment point is saved on each Amateur band. This was memorized during the final alignment and performance verification stages on the production line.

### NOTE:

Please check the operating frequency before beginning the tuning process, to be sure you are not interfering with others who may already be using the frequency.

### TERMINOLOGY:

**Antenna Tuner Memories:** The microprocessor of the ATU makes a note of the positions of the tuning capacitors and the selected inductors, and stores the data for each 10 kHz window in which tuning has occurred. This eliminates the need to re-tune every time you return to a frequency on which you already have completed the tuning process.

# USING THE AUTOMATIC ANTENNA TUNER

## ABOUT ATU OPERATION

Figure 1 depicts a situation where normal tuning of the ATU has been successfully completed, and the tuning data has been stored in the ATU memory. The antenna system as seen by the transmitter is shown.

In Figure 2, the operator has changed frequency, and the “**HI-SWR**” icon is shown. The operator presses and holds in the [TUNE] button for two seconds to begin impedance matching using the ATU.

If a high SWR condition exists (above 3:1), corrective action must be taken in the antenna system to bring the impedance closer to 50 Ohms. The ATU will refuse to memorize settings on frequencies where the SWR exceeds 3:1. The high SWR may indicate a mechanical failure in the antenna or feed system, and such failures can lead to the generation of spurious signals causing TVI, etc.

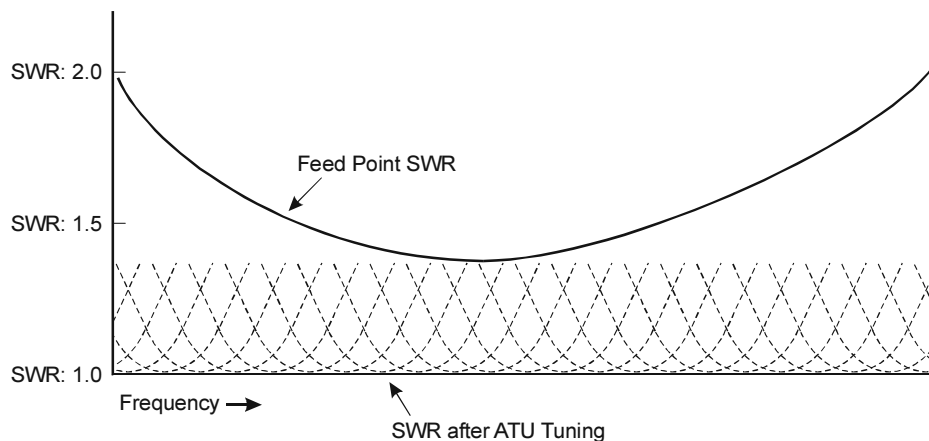

**FIGURE 1**

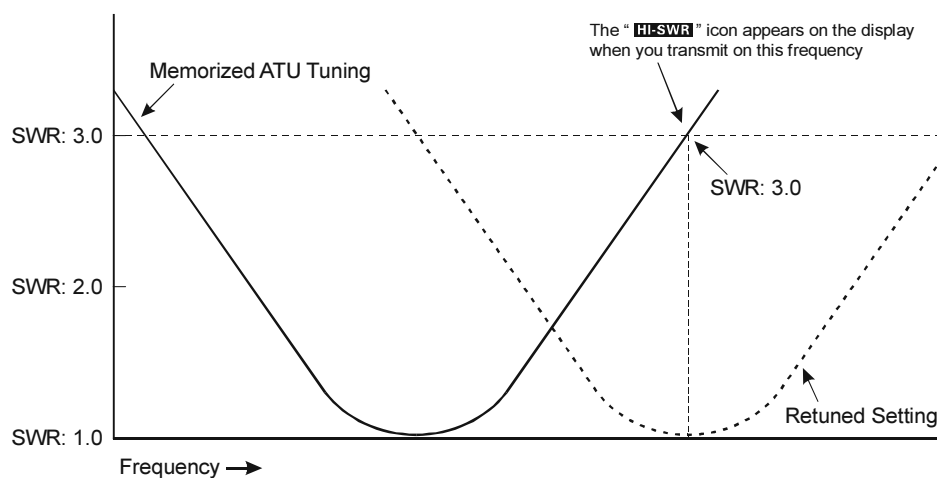

**FIGURE 2**

### About ATU Memories

#### SWR (Post-tuning) Less than 1.5:1

The tuning settings are committed to the ATU memory.

#### SWR (Post-tuning) Greater than 1.5:1

Tuning data will not be retained in memory. If you return to the same frequency, the tuning process must be repeated.

#### SWR (Post-tuning) Greater than 3:1

The “**HI-SWR**” icon will light up, and tuning settings, if achieved, will not be memorized. Please investigate and resolve the high SWR condition before attempting further operation using this antenna.

# ENHANCING TRANSMIT SIGNAL QUALITY

## PARAMETRIC MICROPHONE EQUALIZER (SSB/AM/FM MODES)

The **FTdx5000** includes a unique Three-Band Parametric Microphone Equalizer, that provides precise, independent control over the low-, mid-, and treble-ranges in your voice waveform. You may utilize one group of settings when the speech processor is off, and an another independent group of settings when the speech processor is on.

### Setup of the Parametric Microphone Equalizer

1. Connect the microphone to the **MIC** jack.
2. Set the **[RF PWR]** knob to its minimum value, to reduce interference to other users during adjustment.

#### ADVICE:

- ❑ We recommend you consider connecting a dummy load to one of the Antenna jacks, and monitor your signal on a separate receiver, to prevent interference to other users.
  - ❑ You will have the best chance of hearing the effects of adjustments if you wear headphones (connected to the monitor receiver) while monitoring your transmitted signal.
3. To adjust the Parametric Microphone Equalizer while the speech processor is disabled, press the **[PROC]** button until the “**MICEQ**” icon appears (or blinks) in the display. To adjust the Parametric Microphone Equalizer with the speech processor engaged, press the **[PROC]** button until the “**MICEQ**” and “**PROC**” icon appears in the display.

#### ADVICE:

- A blinking “**MICEQ**” icon indicates the Parametric Microphone Equalizer menu settings have all been set to “OFF”, as described later.
4. Press the **[MONI]** button, if you want to listen on the **FTdx5000**'s internal monitor. Adjust the monitor level using the **[MONI]** knob.
  5. Press the **[MENU]** button briefly. The Menu list will appear in the display.
  6. Rotate the **(VFO-A)[SELECT]** knob to find the “**TAUD**” Menu area, which contains Menu items “**151**” through “**159**”; these parameters apply to the adjustment of the Parametric Microphone Equalizer when the speech processor is disabled. Menu items “**160**” through “**168**” apply to the adjustment of the Parametric Microphone Equalizer when the speech processor is engaged.
  7. Rotate the **(VFO-B)[SELECT]** knob to perform adjustments to a particular Menu item.

#### QUICK POINT:

The Parametric Equalizer is a unique system for adjusting the signal quality. Because the high, mid, and low audio ranges may be adjusted so precisely, it is possible to craft a response that provides a more natural and pleasant sound than you have ever experienced before. Or, the effective “talk power” can be significantly enhanced.

The aspects of configuration that you may adjust with the Parametric Equalizer are:

- Center Frequency:** The center frequency of each of the three bands may be adjusted.
- Gain:** The amount of enhancement (or suppression) within each band may be adjusted.
- Q:** The bandwidth over which the equalization is applied may be adjusted.

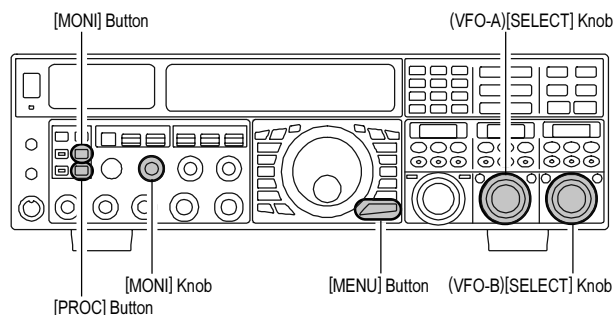

8. Press the **PTT** switch, and speak into the microphone while listening to the effects of the changes you are making (in step 6). Because the overall effect on the sound will change with each adjustment you make, you should make several passes through each adjustment area, to be sure that you are achieving the optimum setting.
9. When you have completed all adjustments, press and hold in the **[MENU]** button for two seconds to save the new settings and exit to normal operation. If you only press the **[MENU]** button momentarily to exit, any changes you performed will not be stored.

#### ADVICE:

To roll off excessive bass response in a wide-range studio microphone, try putting a 10 dB null at 100 Hz with a bandwidth of “1” or “2,” do about a 3 dB null centered on 800 Hz with a bandwidth of “3,” and then put an 8 dB peak centered on 2100 Hz with a bandwidth of “1.” These are starting recommendations; each microphone and user’s voice will be different, often requiring different settings.



# ENHANCING TRANSMIT SIGNAL QUALITY

## PARAMETRIC MICROPHONE EQUALIZER (SSB/AM/FM MODES)

### Activating the Parametric Microphone Equalizer

1. Adjust the [MIC] (gain) knob for SSB use, as described on page 70.
2. Press the [PROC] button briefly. The “**MICEQ**” icon will appear in the display, confirming that the Parametric Microphone Equalizer is engaged.

**ADVICE:**

A blinking “**MICEQ**” icon indicates the Parametric Microphone Equalizer menu settings have all been set to “OFF” (“151 TAUD EQ1 FRQ”, “154 TAUD EQ2 FRQ”, and “157 TAUD EQ3 FRQ”).

3. Press the PTT switch on the microphone, and speak into the microphone in a normal voice level.
4. To switch the Parametric Microphone Equalizer off, press the [PROC] button repeatedly until the “**MICEQ**” icon disappears.

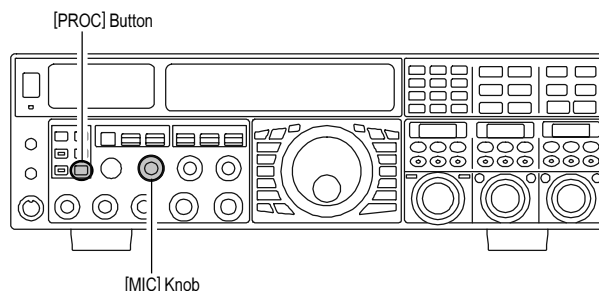

#### 3-STAGE PARAMETRIC EQUALIZER ADJUSTMENTS (SPEECH PROCESSOR: “OFF”)

Center Frequency	“151 TAUD EQ1 FRQ”	(Low) “100” (Hz) ~ “700” (Hz)
	“154 TAUD EQ2 FRQ”	(Mid) “700” (Hz) ~ “1500” (Hz)
	“157 TAUD EQ3 FRQ”	(High) “1500” (Hz) ~ “3200” (Hz)
Parametric Gain	“152 TAUD EQ1 LVL”	(Low) “-20” (dB) ~ “+10” (dB)
	“155 TAUD EQ2 LVL”	(Mid) “-20” (dB) ~ “+10” (dB)
	“158 TAUD EQ3 LVL”	(High) “-20” (dB) ~ “+10” (dB)
Q (Bandwidth)	“153 TAUD EQ1 BW”	(Low) “1” ~ “10”
	“156 TAUD EQ2 BW”	(Mid) “1” ~ “10”
	“159 TAUD EQ3 BW”	(High) “1” ~ “10”

#### 3-STAGE PARAMETRIC EQUALIZER ADJUSTMENTS (SPEECH PROCESSOR: “ON”)

Center Frequency	“160 TAUD PE1 FRQ”	(Low) “100” (Hz) ~ “700” (Hz)
	“163 TAUD PE2 FRQ”	(Mid) “700” (Hz) ~ “1500” (Hz)
	“166 TAUD PE3 FRQ”	(High) “1500” (Hz) ~ “3200” (Hz)
Parametric Gain	“161 TAUD PE1 LVL”	(Low) “-20” (dB) ~ “+10” (dB)
	“164 TAUD PE2 LVL”	(Mid) “-20” (dB) ~ “+10” (dB)
	“167 TAUD PE3 LVL”	(High) “-20” (dB) ~ “+10” (dB)
Q (Bandwidth)	“162 TAUD PE1 BW”	(Low) “1” ~ “10”
	“165 TAUD PE2 BW”	(Mid) “1” ~ “10”
	“168 TAUD PE3 BW”	(High) “1” ~ “10”

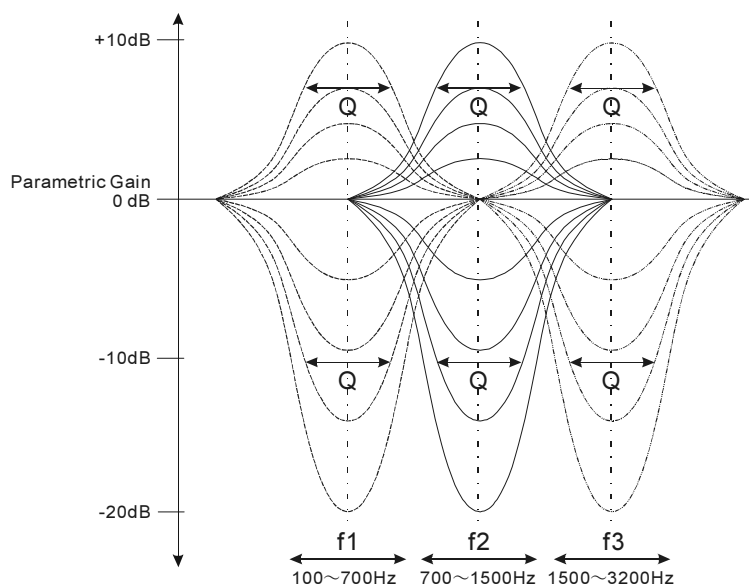

# ENHANCING TRANSMIT SIGNAL QUALITY

## USING THE SPEECH PROCESSOR (SSB MODE)

The Speech Processor is designed to increase “talk power” by increasing the average power output via a sophisticated compression technique. The result is improved intelligibility when conditions are difficult.

1. Adjust the **[MIC]** (gain) knob for SSB use, as described on page 70.
2. Press the **[PROC]** button repeatedly until the “**MICEQ**” and “**PROC**” icons appear in the display, confirming that the Speech Processor is engaged.

### ADVICE:

A blinking “**MICEQ**” icon indicates the Parametric Microphone Equalizer menu settings have all been set to “OFF” (“**160 TAUD PE1 FRQ**”, “**163 TAUD PE2 FRQ**”, and “**166 TAUD PE3 FRQ**”).

3. Set the **[PROC]** knob between the 9:00 to 12:00 o’clock position.

### ADVICE:

The relative compression level of the Speech Processor will show for 3 seconds in the lower right corner of the Main Display whenever the outer **[PROC]** knob is turned.

Alternately, the 3-second display feature may be changed to show in the **SUB DISPLAY-III** window via Menu item “**018 DISP INDI**”. Additionally, you may disable the 3-second display feature via Menu item “**017 DISP LVL IND**” See page 122 for details.

4. Rotate the **[METER]** switch fully to the left, to select “COMP” (Compression).
5. Press the **PTT** switch on the microphone, and speak into the microphone in a normal voice level. Confirm that the compression level is within the 5 dB to 10 dB range.

### ADVICE:

We recommend that you set the **[PROC]** knob between 9:00 to 12:00 o’clock position as described previously.

6. To switch the Speech Processor off, press the **[PROC]** button repeatedly until the “**MICEQ**” and “**PROC**” icons disappear.

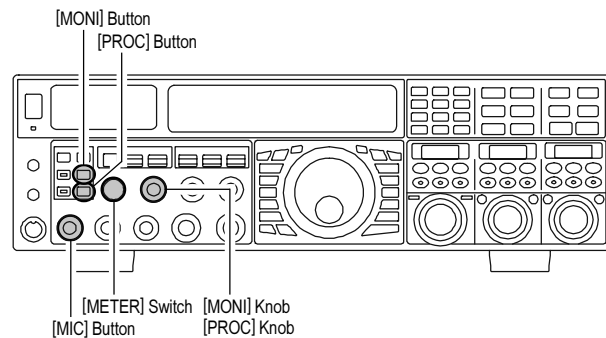

### ADVICE:

- Excessive advancement of the **[PROC]** knob will result in a degradation of the transmitted signal-to-noise ratio, thereby reducing intelligibility at the other end of the circuit.
- The Transmit Monitor provides a helpful way of verifying proper adjustment of the compression level. Pressing the **[MONI]** button then adjusting the **[MONI]** knob for a comfortable listening level while you are transmitting, allows you to hear the difference in sound quality as you make adjustments.
- The **[RF PWR]** knob still controls the RF power output, whether or not the Speech Processor is engaged.
- When the optional **DMU-2000** Data Management Unit is connected, you may observe the effect of your compression level adjustments by viewing the wave-form on the “Oscilloscope” page.

# ENHANCING TRANSMIT SIGNAL QUALITY

## ADJUSTING THE SSB TRANSMITTED BANDWIDTH (SSB MODE)

For SSB transmission, a default bandwidth of 2.4 kHz is provided. This bandwidth provides reasonable fidelity along with good talk power, and is typical of the bandwidth used for decades during SSB transmission. However, the bandwidth may be varied by the operator, when preferred, to provide different levels of fidelity or increased talk power.

Here's how to adjust the transmitted bandwidth on SSB:

1. Press the **[MENU]** button briefly, to engage the Menu.
2. Rotate the **(VFO-A)[SELECT]** knob, and select Menu item "104 A3J TX BPF".
3. Rotate the **(VFO-B)[SELECT]** knob to select the desired bandwidth. The available selections are 50-3000, 100-2900, 200-2800, 300-2700, 400-2600, and 3000WB. The default is 300-2700 Hz. A wider bandwidth will provide greater fidelity, while a narrow bandwidth will compress the available transmitter power into less spectrum, resulting in more "talk power" for DX pile-ups.
4. Press and hold in the **[MENU]** button for two seconds to save the new setting and exit to normal operation.

### ADVICE:

- ❑ The Transmit Monitor is very helpful way of verifying the effects on fidelity of changing the bandwidth. Pressing the **[MONI]** button then adjusting the **[MONI]** knob for a comfortable listening level while you are transmitting, you will be able to hear the difference in sound quality as you make changes.
- ❑ When the optional **DMU-2000** Data Management Unit is connected, you may verify the effect of your adjustments of the transmitted bandwidth by observing the Audio Scope on the "Oscilloscope" page.

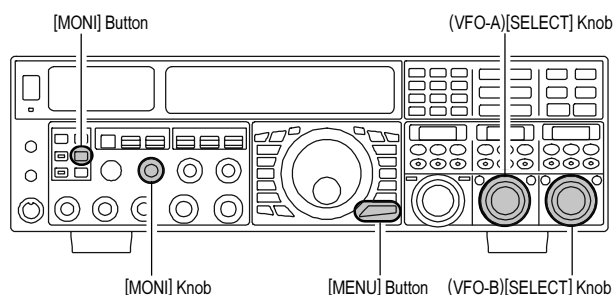

### QUICK POINTS:

- ❑ The higher fidelity associated with wide bandwidth will be particularly enjoyable on the low bands, during local rag-chew QSOs.
- ❑ The "3000WB" setting is a special hi-fidelity setting, whereby the transmitted bandwidth is in excess of 3 kHz. This selection, in conjunction with judicious adjustment of the Parametric Microphone Equalizer (see next chapter) can provide truly outstanding fidelity and very natural-sounding audio.
- ❑ When using the wider bandwidth selections (especially "3000WB"), the apparent power output from the transmitter may seem lower. This is because the available power from the transmitter is being distributed over a wider bandwidth, and the power detection circuitry does not compensate for the effect of the bandwidth selection (it is calibrated in the default 2.4 kHz bandwidth).

# ENHANCING TRANSMIT SIGNAL QUALITY

## LOW-DISTORTION CLASS-A OPERATION (SSB MODE)

Class-A operation of the **FTdx5000** transmitter is provided, yielding ultra-low distortion products during SSB operation. Power output during Class-A operation is 75 Watts.

1. To engage Class-A operation, press the **[CLASS-A]** button. The “**CLASS-A**” icon will appear in the display, confirming that Class-A operation has been selected.
2. Engaging the “Class-A” mode actually places the transceiver in a condition whereby the Bias level may be adjusted, via the Menu mode.
  - 1) Press the **[MENU]** button briefly, to engage the Menu.
  - 2) Rotate the **(VFO-A)[SELECT]** knob, and select Menu item “**169 TGEN BIAS**”.
  - 3) Rotate the **(VFO-B)[SELECT]** knob to select the desired BIAS level “**1 - 100**” to set the transceiver for operation anywhere between Class-A and Class-AB (Class-AB has lower heat dissipation but higher distortion products).

A menu setting of “**100**” will place the transmitter fully in Class-A operation. Counter-clockwise rotation of the **(VFO-B)[SELECT]** knob will move the transmitter toward Class-AB operation. The menu setting “**1**” will place the transmitter fully in Class-AB operation.
  - 4) Press and hold in the **[MENU]** button for two seconds to save the new setting and exit to normal operation.
3. To exit from the CLASS-A mode, press the **[CLASS-A]** switch once more. The “**CLASS-A**” icon disappears, confirming that the CLASS-A mode has been disengaged.

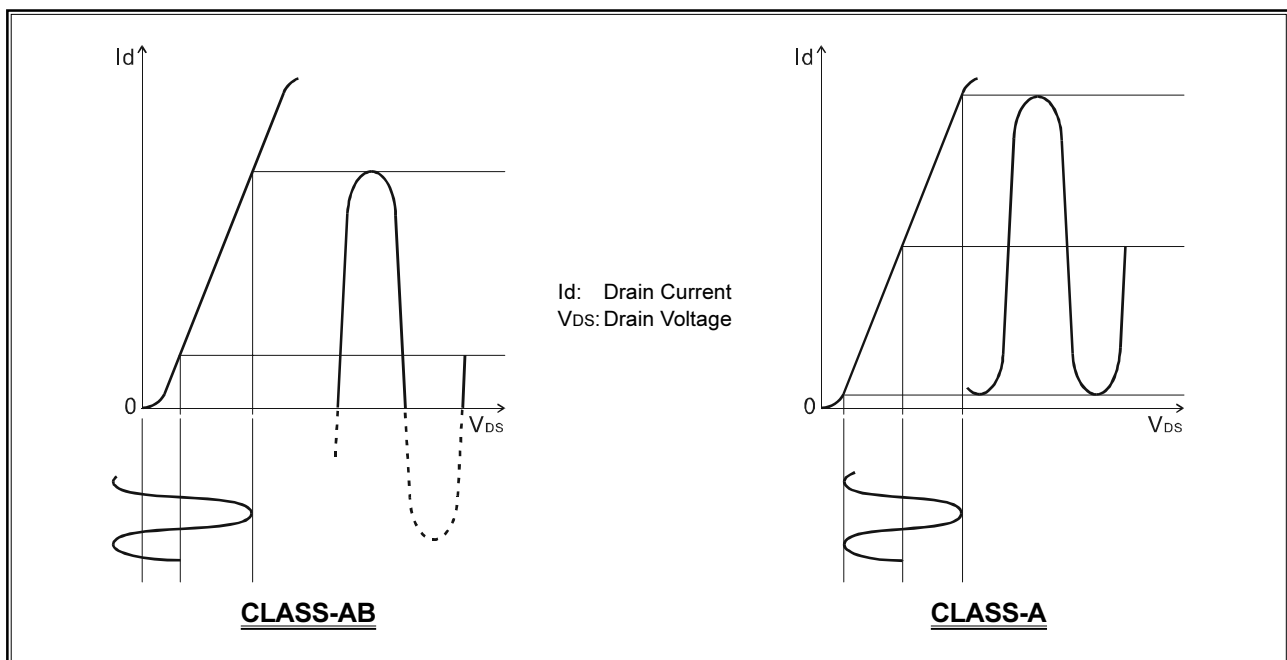
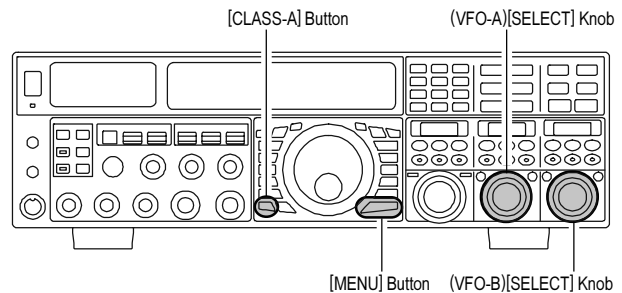

# ENHANCING TRANSMIT SIGNAL QUALITY

## LOW-DISTORTION CLASS-A OPERATION (SSB MODE)

### ADVICE

- During Class-A operation, 10-Amps of Bias current will be flowing, regardless of the modulation level that leads to actual power output. Therefore, if the ambient temperature in your operation location is high, the transceiver temperature may rise as well, due to the high bias level (which must be dissipated as heat). Depending on the temperature, you may wish to reduce the BIAS level using menu item “169 TGEN BIAS”, to reduce the amount of heat being generated.
- When the optional **DMU-2000** Data Management Unit and a video monitor are connected, you can monitor the heat sink temperature on the video monitor; thus, you can always be aware of a rise in temperature during Class-A operation. Normally, the temperature is below 80 °C. If the temperature rises to near or above this value, however, we recommend you adjust the BIAS level toward Class-AB via menu item “169 TGEN BIAS” (decrease the numerical value to reduce the heat being dissipated).
- An innovative aspect of the “Class-A” mode is that the actual power output is always limited to 75 Watts. So even though you might adjust the BIAS in the direction of Class-AB operation, the power output will not rise; this eliminates the need to re-tune your linear amplifier, if used.

### QUICK POINT

- Class-A operation provides a significant improvement in transmitter distortion suppression. During Class-A operation, the 3rd-order IMD products are typically suppressed 45 dB. The 5th- and higher-order IMD products that can cause “splatter” and interfere with others, will typically be suppressed 70 dB or more.
- If you are using a linear amplifier such as the **VL-1000**, the low distortion produced by the **FTdx5000**'s transmitter means these intermodulation distortion products will not exist to be amplified by your linear.

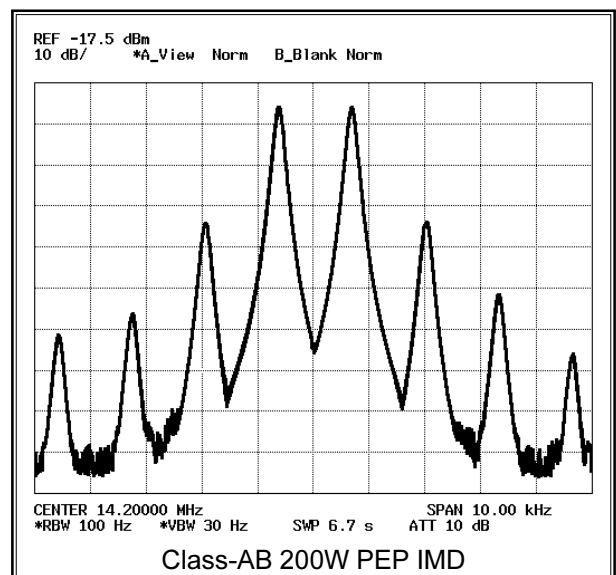
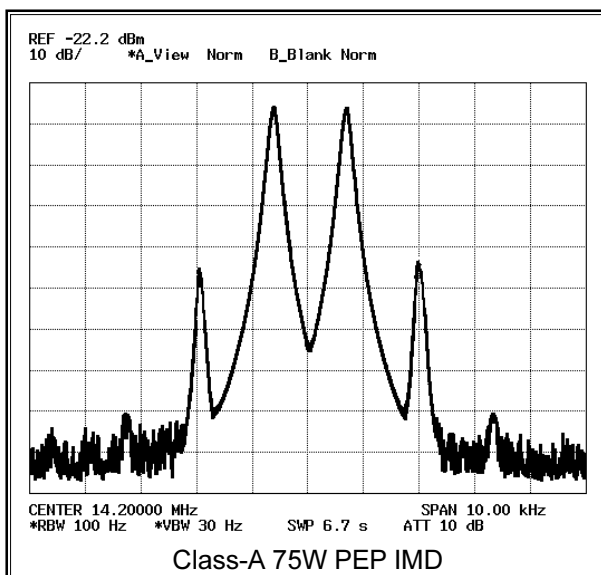

- The High-Power 200-Watt Final Amplifier Stage of the **FTdx5000** utilizes a pair of ST Micro Electronics Corp. SD2931 MOSFET devices operating at 50 Volts. The push-pull configuration provides low distortion along with high power output. The 92 mm thermostatically-controlled cooling fan directs forced air across the heat sink, when triggered by a rise in heat sink temperature.

# TRANSMITTER CONVENIENCE FEATURES

## VOICE MEMORY (SSB/AM/FM MODES)

You may utilize the Voice Memory capability of the **FTdx5000** by plugging in the supplied **FH-2** Remote Control Keypad into the rear panel **REMOTE** jack.

The Voice Memory system includes five memories capable of storing up to 20 seconds of voice audio each. The maximum that any memory can hold is 20 seconds.

### Recording Your Own Voice in Memory

1. Select the LSB, USB, AM, or FM mode using the front panel **[MODE]** buttons.
2. Press the **[MEM]** key on the **FH-2** briefly. A blinking "**REC**" icon will appear in the display

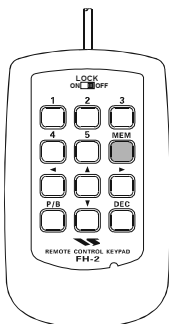

3. Press any of the **FH-2**'s keys numbered **[1]** through **[5]** to select that memory storage register. If you do not press the **PTT** key (see next step) within five seconds, the memory storage process will be cancelled.

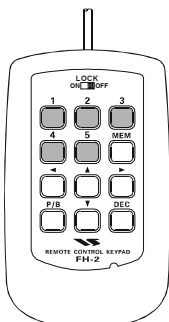

4. Press the microphone's **PTT** switch briefly, the "**REC**" icon will glow steadily, and recording will begin.
5. Speak into the microphone in a normal voice level to record the message (such as "CQ DX, CQ DX, this is W 6 Delta X-Ray Charlie, W 6 Delta X-Ray Charlie, Over"). Remember that the time limit for recording any message is 20 seconds.
6. Press the **FH-2**'s **[MEM]** key to terminate the message storage process.

### Checking Your Recording

1. Be sure that the front panel **[MOX]** and **[VOX]** buttons are both "Off" (the LED imbedded in the button must be off).
2. Press the **FH-2**'s **[1]** ~ **[5]** key (whichever one you just recorded in), and you will hear the contents of the voice memory you just recorded.

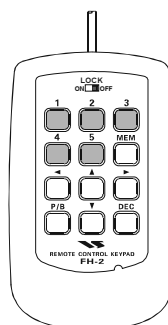

#### ADVICE:

You may adjust the playback level of the recording via Menu item "**020 DVS RX LVL**".

### Transmitting the Recorded Message

1. Select the LSB, USB, AM, or FM mode using the front panel **[MODE]** buttons.
2. Press the front panel **[BK-IN]** button briefly.
3. Press the **FH-2**'s **[1]** ~ **[5]** key, depending on which memory register message you wish to transmit. If you hit the key again during playback, the message will be terminated.

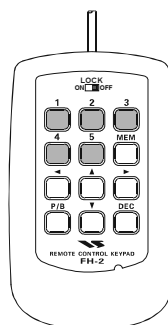

#### ADVICE:

You may adjust the transmit (audio) level of the recording via Menu item "**021 DVS TX LVL**".

# TRANSMITTER CONVENIENCE FEATURES

## VOX (AUTOMATIC TX/RX SWITCHING USING VOICE CONTROL: SSB/AM/FM MODES)

Instead of using the microphone's PTT switch or the front panel [MOX] switch to activate the transmitter, the VOX (Voice Operated TX/RX Control) system provides hands-free, automatic activation of the transmitter, based on voice input into the microphone. Setup of the VOX system takes only a few seconds.

1. Adjust the [MIC] (gain) knob for SSB use, as described on page 70.
2. Set the [VOX] and [DELAY] knobs fully counter-clockwise (to the left).
3. Press the [VOX] button briefly, to engage VOX operation. The [VOX] button will glow red.
4. Speak into the microphone in a normal voice level, and rotate the [VOX] knob clockwise (to the right) until the point where your voice input activates the transmitter.

### ADVICE:

Do not advance the setting of the [VOX] knob too far, as this will make the transmitter respond to minor background noises in your station.

5. Now stop speaking, and note the amount of time it takes for the receiver to recover. If the hang time is too long or too short; rotate the [DELAY] knob, while speaking briefly into the microphone, and then pausing, to set the desired hang time. Clockwise rotation of the [DELAY] knob will increase the hang time.

### ADVICE:

The hang time of the VOX circuit will show for 3 seconds in the lower right corner of the Main Display whenever the outer [DELAY] knob is turned.

Alternately, the 3-second display feature may be changed to show in the **SUB DISPLAY-III** window via Menu item "018 DISP INDI". Additionally, you may disable the 3-second display feature via Menu item "017 DISP LVL IND" See page 122 for details.

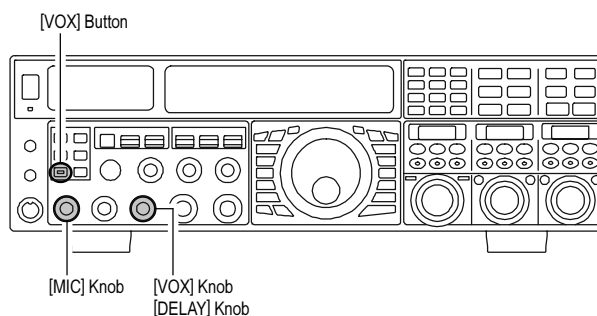

6. To exit from VOX operation, press the [VOX] button once more. We recommend doing this if you are going to leave your station, to prevent inadvertent activation of the VOX system by a ringing nearby telephone, speaker audio from a TV, etc.

### ADVICE:

- The Anti-Trip setting sets the negative feedback of receiver audio to the microphone, to prevent receiver audio from activating the transmitter (via the microphone) can be adjusted via Menu item "175 TGEN ANTI VOX".
- VOX operation may be engaged on voice modes (SSB/AM/FM) and on AFSK-based data modes. Use Menu item "174 TGEN VOX SEL" (the selections are "MIC" and "DATA").

## MONITOR (SSB/AM/FM MODES)

You may listen to the quality of your transmitted signal using the Monitor feature.

1. Press the [MONI] button. The "[MONI]" icon will appear in the display, indicating that the Monitor is turned on.
2. During transmission, rotate the [MONI] knob to adjust the audio level from the Monitor. Clockwise rotation of this knob will increase the volume level.
3. To switch the Monitor off again, press the [MONI] button briefly once more. The "[MONI]" icon will turn off, confirming that the Monitor is now disengaged.

### ADVICE:

- If you are using the speaker for monitoring, instead of headphones, excessive advancement of the [MONI] knob can cause feedback to occur. Additionally, this feedback can cause the VOX system to hang up in a loop, making it impossible to return to receive. Therefore, we recommend the use of headphones, if at all possible, or the minimum usable setting of the [MONI] knob, if the speaker must be used.
- Because the monitor feature utilizes a sampling of the transmitter's IF signal, it can be very useful for checking the adjustment of the Speech Processor or Parametric Equalizer on SSB, and for checking the general signal quality on AM and FM.

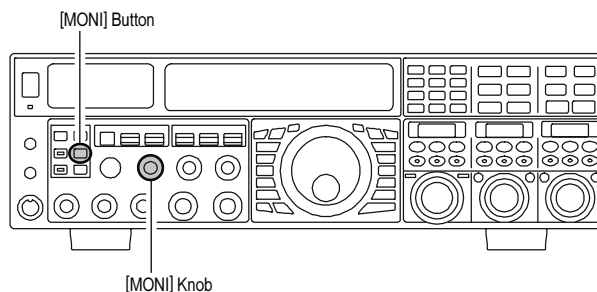

# TRANSMITTER CONVENIENCE FEATURES

## SPLIT OPERATION USING THE TX CLARIFIER (VFO-A OPERATION)

For split TX/RX operation in “casual” pile-ups, where the split is less than 10 kHz, the TX Clarifier (Offset Tuning) feature may be utilized.

1. Press the [TX CLAR/LOCK] button briefly. The “**CLAR**” and “**TX**” icon will appear in the display, and the programmed offset will be applied to the receive frequency.



CLAR  
TX 0.000

### ADVICE:

If the “**CLAR**” and “**TX**” icon does not appear, check to see if the LED imbedded in the [A/B] button glows orange. If so, pressing the [A/B] button briefly, will cause the [A/B] button to go out. Now, press the [TX CLAR/LOCK] button briefly, to begin clarifier operation.

2. Rotate the [CLAR(VFO-B)] knob to set the desired transmitter offset. A maximum split of  $\pm 9.999$  kHz may be set.
3. To exit from TX Clarifier operation, press the [TX CLAR/LOCK] button once more. The “**TX**” icon will disappear from the display.

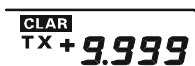

CLAR  
TX + 9.999

### QUICK POINT:

When attempting to work a DX station on CW, in a split-frequency pile-up, remember that a large number of other stations may also be using Yaesu transceivers with capabilities similar to your FTdx5000. On the DX side of the pile-up, everyone calling precisely on the same CW frequency will sound like a single tone! So you may have more success if you use the RX Clarifier to find a hole in the pile-up, instead of trying to zero-beat the last station worked by the DX station.

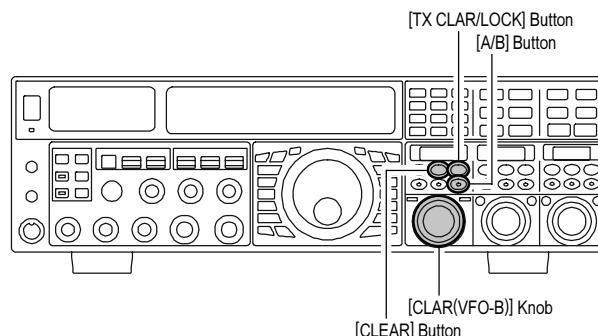

### ADVICE:

- ❑ The frequency step of the TX clarifier depends on the Main Tuning Dial knob.
- ❑ To listen to the pile-up calling the DX station, to find the station currently being worked, you may press the [RX CLAR/FAST] button. Once you have zeroed in on the station calling the DX (use the SPOT function on CW for precise alignment of your frequency), you may then briefly press the [RX CLAR/FAST] button again to cancel the RX Clarifier, and return to reception on the DX station’s frequency.
- ❑ Just as with receiver clarifier operation, the amount of offset from the original VFO frequency will appear in the small display window.
- ❑ As with receiver clarifier operation, when you turn the TX clarifier off the last-used offset is not lost, and will be available if you turn the TX Clarifier back on. To clear the Clarifier offset, briefly press the [CLEAR] button.

## Clarifier Offset Bar Indicator

A visual depiction of the relative offset of the Clarifier may be displayed, using the Bar Indicator.

1. Press the [MENU] button briefly, to enter the Menu mode.
2. Rotate the (VFO-A)[SELECT] knob to select Menu item “012 DISP BAR SEL”.
3. Rotate the (VFO-B)[SELECT] knob to select “CLAR (Clarifier)” (replacing the default “CW TUNE (CW TUNING)” selection).
4. Press and hold in the [MENU] button for two seconds to save the new setting and exit to normal operation.

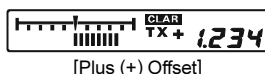

CLAR  
TX + 1.234  
[Plus (+) Offset]

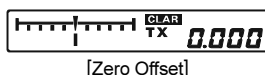

CLAR  
TX 0.000  
[Zero Offset]

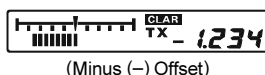

CLAR  
TX - 1.234  
[Minus (-) Offset]

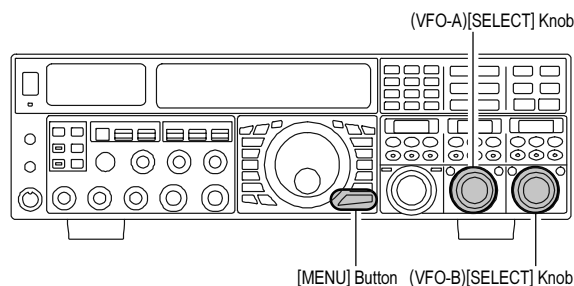



# TRANSMITTER CONVENIENCE FEATURES

## SPLIT-FREQUENCY OPERATION

A powerful capability of the **FTdx5000** is its flexibility in Split Frequency operation, using the Main (VFO-A) and Sub (VFO-B) frequency registers. This makes the **FTdx5000** especially useful for high-level DX-pedition use, as the Split operation capability is very advanced and easy to use.

1. Set the VFO-A frequency as desired.
2. Set the VFO-B frequency.
3. Now press the **[SPLIT]** button briefly. The front panel switch/LEDs will look like this:
  - (VFO-A)[RX] button: LED glows green
  - (VFO-A)[TX] button: LED off
  - (VFO-B)[RX] button: LED off
  - (VFO-B)[TX] button: LED glows red
4. During Split operation, the VFO-A register will be used for reception, while the VFO-B register will be used for transmission. If you press the **[SPLIT]** button once more, Split operation will be cancelled.
  - (VFO-A)[RX] button: LED glows green
  - (VFO-A)[TX] button: LED glows red
  - (VFO-B)[RX] button: LED off
  - (VFO-B)[TX] button: LED off
5. You may also press the **(VFO-A)[TX]** button to return transmit frequency control to the VFO-A side, thereby canceling split operation.

### ADVICE:

- During normal (non-split) VFO-A operation, you may simply press the **(VFO-B)[TX]** button (located above and to the right of the **[CLAR(VFO-B)]** knob) to engage Split operation. The **(VFO-B)[TX]** button will glow red when you press the button.
- During Split operation, pressing the **[A↔B]** button will reverse the contents of VFO-A and VFO-B. Press the **[A↔B]** button once more, to return to the original frequency alignment.
- During Split operation, if you press the **(VFO-B)[RX]** button above and to the right of the **[CLAR(VFO-B)]** knob, you will engage Dual Receive operation. Now you can listen to both sides of the DX pile-up, and transmit on the VFO-B frequency. This is very useful to determine the timing of your calls, while also monitoring both sides of the pile-up.
- During Split operation, you may also listen to the TX frequency temporarily, by pressing the **[TXW]** button (just below the **[SPLIT]** button).
- It is possible to set different operating modes (for example, LSB and USB) on the two VFOs used during Split operation.
- During Split operation, it is also possible to set VFO-A and VFO-B to different amateur bands. But, remember that Dual Reception must be within the same band.

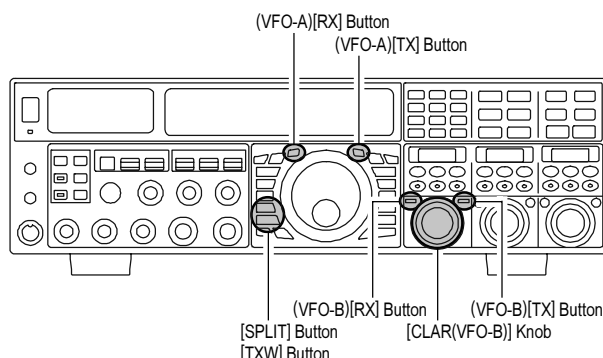

### QUICK POINT:

The **[SPLIT]** button function differs between a brief press and a long press of the button.

- Press the **[SPLIT]** button *briefly* to toggle the transmission control between VFO-A and VFO-B (Split Frequency Operation).
- Press and hold** in the **[SPLIT]** button *for two seconds* to copy the VFO-A frequency to VFO-B, this increases the VFO-B frequency + 5 kHz, and the transmission control switches to VFO-B (Quick Split Operation: See page 85).  
**Press and hold** in the **[SPLIT]** button *for two seconds again* to increment the VFO-B frequency another + 5 kHz and keep the transmission control to VFO-B.

# TRANSMITTER CONVENIENCE FEATURES

## SPLIT-FREQUENCY OPERATION

### VFO Tracking Feature

In the default setting, the VFO-A frequency and VFO-B frequency are changed individually using the Main Tuning Dial knob and the [CLAR(VFO-B)] knob.

If you want to tune the VFO-A frequency and VFO-B frequency together, the VFO Tracking feature is very useful.

Here is the procedure for activating the VFO Tracking feature:

1. Press and hold in the **(VFO-B)[RX]** button for two seconds. This provides a “Short-cut” to Menu item “**038 GENE TRACK**”.
2. Rotate the **(VFO-B)[SELECT]** knob to select the desired Tracking mode.
  - OFF: Disables the VFO Tracking feature.
  - BAND: When you change the band on the VFO-A side, the VFO-B band will automatically change to be the same band as VFO-A.
  - FREQ: This function is similar to the “BAND” setting, and will additionally “lock” VFO-A and VFO-B together. Turning the Main Dial will tune both VFO-A and VFO-B simultaneously.
3. Press and hold in the **(VFO-B)[RX]** button for two seconds to lock in the new configuration and exit to normal operation.

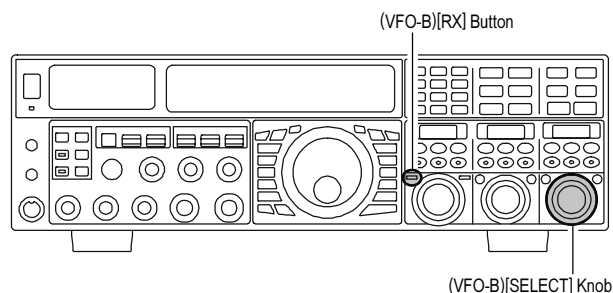

# TRANSMITTER CONVENIENCE FEATURES

## SPLIT-FREQUENCY OPERATION

### Quick Split Operation

The Quick Split feature allows you to set a one-touch offset of +5 kHz, to be applied to the transmit frequency on VFO-B, as compared to the VFO-A frequency.

1. Start with regular transceiver operation on the VFO-A.  
(VFO-A)[RX] button: LED glows green  
(VFO-A)[TX] button: LED glows red  
(VFO-B)[RX] button: LED off  
(VFO-B)[TX] button: LED off
2. Press and hold in the [SPLIT] button for two seconds to engage the Quick Split feature, and apply a frequency 5 kHz above the VFO-A frequency to the VFO-B frequency register.  
The VFO configuration will then be:  
(VFO-A)[RX] button: LED glows green  
(VFO-A)[TX] button: LED off  
(VFO-B)[RX] button: LED off  
(VFO-B)[TX] button: LED glows red
3. Press and hold in the [SPLIT] switch for two seconds to increment the VFO-B frequency another +5 kHz.

#### QUICK POINTS:

- The operating mode applied to the VFO-B register will be the same as that in use on the VFO-A register.
- The offset of the VFO-B from the VFO-A is programmed via the Menu, and is set to +5 kHz at the factory. Other offsets may be selected using the following procedure:

1. Press the [MENU] button briefly, to enter the Menu mode.
2. Rotate the (VFO-A)[SELECT] knob to select Menu item "037 GENE Q SPLIT".
3. Rotate the (VFO-B)[SELECT] knob to select the desired offset.  
The available selections are -20kHz ~ +20kHz (factory default: +5 kHz).
4. When you have completed all adjustments, press and hold in the [MENU] button for two seconds to save the new setting and exit to normal operation. If you only press the [MENU] button briefly to exit, any changes you performed will not be stored.

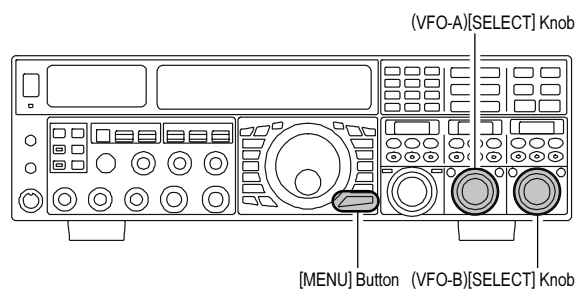
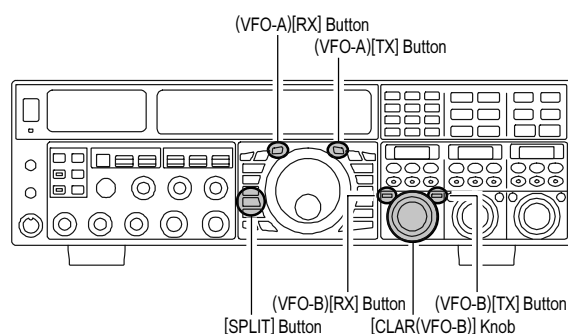

# CW MODE OPERATION

The powerful CW operating capabilities of the **FTdx5000** include operation using both an electronic keyer paddle and a “straight key” or emulation thereof, as is provided by a computer-based keying device.

## SETUP FOR STRAIGHT KEY (AND STRAIGHT KEY EMULATION) OPERATION

Before starting, connect your key line(s) to the front and/or rear panel **KEY** jack(s). Be sure the **[KEYER]** button on the front panel is turned off for now.

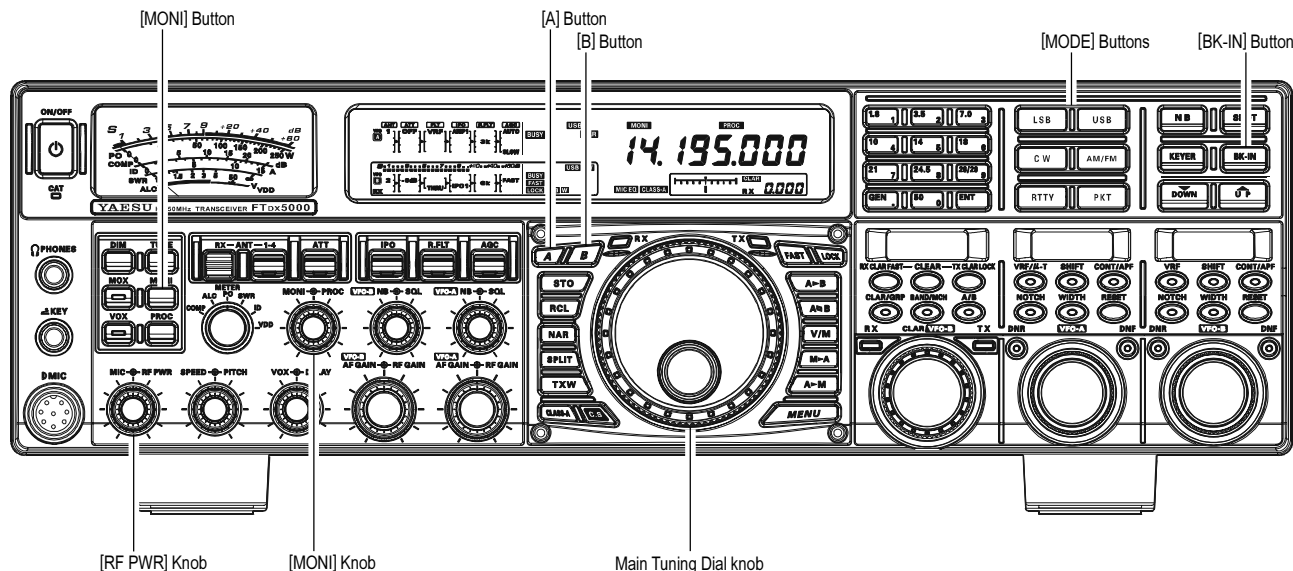

1. Press the **[CW]** mode button to engage CW operation. The “**CW**” and “**USB**” icons will appear in the display. The “**MONI**” icon will also appear in the display; and the CW monitor is activated.

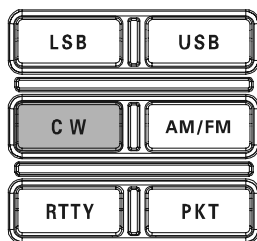

**ADVICE:**

- The operating mode is selected using the **[MODE]** button. The VFO, to which the selection is applied, is selected by the **[A]** or **[B]** button (located to the upper left of the Main Tuning Dial knob). Usually, the **[A]** button glows red, signifying VFO-A is being adjusted. Alternately, pressing the **[B]** button will cause its indicator to glow orange, signifying VFO-B adjustment. Therefore, press the **[A]** or **[B]** button to select the desired VFO, then press the **[CW]** button to select the CW mode.
  - After initially selecting CW, if you press the **[CW]** button once more, you will engage the “CW Reverse” mode (see page 92). Normally, the upper sideband (USB) is used in conjunction with CW. In reverse CW the lower sideband (LSB) is used.
2. Rotate the Main Tuning Dial knob to select the desired operating frequency.

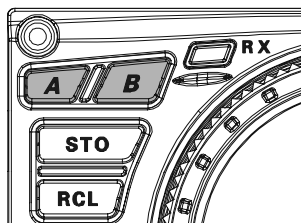

3. Press the **[BK-IN]** button briefly, to engage automatic activation of the transmitter when you close the CW key. The “**BK-IN**” icon will appear in the display.

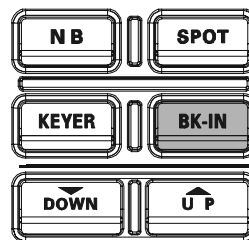

**ADVICE:**

- When you close your CW key, the transmitter will automatically be activated, and the CW carrier will be transmitted. When you release the key, transmission will cease after a brief delay; the delay time is user-programmable, per the discussion on page 93.
  - As shipped from the factory, the **FTdx5000** TX/RX system for CW is configured for “Semi-break-in” operation. However, using Menu item “**063 A1A BK-IN**”, you may change this setup for full break-in (QSK) operation, whereby the switching is quick enough to hear incoming signals in the spaces between the dots and dashes of your transmission. This may prove very useful during contest and traffic-handling operations.
4. Operation using your CW key may now proceed. A CW sidetone sounds from a speaker in accordance with your keying. Adjust the **[MONI]** knob for a comfortable listening level of the CW sidetone.

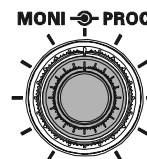

## SETUP FOR STRAIGHT KEY (AND STRAIGHT KEY EMULATION) OPERATION

### ADVICE:

- You may disable the CW sidetone by pressing the [MONI] button. The “MONI” icon will turn off, confirming that the Monitor is now disengaged.
- If you set the [BK-IN] button to off, you may practice your sending without having the signal go out over the air (sidetone only).
- If you reduce power using the [RF PWR] knob, the ALC meter reading will increase. This is normal and does not indicate any problem whatsoever (because increased ALC voltage is being used to lower the power).

### NOTE:

- Use only a 3-pin (“stereo”) 1/4” phone plug; a 2-pin plug will place a short between the ring and (grounded) shaft of the plug, resulting in a constant “key-down” condition in some circumstances.

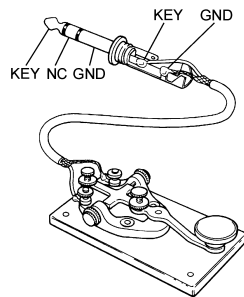

### TERMINOLOGY:

#### Semi-break-in

This is a pseudo- “VOX” mode used on CW, where the closure of the CW key will engage the transmitter. Releasing the key, will allow the receiver to recover after a short delay. No signals will be heard between the spaces between dots and dashes (unless the sending speed is extremely slow).

#### Full break-in

Full break-in (Also known as “Full QSK”) involves very fast switching between transmit and receive, such that incoming signals may be heard between the dots and dashes as you send them. This allows you to hear a station that suddenly starts transmitting on your frequency, while you are in the midst of sending a message.

# CW MODE OPERATION

## USING THE BUILT-IN ELECTRONIC KEYS

Connect the cable from your keyer paddle to the front or rear panel **KEY** jack.

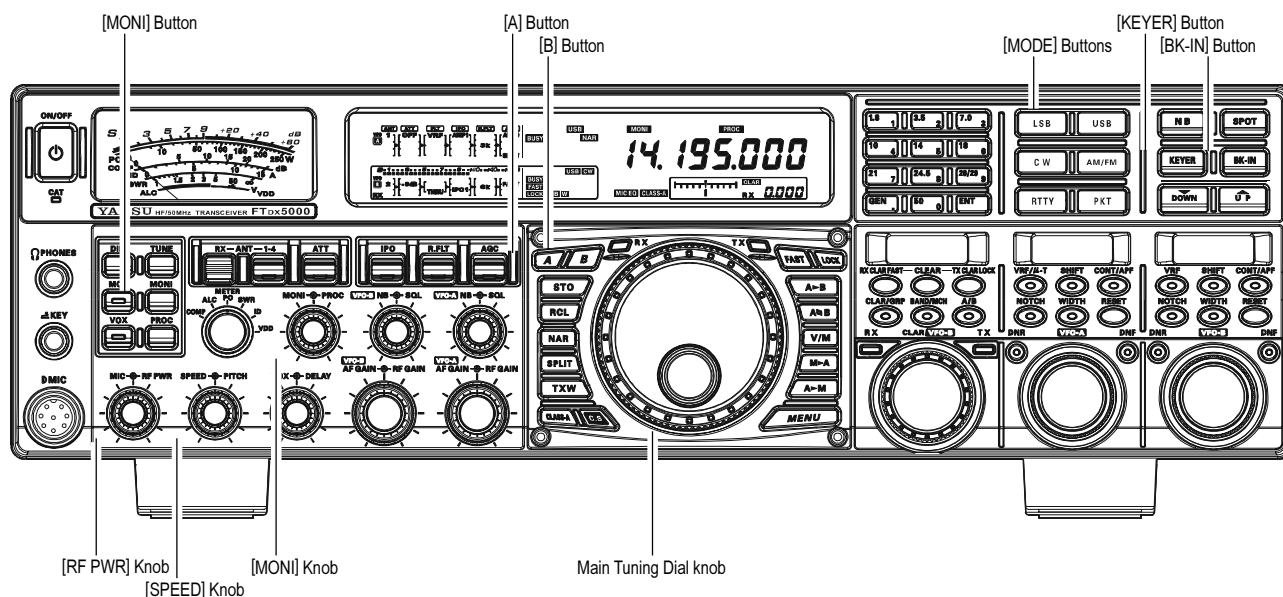

1. Press the **[CW]** mode button to engage CW operation. The “**CW**” and “**USB**” icons will appear in the display, and the CW monitor will be activated.

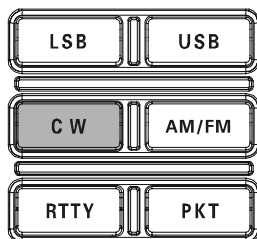

**ADVICE:**

- The operating mode is selected using the **[MODE]** button. The (A or B) VFO to which the selection is applied, is selected by the **[A]** or **[B]** button, located to the upper left of the Main Tuning Dial knob. Usually, the **[A]** button glows red, signifying VFO-A is being adjusted. Alternately, pressing the **[B]** button will cause its indicator to glow orange, signifying VFO-B adjustment. Therefore, press the **[A]** or **[B]** button to select the desired VFO, then press the **[CW]** button to select the CW mode.

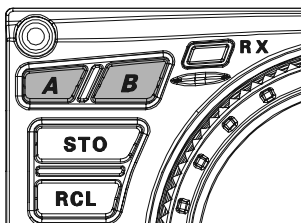

- After initially selecting CW, If you press the **[CW]** button once more you will engage the “CW Reverse” mode (see page 92), whereby the “opposite” sideband injection is used. Normally, the upper sideband (USB) is used in conjunction with CW. In reverse CW the lower sideband (LSB) is used. The “**CW**” and “**LSB**” icons will appear if you select CW Reverse.
2. Rotate the Main Tuning Dial knob to select the desired operating frequency.

3. Press the **[KEYER]** button. The “**KEYER**” icon will appear in the display, confirming that the built-in Electronic Keyer is now active.
4. Rotate the **[SPEED]** knob to set the desired sending speed (4 ~ 60 wpm). Clockwise rotation of the **[SPEED]** knob will increase the keying speed.

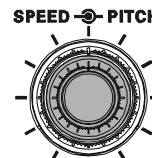
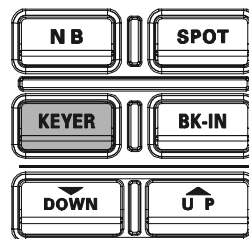

**ADVICE:**

- The keying speed will show for 3 seconds in the lower right corner of the Main Display whenever the outer **[SPEED]** knob is turned. Alternately, the 3-second display feature may be changed to show in the **SUB DISPLAY-III** window via Menu item “**018 DISP INDI**”. Additionally, you may disable the 3-second display feature via Menu item “**017 DISP LVL IND**” See page 122 for details.
  - When you press either the “Dot” or “Dash” side of your paddle, the transmitter will automatically be activated.
5. If you press the **[BK-IN]** button briefly, “semi-break-in” operation (discussed previously) will be engaged.
  6. CW operation utilizing your paddle may now commence.

A CW sidetone sounds from a speaker in accordance with your keying. Adjust the **[MONI]** knob for a comfortable listening level of the CW sidetone.

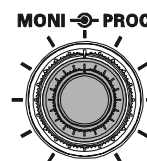

## USING THE BUILT-IN ELECTRONIC KEYS

### ADVICE:

- ❑ You may disable the CW sidetone by pressing the [MONI] button. The “MONI” icon will turn off, confirming that the Monitor is now disengaged.
- ❑ When you utilize your keyer paddle, the transmitter will automatically be activated, and the CW characters (or a string of dots and dashes) will be transmitted. When you release the keyer paddle contacts, transmission will cease after a brief delay. The delay time is user-programmable, per the discussion on page 93.
- ❑ If you reduce power using the [RF PWR] knob, the ALC meter reading will increase. This is normal and does not indicate any problem whatsoever (because increased ALC voltage is being used to lower the power).

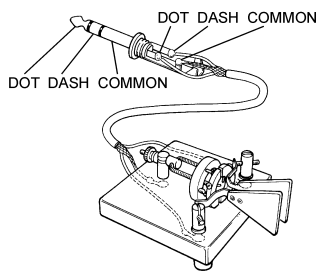

### Full Break-in (QSK) Operation

As shipped from the factory, the FTdx5000 TX/RX system for CW is configured for “Semi-break-in” operation. However, using Menu item “063 A1A BK-IN”, you may change this setup for full break-in (QSK) operation, whereby the switching is quick enough to hear incoming signals in the spaces between the dots and dashes of your transmission.

1. Press the [MENU] button to enter the Menu mode.
2. Rotate the (VFO-A)[SELECT] knob to select Menu item “063 A1A BK-IN”.
3. Rotate the (VFO-B)[SELECT] knob to set this Menu item to “FULL”.
4. Press and hold in the [MENU] button for two seconds to save the new setting and exit.

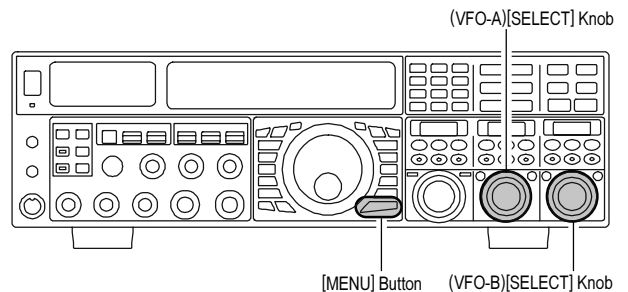

# CW MODE OPERATION

## USING THE BUILT-IN ELECTRONIC KEYS

A number of interesting and useful features are available during Electronic Keyer operation.

### SETTING THE KEYS WEIGHT (DOT/SPACE:DASH) RATIO

The Menu may be used to adjust the Weight for the built-in Electronic Keyer. The default weighting is 3:1 (a dash is three times longer than a dot or space).

1. Press the **[MENU]** button briefly, to enter the Menu mode.
2. Rotate the **(VFO-A)[SELECT]** knob to select Menu item “**065 A1A WEIGHT**”.
3. Rotate the **(VFO-B)[SELECT]** knob to set the weight to the desired value. The available adjustment range is for a Dot/Space:Dash ratio of “2.5” ~ “4.5” (default value: “3.0”).
4. When you are finished, press and hold in the **[MENU]** button for two seconds to save the new setting and exit to normal operation.

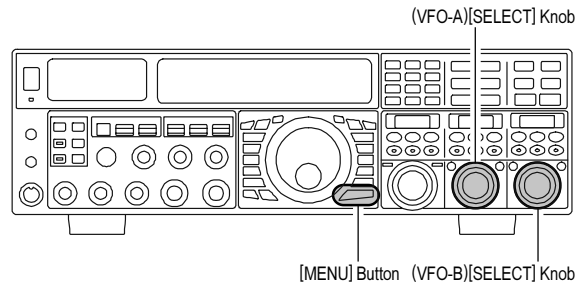

### SELECTING THE KEYS OPERATING MODE

The configuration of the Electronic Keyer may be customized independently for the front and rear **KEY** jacks of the **FTDX5000**. This permits utilization of Automatic Character Spacing (ACS), if desired, as well as the use of the electronic keyer via the front jack and a straight key or computer-driven keying line via the rear panel.

1. Press the **[MENU]** button briefly, to enter the Menu mode.
2. Rotate the **(VFO-A)[SELECT]** knob to select Menu item “**057 A1A F-TYPE**” (for the front **KEY** jack) or “**059 A1A R-TYPE**” (for the rear-panel **KEY** jack).
3. Rotate the **(VFO-B)[SELECT]** knob to set the keyer to the desired mode. The available selections are:
  - OFF:** The built-in Electronic Keyer is turned off (“straight key” mode).
  - BUG:** Dots will be generated automatically by the keyer, but dashes must be sent manually.
  - ELEKEY:** Both dots and dashes will be generated automatically when you use your paddle.
  - ACS:** Same as “ELEKEY” except that the spacing between characters is precisely set by the keyer to be the same length as a dash (three dots in length)
4. When you are finished, press and hold in the **[MENU]** button for two seconds to save the new setting and exit to normal operation.

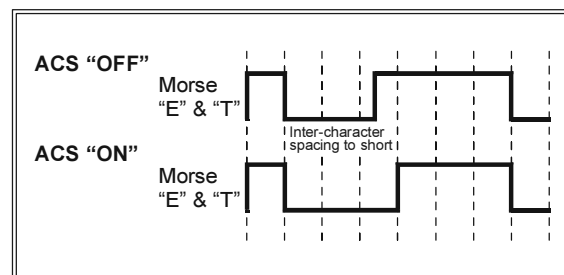
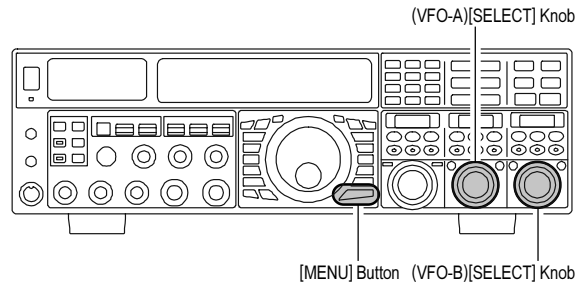



# CW CONVENIENCE FEATURES

## CW SPOTTING (ZERO-BEATING)

“Spotting” (zeroing in on another CW station) is a handy technique for ensuring that you and the other station are precisely on the same frequency.

For everyday operation, the (CW) [PITCH] knob allows you to set the center of the receiver passband, as well as the offset pitch of your CW carrier signal, to the tone pitch you prefer to listen to.

The Tuning Offset Indicator in the display may also be moved so you can adjust your receiver frequency to center the incoming station on the pitch corresponding to that of your transmitted signal.

### Using the SPOT System

While pressing the front panel [SPOT] button, the spot tone will be heard in the speaker, and the spot tone frequency will show in the lower right corner of the Main Display. This tone corresponds to the pitch of your transmitted signal, and if you adjust the receiver frequency to match the pitch of the received CW signal to that of the spot tone, your transmitted signal will be precisely matched to that of the other station.

Release the [SPOT] button to turn the spot tone off.

#### ADVICE:

- ❑ In a tough DX pile-up, you may actually want to use the SPOT system to find a “gap” in the spread of calling stations, instead of zeroing in precisely on the last station being worked by the DX station. From the DX side, if a dozen or more operators (also using Yaesu’s SPOT system) all call precisely on the same frequency, their dots and dashes merge into a single, long tone that the DX station cannot decipher. In such situations, calling slightly higher or lower may get your call through.
- ❑ The Tuning Offset Indicator in the display may be utilized for CW frequency adjustment, as well. Its configuration is set via Menu item “012 DISP BAR SEL” at the factory, and the Tuning Offset Indicator is already set to the “CW TUNE” selection.

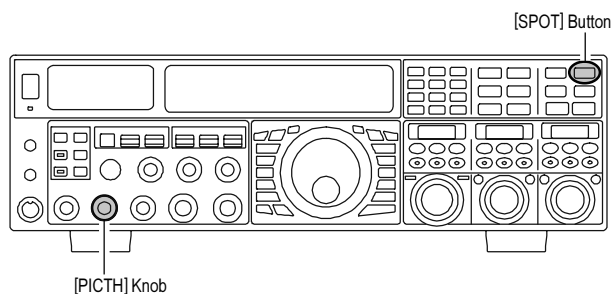
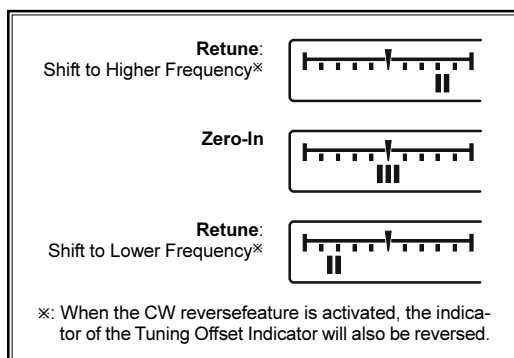

#### QUICK POINTS:

- ❑ The CW spotting process utilizes the spot tone or the Tuning Offset Indicator, with the actual offset pitch being set by the [PITCH] knob on the front panel. The offset pitch may be set to any frequency between 300 Hz and 1050 Hz, in 50 Hz steps, and you can either match tones audibly (using the [SPOT] button) or align the receiver frequency so that the central red bar on the Tuning Offset Indicator lights up. Note that there are 21 “dots” on the Tuning Offset Indicator, and depending on the resolution selected, the incoming CW signal may fall outside the visible range of the bar indicator, if you are not reasonably close to the proper alignment of tones.
- ❑ The displayed frequency on CW, normally reflects the “zero beat” frequency of your offset carrier. That is, if you were to listen on USB on 14.100.70 MHz to a signal with a 700 Hz offset, the “zero beat” frequency of that CW carrier would be 14.000.70 MHz. The latter frequency is what the FTdx5000 displays, by default. However, you can change the display to be identical to what you would see on SSB by using Menu item “066 A1A FRQ DISP” and setting it to “FREQ” instead of its default “PITCH” setting.

# CW CONVENIENCE FEATURES

## USING CW REVERSE

If you experience a difficult interference situation, where an interfering station cannot readily be eliminated, you may wish to try receiving using the opposite sideband. This may move the interfering station's frequency in a direction that may lend itself more readily to rejection.

1. To start, let's use a typical example where you have set the CW mode (using the default "USB" injection) on the VFO-A receiver.
2. Now be sure your mode selection is still set for the VFO-A register, and press the [CW] mode button once more. The "CW" and "LSB" icons will appear in the display, indicating that the "LSB" injection side has now been selected.
3. When using Dual Receive, press the [B] button, which is located to the upper left of the Main Tuning Dial knob. Then press the [CW] button to engage CW Reverse on the VFO-B receiver, in exactly the same way as for the VFO-A receiver.
4. Press the [CW] mode button once more to return to the normal (USB) injection side and cancel CW Reverse operation (the "CW" and "USB" icons will appear in the display).

### NOTES:

- When CW Reverse is engaged, the Tuning Offset Indicator action will concurrently be reversed.
- When the incoming signal pitch tone is properly aligned, the central red marker lights up whether or not CW Reverse is engaged.

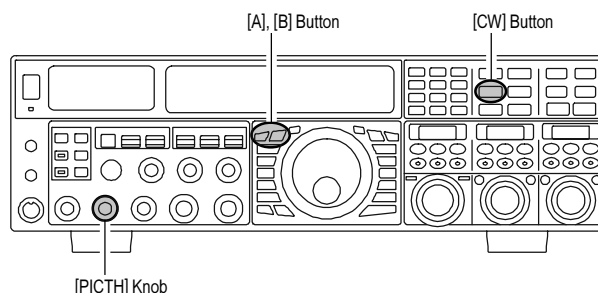
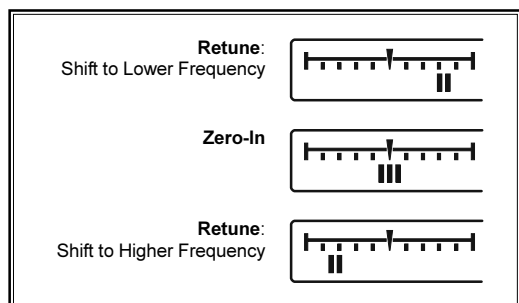

In the illustration, Figure "A" demonstrates the normal CW injection setup, using the USB side. In Figure "B", CW Reverse has been engaged. LSB-side injection is being used to eliminate interference.

The beneficial effect of switching sidebands can be clearly seen in this example.

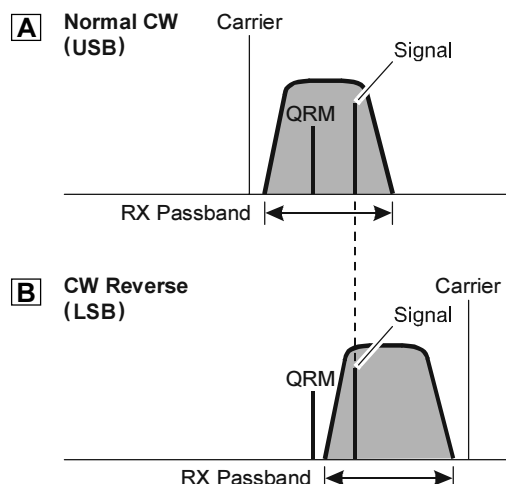

## AUDIO PEAK FILTER

1. Where you have set the CW mode on the VFO-A receiver, press the (VFO-A)[CONT/APF] button briefly, to activate the APF (Audio Peak Filter) which provides a very narrow audio bandwidth. The peak position of the APF will appear in the **SUB DISPLAY-II** window, and the (VFO-A)[SELECT] knob will now function as the APF knob.
2. Rotate the (VFO-A)[SELECT] knob to the left or right to reduce any interference.
3. To disable the APF, press the (VFO-A)[CONT/APF] button briefly, again.
4. To activate the APF (Audio Peak Filter) on VFO-B, press the (VFO-B)[CONT/APF] button briefly, and adjust the (VFO-B)[SELECT] knob to reduce any interference. The peak position of the APF will be indicated in the **SUB DISPLAY-III** window.

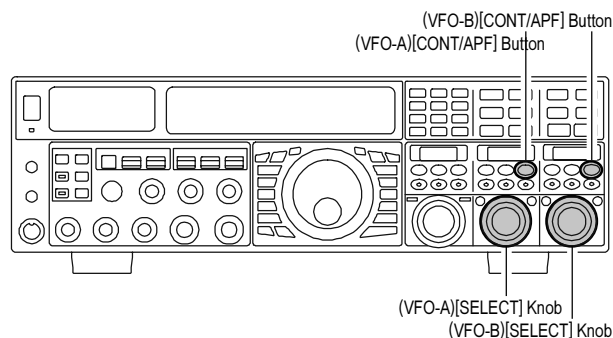

# CW CONVENIENCE FEATURES

## CW DELAY TIME SETTING

During semi-break-in (not QSK) operation, the hang time of the transmitter, after you have finished sending, may be adjusted to a comfortable value consistent with your sending speed. This is the functional equivalent to the “VOX Delay” adjustment used on voice modes, and the delay may be varied anywhere between 20 milli-seconds with the ([**DELAY**] knob set fully counter-clockwise) and 5 seconds (fully clockwise).

1. Press the [**BK-IN**] button to enable CW transmission (Menu item “**059 A1A BK-IN**” must be set to “SEMI”).
2. Start sending, and adjust the [**DELAY**] knob so that the hang time is as you prefer for comfortable operation.

### ADVICE:

The delay time will show for 3 seconds in the lower right corner of the Main Display whenever the outer [**DELAY**] knob is turned.

Alternately, the 3-second display feature may be changed to show in the **SUB DISPLAY-III** window via Menu item “**018 DISP INDI**”. Additionally, you may disable the 3-second display feature via Menu item “**017 DISP LVL IND**” See page 122 for details.

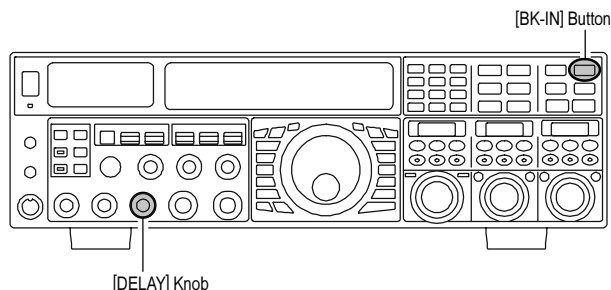

## CW PITCH ADJUSTMENT

Rotation of the front panel's [**PITCH**] knob will allow adjustment of the center frequency of the receiver pass-band, as well as the pitch of your offset CW carrier, to the tone you prefer. The tone may be varied between 300 Hz and 1050 Hz, in 50 Hz steps.

### ADVICE:

The spot tone frequency will show for 3 seconds in the lower right corner of the Main Display whenever the outer [**PROC**] knob is turned.

Alternately, the 3-second display feature may be changed to show in the **SUB DISPLAY-III** window via Menu item “**018 DISP INDI**”. Additionally, you may disable the 3-second display feature via Menu item “**017 DISP LVL IND**” See page 122 for details.

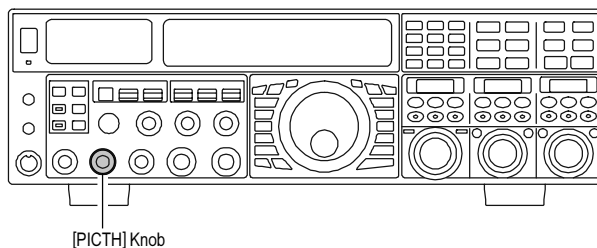

### TERMINOLOGY:

**CW Pitch:** If you tuned to an exact “zero beat” on an incoming CW signal, you could not copy it (“Zero beat” implies a 0 Hz tone). Therefore, the receiver is offset several hundred Hz (typically), to produce an audio tone your ear can detect. The BFO offset associated with this tuning (that produces the comfortable audio tone) is called the CW Pitch.

# CW CONVENIENCE FEATURES

## CONTEST MEMORY KEYS

The **FTDX5000** is capable of the automatic sending of CW messages (as you might do in a contest) by plugging the supplied **FH-2** Remote Control Keypad into the rear panel **REMOTE** jack. Two techniques for message storage are available: you may either send the desired message contents using your keyer paddle (“*Message Memory*”), or you may input the text characters using the **(VFO-A)[SELECT]** knob and **(VFO-B)[SELECT]** knobs (“*Text Memory*”).

### MESSAGE Memory

Five memory channels capable of retaining 50 characters total are provided (using the PARIS standard for character and word length).

*Example:* CQ CQ CQ DE W6DXC K (19 characters)

· · · · ·    · · · · ·    · · ·    · · · · ·    · · · · ·    · · ·    ·    · · · · · · ·    · ·    · · ·    · · ·    · · ·  
 (C) (Q) (C) (Q) (C) (Q) (D) (E) (W) (6) (D) (X) (C) (K)

### STORING A MESSAGE INTO MEMORY

1. Press the **[MENU]** button briefly, to enter the Menu mode.
2. Rotate the **(VFO-A)[SELECT]** knob to select the CW Memory Register you wish to store the message into. For now we are just selecting the message entry technique (Keyer entry).

- 025 KEY CW MEM1
- 026 KEY CW MEM2
- 027 KEY CW MEM3
- 028 KEY CW MEM4
- 029 KEY CW MEM5

3. Rotate the **(VFO-B)[SELECT]** knob to set the selected Memory Register to “MESSAGE”. If you want to use your keyer paddle for message entry on all memories, set all five Menu items (#025 ~ 029) to “MESSAGE”.
4. Press and hold in the **[MENU]** button for two seconds to save the new settings and exit.

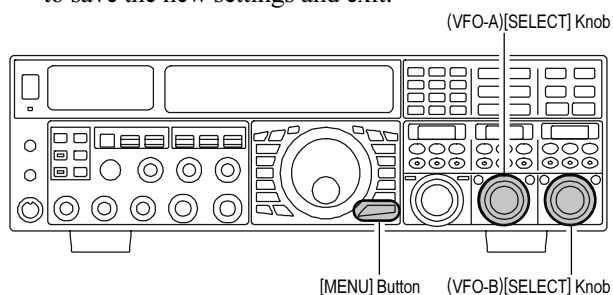

### MESSAGE MEMORY PROGRAMMING (USING YOUR PADDLE)

1. Set the operating mode to CW.
2. Set the **[BK-IN]** button to Off.
3. Turn the internal Electronic Keyer “on” by pressing the **[KEYER]** button briefly, if necessary.
4. Press the **FH-2**’s **[MEM]** key.

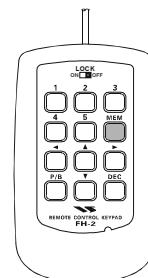

5. Press the **[1] ~ [5]** key on the **FH-2** to begin the memory storage process.

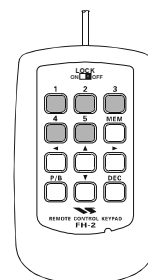

6. Send the desired message using your keyer paddle.
7. Press the **[MEM]** key on the **FH-2** once more at the end of your message. Up to 50 characters may be stored among the five memories.

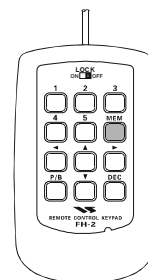

### NOTE:

- You must exercise care in sending to ensure that the spaces between letters and words are accurately done. If your timing is off, the spacing may not come out right in the stored message.
- For ease in setting up the keyer memories, we recommend you set Menu item “**057 A1A F-TYPE**” and/or “**059 A1A R-TYPE**” to “ACS” (Automatic Character Spacing) while you are programming the keyer memories.

### TERMINOLOGY:

**PARIS Word Length:** By convention in the Amateur industry (utilized by ARRL and others), the length of one “word” of CW is defined as the length of the Morse Code characters spelling the word “PARIS.” This character (dot/dash/space) length is used for the rigorous definition of code speed in “words per minute.”

# CW CONVENIENCE FEATURES

## CONTEST MEMORY KEYER

### CHECKING THE CW MEMORY CONTENTS

1. Be sure that Break-in is still turned “off” by the [BK-IN] button.
2. Press the [MONI] button to enable the CW monitor.
3. Press the FH-2’s [1] ~ [5] key to check your work. You will hear the results in the sidetone, but no RF energy will be transmitted.

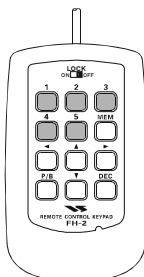

#### NOTE:

Adjust the monitor level using the [MONI] knob.

### ON-THE-AIR CW MESSAGE PLAYBACK

1. Press the [BK-IN] button to enable transmission. Either Full- or Semi-break-in will be engaged, depending on the setting of Menu item “063 A1A BK-IN”.
2. Press an FH-2’s [1] ~ [5] key to transmit the programmed message.



#### NOTE:

If you subsequently decide to use the “Text Memory” technique for message storage, on a particular memory register, the contents of a message stored using the keyer paddle input will not be transferred over when the Menu Mode Setting is changed to “TEXT”).

### Transmitting in the Beacon Mode

It is possible to automatically transmit a “Beacon” message repetitively. The message may be input either with the keyer paddle, or programmed using the MENU “TEXT” input method. The time delay between message repeats may be set anywhere between 1 ~ 690 seconds (1 ~ 240 seconds (1 sec/step) or 270 ~ 690 seconds (30 sec/step)) via Menu item “022 KEY BEACON”. If you do not wish the “Beacon” message to repeat, then, set this Menu item to “OFF”. Press a [1] ~ [5] key on the FH-2 Remote Control Keypad, to select the register into which the Beacon message was stored. Repetitive transmissions of the Beacon message will begin. Press one of these keys once more to halt the Beacon transmissions.

# CW CONVENIENCE FEATURES

## CONTEST MEMORY KEYS

### TEXT Memory

The four channels of CW message memory (up to 50 characters total) may also be programmed using the text-entry technique. This is somewhat slower than sending the message directly from your keyer paddle, but accuracy of character spacing is ensured. **Example 1:** CQ CQ CQ DE W6DXC K} (20 characters)

You may also utilize another powerful feature of the CW Memory Keyer, the sequential Contest Number (“Countup”) feature. **Example 2:** 599 10 200 # K} (15 characters)

### STORING TEXT INTO MEMORY

1. Press the [MENU] button briefly, to enter the Menu mode.
2. Rotate the (VFO-A)[SELECT] knob to select the CW Memory Register you wish to store the message in. For now, you are just selecting the message entry technique (Text entry).  
**025 KEY CW MEM1**  
**026 KEY CW MEM2**  
**027 KEY CW MEM3**  
**028 KEY CW MEM4**  
**029 KEY CW MEM5**
3. Rotate the (VFO-B)[SELECT] knob to set the selected Memory Register to “TEXT”. If you want to use the Text method for message entry on all memories, set all five Menu items (#025 ~ 029) to “TEXT”.
4. Press and hold in the [MENU] button for two seconds to save the new settings and exit.

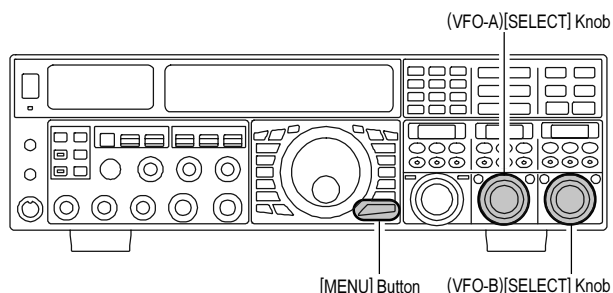

### TEXT MESSAGE PROGRAMMING

1. Set the operating mode to CW.
2. Set the [BK-IN] button to “off”.
3. Turn the internal Electronic Keyer “on” by briefly pressing the [KEYER] button.
4. Press the FH-2’s [MEM] key.

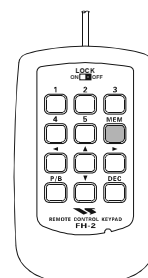

5. Press the [1] ~ [5] key on the FH-2 to begin the memory storage process.

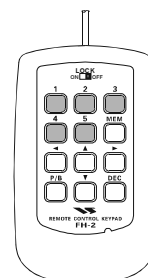

6. Use the FH-2’s [◀] and [▶] keys to set the cursor position and use the [▲] and [▼] keys to choose the letter/number to be programmed in each slot of the memory. In the case of the second example above, the “#” character designates the slot where the Contest Number will appear.

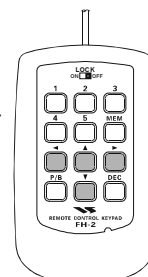

#### ADVICE:

You may set the cursor position with the (VFO-A)[SELECT] knob, and then choose the letter/number with the (VFO-B)[SELECT] knob.

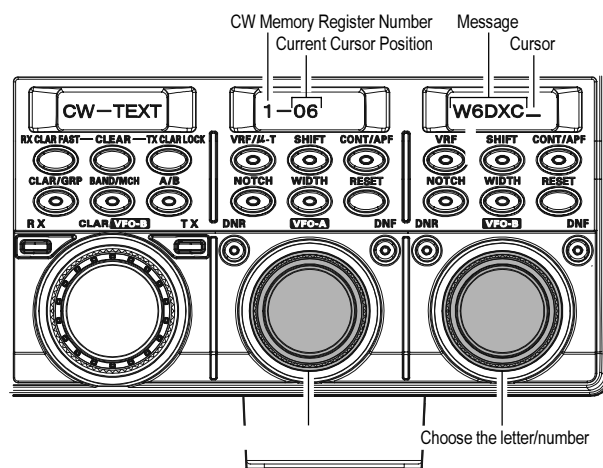

# CW CONVENIENCE FEATURES

## CONTEST MEMORY KEYS

- When the message is complete, add the “}” character at the end to signify the termination of the message.
- Press and hold in the **FH-2 [MEM]** key for 2 seconds to exit, once all characters (including “}”) have been programmed.

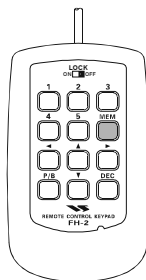

TEXT	CW CODE	TEXT	CW CODE	TEXT	CW CODE	TEXT	CW CODE
!	SN	(	KN	/	DN	@	@
”	AF	)	KK	:	OS	[	—
#	—	*	—	;	KR	\	AL
\$	SX	+	AR	=	—	]	—
%	KA	,	MIM	<	BT	^	—
&	AS	—	DU	>	—	—	IQ
'	WG	.	AAA	?	IMI	}	—

### CHECKING THE CW MEMORY CONTENTS

- Be sure that Break-in is still turned “off” by the **[BK-IN]** button.
- Press the **[MONI]** button briefly, to enable the CW monitor.
- Press an **FH-2 [1] ~ [5]** key to check your work. You will hear the stored message with the CW monitor sidetone, but no RF energy will be transmitted.

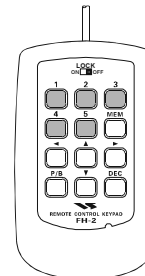

### NOTE:

Adjust the monitor level using the **[MONI]** knob.

### ON-THE-AIR CW MESSAGE PLAYBACK

- Press the **[BK-IN]** button briefly to enable transmission. Either Full- or Semi-break-in will be engaged depending on the setting of Menu item “063 A1A BK-IN.”
- Press the **FH-2’s [1] ~ [5]** key to transmit the programmed message.

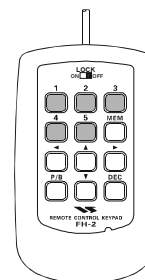

### NOTE:

If you subsequently decide to use the “Message Memory” technique for message storage, on a particular memory register, the contents of the message stored using text input will not be transferred over when you select the “Message Memory” technique (the Menu Mode Setting is set to “MESSAGE”).

### Contest Number Programming

Use this process if you are starting a contest, or if you somehow get out of sync with the proper number in the middle of a contest.

- Press the **[MENU]** button briefly, to enter the Menu mode.
- Rotate the **(VFO-A)[SELECT]** knob to select Menu item “024 KEY CONTEST”.
- Rotate the **(VFO-B)[SELECT]** knob to set the Contest Number to the desired value.

#### ADVICE:

Press the **[CLEAR]** button briefly (located above the **[CLAR(VFO-B)]** knob), to reset the Contest Number to “1”.

- Press and hold in the **[MENU]** button for two seconds to store the new number and exit to normal operation.

### Decrementing the Contest Number

Use this process if the current contest number gets ahead of the actual number you want to send (in case of a duplicate QSO, for example).

Press the **FH-2 control’s [DEC]** key. The current Contest Number will be reduced by one. Press the **[DEC]** button briefly, as many times as necessary, to reach the desired number. If you go too far, use the “Contest Number Programming” technique desired at the left.

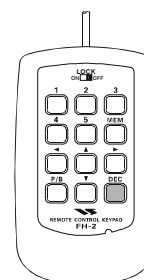

# FM MODE OPERATION

## BASIC OPERATION

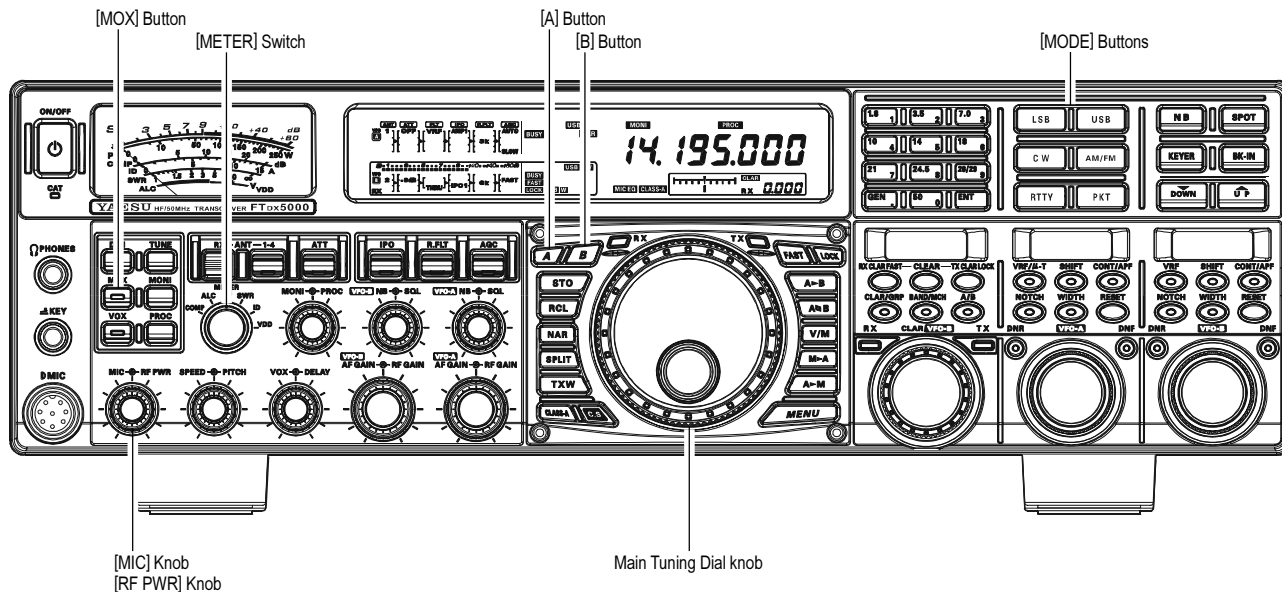

1. To select the FM operating mode, press the [AM/FM] button several times, until the “FM” icon appears in the display, .

### ADVICE:

- The operating mode is

selected using the [MODE] button, and then pressing the [A] or [B] button (located to the upper left of the Main Tuning Dial knob), to choose VFO-A or VFO-B, to which the selection is applied. Usually, the [A] button glows red, signifying VFO-A is being adjusted. Similarly, pressing the [B] button will cause its indicator to glow orange, signifying VFO-B adjustment. Therefore, press the [A] or [B] button to select the desired VFO, then press the [AM/FM] button to select the FM mode.

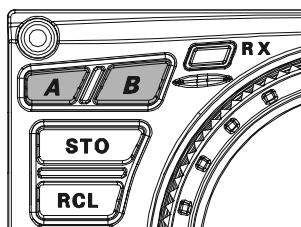
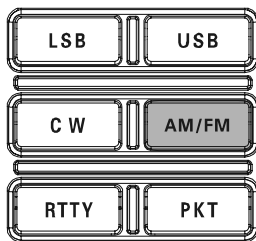

2. Rotate the Main Tuning Dial knob (in the case of VFO-A operation) to tune the desired operating frequency. Pressing the microphone [UP] or [DWN] button will cause the frequency to change in 5 kHz steps.
3. Press the microphone PTT switch (or press the front panel [MOX] button) to transmit. Speak into the microphone in a normal voice level. Release the PTT or [MOX] switch to return to receive.

4. There are two methods of adjusting the microphone gain for FM operation. At the factory, a default level has been programmed that should be satisfactory for most situations. However, using Menu item “079 F3E MICGAIN”, you may set a different fixed value, or you may choose the “MCVR” option which then lets you use the front panel [MIC] knob to set the microphone gain in the FM mode.

### ADVICE:

- The Transmit Monitor is another helpful way of verifying proper adjustment of the FM MIC Gain. By pressing the [MONI] button, and then adjusting the [MONI] knob for a comfortable listening level while you are transmitting, you will be able to hear the difference in deviation as you make adjustments.
- FM is only used in the 28 MHz and 50 MHz Amateur bands covered in the FTDX5000. Please do not use FM on any other bands.



## REPEATER OPERATION

The **FTDX5000** may be utilized on 29 MHz and 50 MHz repeaters.

1. Rotate the Main Tuning Dial knob to the output frequency (downlink) from the repeater.
2. If CTCSS Tone operation is desired/needed, press and hold in the **[AM/FM]** button for two seconds to engage the CTCSS mode.
3. Within 5 seconds of pressing of the **[AM/FM]** button:
  - Rotate the **(VFO-A)[SELECT]** knob to select the desired CTCSS mode. If you just need to send the uplink encoding tone, select "T.ENC". For encode/decode operation, choose "T.SQL" instead. The available choices are "OFF" → "T.ENC" → "T.SQL" → "OFF".
  - Rotate the **(VFO-B)[SELECT]** knob to select the desired CTCSS Tone to be used. A total of 50 standard CTCSS tones are provided (see the CTCSS Tone Chart).
  - Press the **[AM/FM]** button briefly, to select the desired repeater shift direction. The selections are "RPT SIMP (not used on a repeater)" → "RPT +" → "RPT -" → "RPT SIMP (not used on a repeater)".
4. Press and hold in the **[AM/FM]** button for two seconds to exit from the repeater setup mode.
5. Close the microphone **PTT** switch (or press the **[MOX]** button) to begin transmission. You will observe that the frequency has shifted to correspond with the programming you set up in the previous steps. Speak into the microphone in a normal voice level, and then release the **PTT** switch or **[MOX]** button to return to the receive mode.

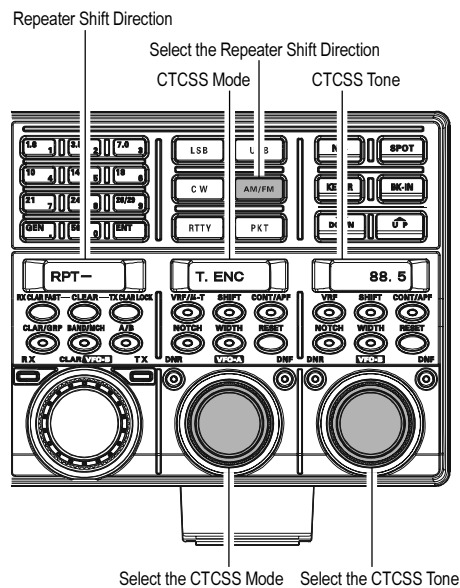

CTCSS TONE FREQUENCY (Hz)							
67.0	69.3	71.9	74.4	77.0	79.7	82.5	85.4
88.5	91.5	94.8	97.4	100.0	103.5	107.2	110.9
114.8	118.8	123.0	127.3	131.8	136.5	141.3	146.2
151.4	156.7	159.8	162.2	165.5	167.9	171.3	173.8
177.3	179.9	183.5	186.2	189.9	192.8	196.6	199.5
203.5	206.5	210.7	218.1	225.7	229.1	233.6	241.8
250.3	251.4	-	-	-	-	-	-

### ADVICE:

The conventional repeater shift used on 29 MHz is 100 kHz, while on the 50 MHz band the shift may vary between 500 kHz and 1.7 MHz (or more). To program the proper repeater shift, use Menu items "081 F3E 28 RPT" (28 MHz) and "082 F3E 50 RPT" (50 MHz), as appropriate.

# MEMORY OPERATION

---

---

## CONVENIENT MEMORY FUNCTIONS

---

---

The **FTdx5000** contains ninety-nine regular memories, labeled “01” through “99”; nine specially programmed limit memory pairs, labeled “P1L/P1U” through “P9L/P9U”; and five QMB (Quick Memory Bank) memories, labeled “C-1” through “C-5”. Each memory location not only stores the VFO-A frequency and mode, but also stores the various settings shown below. By default the 99 regular memories are contained in one group. However, they can be arranged in up to six separate groups, if desired.

### QUICK POINT:

The **FTdx5000**'s memory channels store the following data (in addition to the operating frequency):

- Frequency
- Mode
- Clarifier status and its Offset Frequency
- ANT status
- ATT status
- IPO status
- VRF status
- Roofing filter status and its Bandwidth
- Noise Blanker status
- CONTOUR status and its Peak Frequency
- DSP Noise Reduction (DNR) status and its Reduction algorithm selection.
- DSP Notch filter (NOTCH) status
- NAR bandwidth status
- DSP Auto Notch filter (DNF) status
- Repeater Shift Direction and CTCSS Tone Frequency

### IMPOTANT NOTE

On rare occasions the stored data may become corrupted by miss operation, or static electricity. When repairs are made, the memory data may be lost. Please write down or record the memory information so you will be able to restore it if needed.

## QMB (QUICK MEMORY BANK)

The Quick Memory Bank consists of five memories (labeled “C-1” through “C-5.”) independent from the regular and PMS memories. These can quickly store operating parameters for later recall.

### QMB Channel Storage

1. Tune to the desired frequency on VFO-A.
2. Press the blue **[STO]** button briefly. The “beep” will confirm that the contents of VFO-A have been written to the currently available QMB memory.
3. If you repeatedly press the **[STO]** button, the QMB memories will be written in the following order:  
C-2 → C-3 → C-4 → C-5 → C-1 .....

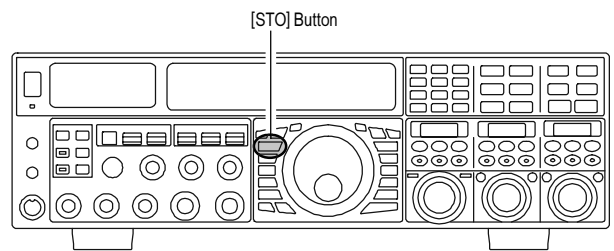

Once all five QMB memories have data in them, previous data (starting with channel “C-1”) will be over-written, on a first-in, first-out basis.

### QMB Channel Recall

1. Press the blue **[RCL]** button briefly. The current QMB channel data will be shown on the VFO-A frequency display field, and the QMB memory channel number will appear in the small window at the lower right corner of the display.
2. Repeatedly pressing the **[RCL]** button will rotate through the QMB channels:  
C-2 → C-3 → C-4 → C-5 → C-1 .....
3. Press the **[V/M]** button briefly, to return to the VFO or Memory mode.

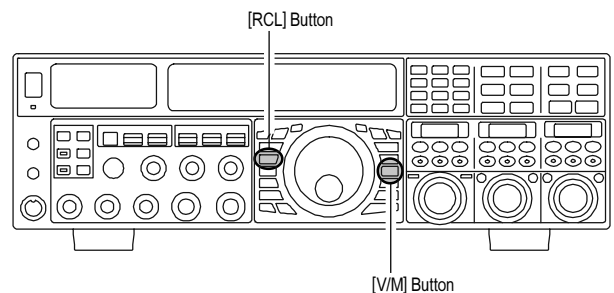

### ADVICE:

Rotating the Main Tuning Dial knob, or changing the operating mode will place the transceiver in the “Memory Tune” mode. This is a temporary “pseudo-VFO” method of tuning off of a stored memory channel. If you do not over-write the contents of the current memory channel, the original contents will not be disturbed by the initiation of Memory Tune operation.

# MEMORY OPERATION

## REGULAR MEMORY OPERATION

The Regular Memory of the **FTDX5000** allows storage and recall of up to 99 memories, each storing frequency, mode, and a wide variety of status information detailed previously. Memories may be grouped into as many as six Memory Groups. Additionally, you get nine pairs of band-limit (PMS) memories, and five QMB (Quick Memory Bank) memories.

### Memory Storage

1. Set VFO-A up with frequency, mode, and status information, the way you want to have it stored.
2. Press the **[A►M]** button briefly (the current channel number will start blinking in the small window at the lower right corner of the display), and the contents of the current memory channel will be shown on the **SUB DISPLAY-I**.
3. Rotate the **[CLAR(VFO-B)]** knob to select the memory channel onto which you wish to store the data. If you have selected a channel in which data is already stored, that frequency will appear on the **SUB DISPLAY-I** window.
4. Press and hold in the **[A►M]** button for two seconds to store the frequency and other data into the selected memory channel. A double beep will confirm that you have held the **[A►M]** button in long enough.

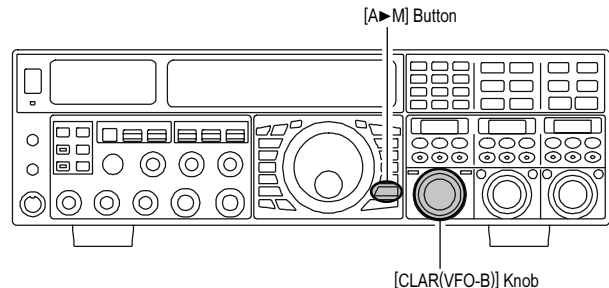

### Memory Channel Recall

1. Press the **[V/M]** button briefly, if necessary, to enter the Memory mode. The memory channel data will be shown on the VFO-A frequency display field, and the "**MR**" icon and memory channel number will appear in the small window at the lower right corner of the display.
2. Press and hold the **[BAND/MCH]** button for two seconds. The **[BAND/MCH]** button glows yellow, indicating that you are ready to select a memory channel using the **[CLAR(VFO-B)]** knob.
3. After pressing the **[BAND/MCH]** button, you may rotate the **[CLAR(VFO-B)]** knob to select the desired memory channel.

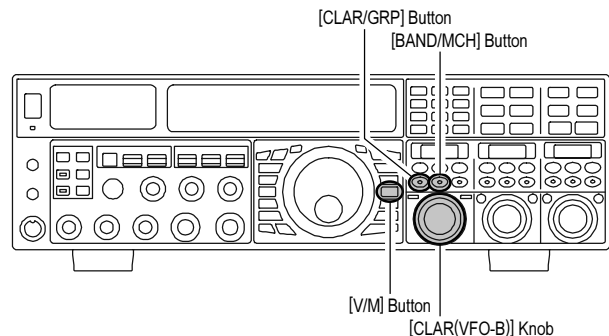

### ADVICE:

To work within a particular Memory Group (described on page 105), press and hold the **[CLAR/GRP]** button for two seconds (the button will glow yellow), then rotate the **[CLAR(VFO-B)]** knob to select the desired Memory Group. Now press and hold the **[BAND/MCH]** button for two seconds (the **[BAND/MCH]** button will glow yellow). You may now choose the memory channel within the selected Memory Group.

## REGULAR MEMORY OPERATION

### Checking a Memory Channel's Status

Before programming a channel into memory, you can check the current contents of that channel without the danger of overwriting the channel accidentally.

1. Press the **[A▶M]** button briefly.  
The data stored in the currently-selected memory channel will be displayed in the **SUB DISPLAY-I** window. However, since you are only checking the contents of the memory channel, your radio will not have moved to the memory channel's frequency.
2. Rotate the **[CLAR(VFO-B)]** knob to select a different memory channel. To exit from the Memory Check mode, press the **[A▶M]** button briefly, once more.

#### ADVICE:

- While the Memory Check function is engaged, the memory channel number will blink in the multi-panel window.
- While operating in the VFO mode, using Memory Check, you may store the current contents of the VFO-A register into the selected memory by pressing and holding in the **[A▶M]** button for two seconds (listen for the double beep). Conversely, if you wish to write the contents of the current memory into the VFO-A register, press and hold in the **[M▶A]** button for two seconds.

### Erasing Memory Channel Data

1. Press the **[A▶M]** button briefly.  
The data stored in the currently-selected memory channel will be displayed in the **SUB DISPLAY-I** window.
2. Rotate the **[CLAR(VFO-B)]** knob to select the memory channel that you would like to erase.
3. Press the **[LOCK]** button briefly, to erase the contents of the selected memory channel.

#### ADVICE:

- After erasure, only the memory channel number will remain. The frequency data will disappear from the display.
- If you make a mistake and wish to restore the memory contents, just repeat steps (1) through (3) above.

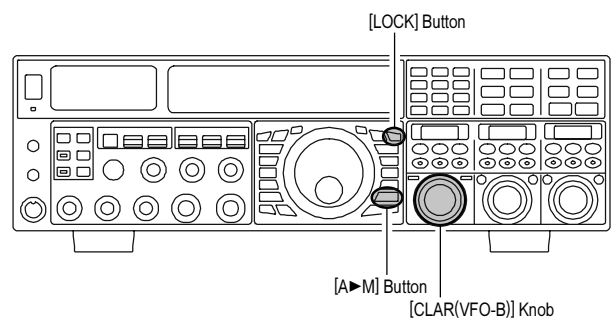
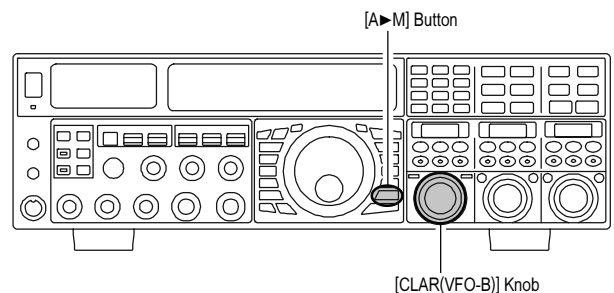

# MEMORY OPERATION

## REGULAR MEMORY OPERATION

### Moving Memory Data to the VFO-A

You may transfer the contents of the currently selected memory channel into the Main band (VFO-A) register, if you like.

1. Press the **[V/M]** button briefly, as necessary, to enter the Memory mode. The memory channel number will appear in the small window at the lower right corner of the display.
2. Press and hold the **[BAND/MCH]** button for two seconds. The **[BAND/MCH]** button will glow yellow, indicating that you are ready to select a memory channel using the **[CLAR(VFO-B)]** knob.
3. Rotate the **[CLAR(VFO-B)]** knob to select the memory channel you wish to transfer to VFO-A.
4. Press and hold in the **[M▶A]** button for two seconds, until you hear the double beep. The data in the selected memory channel will now be transferred to the VFO-A.

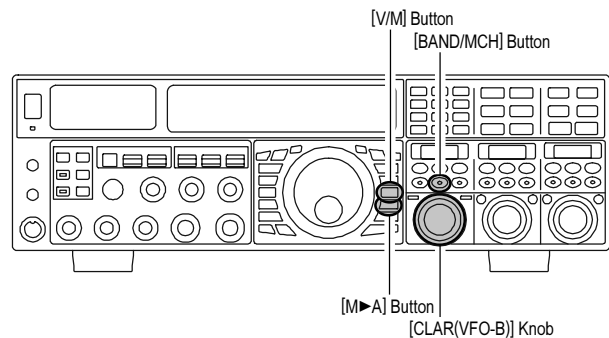

#### ADVICE:

The transfer of data to the VFO-A does not affect the original contents of the memory channel. This is a “copy” function that leaves the memory contents unchanged.

### Memory Tune Operation

You may freely tune the frequency off of any memory channel in a “Memory Tune” mode. This is similar to VFO operation. So long as you do not over-write the contents of the current memory, Memory Tune operation will not alter the contents of the memory channel.

1. Press the **[V/M]** button briefly, to recall any memory channel.
2. Rotate the Main Tuning Dial knob and you will see that the memory channel frequency is changing.

#### ADVICE:

- The “**MT**” icon will replace the “**MR**” icon in the small window at the lower right corner of the display, indicating you are in the “Memory Tune” mode.
  - During Memory Tune operation, you may change operating modes, and engage the Clarifier, if desired.
3. Press the **[V/M]** button briefly to return to the originally-memorized frequency of the current memory channel. One more brief press of the **[V/M]** button will return you to VFO operation.

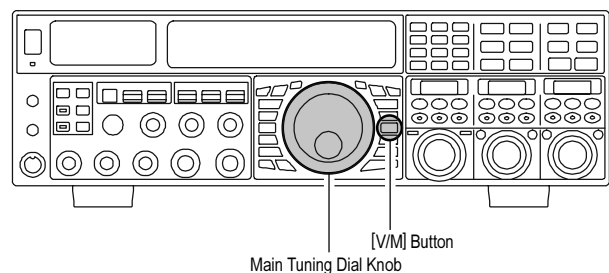

#### NOTE:

Computer software programs utilizing the CAT system interface port may presume that the transceiver is operating in the VFO mode for certain features like “band mapping” and/or frequency logging. Because the “Memory Tune” mode so closely resembles the VFO mode, be sure that you have the **FTDX5000** operating in a control mode compatible with your software requirements. Use the VFO mode if you’re not sure.

## MEMORY GROUPS

Memory channels may be grouped into as many as six convenient batches, for easy identification and selection. For example, you might want to set aside memory groups for AM BC stations, shortwave broadcast stations, contest frequencies, repeater frequencies, and PMS limits, or any other groupings you like.

Each memory group is capable of holding up to 19 or 20 memory channels (the Group size is fixed). When a memory channel is grouped, the channel numbers change to correspond to the chart below:

### Memory Group Assignment

1. Press the [MENU] button briefly, to enter the Menu mode.
2. Rotate the (VFO-A)[SELECT] knob to select Menu item "032 GENE MEM GRP".
3. Rotate the (VFO-B)[SELECT] knob to set this Menu item to "ENABLE" (the default setting is "DISABLE").
4. Press and hold in the [MENU] button for two seconds to save the new setting and exit. Operation will now be restricted to the six Memory Groups.

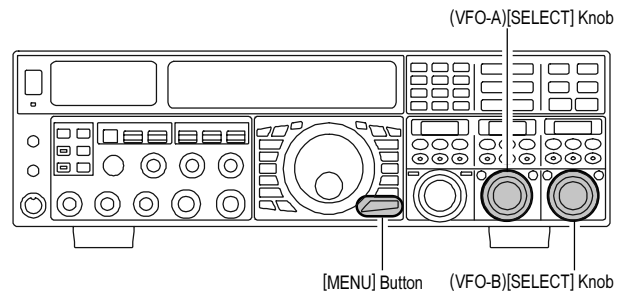

To cancel Memory Group operation, repeat steps (1) through (4) above, choosing "DISABLE" in step (3).

#### ADVICE

Note that for the PMS memory group, the PMS memories "P1L" through "P9U" will be so designated, to avoid confusion.

MEMORY CHANNEL NUMBER	
GROUP MEMORY "OFF"	GROUP MEMORY "ON"
01 ~ 19	1-01 ~ 1-19
20 ~ 39	2-01 ~ 2-20
40 ~ 59	3-01 ~ 3-20
60 ~ 79	4-01 ~ 4-20
80 ~ 99	5-01 ~ 5-20
P-1L/1U ~ P-9L/9U	P-1L/1U ~ P-9L/9U

### Choosing the Desired Memory Group

You may recall memories just within a particular Memory Group, if desired.

1. Press the [V/M] button briefly, if necessary to enter the Memory mode.
2. Press and hold the [CLAR/GRP] button for two seconds. The [CLAR/GRP] button will glow yellow.
3. Rotate the [CLAR(VFO-B)] knob to select the desired Memory Group.
4. Press and hold the [BAND/MCH] button. The [BAND/MCH] button will glow yellow.
5. Rotate the [CLAR(VFO-B)] knob to select the desired Memory Channel within the Selected Memory Group.

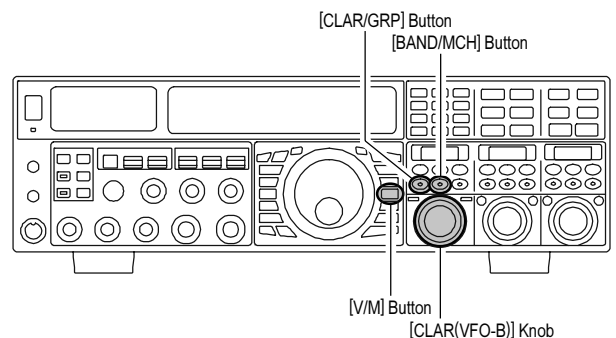

#### ADVICE:

If no channels have been assigned to a particular Memory Group, you will not have access to that Group.

# OPERATION ON ALASKA EMERGENCY FREQUENCY: 5167.5 KHz (U.S. VERSION ONLY)

Section 97.401(d) of the regulations governing amateur radio in the United States permits emergency amateur communications on the spot frequency of 5167.5 kHz by stations in (or within 92.6 km of) the state of Alaska. This frequency is only to be used when the immediate safety of human life and/or property are threatened. It is never to be used for routine communications.

The **FTdx5000** includes the capability for transmission and reception on 5167.5 kHz under such emergency conditions via the Menu system. To activate this feature:

1. Press the **[MENU]** button to briefly, enter the Menu mode.
2. Rotate the **(VFO-A)[SELECT]** knob to select “**176 TGEN EMRGNCY**”.
3. Rotate the **(VFO-B)[SELECT]** knob to select “**ENABLE**”.
4. Press and hold in the **[MENU]** button for 2 seconds to save the new setting and exit to normal operation. Emergency communication on this spot frequency is now possible.
5. Press the **[V/M]** button, as necessary, to enter the Memory mode. Press and hold the **[BAND/MCH]** button (the imbedded LED glows yellow), then rotate the **[CLAR(VFO-B)]** knob to select the emergency channel (“**E-US**”), which is found between channels “**P-9U**” and “**01.**”

## NOTE:

- ❑ The receive-mode CLARIFIER functions normally while using this frequency, but variation of the transmit frequency is not possible. Activation of “**176 TGEN EMRGNCY**” does not enable any other out-of-amateur-band capability on the transceiver. The full specifications of the **FTdx5000** are not necessarily guaranteed on this frequency. However, power output and receiver sensitivity should be fully satisfactory for the purpose of emergency communication.
- ❑ If you wish to disable operation capability on the Alaska Emergency Frequency, repeat the above procedures, but set “**176 TGEN EMRGNCY**” to “**DISABLE**” in step 3.
- ❑ In an emergency, note that a half-wave dipole cut for this frequency should be approximately 45’3” on each leg (90’6” total length). Emergency operation on 5167.5 kHz is shared with the Alaska-Fixed Service. This transceiver is not authorized for operation under the FCC’s Part 87 rules for aeronautical communications.

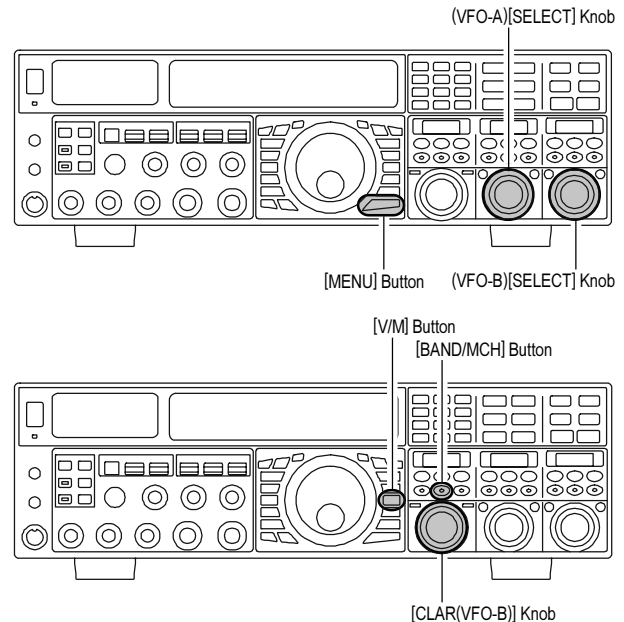



# VFO AND MEMORY SCANNING

You may scan either the VFO or the memories of the **FTDx5000**. The radio will halt scanning on any station with a signal strong enough to open the receiver squelch.

## VFO SCANNING

1. Set the VFO to the frequency on which you would like to begin scanning.
2. Rotate the **(VFO-A)[SQL]** knob so that the background noise is just silenced.

**ADVICE:**

If you would like to scan on VFO-B, rotate the **(VFO-B)[SQL]** knob so that the background noise is just silenced.

3. Press and hold in the microphone **[UP]** or **[DWN]** key for 1/2 second to start scanning in the specified direction on the VFO-A.

**ADVICE:**

If you would like to begin scanning on the VFO-B, press the **[B]** button briefly, first (located to the upper left of the Main Tuning Dial knob), then press and hold in the microphone **[UP]** or **[DWN]** key for 1/2 second.

4. The scanner will now increment the frequency in the chosen direction until a signal is detected. When a signal is encountered which opens the squelch, receiver will respond differently, depending on the operating mode:

- In the SSB/CW modes**, the decimal points in the frequency display area will blink and the scanner will slow down (but does not stop).
- In the FM/AM modes**, the transceiver pauses on the signal and stays locked on its frequency for five seconds. Thereafter, scanning will resume whether or not the other station's transmission has ended. While the transceiver is in the "pause" condition, the decimal points in the frequency display area will blink. If the incoming signal disappears, scanning will resume.

5. To cancel scanning, press the microphone **[UP]** or **[DWN]** key briefly.

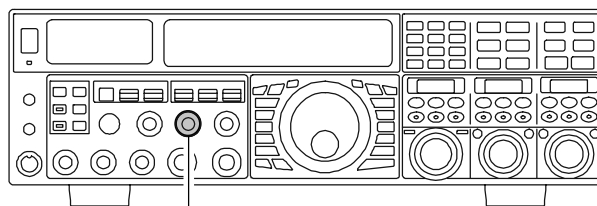

(VFO-B)[PICTH] Knob

### MAIN BAND (VFO-A) SCANNING

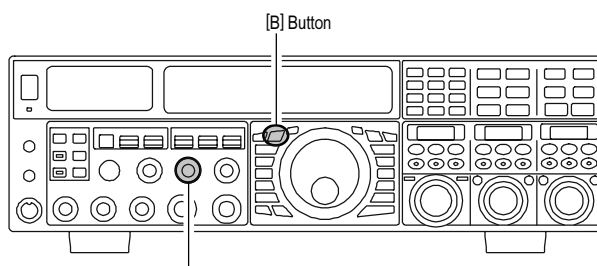

[B] Button

(VFO-B)[PICTH] Knob

### SUB BAND (VFO-B) SCANNING

**ADVICE:**

You may select the manner in which the scanner resumes while it has paused on a signal in the FM/AM modes, using Menu item "**045 GENE SCN RSM**". The default "TIME" setting will cause the scanner to resume scanning after five seconds; you may change it, however, to resume only after the carrier has dropped out, if you like See page 125.

**QUICK POINT:**

If you have no interest in scanning, and wish to prohibit the microphone's **[UP]**/**[DWN]** keys from initiating scanning, you may disable scanning control from the microphone using Menu item "**044 GENE MIC SCN**" (set it to "DISABLE").

# VFO AND MEMORY SCANNING

## MEMORY SCAN

1. Set the transceiver up in the memory mode by pressing the [V/M] button briefly, if necessary.
2. Rotate the (VFO-A)[SQL] knob so that the background noise is just silenced.
3. Press and hold in the microphone's [UP] or [DWN] key for 1/2 second to start scanning in the specified direction.
4. The scanner will now cause the transceiver to increment in the chosen direction until a signal is detected. When a signal is encountered which opens the squelch, the transceiver pauses on the signal and stays locked on its frequency for five seconds. Thereafter, scanning will resume whether or not the other station's transmission has ended. While the transceiver is in the "pause" condition, the decimal points in the frequency display area will blink.
5. If the incoming signal disappears, scanning will resume.
6. To cancel the scanning, press the microphone's [UP] or [DWN] key briefly.

### ADVICE:

- During Memory Group operation, only the channels within the current Memory Group will be scanned.
- If the scan has paused on a signal, pressing the microphone's [UP] or [DWN] key will cause scanning to resume instantly.
- If you press the microphone's PTT switch during scanning, the scanner will halt at once. Pressing the PTT switch during scanning will not cause transmission, however.
- You may select the manner in which the scanner resumes while it has paused on a signal, using Menu item "045 GENE SCN RSM". The default "TIME" setting will cause the scanner to resume scanning after five seconds; you may change it, however, to resume only after the carrier has dropped out, if you like See page 125.

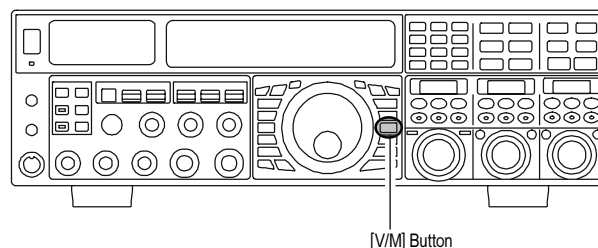

### QUICK POINT:

If you have no interest in scanning, and wish to prohibit the microphone's [UP]/[DWN] keys from initiating scanning, you may disable scanning control from the microphone using Menu item "044 GENE MIC SCN" (set it to "DISABLE").

# PMS (PROGRAMMABLE MEMORY SCANNING)

To limit scanning (and manual tuning) within a particular frequency range, you can use the Programmable Memory Scanning (PMS) feature, which utilizes nine special-purpose memory pairs (“P1L/P1U” through “P9L/P9U”). The PMS feature is especially useful in helping you to observe any operating sub-band limits which apply to your Amateur license class.

1. Store the Lower and Upper tuning/scanning limit frequencies into the memory pair “P1L” and “P1U,” respectively, or any other “L/U” pair of memories in the special PMS memory area. See page 102 for details regarding memory storage.
2. Press the [V/M] button briefly, to enter the Memory mode.
3. Press and hold the [BAND/MCH] button for two seconds. The [BAND/MCH] button will glow yellow, indicating that you may select a memory channel using the [CLAR(VFO-B)] knob.
4. Rotate the [CLAR(VFO-B)] knob to select memory channel “P1L” or “P1U.”
5. Rotate the (VFO-A)[SQL] knob so that the background noise is just silenced.
6. Turn the Main Tuning Dial knob slightly (to activate memory tuning). Tuning and scanning are now limited to the range within the P1L/P1U limits until you press the [V/M] button briefly, to return to memory channel or VFO-A operation.
7. Press and hold in the microphone’s [UP] or [DWN] key for 1/2 second to start scanning in the specified direction.
8. The scanner will now cause the transceiver to increment in the chosen direction until a signal is detected. When a signal is encountered which opens the squelch, it will do different things, depending on the operating mode:
  - In the SSB/CW modes**, the decimal points in the frequency display area will blink and the scanner will slow down (but does not stop).
  - In the FM/AM modes**, the transceiver pauses on the signal and stays locked on its frequency for five seconds. Thereafter, scanning will resume whether or not the other station’s transmission has ended. While the transceiver is in the “pause” condition, the decimal points in the frequency display area will blink. If the incoming signal disappears, scanning will resume.
9. If you rotate the Main Tuning Dial knob in the opposite direction from the current scanning direction (in other words, you rotate the dial to the left when scanning toward a higher frequency), the direction of the scan will reverse.
10. If you press the microphone PTT switch during scanning, the scanner will halt at once. Pressing the PTT switch during scanning will not cause transmission, however.

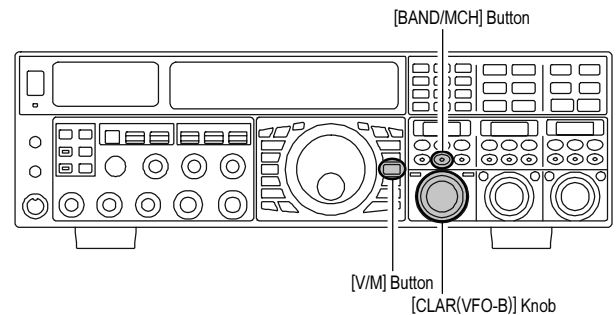

# PACKET OPERATION

Packet operation is easily accomplished on the **FTdx5000** by connecting your TNC (Terminal Node Controller) to the transceiver, as in the illustration. “Packet” operation also applies to SSB-based AFSK data modes, such as PSK31, etc.

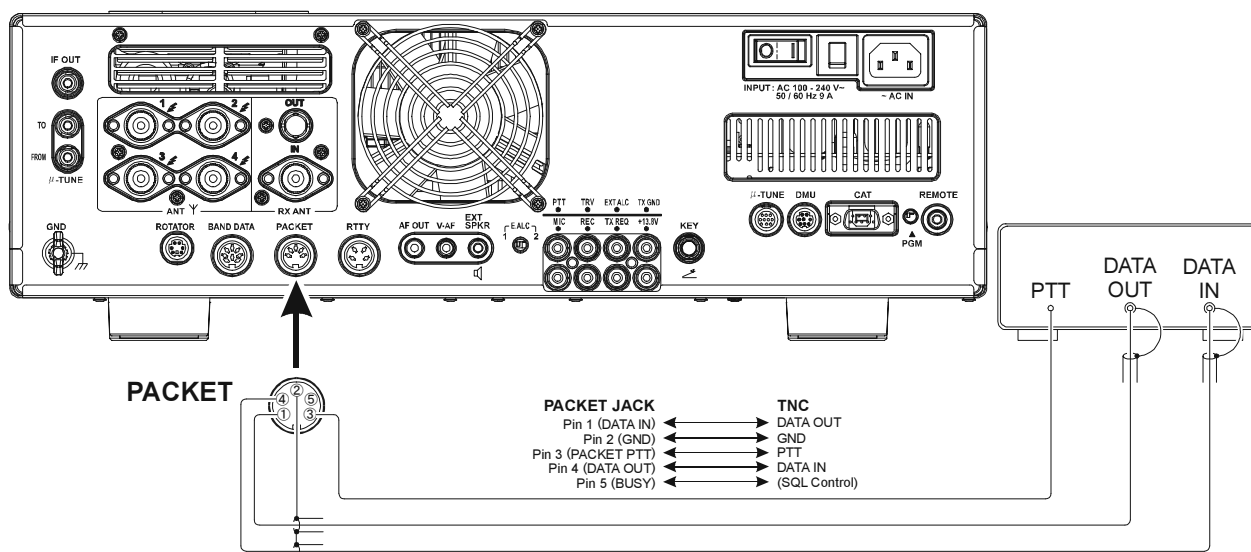

## PACKET SETUP (INCLUDING SUBCARRIER FREQUENCY)

Before operation can commence, some basic setup procedures must be performed, using the Menu, to configure your radio for the desired data mode.

MENU ITEM	AVAILABLE VALUES	MENU ITEM	AVAILABLE VALUES
069 DATA DATA IN	DATA or PC	083 PKT LCUT FRQ	OFF/100 ~ 1000 Hz
070 DATA DT GAIN	0 ~ 100	084 PKT LCUT SLP	18dB/oct or 6dB/oct
071 DATA DT OUT	VFO-A or VFO-B	085 PKT HCUT FRQ	OFF/700 ~ 4000 Hz
072 DATA OUT LVL	0 ~ 100	086 PKT HCUT SLP	18dB/oct or 6dB/oct
073 DATA VOX DLY	30 ~ 3000 ms	087 PKT PKT DISP	-3000 ~ +3000 Hz
074 DATA VOX GAIN	0 ~ 100	088 PKT PKT SFT	-3000 ~ +3000 Hz

## BASIC SETUP

1. Press the **[PKT]** button.

### ADVICE:

- For HF operation, SSB-based data operation is generally used. One brief press of the **[PKT]** button will engage packet operation in the “LSB” mode (by default). Both the “**PKT**” and “**LSB**” icons will appear in the display.
  - To operate FM-based 1200-baud packet on the 29/50 MHz bands, press the **[PKT]** button repeatedly to illuminate the “**PKT**” and “**FM**” icons, to engage the “PKT-FM” mode.
  - To engaged Packet operation in the “USB” mode, repeat pressing the **[PKT]** button until both the “**PKT**” and “**USB**” icons are appear.
2. When the “transmit” command is received from the TNC, the **FTdx5000** transmitter will automatically be engaged. Likewise, the command to return to receive will cause the radio to revert to the receive mode.

### ADVICE:

- If you need to adjust the output level from the “DATA OUT” pin of the **PACKET** jack (pin 4) on the radio, use Menu item “**072 DATA OUT LVL**”. For the input level from the TNC, as applied to the DATA IN pin of the **PACKET** jack (pin 1), use Menu item “**070 DATA DT GAIN**”.
- During Packet operation via the rear panel **PACKET** jack, the front panel **MIC** jack is cut off, so you won’t have a “live microphone” problem during data operation.

### NOTE:

If you anticipate making data transmissions of longer than a few minutes, we recommend that you use the **[RF PWR]** knob to reduce the transmitter power to 1/3 ~ 1/2 of its normal maximum.

### QUICK POINT:

#### PACKET Jack Specifications

- DATA IN (Pin 1)
  - Input Level: 50 mVp-p
  - Input Impedance: 10 k-Ohms
- DATA OUT (Pin 4)
  - Output Level: 100 mVp-p max.
  - Output Impedance: 10 k-Ohms

# RTTY (RADIO TELETYPE) OPERATION

Most RTTY operation today is accomplished using a TNC or other computer-based system that utilizes AFSK tones. As such, the previous discussion on LSB-mode “Packet” operation will also apply for Baudot operation. RTTY operation using a Terminal Unit (TU), or the “FSK” output from a TNC is discussed below. Also, see the illustration for details regarding connection to your TU.

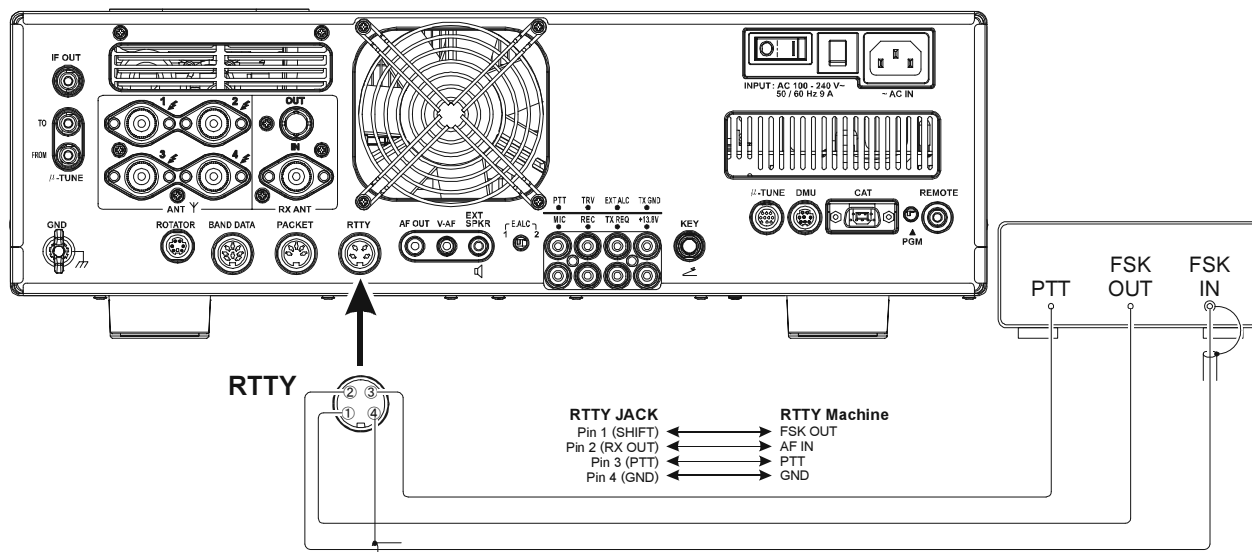

## SETTING UP FOR RTTY OPERATION

Before commencing RTTY operation, please direct your attention to the setup steps shown in the chart to the right.

MENU ITEM	AVAILABLE VALUES	MENU ITEM	AVAILABLE VALUES
089 RTTY LCUT FRQ	OFF/100 ~ 1000 Hz	094 RTTY T PLRTY	NOR or REV
090 RTTY LCUT SLP	18dB/oct or 6dB/oct	095 RTTY RTTY OUT	VFO-A or VFO-B
091 RTTY HCUT FRQ	OFF/700 ~ 4000 Hz	096 RTTY OUT LEVEL	0 ~ 100
092 RTTY HCUT SLP	18dB/oct or 6dB/oct	097 RTTY SHIFT	170/200/425/850 Hz
093 RTTY R PLRTY	NOR or REV	098 RTTY TONE	1275/2125 Hz

## BASIC SETUP

- Press the [RTTY] button briefly, to enter the RTTY mode.  
One press of the [RTTY] button will engage RTTY operation using “LSB” injection, which is generally used in the Amateur service. In this mode, both the “RTTY” and “LSB” icons will appear in the display.  
To switch to USB-side injection in RTTY, press the [RTTY] button once more. Both the “RTTY” and “USB” icons appear. Repeatedly pressing the [RTTY] button will toggle between LSB and USB injection on RTTY.
- When you begin typing on your TU or computer keyboard, the command to transmit should automatically be sent to the transceiver, causing it to enter the transmit mode.

### NOTE:

If you anticipate making data transmissions of longer than a few minutes, we recommend that you use the [RF PWR] knob to reduce the transmitter power to 1/2 ~ 1/3 of its normal maximum.

### ADVICE:

- The Mark/Space Shift utilized in most Amateur RTTY operation is 170 Hz. Other shifts may be configured using Menu item “097 RTTY SHIFT”.  
The FTdx5000 is set up for “high tone” operation (centered on 2125 Hz) by default, but you may configure it for low tone (1275 Hz) operation using Menu item “074 RTTY TONE”.
- You may find that you are unable to decode some RTTY stations, even if they are of sufficient signal strength. If this is observed, there may be a Mark/Space polarity problem between your station and the other station. If so, try setting Menu item “093 RTTY R PLRTY” to “REV” (“Reverse”) to see if that permits copy. A separate Menu item permits reversal of your transmitter Mark/Space polarity: “094 RTTY T PLRTY”.

### QUICK POINT:

In the FTdx5000, “RTTY” is defined as an “FSK” mode, whereby the closing and opening of a keying line (to ground) causes the Mark/Space tones to alternate. The RTTY mode is not an AFSK based mode in this transceiver and the AFSK output tones from a TNC will not cause Mark/Space shifting to occur. Use the “Packet” mode for AFSK-based Baudot and other data modes.

# MISCELLANEOUS AFSK-BASED DATA MODES

The **FTDx5000** may also be used for a host of other SSB-based Data modes. Please set up your system using the illustration as a guideline.

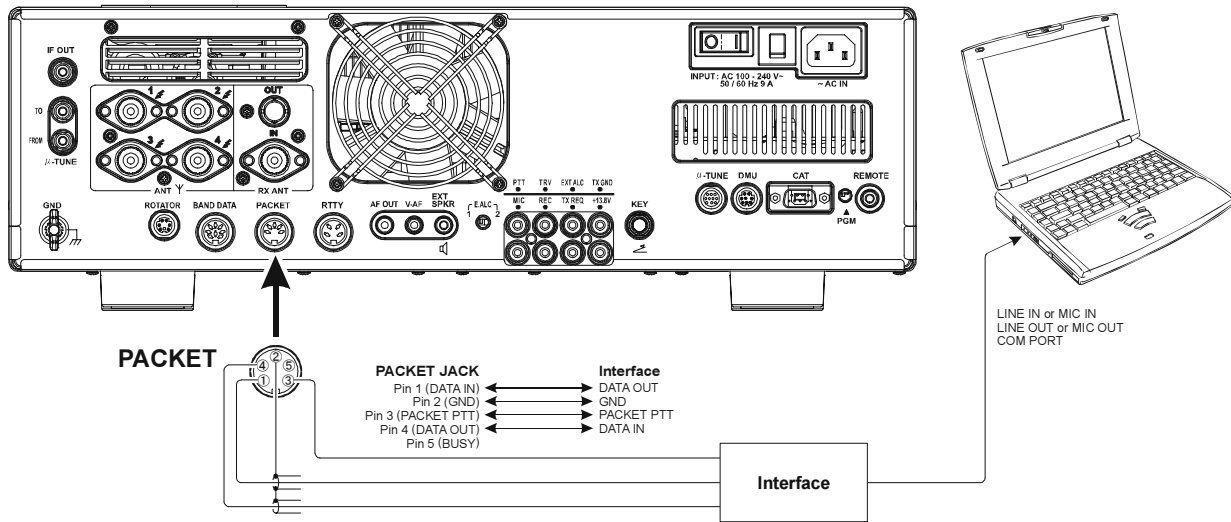

## QUICK POINT:

When you have configured Menu item “**174 TGEN VOX SEL**” to “**DATA**”, the transceiver will operate in a “**VOX**” mode, and it is not necessary to connect a **PTT** line. This makes very convenient to interface your transceiver to computer Sound Cards, etc.



# ABOUT THE TRANSVERTER OUTPUT TERMINAL

You may connect an after-market transverter to the rear panel **TRV** jack. The output frequency is selectable from 14, 28, and 50 MHz, and the output level is approximately  $-10$  dBm (0.1 mW) at 50 Ohms.

## SETUP

1. Press the **[MENU]** button briefly to enter the Menu mode.
2. Rotate the **(VFO-A)[SELECT]** knob to select Menu item “**150 TUNE MY BAND**”.
3. Rotate the **(VFO-B)[SELECT]** knob to select the desired input frequency band of the transverter in menu item (T14M OFF, T28M OFF, or T50M OFF ).
4. Press the **[ENT]** button (one of the **[BAND]** buttons) to change the parameter to “ON” (the “OFF” notation will change to “ON”).
5. Rotate the **(VFO-A)[SELECT]** knob to select Menu item “**172 TGEN ETX-GND**”.
6. Rotate the **(VFO-B)[SELECT]** knob to set this Menu item to “ENABLE” to enable the internal relay connected to the rear panel **TX GND** jack.
7. Press and hold the **[MENU]** button for at least two seconds to save the new setting, and exit to normal operation.

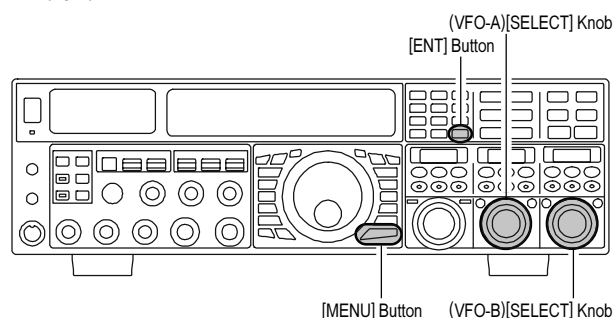

### Setting the Transverter Frequency Offset

You may set up the frequency display so that it shows the frequencies of the transverter operating band (instead of the 28 MHz band frequencies used as the “IF” on your **FTDx5000**).

*Example:* Setting up the **FTDx5000** display for use with a 144 MHz Transverter

1. Connect the 144 MHz transverter to the **FTDx5000**.
2. Press the **[MENU]** button briefly, to enter the Menu mode.
3. Rotate the **(VFO-A)[SELECT]** knob to select the Menu item which designates the input frequency band from the transverter (**040 GENE TRV 14M**, **041 GENE TRV 28M**, or **042 GENE TRV 50M**).
4. Rotate the **(VFO-B)[SELECT]** knob to select “44MHz” on the display.
5. Press and hold the **[MENU]** button in for at least two seconds to save the new setting and exit.

The “100 MHz” digit of the frequency is not displayed, so when you are operating on 2 meters and see “45 MHz” on the frequency readout, this indicates “145 MHz” instead.

### ADVICE:

With the setup described above, tuning the actual operating range of the **FTDx5000** will correspond to transverter operating frequency of 144-145 MHz, with “44-45” being displayed on the front panel of the transceiver.



# ABOUT THE TRANSVERTER OUTPUT TERMINAL

## OPERATION

1. Set up the **FTdx5000** for transverter use, as described previously.
2. Choose the “Transverter” band with the “MY Bands” procedures as described on page 46. You may find the “Transverter” band between the “1.8 MHz” and “50 MHz” Bands.
3. Rotate the Main Tuning Dial knob to set the desired operating frequency. Operation is basically unchanged from normal transceiver operation.

### ADVICE:

When the “Transverter” mode is turned on, TX power output will not be allowed to pass to the “ANT 1” through “ANT 4” main antenna jacks. So one of these may be connected to your transverters “RX” jack. Just be certain to disconnect the transverter when returning to HF operation, as the selected antenna jack will now be capable of passing RF power.

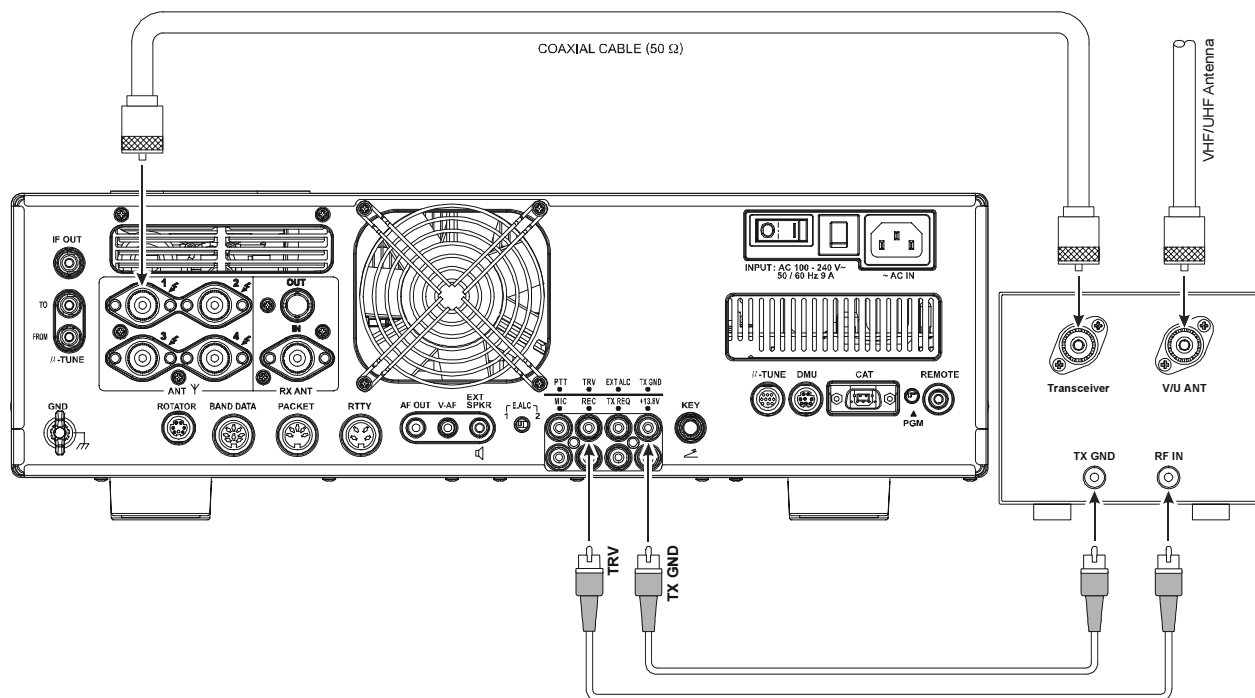

# MENU MODE

The Menu system of the **FTdx5000** provides extensive customization capability, so you can set up your transceiver just the way you want to operate it. The Menu items are grouped by general utilization category, and are numbered from “001 AGC FST DLY” to “176 TGEN EMRGNCY.”

## USING THE MENU

1. Press the **[MENU]** button momentarily, to engage the Menu mode.

The **SUB DISPLAY-I** window will show the Menu Number and Menu Group name, while the **SUB DISPLAY-II** window will show the Menu item; the **SUB DISPLAY-III** window shows the current setting of the currently-selected Menu item.

2. Rotate the **(VFO-A)[SELECT]** knob to select the Menu item you wish to work on.
3. Rotate the **(VFO-B)[SELECT]** knob to change the current setting of the selected Menu item.

### ADVICE:

Press the **[CLEAR]** button momentarily to reset the selected Menu item to the factory default value.

4. When you have finished making your adjustments, press and hold in the **[MENU]** button for two seconds to save the new setting and exit to normal operation. If you only *momentarily* press the **[MENU]** button, the new settings will *not* be retained.

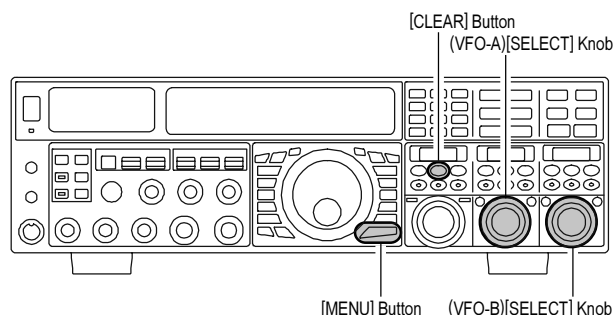

## Menu Mode Reset

You may reset all the Menu settings to their original factory defaults, if desired.

1. Turn the front panel **[POWER]** switch off.
2. Press and hold in the **[MENU]** button, and while holding it in, press the **[POWER]** switch to turn the transceiver back on. Now release the **[MENU]** button.

# MENU MODE

GROUP	No.	MENU FUNCTION	AVAILABLE VALUES	DEFAULT SETTING
AGC	001	AGC FST DLY	20 msec ~ 4000 msec (20 msec/step)	300 msec
AGC	002	AGC FST HLD	0 msec ~ 2000 msec (20 msec/step)	20 msec
AGC	003	AGC MID DLY	20 msec ~ 4000 msec (20 msec/step)	700 msec
AGC	004	AGC MID HLD	0 msec ~ 2000 msec (20 msec/step)	20 msec
AGC	005	AGC SLW DLY	20 msec ~ 4000 msec (20 msec/step)	3000 msec
AGC	006	AGC SLW HLD	0 msec ~ 2000 msec (20 msec/step)	20 msec
DISPLAY	007	DISP COLOR	BLUE1 / BLUE2 / WHITE / UMBER1 / UMBER2	BLUE1*1
DISPLAY	008	DISP DIM MTR	0 ~ 15	8
DISPLAY	009	DISP DIM VFD	0 ~ 15	8
DISPLAY	010	DISP DIM OLE	0 ~ 15	8
DISPLAY	011	DISP DIM ELCD	0 ~ 15	8
DISPLAY	012	DISP BAR SEL	CLAR / CW TUNE	CW TUNE
DISPLAY	013	DISP S PK HLD	OFF / 0.5s / 1.0s / 2.0s	OFF
DISPLAY	014	DISP RTR STU	0° / 90° / 180° / 270°	0°
DISPLAY	015	DISP RTR ADJ	-30° ~ 0° (2°/step)	0°
DISPLAY	016	DISP QMB MKR	DISABLE / ENABLE	ENABLE*1
DISPLAY	017	DISP LVL IND	PTCH / SPED / CDLY / VDLY / RPWR / MICG / PROC	ON
DISPLAY	018	DISP INDI	VFD / OEL	VFD
DISPLAY	019	DISP SELECT	PTN1 / PTN2 / PTN3	PTN2
DVS	020	DVS RX LVL	0 ~ 100	50
DVS	021	DVS TX LVL	0 ~ 100	50
KEYER	022	KEY BEACON	OFF / 1s ~ 240s (1 sec/step) / 270s ~ 690s (1 sec/step)	OFF
KEYER	023	KEY NUM STL	1290 / AUNO / AUNT / A2NO / A2NT / 12NO / 12NT	1290
KEYER	024	KEY CONTEST	0 ~ 9999	1
KEYER	025	KEY CW MEM1	TEXT / MESSAGE	MESSAGE
KEYER	026	KEY CW MEM2	TEXT / MESSAGE	MESSAGE
KEYER	027	KEY CW MEM3	TEXT / MESSAGE	MESSAGE
KEYER	028	KEY CW MEM4	TEXT / MESSAGE	MESSAGE
KEYER	029	KEY CW MEM5	TEXT / MESSAGE	MESSAGE
GENERAL	030	GENE ANT SEL	BAND / STACK	BAND
GENERAL	031	GENE BEEP LVL	0 ~ 100	40
GENERAL	032	GENE CAT BPS	4800 bps / 9600 bps / 19200 bps / 38400 bps	4800 bps
GENERAL	033	GENE CAT TOT	10 msec / 100 msec / 1000 msec / 3000 msec	10 msec
GENERAL	034	GENE CAT RTS	DISABLE / ENABLE	ENABLE
GENERAL	035	GENE CAT IND	DISABLE / ENABLE	ENABLE
GENERAL	036	GENE MEM GRP	DISABLE / ENABLE	DISABLE
GENERAL	037	GENE Q SPLIT	-20 kHz ~ 0 kHz ~ 20 kHz (1 kHz/step)	+5 kHz
GENERAL	038	GENE TRACK	OFF / BAND / FREQ	OFF
GENERAL	039	GENE TX TOT	OFF / 1 ~ 30 min	OFF
GENERAL	040	GENE TRV 14M	30 MHz ~ 46 MHz	44 MHz
GENERAL	041	GENE TRV 28M	30 MHz ~ 46 MHz	44 MHz
GENERAL	042	GENE TRV 50M	30 MHz ~ 46 MHz	44 MHz
GENERAL	043	GENE $\mu$ T DIAL	STEP-1 / STEP-2 / OFF	STEP-1
GENERAL	044	GENE MIC SCN	DISABLE / ENABLE	ENABLE
GENERAL	045	GENE SCN RSM	TIME / PAUSE	TIME
GENERAL	046	GENE FRQ ADJ	-25 ~ 0 ~ +25	0
MODE-AM	047	A3E LCUT FRQ	OFF / 100 Hz ~ 1000 Hz (50 Hz/step)	OFF
MODE-AM	048	A3E LCUT SLP	6dB/oct or 18dB/oct	6dB/oct
MODE-AM	049	A3E HCUT FRQ	700 Hz ~ 4000 Hz / OFF (50 Hz/step)	OFF
MODE-AM	050	A3E HCUT SLP	6dB/oct or 18dB/oct	6dB/oct
MODE-AM	051	A3E MIC GAIN	MCVR / 0 ~ 100	30
MODE-AM	052	A3E MIC SEL	FRONT / DATA / PC	FRONT

\*: Requires optional **DMU-2000** Data Management Unit.

# MENU MODE

GROUP	No. MENU FUNCTION	AVAILABLE VALUES	DEFAULT SETTING
MODE-CW	053 A1A LCUT FRQ	OFF / 100 Hz ~ 1000 Hz (50 Hz/step)	300 Hz
MODE-CW	054 A1A LCUT SLP	6dB/oct or 18dB/oct	18dB/oct
MODE-CW	055 A1A HCUT FRQ	700 Hz ~ 4000 Hz / OFF (50 Hz/step)	1000 Hz
MODE-CW	056 A1A HCUT SLP	6dB/oct or 18dB/oct	6dB/oct
MODE-CW	057 A1A F-TYPE	OFF / BUG / ELEKEY / ACS	ELEKEY
MODE-CW	058 A1A F-REV	NOR / REV	NOR
MODE-CW	059 A1A R-TYPE	OFF / BUG / ELEKEY / ACS	ELEKEY
MODE-CW	060 A1A R-REV	NOR / REV	NOR
MODE-CW	061 A1A CW AUTO	OFF / 50M / ON	OFF
MODE-CW	062 A1A BFO	USB / LSB / AUTO	USB
MODE-CW	063 A1A BK-IN	SEMI / FULL	SEMI
MODE-CW	064 A1A SHAPE	1 msec / 2 msec / 4 msec / 6 msec	4 msec
MODE-CW	065 A1A WEIGHT	(1:) 2.5 ~ 4.5	3.0
MODE-CW	066 A1A FRQ DISP	FREQ / PITCH	PITCH
MODE-CW	067 A1A PC KYNG	DISABLE / ENABLE	DISABLE
MODE-CW	068 A1A QSCTIME	15 msec / 20 msec / 25 msec / 30 msec	15 msec
MODE-DAT	069 DATA DATA IN	DATA / PC	DATA
MODE-DAT	070 DADA DT GAIN	0 ~ 100	50
MODE-DAT	071 DATA DT OUT	VFO-A / VFO-B	VFO-A
MODE-DAT	072 DATA OUT LVL	0 ~ 100	50
MODE-DAT	073 DATA VOX DLY	30 ms ~ 3000 ms (10 ms/step)	300ms
MODE-DAT	074 DATA VOX GAIN	0 ~ 100	50
MODE-FM	075 F3E LCUT FRQ	OFF / 100 Hz ~ 1000 Hz (50 Hz/step)	OFF
MODE-FM	076 F3E LCUT SLP	6dB/oct or 18dB/oct	6dB/oct
MODE-FM	077 F3E HCUT FRQ	700 Hz ~ 4000 Hz / OFF (50 Hz/step)	OFF
MODE-FM	078 F3E HCUT SLP	6dB/oct or 18dB/oct	6dB/oct
MODE-FM	079 F3E MIC GAIN	MCVR / 0 ~ 100	50
MODE-FM	080 F3E MIC SEL	FRONT / DATA / PC	FRONT
MODE-FM	081 F3E 28 RPT	0 kHz ~ 1000 kHz (10 kHz/step)	100 kHz
MODE-FM	082 F3E 50 RPT	0 kHz ~ 4000 kHz (10 kHz/step)	1000 kHz
MODE-PKT	083 PKT LCUT FRQ	OFF / 100 Hz ~ 1000 Hz (50 Hz/step)	300 Hz
MODE-PKT	084 PKT LCUT SLP	6dB/oct or 18dB/oct	18dB/oct
MODE-PKT	085 PKT HCUT FRQ	700 Hz ~ 4000 Hz / OFF (50 Hz/step)	3000 Hz
MODE-PKT	086 PKT HCUT SLP	6dB/oct or 18dB/oct	18dB/oct
MODE-PKT	087 PKT PKT DISP	-3000 Hz ~ 3000 Hz (10 Hz/step)	0 Hz
MODE-PKT	088 PKT PKT SFT	-3000 Hz ~ 3000 Hz (10 Hz/step)	1000 Hz
MODE-RTY	089 RTTY LCUT FRQ	OFF / 100 Hz ~ 1000 Hz (50 Hz/step)	300 Hz
MODE-RTY	090 RTTY LCUT SLP	6dB/oct or 18dB/oct	18dB/oct
MODE-RTY	091 RTTY HCUT FRQ	700 Hz ~ 4000 Hz / OFF (50 Hz/step)	3000 Hz
MODE-RTY	092 RTTY HCUT SLP	6dB/oct or 18dB/oct	18dB/oct
MODE-RTY	093 RTTY R PLRTY	NOR / REV	NOR
MODE-RTY	094 RTTY T PLRTY	NOR / REV	NOR
MODE-RTY	095 RTTY RTTY OUT	VFO-A / VFO-B	VFO-A
MODE-RTY	096 RTTY OUT LVL	0 ~ 100	50
MODE-RTY	097 RTTY SHIFT	170 Hz / 200 Hz / 425 Hz / 850 Hz	170 Hz
MODE-RTY	098 RTTY TONE	1275 Hz / 2125 Hz	2125 Hz
MODE-SSB	099 A3J LCUT FRQ	OFF / 100 Hz ~ 1000 Hz (50 Hz/step)	100 Hz
MODE-SSB	100 A3J LCUT SLP	6dB/oct or 18dB/oct	6dB/oct
MODE-SSB	101 A3J HCUT FRQ	700 Hz ~ 4000 Hz / OFF (50 Hz/step)	3000 Hz
MODE-SSB	102 A3J HCUT SLP	6dB/oct or 18dB/oct	6dB/oct
MODE-SSB	103 A3J MIC SEL	FRONT / DATA / PC	FRONT
MODE-SSB	104 A3J TX BPF	50-3000 / 100-2900 / 200-2800 / 300-2700 / 400-2600 / 3000WB	300-2700
MODE-SSB	105 A3J LSB CAR	-200 Hz ~ 200 Hz (10 Hz/step)	0 Hz
MODE-SSB	106 A3J USB CAR	-200 Hz ~ 200 Hz (10 Hz/step)	0 Hz

# MENU MODE

GROUP	No.	MENU FUNCTION	AVAILABLE VALUES	DEFAULT SETTING
RX AUDIO	107	ROUT AGC SLP	NORMAL / SLOPE	NORMAL
RX AUDIO	108	ROUT HEADPHN	SEPARATE / COMBINE1 / COMBINE2	SEPARATE
RX GNRL	109	RGEN IF OUT	DISABLE / ENABLE	DISABLE
RX GNRL	110	RGEN MNB LVL	0 ~ 100	50
RX GNRL	111	RGEN MNB WDTN	0 ~ 100	50
RX DSP	112	RDSP CNTR LV	-40 dB ~ 20 dB	-15 dB
RX DSP	113	RDSP CNTR WI	1 ~ 11	10
RX DSP	114	RDSP NOTCH WI	NARROW / WIDE	WIDE
RX DSP	115	RDSP HCW SHP	SOFT / SHARP	SHARP
RX DSP	116	RDSP HCW SLP	STEEP / MEDIUM / GENTLE	MEDIUM
RX DSP	117	RDSP HPKT SHP	SOFT / SHARP	SHARP
RX DSP	118	RDSP HPKT SLP	STEEP / MEDIUM / GENTLE	MEDIUM
RX DSP	119	RDSP HRTY SHP	SOFT / SHARP	SHARP
RX DSP	120	RDSP HRTY SLP	STEEP / MEDIUM / GENTLE	MEDIUM
RX DSP	121	RDSP HSSB SHP	SOFT / SHARP	SHARP
RX DSP	122	RDSP HSSB SLP	STEEP / MEDIUM / GENTLE	MEDIUM
RX DSP	123	RDSP VCW SHP	SOFT / SHARP	SHARP
RX DSP	124	RDSP VCW SLP	STEEP / MEDIUM / GENTLE	MEDIUM
RX DSP	125	RDSP VPKT SHP	SOFT / SHARP	SHARP
RX DSP	126	RDSP VPKT SLP	STEEP / MEDIUM / GENTLE	MEDIUM
RX DSP	127	RDSP VRTY SHP	SOFT / SHARP	SHARP
RX DSP	128	RDSP VRTY SLP	STEEP / MEDIUM / GENTLE	MEDIUM
RX DSP	129	RDSP VSSB SHP	SOFT / SHARP	SHARP
RX DSP	130	RDSP VSSB SLP	STEEP / MEDIUM / GENTLE	MEDIUM
SCOPE	131	SCP 1.8 FIX	1800 kHz ~ 1999 kHz (1 kHz/step)	1800 kHz <sup>※1</sup>
SCOPE	132	SCP 3.5 FIX	3500 kHz ~ 3999 kHz (1 kHz/step)	35000 kHz <sup>※1</sup>
SCOPE	133	SCP 5.0 FIX	5250 kHz ~ 5499 kHz (1 kHz/step)	5250 kHz <sup>※1</sup>
SCOPE	134	SCP 7.0 FIX	7000 kHz ~ 7299 kHz (1 kHz/step)	7000 kHz <sup>※1</sup>
SCOPE	135	SCP 10.1 FIX	10100 kHz ~ 10149 kHz (1 kHz/step)	10100 kHz <sup>※1</sup>
SCOPE	136	SCP 14.0 FIX	14000 kHz ~ 14349 kHz (1 kHz/step)	14000 kHz <sup>※1</sup>
SCOPE	137	SCP 18.0 FIX	18000 kHz ~ 18199 kHz (1 kHz/step)	18068 kHz <sup>※1</sup>
SCOPE	138	SCP 21.0 FIX	21000 kHz ~ 21449 kHz (1 kHz/step)	21000 kHz <sup>※1</sup>
SCOPE	139	SCP 24.8 FIX	24800 kHz ~ 24989 kHz (1 kHz/step)	24890 kHz <sup>※1</sup>
SCOPE	140	SCP 28.0 FIX	28000 kHz ~ 29699 kHz (1 kHz/step)	28000 kHz <sup>※1</sup>
SCOPE	141	SCP 50.0 FIX	50000 kHz ~ 53999 kHz (1 kHz/step)	50000 kHz <sup>※1</sup>
TUNING	142	TUN DIAL STP	1 Hz / 5 Hz / 10 Hz	10 Hz
TUNING	143	TUN CW FINE	DISABLE / ENABLE	DISABLE
TUNING	144	TUN MHz SEL	1 MHz / 100 kHz	100 kHz
TUNING	145	TUN AM STEP	2.5 kHz / 5 kHz / 9 kHz / 10 kHz / 12.5 kHz	5 kHz
TUNING	146	TUN FM STEP	5 kHz / 6.25 kHz / 10 kHz / 12.5 kHz / 20 kHz / 25 kHz	5 kHz
TUNING	147	TUN AM D.LCK	DISABLE / ENABLE	DISABLE
TUNING	148	TUN FM D.LCK	DISABLE / ENABLE	DISABLE
TUNING	149	TUN FM DIAL	10 Hz / 100 Hz	100 Hz
TUNING	150	TUN MY BAND	1.8M ~ 50M / GEN / T14M / T28M / T50M	TRV

※1: Requires optional **DMU-2000** Data Management Unit.

※2: This Menu item does not work. Please do not change this setting.

# MENU MODE

GROUP	No. MENU FUNCTION	AVAILABLE VALUES	DEFAULT SETTING
TX AUDIO	151 TAUD EQ1 FRQ	OFF / 100 Hz ~ 700 Hz (100 Hz/step)	OFF
TX AUDIO	152 TAUD EQ1 LVL	-20 ~ 10	5
TX AUDIO	153 TAUD EQ1 BW	1 ~ 10	10
TX AUDIO	154 TAUD EQ2 FRQ	OFF / 700 Hz ~ 1500 Hz (100 Hz/step)	OFF
TX AUDIO	155 TAUD EQ2 LVL	-20 ~ 10	5
TX AUDIO	156 TAUD EQ2 BW	1 ~ 10	10
TX AUDIO	157 TAUD EQ3 FRQ	OFF / 1500 Hz ~ 3200 Hz (100 Hz/step)	OFF
TX AUDIO	158 TAUD EQ3 LVL	-20 ~ 10	5
TX AUDIO	159 TAUD EQ3 BW	1 ~ 10	10
TX AUDIO	160 TAUD PE1 FRQ	OFF / 100 Hz ~ 700 Hz (100 Hz/step)	200 Hz
TX AUDIO	161 TAUD PE1 LVL	-20 ~ 10	0
TX AUDIO	162 TAUD PE1 BW	1 ~ 10	2
TX AUDIO	163 TAUD PE2 FRQ	OFF / 700 Hz ~ 1500 Hz (100 Hz/step)	800 Hz
TX AUDIO	164 TAUD PE2 LVL	-20 ~ 10	0
TX AUDIO	165 TAUD PE2 BW	1 ~ 10	1
TX AUDIO	166 TAUD PE3 FRQ	OFF / 1500 Hz ~ 3200 Hz (100 Hz/step)	2100 Hz
TX AUDIO	167 TAUD PE3 LVL	-20 ~ 10	0
TX AUDIO	168 TAUD PE3 BW	1 ~ 10	1
TX GNRL	169 TGEN BIAS	1 ~ 100	100
TX GNRL	170 TGEN MAX PWR	20 W / 50 W / 100 W / 200 W	200 W
TX GNRL	171 TGEN PWR CTRL	ALL MODE / CARRIER	ALL MODE
TX GNRL	172 TGEN ETX-GND	DISABLE / ENABLE	DISABLE
TX GNRL	173 TGEN TUN PWR	20 W / 50 W / 100 W / 200 W	100 W
TX GNRL	174 TGEN VOX SEL	MIC / DATA	MIC
TX GNRL	175 TGEN ANTI VOX	0 ~ 100	50
TX GNRL	176 TGEN EMRGNCY	DISABLE / ENABLE	DISABLE

---

---

## AGC GROUP

---

---

### 001 AGC FST DLY

**Function:** Sets the delay time for the AGC FAST mode.

**Available Values:** 20 msec ~ 4000 msec (20 msec/step)

**Default Setting:** 300 msec

### 002 AGC FST HLD

**Function:** Sets the hang time of the AGC peak voltage for the AGC FAST mode.

**Available Values:** 0 msec ~ 2000 msec (20 msec/step)

**Default Setting:** 20 msec

### 003 AGC MID DLY

**Function:** Sets the delay time for the AGC MID mode.

**Available Values:** 20 msec ~ 4000 msec (20 msec/step)

**Default Setting:** 700 msec

### 004 AGC MID HLD

**Function:** Sets the hang time of the AGC peak voltage for the AGC MID mode.

**Available Values:** 0 msec ~ 2000 msec (20 msec/step)

**Default Setting:** 20 msec

### 005 AG SLW DLY

**Function:** Sets the delay time for the AGC SLOW mode.

**Available Values:** 20 msec ~ 4000 msec (20 msec/step)

**Default Setting:** 3000 msec

### 006 AGC SLW HLD

**Function:** Sets the hang time of the AGC peak voltage for the AGC SLOW mode.

**Available Values:** 0 msec ~ 2000 msec (20 msec/step)

**Default Setting:** 20 msec

---

---

## DISPLAY GROUP

---

---

### 007 DISP COLOR

**Function:** Selects the Display color when the optional Data Management Unit (**DMU-2000**) is connected.

**Available Values:** BLUE1 / BLUE2 / WHITE / UMBER1 / UMBER2

**Default Setting:** BLUE1

**ADVICE:**

If the optional **DMU-2000** Data Management Unit is not connected, this adjustment has no effect.

### 008 DISP DIM MTR

**Function:** Setting of the meter brightness level when "DIM" is selected.

**Available Values:** 0 ~ 15

**Default Setting:** 8

**ADVICE:**

You may see the effects of your changes by pressing the [DIM] switch to activate the Dimmer function.

### 009 DISP DIM VFD

**Function:** Setting of the frequency display brightness level when "DIM" is selected.

**Available Values:** 0 ~ 15

**Default Setting:** 8

**ADVICE:**

You may see the effects of your changes by pressing the [DIM] switch to activate the Dimmer function.

### 010 DISP DIM OEL

**Function:** Setting of three Sub Displays brightness level when "DIM" is selected.

**Available Values:** 0 ~ 15

**Default Setting:** 8

**ADVICE:**

You may see the effects of your changes by pressing the [DIM] switch to activate the Dimmer function.

### 011 DISP DIM ELCD

**Function:** Setting of the Spectrum Scope display brightness level of the optional **SM-5000** Station Monitor when "DIM" is selected.

**Available Values:** 0 ~ 15

**Default Setting:** 8

**ADVICE:**

You may see the effects of your changes by pressing the [DIM] switch to activate the Dimmer function.

If the optional **SM-5000** Station Monitor is not connected, this adjustment has no effect.

### 012 DISP BAR SEL

**Function:** Selects one of three parameters to be viewed on the Tuning Offset Indicator.

**Available Values:** CLAR / CW TUNE

**Default Setting:** CW TUNE

CLAR: Displays relative clarifier offset.

CW TUNE: Displays relative CW tuning offset between the incoming signal and transmitted frequency.

## DISPLAY GROUP

### 013 DISP PK HLD

**Function:** Selects the peak hold time of the VFO-B receiver's S-meter.

**Available Values:** OFF / 0.5s / 1.0s / 2.0s

**Default Setting:** OFF

### 014 DISP RTR STU

**Function:** Selects the starting point of your rotator controller's indicator needle.

**Available Values:** 0° / 90° / 180° / 270°

**Default Setting:** 0°

### 015 DISP RTR ADJ

**Function:** Adjusts the indicator needle precisely to the starting point set in menu item "014 DISP RTR STU".

**Available Values:** -30° ~ 0° (2°/step)

**Default Setting:** 0°

### 016 DISP QMB MKR

**Function:** Enables/Disables the QMB Marker (White arrow "▽") to display on the Spectrum Band Scope when the optional **DMU-2000** Data Management Unit is connected.

**Available Values:** DISABLE / ENABLE

**Default Setting:** ENABLE

#### ADVICE:

If the optional **DMU-2000** Data Management Unit is not connected, this adjustment has no effect.

### 017 DISP LVL IND

**Function:** Enables/Disables the Main Display to show the frequency or value while each enabled knob is turned.

**Available Values:** PTCH (PITCH) / SPED (SPEED) / CDLY (CW DELAY) / VDLY (VOX DEALAY) / RPWR (RF POWER) / MICG (MIC GAIN) / PROC (PROCESSOR GAIN)

To disable the "function," rotate the (VFO-B)[SELECT] knob to recall the "function" to be disabled, then press the [ENT] key (one of the [BAND] buttons) to change this setting to "OFF". Repeat the same procedures to enable a function (setting it to "ON").

### 018 DISP INDI

**Function:** Select the indicator location of the current value when adjusting the following knobs\*.

**Available Values:** VFD / OEL

**Default Setting:** VFD

VFD: The current value will show for 3-seconds in the lower right corner of the Main Display whenever the following knob\* is turned.

OEL: The current value will show for 3-seconds in the **SUB DISPLAY-III** window whenever the following knob\* is turned.

\*: MIC, RF PWR, SPEED, PITCH, DELAY, and PITCH knob

### 019 DISP SELECT

**Function:** Selects the display pattern of the **SUB DISPLAY-II** and **SUB DISPLAY-III** windows.

**Available Values:** PTN1 / PTN2 / PTN3







**Default Setting:** PTN2

PTN1: Generally, the current value is not indicated in the window, only the graphic is depicted. When the [SELECT] knob is rotated, the current value will appear under the graphical display. Three seconds after the turning of the [SELECT] knob is stopped, the current value indication disappears.

PTN2: Generally, the current value is indicated with the small characters and graphical display. When the [SELECT] knob is rotated, the current value indication becomes large characters. Three seconds after the turning of the [SELECT] knob is stopped, the current value indication returns to small characters.

PTN3: The current value always indicated with the large characters and graphical display.

#### SUB DISPLAY EXAMPLES (CONTOUR OPERATION)

	GENERAL	WHILE ADJUSTING
PTN1		
PTN2		
PTN3		

## DVS GROUP

### 020 DVS RX LVL

**Function:** Sets the audio output level from the voice memory.

**Available Values:** 0 ~ 100

**Default:** 50

### 021 DVS TX LVL

**Function:** Sets the microphone input level to the voice memory

**Available Values:** 0 ~ 100

**Default:** 50



---

---

## KEYER GROUP

---

---

### 022 KEY BEACON

**Function:** Sets the interval time between repeats of the beacon message.

**Available Values:** OFF / 1s ~ 240 sec (1 sec/step) / 270s ~ 690 sec (30 sec/step)

**Default Setting:** OFF

### 023 KEY NUM STL

**Function:** Selects the Contest Number “Cut” format for an imbedded contest number.

**Available Values:** 1290 / AUNO / AUNT / A2NO / A2NT / 12NO / 12NT

**Default Setting:** 1290

1290: Does not abbreviate the Contest Number

AUNO: Abbreviates to “A” for “One,” “U” for “Two,” “N” for “Nine,” and “O” for “Zero.”

AUNT: Abbreviates to “A” for “One,” “U” for “Two,” “N” for “Nine,” and “T” for “Zero.”

A2NO: Abbreviates to “A” for “One,” “N” for “Nine,” and “O” for “Zero.”

A2NT: Abbreviates to “A” for “One,” “N” for “Nine,” and “T” for “Zero.”

12NO: Abbreviates to “N” for “Nine,” and “O” for “Zero.”

12NT: Abbreviates to “N” for “Nine,” and “T” for “Zero.”

### 024 KEY CONTEST

**Function:** Enters the initial contest number that will increment/decrement after sending during contest QSOs.

**Available Values:** 0 ~ 9999

**Default Setting:** 1

**ADVICE:**

Press the [CLEAR] button to reset the contest number to “1.”

### 025 KEY CW MEM1

**Function:** Permits entry of the CW message for message register 1.

**Available Values:** TEXT / MESSAGE

**Default Setting:** MESSAGE

TEXT: You may enter the CW message from the **FH-2**'s keypad.

MESSAGE: You may enter the CW message from the CW keyer.

### 026 KEY CW MEM2

**Function:** Permits entry of the CW message for message register 2.

**Available Values:** TEXT / MESSAGE

**Default Setting:** MESSAGE

TEXT: You may enter the CW message from the **FH-2**'s keypad.

MESSAGE: You may enter the CW message from the CW keyer.

### 027 KEY CW MEM3

**Function:** Permits entry of the CW message for message register 3.

**Available Values:** TEXT / MESSAGE

**Default Setting:** MESSAGE

TEXT: You may enter the CW message from the **FH-2**'s keypad.

MESSAGE: You may enter the CW message from the CW keyer.

### 028 KEY CW MEM4

**Function:** Permits entry of the CW message for message register 4.

**Available Values:** TEXT / MESSAGE

**Default Setting:** MESSAGE

TEXT: You may enter the CW message from the **FH-2**'s keypad.

MESSAGE: You may enter the CW message from the CW keyer.

### 029 KEY CW MEM5

**Function:** Permits entry of the CW message for message register 5.

**Available Values:** TEXT / MESSAGE

**Default Setting:** MESSAGE

TEXT: You may enter the CW message from the **FH-2**'s keypad.

MESSAGE: You may enter the CW message from the CW keyer.

## GENERAL GROUP

### 030 GENE ANT SEL

**Function:** Sets the method of antenna selection.

**Available Values:** BAND / STACK

**Default Setting:** BAND

**BAND:** The antenna is selected in accordance with the operating band.

**STACK:** The antenna is selected in accordance with the band stack (different antennas may be utilized on the same band, if so selected in the band stack).

### 031 GENE BEEP LVL

**Function:** Sets the beep level.

**Available Values:** 0 ~ 100

**Default Setting:** 40

### 032 GENE CAT BPS

**Function:** Sets the transceiver's computer-interface circuitry for the CAT baud rate to be used.

**Available Values:** 4800bps / 9600bps / 19200bps / 38400bps

**Default Setting:** 4800bps

### 033 GENE CAT TOT

**Function:** Sets the Time-Out Timer countdown time for a CAT command input.

**Available Values:** 10ms / 100ms / 1000ms / 3000ms

**Default Setting:** 10ms

The Time-Out Timer shuts off the CAT data input after the continuous transmission of the programmed time.

### 034 GENE CAT RTS

**Function:** Enables/Disables the RTS port of the CAT jack.

**Available Values:** DISABLE / ENABLE

**Default Setting:** ENABEL

### 035 GENE CAT IND

**Function:** Enables/Disables the flashing of the CAT LED in conjunction with the CAT commands.

**Available Values:** DISABLE / ENABLE

**Default Setting:** ENABEL

### 036 GENE MEM GRP

**Function:** Enables/Disables Memory Group Operation.

**Available Values:** DISABLE / ENABLE

**Default Setting:** DISABEL

### 037 GENE Q SPLIT

**Function:** Selects the tuning offset for the Quick Split feature.

**Available Values:** -20 kHz ~ 0 kHz ~ 20 kHz (1 kHz Step)

**Default Setting:** 5 kHz

### 038 GENE TRACK

**Function:** Sets the VFO Tracking feature.

**Available Values:** OFF / BAND / FREQ

**Default Setting:** OFF

**OFF:** Disables the VFO Tracking feature.

**BAND:** When you change bands on the VFO-A side, the VFO-B will automatically change to be the same as that of VFO-A.

**FREQ:** This function is the similar to "BAND", additionally, the VFO-B frequency changes together with the VFO-A frequency when turning the Main Dial Tuning knob.

### 039 GENE TX TOT

**Function:** Sets the Time-Out Timer countdown time.

**Available Values:** OFF / 1min ~ 30min

**Default Setting:** OFF

The Time-Out Timer shuts off the transmitter after continuous transmission of the programmed time.

### 040 GENE TRV 14M

**Function:** Sets the 10's and 1's of the MHz digits display for operation with a transverter when the exciter band is 14 MHz.

**Available Values:** 30 MHz ~ 46 MHz

**Default Setting:** 44 MHz

The default setting would be used with a 144 MHz transverter. If you connect a 430 MHz transverter to the radio, set this menu to "30" (the "100 MHz" digits are hidden on this radio).

### 041 GENE TRV 28M

**Function:** Sets the 10's and 1's of the MHz digits display for operation with a transverter when the exciter band is 28 MHz.

**Available Values:** 30 MHz ~ 46 MHz

**Default Setting:** 44 MHz

The default setting would be used with a 144 MHz transverter. If you connect a 430 MHz transverter to the radio, set this menu to "30" (the "100 MHz" digits are hidden on this radio).

### 042 GENE TRV 50M

**Function:** Sets the 10's and 1's of the MHz digits display for operation with a transverter when the exciter band is 50 MHz.

**Available Values:** 30 MHz ~ 46 MHz

**Default Setting:** 44 MHz

The default setting would be used with a 144 MHz transverter. If you connect a 430 MHz transverter to the radio, set this menu to "30" (the "100 MHz" digits are hidden on this radio).

## GENERAL GROUP

### 043 GENE $\mu$ T DIAL

**Function:** Selects the  $\mu$ -TUNE mode.

**Available Values:** STEP-1 / STEP-2 / OFF

**Default Setting:** STEP-1

STEP-1: Activates the  $\mu$ -TUNE system using “COARSE” steps of the [SELECT] knob (2 steps/click) on the 7 MHz and lower amateur bands. On the 10/14 MHz bands, “FINE” steps of [SELECT] knob (1 step/click) will be used.

STEP-2: Activates the  $\mu$ -TUNE system using “FINE” steps of the [SELECT] knob (1 step/click) on the 14 MHz and lower amateur bands on the Main band (VFO-A).

OFF: Disables the  $\mu$ -TUNE system. Activates the VRF feature on the 14 MHz and lower amateur bands on the main band (VFO-A).

#### **ADVICE:**

If the optional RF  $\mu$ Tuning Kit is not connected, this adjustment has no effect.

### 044 GENE MIC SCN

**Function:** Enables/disables scanning access via the microphone's [UP]/[DWN] keys.

**Available Values:** DISABLE / ENABLE

**Default Setting:** ENABLE

### 045 GENE SCN RSM

**Function:** Selects the Scan Resume mode.

**Available Values:** TIME / PAUSE

**Default Setting:** TIME

TIME: The scanner will hold for five seconds, then resume whether or not the other station is still transmitting.

PAUSE: The scanner will hold until the signal disappears, then will resume after one second.

### 046 GENE FRQ ADJ

**Function:** Adjusts the reference oscillator.

**Available Values:** -25 ~ 0 ~ 25

**Default Setting:** 0

Connect a 50-Ohm dummy load and frequency counter to the antenna jack; adjust the (VFO-B)[SELECT] knob so that the frequency counter reading is same as the VFO frequency while pressing the PTT switch.

#### **ADVICE:**

Do not perform this Menu item unless you have a high-performance frequency counter. Perform this Menu item after aging the transceiver and frequency counter sufficiently (at least 30 minutes).

## MODE-AM GROUP

### 047 A3E LCUT FRQ

**Function:** Selects the cutoff frequency of the lower side of the RX audio filter in the AM mode.

**Available Values:** OFF / 100 Hz ~ 1000Hz (50 Hz/step)

**Default Setting:** OFF

### 048 A3E LCUT SLP

**Function:** Selects the filter slope of the lower side of the RX audio filter in the AM mode.

**Available Values:** 6dB/oct or 18dB/oct

**Default Setting:** 6dB/oct

### 049 A3E HCUT FRQ

**Function:** Selects the cutoff frequency of the upper side of the RX audio filter in the AM mode.

**Available Values:** OFF / 700Hz ~ 4000Hz (50 Hz/step)

**Default Setting:** OFF

### 050 A3E HCUT SLP

**Function:** Selects the filter slope of the upper side of the RX audio filter in the AM mode.

**Available Values:** 6dB/oct or 18dB/oct

**Default Setting:** 6dB/oct

### 051 A3E MIC GAIN

**Function:** Sets the microphone gain for the AM mode.

**Available Values:** MCVR / 0 ~ 100

**Default Setting:** 30

When this menu is set to “MCVR”, you may adjust the microphone gain using the front panel's [MIC] knob.

### 052 A3E MIC SEL

**Function:** Selects the microphone to be used in the AM mode.

**Available Values:** FRONT / DATA / PC

**Default Setting:** FRONT

FRONT: Selects the microphone connected to the front panel's MIC jack while using the AM mode.

DATA: Selects the microphone connected to pin 1 of the PACKET Jack while using the AM mode.

PC: This parameter is for future expansion of this transceiver's capabilities, but at this time is not supported.

## MODE-CW GROUP

### **053 A1A LCUT FRQ**

**Function:** Selects the cutoff frequency of the lower side of the RX audio filter in the CW mode.

**Available Values:** OFF / 100 Hz ~ 1000Hz (50 Hz/step)

**Default Setting:** 300Hz

### **054 A1A LCUT SLP**

**Function:** Selects the filter slope of the lower side of the RX audio filter in the CW mode.

**Available Values:** 6dB/oct or 18dB/oct

**Default Setting:** 18dB/oct

### **055 A1A HCUT FRQ**

**Function:** Selects the cutoff frequency of the upper side of the RX audio filter in the CW mode.

**Available Values:** OFF / 700Hz ~ 4000Hz (50 Hz/step)

**Default Setting:** 1000Hz

### **056 A1A HCUT SLP**

**Function:** Selects the filter slope of the upper side of the RX audio filter in the CW mode.

**Available Values:** 6dB/oct or 18dB/oct

**Default Setting:** 6dB/oct

### **057 A1A F-TYPE**

**Function:** Selects the desired keyer operation mode for the device connected to the front panel **KEY** jack.

**Available Values:** OFF / BUG / ELEKEY / ACS

**Default Setting:** ELEKEY

OFF: Disables the front panel keyer (use this mode with a straight key, an external keyer, or a computer-driven keying interface).

BUG: Mechanical “bug” keyer emulation. One paddle produces “dits” automatically, while the other paddle manually produces “dahs.”

ELEKEY: Iambic keyer with ACS (Automatic Character Spacing) disabled.

ACS: Iambic keyer with ACS (Automatic Character Spacing) enabled.

### **058 A1A F-REV**

**Function:** Selects the keyer paddle’s wiring configuration for the **KEY** jack on the front panel.

**Available Values:** NOR / REV

**Default Setting:** nor

NOR: Tip = Dot, Ring = Dash, Shaft = Ground

REV: Tip = Dash, Ring = Dot, Shaft = Ground

### **059 A1A R-TYPE**

**Function:** Selects the desired keyer operation mode for the device connected to the rear panel **KEY** jack.

**Available Values:** OFF / BUG / ELEKEY / ACS

**Default Setting:** ELEKEY

OFF: Disables the rear panel keyer (use this mode with a straight key, an external keyer, or a computer-driven keying interface).

BUG: Mechanical “bug” keyer emulation. One paddle produces “dits” automatically, while the other paddle manually produces “dahs.”

ELEKEY: Iambic keyer with ACS (Automatic Character Spacing) disabled.

ACS: Iambic keyer with ACS (Automatic Character Spacing) enabled.

### **060 A1A R-REV**

**Function:** Selects the keyer paddle wiring configuration for the **KEY** jack on the rear panel.

**Available Values:** NOR / REV

**Default Setting:** nor

NOR: Tip = Dot, Ring = Dash, Shaft = Ground

REV: Tip = Dash, Ring = Dot, Shaft = Ground

### **061 A1A CW AUTO**

**Function:** Enables/disables CW keying while operating on SSB.

**Available Values:** OFF / 50M / ON

**Default Setting:** OFF

OFF: Disables CW keying while operating on SSB.

50M: Enables CW keying only while operating SSB on 50 MHz (but not HF).

ON: Enables CW keying while operating on SSB (all TX bands).

### **NOTE:**

This feature allows you to move someone from SSB to CW without having to change modes on the front panel.

### **062 A1A BFO**

**Function:** Sets the CW carrier oscillator injection side for the CW mode.

**Available Values:** USB / LSB / AUTO

**Default Setting:** USB

USB: Injects the CW carrier oscillator on the USB side.

LSB: Injects the CW carrier oscillator on the LSB side.

AUTO: Injects the CW carrier oscillator on the LSB side while operating on the 7 MHz band and below, and the USB side while operating on the 10 MHz band and up.

## MODE-CW GROUP

### 063 A1A BK-IN

**Function:** Sets the CW “break-in” mode.

**Available Values:** SEMI / FULL

**Default Setting:** SEMI

SEMI: The transceiver will operate in the semi break-in mode. The delay (receiver recovery) time is set by the front panel [DELAY] knob.

FULL: The transceiver will operate in the full break-in (QSK) mode.

### 064 A1A SHAPE

**Function:** Selects the CW carrier wave-form shape (rise/fall times).

**Available Values:** 1ms / 2ms / 4ms / 6ms

**Default Setting:** 4 ms

### 065 A1A WEIGHT

**Function:** Sets the Dot:Dash ratio for the built-in electronic keyer.

**Available Values:** (1:) 2.5 ~ 4.5

**Default Setting:** 3.0

### 066 A1A FRQ DISP

**Function:** Selects the frequency Display Format for the CW mode.

**Available Values:** FREQ / PITCH

**Default Setting:** PITCH

FREQ: Displays the receiver carrier frequency, without any offset added. When changing modes between SSB and CW, the frequency display remains constant.

PITCH: This frequency display reflects the added BFO offset.

### 067 A1A PC KYNG

**Function:** Enables/disables CW keying from the “PACKET PTT” terminal (pin 3) on the rear panel’s PACKET jack while operating in the CW mode.

**Available Values:** DISABLE / ENABLE

**Default Setting:** DISABLE

### 068 A1A QSK TIME

**Function:** Selects the time delay between when the CW key is closed and the carrier is transmitted during Semi-break-in operation.

**Available Values:** 15ms / 20ms / 25ms / 30 ms

**Default Setting:** 15ms

## MODE-DAT GROUP

### 069 DATA DATA IN

**Function:** Selects the data input path to be used in the PKT mode.

**Available Values:** DATA / PC

**Default Setting:** DATA

DATA: Uses the data input line connected to pin 1 of the PACKET jack while using the PKT mode.

PC: This parameter is for future expansion of this transceiver’s capabilities, but at this time is not supported.

### 070 DATA DT GAIN

**Function:** Sets the data input level from the TNC to the AFSK modulator.

**Available Values:** 0 ~ 100

**Default Setting:** 50

### 071 DATA DT OUT

**Function:** Selects the receiver to be connected to the data output port (pin 4) of the PACKET jack.

**Available Values:** VFO-A / VFO-B

**Default Setting:** VFO-A

### 072 DATA OUT LVL

**Function:** Sets the AFSK data output level at the output port (pin 4) of the PACKET jack.

**Available Values:** 0 ~ 100

**Default Setting:** 50

### 073 DATA VOX DLY

**Function:** Adjusts the “VOX” delay (receiver recovery) time in the PKT mode.

**Available Values:** 30ms ~ 3000ms (10 ms/step)

**Default Setting:** 300ms

### 074 DATA VOX GAIN

**Function:** Adjusts the “VOX” gain in the PKT mode.

**Available Values:** 0 ~ 100

**Default Setting:** 50

# MENU MODE

## MODE-FM GROUP

### 075 F3E LCUT FRQ

**Function:** Selects the cutoff frequency of the lower side of the RX audio filter in the FM mode.

**Available Values:** OFF / 100Hz ~ 1000Hz (50 Hz/step)

**Default Setting:** OFF

### 076 F3E LCUT SLP

**Function:** Selects the filter slope of the lower side of the RX audio filter in the FM mode.

**Available Values:** 6dB/oct or 18dB/oct

**Default Setting:** 6dB/oct

### 077 F3E HCUT FRQ

**Function:** Selects the cutoff frequency of the upper side of the RX audio filter in the FM mode.

**Available Values:** OFF / 700Hz ~ 4000Hz (50 Hz/step)

**Default Setting:** OFF

### 078 F3E HCUT SLP

**Function:** Selects the filter slope of the upper side of the RX audio filter in the FM mode.

**Available Values:** 6dB/oct or 18dB/oct

**Default Setting:** 6dB/oct

### 079 F3E MIC GAIN

**Function:** Sets the microphone gain for the FM mode.

**Available Values:** MCVR / 0 ~ 100

**Default Setting:** 50

When this menu is set to "MCVR", you may adjust the microphone gain using the front panel [MIC] knob.

### 080 F3E MIC SEL

**Function:** Selects the microphone to be used on the FM mode.

**Available Values:** FRONT / DATA / PC

**Default Setting:** FRONT

FRONT: Selects the microphone connected to the front panel **MIC** jack while using the FM mode.

DATA: Selects the microphone connected to pin 1 of the **PACKET** Jack while using the FM mode.

PC: This parameter is for future expansion of this transceiver's capabilities, but at this time is not supported.

### 081 F3E 28 RPT

**Function:** Sets the magnitude of the repeater shift on the 28 MHz band.

**Available Values:** 0kHz ~ 1000kHz (10 kHz/step)

**Default Setting:** 100kHz

### 082 F3E 50 RPT

**Function:** Sets the magnitude of the repeater shift on the 50 MHz band.

**Available Values:** 0kHz ~ 4000kHz (10 kHz/step)

**Default Setting:** 1000kHz

## MODE-PKT GROUP

### 083 PKT LCUT FRQ

**Function:** Selects the cutoff frequency of the lower side of the RX audio filter in the Packet mode.

**Available Values:** OFF / 100Hz ~ 1000Hz (50 Hz/step)

**Default Setting:** 300Hz

### 084 PKT LCUT SLP

**Function:** Selects the filter slope of the lower side of the RX audio filter in the Packet mode.

**Available Values:** 6dB/oct or 18dB/oct

**Default Setting:** 18dB/oct

### 085 PKT HCUT FRQ

**Function:** Selects the cutoff frequency of the upper side of the RX audio filter in the Packet mode.

**Available Values:** OFF / 700Hz ~ 4000Hz (50 Hz/step)

**Default Setting:** 3000Hz

### 086 PKT HCUT SLP

**Function:** Selects the filter slope of the upper side of the RX audio filter in the Packet mode.

**Available Values:** 6dB/oct or 18dB/oct

**Default Setting:** 18dB/oct

### 087 PKT PKTDISP

**Function:** Sets the packet frequency display offset.

**Available:** -3000Hz ~ 3000Hz (10 Hz/step)

**Default:** 0Hz

### 088 DATA PKT SFT

**Function:** Sets the carrier point during the SSB packet operation.

**Available:** -3000Hz ~ 3000Hz (10 Hz/step)

**Default:** 1000Hz (typical center frequency for PSK31, etc.)

## MODE-RTTY GROUP

### 089 RTTY LCUT FRQ

**Function:** Selects the cutoff frequency of the lower side of the RX audio filter in the RTTY mode.

**Available Values:** OFF / 100Hz ~ 1000Hz (50 Hz/step)

**Default Setting:** 300Hz

### 090 RTTY LCUT SLP

**Function:** Selects the filter slope of the lower side of the RX audio filter in the RTTY mode.

**Available Values:** 6dB/oct or 18dB/oct

**Default Setting:** 18dB/oct

### 091 RTTY HCUT FRQ

**Function:** Selects the cutoff frequency of the upper side of the RX audio filter in the RTTY mode.

**Available Values:** OFF / 700Hz ~ 4000Hz (50 Hz/step)

**Default Setting:** 3000Hz

### 092 RTTY HCUT SLP

**Function:** Selects the filter slope of the upper side of the RX audio filter in the RTTY mode.

**Available Values:** 6dB/oct or 18dB/oct

**Default Setting:** 18dB/oct

### 093 RTTY R PLRTY

**Function:** Selects normal or reverse Mark/Space polarity for RTTY receive operation.

**Available Values:** NOR / REV

**Default Setting:** NOR

### 094 RTTY T PLRTY

**Function:** Selects normal or reverse Mark/Space polarity for RTTY transmit operation.

**Available Values:** NOR / REV

**Default Setting:** NOR

### 095 RTTY RTTY OUT

**Function:** Selects the receiver to be connected to the data output port (pin 2) of the **RTTY** jack.

**Available Values:** VFO-A / VFO-B

**Default Setting:** VFO-A

### 096 RTTY OUT LVL

**Function:** Sets the FSK RTTY data output level at the output port (pin 2) of the **RTTY** jack.

**Available Values:** 0 ~ 100

**Default Setting:** 50

### 097 RTTY SHIFT

**Function:** Selects the frequency shift for FSK RTTY operation.

**Available Values:** 170Hz / 200Hz / 425Hz / 850Hz

**Default Setting:** 170Hz

### 098 RTTY TONE

**Function:** Selects the Mark tone for RTTY operation.

**Available Values:** 1275Hz / 2125Hz

**Default Setting:** 2125Hz

## MODE-SSB GROUP

### 099 A3J LCUT FRQ

**Function:** Selects the cutoff frequency of the lower side of the RX audio filter in the SSB mode.

**Available Values:** OFF / 100Hz ~ 1000Hz (50 Hz/step)

**Default Setting:** 100Hz

### 100 A3J LCUT SLP

**Function:** Selects the filter slope of the lower side of the RX audio filter in the SSB mode.

**Available Values:** 6dB/oct or 18dB/oct

**Default Setting:** 6dB/oct

### 101 A3J HCUT FRQ

**Function:** Selects the cutoff frequency of the upper side of the RX audio filter in the SSB mode.

**Available Values:** OFF / 700Hz ~ 4000Hz (50 Hz/step)

**Default Setting:** 3000Hz

### 102 A3J HCUT SLP

**Function:** Selects the filter slope of the upper side of the RX audio filter in the SSB mode.

**Available Values:** 6dB/oct or 18dB/oct

**Default Setting:** 6dB/oct

### 103 A3J MIC SEL

**Function:** Selects the microphone to be used on the SSB modes (LSB and USB).

**Available Values:** FRONT / DATA / PC

**Default Setting:** Frnt

FRONT: Selects the microphone connected to the front panel **MIC** jack while using the SSB modes.

DATA: Selects the microphone connected to pin 1 of the **PACKET** Jack while using the SSB modes.

PC: This parameter is for future expansion of this transceiver's capabilities, but at this time is not supported.

### 104 A3J TX BPF

**Function:** Selects the audio passband of the DSP modulator on the SSB mode.

**Available Values:** 50-3000 / 100-2900 / 200-2800 / 300-2700 / 400-2600 / 3000WB

**Default Setting:** 300-2700 (Hz)

#### **NOTE:**

The apparent power output, when using the widest bandwidths, may seem lower. This is normal, and it occurs because the available transmitter power is distributed over a wider bandwidth. The greatest compression of power output, conversely, occurs when using the "400-2600" setting (400-2600 Hz), and this setting is highly recommended for contest or DX pile-up work.

# MENU MODE

## MODE-SSB GROUP

### 105 A3J LSB CAR

**Function:** Adjusts the receiver carrier point for the LSB mode.

**Available Values:** -200 Hz ~ 200 Hz (10 Hz/steps)

**Default Setting:** 0 Hz

### 106 A3J USB CAR

**Function:** Adjusts the receiver carrier point for the USB mode.

**Available Values:** -200 Hz ~ 200 Hz (10 Hz/step)

**Default Setting:** 0 Hz

## RX AUDIO GROUP

### 107 ROUT AGC SLP

**Function:** Selects the gain curve of the AGC amplifier.

**Available Values:** NORMAL / SLOPE

**Default Setting:** nor

**NORMAL:** The AGC output level will follow a linear response to the antenna input level, while AGC is activated.

**SLOPE:** The AGC output level will increase at 1/10 the rate of the antenna input level, while AGC is activated.

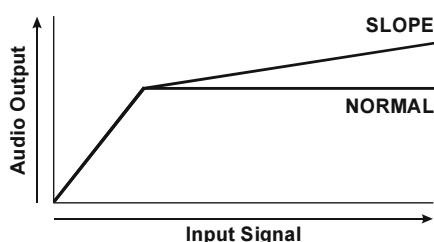

### 108 ROUT HEADPHN

**Function:** Selects one of three audio mixing modes when using headphones during Dual Receive operation.

**Available Values:** SEPARATE / COMBINE1 / COMBINE2

**Default Setting:** SEPARATE

**SEPARATE:** Audio from the VFO-A receiver is heard only in the left ear, and VFO-B receiver audio solely in the right ear.

**COMBINE1:** Audio from both VFO-A and VFO-B receivers can be heard in both ears, but VFO-B audio is attenuated in the left ear and VFO-A audio is attenuated in the right ear.

**COMBINE2:** Audio from both VFO-A and VFO-B receivers is combined and heard equally in both ears.

## RX GNRL GROUP

### 109 RGEN IF OUT

**Function:** Enables/Disables the 9 MHz RX IF signal from the rear panel **IF OUT** jack.

**Available Values:** DISABLE / ENABLE

**Default Setting:** DISABLE

### 110 RGEN MNB LVL

**Function:** Adjusts the noise blanking level of the VFO-A IF noise Blanker.

**Available Values:** 0 ~ 100

**Default Setting:** 50

### 111 RGEN MNB WDTN

**Function:** Adjusts the bandwidth for the longer-duration pulse noise of the VFO-A IF noise Blanker.

**Available Values:** 0 ~ 100

**Default Setting:** 50



## RX DSP GROUP

### 112 RDSP CNTR LV

**Function:** Adjusts the gain of the Contour filter.

**Available Values:** -40 ~ 20 dB

**Default Setting:** -15 dB

### 113 RDSP CNTR WI

**Function:** Adjusts the Q-factor of the Contour filter.

**Available Values:** 1 ~ 11

**Default Setting:** 10

### 114 RDSP NOTCH WI

**Function:** Selects the bandwidth of the DSP NOTCH filter

**Available Values:** NARROW / WIDE

**Default Setting:** WIDE

### 115 RDSP HCW SHP

**Function:** Selects the passband characteristics of the DSP filter for the CW mode on the HF band.

**Available Values:** SOFT / SHARP

**Default Setting:** SHARP

SOFT: Primary importance is attached to the phase of the filter factor.

SHARP: Primary importance is attached to the amplitude of the filter factor.

### 116 RDSP HCW SLP

**Function:** Selects the shape factor of the DSP filter for the CW mode on the HF band.

**Available Values:** STEEP / MEDIUM / GENTLE

**Default Setting:** MEDIUM

### 117 RDSP HPKT SHP

**Function:** Selects the passband characteristics of the DSP filter for the PKT mode on the HF band.

**Available Values:** SOFT / SHARP

**Default Setting:** SHARP

SOFT: Primary importance is attached to the phase of the filter factor.

SHARP: Primary importance is attached to the amplitude of the filter factor.

### 118 RDSP HPKT SLP

**Function:** Selects the shape factor of the DSP filter for the PKT mode on the HF band.

**Available Values:** STEEP / MEDIUM / GENTLE

**Default Setting:** MEDIUM

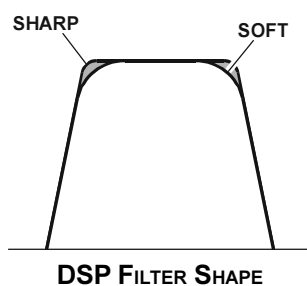

### 119 RDSP HRTY SHP

**Function:** Selects the passband characteristics of the DSP filter for the RTTY mode on the HF band.

**Available Values:** SOFT / SHARP

**Default Setting:** SHARP

SOFT: Primary importance is attached to the phase of the filter factor.

SHARP: Primary importance is attached to the amplitude of the filter factor.

### 120 RDSP HRTY SLP

**Function:** Selects the shape factor of the DSP filter for the RTTY mode on the HF band.

**Available Values:** STEEP / MEDIUM / GENTLE

**Default Setting:** MEDIUM

### 121 RDSP HSSB SHP

**Function:** Selects the passband characteristics of the DSP filter for the SSB mode on the HF band.

**Available Values:** SOFT / SHARP

**Default Setting:** SHARP

SOFT: Primary importance is attached to the phase of the filter factor.

SHARP: Primary importance is attached to the amplitude of the filter factor.

### 122 RDSP HSSB SLP

**Function:** Selects the shape factor of the DSP filter for the SSB mode on the HF band.

**Available Values:** STEEP / MEDIUM / GENTLE

**Default Setting:** MEDIUM

### 123 RDSP VCW SHP

**Function:** Selects the passband characteristics of the DSP filter for the CW mode on the 50 MHz band.

**Available Values:** SOFT / SHARP

**Default Setting:** SHARP

SOFT: Primary importance is attached to the phase of the filter factor.

SHARP: Primary importance is attached to the amplitude of the filter factor.

### 124 RDSP VCW SLP

**Function:** Selects the shape factor of the DSP filter for the CW mode on the 50 MHz band.

**Available Values:** STEEP / MEDIUM / GENTLE

**Default Setting:** MEDIUM

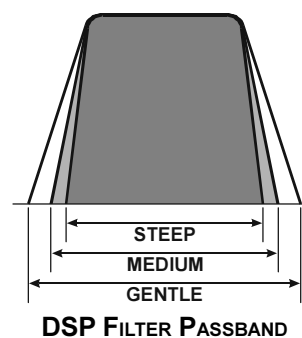

## RX DSP GROUP

### 125 RDSP VPKT SHP

**Function:** Selects the passband characteristics of the DSP filter for the PKT mode on the 50 MHz band.

**Available Values:** SOFT / SHARP

**Default Setting:** SHARP

SOFT: Primary importance is attached to the phase of the filter factor.

SHARP: Primary importance is attached to the amplitude of the filter factor.

### 126 RDSP VPKT SLP

**Function:** Selects the shape factor of the DSP filter for the PKT mode on the 50 MHz band.

**Available Values:** STEEP / MEDIUM / GENTLE

**Default Setting:** MEDIUM

### 127 RDSP VRTY SHP

**Function:** Selects the passband characteristics of the DSP filter for the RTTY mode on the 50 MHz band.

**Available Values:** SOFT / SHARP

**Default Setting:** SHARP

SOFT: Primary importance is attached to the phase of the filter factor.

SHARP: Primary importance is attached to the amplitude of the filter factor.

### 128 RDSP VRTY SLP

**Function:** Selects the shape factor of the DSP filter for the RTTY mode on the 50 MHz band.

**Available Values:** STEEP / MEDIUM / GENTLE

**Default Setting:** MEDIUM

### 129 RDSP VSSB SHP

**Function:** Selects the passband characteristics of the DSP filter for the SSB mode on the 50 MHz band.

**Available Values:** SOFT / SHARP

**Default Setting:** SHARP

SOFT: Primary importance is attached to the phase of the filter factor.

SHARP: Primary importance is attached to the amplitude of the filter factor.

### 130 RDSP VSSB SLP

**Function:** Selects the shape factor of the DSP filter for the SSB mode on the 50 MHz band.

**Available Values:** STEEP / MEDIUM / GENTLE

**Default Setting:** MEDIUM

## SCOPE GROUP

### **ADVICE:**

This group's adjustment has no effect, if the optional **DMU-2000** Data Management Unit is not connected.

### 131 SCP 1.8 FIX

**Function:** Selects the scan start frequency of the FIX mode Spectrum Scope while monitoring on the 160 m amateur band.

**Available Values:** 1800kHz ~ 1999kHz (1 kHz/step)

**Default Setting:** 1800kHz

### 132 SCP 3.5 FIX

**Function:** Selects the scan start frequency of the FIX mode Spectrum Scope while monitoring on the 80 m amateur band.

**Available Values:** 3500kHz ~ 3999kHz (1 kHz/step)

**Default Setting:** 3500kHz

### 133 SCP 5.0 FIX

**Function:** Selects the scan start frequency of the FIX mode Spectrum Scope while monitoring on the 60 m amateur band.

**Available Values:** 5250kHz ~ 5499kHz (1 kHz/step)

**Default Setting:** 5250kHz

### 134 SCP 7.0 FIX

**Function:** Selects the scan start frequency of the FIX mode Spectrum Scope while monitoring on the 40 m amateur band.

**Available Values:** 7000kHz ~ 7299kHz (1 kHz/step)

**Default Setting:** 7000kHz

### 135 SCP 10.1 FIX

**Function:** Selects the scan start frequency of the FIX mode Spectrum Scope while monitoring on the 30 m amateur band.

**Available Values:** 10100kHz ~ 10149 kHz (1 kHz steps)

**Default Setting:** 10100kHz

---

---

## SCOPE GROUP

---

---

### 136 SCP 14.0 FIX

**Function:** Selects the scan start frequency of the FIX mode Spectrum Scope while monitoring on the 20 m amateur band.

**Available Values:** 14000kHz ~ 14349kHz (1 kHz/step)

**Default Setting:** 14000kHz

### 137 SCP 18.0 FIX

**Function:** Selects the scan start frequency of the FIX mode Spectrum Scope while monitoring on the 17 m amateur band.

**Available Values:** 18000kHz ~ 18199kHz (1 kHz/step)

**Default Setting:** 18068kHz

### 138 SCP 21.0 FIX

**Function:** Selects the scan start frequency of the FIX mode Spectrum Scope while monitoring on the 15 m amateur band.

**Available Values:** 21000kHz ~ 21449kHz (1 kHz/step)

**Default Setting:** 21000kHz

### 139 SCP 24.8 FIX

**Function:** Selects the scan start frequency of the FIX mode Spectrum Scope while monitoring on the 12 m amateur band.

**Available Values:** 24800kHz ~ 24989kHz (1 kHz/step)

**Default Setting:** 24890kHz

### 140 SCP 28.0 FIX

**Function:** Selects the scan start frequency of the FIX mode Spectrum Scope while monitoring on the 10 m amateur band.

**Available Values:** 28000kHz ~ 29699kHz (1 kHz/step)

**Default Setting:** 28000kHz

### 141 SCP 50.0 FIX

**Function:** Selects the scan start frequency of the FIX mode Spectrum Scope while monitoring on the 6 m amateur band.

**Available Values:** 50000kHz ~ 53999kHz (1 kHz/step)

**Default Setting:** 50000kHz

---

---

## TUNING GROUP

---

---

### 142 TUN DIAL STP

**Function:** Setting of the Tuning Dial knob's tuning speed except the FM and FM-PKT modes.

**Available Values:** 1Hz / 5Hz / 10Hz

**Default Setting:** 10Hz

### 143 TUN CW FINE

**Function:** Enabling/disabling of the "Fine" tuning speed in the CW, RTTY, and PKT-SSB modes.

**Available Values:** DISABLE / ENABLE

**Default Setting:** DISABLE

ENABLE: Tuning in 1 Hz steps on the CW, RTTY, and PKT-SSB modes.

DISABLE: Tuning according to the steps determined via menu item "142 TUN DIAL STP".

### 144 TUN MHz SEL

**Function:** Selects the tuning steps of the [▼(DOWN)] / [▲(UP)] key.

**Available Values:** 1MHz / 100kHz

**Default Setting:** 100kHz

### 145 TUN AM STEP

**Function:** Selects the tuning steps for the microphone's [UP]/[DWN] keys in the AM mode.

**Available Values:** 2.5kHz / 5kHz / 9kHz / 10kHz / 12.5 kHz

**Default Setting:** 5kHz

### 146 TUN FM STEP

**Function:** Selects the tuning steps for the microphone's [UP]/[DWN] keys in the FM and FM-PKT modes.

**Available Values:** 5kHz / 6.25kHz / 10kHz / 12.5kHz / 20kHz / 25kHz

**Default Setting:** 5kHz

### 147 TUN AM D.LCK

**Function:** Select whether the Main Tuning Dial knob and [CLAR(VFO-B)] knob shall be "Enabled" or "Disabled" on the AM mode.

**Available Values:** DISABLE / ENABLE

**Default Setting:** DISABLE

### 148 TUN FM D.LCK

**Function:** Select whether the Main Tuning Dial knob and [CLAR(VFO-B)] knob shall be "Enabled" or "Disabled" on the FM mode.

**Available Values:** DISABLE / ENABLE

**Default Setting:** DISABLE

### 149 TUN FM DIAL

**Function:** Setting of the Tuning Dial knob's tuning speed in the FM mode.

**Available Values:** 10Hz / 100Hz

**Default Setting:** 100Hz

## TUNING GROUP

### 150 TUN MY BAND

**Function:** Programs a band to be skipped while selecting bands using the [CLAR(VFO-B)] knob.

**Available Values:** 1.8M ~ 50M / GEN / T14M / T28M / T50M

**Default Setting:** 1.8M ~ 50M / GEN: ON, T14M / T28M / T50M: OFF

To program the band to be skipped, rotate the (VFO-B)[SELECT] knob to recall the band to be skipped while selecting bands via the [CLAR(VFO-B)] knob, then press the [ENT] key (one of the [BAND] buttons) to change this setting to "OFF". Repeat the same procedures to cancel the setting (change the "OFF" notation to "ON").

## TX AUDIO GROUP

### 151 TAUD EQ1 FRQ

**Function:** Selects the center frequency of the lower range for the parametric microphone equalizer.

**Available Values:** OFF / 100Hz ~ 700Hz (100 Hz/step)

**Default Setting:** OFF

OFF: The equalizer gain and Q-factor are set to factory defaults (flat).

100Hz ~ 700Hz: Center frequencies of 100 Hz ~ 700 Hz. You may adjust the equalizer gain and Q-factor at this selected audio frequency via menu items "152 TAUD EQ1 LVL" and "153 TAUD EQ1 BW".

### 152 TAUD EQ1 LVL

**Function:** Adjusts the equalizer gain of the low range of the parametric microphone equalizer.

**Available Values:** -20 ~ 10

**Default Setting:** 5

### 153 TAUD EQ1 BW

**Function:** Adjusts the Q-factor of the low range of the parametric microphone equalizer.

**Available Values:** 1 ~ 10

**Default Setting:** 10

### 154 TAUD EQ2 FRQ

**Function:** Selects the center frequency of the middle range for the parametric microphone equalizer.

**Available Values:** OFF / 700Hz ~ 1500Hz (100 Hz/step)

**Default Setting:** OFF

OFF: The equalizer gain and Q-factor are set to factory defaults (flat).

700Hz ~ 1500Hz: Center frequencies of 700 Hz ~ 1500 Hz. You may adjust the equalizer gain and Q-factor at this selected audio frequency via menu items "155 TAUD EQ2 LVL" and "156 TAUD EQ2 BW".

### 155 TAUD EQ2 LVL

**Function:** Adjusts the equalizer gain of the middle range of the parametric microphone equalizer.

**Available Values:** -20 ~ 10

**Default Setting:** 5

### 156 TAUD EQ2 BW

**Function:** Adjusts the Q-factor of the middle range of the parametric microphone equalizer.

**Available Values:** 1 ~ 10

**Default Setting:** 10

## TX AUDIO GROUP

### **157 TAUD EQ3 FRQ**

**Function:** Selects the center frequency of the high range for the parametric microphone equalizer.

**Available Values:** OFF / 1500Hz ~ 3200Hz (100 Hz/step)

**Default Setting:** OFF

OFF: The equalizer gain and Q-factor are set to factory defaults (flat).

1500Hz ~ 3200Hz: Center frequencies of 1500 Hz ~ 3200 Hz. You may adjust the equalizer gain and Q-factor in this selected audio frequency via menu items “158 TAUD EQ3 LVL” and “159 TAUD EQ3 BW”.

### **158 TAUD EQ3 LVL**

**Function:** Adjusts the equalizer gain of the high range of the parametric microphone equalizer.

**Available Values:** -20 ~ 10

**Default Setting:** 5

### **159 TAUD EQ3 BW**

**Function:** Adjusts the Q-factor of the high range of the parametric microphone equalizer.

**Available Values:** 1 ~ 10

**Default Setting:** 10

### **160 TAUD PE1 FRQ**

**Function:** Selects the center frequency of the lower range for the parametric microphone equalizer when the speech processor is activated.

**Available Values:** OFF / 100Hz ~ 700Hz (100 Hz/step)

**Default Setting:** 200Hz

OFF: The equalizer gain and Q-factor are set to factory defaults (flat).

100Hz ~ 700Hz: Center frequencies of 100 Hz ~ 700 Hz. You may adjust the equalizer gain and Q-factor at this selected audio frequency via menu items “161 TAUD PE1 LVL” and “162 TAUD PE1 BW”.

### **161 TAUD PE1 LVL**

**Function:** Adjusts the equalizer gain of the low range of the parametric microphone equalizer when the speech processor is activated.

**Available Values:** -20 ~ 10

**Default Setting:** 0

### **162 TAUD PE1 BW**

**Function:** Adjusts the Q-factor of the low range of the parametric microphone equalizer when the speech processor is activated.

**Available Values:** 1 ~ 10

**Default Setting:** 2

### **163 TAUD PE2 FRQ**

**Function:** Selects the center frequency of the middle range for the parametric microphone equalizer when the speech processor is activated.

**Available Values:** OFF / 700Hz ~ 1500Hz (100 Hz/step)

**Default Setting:** 800Hz

OFF: The equalizer gain and Q-factor are set to factory defaults (flat).

700Hz ~ 1500Hz: Center frequencies of 700 Hz ~ 1500 Hz. You may adjust the equalizer gain and Q-factor at this selected audio frequency via menu items “164 TAUD PE2 LVL” and “165 TAUD PE2 BW”.

### **164 TAUD PE2 LVL**

**Function:** Adjusts the equalizer gain of the middle range of the parametric microphone equalizer when the speech processor is activated.

**Available Values:** -20 ~ 10

**Default Setting:** 0

### **165 TAUD PE2 BW**

**Function:** Adjusts the Q-factor of the middle range of the parametric microphone equalizer when the speech processor is activated.

**Available Values:** 1 ~ 10

**Default Setting:** 1

### **166 TAUD PE3 FRQ**

**Function:** Selects the center frequency of the high range for the parametric microphone equalizer when the speech processor is activated.

**Available Values:** OFF / 1500Hz ~ 3200Hz (100 Hz/step)

**Default Setting:** 2100Hz

OFF: The equalizer gain and Q-factor are set to factory defaults (flat).

1500Hz ~ 3200Hz: Center frequencies of 1500 Hz ~ 3200 Hz. You may adjust the equalizer gain and Q-factor in this selected audio frequency via menu items “167 TAUD PE3 LVL” and “168 TAUD PE3 BW”.

### **167 TAUD PE3 LVL**

**Function:** Adjusts the equalizer gain of the high range of the parametric microphone equalizer when the speech processor is activated.

**Available Values:** -20 ~ 10

**Default Setting:** 0

### **168 TAUD PE3 BW**

**Function:** Adjusts the Q-factor of the high range of the parametric microphone equalizer when the speech processor is activated.

**Available Values:** 1 ~ 10

**Default Setting:** 1

---

---

## TX GNRL GROUP

---

---

### **169 TGEN BIAS**

**Function:** Adjusts the Bias level of the Final Amplifier while in “Class-A” operation.

**Available Values:** 1 ~ 100

**Default Setting:** 100

### **170 TGEN MAX PWR**

**Function:** Selects a maximum output power limit.

**Available Values:** 20W / 50W / 100W / 200W

**Default Setting:** 200W

### **171 TGEN PWR CTRL**

**Function:** Configures the [RF PWR] knob.

**Available Values:** ALL MODE / CARRIER

**Default Setting:** ALL MODE

ALL MODE: The [RF PWR] knob is enabled on all modes.

CARRIER: The [RF PWR] knob is enabled in all modes except SSB. In this configuration, the SSB output power will be set to maximum, regardless of the [RF PWR] knob’s position.

### **172 TGEN ETX-GND**

**Function:** Enables/Disables the TX GND jack on the rear panel.

**Available Values:** DISABLE / ENABLE

**Default Setting:** DISABLE

### **173 TGEN TUN PWR**

**Function:** Selects a maximum output power limit for driving the input circuit of an external linear RF amplifier while tuning (while using the Remote Control function of the linear RF amplifier).

**Available Values:** 20W / 50W / 100W / 200W

**Default Setting:** 100W

### **174 TGEN VOX SEL**

**Function:** Selects the audio input source for triggering TX during VOX operation.

**Available Values:** MIC / DATA

**Default Setting:** MIC

MIC: The VOX function will be activated by microphone audio input.

DATA: The VOX function will be activated by data audio input.

### **175 TGEN ANTI VOX**

**Function:** Adjusts the Anti-VOX Trip Gain, which is the level of negative AF feedback of receiver audio to the microphone, to prevent receiver audio from activating the transmitter (via the microphone) during VOX operation.

**Available Values:** 1 ~ 100

**Default Setting:** 100

### **176 TGEN EMRGNCY**

**Function:** Enables Tx/Rx operation on the Alaska Emergency Channel, 5167.5 kHz.

**Available Values:** DISABLE / ENABLE

**Default Setting:** DISABLE

When this Menu Item is set to “ENABLE”, the spot frequency of 5167.5 kHz will be enabled. The Alaska Emergency Channel will be found between the Memory channels “P-1” and “01 (or 1-01)”.

**IMPORTANT:**

The use of this frequency is restricted to stations operating in or near Alaska, and only for emergency purposes (never for routine operations). See §97.401(c) of the FCC’s regulations for details.

---

---

**NOTE**

---

---

# SPECIFICATIONS

## GENERAL

<b>Rx Frequency Range:</b>	30 kHz - 60 MHz (operating)* 1.8 - 29.7 MHz, 50 - 54 MHz (specified performance, Amateur bands only)*
<b>Tx Frequency Ranges:</b>	1.8 - 29.7 MHz, 50 - 54 MHz (Amateur bands only) 5.16750MHz, 5.33200MHz, 5.34800MHz, 5.36800MHz, 5.37300MHz, 5.40500MHz (USA version only) 135.7 - 137.8kHz, 5.26000MHz, 5.28000MHz, 5.29000 MHz, 5.36800MHz, 5.37300MHz, 5.40000MHz, 5.40500MHz (UK version only)
<b>Frequency Stability:</b>	±0.05 ppm (MP version, after 1 minute @+14 °F ~ +140 °F [-10 °C ~ +60 °C]) ±0.5 ppm (after 1 minute @+14 °F ~ +140 °F [-10 °C ~ +60 °C])
<b>Operating Temperature Range:</b>	+14 °F ~ +140 °F (-10 °C ~ +60 °C)
<b>Emission Modes:</b>	A1A (CW), A3E (AM), J3E (LSB, USB), F3E (FM), F1B (RTTY), F1D (PACKET), F2D (PACKET)
<b>Frequency Steps:</b>	1/5/10 Hz (SSB,CW, & AM), 100 Hz (FM)
<b>Antenna Impedance:</b>	50 Ohms, unbalanced 16.7 - 150 Ohms, unbalanced (Tuner ON, 1.8 - 29.7 MHz Amateur bands) 25 - 100 Ohms, unbalanced (Tuner ON, 50 MHz Amateur band)
<b>Power Consumption:</b> (@117 VAC)	Rx (no signal) 70 VA Rx (signal present) 80 VA Tx (200 W) 720 VA
<b>Supply Voltage:</b>	AC 100 - 240 V (±10 %)
<b>Dimensions (WxHxD):</b>	18.2" x 5.3" x 15.3" (462 x 135 x 389 mm) w/o knob and connector
<b>Weight (approx.):</b>	46.3 lbs (21 kg)

## TRANSMITTER

<b>Power Output:</b>	10 - 200 watts (CW, LSB, USB, FM, RTTY, PKT) 5 - 50 watts (AM carrier) 10 - 75 watts (Class A: LSB, USB) +10 dBm (135.7 - 137.8kHz: TRV Jack, CW, UK version only)
<b>Modulation Types:</b>	J3E (SSB): Balanced, A3E (AM): Low-Level (Early Stage) F3E (FM): Variable Reactance
<b>Maximum FM Deviation:</b>	±5.0 kHz/±2.5 kHz
<b>Harmonic Radiation:</b>	Better than -60 dB (1.8 - 50 MHz Amateur bands)
<b>SSB Carrier Suppression:</b>	At least 60 dB below peak output
<b>Undesired Sideband Suppression:</b>	At least 60 dB below peak output
<b>Audio Response (SSB):</b>	Not more than -6 dB from 300 to 2700 Hz
<b>3rd-order IMD:</b>	-31 dB @14 MHz, 200 watts PEP -40 dB @14 MHz, Class A: 75 watts PEP
<b>Bandwidth:</b>	500 Hz (CW) 3.0 kHz (LSB, USB) 6.0 kHz (AM) 16 kHz (FM)
<b>Microphone Impedance:</b>	600 Ohms (200 to 10 k Ohms)



## RECEIVER

<b>Circuit Type:</b>	VFO-A; Double-conversion superheterodyne VFO-B; Triple-conversion superheterodyne															
<b>Intermediate Frequencies:</b>	VFO-A; 9 MHz /30 kHz (24 kHz for AM/FM) VFO-B; 40.455 MHz/455 kHz /30 kHz (24 kHz for AM/FM)															
<b>Sensitivity:</b>	SSB (2.4 kHz, 10 dB S+N/N) 2 $\mu$ V (0.5 - 1.8 MHz, IPO1) 0.2 $\mu$ V (1.8 - 30 MHz, AMP2)* 0.125 $\mu$ V (50 - 54 MHz, AMP2) AM (6 kHz, 10 dB S+N/N, 30 % modulation @400 Hz) 6 $\mu$ V (0.5 - 1.8 MHz, IPO1) 2 $\mu$ V (1.8 - 30 MHz, AMP2)* 1 $\mu$ V (50 - 54 MHz, AMP2) FM (BW: 15 kHz, 12 dB SINAD) 0.5 $\mu$ V (28 - 30 MHz, AMP2) 0.35 $\mu$ V (50 - 54 MHz, AMP2) There is no specification in frequency ranges not listed.															
<b>Squelch Sensitivity (AMP2):</b>	SSB/CW/AM 2 $\mu$ V (0.1 - 30 MHz) 2 $\mu$ V (50 - 54 MHz) FM 1 $\mu$ V (28 - 30 MHz) 1 $\mu$ V (50 - 54 MHz) There is no specification in frequency ranges not listed.															
<b>Selectivity (-6/-60 dB):</b>	<table><thead><tr><th>Mode</th><th>-6 dB</th><th>-60 dB</th></tr></thead><tbody><tr><td>CW</td><td>0.5 kHz or better</td><td>750 Hz or less</td></tr><tr><td>LSB, USB</td><td>2.4 kHz or better</td><td>3.6 kHz or less</td></tr><tr><td>AM</td><td>6 kHz or better</td><td>15 kHz or less</td></tr><tr><td>FM</td><td>12 kHz or better</td><td>30 kHz or less</td></tr></tbody></table>	Mode	-6 dB	-60 dB	CW	0.5 kHz or better	750 Hz or less	LSB, USB	2.4 kHz or better	3.6 kHz or less	AM	6 kHz or better	15 kHz or less	FM	12 kHz or better	30 kHz or less
Mode	-6 dB	-60 dB														
CW	0.5 kHz or better	750 Hz or less														
LSB, USB	2.4 kHz or better	3.6 kHz or less														
AM	6 kHz or better	15 kHz or less														
FM	12 kHz or better	30 kHz or less														
<b>Image Rejection:</b>	70 dB or better (1.8 - 29.7 MHz Amateur bands, VRF: ON) 60 dB or better (50 MHz Amateur band)															
<b>Maximum Audio Output:</b>	2.5 W into 4 Ohms with 10% THD															
<b>Audio Output Impedance:</b>	4 to 8 Ohms (4 Ohms: nominal)															
<b>Conducted Radiation:</b>	Less than 4000 $\mu$ W (-47 dBm $\leq$ 1000 MHz, -57 dBm $>$ 1000 MHz)															

\*: Except the 9 MHz.

*Specifications are subject to change, in the interest of technical improvement, without notice or obligation, and are guaranteed only within the amateur bands.*

# INSTALLATION OF THE OPTIONAL ROOFING FILTER (XF-126CN)

1. Turn the front panel **[POWER]** switch “off,” then turn the rear panel’s **[POWER]** switch “off.”
2. Disconnect all the cables from the transceiver.
3. Referring to Figure 1, remove the three screws from each side of the transceiver and four screws from the top of the transceiver, then remove the top cover.
4. Refer to Figure 2, there is the metal plate on the right side of the transceiver. A mounting position of the optional filter is inside of this. Remove the three screws affixing the metal plate, then remove the metal plate.
5. Refer to Figure 3, position the filter so that its connectors are aligned with the mounting pins on the board, and push it into place.
6. Replace the metal plate and its three screws.
7. Replace the top cover and its ten screws.
8. Filter installation is now complete.
9. Connect the all cables to the transceiver.

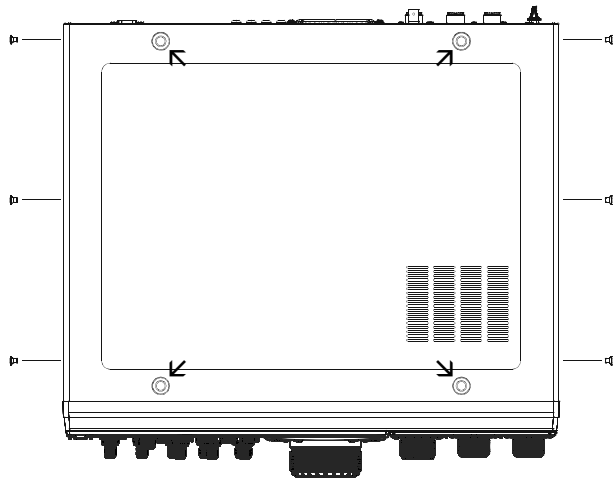

**FIGURE 1**

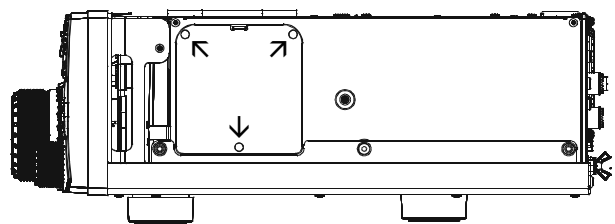

**FIGURE 2**

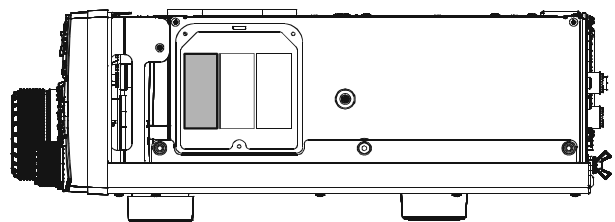

**FIGURE 3**



# INDEX

## A

A Switch .....	22
A◀B Switch .....	24, 83
A▶B Switch .....	24,
A▶M Switch .....	24, 102
Accessory .....	4
AF GAIN Knob .....	21, 38
AFSK Operation .....	112
AGC Switch .....	19, 67
Alaska Emergency Frequency .....	106
All Reset .....	7
AM Operation .....	70
APF .....	27, 29, 92
ATT Switch .....	18, 52
ATU .....	72
Audio Peak Filter .....	27, 29, 92
Audio Playback .....	45
Automatic Antenna Tuner .....	72

## B

B Switch .....	22
Band Stack .....	47
Basic Operation .....	37
Beacon .....	95
BK-IN Switch .....	25, 86, 88

## C

Clarifier .....	40
Class-A Operation .....	78
Connector Pinout .....	15
CONT Switch .....	27, 29, 58
Contest Memory Keyer .....	94
Contest Number .....	97
CONTOUR .....	58
Custom Switch .....	47
CW Delay Time .....	93
CW Operation .....	86
CW Pitch .....	93
CW Reverse .....	92
CW Spotting .....	91

## D

Digital Noise Reduction .....	64
Digital Notch Filter .....	64
DIM Switch .....	6, 41
DNF Switch .....	28, 29, 64
DNR Switch .....	28, 29, 64
Dual Receive .....	42

## E

Electronic Keyer .....	88
Erasing Memory .....	103

## F

FCC Notice .....	144
FM Operation .....	98
Full Break-in .....	87, 89
Full Reset .....	7

## I

IF SHIFT .....	27, 28, 60
Installation .....	8
Installation of Option .....	140
Intercept Point Optimization .....	18, 51
IPO Switch .....	18, 51

## K

KEYER Switch .....	25, 88
Keyer Weight Ratio .....	90

## L

LOCK Switch .....	23, 41
-------------------	--------

## M

M▶A Switch .....	24, 104
Memory Check .....	103
Memory Group .....	105
Memory Recall .....	102
Memory Reset .....	7
Memory Scan .....	108
Memory Storage .....	102
Memory Tune .....	104
Menu Mode .....	116
Menu Reset .....	7
Message Memory .....	94
METER Knob .....	19
MIC .....	20, 70
MONI Knob .....	19, 81
MONI Switch .....	17, 81
Moving Memory .....	104
MOX Switch .....	17
Mute .....	69
My Band .....	46

## N

NAR Switch .....	29, 65
NARROW .....	65
NB Knob .....	19, 66
NB Switch .....	25, 66
Noise Blanker .....	25, 66
NOTCH Filter .....	28, 29, 63

## O

Option .....	4
--------------	---

## P

P.BACK .....	45
Packet Operation .....	110
Parametric Microphone Equalizer .....	74
Plug Pinout .....	15
PMS .....	109
POWER Switch .....	16, 38
PROC Knob .....	19, 76
PROC Switch .....	17, 76
Programmable Memory Scan .....	109

## Q

QMB .....	22, 101
Quick Memory Bank .....	101
Quick Split .....	85

## R

RCL Switch .....	22, 101
Repeater Operation .....	99
Reset .....	7
RF GAIN Knob .....	21, 53
RF PWR Knob .....	20, 71
Roofing Filter .....	18, 56
Rotator Control .....	48
RTTY Operation .....	111
RX ANT .....	17, 39

## S

Scan .....	107
Semi Break-in .....	87
SHIFT Switch .....	27, 28, 60
Sloped AGC .....	68
Specification .....	138
Speech Processor .....	76
Split Operation .....	82
SQL .....	19, 39
SSB Operation .....	70
SSB Transmit Bandwidth .....	77
STO Switch .....	22, 101
SUB DISPLAY .....	25, 26, 28

## T

Text Memory .....	96
TUNE Switch .....	17, 72
TX Clarifier .....	82
TXW Switch .....	23, 83

## V

V/M Switch .....	24, 101
VFO Scan .....	107
VFO Tracking Feature .....	83
Voice Memory .....	80
VOX Switch .....	17, 81
VRF Switch .....	27, 28, 54

## W

WIDTH Switch .....	28, 29, 61
--------------------	------------

This equipment has been tested and found to comply with the limits for a Class B digital device, pursuant to Part 15 of the FCC Rules. These limits are designed to provide reasonable protection against harmful interference in a residential installation. This equipment generates, uses and can radiate radio frequency energy and, if not installed and used in accordance with the instructions, may cause harmful interference to radio communications. However, there is no guarantee that interference will not occur in a particular installation.

If this equipment does cause harmful interference to radio or television reception, which can be determined by turning the equipment off and on, the user is encouraged to try to correct the interference by one or more of the following measures:

- Reorient or relocate the receiving antenna.
- Increase the separation between the equipment and receiver.
- Connect the equipment into an outlet on a circuit different from that to which the receiver is connected.
- Consult the dealer or an experienced radio/TV technician for help.

1. Changes or modifications to this device not expressly approved by VERTEX STANDARD could void the user's authorization to operate this device.
2. This device complies with part 15 of the FCC Rules. Operation is subject to the following two conditions; (1) this device may not cause harmful interference, and (2) this device must accept any interference including interference that may cause undesired operation.
3. The scanning receiver in this equipment is incapable of tuning, or readily being altered, by the User to operate within the frequency bands allocated to the Domestic public Cellular Telecommunications Service in Part 22.

#### DECLARATION BY MANUFACTURER

The scanner receiver is not a digital scanner and is incapable of being converted or modified to a digital scanner receiver by any user.

**WARNING: MODIFICATION OF THIS DEVICE TO RECEIVE CELLULAR RADIOTELEPHONE SERVICE SIGNALS IS PROHIBITED UNDER FCC RULES AND FEDERAL LAW.**

This Class B digital apparatus complies with Canadian ICES-003.



## ***Declaration of Conformity***

We, YAESU UK LTD. declare under our sole responsibility that the following equipment complies with the essential requirements of the Directive 1999/5/EC.

Type of Equipment:	HF Transceiver
Brand Name:	YAESU
Model Number:	FT DX 5000, FT DX 5000D, FT DX 5000MP
Manufacturer:	Vertex Standard Co., Ltd.
Address of Manufacturer:	4-8-8 Nakameguro Meguro-Ku, Tokyo 153-8644, Japan

### Applicable Standards:

This equipment is tested and conforms to the essential requirements of directive, as included in following standards.

Radio Standard:	EN 301 783-2 V1.1.1
EMC Standard:	EN 301 489-1 V1.8.1 EN 301 489-15 V1.2.1
Safety Standard:	EN 60950-1: 2006 +A11: 2009

The technical documentation as required by the Conformity Assessment procedures is kept at the following address:

Company: YAESU UK LTD.  
Address: Unit 12, Sun Valley Business Park, Winnall Close  
Winchester, Hampshire, SO23 0LB, U.K.

### **Attention in case of use**

This transceiver works on frequencies which are not generally permitted. As for the actual usage, the user has to possess an amateur radio licence. Usage is allowed only in the frequency bands which are allocated for amateur radios.

List of the practicable area						
AUT	BEL	BGR	CYP	CZE	DEU	DNK
ESP	EST	FIN	FRA	GBR	GRC	HUN
IRL	ITA	LTU	LUX	LVA	MLT	NLD
POL	PRT	ROM	SVK	SVN	SWE	CHE
ISL	LIE	NOR				

### **Disposal of your Electronic and Electric Equipment**

Products with the symbol (crossed-out wheeled bin) cannot be disposed as household waste.

Electronic and Electric Equipment should be recycled at a facility capable of handling these items and their waste byproducts.

In EU countries, please contact your local equipment supplier representative or service center for information about the waste collection system in your country.

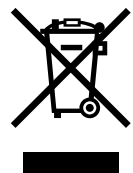

# YAESU

Copyright 2011  
VERTEX STANDARD CO., LTD.  
All rights reserved

No portion of this manual  
may be reproduced without  
the permission of  
VERTEX STANDARD CO., LTD.

Printed in Japan

