

# INSTRUCTION MANUAL

## FT<sub>DX</sub>400

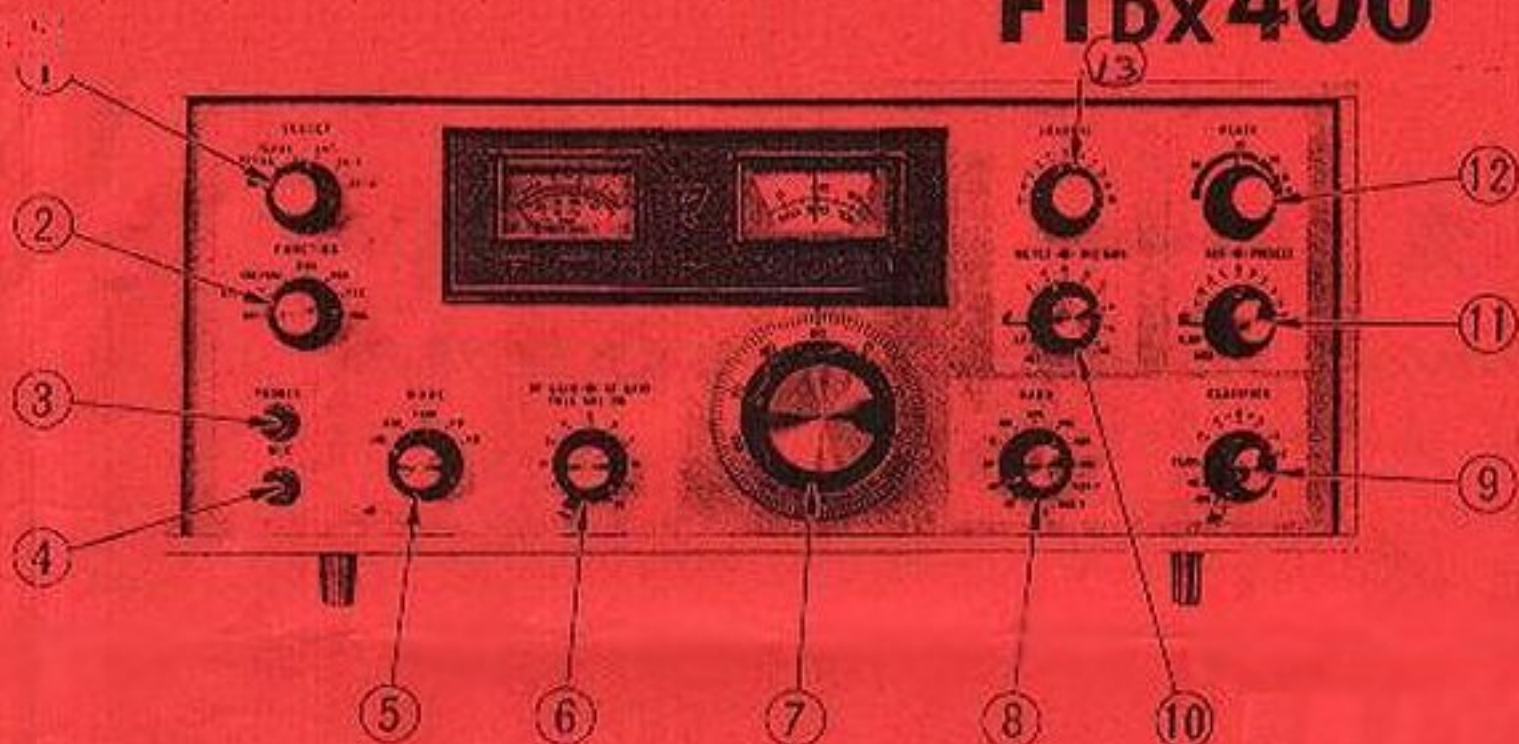

### 1. SELECT

INT: Operating frequency is controlled by main tuning dial.  
 RX-EXT: Receiving frequency is controlled by external VFO.  
 TX-EXT: Transmitting frequency is controlled by external VFO.  
 EXT: Operating frequency is controlled by external VFO.  
 CH-1 And CH-2: Crystal controlled operation.

### 2. FUNCTION

OFF: Transceiver off.  
 STBY: All voltages are applied to the transceiver.  
 CAL 100 KHz: 100 KHz calibrator on.  
 CAL 25 KHz: 25 KHz multivibrator on.  
 MOX: Manual Operation.  
 PTT: Push to Talk.  
 VOX: Voice operation.

### 3. HEADPHONE JACK

### 4. MICROPHONE JACK

### 5. MODE

USB/LSB: Side Band selection.  
 TUNE: Use for transmitter tune-up.  
 CW: Code operation.  
 AM: Carrier and one sideband.

### 6. RF GAIN

Controls the gain of RF and IF stages.

### 6. AF GAIN

Varies the gain of receiver audio amplifier, and automatic noise limiter is connected at pull position.

### 7. MAIN TUNING

Controls operating frequency.

### 8. BAND

Selects operating band.

### 9. CLARIFIER

Varies the VFO frequency slightly for receiver incremental tuning, and is also used as the vernier of main dial.

### 10. METER

Selects the meter to read PA cathode current, relative power output, or plate current of ALC controlled stage.

### 10. MIC GAIN

Controls microphone gain for transmitting, and tone signal input for tune-up.

### 11. AGC

Changes receiver AGC release time.

### 11. PRESELECT

Pretunes signal circuits for both transmit and receive condition.

### 12. PLATE

Tunes the plate circuit of PA tubes.

### 13. LOADING

Tunes the output circuit of PI network.

**CONGRATULATIONS!** You have just purchased one of the finest, high performance transceivers available to the amateur today. To fully appreciate the features, flexibility, and efficient operating procedures available with your new transceiver, we recommend that the instruction manual be studied thoroughly prior to operation.

**GENERAL:**

The FTdx 400/500 Single Sideband Transceiver is a precision built transceiver providing SSB (USB and LSB), CW, and AM modes of operation. This transceiver operates at a maximum input of 560 watts PEP for SSB, 500 watts for CW and 125 watts AM on all bands, 80 through 10 meters.

In addition to the high output power of the transceiver, many features that have previously been considered extra cost options are included as standard equip-

ment on the FTdx 400/500. Standard equipment includes built-in solid state power supply, fully adjustable VOX, break-in CW operation, adjustable CW side tone, additional solid state oscillator for fixed frequency crystal operation, clarifier control provides  $\pm 5$  KHz off-set receiver operation, dual calibration markers at 100 and 25 KHz, phone patch connections, provision for three additional transceive bands outside the amateur bands between 3.5 and 30 MHz, and front panel external VFO solid state switching.

The companion FV401 External VFO allows cross-band DX operation and has the effect of providing the operator with split frequency, separate receiver-transmitter operation.

The FTdx 400/500 has been designed to anticipate the amateur's future operating requirements and will provide many hours of trouble free service.

**SPECIFICATIONS**

Emission Type .....	SSB (USB and LSB selectable) CW, AM
Input Power .....	560 watts PEP maximum, 500 watts CW, 125 watts for AM
Frequency Range .....	3.5-4.0, 7.0-7.5, 14.0-14.5, 21.0-21.5, 28.0-30.0 MHz (3 extra bands can be added)
Frequency Stability .....	After warmup 100 Hz for any 30 min.
Antenna Impedance .....	50 to 120 ohms unbalanced
Carrier Suppression .....	Better than -40 db
Sideband Suppression .....	Better than -50 db at 1000 Hz
Distortion products .....	Better than -25 db
Receiver sensitivity .....	0.5 $\mu$ V S/N 20db at 14 MHz SSB
Selectivity .....	2.3 KHz at -6 db, 3.7 KHz at -60 db
Image rejection .....	50 db
Audio output .....	2 watts
Output impedance .....	8 and 600 ohms
Power requirement .....	AC 117 or 220 volts at 50/60 Hz
Dimensions .....	15 $\frac{3}{4}$ " wide, 6 $\frac{1}{4}$ " high, 13 $\frac{3}{4}$ " deep
Weight .....	approximately (40 lbs.)

## BLOCK DIAGRAM

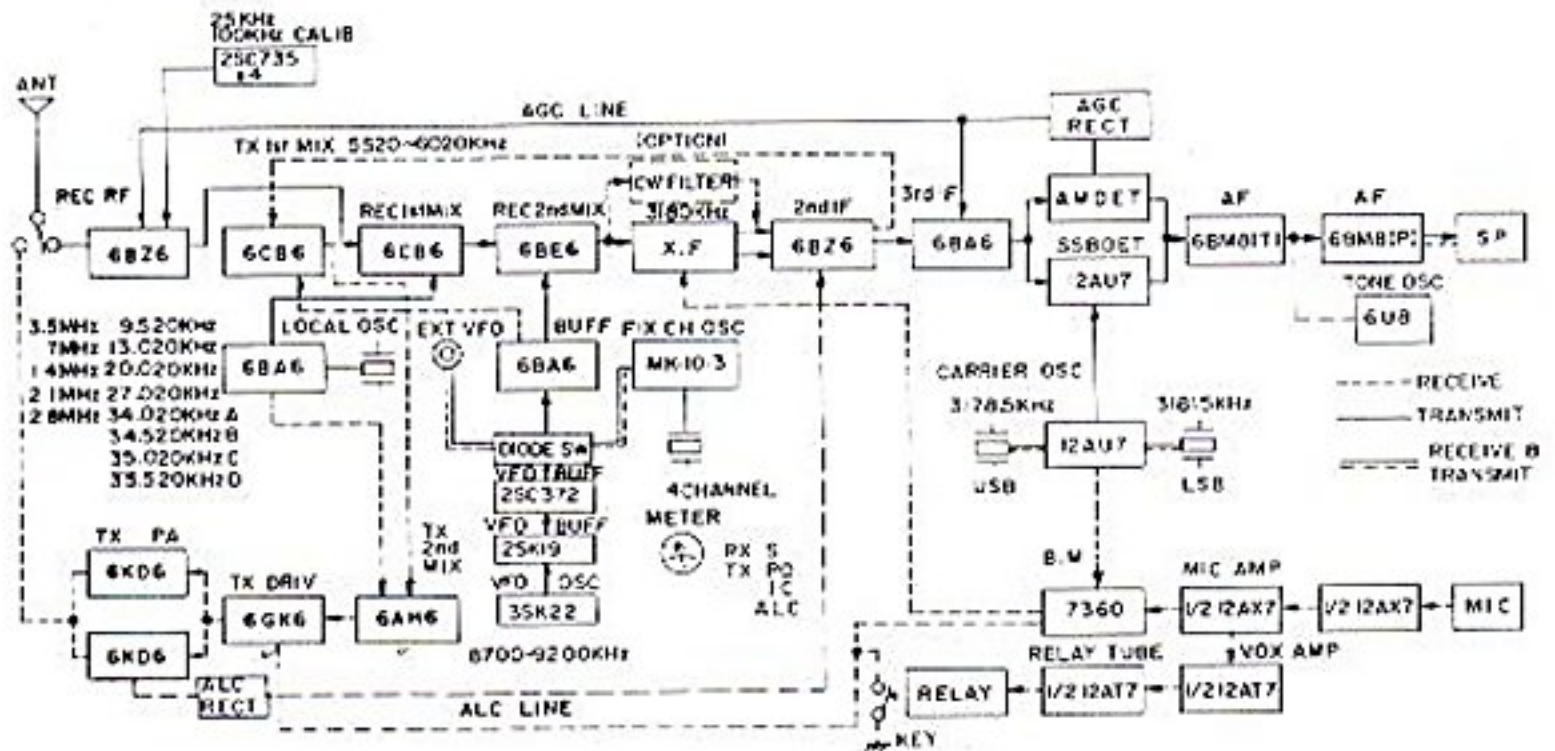

### PRINCIPLES OF OPERATION

The block diagram and the circuit description provides you with a better understanding of this transceiver. The transceiver consists of a double-conversion receiver and a double-conversion exciter-transmitter. Receiver and transmitter circuits use common oscillators, common crystal filter, and common IF stages. The low frequency IF is 3,180 KHz. The high frequency IF is pass band tuned cover 5,520 to 6,020 KHz.

### RECEIVER CIRCUIT:

A signal from the antenna passes through the antenna relay and trap coil, (tuned to 5,770 KHz), then to the tuned circuit and is applied to the grid of the RF amplifier, V1, 6BZ6.

The high frequency oscillator injection signal is also fed to the grid of the first mixer from the local oscillator V2, 6BA6. The product of the first mixer is applied from the plate of the tube to the high IF pass band transformer. Output of this transformer (5,520 to 6,020 KHz) is applied to the grid of the second receiver mixer, V203, 6BE6. When the signal is applied to the grid of V203,

and the VFO injection signal is applied to another grid of the tube, the 3,180 KHz difference product is fed from the V203 plate circuit to the crystal filter. The output from the filter is applied to the grid of the first IF amplifier, V204, 6BZ6. The signal is amplified by V204 and V205 and applied through T205 to the AM detector, AGC rectifier diodes, and the grid of product detector V213, 12AU7.

The beat-frequency oscillator signal which is generated in V206, 12AU7 is applied to the cathode of V213, 12AU7 and the result is the detected audio signal. Output of the AGC rectifier circuit is applied to the grid circuit of the RF amplifier tube and IF amplifier tubes to control the gain of the receiver automatically and prevent overloading. Output from the AM detector or the product detector is applied through MODE switch to the noise limiter circuit by a switch on the front panel. Output from the noise limiter circuit is applied through the AF GAIN control, VR9, to the grid of the first AF amplifier tube, triode section of V210, 6BM8. Amplified audio output of the triode section is couple to the grid of the AF output amplifier, pentode section of V210, which drives the output transformer T1.

## TRANSMITTER CIRCUIT:

The microphone input is connected to the grid of the first microphone amplifier V208A, 12AX7, and then coupled to the grid of the second amplifier, V208B, the other half of the tube. Output from V208B is coupled to the beam deflection electrode of V207, 7360, through the MIC GAIN control, VR-6.

In the TUNE position of the MODE switch, output from the tone oscillator, V212, 6U8, is fed to the grid of the second amplifier. This signal is also fed to the grid of the first receiver A-F amplifier tube, V210, through the AUDIO GAIN control. The carrier signal generated in V206, 12AU7, is fed to the control grid of V207. Output from the balanced modulator V207 coupled to the grid of the IF amplifier, V204, 6BZ6, through the crystal filter, XF-201 of which the passband is centered at 3,180 KHz. This passes either the upper or lower sideband, depending upon the sideband selected when the MODE switch is set to carrier crystal X201 or X202.

The output from the IF amplifier is fed through L204 to the grid of transmitter VFO mixer, V201, 6CB6. The plate circuit of the first mixer is connected to the passband tuning transformer BPF5, and converts the 3,180 KHz sideband signal to a 5,520 to 6,020 KHz single sideband signal. The passband tuning is so designed that it provides excellent spurious reduction. The output signal from the passband network is fed to the grid of the second mixer, V3, 6AH6, and the high frequency injection signal from crystal oscillator, V2, 6BA6 is also fed to the grid of V3. This arrangement converts the IF signal to the desired transmitting frequency. Output from the second mixer is fed through a tuned circuit to the grid of the driver tube, V4, 6GK6 and amplified to a level sufficient to drive the final linear amplifier, V5 and V6, 6KD6s.

Final output from V5 and V6 is fed to a pi-section network consisting of L15 and PLATE and LOAD capacitors. A section of the bandswitch adjusts the inductance of L15 to the correct value for each band, and adds fixed amounts of capacity to the PLATE and LOAD capacitor on the lower bands. Output from the pi-network is fed to the antenna through the contacts of the antenna relay. Both the driver and final stages are neutralized to ensure stability. A section of the band switch selects the capacitors to the correct value for perfect neutralization on each band.

The ALC circuit is placed in the grid circuit of the final tubes. When RF driving voltage to the final tubes becomes sufficient to drive the grids positive, the grids begin to draw current and the signal is detected. This produces an audio envelope. The audio is then rectified by the ALC rectifier, which in turn produces a negative DC voltage. The voltage is filtered by C61, C62, R29 and R30, which also determines the time constant, and controls the gain of V204. The ALC voltage is grounded

by the MODE switch in CW and TUNE positions. This system allows a high average of modulation without increased distortion.

The output voltage from the second microphone amplifier, V208, is coupled through the VOX GAIN control to the grid of V209A, 12AT7, and fed to the VOX rectifier. The positive DC output voltage of the VOX rectifier is applied to the grid of VOX relay amplifier tube, V209B, 12AT7, causing it to conduct current and actuate the VOX relay RL1. The relay tube is so biased that the relay is actuated by the FUNCTION switch in the MOX position. Contacts on the relay switch, -70 volts DC muting and bias voltage, the metering circuit from receive to transmit, the clarifier, antenna relay, and a pin of the remote socket to control external equipment. The FUNCTION switch in the CAL position actuates the antenna relay to disable the receiver RF amplifier tube for easy and clear calibration.

The ANTITRIP circuit provides a threshold voltage to prevent the loud speaker output from tripping the transceiver into the transmit function. The receiver output audio voltage is connected through ANTITRIP control, VR8, to a rectifier. Negative DC output voltage from the ANTITRIP rectifier, connected to the grid of the VOX tube V209B, 12AT7, provides the necessary antitrip threshold. ANTITRIP control VR8 adjusts the value of the antitrip voltage threshold so that the loudspeaker output will not produce too much positive DC output from the VOX rectifier so as to exceed the negative DC output from the antitrip rectifier and cause V209B to actuate the relay. However, the microphone input will cause the positive voltage to overcome the negative voltage and actuate the relay. VR13, located on meter bracket under the top cover provides coarse adjustment for relay tube sensitivity.

Relay hold time will be determined by DELAY control, located on chassis rear apron.

## OSCILLATORS

The transceiver contains six oscillators. They are the carrier oscillator, two high frequency crystal oscillators, the variable frequency oscillator, the tone oscillator, and the crystal calibrator.

### Carrier Oscillator

The carrier oscillator is crystal controlled at either 3,178.5 or 3,181.5 KHz, depending upon whether X201 or X202 is selected by the MODE switch. The MODE switch disconnects the cathode circuit of either tube when not in use. These crystal frequencies are matched to the pass band of the crystal filter, to place the carrier frequency approximately 20db down on the skirt of the filter response. The 3,178.5 KHz crystal frequency is shifted into the filter response range to insert the carrier for AM and CW operation.

## High Frequency Oscillators

One of the high frequency oscillators is used instead of the variable frequency oscillator for crystal controlled operation. A field effect transistor, FET 701, MK-10, is used for the crystal controlled oscillator, and its output is fed to the other VFO buffer, V211, 6BA6, through the SELECT switch. The relation between the operating frequency and the crystal frequency is shown in the table, on page 4. The other oscillator is used to set the desired band. This oscillator, V2, 6BA6, is crystal controlled by one of the 8 crystals selected by the BAND switch. Output from the oscillator is fed to the cathode of the receiver first mixer V202, 6CB6, and the grid of the transmitter second mixer, V3, 6AH6. The output frequency of this oscillator is always 6.020 KHz higher than the lower edge of the selected band. The output signal from this oscillator is the crystal fundamental frequency for 80 and 40 meters, but for higher bands, the crystal frequency is tripled in the plate circuit of the oscillator.

## Variable frequency oscillator

The VFO uses a FET transistor, TR401, 3SK22G, as the oscillator, and TR402, first buffer and TR403 buffer amplifier. The VFO oscillating frequency is 8,700 to 9,200 KHz to provide 500 KHz Band coverage. Varactor diode IS145 is in series with capacitor, C402 and is switched into the circuit by the CLARIFIER select switch and relay contacts to shift the VFO frequency. Output from TR403 is fed through the SELECT switch to VFO buffer tube V211.

## Tone oscillator

The tone oscillator operates when the MODE switch is in CW or TUNE position. It is a phase shift oscillator operating at approximately 800 Hz. The output is fed to the microphone circuit for tuneup of the transmitter. Some of the output from the tone oscillator is applied to the receiver audio amplifier for sidetone monitoring in CW operation.

## Crystal calibrator

The 100 KHz crystal oscillator, TR301, 2SC735 is used for dial calibration. Output from the buffer transistor, TR302 is fed into the 25 KHz multivibrator which generates a marker signal every 25 KHz.

## POWER SUPPLY

The built-in power supply is an all solid state bridge-type, delivering 4 different DC voltages and also AC heater supply for all tubes. The power transformer has two primary windings for operation from either 117 or 220 volt AC supply.

The power amplifier plate voltage (800V DC) is supplied from bridge connected silicon rectifiers. 300 volts DC is delivered to the plates of the other tubes, and 150 volt DC supply is provided through the center tap of the medium voltage supply. Bias is supplied from a half wave rectifier, D513, IS1943. The plate voltage for all oscillator tubes is regulated with a VR-105 MT, stabilizer tube.

FREQUENCY TABLE (KHz)

VFO Frequency	9200	9100	9000	8900	8800	8700	Local Frequency
	3500	3620	3700	3800	3900	4000	9520
	7000	7100	7200	7300	7400	7500	13020
	14000	14100	14200	14300	14400	14500	20020
Operating Frequency	21000	21100	21200	21300	21400	21500	27020
	28000	28100	28200	28300	28400	28500	34020
	28500	28600	28700	28800	28900	29000	34520
	29000	29100	29200	29300	29400	29500	35020
	29500	29600	29700	29800	29900	30000	35520

\* Operating frequency - Carrier frequency + 1.5Kc for USB

Carrier frequency - 1.5Kc for LSB

Xtal frequency for crystal controlled operation is determined by following formula:

X = Local frequency - Operating frequency + 3180Kc

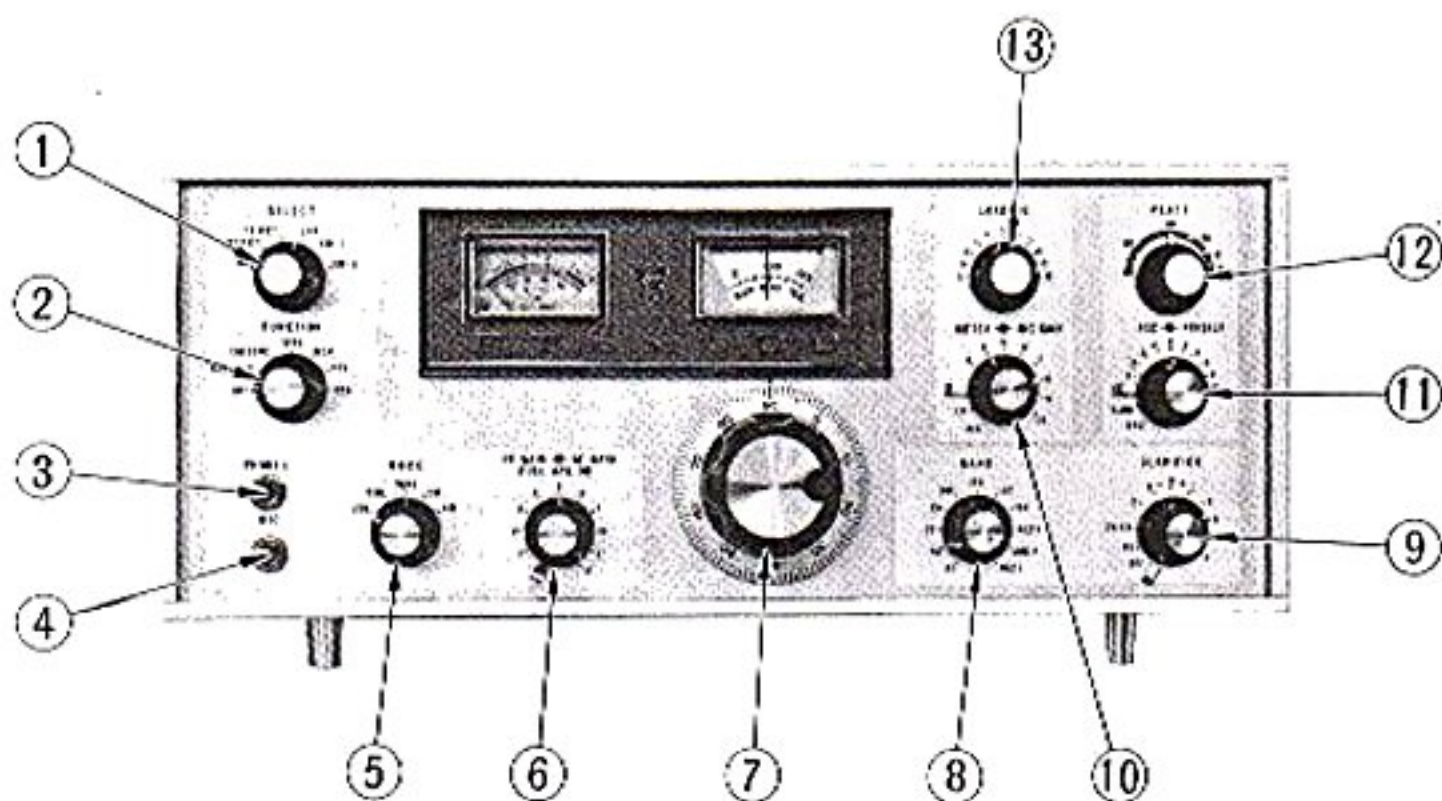

1. SELECT

INT: Operating frequency is controlled by main tuning dial.  
 RX-EXT: Receiving frequency is controlled by external VFO.  
 TX-EXT: Transmitting frequency is controlled by external VFO.  
 EXT: Operating frequency is controlled by external VFO.  
 CH-1 And CH-2: Crystal controlled operation.  
 OFF: Transceiver off.  
 STBY: All voltages are applied to the transceiver.  
 CAL 100 KHz: 100 KHz calibrator on.  
 CAL 25 KHz: 25 KHz multivibrator on.  
 MOX: Manual Operation.  
 PTT: Push to Talk.  
 VOX: Voice operation.

3. HEADPHONE JACK

4. MICROPHONE JACK

5. MODE

USB/LSB: Side Band selection.  
 TUNE: Use for transmitter tune-up.  
 CW: Code operation.  
 AM: Carrier and one sideband.

6. RF GAIN

Controls the gain of RF and IF stages.

6. AF GAIN

Varies the gain of receiver audio amplifier, and automatic noise limiter is connected at pull position.

7. MAIN TUNING

Controls operating frequency.

8. BAND

Selects operating band.

9. CLARIFIER

Varies the VFO frequency slightly for receiver incremental tuning, and is also used as the vernier of main dial.

10. METER

Selects the meter to read PA cathode current, relative power output, or plate current of ALC controlled stage.

10. MIC GAIN

Controls microphone gain for transmitting, and tone signal input for tune-up.

11. AGC

Changes receiver AGC release time.

11. PRESELECT

Pretunes signal circuits for both transmit and receive condition.

12. PLATE

Tunes the plate circuit of PA tubes.

13. LOADING

Tunes the output circuit of PI network.

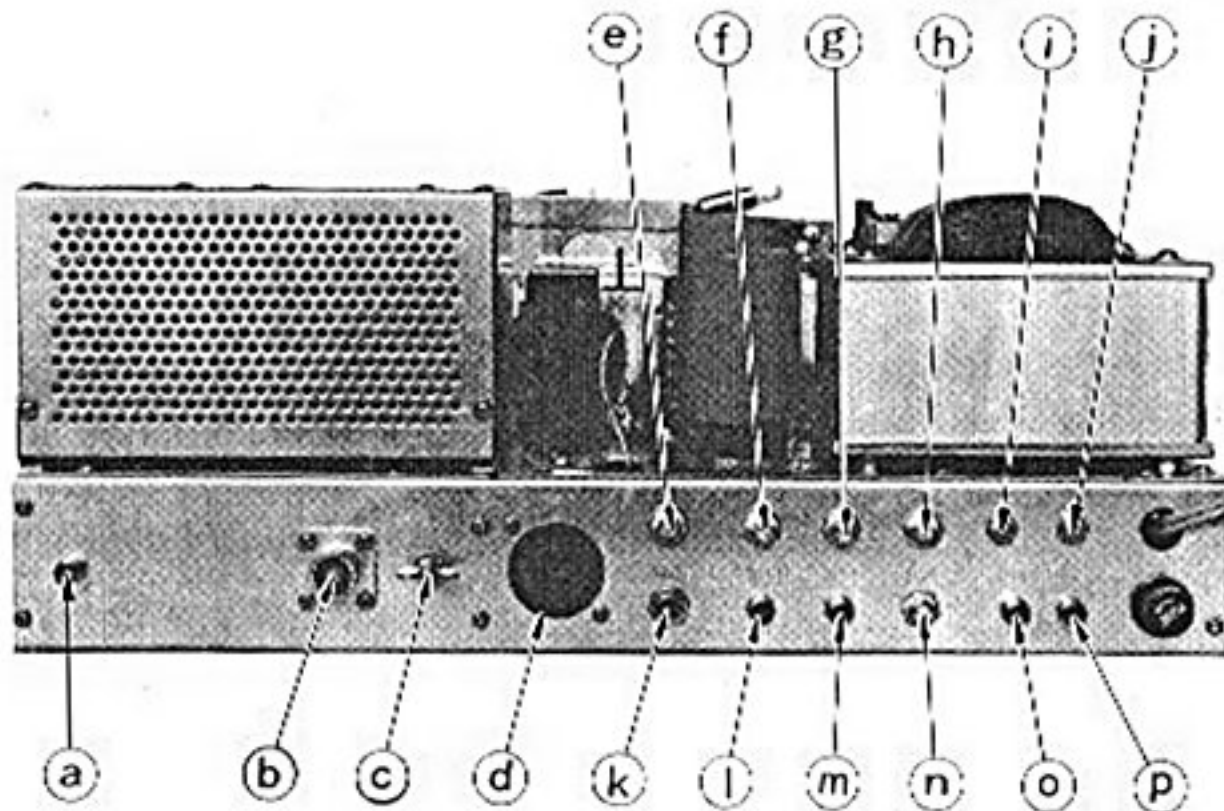

ⓐ RF OUT

Output from driver stage may be obtained for the use of optional equipments, such as our FTV-650 transverter.

ⓑ ANT

Coaxial connector for antenna.

ⓒ GND

Ground connection.

ⓓ ACC

Accessory socket.

Pins 1 and 2 shorted by ACC plug (11 pin male plug) when operating without transverter.

ⓔ DELAY

Adjusts "hold-in" time of VOX.

ⓕ VOX GAIN

Adjusts the VOX gain.

ⓖ ANTITRIP

Adjusts VOX anti-trip level.

ⓗ CARR.

Adjusts level of re-inserted carrier for AM operation.

ⓓ SM ADJ

Adjusts S-meter zero setting.

ⓓ ALC ADJ

Adjusts ALC limiting action.

ⓓ KEY

Key jack for code operation.

ⓓ PATCH

Speech input terminal for phone patch connection. Impedance is 50 kilo-ohms.

ⓓ VFO

Input jack for external V. F. O.

ⓓ BIAS

Adjusts bias on PA tubes.

ⓓ 600Ω

Receiver output at 600 ohm impedance to be used for phone patch.

ⓓ 8Ω

Receiver output at 8 ohm impedance for loud speaker.

## INSTALLATION

It is recommended that an excessively warm location be avoided. The transceiver should be placed in a location that has adequate space to permit free air circulation through the cabinet openings.

The transceiver should be connected to a good ground by a heavy lead to the terminal marked GND on rear apron of the chassis. It is not recommended that a gas pipe or electrical conduit pipes be used. The ground lead should be as short as possible.

Impedance of the antenna is designed to match a 50 to 120 ohm load. Most commercial antenna and feeders are designed between 50 and 75 ohms. If the impedance is far from this value, an antenna matching device should be placed between the antenna terminal and the feeder.

## OPERATION

### INITIAL CHECK

Prior to connecting the transceiver to power outlet, carefully examine for any visible damage, check that all tubes and crystals are properly seated in their sockets, and check tuning controls and switches for complete freedom. Connect the SP 400 speaker to jack marked 8 ohms on rear apron of the chassis, and an antenna cable to the coaxial cable connector. Make sure that supply voltage is the same as the voltage marked on the rear apron of the chassis before connecting to power outlet.

chassis before connecting to power outlet. Insert ACC plug (11 pin male plug sharing pins 1 and 2) into ACC socket on the rear apron of the chassis.

### RECEIVER TUNING

Set the controls as follows:

FUNCTION	OFF
MODE	Desired operation mode
BAND	Desired Band
MIC GAIN	Fully counterclockwise
RF GAIN	Fully clockwise
SELECT	INT
CLARIFIER	OFF
AGC	FAST

Set FUNCTION switch to STBY position, then adjust the AF GAIN control until some receiver noise is heard in speaker. Peak the PRESELECTOR for maximum S-meter reading, and tune slowly for desired signal.

### INITIAL ADJUSTMENTS

#### Dial Calibration:

Set FUNCTION switch to 100 KHz position. Rotate tuning knob to nearest 100 KHz mark as indicated on the lighted main tuning dial. An audio tone will be heard as tuning knob is rotated through each 100 KHz dial point. Very slowly rotate tuning knob in the direction that causes audio tone to decrease in frequency, until tone is just inaudible. (Zero Beat) Hold tuning knob firmly at this point and rotate skirt vernier dial to zero position. The skirt vernier dial surrounds the tuning knob and is held in

position by a friction locking device. This dial is easily movable by hand but will retain its position after adjustment. The transceiver must be recalibrated when changing mode of operation to LSB, USB, or CW. When in the AM mode no calibration tone can be heard, however, accurate frequency location can be determined by observing the S-meter for maximum indication when tuning through the calibration signal.

### METER ADJUSTMENTS:

The transceiver features four separate meter functions; S-meter, ALC (Automatic Limiter Control Indication), IC (Cathode Current of Final Amplifier Tubes), and PO (Relative Power Output Indication).

These functions are controlled from the METER switch on the front panel and are adjusted for zero settings by means of two variable potentiometers on the rear apron of the chassis.

#### S-Meter Adjustments

Set FUNCTION switch to STBY position, and R. F. GAIN control to fully clockwise, disconnect antenna, then adjust S-meter control on chassis rear apron until meter reads zero. Reconnect antenna.

#### ALC Adjustment

When METER switch on the front panel is set to ALC position the meter will indicate limiting action. To adjust meter to zero, set controls as follows:

MODE	USB
MIC GAIN	Fully counterclockwise
FUNCTION	MOX

If meter reads other than zero, adjust ALC control on rear apron of chassis for zero indication. Return FUNCTION switch to STBY position.

#### BIAS ADJUSTMENT

After warmup, set MODE switch to USB, METER to IC, and the FUNCTION switch to MOX for transmit condition. The meter will indicate PA plate current. The needle of the meter should rise to IDLE position which is approximately 50 ma. If plate current is other than 50 ma, adjust BIAS potentiometer on rear apron.

#### VOX ADJUSTMENT

VOX controls have been preset for normal operation settings at the factory, however, in the event of V209 tube replacement it may be necessary to readjust controls.

Set VOX GAIN and DELAY controls on rear apron on chassis to center of travel.

Locate potentiometer VR13 under top cover of cabinet and attached to bracket near S-meter. Adjust VR13 to just activate VOX relay when speaking into the microphone normally. Fine adjustments can then be made with VOX controls on rear apron.



## TRANSMITTER TUNING

Set controls as follows:

SELECT	INTERNAL
FUNCTION	STBY
MODE	TUNE
MIC GAIN	Fully counter clockwise
AF GAIN	Normal listening level
METER	IC position
CLARIFIER	OFF
BAND	Desired band
PLATE	Desired band
LOADING	To position shown in table

LOADING POSITIONS	
BAND	LOADING
80 .....	4
40 .....	2.5
20 .....	5
15 .....	3
10A .....	3
10B .....	3
10C .....	3
10D .....	3

### PRE-TUNING

1. Adjust PRESEL for maximum receiver noise level.
  2. Turn FUNCTION switch to MOX position with meter in IC position.
  3. Rotate MIC GAIN control until meter rises just above normal idling current. (50 ma)
  4. Rotate PRESEL control for maximum meter reading. (Caution: if meter reading exceeds 0.2 reduce MIC GAIN control).
  5. Rotate PLATE control for minimum meter reading. (Dip plate).
  6. Return FUNCTION switch to STBY.
- The transmitter is now pre-tuned to the desired frequency. Final peak tuning is accomplished by carefully following the final tuning procedure.

### FINAL TUNING

**CAUTION: EXCEEDING THE TIME LIMITS NOTED DURING FINAL TUNING MAY RESULT IN DESTRUCTION OF THE FINAL OUTPUT TUBES.**

1. Set meter to P.O. position, FUNCTION switch to STBY, MODE switch to CW.
  2. Momentarily set FUNCTION switch to MOX (ten seconds maximum) adjust PRESEL for *maximum* meter reading. Return FUNCTION switch to STBY.
  3. Momentarily set FUNCTION switch to MOX (ten seconds maximum), increase or decrease LOADING slightly for *maximum* meter reading. Return FUNCTION switch to STBY.
  4. Momentarily set FUNCTION switch to MOX (ten seconds maximum), adjust PLATE for *maximum* meter reading. Return FUNCTION switch to STBY.
  5. Repeat steps 3 and 4 until maximum meter reading is obtained.
- The transmitter is now peaked to maximum output. Return meter to IC position and set MODE switch to desired operating position.

### SSB OPERATION

Set up the transceiver as described in transmitter tuning. Set the METER switch to ALC position. Set the FUNCTION switch to MOX and adjust the MIC GAIN control until the meter kicks up to midscale of green colored portion when speaking into the microphone normally. Set the FUNCTION switch to desired operation. MOX (manual), PTT (push to talk), or VOX (voice control). For VOX operation, set the FUNCTION switch to VOX position, and advance VOX GAIN control on rear

apron until voice actuates the transceiver. Set the ANTI-TRIP control to the minimum point to prevent the speaker output from tripping the VOX. Do not use more VOX gain or more ANTITRIP gain than necessary. Adjust the DELAY control on rear apron for suitable release time.

NOTE: When meter is set to IC, voice modulation peaks will indicate 250 to 300 ma. Actual peak current, however, is approximately 2 times the indicated value.

## CW OPERATION

Using the two contact jack supplied with the accessory pack, connect key as shown in the illustration. Most relay type automatic keyers can be connected into the transceiver for break-in operation without modification.

## TUNING PROCEDURE - CW

Set up transceiver as described in transmitter tuning. After completion of final tuning, install key jack in rear apron of transceiver. Set MODE switch to CW and FUNCTION switch to MOX. The transceiver is now set up for manual CW operation. After completing a transmission the FUNCTION switch must be returned to STBY position for receive operation. For break-in operation, simply set FUNCTION switch to VOX position for transmit and receive.

## SIDETONE ADJUSTMENT

CW sidetone level may be adjusted by rotating the tone level potentiometer (VR 203) located on the main circuit board under the top cover. NOTE: Do not disturb setting of adjacent paint marked controls.

NOTE: Insertion of key jack automatically disconnects bias supply to final output tubes, therefore, with key jack installed bias idling current will not be indicated on meter.

## AM OPERATION

Set up the transceiver as described in transmitter tuning. Set meter to IC, MODE switch to AM position. Momentarily set FUNCTION switch to MOX. Meter should read 150 ma. If meter indicates other than 150 ma adjust the AM carrier control on rear apron until the correct reading is obtained.

Adjust the MIC GAIN control until the meter reading kicks up slightly on speech peaks. Do not draw more than 150 ma, otherwise the PA tubes will be damaged.

## SERVICE INSTRUCTIONS

### WARNING

Dangerous voltages are present, therefore extreme care is essential. Be sure that all power is disconnected before working on the chassis. Check the high voltages in the capacitors by shorting the high voltage line to ground with an insulated screw driver. The transceiver has been aligned and calibrated at the factory with proper test instruments and should not require realignment. Service or replacement of a major component may require subsequent realignment, but do not attempt to make an alignment unless the operation of the transceiver is fully understood. To remove the transceiver chassis from the cabinet, remove the six screws around the cabinet and two screws on the bottom of the cabinet. From the rear, push the chassis forward until front frame slides out of the cabinet. Holding the front panel at the edge, carefully slide the chassis out of the cabinet.

## VOLTAGE AND RESISTANCE MEASUREMENTS

The table lists voltages and resistance at all tube sockets. These values are measured with a VTVM with all tubes installed in their respective sockets.

All measurements should be made from socket pins to ground.

Adjust transistor voltage regulator to exactly 9 volts with VR-202 on the printed board. Measure voltage at junction of R294 and R295.

## TEST EQUIPMENT REQUIRED

A signal generator, a vacuum tube volt ohm meter with RF probe, a general coverage communication receiver, and a 300 watt dummy load.

## TRANSMITTER ALIGNMENT

1. Disconnect the high voltage (800 volts) by unsoldering the lead at rectifier socket, and also the screen voltage by unsoldering the connection at pin 3 of the two tube sockets.
2. Connect VTVM RF probe to pin 5 of V5.
3. Set the MODE switch to USB or LSB, and the FUNCTION switch to MOX position. Adjust carrier balance potentiometer VR, 201 on the main print board for minimum VTVM indication.
4. Advance MIC GAIN control two positions, and turn the MODE switch to TUNE.
5. Adjust PRESEL control for maximum VTVM reading.
6. Adjust the MIC GAIN control during transmitter alignment to keep VTVM reading at 15 volts to avoid saturation of the circuits.
7. Start with both slugs of T203 nearly out and peak primary and secondary of T203 for peak VTVM reading.
8. Same as in 7, adjust slugs of T204.
10. Set the BAND switch to the 80 meter band, the main tuning dial to the center (250 KHz), and the PRESEL control at center. Adjust the slugs of L901 & L1001 for peak VTVM reading. Adjust the slugs on all appropriate bands from 40 to 15 meters using the same procedure. Set the BAND switch to 10B and the main tuning dial at upper edge, and adjust L905 and L1005 for peak VTVM readings.

11. Disconnect the VTVM from pin 5 of V5, and connect it to pin 2 of V202. Set the BAND switch to 10D and adjust slug L3 for peak VTVM reading. Set the BAND switch to 10C and adjust the TC1101 for peak VTVM reading. Adjust TC1102 for 10B, TC 1103 for 10A, TC1104 for 15 and TC1105 for the 20 and 80 meter band, adjust TC1106 for peak VTVM reading. Disconnect VTVM.
12. Connect VTVM RF probe from pin 1 of V203 to ground. Set the main tuning dial at center. Adjust L207 for peak VTVM reading. Disconnect VTVM from pin 1 of V203 socket.
13. Turn the FUNCTION switch to OFF. Restore unsoldered PA screen grid and high voltage wire.
14. Connect the transceiver output to a 50 or 75 ohms dummy load. Set the main tuning dial at center, and tune up the transceiver on 80 meter band as described. Adjust MIC GAIN control setting to keep PA current less than 100 ma. Readjust L1001 for peak meter reading. Readjust L1001 to L1005 for appropriate BAND settings.
15. Tune the transceiver to maximum output at 14,350 KHz To measure spurious radiation, use the S-meter of another receiver and tune it to 14,520KHz where a spurious signal can be heard. Adjust TC-205 for minimum S-meter reading without decreasing power output of the transceiver.  
Adjust L17 and L19 for minimum S-meter reading.

#### TRANSMITTER SIGNAL LEVEL

The following table shows voltage measuring points and normal signal levels. Before making measurements, set MODE switch to CW and unsolder the lead from pin 3 of V5, and V6 sockets. Set the FUNCTION switch to MOX. Plug-in key to key-Jack and close key to measure the signal level.

TEST POINT	FREQUENCY	RF VOLTAGE
V207 — pin 3	3,178.5 KHz	1 volt
V201 — pin 1	Variable	0.6 volts (Function STBY sw.)
V3 — pin 1	X-tal frequency selected	0.5-1 volts
V207 — pin 7	3,178.5 KHz	5.5 volts
V204 — pin 1	3,178.5 KHz	0.03 volts
V204 — pin 5	3,178.5 KHz	5.5 volts
V201 — pin 5	Variable iF	9.0 volts
V3 — pin 5	Transmit frequency	10.0 volts
V5 — pin 5	Transmit frequency	33.0 volts

Voltages given in the table are nominal and may vary  $\pm 20\%$

#### FINAL AMPLIFIER NEUTRALIZATION

When replacing the final amplifier tubes it may be necessary to reset the bias to 50 ma and check neutralization. Using the procedure outlined below will guarantee maximum output and long tube life.

#### CAUTION:

HIGH VOLTAGES ARE PRESENT ON UNDERSIDE OF CHASSIS.

USE GREAT CARE WHILE MAKING ADJUSTMENTS WITH WIRING EXPOSED.

1. Locate TC-1 the neutralization variable capacitor shaft on the underside of chassis near the last band-switch wafer, in the final amplifier section.
2. Connect antenna to dummy load, set meter to I.C.
3. Check final amplifier bias in upper or lower Side Band position. If meter indicates other than 50 ma, reset bias.
4. Tune up the transceiver in the center of the 15 meter band.
5. After tune up place meter in I.C. position, Mode switch in Tune position, and advance Mic Gain until meter reads 150 ma.
6. Rotate Plate tuning control and observe dip as indicated on meter. (NOTE: If dip is not prominent, reduce loading control slightly for better indication). As the Plate control is rotated the meter should rise equally and smoothly on either side of maximum dip indication.
7. Determine which side of the dip rises abruptly. Set Plate control slightly to this side of dip keeping the meter reading below 200 ma.
8. Using a non-metallic tuning wand, rotate neutralization capacitor shaft *very slightly* in the direction which reduces the current shown on the meter.
9. Repeat steps 7 and 8 until the meter indicates a smooth, equal rise on either side of the maximum dip point.

## RECEIVER CIRCUIT ALIGNMENT

When the transmitter circuits are aligned, the only alignment remaining for the receiver circuits are the last IF stage transformer L205, antenna input transformer L801 to L805, trap coils L806, L906 and L23, set.

1. Connect signal generator output to the antenna terminal. Set the BAND switch to 80 meters, and receive 3,750 KHz signal from signal generator. Adjust PRESEL control for peak S-meter reading. Adjust L801 for peak S-meter reading. Adjust coils L802 to L805 at 7,250, 14,250, 21,250, 29,000 KHz respectively for peak S-meter reading.

2. Tune the receiver circuit to 7,100 KHz incoming signal, and leave controls as is. Apply 5,920 KHz signal generator output to antenna terminal. Adjust L806 and L906 for minimum S-meter reading. Then tune the receiver to 7,500 KHz and adjust L23 same as above at 5,520 KHz signal.
3. Tune the receiver to incoming signal on any band, and adjust slugs of T205 for peak S-meter reading.

## RECEIVER SIGNAL LEVEL

The following table shows test points and nominal signal level to produce S-9 reading on S-meter.

SIGNAL GENERATOR CONNECTION POINT	SIGNAL GENERATOR FREQUENCY	SIGNAL GENERATOR OUTPUT LEVEL
V205 — pin 1	3,180 HKz	100 db
V204 — pin 1	3,180 HKz	75 db
V203 — pin 7	5,770 KHz	77 db
V201 — pin 1	5,770 KHz	50 db
V1 — pin 1	14,255 KHz	47 db
Antenna Terminal	14,255 KHz	34 db
Oscillator injection voltages		
V213 — pin 7	3,178.5 KHz	4 volts
V203 — pin 1	Variable	3 volts
V202 — pin 1	Crystal Selected	1-2 volts

The receiver was tuned to 14.255 KHz for these measurements and the test signal injected at indicated test points. Signal generator output levels are taken from signal generator attenuator. All values are nominal and may vary  $\pm 20\%$  without degrading performance.

## TROUBLE SHOOTING GUIDE

DEFECT	POSSIBLE CAUSE
PA idling current unstable:	<ol style="list-style-type: none"> <li>1. Defective V5 and V6.</li> <li>2. Defective Bias supply including bias potentiometer.</li> </ol>
Insufficient load:	<ol style="list-style-type: none"> <li>1. PRESEL improperly tuned.</li> <li>2. BAND switch improperly set.</li> <li>3. Antenna not resonant at frequency.</li> <li>4. Defective antenna or transmission line.</li> <li>5. V3, V4, V5, V6 defective.</li> <li>6. Defective rectifier.</li> </ol>
Insufficient carrier suppression:	<ol style="list-style-type: none"> <li>1. Defective V207.</li> <li>2. Carrier balance control improperly set.</li> <li>3. Defective crystal X201 or X202.</li> <li>4. Carrier frequency improperly set.</li> </ol>
Distorted transmitted signal:	<ol style="list-style-type: none"> <li>1. Excessive MIC GAIN adjust.</li> <li>2. V7 defective.</li> <li>3. D2, D3 defective.</li> <li>4. Incorrect neutralization.</li> </ol>
Insufficient drive or no drive:	<ol style="list-style-type: none"> <li>1. Defective rectifier.</li> <li>2. Defective V204, V201, V3, V4, V5.</li> <li>3. Defective crystal.</li> </ol>
Low receiver sensitivity:	<ol style="list-style-type: none"> <li>1. Antenna relay, back contacts defective.</li> <li>2. Defective V1, V201, V203, V204, V205.</li> </ol>
VOX unstable:	<ol style="list-style-type: none"> <li>1. Defective V209.</li> <li>2. Improper setting of VOX GAIN and ANTITRIP controls.</li> </ol>

## RESISTANCE CHART

*Smith. Pin*

			1	2	3	4	5	6	7	8	9	10	11	12
	V 1	6BZ6	∞	100	0	0	7K	10K	0	—	—	—	—	—
<i>EF93</i>	V 2	6BA6	50K	0	0	0	10K	10K	0	—	—	—	—	—
	V 3	6AH6	∞	0	0	0	10K	7K	1K	—	—	—	—	—
	V 4	6GK6	200	50K	0	0	0	0	10K	10K	0	—	—	—
	V 5	6KD6	0	0	7K	0	50K	0	0	0	10K	0	7K	0
	V 6	6KD6	0	0	7K	0	50K	0	0	0	10K	0	7K	0
	V 7	VR105MT	10K	0	∞	0	10K	∞	0	—	—	—	—	—
	V201	6CB6	∞	500	0	0	8K	8K	0	—	—	—	—	—
	V202	6CB6	0	1K	0	0	8K	100K	0	—	—	—	—	—
<i>EK90s</i>	V203	6BF6	20K	100	0	0	8K	20K	100K	—	—	—	—	—
<i>G3H6</i>	V204	6BZ6	∞	100	0	0	8K	8K	100	—	—	—	—	—
<i>EF93</i>	V205	6BA6	∞	50	0	0	8K	10K	50	—	—	—	—	—
<i>ECC82</i>	V206	12AU7	20K	50K	∞	0	0	20K	50K	1K	0	—	—	—
	V207	7360	1K	0	∞	0	0	30K	50K	50K	10K	—	—	—
<i>ECL83</i>	V208	12AX7	∞	50K	3K	0	0	∞	∞	2K	0	—	—	—
<i>ECC81</i>	V209	12AT7	0	0	2K	0	0	20K	∞	10K	0	—	—	—
<i>ECL82</i>	V210	6BM8	∞	500	∞	0	0	10K	8K	2K	∞	—	∞	—
<i>EF93</i>	V211	6BA6	50K	0	0	0	10K	10K	200	—	—	—	—	—
<i>ECC82</i>	V212	6L8	∞	∞	∞	0	0	80K	∞	∞	∞	—	—	—
<i>ECC82</i>	V213	12AU7	50K	∞	1K	0	0	100K	100K	1K	0	—	—	—
<i>ECC82</i>	V214	6L8	∞	∞	∞	0	0	80K	2K	10K	∞	TUNE CW MODE		

NOTES 1. VALUES ARE IN OHMS 2. MODE IS IN USB UNLESS OTHERWISE SPECIFIED.

### ACCESSORY SOCKET CONNECTION

Pin 1. 6KD6 Heater

2. 6.3 Volt AC

3. -150 Volt DC

4. -300 Volt DC

5. 1500 Volt DC

6. -100 Volt DC

7. ALC

8. Ground

9. Relay contact open for receive and close to ground for transmit.

10. Relay contact open for transmit and close to ground for receive.

11. 6.3V AC

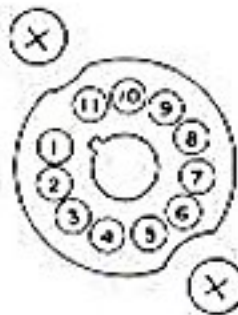

NOTE: ACCESSORY SOCKET IS WIRED TO USE TRANSVERTOR. WHEN TRANSVERTOR IS NOT USED, ACCESSORY PLUG MUST BE IN THE SOCKET, OTHERWISE, 6KDS HEATERS ARE NOT CONNECTED TO POWER SUPPLY.

### KEY AND MICROPHONE CONNECTIONS

CONNECTION

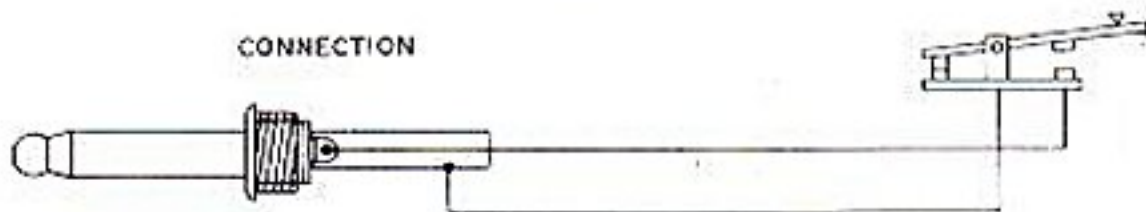

CONNECTION FOR PTT OPERATION

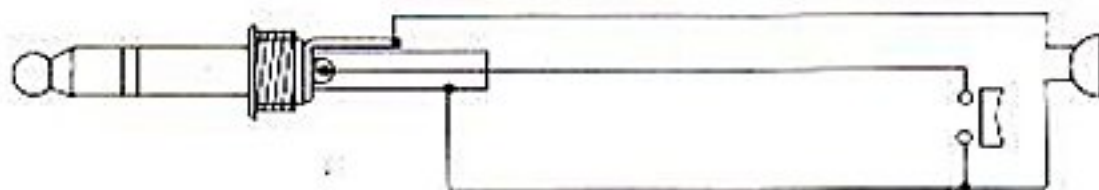

CONNECTION FOR MOX OPERATION

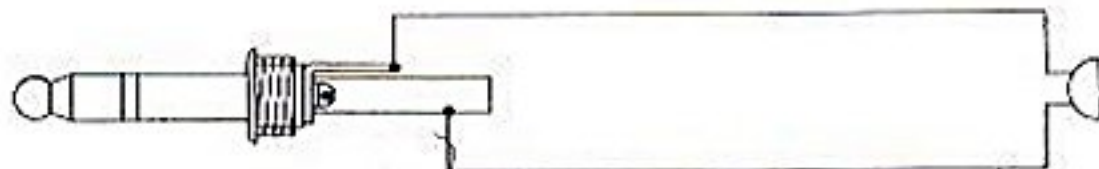

# VOLTAGE CHART

PIN TUBE	RECEIVE												TRANSMIT												
	1	2	3	4	5	6	7	8	9	10	11	12	1	2	3	4	5	6	7	8	9	10	11	12	
V 1 6BZ6	-	1.5	AC 6.3	0	170	105	0	-	-	-	-	-	-	25	AC 6.3	0	165	105	0	-	-	-	-		
V 2 6BA6	-	0	AC 6.3	0	105	105	0	-	-	-	-	-	-	0	AC 6.3	0	105	105	0	-	-	-	-		
V 3 6A116	-90	0	AC 6.3	0	200	170	-	-	-	-	-	-	-	0	AC 6.3	0	350	165	4.4	-	-	-	-		
V 4 6GK6	-	-90	0	0	AC 6.3	-	470	530	380	-	-	-	10	-	0	0	AC 6.3	-	500	300	0	-	-		
V 5 6KD6	AC 6.3	-	175	0	95	0	0	0	-95	0	175	0	AC 1.3	0	170	0	-50	0	0	0	-50	0	170	0	
V 6 6KD6	AC 6.3	-	175	0	-95	0	0	0	95	0	175	0	AC 6.3	0	170	0	-50	0	0	0	0	50	0	170	0
V 7 VR105MT	105	0	0	0	105	0	0	-	-	-	-	-	105	0	0	0	105	0	0	-	-	-	-	-	
V201 6CB6	-90	-	0	AC 6.3	165	165	0	-	-	-	-	-	-	2.7	0	AC 6.3	150	150	0	-	-	-	-	-	
V202 6CB6	-	2.5	AC 6.3	0	165	100	0	-	-	-	-	-	-90	-	AC 6.3	0	150	150	0	-	-	-	-	-	
V203 6BE6	-	0.8	AC 6.3	0	165	75	-	-	-	-	-	-	-	-	AC 6.3	0	150	70	-90	-	-	-	-	-	
V204 6BZ6	-	1.7	0	AC 6.3	155	120	1.7	-	-	-	-	-	-	1.7	0	AC 6.3	150	115	1.7	-	-	-	-	-	
V205 6BA6	-	1.3	0	AC 6.3	155	105	1.1	-	-	-	-	-	-	35	0	AC 6.3	150	105	35	-	-	-	-	-	
V706 12AU7	80	-	1.3	0	0	80	-	3.0	AC 6.3	-	-	-	80	-	1.1	0	0	80	3.0	AC 6.3	-	-	-		
V207 7J60	-	85	90	0	AC 6.3	105	105	11	11	-	-	-	1.5	35	-	0	AC 6.3	90	90	11.5	11.5	-	-	-	
V208 12AX7	55	-	3.7	AC 6.3	65	65	-	7.9	0	-	-	-	55	-	2.7	AC 6.3	65	65	-	2.9	0	-	-	-	
V209 12AT7	60	-	1.2	AC 6.3	300	300	-	45	0	-	-	-	80	-	1.2	AC 6.3	150	150	0	0.3	0	-	-	-	
V210 6BM8	-	9.5	-	AC 6.3	160	170	1.3	75	-	-	-	-	9.5	-	AC 6.3	160	160	160	1.2	75	-	-	-	-	
V211 6BA6	-	0	AC 6.3	0	160	105	7.4	-	-	-	-	-	-	AC 6.3	0	155	105	2.4	-	-	-	-	-	-	
V712 6L8	0	-	165	AC 6.3	0	120	14	14	-90	-	-	-	0	-	150	AC 6.3	0	120	14	14	-	-	-	-	
V213 12AU7	115	-	4.5	0	0	70	-	4.5	AC 6.3	-	-	-	115	-	4.5	0	0	70	-	4.5	AC 6.3	-	-	-	
V212 6UB	310	-	45	AC 6.3	0	78	2.2	-	-55	-	-	-	180	-	40	AC 6.3	0	70	1.9	8.0	-	-	-	TUNE/CW MODE	

NOTES 1. VALUES ARE MEASURED BY VTVM AND ARE IN VOLTS D. C. UNLESS OTHERWISE SPECIFIED.

2. MODE IS IN USB UNLESS OTHERWISE SPECIFIED.

C-CAPACITOR			31, 37, 38, 40, 41, 43, 44, 49, 50, 52, 55, 56, 57, 58, 59, 60, 69, 70, 72, 77, 83, 108, 202, 203, 206, 208, 213, 214, 218, 221, 222, 225, 228, 229, 231, 235, 238, 242, 244, 245, 247, 248, 249, 252, 253, 256, 259, 261, 262, 264, 265, 274, 275, 276, 284, 286, 287, 288, 289, 290, 291, 292, 293, 294, 295, 296, 297, 2103, 2104, 2105, 2117, 2118, 2126, 403, 414, 513, 1202, 1203, 1204, 1205, 1206, 1208, 1209, 1210	500WV 0.01 $\mu$ F $\pm 1\%$
249, 2125	DIPPED MICA 500WV 1PF $\pm 0.5PF$			
282	DIPPED MICA 500WV 2PF $\pm 0.5PF$			
12	DIPPED MICA 500WV 3PF $\pm 0.5PF$			
81, 93, 2109, 705, 1004	DIPPED MICA 500WV 5PF $\pm 0.5PF$			
11, 89, 98, 101, 110, 281	DIPPED MICA 500WV 10PF $\pm 10\%$			
74, 212, 246, 277, 2116, 902	DIPPED MICA 500WV 15PF $\pm 10\%$			
75, 82, 243, 1002	DIPPED MICA 500WV 20PF $\pm 10\%$			
33, 279, 1003, 1102	DIPPED MICA 500WV 30PF $\pm 10\%$			
34, 278	DIPPED MICA 500WV 40PF $\pm 10\%$			
13, 88, 96, 2108, 304, 305, 308, 311, 313, 802, 805, 904	DIPPED MICA 500WV 50PF $\pm 10\%$			CERAMIC DISC (AL) 1.4KVDC 0.0047 $\mu$ F $\pm 1\%$
703, 903	DIPPED MICA 500WV 60PF $\pm 10\%$			CERAMIC DISC (AL) 1.4KVDC 0.01 $\mu$ F $\pm 1\%$
224, 226, 230, 232, 241, 804, 901	DIPPED MICA 500WV 70PF $\pm 10\%$			CERAMIC (TC) NPO 500WV 8PF $\pm 0.5PF$
302, 803, 1103	DIPPED MICA 500WV 80PF $\pm 10\%$			CERAMIC (TC) NPO 500WV 10PF $\pm 10\%$
3, 6, 217, 219, 233, 234, 239, 273, 2106, 408, 1005, 1104	DIPPED MICA 500WV 100PF $\pm 10\%$			CERAMIC (TC) NPO 500WV 20PF $\pm 10\%$
2, 10, 215, 216, 2100, 2101, 2102, 801	DIPPED MICA 500WV 150PF $\pm 10\%$			CERAMIC (TC) N750 500WV 82PF $\pm 10\%$
30, 84, 87, 258, 410, 411	DIPPED MICA 500WV 200PF $\pm 10\%$			CERAMIC (TC) N750 500WV 4PF $\pm 0.5PF$
35, 79, 236, 301, 310	DIPPED MICA 200WV 250PF $\pm 10\%$			CERAMIC (TC) N750 500WV 10PF $\pm 10\%$
29, 94	DIPPED MICA 500WV 300PF $\pm 10\%$			CERAMIC (TC) N750 500WV 20PF $\pm 10\%$
14, 91, 806	DIPPED MICA 500WV 470PF $\pm 10\%$			CERAMIC FEED THRU BYPASS 500WV 0.001 $\mu$ F $\pm 1\%$
401, 402	DIPPED MICA 500WV 650PF $\pm 10\%$			CERAMIC RDA-30 3KTV 80PF $\pm 10\%$
4, 71, 205, 209, 220, 227, 251, 2115, 306, 307	DIPPED MICA 500WV 1000PF $\pm 10\%$			CERAMIC RDA-40 3KTV 280PF $\pm 10\%$
303, 405	DIPPED MICA 500WV 2000PF $\pm 10\%$			MYLAR FILM 50WV 0.047 $\mu$ F $\pm 20\%$
109	MICA CML1 1000WV 10PF $\pm 10\%$			MYLAR FILM 50WV 0.1 $\mu$ F $\pm 20\%$
32	MICA CML1 1000WV 50PF $\pm 10\%$			MYLAR FILM 50WV 0.22 $\mu$ F $\pm 20\%$
25	MICA CML1 1000WV 100PF $\pm 10\%$			MYLAR FILM 50WV 0.47 $\mu$ F $\pm 20\%$
47	MICA CM35 1500WV 300PF $\pm 10\%$			PAPER 600WV 0.047 $\mu$ F $\pm 20\%$
48	MICA CM35 1500WV 500PF $\pm 10\%$			METALIZED PAPER 160WV 0.47 $\mu$ F $\pm 20\%$
86	MICA CM35 1500WV 1000PF $\pm 10\%$			ELECTROLYTIC 16WV 1 $\mu$ F $\pm 20\%$
46	MICA CMBS 3000WV 1000PF $\pm 10\%$			ELECTROLYTIC 16WV 10 $\mu$ F $\pm 20\%$
45	MICA CMBS 3000WV 5000PF $\pm 10\%$			ELECTROLYTIC 25WV 470 $\mu$ F $\pm 20\%$
2113	CERAMIC DISC 50WV 0.0022 $\mu$ F $\pm 20\%$			ELECTROLYTIC 270 50WV 10 $\mu$ F $\pm 20\%$
309, 312, 406, 407, 409, 412, 413, 421, 701, 702, 704, 1201, 1211	CERAMIC DISC 50WV 0.01 $\mu$ F $\pm 20\%$			ELECTROLYTIC 2112 160WV 1 $\mu$ F $\pm 20\%$
39, 42	CERAMIC DISC 50WV 0.047 $\mu$ F $\pm 20\%$			ELECTROLYTIC 272, 2110, 2111, 1207 160WV 10 $\mu$ F $\pm 20\%$
85, 269, 283	CERAMIC DISC 500WV 0.0047 $\mu$ F $\pm 1\%$			ELECTROLYTIC 65, 66 160WV 22 $\mu$ F $\pm 20\%$
7, 8, 15, 23, 24, 26, 27, 28,	CERAMIC DISC			ELECTROLYTIC 73 350WV 22 $\mu$ F $\pm 20\%$
				ELECTROLYTIC 92, 95

603	350WV 47 $\mu$ F	10%	508, 601, 602		
	ELECTROLYTIC		1, 29, 234, 267, 285, 2108	1/2 W	1M $\Omega$ $\pm$ 10%
601, 602	400WV 3 $\times$ 47 $\mu$ F	10%	225, 269, 271	1/2 W	2.2M $\Omega$ $\pm$ 10%
	ELECTROLYTIC		2110	1/2 W	3.3M $\Omega$ $\pm$ 10%
	500WV 100 $\mu$ F	10%	224	1/2 W	5.6M $\Omega$ $\pm$ 10%
<b>VC-VARIABLE CAPACITOR</b>					
1	PRESELECT	B565A118	23, 26	1W	56 $\Omega$ $\pm$ 10%
2	PLATE	YA-270P	225	1W	220 $\Omega$ $\pm$ 10%
3	LOADING	ECV-2HA43A44	2120	1W	3.3K $\Omega$ $\pm$ 10%
401	V. F. O.	C521A112	513	1/2 W	4.7K $\Omega$ $\pm$ 10%
			218	1W	5.6K $\Omega$ $\pm$ 10%
<b>TC-TRIMMER CAPACITOR</b>					
1	AIR		52, 53, 516	1W	22K $\Omega$ $\pm$ 10%
	TSN-170C-10P		18	2W	5.1K $\Omega$ $\pm$ 10%
203, 204, 205, 701, 702	CERAMIC		35, 50	2W	3.3K $\Omega$ $\pm$ 10%
1101, 1102, 1103, 1104,	ECV-1ZW20P32		16, 284	3W	47K $\Omega$ $\pm$ 10%
1105, 1106, 1107, 1108,			517	4W	5.6 $\Omega$ $\pm$ 10%
1109			17	5W	4.7K $\Omega$ $\pm$ 10%
206, 207, 208	CERAMIC		34	5W	22K $\Omega$ $\pm$ 10%
	ECV-1ZW40P32		48	20W	1.5K $\Omega$ $\pm$ 10%
301	CERAMIC		49	20W	4K $\Omega$ $\pm$ 10%
	DT-120-50P		25	METER SHUNT	
401	AIR			<b>VR-VARIABLE RESISTOR</b>	
	TSN-150C-30P		1, 10	EVW-JOAS 15B51 B50 $\Omega$	
402	AIR (SPLIT STATOR)		2, 9	EVF-93QF 11653	
	TSN-170C-10P $\times$ 2			B500K $\Omega$ /C10K $\Omega$ DUAL	
<b>R-RESISTOR</b>					
56	1/2 W	5.6 $\Omega$ $\pm$ 10%	3	EVR-NOAS50B13 B1K $\Omega$	
57, 59, 704	1/2 W	10 $\Omega$ $\pm$ 10%	5	EVH-BOAS15B54 B50K $\Omega$	
282	1/2 W	22 $\Omega$ $\pm$ 10%	6	EVR-NOAS50A55 A500K $\Omega$	
21, 24, 36, 39, 42, 44, 221	1/2 W	56 $\Omega$ $\pm$ 10%	7, 8	EVH-BOAS15A55 A500K $\Omega$	
3, 40, 41, 212, 216, 303, 310	1/2 W	100 $\Omega$ $\pm$ 10%	11	EVC-BOAS15B24 B20K $\Omega$	
277	1/2 W	150 $\Omega$ $\pm$ 10%	12	EVC-BOAS15B36 B3M $\Omega$	
15, 279, 411, 703	1/2 W	220 $\Omega$ $\pm$ 10%	13	EVC-BOAS15B33 B3K $\Omega$	
410, 702	1/2 W	270 $\Omega$ $\pm$ 10%	202 (TRIMMER)	EVL-S3AA00B13 B1K $\Omega$	
203, 403, 406	1/2 W	330 $\Omega$ $\pm$ 10%	4, 14, 201 (TRIMMER)	EVL-S3AA00B53 B5K $\Omega$	
7, 294, 1202	1/2 W	470 $\Omega$ $\pm$ 10%	301 (TRIMMER)	EVL-S3AA00B14 B10K $\Omega$	
293	1/2 W	560 $\Omega$ $\pm$ 10%	204, 205 (TRIMMER)	EVL-S3AA00B54 B50K $\Omega$	
2119	1/2 W	680 $\Omega$ $\pm$ 10%	203 (TRIMMER)	EVL-S3AA00B55 B500K $\Omega$	
4, 6, 8, 11, 13, 20, 60, 201,	1/2 W	1K $\Omega$ $\pm$ 10%	<b>TR-TRANSISTOR &amp; FET</b>		
204, 207, 209, 214, 219,			202, 403	2SC372Y	
229, 230, 235, 237, 244,			201	2SC504	
280, 289, 295, 2121, 404,			301, 302, 303, 304	2SC735Y	
407, 412, 1201, 1206, 1207			402	FET 2SK19G	
19, 253, 262, 272, 297,	1/2 W	2.2K $\Omega$ $\pm$ 10%	401	FET 3SK22G	
298, 2102			701	FET MK-10-E or MK-10-F	
258, 296	1/2 W	3.3K $\Omega$ $\pm$ 10%	<b>D-DIODE</b>		
247, 260, 2113, 305, 307	1/2 W	4.7K $\Omega$ $\pm$ 10%	401, 701	VARACTOR 1S115	
37	1/2 W	5.1K $\Omega$ $\pm$ 10%	215	ZENER 1S131	
286	1/2 W	5.6K $\Omega$ $\pm$ 10%	217	ZENER 1S134	
408	1/2 W	8.2K $\Omega$ $\pm$ 10%	216	ZENER 1S136	
22, 47, 276, 283, 2105,	1/2 W	10K $\Omega$ $\pm$ 10%	1, 204, 205, 206, 212,	1S1007	
2107, 2112, 301, 308, 401,			1201, 1202, 1203		
514, 705, 1203, 1204			2, 3, 202, 203, 207, 208	1S1941	
213	1/2 W	15K $\Omega$ $\pm$ 10%	209, 210, 213, 218		
211, 217, 2122, 2123, 409	1/2 W	22K $\Omega$ $\pm$ 10%	211, 513	1S1943	
306	1/2 W	27K $\Omega$ $\pm$ 10%	509, 510, 511, 512	1S1944	
55, 304	1/2 W	33K $\Omega$ $\pm$ 10%	501, 502, 503, 504, 505,	10D10	
5, 14, 45, 226, 238, 240,	1/2 W	47K $\Omega$ $\pm$ 10%	506, 507, 508,		
241, 243, 245, 246, 248,			<b>V-VACUUM TUBE</b>		
249, 250, 259, 268, 278,			3	6AH6	
291, 292, 2104			2, 205, 211	6BA6	
12, 54, 202, 205, 208, 210,	1/2 W	100K $\Omega$ $\pm$ 10%	203	6BE6	
215, 220, 228, 233, 239,			210	6BM8	
252, 256, 261, 266, 287,			1, 204	6BZ6	
288, 290, 2106, 302, 309,			201, 202	6CB6	
402, 405, 515, 701,			4	6GK6	
242	1/2 W	150K $\Omega$ $\pm$ 10%	5, 6	6KD6	
257, 264, 270, 271	1/2 W	220K $\Omega$ $\pm$ 10%	212	6U8	
2, 226, 254, 263, 265,	1/2 W	470K $\Omega$ $\pm$ 10%	209	12AT7	
274, 299, 2100, 2101,			206, 213	12AU7	
2103, 2109, 501, 502,			208	12AX7	
503, 504, 505, 506, 507,			207	7360	
			7	VR105MT	



<b>L-INDUCTOR</b>		4	JPL-259 (COAXIAL)
1, 2, 3, 403	MICRO-INDUCTOR 250 $\mu$ H	5	PA-602B (11P MALE)
<b>RL-RELAY</b>			
402	R. F. CHOKE COIL TV 245 250 $\mu$ H	2, 201	RAB-100D-11
<b>PL-PILOT LAMP</b>			
6	R. F. CHOKE COIL 200 $\mu$ H	1, 2	8V 0.15AMP.
24	R. F. CHOKE COIL 300 $\mu$ H	<b>PLH-PILOT LAMP HOLDER</b>	
14	R. F. CHOKE COIL 500 $\mu$ H	1, 2	S-3512
215	R. F. CHOKE COIL 2MH	<b>F-FUSE</b>	
301, 302	R. F. CHOKE COIL 4MH	1	10AMP. for 117V 6AMP. for 220V
<b>T-TRANSFORMER</b>			
1	OUTPUT TRANSFORMER		<b>FH-FUSE HOLDER</b>
2	POWER TRANSFORMER	1	S-N1001
<b>CH-A. F. CHOKE COIL</b>			<b>M-METER</b>
201	1H 20MA	1	MK-45 1mA
1	2.5H 150MA		<b>XS-CRYSTAL SOCKET</b>
<b>VS-VACUUM TUBE SOCKET</b>		1, 2, 3	TYPE HC-25/U
1, 2, 3	TS102 C01	201, 202, 301, 701, 702	TYPE HC-6/U
4	TS103 C01	<b>X-CRYSTAL</b>	
7	TS102 C04	1	80m BAND LOCAL OSC. HC-18/U 9.52MHz
5, 6	S-B0703-2	2	40m " " " " " 13.02 "
201, 202, 203, 204, 205	S-B0933-2	3	20m " " " " " 20.02 "
211		4	15m " " " " " 27.02 "
206, 207, 208, 213	S-B1330-2	5	10mA " " " " " 34.02 "
209, 210, 212	S-B1307-2	6	10mB " " " " " 34.52 "
<b>S-SWITCH</b>		7	10mC " " " " " 35.02 "
1	BAND SELECTOR RS13-13-11	8	10mD " " " " " 35.52 "
2	AGC RS1-1-3	201	USB CARRIER OSC. HC-6/U 3181.5KHz
3	CLARIFIER RS1-2-3	202	USB " " " " " 3178.5 "
4	MODE RS4-8-5	301	CALIBRATOR OSC. HC-13/U 100KHz
5	FUNCTION RS1-4-7	<b>XF-CRYSTAL FILTER</b>	
6	SELECT RS2-4-6	201	XF-3A 2.4KHz
7	METER RS1-1-3	202	(OPTION) XF-3C 600Hz
<b>J-JACK &amp; RECEPTACLE</b>		<b>PB-PRINTED CIRCUIT BOARD</b>	
2, 7, 9, 10, 11	CN-7017	PB1001-2	GENERATOR
3, 6	S-G7615 (2P)	PB1002	CALIBRATOR
1	S-G7701 (3P)	PB1004-2	POWER SUPPLY
4	ISO-239 (COAXIAL)	PB1007	COIL ASS'Y
5	SA-602B (11P FEMALE)	PB1022A	TRIMMER CAP. ASS'Y
<b>P-PLUG</b>		PB1038	DIODE SWITCH
2, 7, 9, 10, 11	CN-7017	PB1056	V. F. O.
3, 6	S-H3001 (2P)	PB1058	B. P. F.
1	S-H3601 (3P)	PB1059	B. P. F.

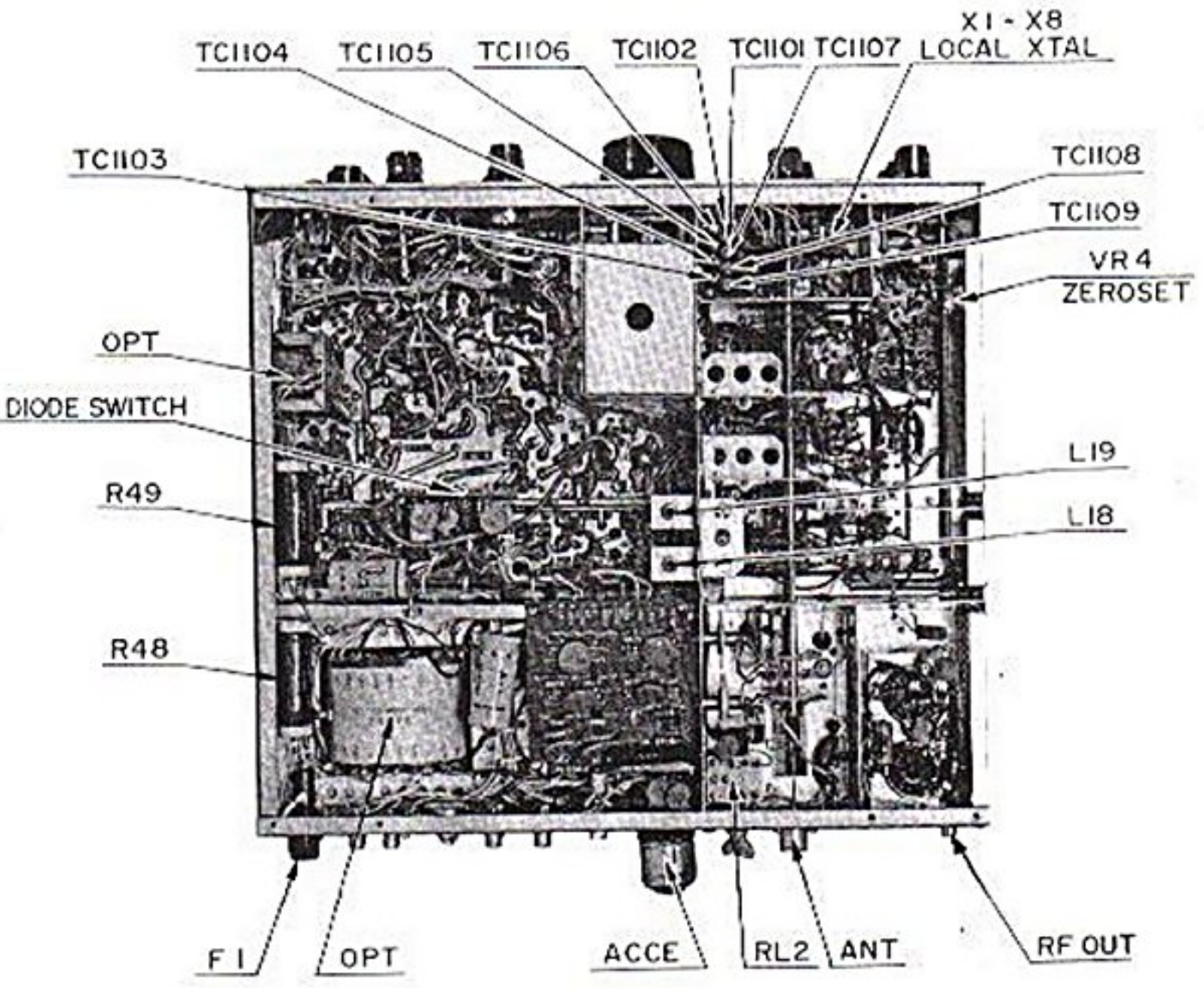
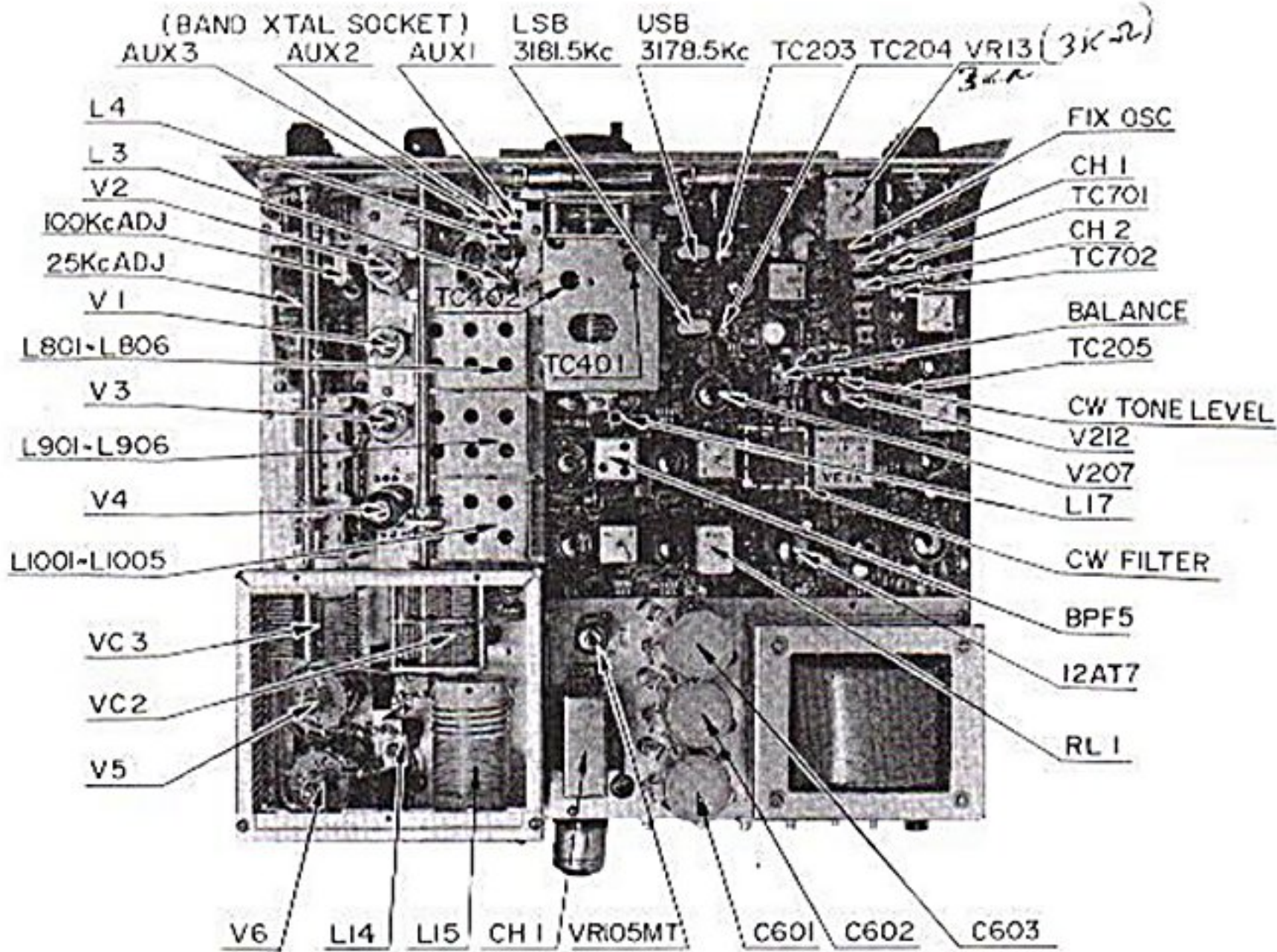

V208 12AX7  
MIC AMP

V209a 12AT7  
VOX AMP

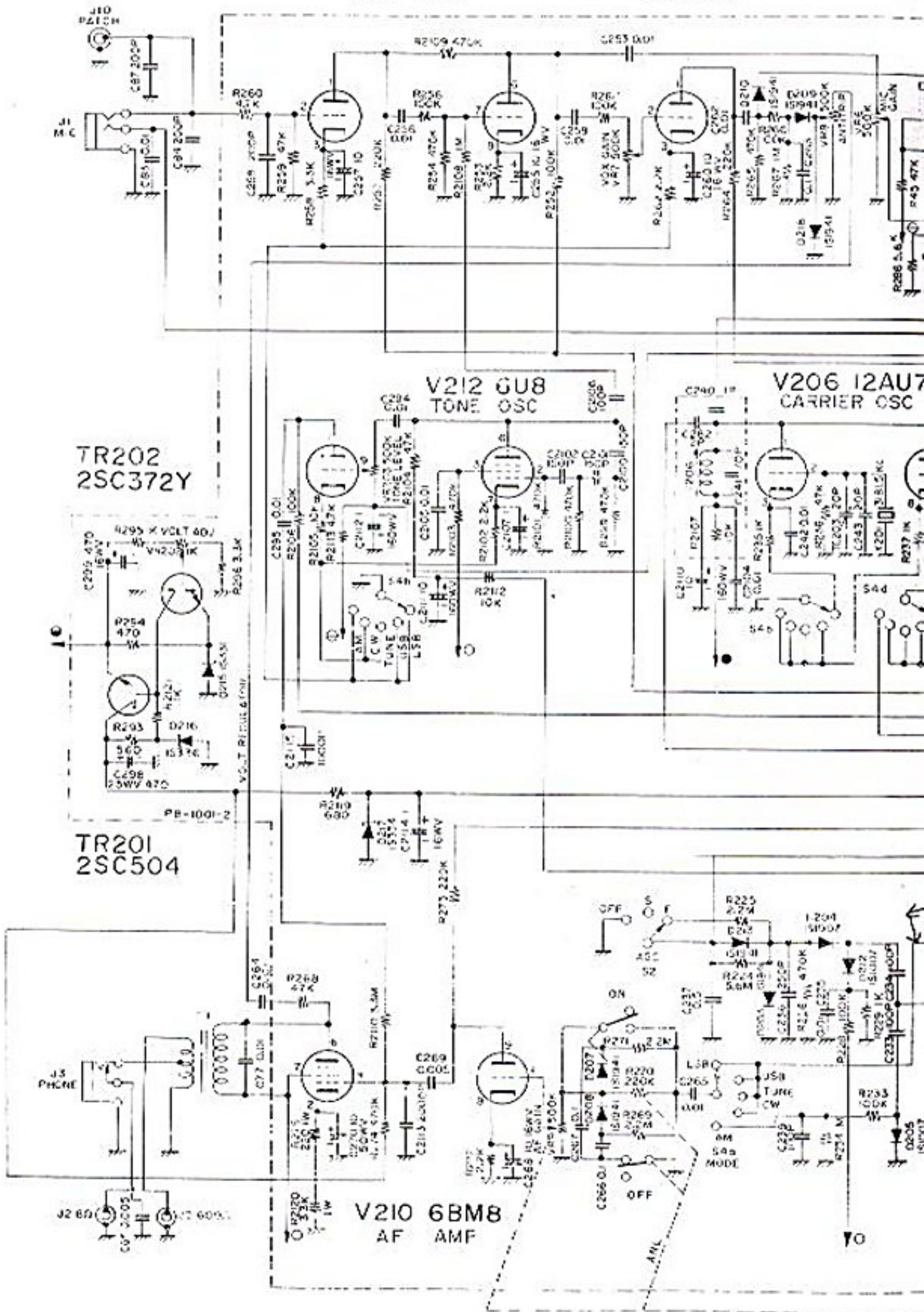

V209b 12AT7  
RELAY CONTROL

V207 7360  
B M

V201 6CB6  
TRANS 1ST MIX

V3 6AH6  
TRANS 2ND MIX

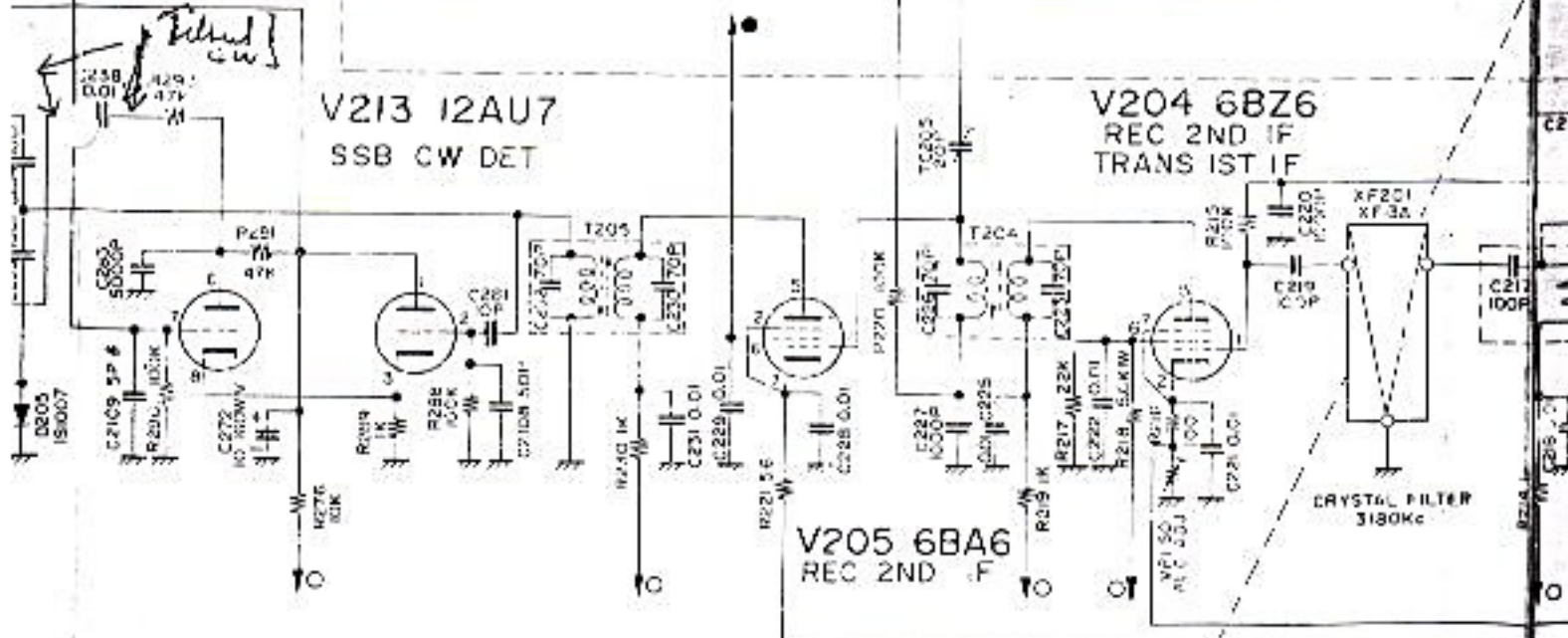
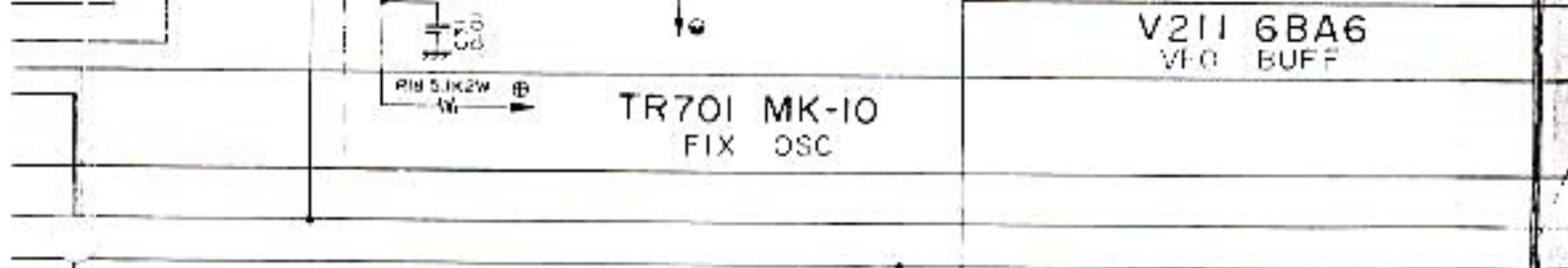
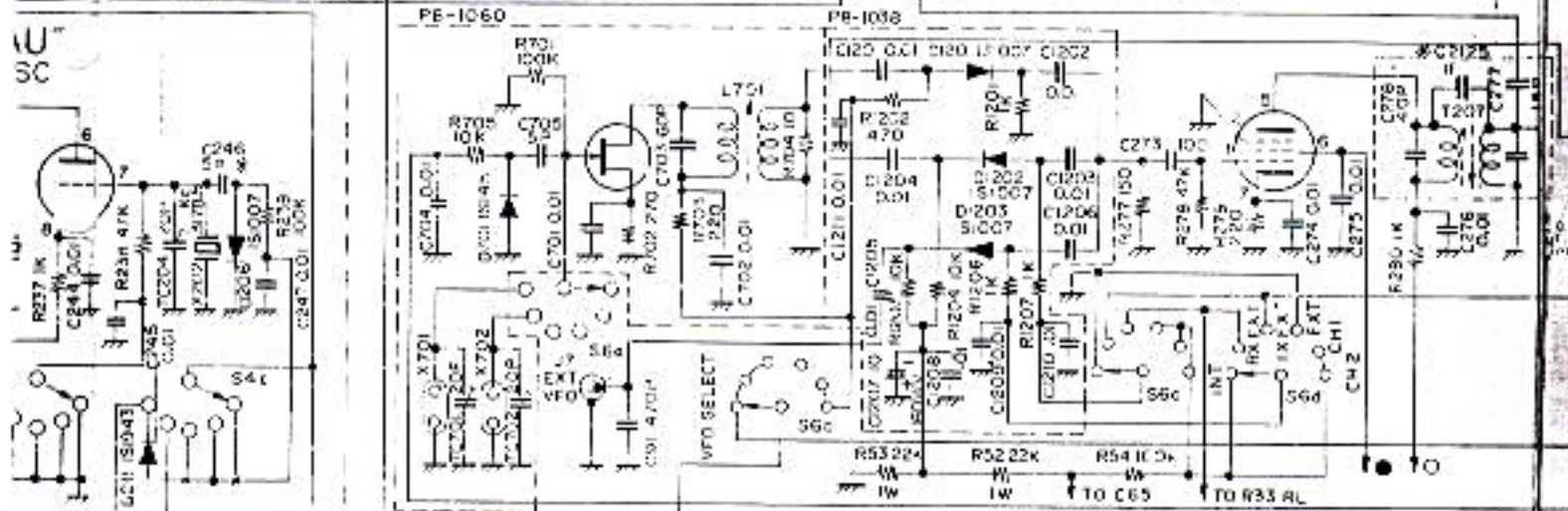
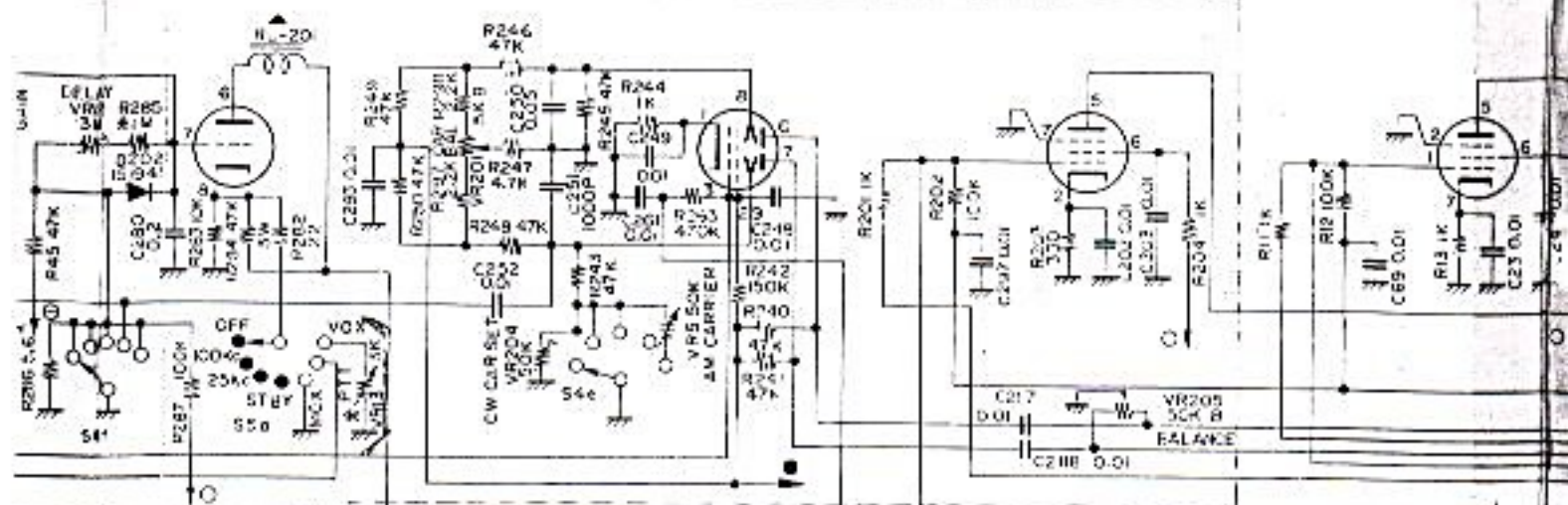

- ▲ RL 1
- RL 2
- +105V REG
- +150V
- ⊕ +300V
- ⊗ +800V
- ⊙ -100V (Rx10-40(TX))
- ⊕ 5V REG

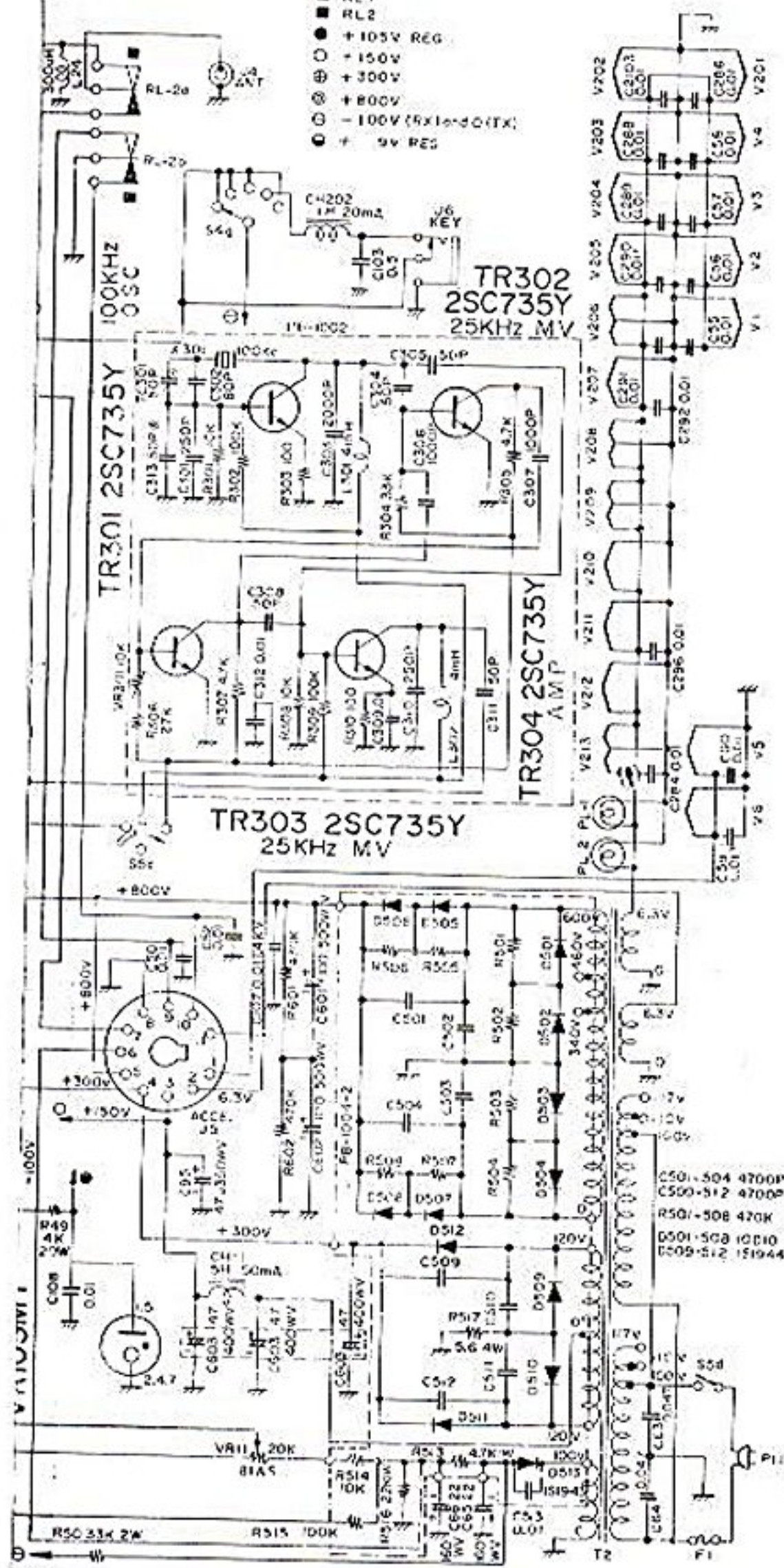

RES IN OHM 1/2W 10%  
 OTHERWISE NOTED.  
 CAPS IN μF  
 OTHERWISE NOTED.  
 \* NOMINAL

**FTDX400 / 500  
 CIRCUIT DIAGRAM**

AH6  
2D MIX

V4 6GK6  
DRIVER

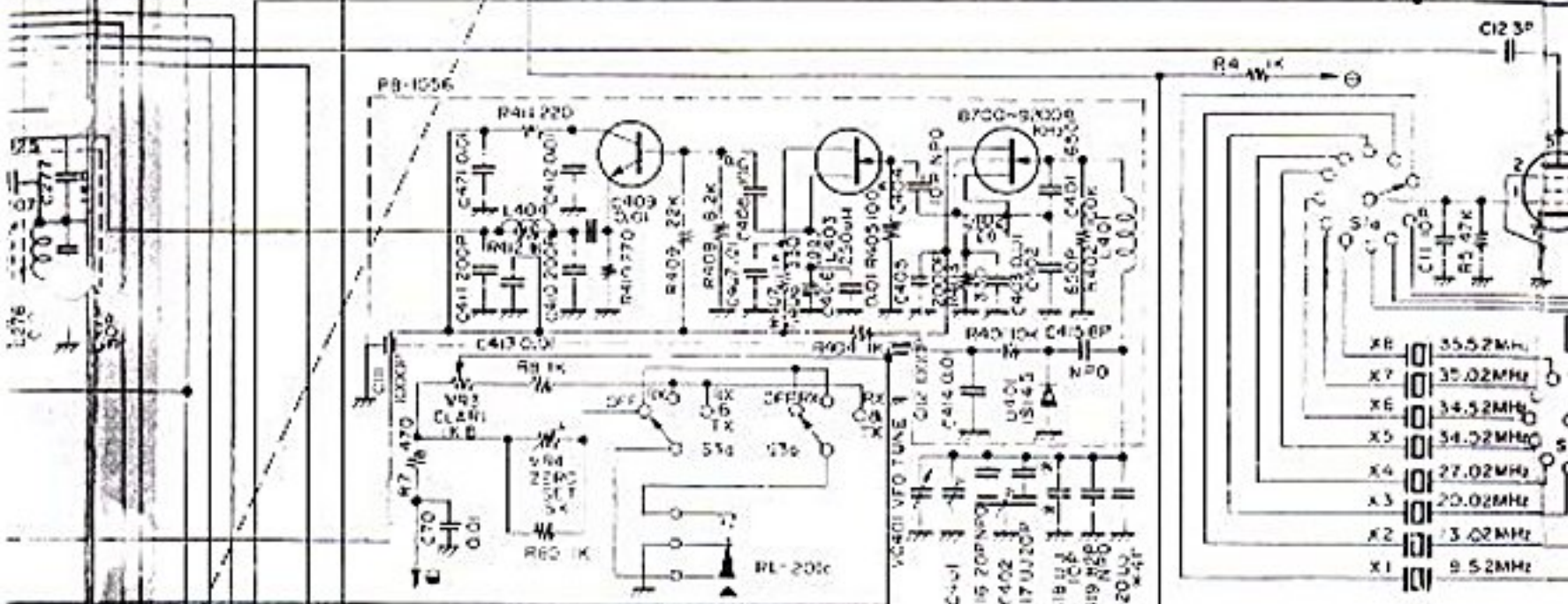
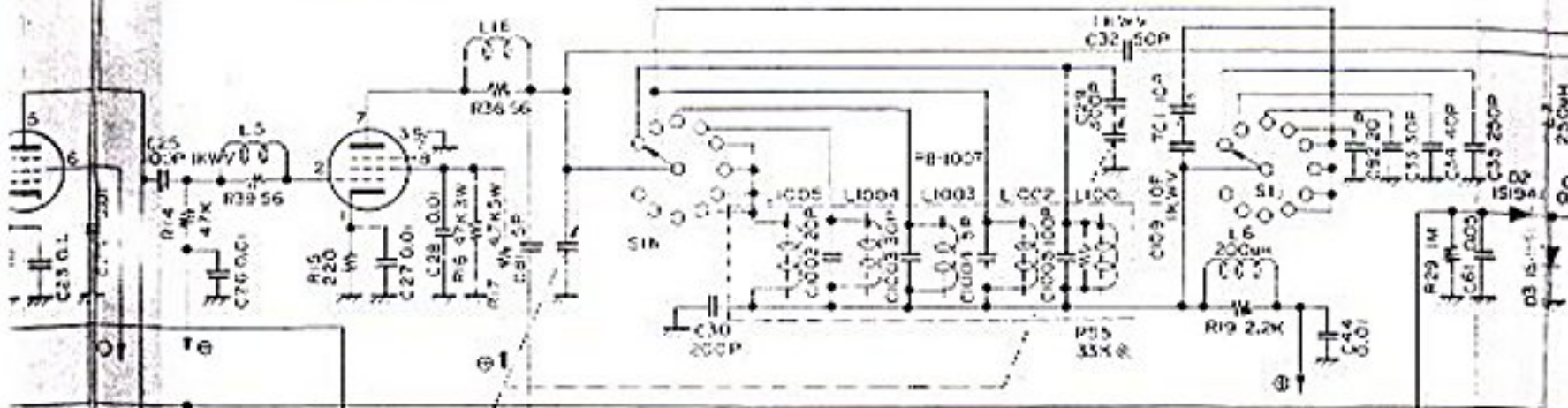

TR403  
2SC372Y  
VFO AMP

TR402  
2SK19G  
VFO BUFF

TR401  
3SK22G  
VFO OSC

V2 6E  
LOCAL

V203 6BE6  
REC 2ND MIX

V202 6CB6  
REC 1ST MIX

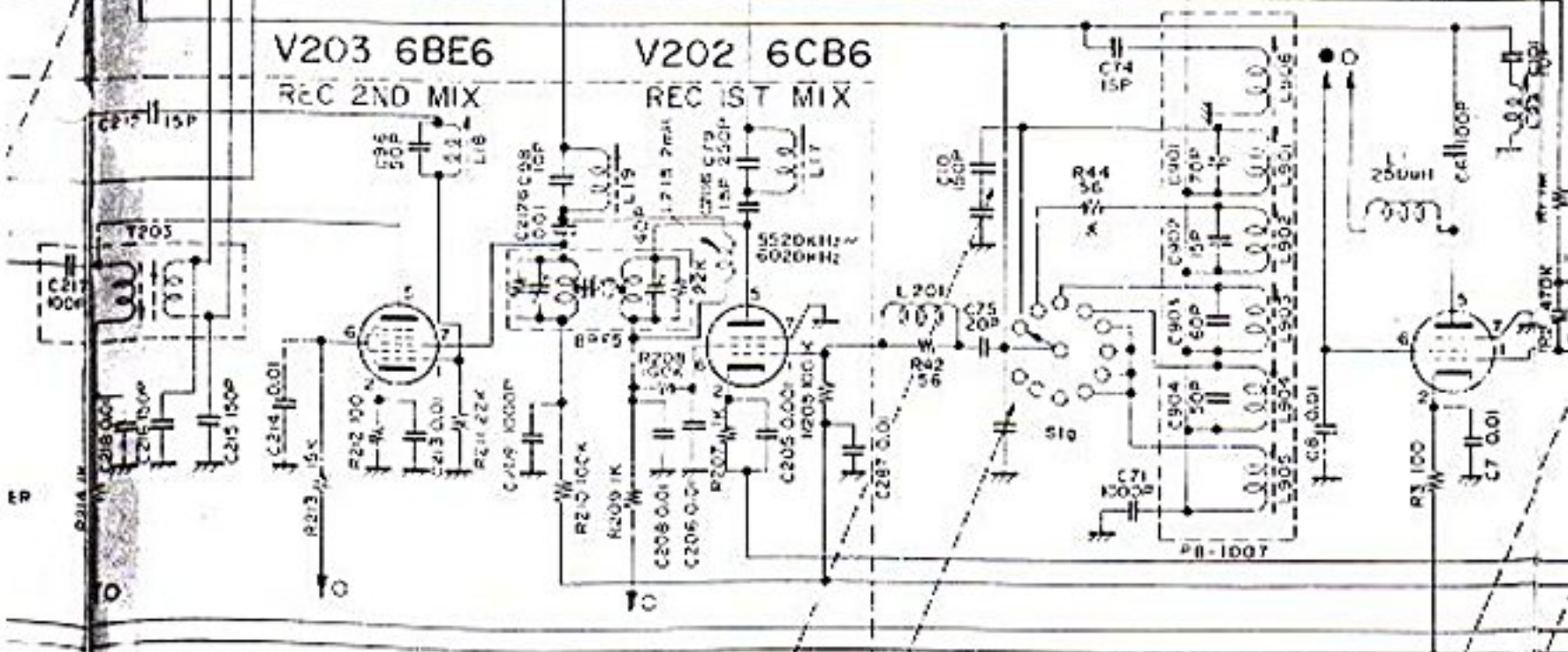

VC1 PRESELECTOR

V5 6KD6  
P A

V6 6KD6  
P A

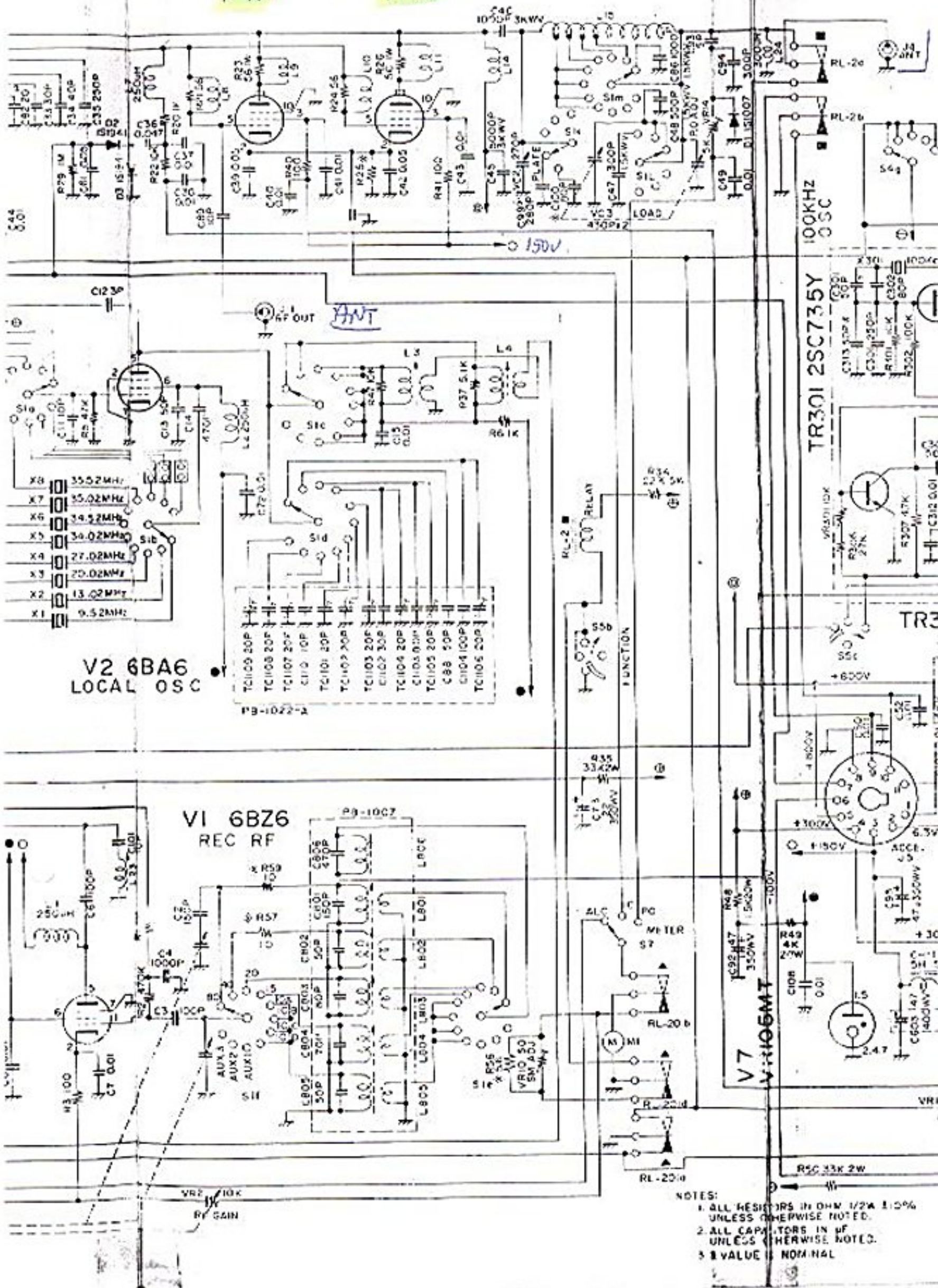

V2 6BA6  
LOCAL OSC

VI 6BZ6  
REC RF

V7 6V105MT

TR301 2SC735Y

- NOTES:
1. ALL RESISTORS IN OHM 1/2% 1.0%
  2. ALL CAPACITORS IN PF UNLESS OTHERWISE NOTED.
  3. VALUE IS NOMINAL

KD6  
A

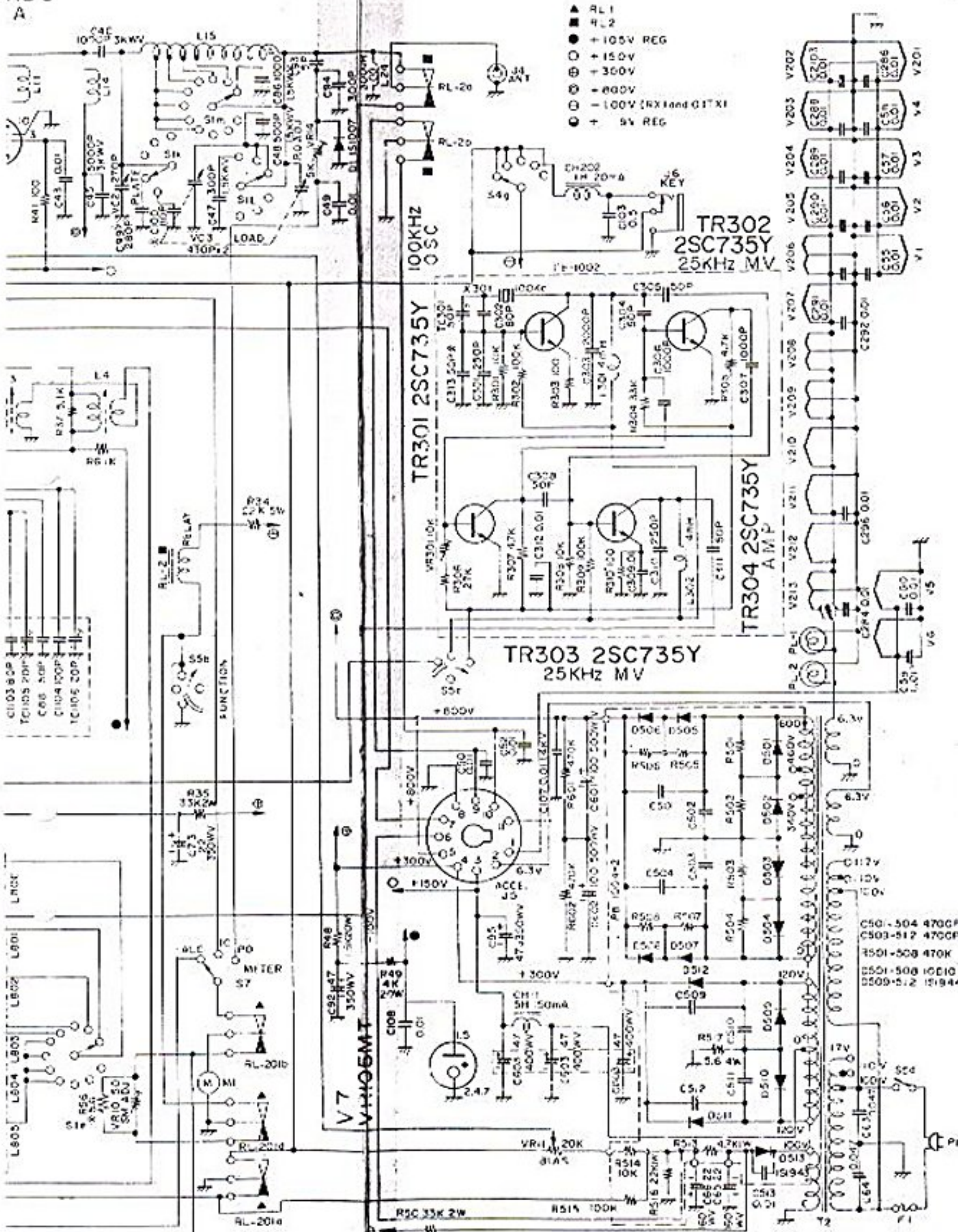

NOTES:  
 1. ALL RESISTORS IN OHM 1/2W ±10%  
 UNLESS OTHERWISE NOTED.  
 2. ALL CAPACITORS IN UF  
 UNLESS OTHERWISE NOTED.  
 3. VALUE IS NOMINAL

FDX400 / 500  
 CIRCUIT DIAGRAM