



FT-770RH OPERATING MANUAL



E2040100

YAESU MUSEN CO., LTD.
C.P.O. BOX 1500
TOKYO, JAPAN

CONTENTS

General Description	1
Specifications	2
Supplied Accessories and Options	3
Controls, Switches and Connectors	4
Installation:	
Antenna Considerations	10
Mobile Installation	10
Base Station Installation	13
FTS-8 Tone Squelch Unit Installation	14
FVS-1 Voice Synthesizer Unit Installation	16
Operation:	
Initializing and Basic Checkout	18
General Operating Features	
(1) VFO Selection	22
(2) Frequency Selection	22
(3) Single-Frequency Memory Storage	23
(4) Storage of Transmit Frequencies	25
(5) Memory Erasure	25
(6) Memory Selection and Recall	26
(7) Frequency Scanning with a VFO	27
(8) Memory Scanning	28
(9) Programmable Memory Scan (PMS)	29
(10) Priority Channel Monitoring	30
(11) Tone Squelch (CTCSS) Functions	31
(12) Voice Synthesizer FVS-1	34
Memory Backup Information	35

YAESU FT-770RH SYNTHESIZED 70cm FM MOBILE TRANSCEIVER

The FT-770RH is a synthesized, compact 25-watt FM transceiver for the 70cm amateur band. A die-cast aluminum "duct-flow" forced-air chassis serves as a heatsink while providing excellent shielding, assuring cool clean operation even in the roughest environments. Three watts low power is also switch selectable from the front panel.

Two 4-bit CPUs provide simple and convenient control of 10 memory channels and dual VFOs with lithium cell backup. Yaesu's "PMS" (programmable memory scan) system allows scanning between two memory channels. A MHz stepping button and priority channel checking are provided, along with selectable scan resume on carrier drop or timed resume. Eight independently programmable transmit/receive memories and programmable standard shifts plus one-touch reverse allow the operator total freedom in all kinds of repeater operation. A burst tone generator is built-in, and when the optional FTS-8 Tone Squelch Unit is installed, any of 37 standard CTCSS (subaudible) tone frequencies can be displayed, selected and programmed into the memories channels for either silent monitoring or encode-only operation.

The comfortable green-lit LCD display shows the complete operating status of the transceiver, including memory and call channel selection and the CTCSS mode and tone frequency (if FTS-8 installed). A ten step two-color LED bar PO/S-meter indicates relative power output or received signal strength.

A deluxe scanning microphone is supplied with the FT-770RH (US version includes DTMF pad). A "speak" button is provided on the microphone to activate Yaesu's own (optional) Voice Synthesizer Unit, which gives you the operating frequency, selected VFO and CTCSS frequency (if FTS-8 installed), so you can keep your eyes on the road.

SPECIFICATIONS

General Receiver Transmitter

Frequency range	per local requirements (see Model Chart)
Channel steps	(see Model Chart)
Mode	F3 (F3E)
Antenna impedance	50 ohms, unbalanced
Supply voltage	13.8 VDC \pm 15%
Supply current	FT-770RH: 6A @25W TX, 2.5A @3W TX 0.6A RX (stby)
Oper. temp range	-10 to +60°C
Case size	140(W) x 40(H) x 162(D) mm
Weight	Approx. 1.2 kg
Circuit type	Double conversion superheterodyne
First IF	21.6 MHz
Second IF	455 kHz
Sensitivity	0.2uV for 12dB SINAD; 1uV for 30dB S+N/N
Selectivity	\pm 7.0 kHz (-6dB), \pm 14 kHz (-60dB)
Image rejection	60dB or better
Audio output	1.5W into 8 ohms for 5% THD, or better
Ext Speaker imped.	4 to 16 ohms
RF output	FT-770RH: 25W/3W selectable
Modulation	Variable reactance
Deviation	\pm 5 kHz
Maximum bandwidth	16 kHz
Spurious emissions	-60 dB or better
Stability	\pm 5ppm (-5 to +50°C)
Microphone imped.	600 ohms

Specifications subject to change without notice.

FT-770RH Model Chart

Type	Freq. Coverage (MHz)	Channel Steps (kHz)	Rptr Shift (MHz)	Tone Burst (Hz)
A	440-450	12.5/25	\pm 5.0	1800
B	430-440	12.5/25	\pm 7.6	1750
C	430-440	12.5/25	\pm 1.6	1750
X	430-440	12.5/25	\pm 5.0	1800

Supplied Accessories

MMB-26	Mobile Mounting Bracket
MH-14A8	Scanning Hand Microphone (MH-15A8 w/DTMF for USA)
STAND-1	Wire Stand for desktop operation
	Fused DC Power Cord
	Spare fuse (10A)

Options

FTS-8	Tone Squelch Unit
FVS-1	Voice Synthesizer Unit (English)
SP-55	External Speaker
MH-14B8	Scanning Hand Speaker/Microphone
MH-15A8	Scanning Hand Microphone w/DTMF keypad
MF-1A3B	Boom Microphone with flexible arm
YH-1	Headset (w/microphone)
SB-10	PTT Switch Unit for use with MF-1A3B and YH-1

Note: certain options may be included as standard accessories according to local needs or popularity.

CONTROLS, SWITCHES AND CONNECTORS

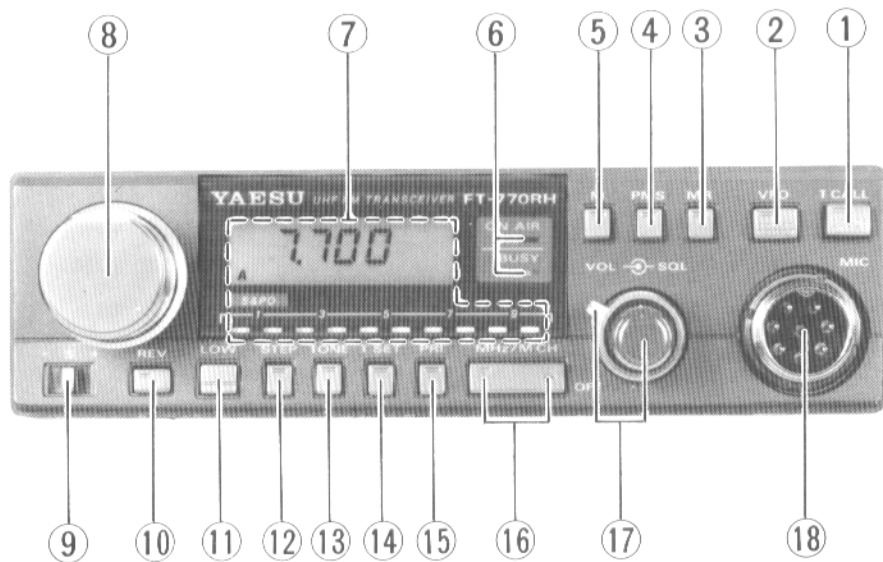

(1) T CALL

Press this button to transmit the 1750 or 1800 Hz Burst Tone for accessing repeaters that require it. The tone is sent only while the button is depressed.

(2) VFO

This button recalls VFO operation from the memories, or selects the alternate VFO (A or B).

(3) MR

Press this button (Memory Recall) to recall the memory mode from VFO operation, or to erase memory data as described in the "Operation" section.

(4) PMS

This momentary switch activates the PMS (Programmable Memory Scan) function, described in detail under "Operation".

(5) M (Memorize)

This button stores the displayed VFO frequency into the selected memory channel, and masks and unmasks selected channels for memory scanning.

(6) LED Indicator Lamps

ON AIR

This (red) lamp is lit whenever the transmitter is active.

BUSY

This (green) lamp is lit whenever the main receiver squelch is open. When the optional FTS-8 Tone Squelch Unit is used in the encode/decode mode, this lamp indicates whether the frequency is occupied.

(7) LCD (Display) and LED Bar Meter

The LCD indicates the operating frequency and functions as shown in the diagram below. Just below the LCD is the PO/S LED bar meter, which gives a relative indication of transmitter power output and receive signal strength.

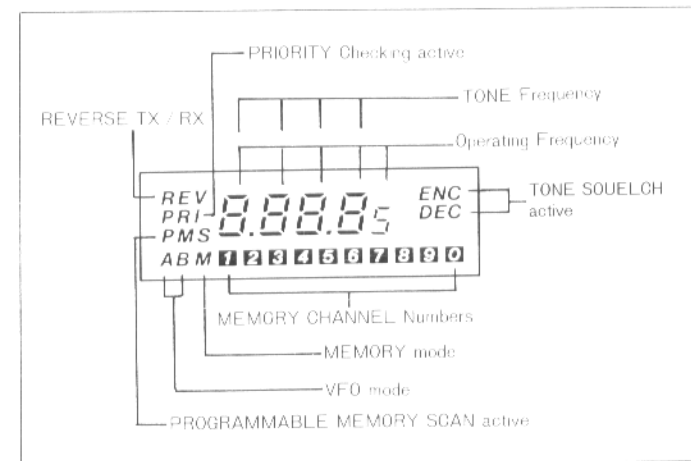

(8) Main Dial

This detented knob selects the operating frequency. If the transceiver is in the memory mode turning this knob will change operation to the VFO, but on the memory channel frequency. The Main Dial is also used to select the CTCSS tone frequency when the FTS-8 is installed.

(9) - S + (Shift)

This 3-position slide switch selects simplex or standard repeater shifts when operating on a VFO or single-frequency memory. It must be set to "S" when operating from a memory having both transmit and receive frequencies preprogrammed.

(10) REV (Reverse TX/RX)

Press and hold this button to exchange transmit and receive frequencies during repeater operation (except on a memory programmed with separate transmit and receive frequencies). REV appears on the display when this function is active.

(11) LOW Switch (Low Power)

This 2-position pushbutton switch selects 3-watt power output when depressed.

(12) STEP

This momentary pushbutton selects 12.5 or 25 kHz steps for tuning and scanning.

(13) TONE

This momentary pushbutton selects the function of the optional FTS-8 Tone Squelch Unit. Modes are Encode only (ENC displayed), Encode/Decode (ENC DEC displayed), or CTCSS off.

(14) T SET (Tone set)

When the FTS-8 is installed, press this button to check or set the CTCSS tone without activating the CTCSS system. The selected tone frequency (in Hz) will appear on the display.

(15) PRI (Priority Function)

This button activates periodic checking of the current memory channel when operating on the VFO. If a signal is found, operation shifts to the memory. Note that the main squelch level must be set properly for the priority function to work.

(16) MHz/MCH

This double button steps the VFO up and down in 1 MHz steps, or the memory channel up and down. Also, when the FTS-8 is installed and the T SET mode selected, the CTCSS tone frequencies are selected by this button. Stepping repeats while this button is held.

(17) VOL \rightarrow SQL

The inner VOL control is the power on/off switch and volume control. The fully counterclockwise (click-stop) position is OFF. Turn the control clockwise out of the click-stop to increase the volume.

The outer SQL control sets the threshold level at which received signals will open the squelch. When the squelch is open the green BUSY LED on the front panel will be lit.

(18) MIC (Microphone) Jack

This 8-pin jack accepts microphone input, scanning control and voice synthesizer keying (when FVS-1 installed).

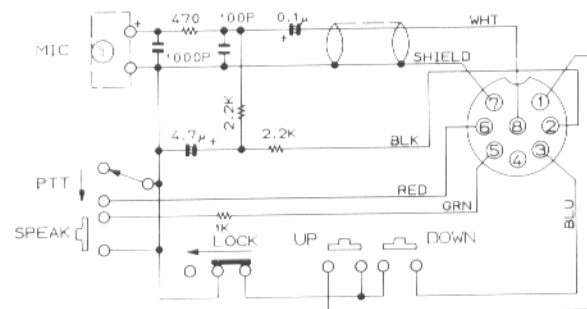

MH-14A8 Microphone
CIRCUIT DIAGRAM

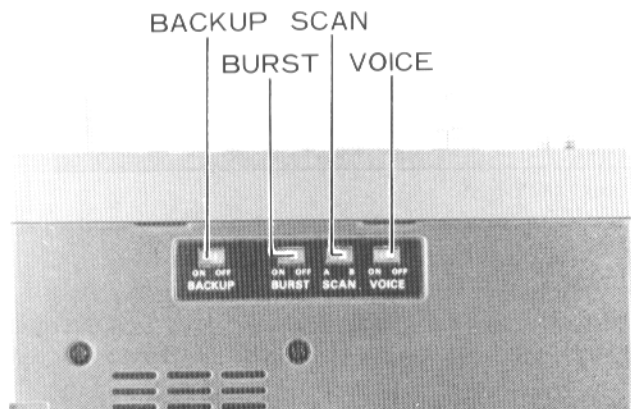

(19) Bottom Cover Slide Switches

BACKUP (on/off)

This is the switch for the memory backup lithium battery. It is set to off at the factory, and should be turned on and left on except when the transceiver is to be stored without use for a long period of time.

BURST (on/off)

This switch enables automatic tone burst, which causes a 1/2-second burst tone (1750 or 1800Hz) to be sent automatically whenever the PTT switch is closed to start transmission. Unless this access tone is required for most of the repeaters in your area, this switch should be set to OFF.

SCAN (A/B)

This switch determines the resume function of the automatic scanner. "A" selects automatic resume scanning after six seconds, and "B" selects automatic resume after carrier drop.

VOICE (on/off)

This switch selects automatic activation of the optional FVS-1 Voice Synthesizer, when installed. When OFF the radio will only speak when the **SPEAK** button on the microphone is pressed. When ON, the radio will speak whenever one of the (announced) operating modes or parameters is changed.

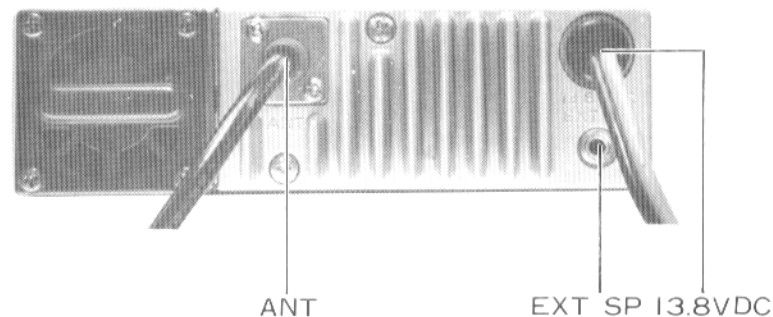

(20) Rear Panel Connectors

13.8 VDC

This is the 13.8 volt DC power cable. Make certain that this cable is always connected with the RED lead positive, and that the supply voltage never exceeds 15V DC. Mobile installations require that the vehicle have a negative ground electrical system. AC voltage must never be connected here.

EXT SP (External Speaker Jack)

If desired, an external 4- to 16-ohm speaker may be connected to this 1/8-inch 2-conductor mini phone jack. The internal speaker is disabled when this jack is used.

ANT

Your 70cm antenna cable should be connected to this in-line jack, using a type "N" coaxial plug.

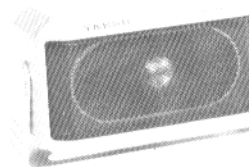

SP-55 External Speaker

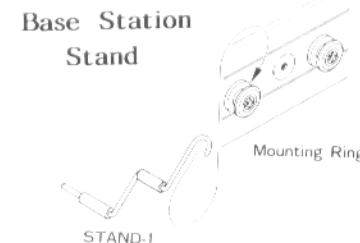

INSTALLATION AND CONNECTION

Antenna Considerations

The FT-770RH is designed for use with an antenna having an impedance near 50 ohms at the operating frequency. For best performance use only a high-quality, carefully designed antenna and the shortest possible length of the best coaxial cable feedline available, with the proper connector to match the jack on the transceiver. The antenna should be connected at all times when power is on, to avoid damage that might otherwise result if transmission occurs when no antenna is connected.

Mobile Installation

The FT-770RH must only be installed in cars having a negative ground electrical system. It should be located where the display, controls and microphone are easily accessible, and should be securely affixed using the supplied MMB-26 mobile mounting bracket. The transceiver may be installed in any position, but it should not be mounted near a heater vent or where it could interfere with safe operation of the vehicle. Also make sure that plenty of space is provided at the left side and rear of the transceiver so that the forced-air cooling system can operate freely. Refer to the diagrams on the facing page for installation of the MMB-26.

- (1) Use the mounting bracket as a template for positioning the mounting holes, after determining the proper location with sufficient clearance for the transceiver. Use a 3/16" bit for drilling the holes. Secure the bracket with the screws, washers and nuts supplied, as shown in Figure 1.
- (2) Screw the mounting rings to the transceiver using the supplied spacers and flat washers as shown in Figure 2. Be sure that the rings are oriented as shown.
- (3) Referring to Figure 3, align the mounting rings with the notches in the bracket, and slide the transceiver backward and upward into the bracket until it snaps into place.

To remove the transceiver from the bracket, pull it straight forward, with slight upward pressure at the rear, if necessary.

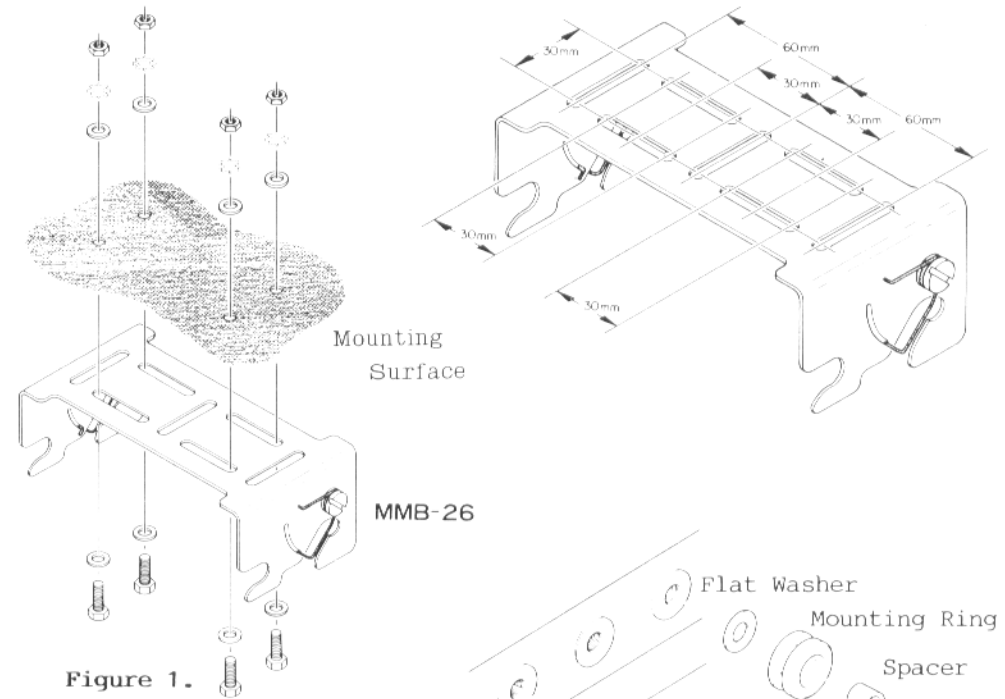

Figure 1.

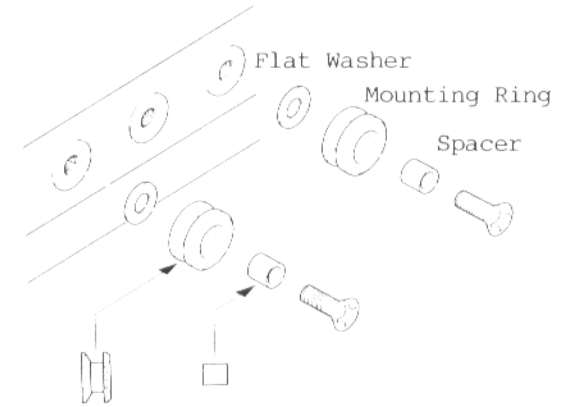

Figure 2.

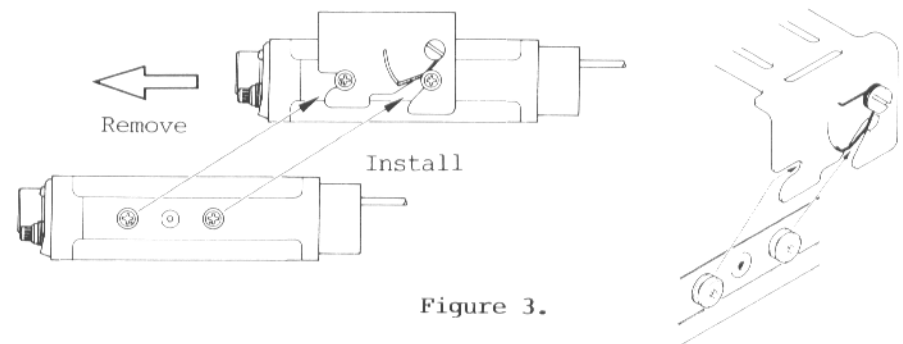

Figure 3.

Power Connection

Before connecting the power cable the maximum battery charging voltage should be checked to ensure that it remains below 15V when the engine is run fast. If more than 15V, the voltage regulator of the car should be adjusted before connection.

Power connections should be made directly to the automobile battery, using the supplied cable with 10A inline fuses. Connection to the cigarette lighter or other accessory circuit may cause the fuse to blow in that circuit. Connecting the supplied DC power cable to the battery independently of the rest of the automobile electrical system will minimize possible noise pickup and supply voltage drop during transmission.

Do not connect any power to the transceiver except via the supplied fused cable, and do not attempt to defeat or bypass the fuses - they are there to protect you and the equipment.

Connect the RED lead of the power cable to the POSITIVE (+) battery terminal, and the BLACK lead to the NEGATIVE (-) terminal. If it is necessary to extend the power cable, use #16 AWG or larger insulated, stranded copper wire, and always use the minimum power cable length practicable to keep voltage drop minimal.

*** * * * * WARNING * * * * ***

NEVER APPLY AC POWER TO THE REAR PANEL POWER JACK OF THE TRANSCEIVER. NEVER CONNECT DC VOLTAGE OF MORE THAN 15 VOLTS TO THE POWER JACK. ALWAYS REPLACE FUSES WITH THE PROPER (10A) RATING. FAILURE TO OBSERVE THESE PRECAUTIONS WILL VOID THE WARRANTY.

Connect the power cable to the short pigtailed on the back of the transceiver; red-to-red and black-to-black, as shown below.

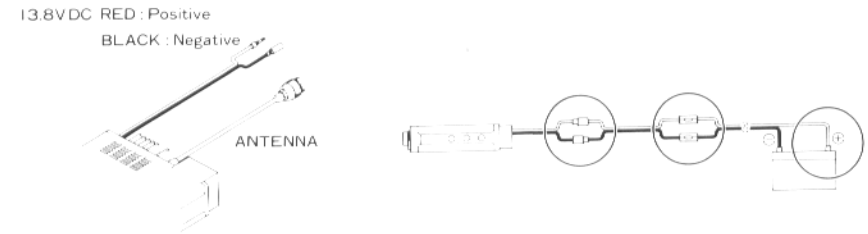

The SP-55 External Speaker (shown on page 9) is an optional accessory that allows the source of audio from the transceiver to be positioned for most comfortable hearing. Especially practical for the noisy mobile environment, the SP-55 includes its own swivel-type mounting bracket, and is available from your Yaesu dealer.

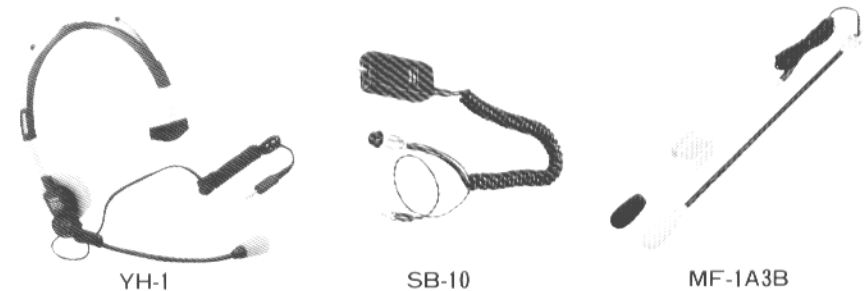

Also available to enhance safety and mobile operating convenience are the YH-1 Headset with miniature boom microphone, and the full size MF-1A3B boom microphone with flexible arm (both of which use the SB-10 PTT switch).

Base Station Installation

A base station mounting stand is supplied with your transceiver, to provide easy viewing of the display, and clearance for the internal speaker. A power supply capable of providing at least 9A continuously at 13.8VDC is required for operation from the AC line. The FP-700 AC power supply is available from your Yaesu dealer for this purpose. Use the fused DC power cable supplied with the transceiver for power connections.

FTS-8 TONE SQUELCH UNIT INSTALLATION

The FTS-8 provides either encode-only or encode/decode operation with 37 front panel selectable subaudible CTCSS tones, and is available for all versions FT-770RH, from your local Yaesu dealer. See the "Operation" section for how to use it.

1. Disconnect the power cable at the rear of the transceiver, and remove the three screws affixing the top cover (see below). Remove the cover by lifting the back slightly before sliding it back and the lifting it away.
2. Locate the two white connectors on the Main Board just behind the tuning knob, and remove the jumper wire from the rear-most connector.
3. Position the FTS-8 so that the connecting pins are aligned with their mating connectors as shown in the photo on the facing page, and gently press the FTS-8 into place.
4. If the FVS-1 Speech Synthesizer Unit is also to be installed now, proceed to Step 2 on page 16, otherwise, replace the top cover in the reverse manner from which it was removed. The output tone level (VR1 on the FTS-8) is adjusted at the factory for the proper deviation, so no adjustment should be necessary.

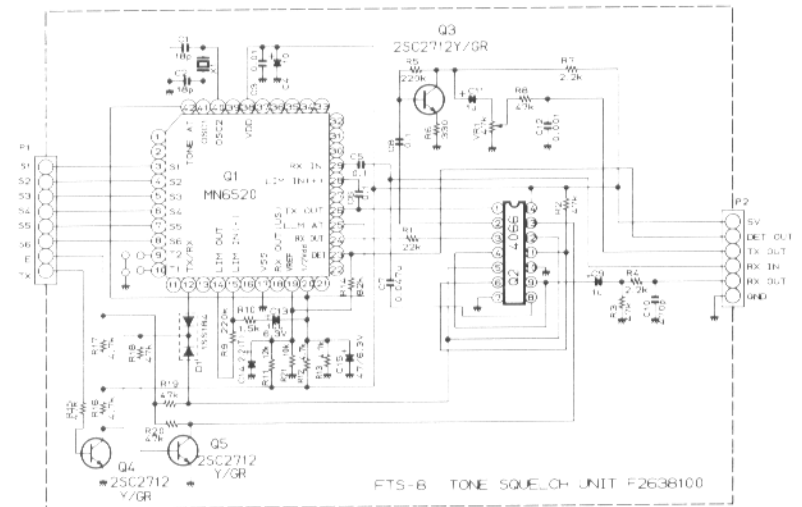
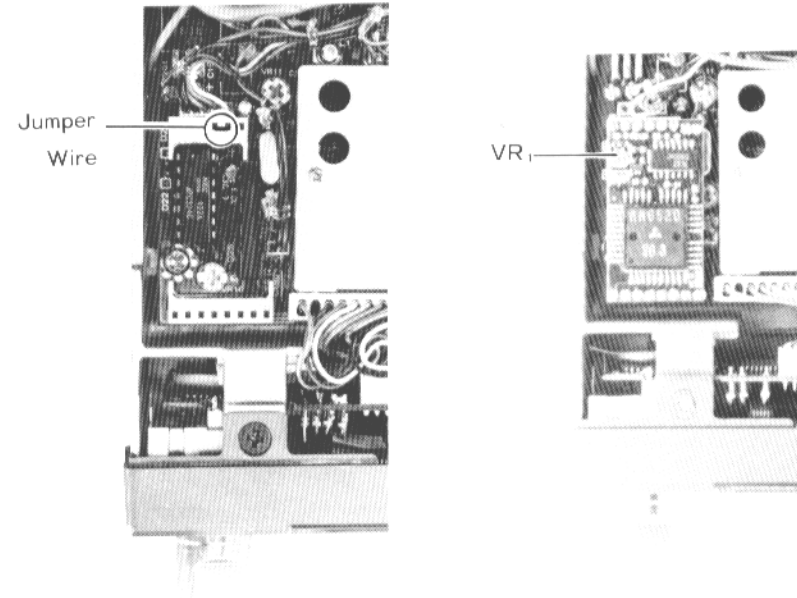
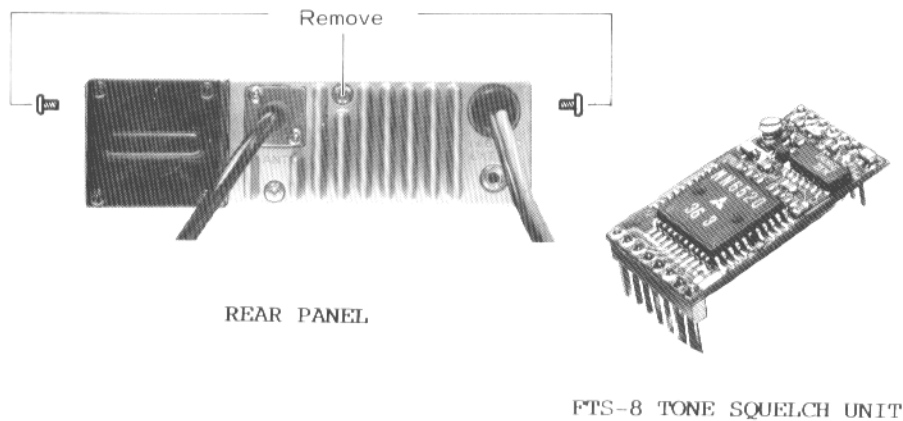

FVS-1 VOICE SYNTHESIZER INSTALLATION

The FVS-1 provides automatic and/or manually actuated synthesized voice readout of VFO and memory frequency, and tone squelch frequency if the FTS-8 is installed. See the "Operation" section for details.

1. Disconnect the power cable at the rear of the transceiver, and remove the three screws affixing the top cover (see below). Remove the cover by lifting the back slightly before sliding it back and the lifting it away.
2. Remove the three screws affixing the bottom cover (see below). Lift the cover away slowly, using care not to pull on the speaker wires.
3. Remove the four screws affixing the front panel at the top and bottom of the set, and then pull the front panel away slightly so as to permit access to the cpu circuit board on the inside of the front panel.
4. Locate the (unconnected) miniature 10-pin connector in the space between the front panel subchassis and the main chassis, and carefully mate this connector to its counterpart on the FVS-1. Use the supplied double-sided adhesive tape to affix the flat surface of the IC on the FVS-1 to the flat surface of the cpu in the transceiver, as shown on the facing page.
5. Replace front panel screws, and the top cover in the reverse manner from which it was removed. Then replace the bottom cover and its screws, using care to ensure that the speaker leads are secure on the speaker, and that no wires are pinched between the covers. The output level (VR1 on the FVS-1) is aligned at the factory, so no further adjustment is necessary.

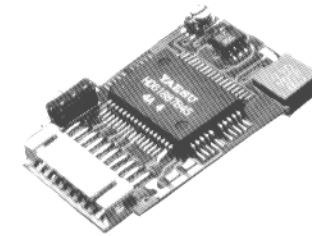
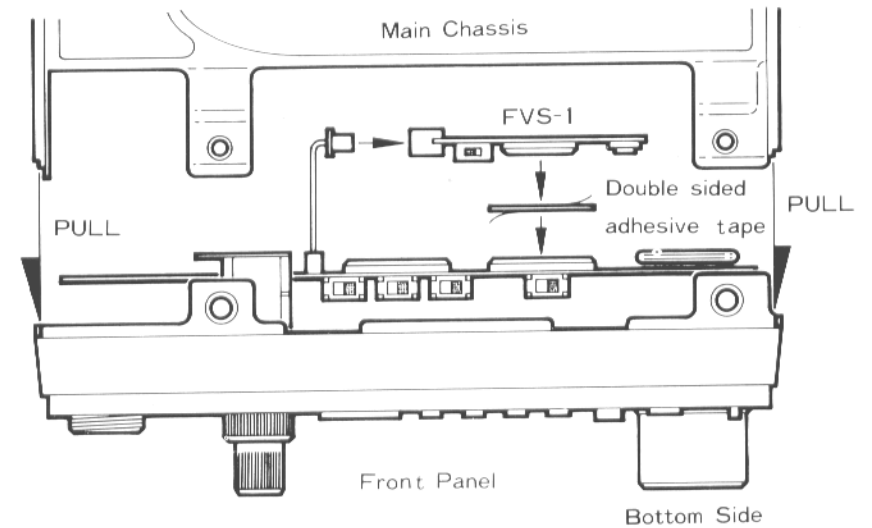
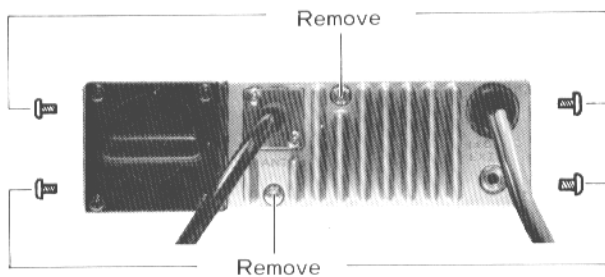

FVS-1 VOICE SYNTHESIZER UNIT

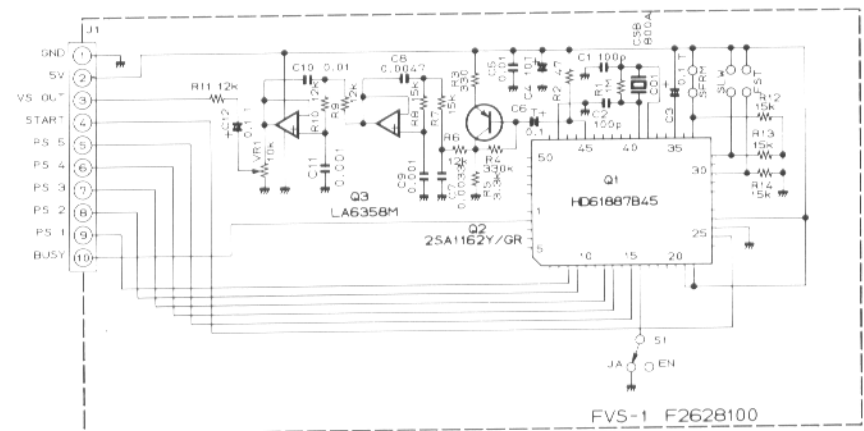

OPERATION

Please read this section carefully. Your enjoyment and efficient operation of this transceiver depend on a clear understanding of how the various controls and switches work together for best performance.

Before proceeding, be certain that a proper antenna for the 70cm band is connected, and that a DC supply of the proper voltage (13.8V DC, negative ground) is connected to the power cable, RED positive.

Preset these controls and switches as follows:

VOL fully counterclockwise into the click-stop (off)
SQL fully counterclockwise
LOW button depressed
- S + switch in the center "S" position
BACKUP (bottom cover) **OFF**

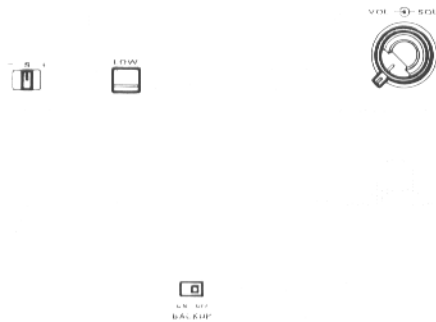

Initializing and Basic Checkout

(1) Rotate the VOL control clockwise out of the click-stop. The panel lamps should come on and the BUSY and ON AIR lamps will blink before frequency data appears on the display. Advance the VOL control for a comfortable level of noise or signal from the speaker.

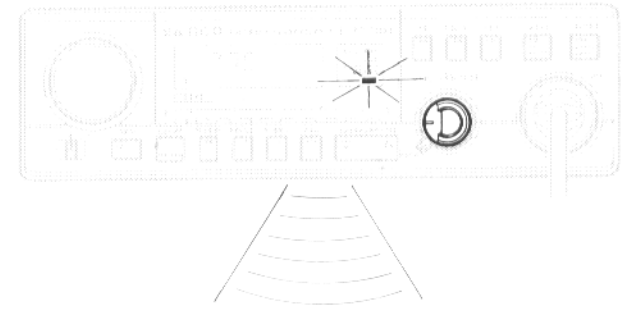

(2) Now set the BACKUP switch on the bottom cover to the ON position. Switching on the power when the BACKUP switch is off resets the cpu, and switching on the backup allows all operating data to be retained in memory until the backup switch is again turned off.



(3) Rotate the dial to an unoccupied channel, if necessary, and then rotate the SQL control clockwise until the noise just disappears and the BUSY lamp turns off. This is the point of maximum squelch sensitivity, where the SQL control should be kept for all except special situations where reduced sensitivity is required (such as when awaiting a call from a strong local station). The BUSY lamp will be lit whenever the main squelch is open.

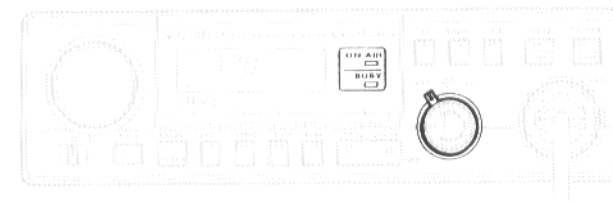

- (4) Press either side of the **MHz/MCH** button to change frequency in 1 MHz steps. At the edge of the band the kHz digits will be cancelled, and then the VFO frequency will automatically jump to the far edge of the band.



- (5) Rotate the dial to observe channel selection. Now press the **STEP** button and turn the dial again to observe the half-step tuning function. Note that the UP and DWN scanning buttons on the microphone, if pressed only momentarily, can also be used to step the frequency. Set the transceiver to a (simplex) frequency to transmit.



- (6) Press the PTT (Push-To-Talk) switch on the microphone to transmit. The **ON AIR** lamp will light, and you can then speak into the microphone (using a normal voice). Never transmit without having a proper antenna or dummy load connected to the antenna connector. Be certain to always follow this precaution to avoid damage to the transceiver.

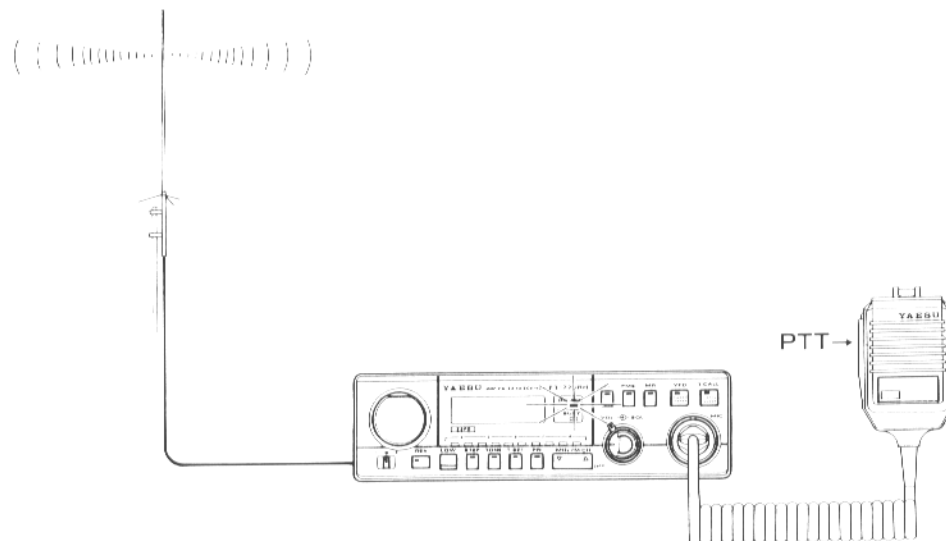

- (7) If high power operation is necessary for communication, set the **LOW** switch to the undepressed position. However, it is best to use low power whenever possible, to minimize current drain, heating and potential interference to others. This is easy to do if you just develop the habit of always keeping the **LOW** switch depressed, and just release it for the rare situations where full power is really needed.



General Operating Features

(1) VFO Selection

The two VFOs in the FT-770RH are labelled "A" and "B", indicated on the display when the transceiver is in the VFO mode. The frequency of the displayed VFO can be changed by the **MHz/MCH** button and the main knob or scanning buttons on the microphone, as indicated previously. The displayed VFO frequency can also be stored in a memory, as described later.



Each VFO is independent of the other; that is, changing the frequency of one will not affect the frequency of the other. Press the **VFO** button (while in the VFO mode) to change from VFO A to B and back.



(2) Frequency Selection

Depending on the setting of the **STEP** switch, vfo tuning steps are either 12.5 or 25kHz. The microphone **UP** and **DWN** buttons can also be used for scan tuning, by pressing and holding either button for more than a half-second. Scan tuning can be stopped by one press of the PTT switch (transmission will not occur unless the switch is released and pressed again). For large changes in frequency, however, use the **MHz/MCH** button to step to the nearest Megahertz, and then use the main knob or microphone buttons.

The VFOs can also be used to work repeaters with standard shifts, by setting the **- S +** switch to the appropriate position. When in the VFO mode the **REVERSE** button can be pressed to exchange the transmit and receive frequencies (while the button is held).

(3) Single-Frequency Memory Storage

The FT-770RH has ten memory channels, numbered 1 through 9 and 0, all of which can be used for storing frequencies directly from the VFOs. However, memories 1 through 8 can also be used to store transmit and receive frequencies independently for split-frequency operation, such as for repeaters, while memories 9 and 0 have a special application in the PMS system described later.

Before storing a frequency in memory, it must be selected on VFO A or B as described in the preceding section. Then press the **M** button once. This activates the memory status checking mode for six seconds, which shows you (on the display) the status of all of the memories. The status indicators are a blinking **M** at the left just below the frequency display, indicating the memory status mode; followed by one or more channel numbers in small black squares, one of which will also be blinking. The blinking channel is the one that is the currently "selected" one, ie., the channel that was last selected and which will be the one to be stored by the following steps. The presence (or absence) of other channel numbers simply indicates whether they are currently holding data or not.



Initially, before any memories have been stored, only a blinking 1 will appear, signifying that memory 1 is selected (by default) for storing, and that all other memories are vacant. The selected "blinking" memory may be changed while in the memory status mode, using the **MHz/MCH** button. If no other buttons are pressed within the six-second memory status check, that mode will cancel and everything will return to its previous state (in the VFO mode). During the memory status mode reception on the selected VFO is not affected, although transmission, tuning and some other buttons are disabled.

Press the **M** button (again) while still in the status mode to memorize the displayed frequency in the (blinking) memory channel. The status info will disappear and operation will return to normal in the original VFO mode. To recall the memory, just press the **MR** button.

When only the receiving frequency is stored in a memory, as just described, repeater operation is possible for repeaters with standard shifts (as with each of the VFOs), by setting the **- S +** switch to the appropriate position. However, the REVerse function is not available. Memories 9 and 0 are limited to simplex and this type of repeater operation.

To store additional memories, press the **M** button to re-enter the memory status mode (from the VFO mode), and then press the **MHz/MCH** button to select the next memory for storing (the new channel number will blink).

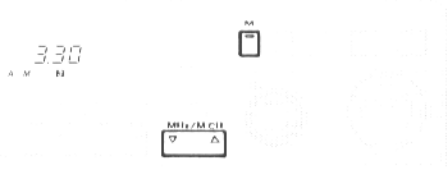

(4) Storage of Transmit Frequencies

As mentioned earlier, memories 1 through 8 have the capability of storing a transmit frequency in addition to the receive frequency. These memories thus allow the required data for all kinds of repeaters to be recalled instantly, without the need to select shift direction or any particular split. The **- S +** switch and **REV** button are disabled on memories having a separate transmit frequency.

To store independent transmit and receive frequencies first store the receive frequency as described above, and then retune the VFO to the desired transmit frequency (and make sure that the **- S +** switch is set to the center). Press the **M** button once, and then press and hold the PTT switch while pressing the **M** button again.



CAUTION: Remember to always check the **- S +** switch to be sure that it is centered before storing a transmit frequency.

While it is possible to store either the receive or transmit frequency first, it is best to store the receive frequency first, since it is not possible to recall, display or use a memory that has only the transmit frequency stored.

(5) Memory Erasure

If you make a mistake in programming a memory channel, or no longer need that channel data, you can simply overwrite it with new data. However, in cases where a separate receive/transmit memory is to be replaced with simplex data, it is too easy to

forget to change the transmit frequency, which can result in unexpected transmission on the wrong frequency. The following memory erasing procedure is recommended for use whenever a memory is to be changed.

To erase the selected memory (from the VFO mode), press **M** to enter the memory status mode, and then press the **MR** button. The selected memory will be cleared, but remain selected for immediate reprogramming, if desired. It is a good idea to keep unneeded memories clear to simplify memory checking and scanning functions.



(6) Memory Selection and Recall

To recall a memory channel when operating in the VFO mode, press the **MR** button. An **M** should be displayed at the left and just below the channel frequency, with the channel number under the frequency. If the channel number is blinking and no frequency is displayed, the memory is vacant.

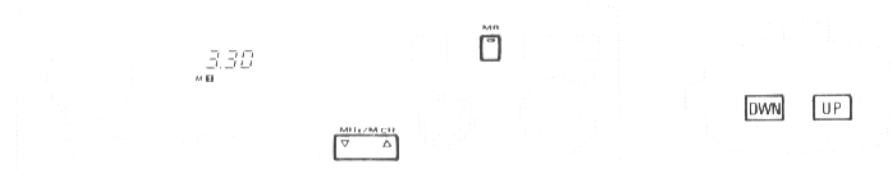

To select a different memory channel (that has already been stored) for operation, press the **MHz/MCH** button (and hold it for multi-stepping). The memory channel (M CH) function of this button is automatically selected when in the memory mode. The UP and DWN buttons on the microphone can also be used for memory channel selection, but with an additional feature described in part (8) below.

Be careful to note the setting of the - S + switch if you transmit after moving from one memory to another, since it will shift the transmit frequency of simplex memories.

(7) Frequency Scanning with a VFO

If either the UP or DWN button on the microphone is pressed and held for 1/2-second while the transceiver is in the VFO mode, scanning will commence. Once started, scanning will continue automatically, if no other buttons are pressed, for as long as the main squelch (as set by the **SQL** control) does not open, looping around at the band edges.



Scanning steps are the same as the tuning steps set by the **STEP** button, and can be reset while scanning. Pressing any front panel button except **LOW**, **MR**, **VFO** or **TCALL** will temporarily halt the scanner while it is pressed. The **LOW** button will not affect the scanner, and the other three buttons will cancel scanning and initiate their respective functions.

Whenever the main squelch is opened by a signal (assuming the **SQL** control has been set properly), the scanner will halt temporarily. If the **SCAN** switch on the bottom cover is set to the "A" position, scanning will resume automatically after about six seconds (regardless of activity on the frequency). If the **SCAN** switch is set to the "B" position, scanning will not resume until about two seconds after the received carrier drops, unless another signal appears in that time. While the scanner is halted temporarily the MHz decimal in the frequency display will blink.

Of course the scanner can be manually stopped at any time by pressing either the UP or DWN button momentarily, or the PTT

switch. If the PTT switch is used to stop the scanner the transceiver will not transmit until the switch is released and pressed again. When the scanner is stopped manually it is necessary to press and hold the UP or DWN button for 1/2-second to restart the scanner.

(8) Memory Scanning

When in the memory mode, the scanning functions just described will act on the programmed memory channels only, instead of the whole band. If you have some frequencies stored in memory that you do not want to include in memory scanning (for example, if they are too busy, or stored for use only in special situations), they can be masked from the scanner without erasing.

To mask a memory from scanning, just recall the memory, and press **M**. The channel number beneath the displayed frequency should now start to blink, and any time this channel is recalled for operation the channel number will be blinking, as a reminder that it is masked from memory scanning. Whenever memory scanning is activated, masked channel(s) will be skipped over just as though they were not there.

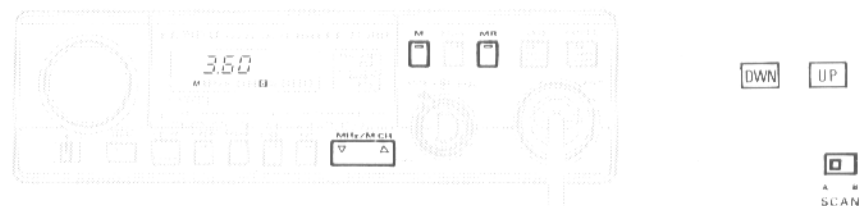

Note that masked memories can only be selected for operation by the **MHz/MCH** button, while the microphone UP and DWN buttons can be used to select only unmasked (and non-vacant) memories. This can be used to advantage for easily checking which channels are included in memory scanning.

To unmask a previously masked channel recall the memory and press **M** once again while on the memory channel. The channel number should stop blinking.

(9) Programmable Memory Scan (PMS)

The frequencies stored in memories 9 and 0 serve as the limits for limited band scanning when the PMS function is activated. This function is useful for limiting scanning to only the FM portion of the band, for example. It is generally best to store the lower frequency in memory 9, for reasons that will become obvious. After storing the desired limits in the memory channels, press the **PMS** button to activate the function.

[9] lower frequency 435.00MHz(445.00MHz) [9] upper frequency 435.10MHz(445.10MHz)

[0] upper frequency 435.10MHz(445.10MHz) [0] lower frequency 435.00MHz(445.00MHz)

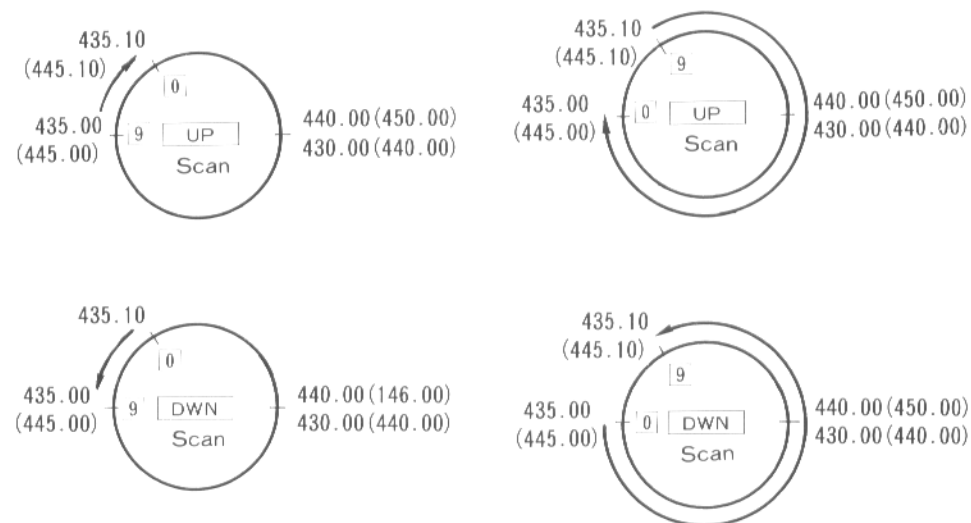

PMS will appear at the left of the display, and the displayed frequency will be that stored in memory 9 (or 0). Press the **UP** button on the microphone to scan to the frequency stored in memory 0, at which time the scanner will jump to memory 9 and continue (until halted in the usual manner described in part (7) above). Notice that if the frequency in memory 0 is lower than that in memory 9, the scanner will loop from the top of the band to the bottom and continue scanning outside of the range between memories 9 and 0 (unless, of course, the **DWN** button is used to start the scan). Press the **MR** or **VFO** button, as desired, to cancel the PMS function.

(10) Priority Channel Monitoring

During operation on a VFO it is possible to monitor a memory channel for activity. For example, if you are waiting for a call on a simplex frequency while operating elsewhere on the band (or even on the alternate band), the priority feature lets the expected call break in immediately when you are receiving on the other frequency.

To set up priority channel operation, first select the desired priority channel from among the stored memories, using the **MR** and **MHz/MCH** buttons. Then press the **PRI** button. **PRI** will appear at the left side of the display, and the (last selected) VFO frequency will be displayed. You may now go ahead and operate with that VFO in any way you like: every six seconds the display (and receiver) will shift to the memory frequency briefly (about 300ms) to check for activity, and then return if no activity is found.

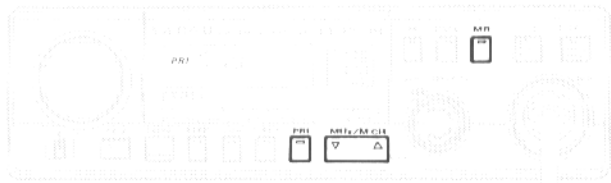

If a signal strong enough to open the squelch appears on the priority (memory) frequency when it is being checked, operation will jump to the priority frequency and priority operation cease. At that time you can respond to the calling station, and if necessary, have him wait while you press the **VFO** button to return to the VFO frequency, to announce that you have QSYed. Then press **MR** to return to the memory.

Note that if the **- S +** button is set for plus or minus repeater shift on any of the frequencies used for the above operation, it may be necessary to change its position when changing frequencies to transmit on the desired priority channel.

It is possible to combine manual band- or PMS scanning with priority monitoring, though the auto-scan features are then dedicated to the priority function. For band scanning, just activate the **PRI** button first, and then use the microphone **UP** and **DWN** buttons, holding the button down to scan, and releasing to halt. For PMS/priority scanning, the **PMS** button must be pressed first, followed by the **PRI** button and then the microphone **UP/DWN** buttons.

(11) Tone Squelch (CTCSS) Functions (FTS-8 Option req'd)

When the optional FTS-8 Tone Squelch Unit is installed either CTCSS encode only or full encode/decode operation can be selected as required. CTCSS (Continuous Tone-Coded Squelch System) uses a continuous tone below the lowest audio frequency used for speech communications, superimposed on the transmitted signal. In the encode-only mode, the subaudible tone can be used for selective access to a special repeater only by users informed of the particular CTCSS tone of that repeater.

The encode/decode mode allows silent monitoring of busy channels, since the receiver remains squelched unless a signal with the correct preset tone is detected. Some repeaters retransmit incoming CTCSS signals (allowing silent monitoring of the repeater for CTCSS calls), while others do not; so contact the repeater group for details of a particular repeater.

Before selecting the CTCSS frequency and function, set the transceiver to the VFO mode (A or B) if you plan to save the CTCSS data in a memory channel later.

To select a CTCSS tone frequency, first press **T SET**. This will cause the **ENC** and **DEC** indicators at the upper right side of the display to appear and blink, and the selected tone frequency (default = 67.0 Hz) to appear in place of the operating frequency. The tone setting function will automatically cancel after six seconds unless you press a button, but while it is active you can use the microphone **UP** and **DWN** buttons, **MHz/MCH** button or main dial to select from the 42 different tone possibilities. Refer to the FTS-8 CTCSS Tone Chart on page 34 for

the actual tone frequencies. Once the desired tone is selected, before the tone setting mode times out, press **T SET** once again to set the selected tone frequency for operation.

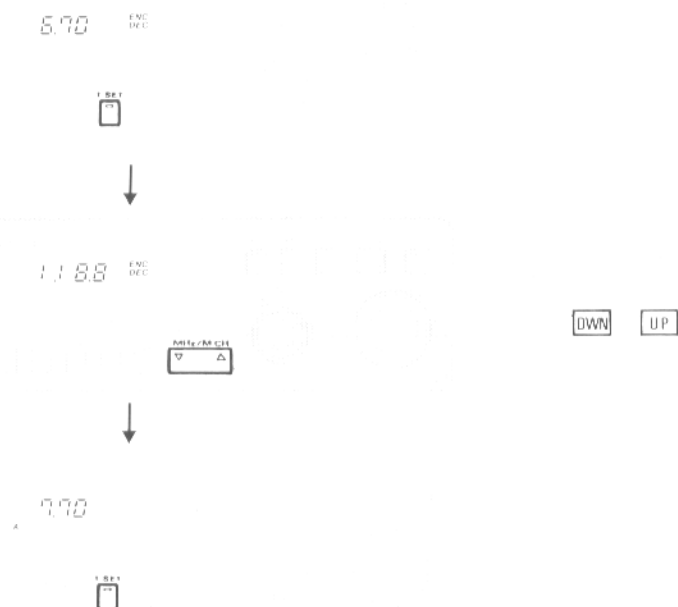

Note that the five of the tones, including the 67.0Hz default, are provided twice, once with a leading 0 and once without. Those five tone selections (between 67.0 and 88.5Hz) that do not have a leading zero have special low-Q decoder filters with $Q = 40$, providing half the tone selectivity to allow proper reception of CTCSS signals from older or less stable tone generators. All other tone selections have standard high selectivity ($Q = 80$) decoder filters.

After setting the desired tone frequency select the CTCSS operation mode, using the front panel **TONE** button. One press of the button selects encode-only, with just **ENC** displayed. In this mode the subaudible tone just selected will be superimposed on your voice signal, for repeater access or selective outgoing calls. The receiver will not be affected. Press the **TONE** button again (when **ENC** is displayed) to select encode/decode operation, displayed as **ENC** and **DEC**. In this

mode the receiver will remain quiet to all but those signals bearing a CTCSS tone identical to the one you selected. Note that the main receiver squelch can still be opened (the **BUSY** lamp lit) by other stations, but the receiver will remain quiet. This feature allows you to make sure that the channel is clear (**BUSY** off) before transmitting.

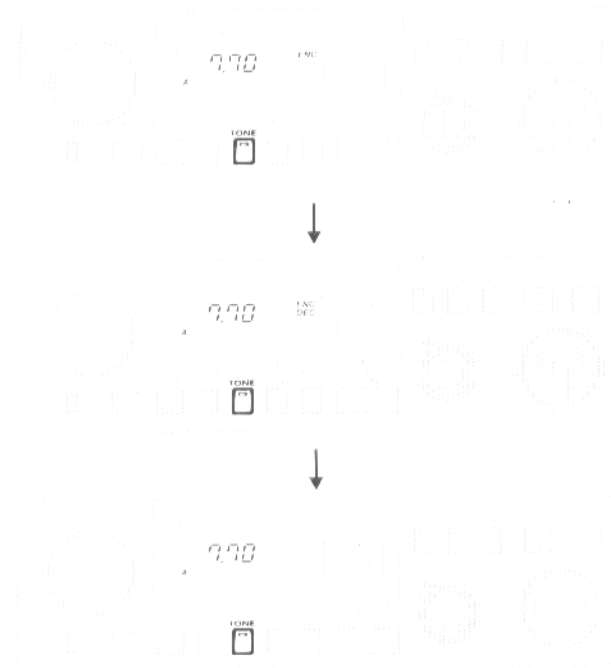

Pressing the **TONE** button once more (when **ENC** and **DEC** are displayed) will deactivate the tone squelch system.

To store the tone squelch frequency and mode in a (selected) memory, first set a VFO for the desired tone squelch data to be stored as above, and also make sure that the VFO frequency is that which you wish to store. Then press the **M** button twice, in the same way as described in part (3) above.

Note that tone squelch data can be set or reset at any time using the **T SET** and **TONE** buttons. However, if this is done in the memory mode, the new data will be only temporary while you remain on that channel. The VFOs must be used to permanently store data in the memories.

FTS-8 CTCSS Tone Chart

Frequency in Hertz (as displayed)			
67.0*	118.8	173.8	067.0
71.9*	123.0	177.9	071.9
77.0*	127.3	186.2	074.4
82.5*	131.8	192.8	077.0
88.5*	136.5	203.5	079.7
94.8	141.3	210.7	082.5
100.0	146.2	218.1	085.4
103.5	151.4	225.7	088.5
107.2	156.7	233.6	091.5
110.9	162.2	241.8	
114.8	167.9	250.3	

* Decoder Q=40, other codes have decoder Q=80

(12) Voice Synthesizer FVS-1 (Option)

When the optional FVS-1 Unit is installed, operating frequency, VFO or memory indication and CTCSS tone frequency (if used) are indicated by a female voice in English, each time one of these is changed (or the **SPEAK** button on the microphone pressed). This feature allows easy and safe operation without looking at the transceiver, such as while driving, or for visually handicapped operators.

The voice synthesizer is activated all the time when it is installed. However, when the **VOICE** switch on the bottom cover is set to OFF, it will only speak when the **SPEAK** button on the microphone is pressed. When the **VOICE** switch is ON, the radio will let you know whenever the VFO, memory or tone modes are reselected, or frequency changed. Press the **SPEAK** button on the microphone and adjust the VOL control for a comfortable volume level of the synthesized voice. In the VFO mode, the first word will be "VFO", followed by "A" or "B", and then

frequency. The format for frequency announcements is "U" (for UHF) followed by the 1MHz digit, "point" (decimal), and the kHz digits. For example, "U five point seven seven zero" indicates (43)5.770 MHz (or 445.770 MHz for the American Model). In the memory mode, the first word will be "memory", followed by the frequency in the same manner as above. In the T SET mode, the first word is "tone", followed by the selected CTCSS tone frequency in Hz.

MEMORY BACKUP INFORMATION

If the FT-770RH is exposed to high voltage "static" discharge the microprocessor circuitry in the transceiver may shut itself down. If this happens it may be impossible to change frequency or operate normally.

Before seeking repairs, you can use the built-in reset system for the microprocessor, provided for such circumstances. First turn the **VOL** control OFF, and set the bottom cover **BACKUP** switch to OFF. Then turn on the **VOL** control, and set the **BACKUP** switch back to ON. Normal operation should now return, although all previously stored memory data will have been erased. If this does not cure the problem contact the dealer from whom you purchased your transceiver for assistance.

SUMMARY OF MEMORY OPERATION FOR THE FT-770RH

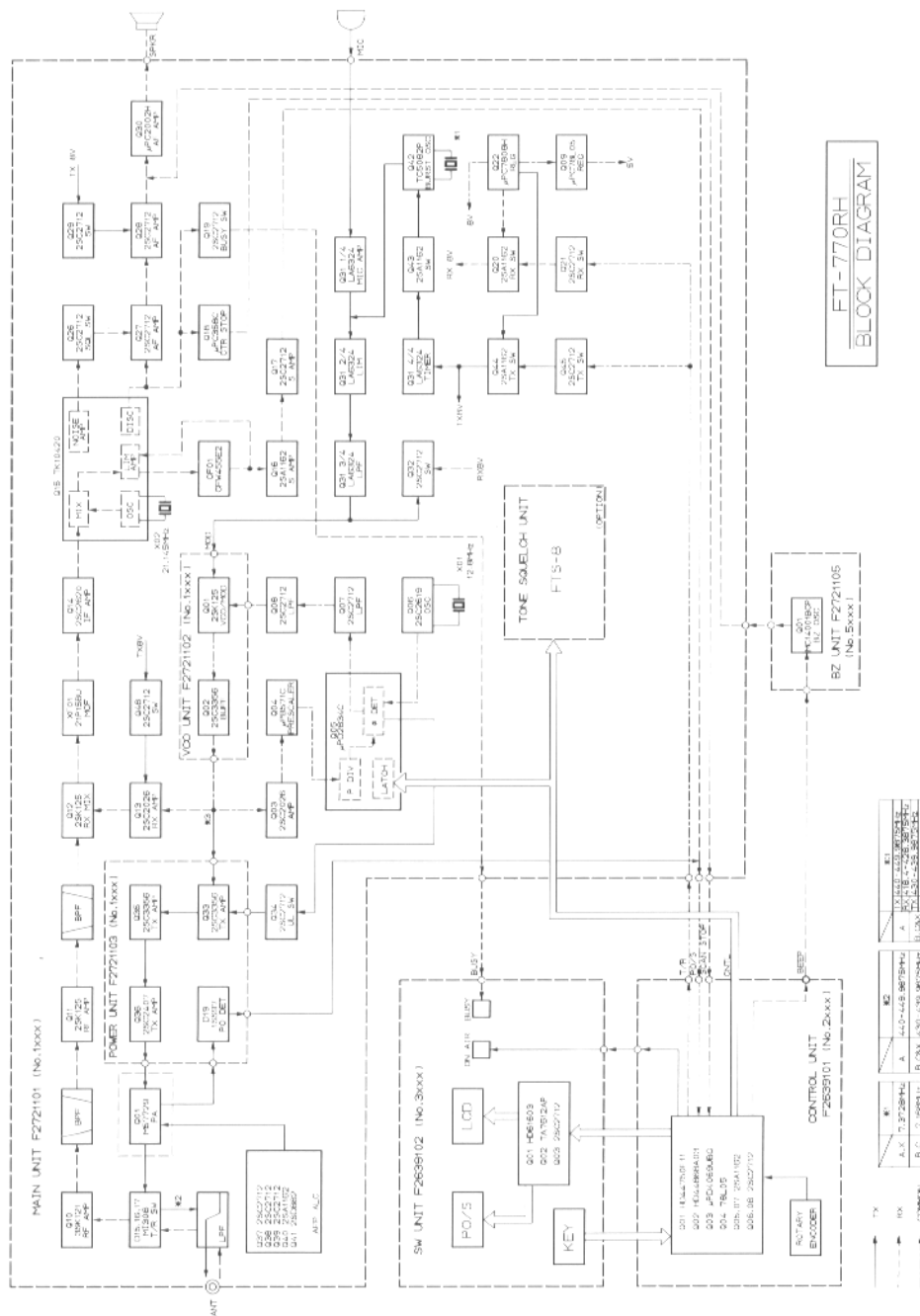

Follow this procedure to program receiving, transmitting and CTCSS tone frequencies into a memory. The optional FTS-8 CTCSS module must be installed if tone frequencies are to be stored.

- (1) Set the SHIFT selector to the "S" position.
- (2) Push the VFO button, for either A or B VFO.
- (3) Press the M button and then MHz/MCH to select the memory channel to store.
- (4) Dial the desired receiving frequency, and press the M button twice.
- (5) Dial the desired transmitting frequency, and press the M button. While the memory channel number is blinking, press the PTT switch on the microphone and hold it while pressing the M button again. Release the PTT switch.
- (6) To store a CTCSS tone in the memory, press the TONE button once for Encode-only, or twice for Encode/Decode. Then press T SET to display the CTCSS frequency. Dial the desired tone frequency and press T SET again. Then press the M button twice to store in the memory channel.

- To recall memories press MR and select with the MHz/MCH button.
- To erase the selected memory, press M and then MR.
- Note that memories can only be changed from the VFO mode.
- Remember to set the Backup switch ON to retain memories.
- To erase all memories, set the Backup switch OFF and then switch off the transceiver.

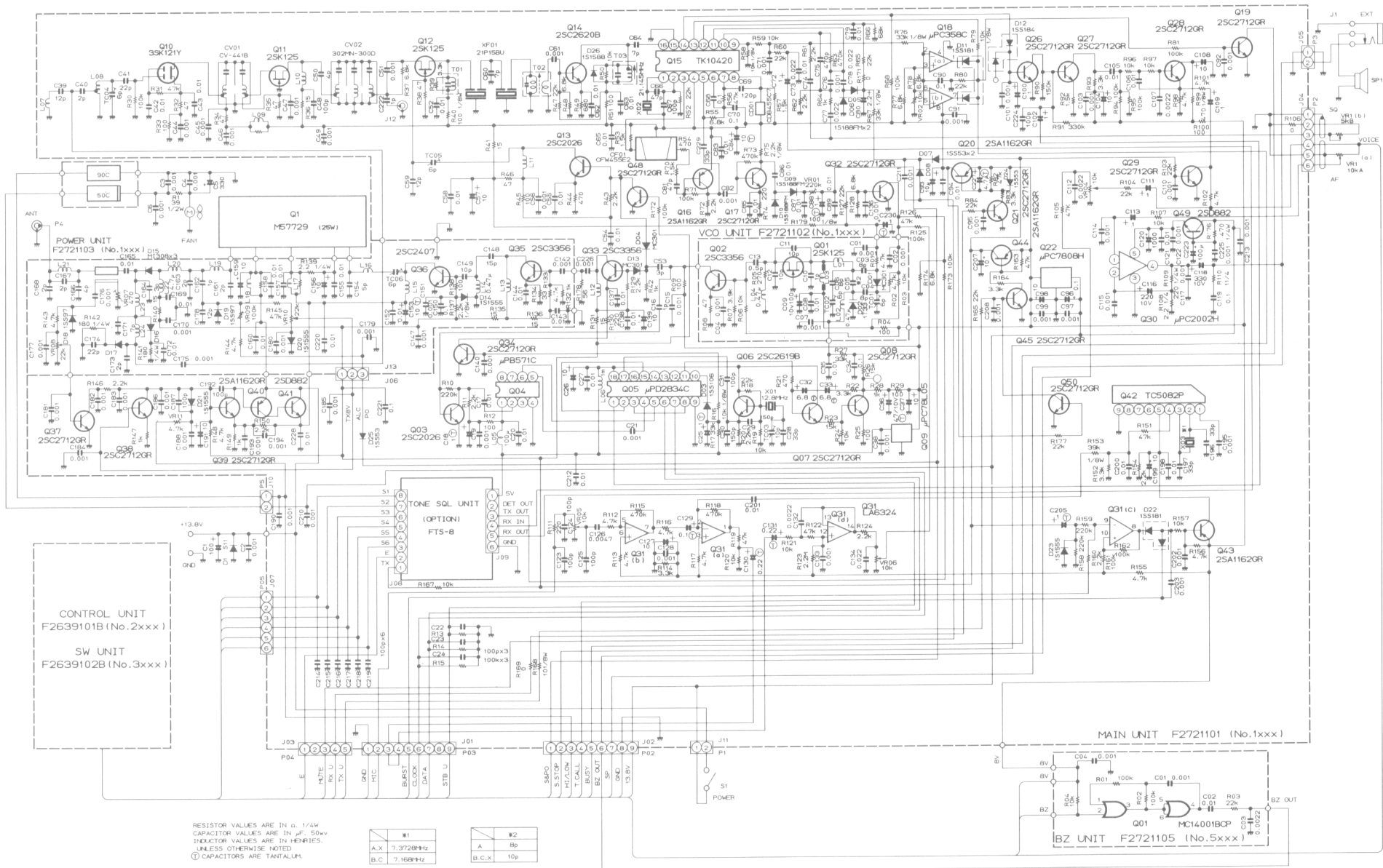

RESISTOR VALUES ARE IN Ω, 1/4W
 CAPACITOR VALUES ARE IN μF, 50V
 INDUCTOR VALUES ARE IN HENRIES,
 UNLESS OTHERWISE NOTED
 ○ CAPACITORS ARE TANTALUM.

X1		X2	
A, X	7.3728MHz	A	Bp
B, C	7.168MHz	B, C, X	10p

FT-770RH
 CIRCUIT DIAGRAM

