

FT-709R OPERATING MANUAL



YAESU MUSEN CO., LTD.

C.P.O. BOX 1500

TOKYO, JAPAN

CONTENTS

Description	1
Specifications	2
Supplied Accessories and Options	3
Top Panel Controls and Switches	4
Front Panel Controls and Switches	6
Side Panel and Bottom Switches	11
Battery Pack Information	12
Battery Removal and Replacement	13
Battery Charger Information	14
YH-2 Headset and MH-12 _{A2B} Speaker/Mic	16
Antenna Considerations and Memory Backup Information	17
FTS-6 Tone Squelch Unit Installation	18
Battery Discharge and Power Output Graphs	19
OPERATION	20
A. Frequency Entry	24
B. Storage & Recall of Frequencies in Memory	24
C. Repeater Operation (standard shift)	25
D. Frequency/Channel Stepping and Basic Scanning	27
E. Basic Priority Channel Operation	28
Advanced Operation and Special Functions	29
A. Power Saving	29
B. Calling Channel Mode	30
C. Selected Memory Scanning, Masking and Deleting	31
D. Limited Band/Programmable Step Scanning	32
E. Odd Repeater Shifts and Split-Frequency Memories	33
F. Multi-channel Priority Scanning	34
G. Tone Squelch Programming (Models A & X w/FTS-6)	35

CONTENTS

Description	1
Specifications	2
Supplied Accessories and Options	3
Top Panel Controls and Switches	4
Front Panel Controls and Switches	6
Side Panel and Bottom Switches	11
Battery Pack Information	12
Battery Removal and Replacement	13
Battery Charger Information	14
YH-2 Headset and MH-12 _{A2B} Speaker/Mic	16
Antenna Considerations and Memory Backup Information	17
FTS-6 Tone Squelch Unit Installation	18
Battery Discharge and Power Output Graphs	19
OPERATION	20
A. Frequency Entry	24
B. Storage & Recall of Frequencies in Memory	24
C. Repeater Operation (standard shift)	25
D. Frequency/Channel Stepping and Basic Scanning	27
E. Basic Priority Channel Operation	28
Advanced Operation and Special Functions	29
A. Power Saving	29
B. Calling Channel Mode	30
C. Selected Memory Scanning, Masking and Deleting	31
D. Limited Band/Programmable Step Scanning	32
E. Odd Repeater Shifts and Split-Frequency Memories	33
F. Multi-channel Priority Scanning	34
G. Tone Squelch Programming (Models A & X w/FTS-6)	35

YAESU FT-709R
DUAL CPU-CONTROLLED
70cm FM HANDIE TRANSCEIVER

From the folks who originated the cpu-controlled amateur handheld transceiver comes the finest product of its kind ever to emerge, the FT-709R. Blending the suggestions of FT-207R and FT-708R operators with the latest advances in microprocessor design and microminiature manufacturing, the FT-709R offers the operator a wealth of features far beyond anything yet conceived, in a package much smaller and lighter than any other cpu-controlled transceiver.

The FT-709R provides up to 4W RF output (with the FNB-4 Ni-Cd pack) in the high power mode, and operates in user-selectable full or half channel steps across the 430 or 440 MHz amateur band. Twenty dual-function keys on the front panel give the operator 39 different commands for programming the two 4-bit microprocessors at the heart of the FT-709R. Each of ten memory channels allows the operator to store independent transmit and receive frequencies, for any repeater shift in any channel, with touch-key reverse or simplex on either frequency.

The manual or auto-stop scanning capabilities include step-programmable full or partial band or memory bank scanning for clear or busy; skip or select channel exclusive scanning; calling channel, select memory or dial priority scanning/monitoring, and other unique yet useful functions too numerous to list, but all programmable from the front panel keypad. Yet even with all of these functions, operation remains simple: the CPU's do the work for you, keeping the number of keystrokes to a minimum.

Operational battery charge life can be greatly extended over standard squelched reception when monitoring, with Yaesu's programmable Power Saver System, which only activates the receiver to check the selected channel momentarily at programmable intervals.

A front panel multimeter indicates either battery condition or received signal strength and relative transmitter output power, with a side panel lamp button for easy viewing in the dark. The fat 1/4-inch high frequency digits on the LCD are complemented by ten memory channel indicators and nine other special function indicators, so the operator knows the exact status of all transceiver functions at a glance.

5

When the optional FTS-6 Tone Squelch Unit is installed (models A & X only), any of 37 CTCSS tones may be selected from the keypad and stored in the memories, with the particular tone stored in each channel indicated on the display along with the stored frequency and memory channel number. The state of the Tone Squelch (encode only, encode/decode or off) may also be programmed and stored in each channel. A DTMF encoder is included as standard in models A & X, while a 1750 Hz burst tone generator is included in models B & C.

The top panel includes a high/low power select switch and VOX on/off and level select switches (for completely hands-free VOX operation with the optional YH-2 Headset). Other options include the FNB-3 (425mAh) and FNB-4 (500mAh) slide-on Ni-Cd battery packs, FBA-5 battery holder (for 6 AA-size dry cells), NC-15 Quick Charger/Adapter, NC-9B/C (for FNB-3) and NC-18B/C (for FNB-4) Compact Chargers, PA-3 Mobile Adapter/Trickle Charger, MH-12_{A2B} Speaker/Mic, and MMB-21 Mobile Hanger.

SPECIFICATIONS

GENERAL

Frequency range: per local requirements (see Model Chart)
 Channel steps: 25/50 kHz
 Mode: F3 (G3E)
 Antenna: BNC female (YHA-44A rubber duck supplied)
 Supply voltage: 6-15 VDC
 Current: see Chart 1
 Case Size: 65(W) x 168(H) x 34(D) mm
 Weight: Approx. 570g w/FNB-3, 590g w/FNB-4

RECEIVER (@10.8V)

Circuit type: Double conversion superheterodyne
 First IF: 21.6 MHz
 Second IF: 455 kHz
 Sensitivity: 0.25uV for 12dB SINAD; 1uV for 30dB S+N/N
 Selectivity: 15 kHz (-6dB), 30 kHz (-60dB)
 Audio Output: 450 mW into 8 ohms for 10% THD, or better

TRANSMITTER (@10.8V)

RF input/output: see Chart 2
 Modulation: Variable reactance
 Deviation: +/-5 kHz
 Maximum bandwidth: 16 kHz
 Spurious response: -60 dB or better
 Microphone: condenser, 2 kilohms

Specifications subject to change without notice.

MODEL CHART

MODEL:	A	X	B	C
Freq. range	440-449.975	430-439.975	430-439.975	430-439.975

DIMF Encoder included as standard in Models A & X

1750 Hz Burst Generator included as standard in models B & C

FTS-6 Tone Squelch Encoder/Decoder optional for Models A & X only

CHART 1: Supply Current (mA)

<===== with 10.8V supply =====>					with 12.5V supply	
Receive	Squelched	Power Save	Transmit		Transmit	
150	45	1:1-1:10	HIGH	LOW	HIGH	LOW
		26-11	700	300	800	350

CHART 2: RF Power (W) (w/50-ohm resistive load)

	Input	Output
FBA-5*	3.0	1.8
FNB-3	4.5	3
FNB-4	6.5	4

* AA-size dry cells (6)

SUPPLIED ACCESSORIES

YHA-44A Rubber Flex Antenna

DIMF Encoder (Models A & X only)

FTE-2 1750Hz Burst Encoder (Models B & C only)

OPTIONS

FNB-3 425 mAh Ni-Cd Pack

FNB-4 500 mAh Ni-Cd Pack

FBA-5 Dry Cell battery case (for 6 AA cells)

CSC-10 Soft Case (for 709R w/FNB-3 or FBA-5)

CSC-11 Soft Case (for 709R w/FNB-4)

FTS-6 Tone Squelch Unit (Models A & X only)

YH-2 Headset

MH-12 Speaker/Microphone

NC-9B/C 117/220 VAC Compact Charger (for FNB-3)

NC-18B/C 117/220 VAC Compact Charger (for FNB-4)

NC-15 Quick Charger/DC Supply

PA-3 DC Car Adapter/Trickle Charger

MMB-21 Mobile Hanger Bracket

Note: certain options may be included as standard accessories according to local needs or popularity.

TOP PANEL CONTROLS AND SWITCHES

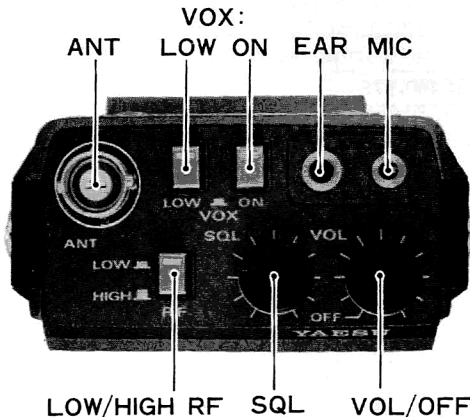

VOL/OFF Control

This is the audio volume control and power on/off switch for the FT-709R. Set this control fully counterclockwise into the OFF click-stop when the transceiver is not in use.

SQL Control

This control sets the threshold level at which received signals will open the squelch and be passed to the audio (and automatic scan stop) stages during normal reception. Whenever the squelch is open, the green BUSY LED on the front panel will be illuminated. When the optional FTS-6 Tone Squelch Unit is installed (Models A & X only) and activated as a decoder, this control sets the threshold at which the BUSY LED will light and the scanner stop, if activated.

LOW/HIGH RF Switch

This two-position push button switch selects the RF output power of the transmitter, which is approximately 300-400mW when the switch is depressed, or 3-4W when not depressed. The LOW position therefore provides extended battery life when high power is not necessary for maintaining communication.

ANT BNC Jack

This connector is for the supplied YHA-44A rubber flex antenna or other antenna system which presents 50 ohms impedance to the transceiver at the operating frequency. Do not transmit unless a proper antenna is connected to this Jack.

VOX: LOW, ON Switches

These two switches are disabled except during VOX (voice-actuated receive/transmit switching) operation with the optional YH-2 Headset. When the YH-2 is connected to the adjacent jacks, the ON button activates VOX operation when it is depressed, and the LOW button selects the level of sensitivity of the VOX switching circuit to audio at the boom microphone on the YH-2, being most sensitive when this switch is not depressed.

EAR Mini Phone Jack

This jack provides an auxiliary audio output from the receiver, for an external earphone, the optional MH-12^{A2B} Speaker Microphone or the YH-2 Headset. When this jack is used the speaker in the transceiver is disabled.

MIC Micromini Jack

This jack accepts auxiliary microphone audio input for the transmitter, from an external 2-kilohm condenser microphone such as that in the MH-12^{A2B} Speaker Microphone or the YH-2 Headset. When this jack is used the microphone in the transceiver is disabled.

	FT-709R	
	HI	LOW
FNB-4	4 W	400mW
FNB-3	3 W	300mW

FRONT PANEL CONTROLS AND SWITCHES

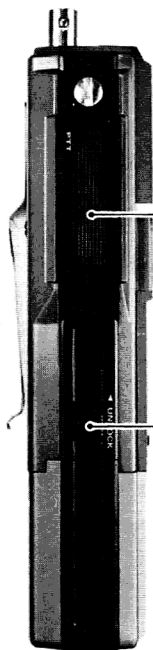
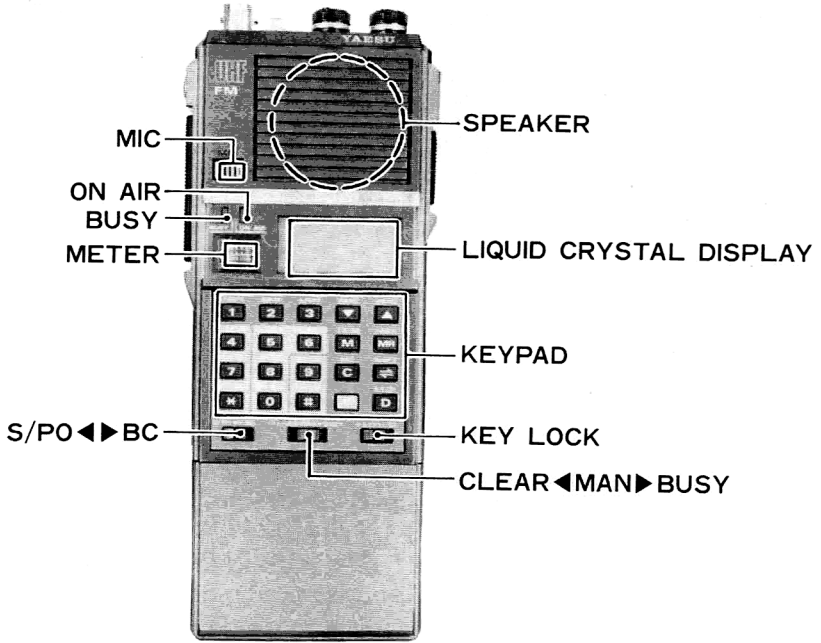

Models A & X

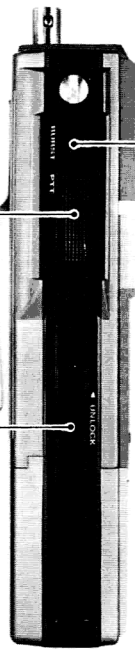

Models B & C

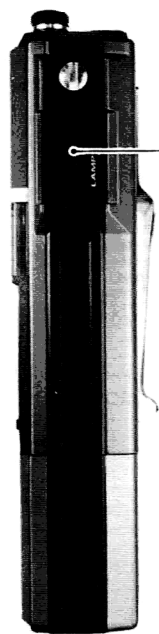

LAMP

Speaker

Behind the grill at the top of the front panel is a 36mm diameter speaker.

Liquid Crystal Display

This display shows the last several digits of the operating frequency, as well as a variety of information regarding any special functions that may be activated.

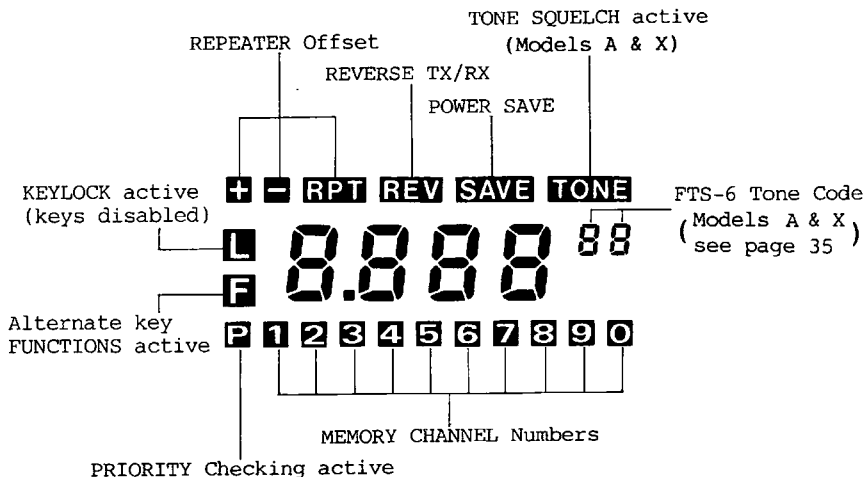

Keypad

The twenty keys on the keypad are used for selecting the frequency and various special functions of the FT-709R during reception. The number, letter or symbol on the face of each key indicates the primary function of the key, while the label on the panel just above each key indicates the alternate function, activated by pressing the "F" key, which will cause an F to appear to the left of the frequency on the display. All keypad operation is disabled unless the KEY LOCK switch below the keypad is set to the left (off), and only the leftmost twelve keys are active (Models A & X only, as DTMF encoder) during transmission. Following is a description of the primary function of each key (during reception). The special "shifted" functions are described later in the Operation section of this manual.

Numbered Keys

The keys numbered 1 through 9 and 0 are used to select frequencies, either digit-by-digit (by pressing the D key last), or by recalling a memory channel (by pressing the MR key after the channel number 0-9). During transmission these plus the *, #, ▼, M, C and F keys generate DTMF tones (in Models A & X only).

▲ Scan Up or ▼ Down

Press these keys momentarily to increment or decrement the operating frequency one step. Press and hold the key in for more than one second to engage the scanner. If pressed while operating on a memory channel, stepping and scanning will be through the memory channels.

[M] Memorize

This key stores the dial frequency into a memory channel if the channel number (only) is pressed prior to this key. Otherwise, if only this key is pressed when operating in the dial mode, the numbers of the channels which currently have data stored will be displayed briefly, below the dial frequency.

[MR] Memory Recall

This key recalls any memory channel if the channel number is pressed prior to this key. Otherwise, if only this key is pressed when operating in the dial mode, the last memory channel (selected previously) will be recalled. In either case, the channel number of the recalled memory will be displayed below the channel frequency. If an invalid channel number (>9) is keyed in first, Err will be displayed briefly, and operation will remain as before.

[D] Dial Mode

After keying in a frequency on the keypad, press this key to actually enter the displayed data into the CPU and execute the change in frequency. Prior to pressing this key one of the display digits should be blinking. After pressing this key the blinking will cease and the MHz decimal will appear. If this key is pressed while receiving on a memory, operation will shift to the last frequency used in the dial mode (and the memory channel number below the frequency display will disappear). Note that the dial mode functions as an eleventh memory.

[C] Clear Error

The CPUs in the FT-709R have been programmed to recognize most of the possible errors that can be made at the keypad, and thus will automatically return to normal operation after briefly displaying Err. However, if an

undesired digit is accidentally pressed during operation or keypad entry, this key can be used to cancel the (last) key command. This key is thus provided in respect to "Murphy", for those elite operators who find themselves prey to his laws, or those disciples of his who dedicate themselves to finding ways to befuddle microprocessors. If in doubt, press this key.

[⇌] Exchange

During split frequency operation, such as through a repeater, this key allows instant exchanging of the transmit and receive frequencies.

[✱] Call CH Recall

This key instantly recalls channel 0, regardless of the last operating mode. Thus if the local calling channel is programmed in memory 0, it can be accessed quickly with just a single key. When the call channel function is active the last major frequency digit will be replaced with a C. Press D or MR to exit calling channel operation.

[#] Priority Monitor

Press this key to activate the priority channel monitor function, in which the receiver samples the (last) selected memory channel for activity momentarily every so often while operating in the dial mode. The display will show a small P in the lower left corner, while the number of the channel being checked will blink below the operating frequency. If a signal appears on the priority check frequency that is strong enough to open the squelch, the checking function will be cancelled and operation will automatically shift to the priority frequency. Otherwise, press the D or MR key to cancel priority monitoring and stay on the present operating frequency.

[F] Alternate Key Functions

This yellow key changes the functions of all other keys on the keypad to the alternate functions indicated by the labelling on the front panel just above each key (except this one). A letter F will appear on the display to the left of the digits while the alternate key functions are active. If certain keys are pressed, or if no key is pressed within 3 seconds, the F will disappear and the keys will revert to their primary functions.

► KEY LOCK Slide Switch

Setting this switch to the right disables the keypad, preventing inadvertent input. When the keypad is so locked, an L is displayed to the left of the frequency. Slide this switch to the left to activate the keypad.

CLEAR ◀ ▶ BUSY Slide Switch

This 3-position slide switch selects the scan stop mode for the various types of scanning. The center MAN position allows manually stopping scanning by releasing the scanning key. The CLEAR position causes scanning to stop whenever a clear channel is reached (one which does not have any signal strong enough to open the squelch, as set by the SQL control). Conversely, the BUSY position causes the scanner to stop on the first channel which has a signal strong enough to open the squelch.

S/PO ◀ ▶ BC Slide Switch

This is the function selector for the front panel meter. When set to the S/PO position the meter indicates relative signal strength during receive and relative RF power output during transmit. When set to the BC position the meter indicates battery charge condition. The meter will indicate in the green zone during high power transmission if the battery pack has sufficient charge.

Meter

This multi-function meter indicates either relative incoming signal strength while receiving and relative RF power output while transmitting, or battery charge condition. The meter function is selected by the **S/PO ◀ ▶ BC** slide switch below the keypad. The numbers on the meter scale are for relative reference, while the colored zones are for battery condition indication, with the green zone indicating sufficient battery charge and the red zone indicating recharge or replacement of the battery is required.

BUSY and ON AIR Lamps

The green BUSY LED is lit whenever the squelch is open during reception. This is normally due to the presence of a signal on the channel, but can be caused by noise if the SQL control is set too far counterclockwise.

The red ON AIR LED is lit whenever the FT-709R is in the transmit mode. If it does not appear to light when the PTT button is pressed, battery condition should be checked.

MIC

Behind the small grill at this point is a 2-kilohm condenser microphone.

SIDE PANEL AND BOTTOM SWITCHES

PTT Bar Button

Press the PTT bar switch on the left side of the transceiver to transmit, and release it to receive. The red ON AIR lamp should be lit while this switch is depressed.

BURST Button (European versions only)

Press this button simultaneously with the PTT button to manually transmit a 1750 Hz burst tone to access repeaters that require it. The tone will be transmitted for as long as this button (and PTT) are held.

UNLOCK Slide Button

To remove the battery pack, hold this button upwards to release the safety catch and allow the battery to be slid (to the left) out of its mounting track.

LAMP Button

Press this button on the right side of the transceiver to turn on the lamp illuminating the meter and display, when ambient light is insufficient.

STEP X1/X2 Switch (in battery mounting track)

This recessed two-position push button switch is accessible with a pointed instrument through the square hole in the battery mounting track when the battery pack is removed from the transceiver, and allows selection of the size of the channel steps. The smallest steps are selected when the switch is in the depressed position, and the resulting (minimum) channel step size will be 25 kHz, with the alternate switch position providing steps twice that size.

STEP X1/X2
Switch

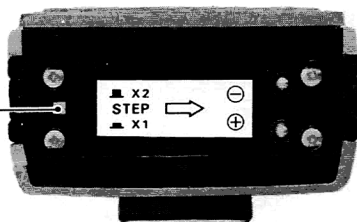

BATTERY PACK INFORMATION

The following battery packs are recommended for use with the FT-709R:

FNB-3 10.8V 425mAh Ni-Cd Battery Pack

FNB-4 12V 500mAh Ni-Cd Battery Pack

Also available is the **FBA-5** Battery Case for 6 AA-size dry cells (non-rechargeable, batteries optional).

In some countries, one or more of the above may be supplied with the transceiver. If not, contact the nearest Yaesu dealer. We do not recommend the use of any other type of battery with the FT-709R, and using another type may affect your warranty.

The FNB-3 and FNB-4 are both rechargeable, either while attached to the transceiver or separately, using the battery chargers described on the following pages. Each Ni-Cd pack should be fully charged before it is used with the transceiver for the first time. Note that the chargers required for the FNB-3 (except for the NC-15) are different than those for the FNB-4, because of the difference in battery voltage.

RF power output from the transmitter will differ according to which type of battery is used, with the FNB-4 providing the highest output and the FBA-5 with fresh dry cells providing about 60% less output. See page 19 for further details.

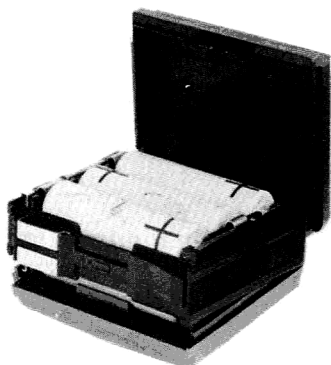

FBA-5

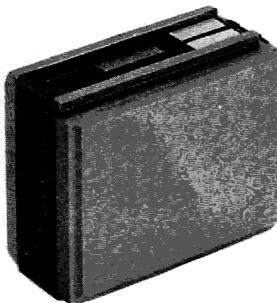

FNB-3

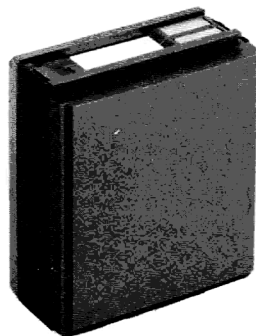

FNB-4

BATTERY REMOVAL AND REPLACEMENT

1. Make sure that the **VOL** control is set into the **Off** click-stop, and remove the protective soft or hard case, if used.
2. Grasp the upper portion of the transceiver with your left hand, so that your palm is over the speaker and your left thumb is on the **◀ UNLOCK** button.
3. Move the **◀ UNLOCK** button in the direction indicated by the small arrowhead, while using your right hand to slide the battery case toward the side with the **◀ UNLOCK** button. The battery case should slide smoothly out of its track.
4. If using the FBA-5 battery case and dry cells, they can be removed from the case by placing both of your thumbs on the mounting tracks on top of the case and gently prying the tracks apart. Although both sides must be opened to change the cells, only one side must be opened at a time, to avoid damage to the hinges. First install or replace the three cells in one side, and then close that side, open the other side, and install or replace the other three cells. Always replace all six cells.
5. To replace the battery case or Ni-Cd pack, repeat steps 2 and 3 above, simply sliding the battery case in the other direction after aligning the shorter side of the battery case with the track below the **◀ UNLOCK** button.

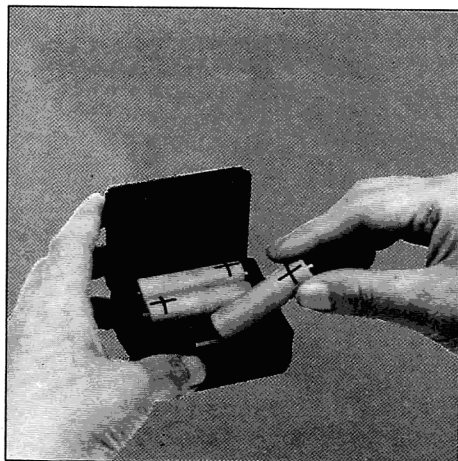
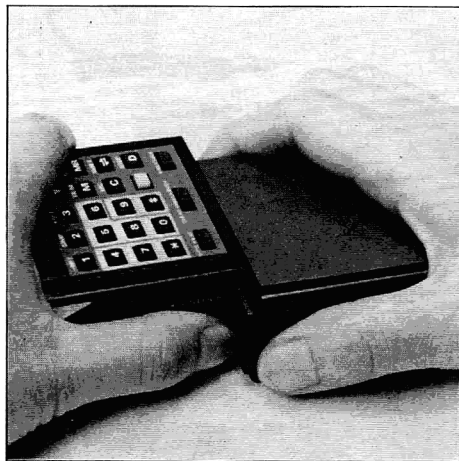

BATTERY CHARGER INFORMATION

NC-9B/C

The NC-9B (117VAC) and NC-9C (220-234VAC) are compact chargers for recharging the FNB-3 Ni-Cd battery pack from the AC line. A completely discharged pack requires approximately 15 hours to recharge with the NC-9B/C. Do not attempt to charge the FNB-4 with the NC-9B/C.

NC-18B/C

The NC-18B (117VAC) and NC-18C (220-234VAC) are compact chargers for recharging the FNB-4 Ni-Cd battery pack from the AC line. A completely discharged pack requires approximately 15 hours to recharge with the NC-18B/C. Do not attempt to charge the FNB-3 with the NC-18B/C.

It is not necessary to remove the battery pack from the transceiver when charging, but the transceiver can not be operated while the NC-9B/C or NC-18B/C is connected. Therefore it is advisable to have an extra battery pack on hand so that the transceiver can be used while the spare pack is being charged.

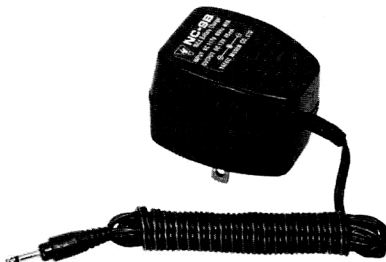

NC-9B

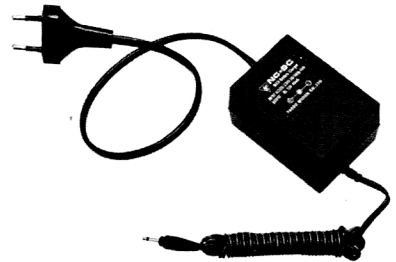

NC-9C



NC-18B

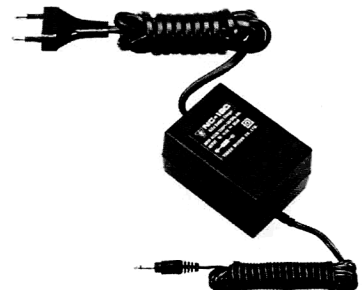

NC-18C

NC-15

The NC-15 is a battery charger/DC supply with quick and trickle charging modes. The quick mode is automatically selected initially, to bring the battery pack up to full charge as fast as is safely possible. The charger then automatically reverts to the trickle charge mode, to prevent self-discharge. The quick mode recharges a completely discharged FNB-3 in about 1 hour, or FNB-4 in about 1.5 hours.

The DC power supply function of the NC-15 allows the transceiver to be operated while also charging an attached battery pack.

PA-3

The PA-3 is a DC-DC adapter for use when operating the transceiver mobile. The PA-3 provides a regulated 10.8V DC to the transceiver and battery through terminals on the bottom of the FNB-3 or FNB-4. Battery charge is thus preserved during mobile operation. The PA-3 may be used only with 12-volt negative ground electrical systems.



FT-709R/NC-15

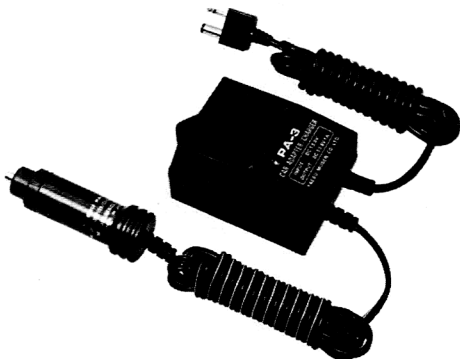

PA-3

YH-2 HEADSET and MH-12_{A2B} SPEAKER/MICROPHONE

Either of these optional accessories can be used to increase operating convenience and extend communications range and signal strength. Each is equipped with a dual plug connector which mates with the EAR and MIC jacks on the top panel of the transceiver, disabling the internal speaker and microphone. The connecting cable then allows the transceiver to be left clipped to the operator's belt, or to be held overhead above obstructions for improved performance, if necessary. For mobile operation with the **MMB-21** Mobile Hanger, the transceiver can be left in the Hanger during transmission.

The **MH-12_{A2B}** Speaker/Microphone can be held close to the ear during reception; or if preferred, an external earphone can be connected to the transceiver via the speaker/mic plug, thereby attenuating the audio from the speaker in the **MH-12_{A2B}** speaker. To transmit, just hold the speaker/mic close to your mouth and close the PTT switch on the microphone.

The **YH-2** Headset includes both a lightweight earphone and miniature boom microphone with a single headband, permitting totally hands-free operation of the transceiver when the VOX (voice-actuated transmit/receive switching) system in the transceiver is activated by pressing the VOX ON switch on the top panel. When in a normal, quiet environment, set the VOX LOW switch to the undepressed (high) position, for maximum sensitivity of the VOX circuit. If in a noisy environment where extraneous sounds might trigger the VOX inadvertently, press the VOX LOW switch.

To transmit when using the **YH-2** it is only necessary to speak. The boom microphone will pick up your voice, which will automatically activate the transmitter and be sent out over the air (watch what you say). To return to receive, just stop talking.



MMB-21

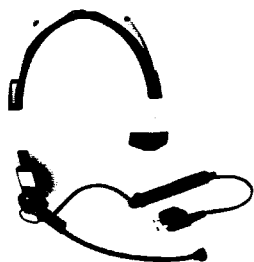

YH-2



MH-12_{A2B}

ANTENNA CONSIDERATIONS

While the supplied YHA-44A rubber flex antenna provides great convenience for short-range portable operation, the standard BNC-type antenna connector on the transceiver allows for the use of higher gain antennas for extended range in base or mobile operation. However, any antenna connected to the transceiver must have an impedance close to 50 ohms throughout the operating frequency band. Also, if the antenna is to be connected with a feedline to the transceiver, high quality 50-ohm coaxial cable should be used.

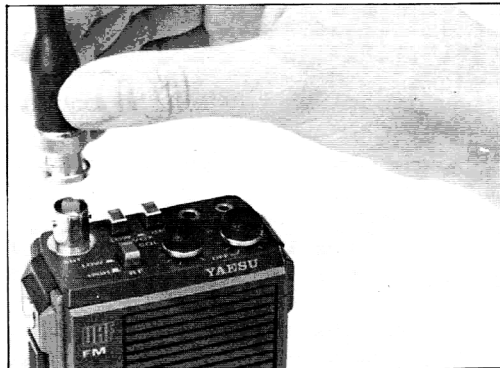

MEMORY BACKUP INFORMATION

Most of the operating data programmed in the FT-709R is retained in memory by an internal lithium cell even when the power is off and the battery removed. This backup cell has an estimated lifetime of five years, after which time data may be lost when power is switched off. When that occurs, see your Yaesu dealer for installation of a replacement backup cell.

FTS-6 TONE SQUELCH UNIT INSTALLATION

The FTS-6 can be installed in the A & X versions of the FT-709R, and is available from Yaesu dealers in those countries where Models A & X versions are sold.

1. Make sure that the **VOL** control is set into the **OFF** position. Remove the hard or soft case, if used, from the transceiver, and remove the battery pack as described on page 13.
2. Remove the four screws affixing the battery mounting track on the bottom of the transceiver, and carefully remove the track.
3. Locate the 1/8-watt, 27-kilohm resistor that is inserted in one side of the (otherwise empty) socket on the bottom of the transceiver, and pull the resistor out of the socket. It is not needed when the FTS-6 is installed. If this resistor cannot be found, or if a circuit is already installed in the socket, the transceiver is probably not a Model A or X. In this case, contact your Yaesu dealer before proceeding.
4. Make sure that all of the pins on the FTS-6 are straight, and position the FTS-6 so that the 8-pin side is aligned with the 8-pin side of the socket (the other side of the FTS-6 and socket has 7 pins). Gently press the FTS-6 into the socket, rocking the board back-and-forth a little at a time until the top of the IC is flush with the surrounding black plastic inner cover. Do not use a sharp object to press on the board, as this may damage the circuitry.
5. Replace the battery mounting track and its 4 screws, followed by the battery pack, which should fit as smoothly as before if the FTS-6 was properly seated.

See page 35 for details of tone squelch operation.

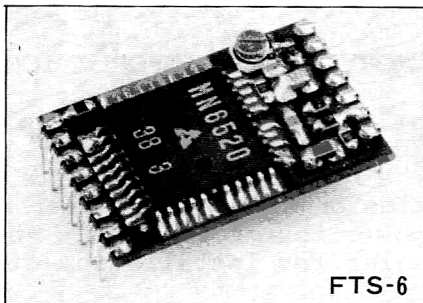

FTS-6

FTS-6 INSTALLATION

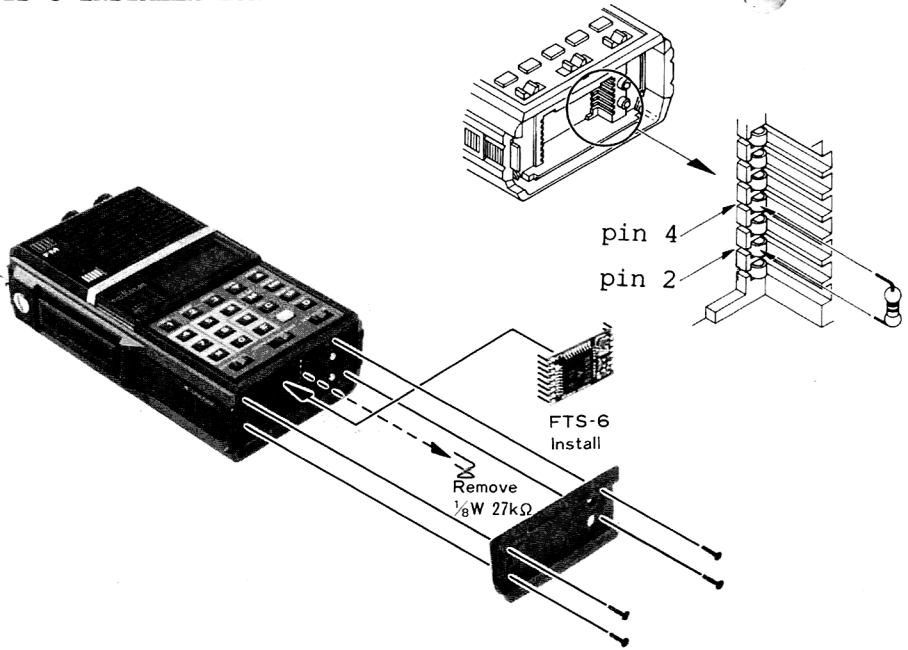

BATTERY DISCHARGE & POWER OUTPUT

TX/RX RATIO = 1:3

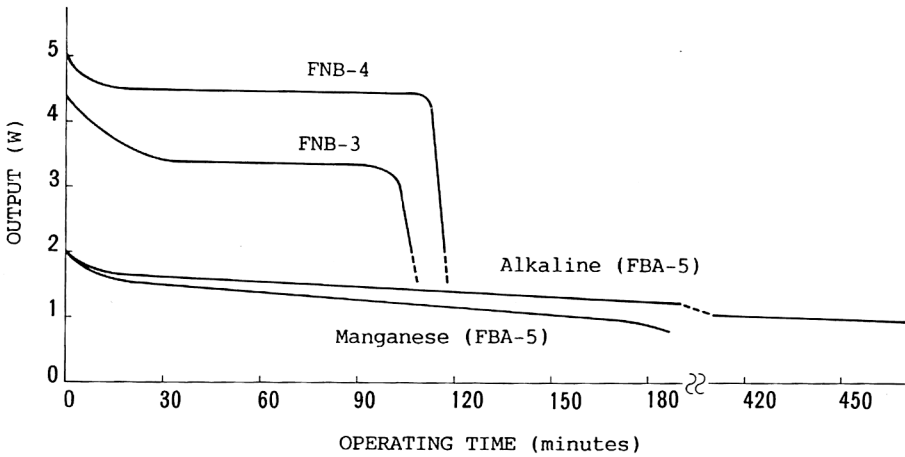

Preliminary Operating Information

Before operating the transceiver, make sure that the battery pack is fully charged if using the FNB-3 or FNB-4 (Ni-Cd battery packs that have just been received from the dealer require full recharging before beginning operation). Also, before installing the battery pack (remove it if it is already installed), set the STEP X1/X2 switch on the bottom of the transceiver to the desired position, according to whether or not the half-steps are used in your area. If you don't know, this can be set later. If using the FBA-5 battery case and AA-size batteries, install the batteries as described on page 13.

Connect the YHA-44A rubber flex antenna to the antenna jack on the top of the transceiver. Never operate the transceiver without an antenna connected.

VOX operation using the YH-2 Headset is described on page 16. For now, do not connect the YH-2 or the MH-12^{A2B} Speaker/Mic, and set both of the VOX buttons on the top panel to the undepressed position (until you are familiar with basic operation). Also on the top panel, press the RF button to select LOW power output.

On the front panel, beneath the keypad, set the lefthand (meter) slide switch to the S/PO position, the center (scan stop mode) slide switch to MAN, and the righthand KEYLOCK switch to the left (off).

With the VOL control set into the click-stop (OFF), set the SQL control fully counterclockwise. Now rotate the VOL control out of the click-stop and adjust for a comfortable volume on the noise or received signal. Unless the transceiver has been used since it left the factory, the display should show either **6.000** (Model A, indicating 446.000 MHz), **3.000** (Model X, indicating 433.000 MHz), or **3.400** (Models B & C, indicating 433.400 MHz). If a signal is present, press either the ▲ or ▼ key at the upper right of the keypad, until a frequency is found where only noise is heard.

Rotate the SQL control clockwise just to the point where the noise is silenced and the green BUSY LED is extinguished. If the SQL control is set further clockwise, sensitivity to weak signals will be reduced. Now, whenever a signal reaches the receiver that is strong enough to open the squelch, the BUSY LED will light.

After studying the information on the following pages, when

you wish to transmit, wait until the channel is clear (green BUSY LED off), and squeeze the PTT switch on the side of the transceiver while speaking into the microphone (MIC on the front panel, just above the meter). During transmission the red ON AIR LED will light. If it does not, or becomes dim after several hours of operation, the battery pack should be recharged or batteries replaced (in the FBA-5). If you are calling through a repeater that requires a burst tone (using transceiver model B or C), press the BURST button along with the PTT switch to send the 1750 Hz burst tone.

Release the PTT switch to receive. If more power is required, press the RF button on the top panel so that it returns to the undepressed position. However, whenever communication is possible with low power, this button should be depressed to conserve battery life and minimize possible interference to other stations.

In certain locations, when received signals or repeater access is weak or unstable, the signals may be improved by moving the transceiver around: in general, the higher the better. The signal strength function of the meter is especially useful for determining the optimum position of the transceiver while receiving, which position will also be the best for transmitting. Either the YH-2 Headset or MH-12_{A2B} Speaker Microphone allow the transceiver to be held high overhead during operation. These accessories are described on page 16.

When operating in a dark environment, the LAMP button can be pressed to illuminate the display and meter.

Frequency Programming and Special Functions

While the variety of keypad-programmable functions in the FT-709R can seem formidable at first glance, basic operation is not complicated and requires only a few moments with the transceiver in hand. Once this has been learned you can select those particular functions that you wish to use right away, skipping over the functions that may be less useful in your particular case until last. The following material presents the keypad programming functions in two different ways: firstly in narrative step-by-step procedures, and secondly in the form of several charts. Once the step-by-step procedures have been tried the charts may be used to refresh your memory, if necessary, from time to time. If the information in the charts becomes confusing, however, it may prove helpful to return to the step-by-step description of the particular functions. In all cases, we recommend that you have the operating transceiver in hand to actually key in the procedures when studying the functions.

Before proceeding, you may wish to review the descriptions of the basic key functions and carefully look over the LCD segment diagram in the first part of this manual. The following procedures assume that you have become familiar with the key and LCD segment locations, and that you are acquainted with the following terms:

Calling Channel - a frequency usually set aside by fraternal agreement to be used only for establishing initial contact (after which stations QSY to another frequency). This assures operators of a frequency on which someone is (hopefully) always monitoring, yet which is never occupied for more than a few seconds. Memory channel 0 in the FT-709R is intended for calling channel use.

DIAL - the primary operating mode of the transceiver, when not operating on a "memory" channel. Actually, the DIAL mode has its own register in the CPU, and is backed up when power is off. The D key is used to activate (or access) this mode.

DTMF (Dual Tone Multi Frequency) - a push button audible tone signalling system often used for telephone dialling, in which each of the keys 0-9, *, #, ▼, M, C and F produce two simultaneous audible tones which are transmitted when the PTT switch is pressed along with the key. A DTMF encoder is included in Models A & X, for accessing the telephone system through repeaters so equipped.

Priority Channel Operation - a method of operation whereby the transceiver periodically checks a preselected frequency (the "priority" channel) momentarily for the presence of a signal while operation is conducted on another channel. The priority channel is checked only during reception, and operation automatically shifts to the priority channel if it becomes active.

Repeater Shift - the difference between the output (transmitting) and input (receiving) frequencies of a repeater. "+" shift signifies that the receiving frequency of the repeater is above its transmitting frequency, and "-" shift is vice-versa. Remember that you must transmit on the input and receive on the output frequency, though the FT-709R allows reversing these, when required.

Tone Squelch - a subaudible tone system in which the transmitted voice signal has a subaudible (very low audio frequency) tone superimposed, and the receiver has a very

sharp filter (tuned to the same subaudible frequency) in its squelch circuit. The receiver squelch will open only when it receives a signal with the matching subaudible tone, regardless of other signals on the frequency. The FTS-6 Tone Squelch Unit is available as an option for the FT-709R (Models A & X only).

NOTICE: MEMORY RESET

The following procedures assume that no data has previously been entered into the FT-709R, and thus all functions and memories are at their default values. To ensure that this is so, locate the small hole in the lower rear cover beside the belt clip, and gently press the point of a small sharp instrument into this hole when the power is switched on, to reset the memory of the CPUs. This can be done at any time to erase all data and return to the default settings, which are as follows:

	<u>Preset frequency</u>	<u>Repeater shift</u>
Model A	446.000 MHz	5 MHz
Model X	433.000 MHz	5 MHz
Model B	433.400 MHz	1.6 MHz
Model C	433.400 MHz	7.6 MHz

Tone Squelch - Models A & X w/FTS-6 option only, Code No,5
(88.5 Hz)

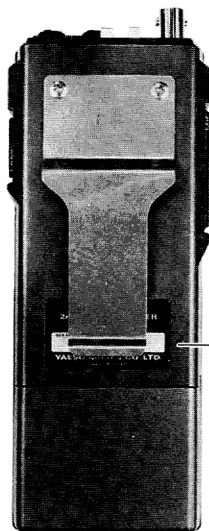

ALL RESET SWITCH
Access Hole

A. Frequency Entry

1. To key in the digits of any frequency within the range of the FT-709R, begin by pressing the MHz digit of the desired frequency (even if this is already shown on the display). This informs the CPU that you want to enter new data, and it will respond by replacing the previous display data with the digit you pressed followed by three 0's, the first of which will be blinking.

Note that it is not necessary to enter the hundred and ten MHz digits, since the FT-709R expects these to always be 4 and 3 (or 4); only the one MHz digit should be entered.

2. Next press the hundred kHz digit of the frequency you desire, and the next digit on the display will blink. Then press either 0, 2, 5 or 7, for 00, 25, 50 or 75 kHz, which will automatically appear as the last two digits.
3. The display should now show the frequency that you wish to enter, in which case you can now press D (DIAL) to enter the new frequency in the Dial mode. If the display does not show the frequency you want, press C to cancel the last keystroke, and re-enter the desired digit. Pressing C more than once will cancel previous keystrokes in the reverse order that they were made, all the way back to the initial state of the transceiver. However, once the D key has been pressed the keyed in data becomes the operating frequency in the Dial mode, where the C key is deactivated.

EXAMPLE: to enter 445.550 MHz (Model A), or 435.550 MHz

Press 5 (the display will show 5000), and 5 again two more times. The display will then show 5550. Press D and the decimal will appear after the leftmost digit.

B. Storage & Recall of Frequencies in Memory

1. To store a frequency in memory, first enter the desired frequency in the Dial mode as described above. Then press the desired memory channel number, from 0-9, followed by the M key. The channel number will appear briefly at the bottom of the display, confirming the action, but the transceiver will remain in the Dial mode. Go ahead, store a few frequencies. If you want

to store repeater frequencies, enter output frequency (the frequency you want to receive on) for now. Remember that when you store data in memory, the data previously stored in that channel (if any) will be erased.

EXAMPLE

To store the previously entered frequency (445.550 or 435.550 MHz) in the CALL channel (0), just press 0 and then M. Use the same procedure after keying in other commonly used frequencies in the DIAL mode to store them in channels 1 to 9.

2. To recall any memory press the channel number followed by MR. The recalled channel number will appear at the bottom of the display, indicating that the transceiver is no longer in the Dial mode, but in the Memory mode. However, if you try to recall a memory that has nothing stored in it you will get an error indication. Calling channel 0 is a special case in that you need press only one key (*), to recall it (in this case, the last frequency digit will be replaced with a C, for the Calling Channel mode). Channel 0 has some other special features, described later.
3. If you wish to check which memory channels are in use before storing new data, press the M key while in the Dial mode. The numbers of the channels which are occupied will appear for a second at the bottom of the display.

C. Repeater Operation (standard shift)

1. All models have a default repeater shift, which may be easily changed from the keypad, as described later. For now, just check the standard shift by pressing F and then SHIFT. The display will show either 5.000 (Models A & X), 1.600 (Model B) or 7.600 (Model C) for a second.

Note: Whenever the yellow F key is pressed the display will show an F for about a second, during which the key functions will be "shifted" to their alternate functions, labelled above each key. If another key is not pressed within that time the key functions will return to those indicated on the key faces, and it will be necessary to press F again for the alternate functions. In these instructions each key will be referred to by the function

that it should have when pressed, so that when a key is to be pressed immediately after the **F** key, it will be referred to by its alternate function name, above the key itself.

2. To enter the standard repeater shift checked in paragraph 1, press **F** and then either **+RPT** or **-RPT**, depending on which direction the transmit frequency is to be offset to the repeater input. **+** or **-** and **RPT** will appear on the display. If the transceiver is in the Dial mode, this shift will be applied to any new frequency that you may enter in this mode, and to any memory channels that you may store. However, if you are in the Memory or Call modes, the repeater shift will only apply to that channel frequency, and will be cancelled once you change modes or channels. To store the repeater shift in the memory channel, after recalling the channel and selecting the shift, just press **M** (the **+** or **-** sign on the display will disappear).

EXAMPLE: To program 449.85/444.85 into Channel 1

This can only be done in Model A, but the procedure is identical in the other models, for appropriate frequencies. First, press **4, 8, 5** and **D** to enter the repeater output frequency (your receiving frequency) in the Dial mode. Then press **F** and **-RPT** to select the shift. Finally, press **1** and **M** to store the works in channel 1. Again, the transceiver will remain in the Dial mode, but you can press **1** and **MR** to check the memory. Note that the **+** or **-** sign is not displayed when repeater shift is stored in memory.

3. To cancel or change the direction of the repeater shift in the Dial mode, just press **F** and the **SIMP** key (to cancel shift), or the **-RPT** or **+RPT** key. Similarly, to cancel the shift in the Memory mode, press **F** and **SIMP**. This will be temporary (not actually stored in the channel) unless you press **M**. Changing the direction of shift once it is stored in a memory is not so easy: you need to first press **F, SIMP** and **M** before pressing **F** again and the other shift direction. Again, press **M** if you want the change memorized.
4. One more repeater function that should be mentioned at this point is the reverse function, which exchanges the transmit and receive frequencies of the transceiver during repeater shift operation. To do this, press the \Rightarrow key. **REV** will appear on the display, and the transmit and receive frequencies will be reversed. This key is especially handy for checking the direction of shift of a memory without the need to transmit. Just press the \Rightarrow key twice.

D. Frequency/Channel Stepping and Basic Scanning

1. All scanning can be manually activated and deactivated by the ▲ and ▼ keys. If the transceiver is in the Dial mode then at the first press of these keys the frequency will step up or down from the initial frequency by the size of the scanning steps. The steps are either 25 or 50 kHz, determined by the position of the STEP switch on the bottom of the transceiver (see page 11).

If the transceiver is set to the Memory mode (a channel number is displayed below the frequency), pressing the ▲ or ▼ key will cause the frequency to move to the next higher or lower (occupied) memory channel. In this context, "higher" and "lower" refer to the number of the channel itself - not the frequency that is stored there. Also, note that only those channels which actually have frequencies memorized will (or can) be checked. To determine which frequencies are occupied or empty, just press **M** when in the Dial mode. The numbers of those channels which are currently holding data will appear for a few seconds below the Dial frequency.

2. Holding the ▲ or ▼ key for more than a second will cause scanning to start. The condition under which scanning will stop is determined by the CLEAR ◀ MAN ▶ BUSY slide switch and the setting of the SQL control (unless the switch is set to MAN). If set to MAN, scanning stops whenever the ▲ or ▼ key is released. If the slide switch is set to CLEAR, the beeper will sound and scanning will stop (for about 3 seconds) whenever a frequency is reached where the squelch does not open, and then resume automatically. Conversely, if the slide switch is set to BUSY, scanning will stop briefly on frequencies where the squelch does open. While automatic scanning in either mode is pausing, the decimal of the displayed frequency will blink.

Notice that the setting of the SQL control determines the strength of received signals that will affect automatic scan stop functions, and thus it should be set carefully for the desired threshold before starting scanner operation. Also, while it is normally convenient to have the beeper activated, to signal when a key is pressed or when automatic scanning stops, this can be a nuisance when the automatic scanning stops often. To deactivate the beeper just press **F** and **B OFF**, and **F** and **BEEP** to turn it back on.

Either automatic scanning mode may be interrupted at any time, by pressing either ▲ or ▼ again, or by pressing D (if in the Dial mode) or MR (if in the Memory mode), or the PTT switch. If the PTT switch is used for this, the transmitter will not be activated unless the PTT switch is released first, and then pressed again.

E. Basic Priority Channel Operation

1. To check for activity on a memory frequency while receiving in the Dial mode, first preset the SQL control for the desired threshold level. If the frequency to be checked is already stored in a memory channel, just press MR to recall it. Otherwise, go ahead and store it in a memory as described in Part B on page 24, and then press MR to recall it.
2. Once the frequency to be checked has been recalled, press D to change to the Dial mode, and enter the frequency you wish to operate on while the memory frequency is being checked. Of course you can also use repeater shift. Now press # to activate priority channel checking: a small P will appear at the lower left corner of the display, and the channel number of the priority channel will blink. About every 3 seconds the displayed frequency will briefly change from the Dial frequency (on which you are operating) to the priority channel frequency, and then back.
3. You can go ahead and operate in the Dial mode as you normally would (transmit, change frequency, scan, etc.), until a signal above the squelch threshold (that you set before beginning) appears on the priority channel while you are receiving, at which time the operating frequency will automatically shift to the priority channel. If you were in the middle of a QSO in the Dial mode, you may need to press D to go back to that frequency and inform the other station that you received a call (in which case just press MR to return to the priority channel).
4. Priority operation can be terminated manually at any time by pressing D, MR or ✕, depending on which mode is desired for consequent operation. Note that if the Power Save function (described in the next section) is activated at the same time as priority operation, the periods between channel checking will be longer.

This concludes the description of the basic functions of the FT-709R. The next section describes specialized functions which are more or less useful to particular types of UHF FM operation and local requirements. Before proceeding, please

take time to become thoroughly familiar with the above functions, which must be clearly understood in order to make full use of the specialized functions on the following pages.

NOTE

When the transceiver is switched off while the scanner is active and/or the transmit and receive frequencies are REVERSED, these functions will be cancelled.

ADVANCED OPERATION AND SPECIAL FUNCTIONS

Once the basic functions described on the previous pages are clearly understood, the operator may select from the following those functions that he may require for his particular operating requirements. The first few procedures (Power Saving, Calling Channel and Special Scanning functions) will be found useful by most active UHF operators. However, some of the other special functions can not be implemented on all models of the FT-709R, and will be so noted.

A. Power Saving

This function allows the FT-709R to monitor a frequency for activity while drawing less current than is required for normal squelched reception. This is done by removing power from all circuits (except a timer and the display) for programmable intervals, during which **SAVE** will be displayed along with the frequency data. Between "save" intervals, the receiver will be enabled for about 300ms to check the preselected frequency for activity. When a signal appears the receiver will function normally. However, if the carrier drops for more than five seconds, power saving will resume automatically. If the PTT switch is closed at any time during power saver operation, the transmitter will activate as usual. If no station responds to the transmission within five seconds after releasing the PTT switch, power saving will resume.

1. Before activating the power saver, set the transceiver to receive on the desired frequency to be monitored, which may be in any of the Dial, Memory or Call modes. Make sure that the **SQL** control is set to the desired threshold (the **BUSY LED** must be off), and then press **F** and the **SAVE** key. Note that the power saver is one of the only features that is not deactivated by switching the transceiver power off. To deactivate it, press **F** and the **S OFF** key (or reset the CPUs).

2. In its default state the power saver provides a 1:2 duty cycle ratio (300ms receive, 600ms save). This ratio can be reprogrammed by the user for 1:1 to 1:10 by selecting multiples of 300ms, from one to ten, for the "save" time. Press the numbered key corresponding to the desired multiple (0 for x 10, or 3 seconds save), and then **F** and **SAV T**. This can be done regardless of whether the save function is on or off. The chart below shows the various selectable save intervals.

Example: To program 300ms receive, 1.5seconds save Press 5 and then **F** and **SAV T** (300ms x 5 = 1500ms, or 1.5 sec). Then set the **SQL** control to the point where the **BUSY** lamp just turns off, and press **F** and **SAVE** to activate the power saver, if not already on (**SAVE** shown on display).

Notice that the keypad has priority over the power save function; whenever a key is pressed the save cycle will be interrupted, and will not resume until five seconds after all entries are finished. However, if the power saver is active when the power is switched off, **SAVE** will be displayed for three seconds whenever power is switched back on, to let you know it is activated.

POWER SAVER INTERVALS

Key Code	Save Time (T_1)	Save/Receive Ratio (T_1/T_2)
[1]	300 ms	1:1
[2]	600 ms (default)	2:1
[3]	900 ms	3:1
[4]	1200 ms	4:1
[5]	1500 ms	5:1
[6]	1800 ms	6:1
[7]	2100 ms	7:1
[8]	2400 ms	8:1
[9]	2700 ms	9:1
[0]	3000 ms (3 sec)	10:1

Note: Receive Sampling time T_2 is always 300 ms

B. Calling Channel Mode

While this function was introduced previously on page 25, it was described only as a memory channel (0) with a special single-key (*) recall capability. Actually, the * key activation of the Calling Channel makes this a mode of its own, in the sense that it is not a function of either the Dial or Memory modes. Therefore, even though the default frequency (see page 23) is present in the Calling Channel when the

CPUs are reset, it cannot be recalled as memory channel 0 by pressing **0** and **MR** until this (or another frequency) has been memorized in the usual manner.

In fact, while the frequency stored in memory channel 0, if any, will always be the same as that of the calling channel, the way in which that frequency is recalled (with ***** or with **0, MR**) will determine how the frequency is displayed (with or without a **C**) and how it can be used.

If the calling channel is to be used for priority channel checking, it must be manually stored in channel 0 as would any other memory frequency, and then recalled before activating priority operation. In this case, do not use the ***** key to recall it: treat it like any other memory. Pressing the ***** key during priority channel checking will cancel that function and operation will shift to the calling channel.

Some of the following special memory functions do not include channel 0, so as to protect the programmed calling channel frequency from accidental erasure.

C. Selected Memory Scanning, Masking and Deleting

In addition to the memory scanning function described on page 27, it is possible to select only certain channels for memory scanning without having to erase those that you do not wish to scan.

1. To mask a channel, press the channel number followed by **F** and **MSS** (memory scan skip). The beeper will sound three times, and the display will show (for a few seconds) all of the channel numbers that are currently included among the channels to be scanned, plus the channel that has just been masked, the number of which will blink. Although the masked channel will no longer be included in memory scanning, it can still be recalled manually by pressing the channel number and **MR**.
2. The channels included in the selected memory scan can be checked at any time by pressing **M** twice while in the Dial mode (the first press causes the display to show the numbers of the channels presently storing data, and the second press will show only those included in the selected scan). Scanning of the selected channels is activated and deactivated from the Memory mode with the **▲** and **▼** keys as described previously.
3. To reinstate a channel that has been masked from memory scanning, stop the scanner (if active), and then press the number of the channel followed by **MR** and **M**.

4. If you wish to completely delete a memory without entering a new frequency, just press the channel number and **MR** to recall it, then press the channel number again, followed by **F**, **MC**, and **D**. This is useful if more than just the frequency is being stored.

D. Limited Band/Programmable Step Scanning

It is possible to scan the frequencies between any two adjacent memory channels, using the PMS (Programmable Memory Scan) function. The steps of the scanner can also be programmed in this mode, in multiples of the basic step up to $\times 10$.

1. To scan upwards or downwards from a particular channel, just press the number of that channel followed by **F** and either **PMS ▲** or **PMS ▼**, according to the desired scanning direction. The number of the channel keyed in and also that of the next higher or lower channel will be displayed (data must have been stored previously in both channels). Hold the last key down for a second to activate scanning, which will continue in the selected direction (if uninterrupted) until it reaches the frequency of the programmed limit, and then jump back to the starting channel frequency. As usual, scanning can be interrupted automatically by Busy or Clear, or manually with **D**, ***** or the PTT switch.

Note that channel 0 may be included in the above scanning functions, in which case its relative position is above channel 9 and below channel 1. Also note that while it is necessary that both channels used in this scanning mode have data previously memorized (or an **Err** will result), it is possible to use channels that have been programmed for omission from standard memory channel scanning: their status for that purpose will be unchanged.

2. The steps of the scanner during PMS operation can be programmed from the Dial, Memory or Call mode, by pressing the numbered key corresponding to the multiple of basic channel step that will provide the desired scanning step ("**0**" = $\times 10$). The basic scanning step for this purpose is 25 kHz.

Example: 100 kHz scanning steps

Press **4**, **F** and **STEP** (the **D** key). Press **F** and **STEP** to confirm the new steps.

The PMS steps are retained permanently in memory during other modes of operation (though they are not applicable to other scanning modes), and while power is off.

3. One additional function that comes in handy especially when making use of the PMS system is memory channel swapping, whereby any two channel numbers (excluding channel 0) can be exchanged quickly without affecting the data stored in either memory. To do this, just press the number of one channel followed by **MR**, the other channel number, and **M**.

It is possible to utilize PMS scanning and priority channel checking at the same time. To do this, first recall the priority channel and set the squelch as required. Then press **#** to activate priority operation (the display will show the Dial frequency, which may be ignored), and then press the PMS channel number, **F**, and the desired PMS key.

E. Odd Repeater Shifts and Split-Frequency Memories

Non-standard repeater shifts and other split frequency requirements can be handled via the Dial mode, utilizing the frequency shift register, for occasional or one-time needs; or via the Memory mode for more permanent requirements.

1. To operate with a non-standard shift in the Dial mode, first key in your receive frequency and press **D**, followed by the desired **offset** (not the actual transmit frequency), **F** and **SHIFT**. Then press **F** and **+RPT** or **-RPT**, as required. **+RPT** or **-RPT** will be displayed along with the operating frequency, which will be offset by the same amount regardless of what frequency is later set while in the Dial mode.

Simplex operation can be recalled in two ways: by pressing **F** and **SIMP**, in which case the offset will remain in the frequency shift register but **+ or -RPT** will vanish from the display; or by pressing **0**, **F** and **SHIFT**, which will zero the offset but retain split operation (with zero shift).

2. To store an odd split in a memory channel, begin by storing the receive frequency (key in the digits, press **D**, the channel number and then **M**). Then key in the desired amount of offset, press **F**, **SHIFT**, **F** and **+ or -RPT**, followed by the same channel number just entered, and **M** again. At this point, the transceiver is still in the Dial mode, so you can go ahead and operate. When the memory channel is recalled, it will have the data just programmed, but the **+ or -** indicating the offset direction will not be displayed.

The above two requirements both cause the shift to be changed, so that it must be reprogrammed to return to standard shift (by keying in **5** (or **1,6** or **7,6**), **F** and **SHIFT**). This is not very convenient if only one repeater has that particular odd split, and so a third method is available which does not use the frequency shift register, but rather programs completely independent receive and transmit frequencies each into the same memory channel.

3. First key in the receive frequency, and press **D**, the desired channel number and **M** to store it in the memory. Then key in the actual transmit frequency (not offset), and press **D**, the same channel number, **F**, and **TXM**. Note that the transceiver is now in the Dial mode on the transmit frequency. Simply recall the memory by pressing the channel number and **MR** to operate.

Recall that the \rightleftharpoons key is available for reversing the transmit and receive frequencies at any time. This can be used with any of the above methods, and **REV** will be shown on the display when operation is the reverse of that programmed.

F. Multi-channel Priority Scanning

The Priority Channel Checking function described earlier in this manual may also be implemented so as to check a number of frequencies for activity sequentially.

1. The selective memory scanning system described in Part C above can be used for priority checking of selected memory channels while operating in the Dial mode. First, enter your desired receive frequency and press **D**.

Now check the selected memory channel by pressing **M**, and enter or unmask the channels that you wish to have priority-checked. Then recall the channel you wish to start with, by pressing the channel number and **MR**, and activate select channel scanning with **▲** or **▼**. Set the **SQL** control for the desired threshold, and press the **#** key to activate priority checking. Notice that the transceiver is now operating in the Dial mode, but each time the priority system checks a channel, it will be higher or lower than that checked previously.

Of course, while operating in the Dial mode and priority checking memories, it is also possible to scan the Dial frequency, just by pressing either of the scan keys again. However, while the Dial is used for scanning, the SAVE function is inoperative, so priority checking will occur more frequently, and power consumption will be higher.

G. Tone Squelch Programming (Models A & X only, w/ FTS-6)

When the optional FTS-6 CTCSS Tone Squelch Unit is installed in Model A or X transceivers, the tone frequency and decoder selectivity (Q) may be selected from the transceiver keypad, along with encode-only (transmit) or encode/decode operation. The standard CTCSS tone frequencies are assigned specific code numbers for programming purposes, as shown in the chart below.

FTS-6 CTCSS Tone Code Chart

Code No.	Freq (Hz)	Code No.	Freq	Code No.	Freq
1	XZ 67.0*	15	SB 131.8	30	225.7
2	XA 71.9*	16	4Z 136.5	31	233.6
3	XB 77.0*	17	4A 141.3	32	241.8
4	YZ 82.5*	18	4B 146.2	33	250.3
5	YB 88.5*	19	5Z 151.4	34	XZ 67.0
6	2A 94.8	20	5A 156.7	35	XA 71.9
7	1Z 100.0	21	5B 162.2	36	WA 74.4
8	1A 103.5	22	6Z 167.9	37	XB 77.0
9	1B 107.2	23	6A 173.8	38	SP 79.7
10	2Z 110.9	24	6B 179.9	39	YZ 82.5
11	2A 114.8	25	7Z 186.2	40	YA 85.4
12	2B 118.8	26	7A 192.8	41	YB 88.5
13	3Z 123.0	27	m1 203.5	42	ZZ 91.5
14	3A 127.3	28	210.7	63	1000**
		29	218.1		

* Decoder Q = 40, other codes have decoder Q = 80

** Audible test tone

- 
1. Select the tone code from the chart that corresponds with the desired tone frequency. Note that codes 1-5 have the same frequencies as codes 34, 35, 37, 39 and 41, but with only half the selectivity. These low-Q codes are for use when the adjacent tone frequencies are not used in the local area, and provide faster response than the more selective codes.

Key in the (one or two) digits of the tone code, and press **F** and **T SET**. The code number will now appear briefly to the right of the frequency on the display.

2. To activate the tone squelch system (encoder on transmit and decoder on receive), press **F** and **T SQ**. **TONE** is now shown on the display. Set the **SQL** control so that the **BUSY LED** just turns off (or automatic scanning will not function properly). If you wish to activate the encoder only (for transmission), press **F** and **ENC** instead, in which case **TONE** will only appear on the display during transmission.

If the tone code is not entered as in step 1, the default 88.5 Hz (Code 5) will be selected automatically whenever the **T SQ** or **ENC** functions are activated. If operating in a memory channel, be sure to press **M** to store the tone code before changing to another memory or mode. Each memory channel can store a different tone along with frequency and split, when required.

3. To deactivate the tone squelch or encoder without erasing the selected code, press **F** and **T OFF**. Remember, if you wish to preserve a newly set status in a memory channel, you must press **M** to restore the channel data (if already in the Memory mode, or a channel number and then **M** if in the Dial mode).

Final Comment on Operation

While the operating instructions included in this manual are intended to cover the vast majority of needs for the active UHF operator, the FT-709R itself is no doubt capable of more combinations of functions and shortcuts than can be described herein. Once the procedures in this manual have been learned, we encourage the adventurous operator to experiment with alternate programming techniques, and to pass on their discoveries to others. The incredible operating potential afforded by the two CPUs in the FT-709R leaves plenty of room for creativity by those who enjoy experimentation in the state of the art.



E3960185(8411-P)

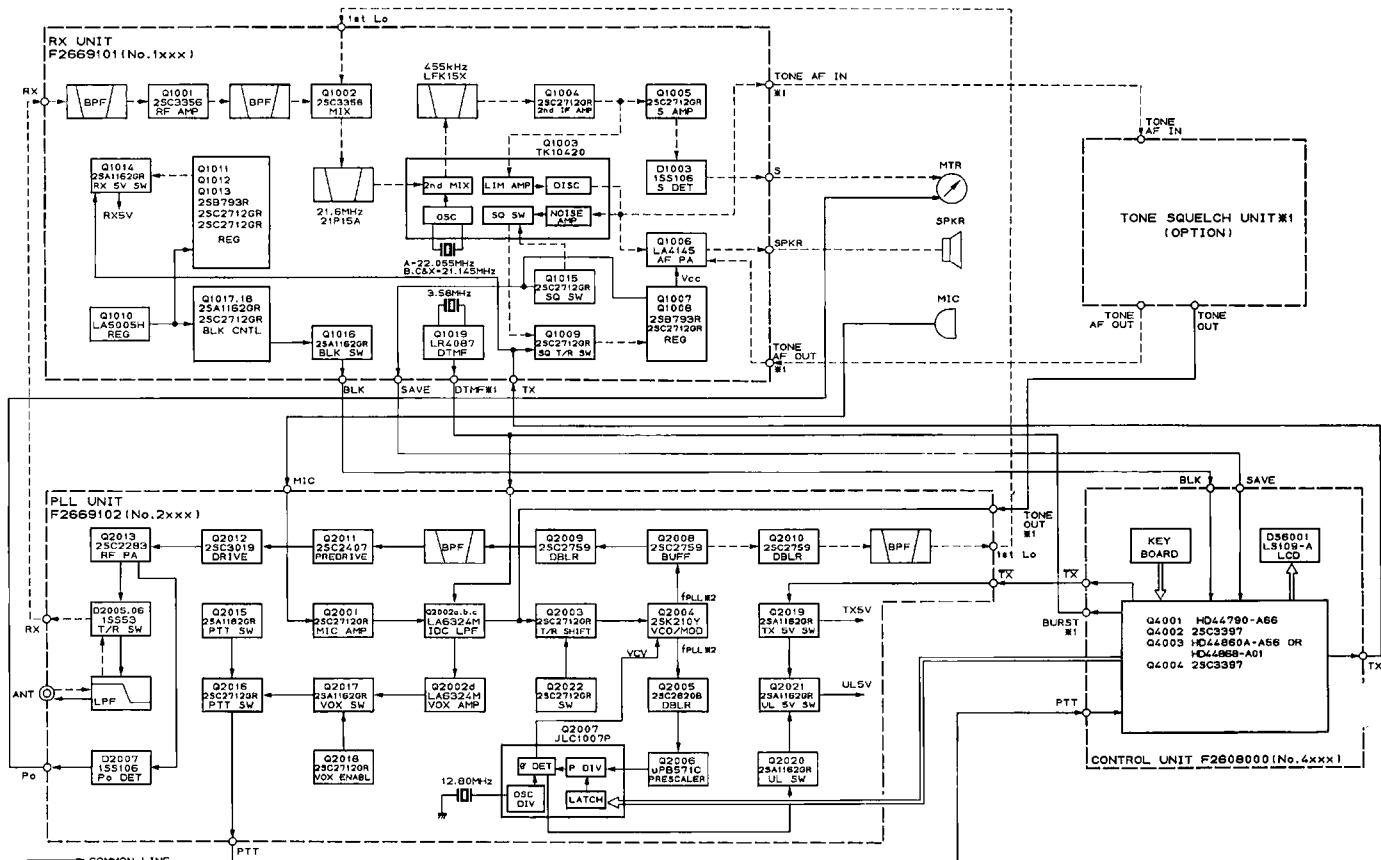

#1 RX PLL AND CONTROL COMPONENT VARIATIONS

	DTMF	BURST	TOUR SQ
A	○	○	OPTION
B	○	○	○
C	○	○	○
X	○	○	OPTION

#2

	TX (MHz)	RX (MHz)
A	230.200-	208.260-
	215.000-	204.200-
B,C,X	220.060-	209.200-

**FT-709R
BLOCK DIAGRAM**