

FT-290RII

TECHNICAL SUPPLEMENT

This manual is intended to serve as a supplement to the FT-290RII Operating Manual. Detailed information regarding functions, specifications, options and operation has been provided in the Operating Manual, and is not reprinted herein. Therefore, this supplement is not intended to serve as an independent reference, but to be used in conjunction with the information provided in the Operating Manual.

Because of the compactness and complexity of the double-sided glass-epoxy circuit boards used in the FT-290RII, four layout diagrams are provided for each board. Each side of the board is identified by the type of the majority of components installed on that side. In most cases one side has only chip components, and the other has either a mixture of both chip and lead components (trimmers, coils, electrolytic capacitors, packaged ICs, etc.), or lead components only. The two "obverse" views depict the board as it is seen when viewed directly with the eye, while the two "reverse" views depict the unseen side of the board as it would appear if one were to peer through the board from the other side without seeing the components and tracks on the near side.

While we believe the technical information in this manual is correct, Yaesu assumes no liability for damage that may occur as a result of typographical or other errors that may be present. Your cooperation in pointing out any inconsistencies in the technical information would be appreciated.

Yaesu Musen reserves the right to make changes in the circuitry of this transceiver, in the interest of technological improvement, without notification of the owners.



YAESU MUSEN CO., LTD.
C.P.O. BOX 1500
TOKYO, JAPAN

MAIN UNIT

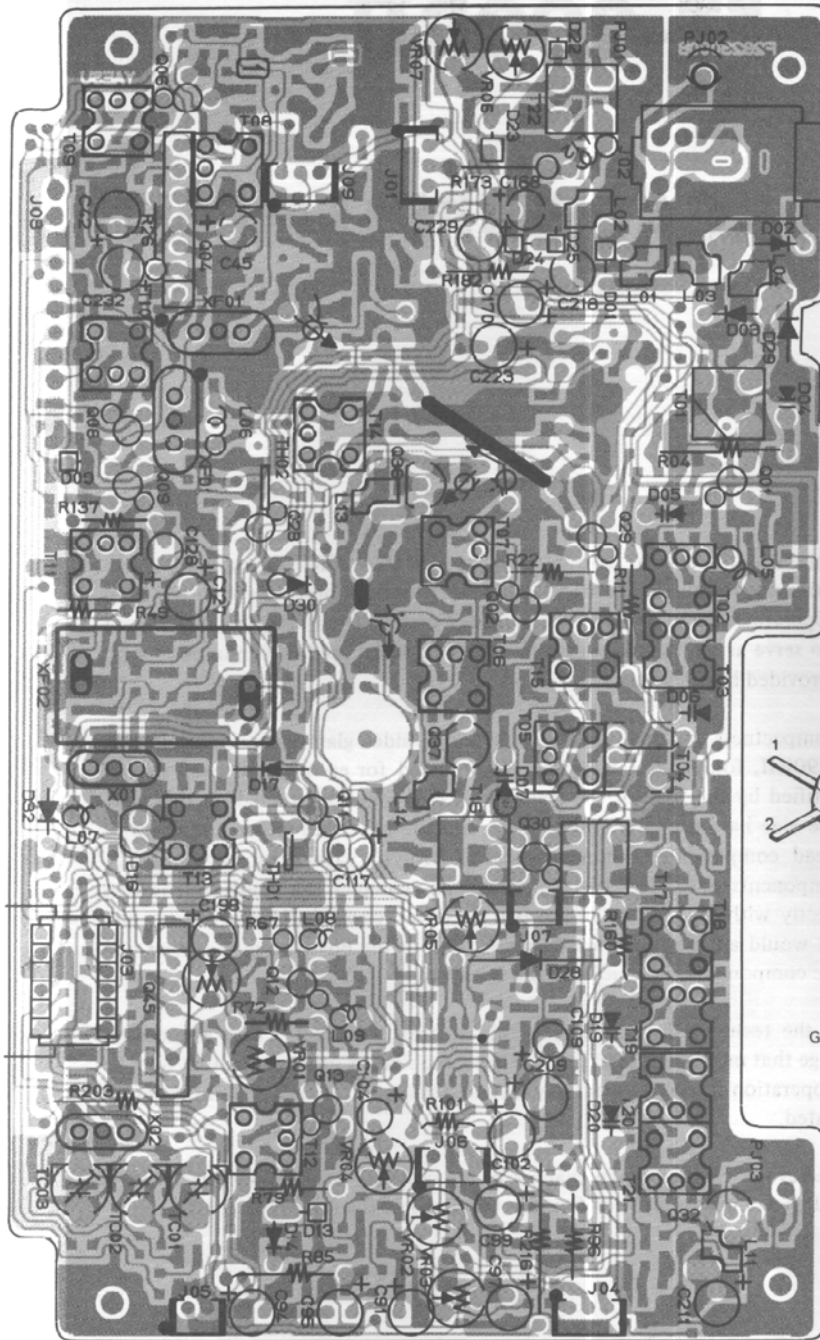

(obverse view of "component" side)

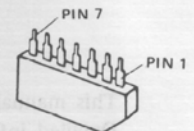

μPC577H (Q3004)
μPC1037H (Q3045)

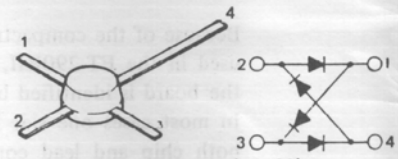

ND487C1-3R (Q3030)

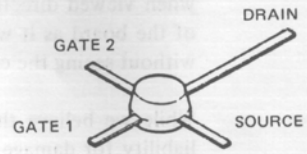

3SK74L (Q3002)
3SK122L (Q3001, 3006
3008, 3009
3011-3013
3028, 3029)

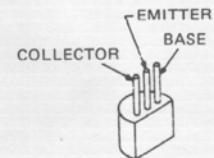

2SC2026 (Q3032, 3036)
2SC3355 (Q3037)

MAIN UNIT

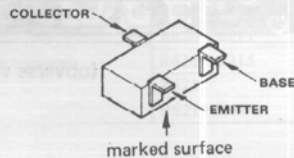
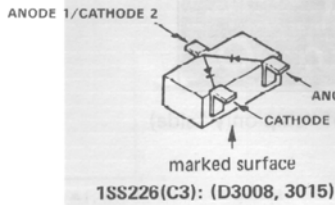
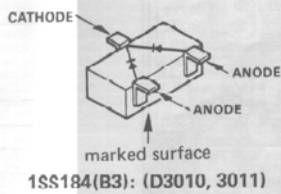
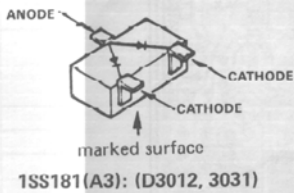
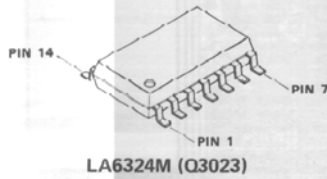
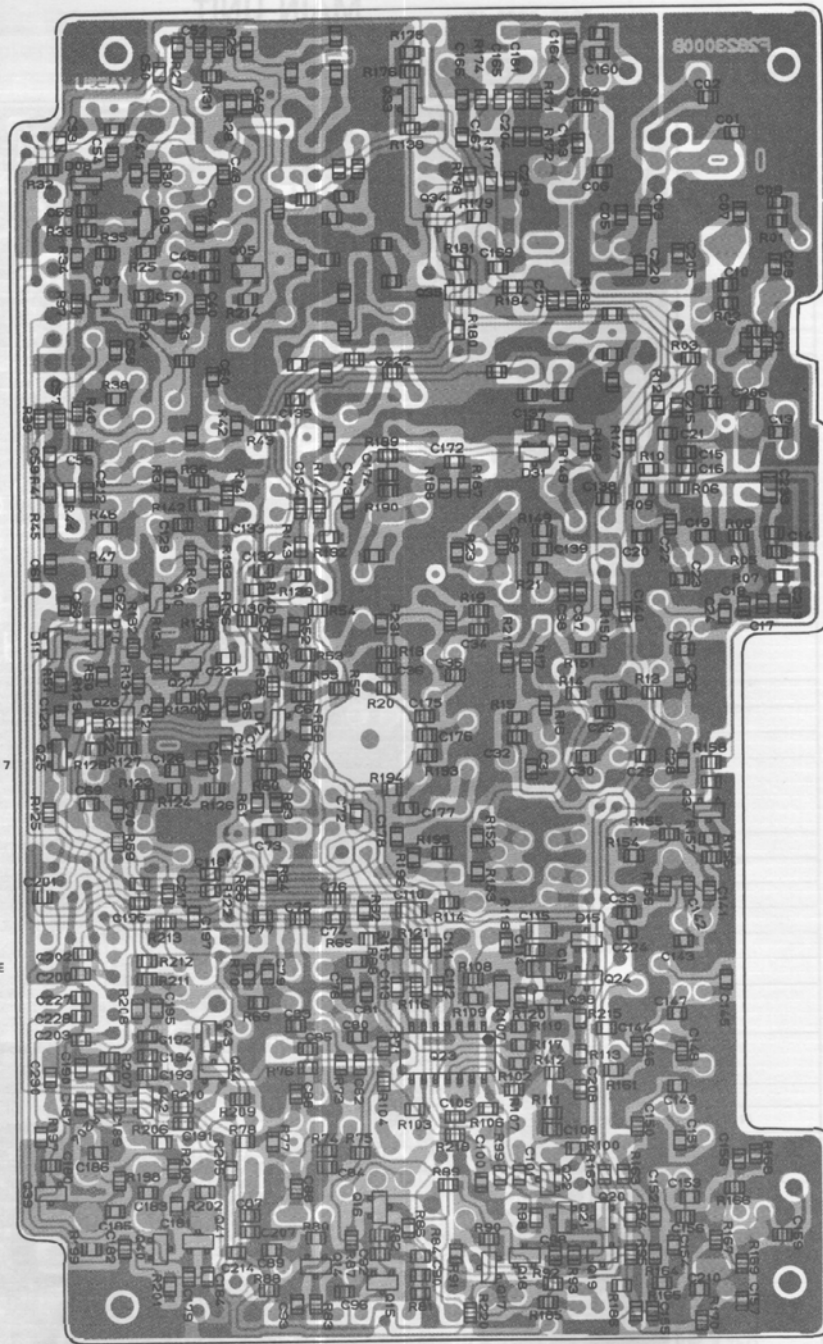

(reverse view of "chip-only" side)

2SA812F(M6): (Q3015, 3017, 3018, 3034, 3038)

2SC1623F(L6): (Q3003, 3005, 3007, 3010, 3014, 3016, 3019-3022, 3024, 3025, 3027, 3033, 3035, 3039-3044)

2SC2620B(OB): (Q3026)

2SC3052F(LF): (Q3031)

MAIN UNIT

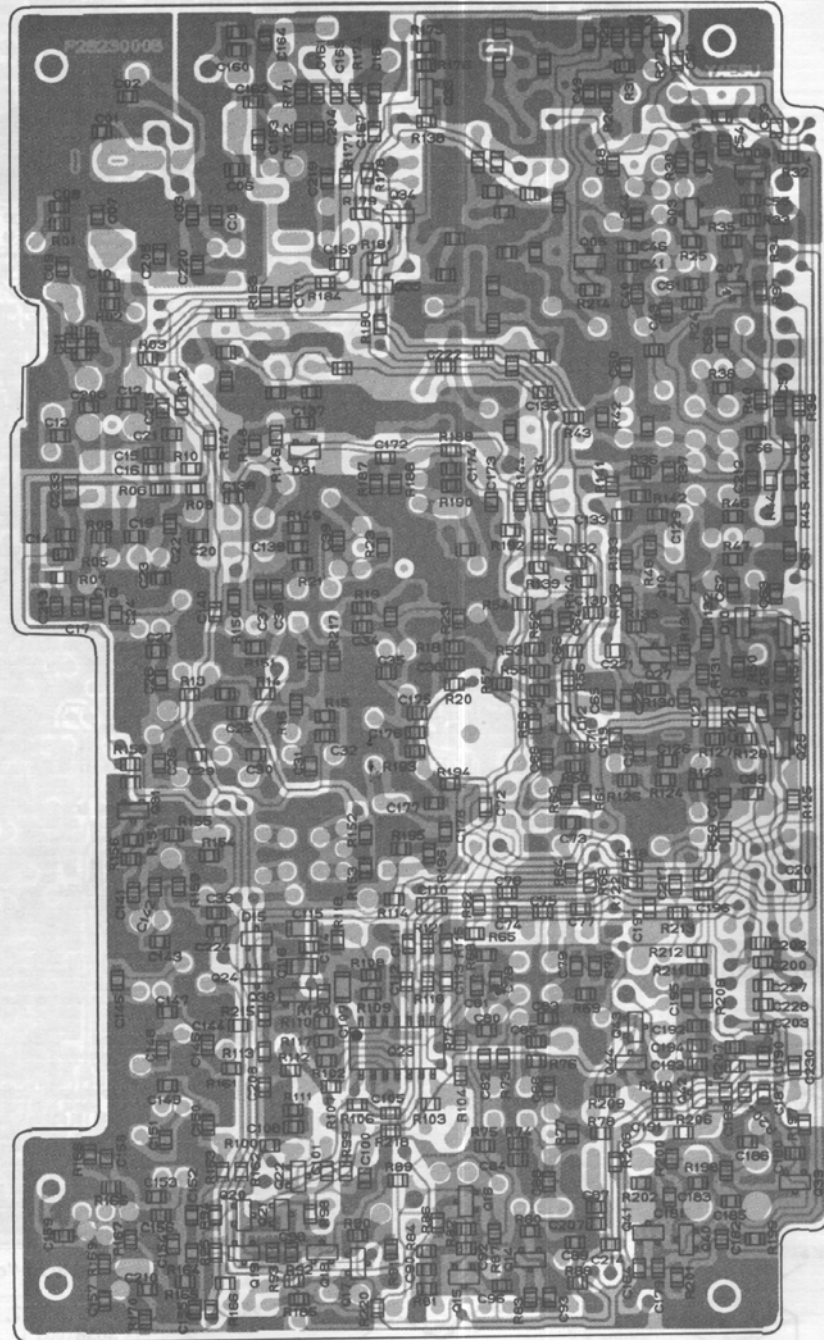

(obverse view of "chip-only" side)

MAIN UNIT

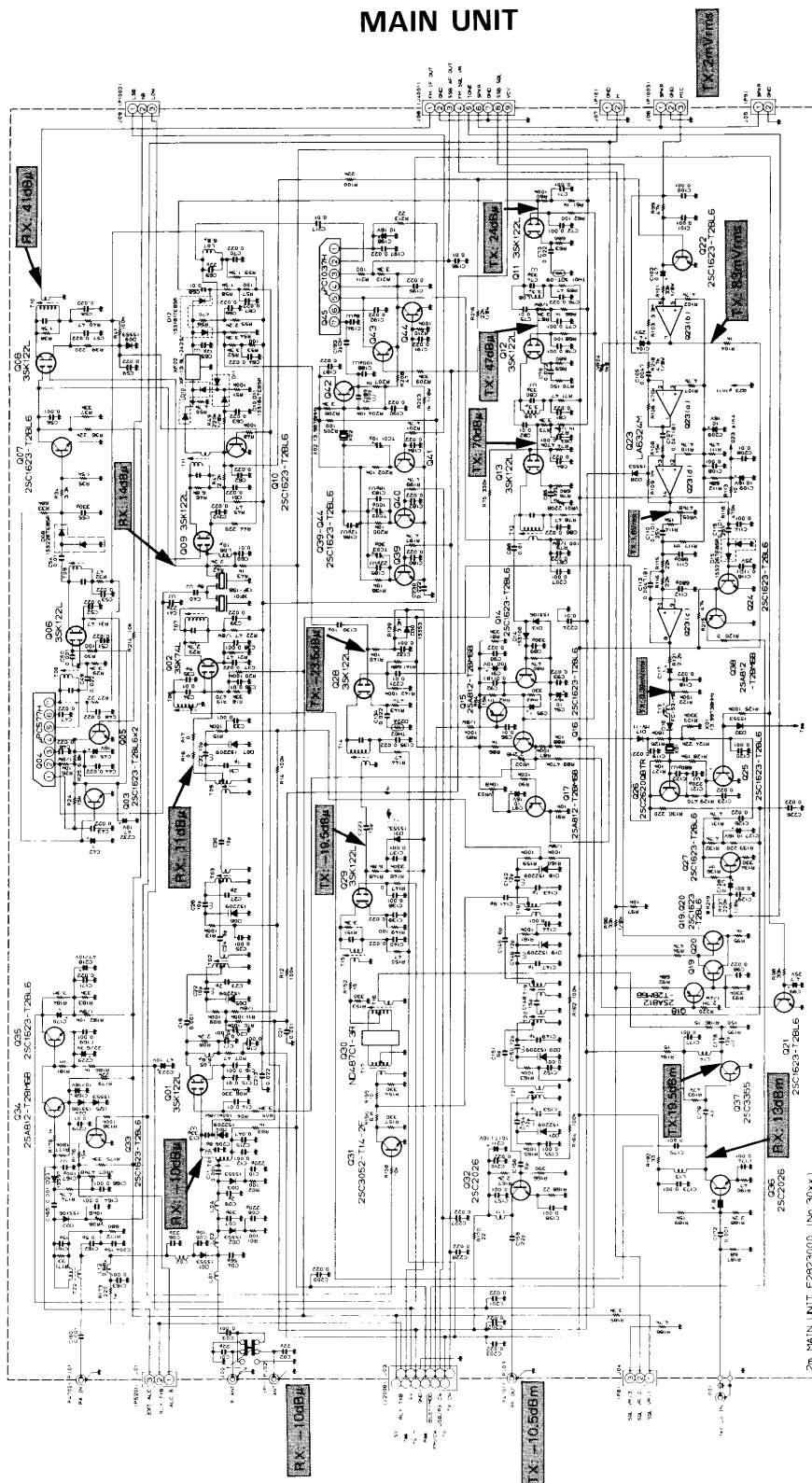

NOTES:
 1. ALL DIMENSIONS ARE IN MILLIMETERS.
 2. DIMENSIONS ARE TO CENTER UNLESS OTHERWISE NOTED.
 3. DIMENSIONS ARE TO CENTER UNLESS OTHERWISE NOTED.



2m MAIN UNIT F252000 (No. 30x)

MAIN UNIT VOLTAGE CHART (DC VOLT)

◎CONNECTORS

PIN No.	1	2	3	4	5	6	7	8	9	10	11	12	REMARKS
J3001	2.7	3.8	2.2	—	—	—	—	—	—	—	—	—	
J3003	0	6.8	0	4.9	1.8	0.8	0	0	-4.0	-4.0	-3.9	4.9	
J3004	3.9	3.9	1.3	—	—	—	—	—	—	—	—	—	
J3005	0.2	0	—	—	—	—	—	—	—	—	—	—	
J3006	0.2	0	0	—	—	—	—	—	—	—	—	—	
J3007	0	0	—	—	—	—	—	—	—	—	—	—	
J3008	0	0	4.7	1.9	0.1	0.2	0	4.9	5.2	—	—	—	
J3009	4.4	4.8	0	—	—	—	—	—	—	—	—	—	

◎TRANSISTORS & FETS

	E (S)	C (D)	B (G1)	(G2)	REMARKS		E (S)	C (D)	B (G1)	(G2)	REMARKS
Q3001	1.1/0	6.6/6.8	2.0	0.8/-3.9	RX/TX	Q3024	0	6.8	0	—	
Q3002	0.3	6.6	1.2	0		Q3025	0	0/0.1	0.6/0.7	—	RX/TX
Q3003	0	6.2/0.4	0	—	NB OFF/ON	Q3026	0/2.8	0/7.3	0/3.5	—	RX/TX
Q3005	0	6.2/0.1	0/0.7	—	NB OFF/ON	Q3027	0/0.2	0/6.0	0/0.7	—	RX/TX
Q3006	6.2/0.4	6.7/6.6	6.2/1.2	0.3	NB OFF/ON	Q3028	0/1.0	6.8/6.5	3.0	-4.0/0.8	RX/TX
Q3007	0	3.0	0	—		Q3029	0/0.8	6.8/6.3	2.9	-4.0/0.8	RX/TX
Q3008	1.2/0.6	6.7/6.8	3.0	0.8/-3.9	RX/TX	Q3031	0	0	0	—	
Q3009	1.2/0.6	6.5	3.0	0.8/-3.9	RX/TX	Q3032	0/0.3	0/7.3	0/1.1	—	RX/TX
Q3010	0	4.5/0	0/0.6	—	RX/TX	Q3033	0	1.9	0	—	
Q3011	1.2/0	6.7/6.8	2.9	0.8/-3.9	RX/TX	Q3034	0.8	-3.6	1.0	—	
Q3012	1.2/0	6.7/6.8	2.9	0.8/-3.9	RX/TX	Q3035	-4.0	2.9	-3.6	—	
Q3013	1.2/0	6.7/6.8	3.3	0.8/-3.9	RX/TX	Q3036	0.3	6.6	0.7	—	
Q3014	-3.3	2.9	-3.3	—		Q3037	0	0/7.4	0/0.8	—	RX/TX
Q3015	4.9	1.8	4.9	—		Q3038	1.9/3.6	0	6.8	—	RX/TX
Q3016	2.6	4.9	2.9	—		Q3039	0/1.6	6.7/4.4	0	—	FM/SSB
Q3017	0	3.1	2.5	—		Q3040	0/1.6	6.7/1.6	0/2.2	—	FM/SSB
Q3018	0	3.1	2.5	—		Q3041	0/1.6	6.7/4.4	0	—	FM/SSB
Q3019	0.1	0.8	0	—		Q3042	6.0/3.2	6.7/4.4	6.5/3.3	—	FM/SSB
Q3020	0.1	0.1	0.8	—		Q3043	6.0/0.1	6.0/0	0/2.8	—	FM/SSB
Q3021	0	0	0.6	—		Q3044	0	6.0/0.1	0/0.8	—	FM/SSB
Q3022	0	0	0.6/0	—	RX/TX						

◎ICs

PIN No.	1	2	3	4	5	6	7	8	9	10	11	12	13	14	REMARKS
Q3004	6.2/5.2	6.2/1.1	6.2/1.3	6.2/0.1	6.8/6.2	6.2/1.9	6.8/6.2	—	—	—	—	—	—	—	NB OFF/ON
Q3023	2.7	2.7	2.7	6.7	2.7	2.7	2.7	2.8	2.8	2.3	0	2.8	2.8	2.8	
Q3045	6.8/6.4	6.8/5.5	6.1/4.9	6.0/0.1	6.0/2.8	6.0/2.9	6.0/2.9	—	—	—	—	—	—	—	FM/SSB

CHIP SEMICONDUCTOR CROSS-REFERENCE (MAIN UNIT)

PART LOCATION No.	ORIGINAL NOMENCLATURE (MARKING) AND PART NUMBER	REPLACEMENT NOMENCLATURE (MARKING) AND PART NUMBER		
	Q3017, 3034	2SA812F (M6) G3108120F	2SA1179F (M6) G3111790F	
Q3015, 3018, 3038	2SA812F/G(M6/M7) G3108120F/G	2SA1162GR (SG) G3111620G	2SA1179F/G(M6/M7) G3111790F/G	
Q3014, 3016, 3035, 3042	2SC1623F(L6) G3316230F	2SC2712GR (LG) G3327120G	2SC2812F (L6) G3328120G	
Q3003, 3005, 3007, 3010, 3019, 3020, 3021, 3022, 3024, 3025, 3027, 3033, 3036, 3040, 3041, 3043, 3044	2SC1623F/G(L6/L7) G3316230F/G	2SC2462C/D(LG/LD) G3324620C/D	2SC2712GR/BL(LG/LL) G3327120G/B	2SC2812F/G(L6/L7) G3328120F/G
Q3031	2SC3052F (LF) G3330520F	2SC3052E (LE) G3330520E		
D3012, 3031	ISS181 (A3) G2070001	DCA0151A (A4) G2070014	MC2836 (A4) G2070024	
D3010, 3011	ISS184 (B3) G2070009	DCB0151A (A6) G2070012	MC2838 (A6) G2070018	
D3008, 3015	ISS226 (C3) G2070003	ISS123 (C3) G2070020		

*Semiconductors not listed above may be replaced only with original types.

MAIN UNIT (DC VOLT) PLL/PA UNIT

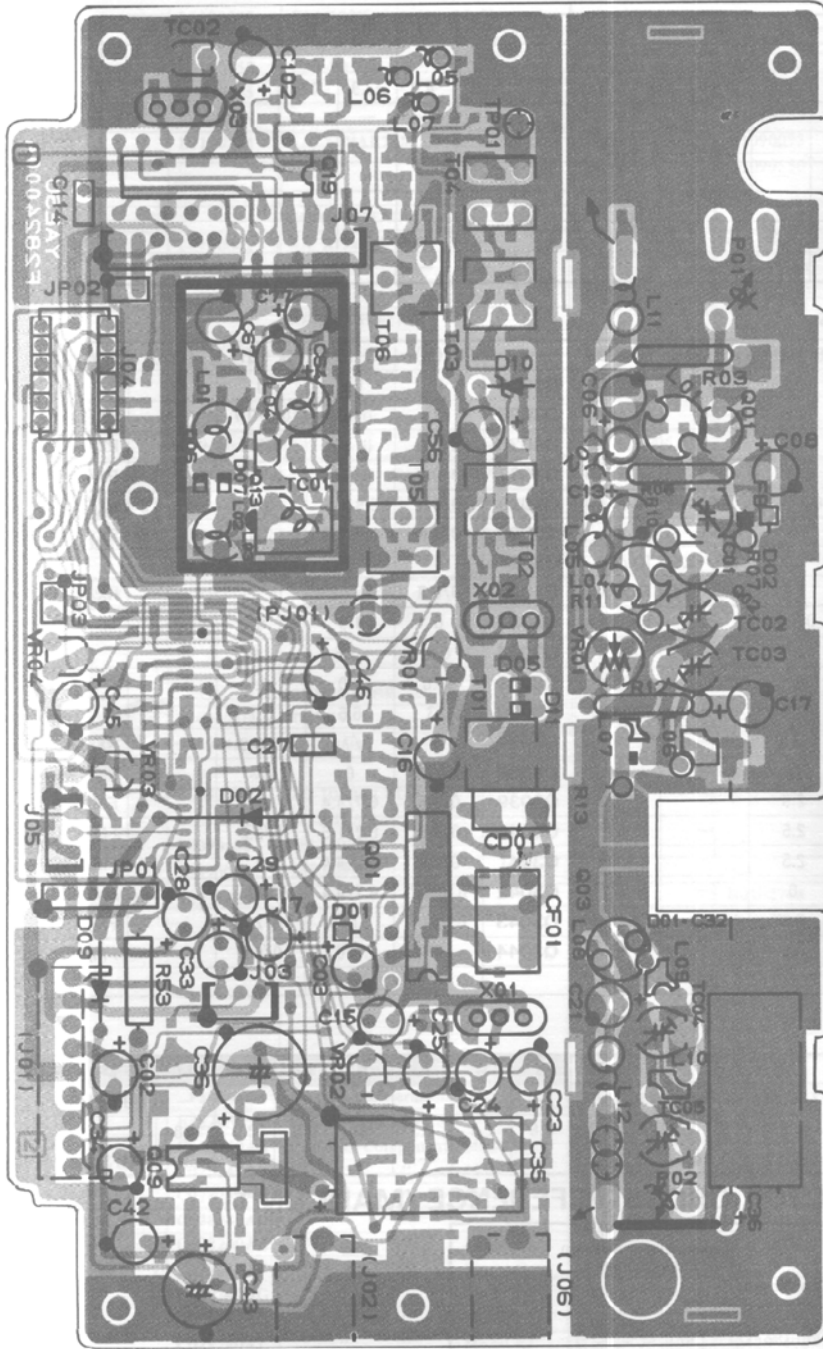

CONNECTORS

CONNECTOR	TYPE	NO. OF PINS	TYPE
JP01	100-0000000-0	10	100-0000000-0
JP02	100-0000000-0	10	100-0000000-0
JP03	100-0000000-0	10	100-0000000-0
JP04	100-0000000-0	10	100-0000000-0

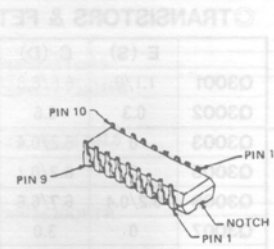

MC145145P1 (Q4019)

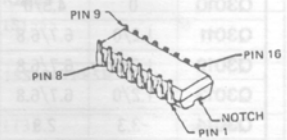

MC3357P (Q4001)

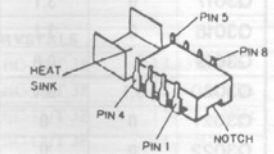

μPC575C2 (Q4009)

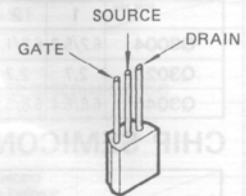

2SK192A-GR (Q4013)

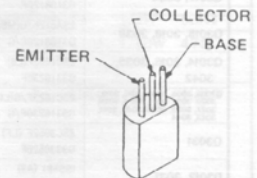

2SC2538 (Q4702)

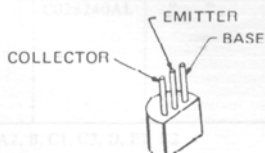

2SC3355 (Q4701)

(obverse view of "component" side)

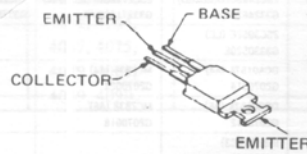

2SC1971 (Q4703)

PLL/PA UNIT

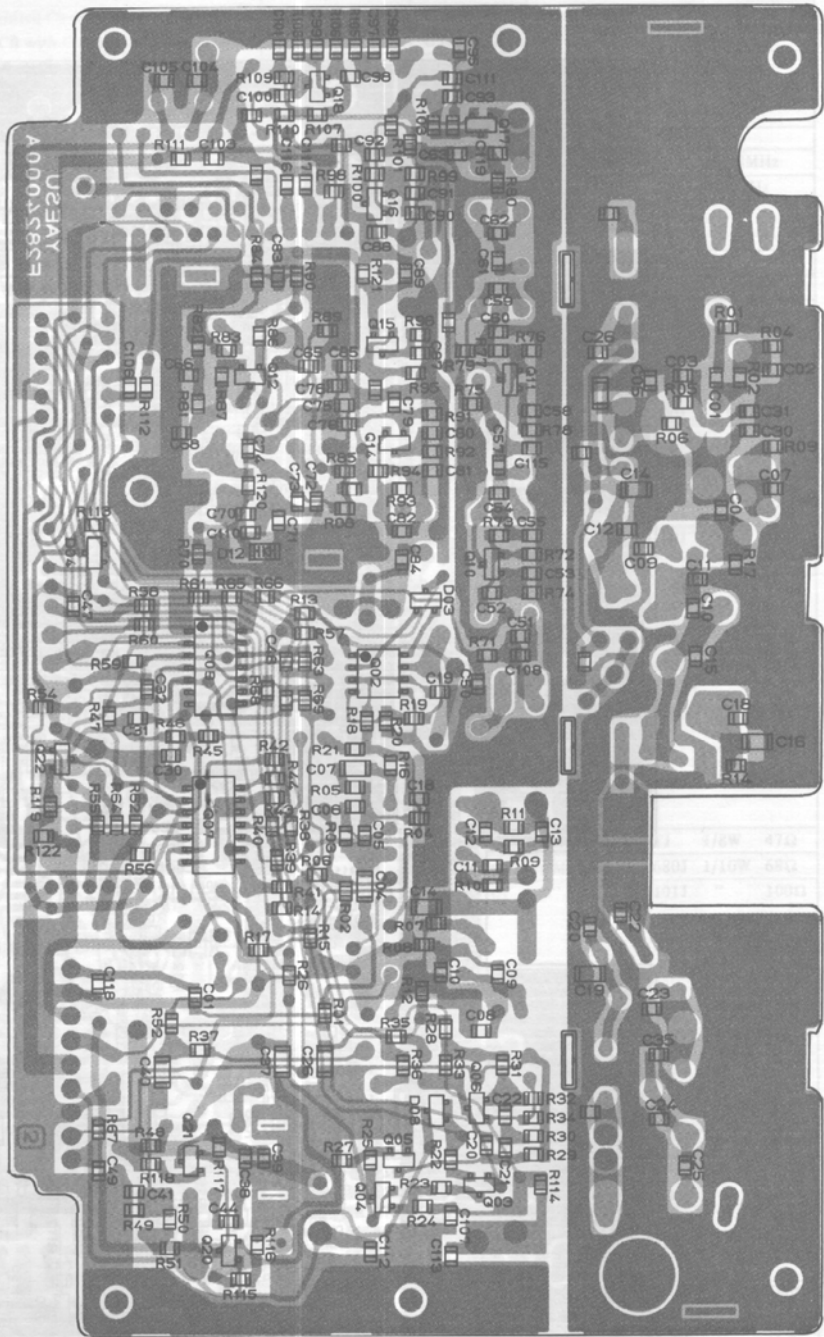

(reverse view of "chip-only" side)

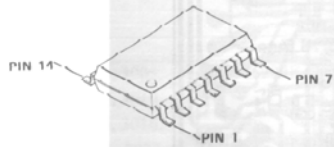

LA6324M (Q4008)
 μPD1066BG (Q4007)

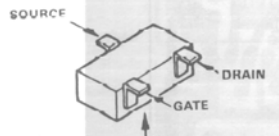

marked surface
 2SK302Y(TY): (Q4014, 4015)

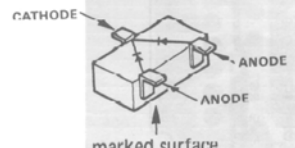

marked surface
 1SS184(B3): (D4003, 4004, 4008)

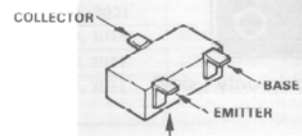

marked surface

2SA812F(M6): (Q4003, 4004, 4012)
 2SC1623F(L6): (Q4005, 4006, 4010, 4020-4022)
 2SC2620B(QB): (Q4011, 4016-4018)

PLL/PA UNIT

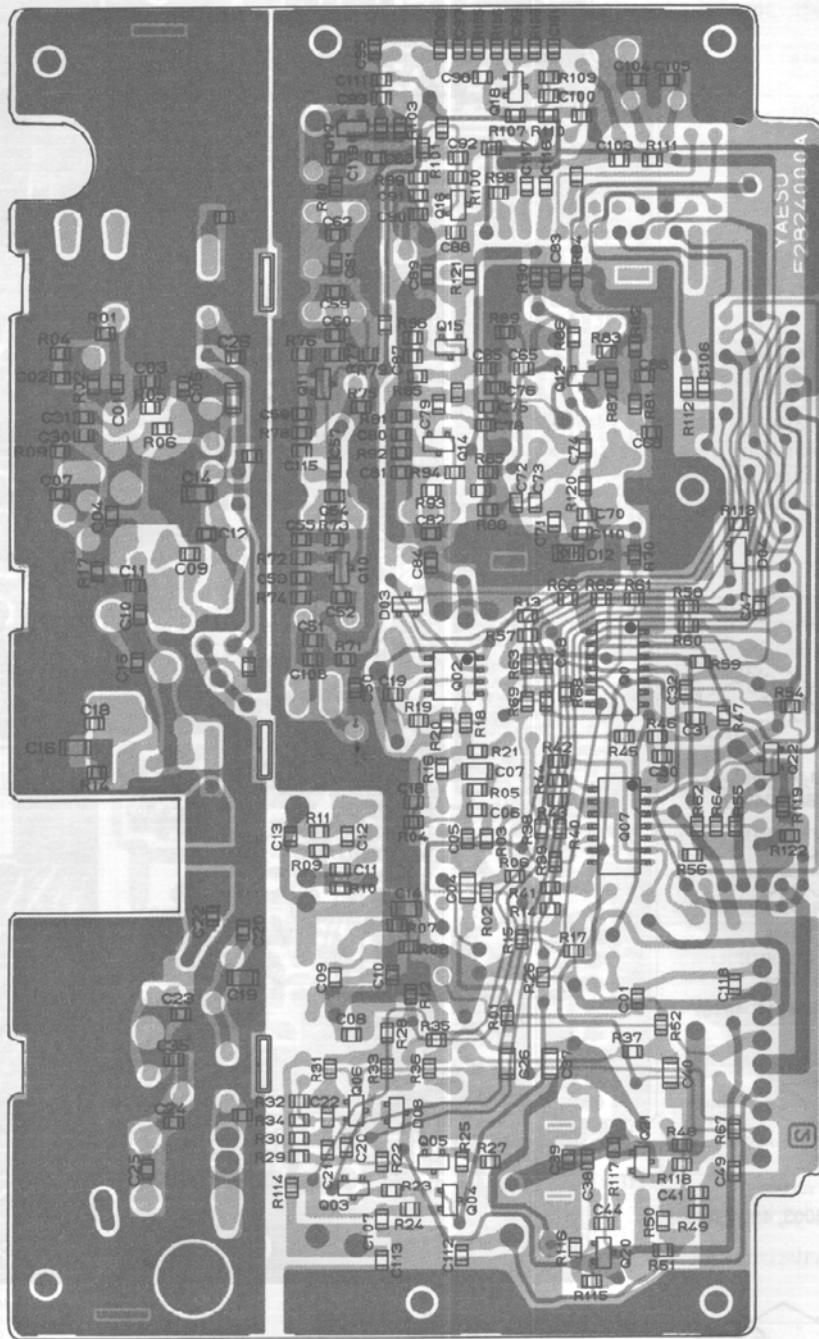

(obverse view of "chip-only" side)

PLL/PA UNIT

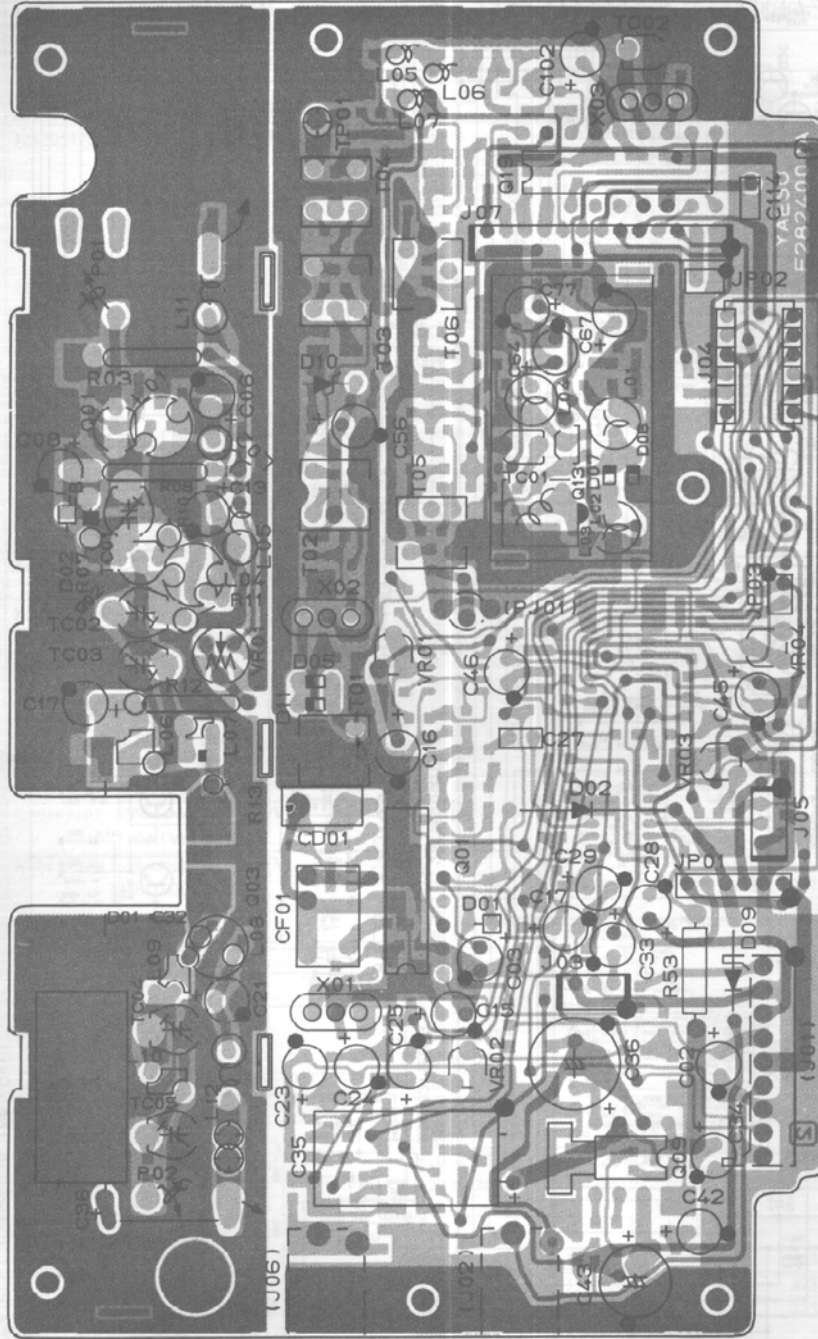

(reverse view of "component" side)

PLL/PA UNIT

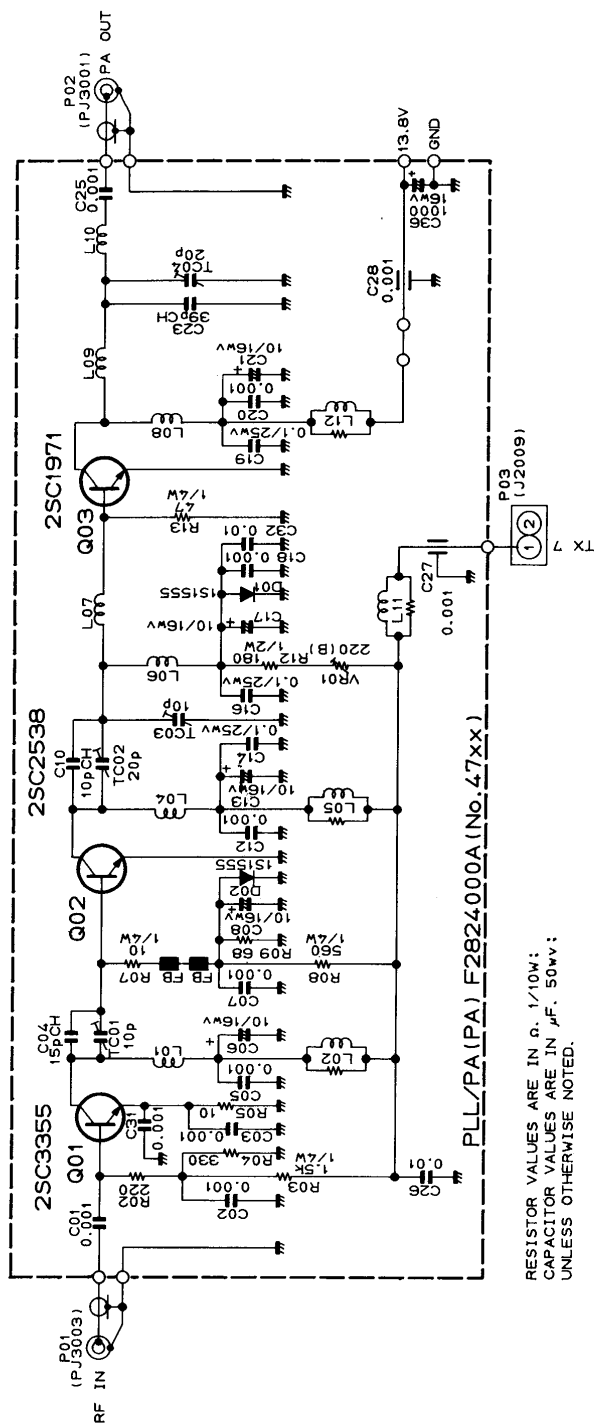

PLL/PA UNIT VOLTAGE CHART (DC VOLT)

◎CONNECTORS

PIN No.	1	2	3	4	5	6	7	8	9	10	11	12	13	REMARKS
J4001	0	0	6.2	1.9	-0.2/0.2	0.2/0	0	0.1	1.2					FM, CW RX/TX
	0	0	4.8	1.9	-0.2/0.2	0.2/0	0	0.1	1.2					LSB, USB RX/TX
J4003	0	0	0											
J4005	0	0~4.9	4.9											CLAR CW~CCW
J4007	0	0	0	0	0.4	4.7	4.5	0	4.5	0	0	0	0	

	13.8V	TX	5V	GND	U.L	CENT	MUTE	7V	-4V	FM	FM	CW	REMARKS
J4004	13.8	4.5/0	4.9	0	4.8	0	4.9	6.8	-3.9	4.5/0	0.1	0	FM RX/TX
	13.8	4.5/0	4.9	0	4.8	0	4.9/0	6.8	-3.9	0	4.8	4.5	CW RX/TX
	13.8	4.5/0	4.9	0	4.8	0	4.9/0	6.8	-3.9	0	4.8	0	USB, LSB RX/TX

◎TRANSISTORS

	E	C	B	REMARKS		E	C	B	REMARKS
Q4003	4.9	4.9	4.3		Q4014	0.2	6.6	0	
Q4004	2.8/0.1(4.7)	2.8/-0.1(4.7)	2.2/0(4.1)	CW RX/TX (FM, USB, LSB)	Q4015	0.5	6.7	0	
Q4005	0	0	0.6		Q4016	0.9	6.7	1.5	
Q4006	0.9	3.8	1.5		Q4017	0.3	6.1	0.9	
Q4010	1.2	6.6	1.9		Q4018	0.1	0.9	0.7	
Q4011	1.3	6.7	2.0		Q4020	0(0)	0.1/13.6(0.1)	0.64/0(0.64)	FM, USB, LSB RX/TX (CW)
Q4012	1.6	0	0.9		Q4021	1.7/13.6(13.6)	13.6(13.6)	0.1/13.6(0.1)	FM, USB, LSB RX/TX (CW)
Q4013	1.1	6.3	0						

◎ICs

	1	2	3	4	5	6	7	8	9	10	11	12	13	14	15	16	17	18	REMARKS
Q4001	6.5/6.4	6.2/6.0	6.4/6.3	6.6/6.4	1.1	1.1	1.1	6.6/6.4	2.8/2.7	1.9	2.0	0.7/0.3	0.5/9	4.5/0	0	2.0			FM RX/TX
	6.5/6.4	6.2/6.0	6.4/6.3	6.6/6.4	1.1	1.1	1.1	6.6/6.4	3.1/2.8	1.9	2.0	0.7/0.3	0.5/9	0	0	2.0			CW RX/TX
	6.5/6.4	6.2/6.0	6.4/6.3	6.6/6.4	1.1	1.1	1.1	6.6/6.4	3.1/3.2	1.9	2.0	0.7/0.3	0.5/9	0	0	2.0			USB RX/TX
	6.5/6.4	6.2/6.0	6.4/6.3	6.6/6.4	1.1	1.1	1.1	6.6/6.4	2.3/2.2	1.9	2.0	0.7/0.3	0.5/9	0	0	2.0			LSB RX/TX
Q4002	5.4	1.8	2.8/3.3	0	1.4	2.8	0	6.5											FM RX/TX
	5.4	1.8	3.0/2.9	0	1.4	3.0/2.9	0	6.5											CW RX/TX
	5.4	1.8	3.0/3.1	0	1.4	3.0/3.1	0	6.5											USB RX/TX
	5.4	1.8	2.3	0	1.4	2.3	0	6.5											LSB
Q4007	2.5	2.5	2.5	2.4	4.5	4.9	0	2.5	2.5	2.5	2.5	4.5	0.1/4.9	4.9					FM/CW, USB, LSB
Q4008	1.4	0.4	0.4	6.7	0.1	1.3	1.1	2.5	2.5	-3.8	0	0	0						FM, CW
	1.5	0.4	0.4	6.7	1.6	1.6	1.3	2.5	2.5	-3.8	0	0	0						USB
	2.0	0.4	0.4	6.7	1.6	1.6	1.3	2.5	2.5	-3.8	0	0	0						LSB
Q4009	1.7/1.8	13.5 ^{12.8/13.5}	7.2/0.3	5.9/0.6	13.6	0.2/0	1.7/4.8												FM, USB, LSB RX, CW /FM, USB, LSB TX
Q4019	0	0	2.3	0	4.8	2.1	2.3	4.5	0	4.5	0	1.4	4.8	4.8	4.8	1.6	0	0	FM, CW
	0	4.5	2.3	0	4.8	2.1	2.3	4.5	0	4.5	0	1.4	4.8	4.8	4.8	1.6	0	0	USB
	0	0	2.3	0	4.8	2.1	2.3	4.5	0	4.5	0	1.4	4.8	4.8	4.8	1.6	4.5	0	LSB

CHIP SEMICONDUCTOR CROSS-REFERENCE (PLL/PA UNIT)

PART LOCATION No.	ORIGINAL NOMENCLATURE (MARKING) AND PART NUMBER	REPLACEMENT NOMENCLATURE (MARKING) AND PART NUMBER	
	Q4012	2SA812F (M6) G3108120F	2SA1179F (M6) G3111790F
Q4003, 4004	2SA812F/G(M6/M7) G3108120F/G	2SA1162GR (SG) G3111620G	2SA1179F/G(M6/M7) G3111790F/G
Q4017	2SC1623F (L6) G3316230F	2SC2712GR (LG) G3327120G	2SC2812F (L6) G3328120F
Q4005, 4006, 4020, 4021, 4022	2SC1623F/G(L6/L7) G3316230F/G	2SC2462C/D(LC/LD) G3324620C/D	2SC2712GR/BL(LG/LL) G3327120G/B
Q4007	LC4066BM G1090772	PD4066BG G1090602	
D4003, 4004, 4008	ISS184 (B3) G2070009	DCB015TA (A6) G2070012	MC2838 (A6) G2070018

*Semiconductors not listed above may be replaced only with original types.

SW UNIT

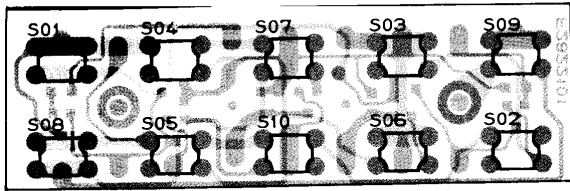

(obverse view of "component" side)

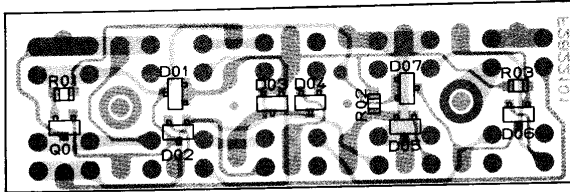

(reverse view of "chip-only" side)

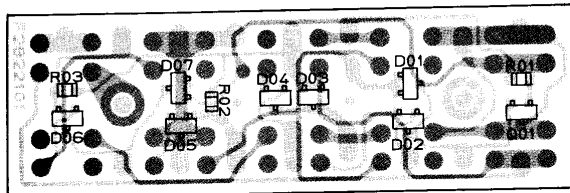

(obverse view of "chip-only" side)

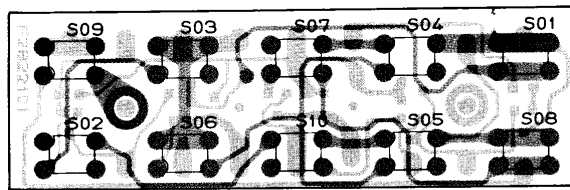

(reverse view of "component" side)

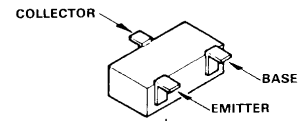

marked surface
2SA812F(M6): (Q2501)

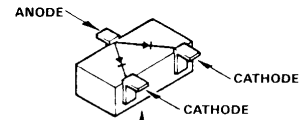

marked surface
1SS181(A3): (D2501~2507)

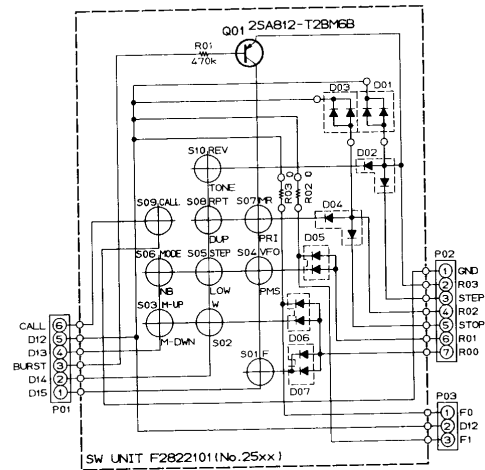

RESISTOR VALUES ARE IN Ω , 1/10 \times ,
DIODES ARE TYPE 1SS181;
UNLESS OTHERWISE NOTED.

CHIP SEMICONDUCTOR CROSS-REFERENCE (SW UNIT)

PART LOCATION No.	ORIGINAL NOMENCLATURE (MARKING) AND PART NUMBER		REPLACEMENT NOMENCLATURE (MARKING) AND PART NUMBER	
	Q2501	2SA812F/G (M6/M7)	ZSA1162GR (SG)	ZSA1179F/G (M6/M7)
D2501, 2502, 2503, 2504, 2505, 2506, 2507	G3108120F/G	G3111620G	G3111790F/G	
	ISS181 (A3)	DCAD157A (A4)	MC2836 (A4)	
	G2070001	G2070014	G20700024	

*Semiconductors not listed above may be replaced only with original types.

CNTL UNIT

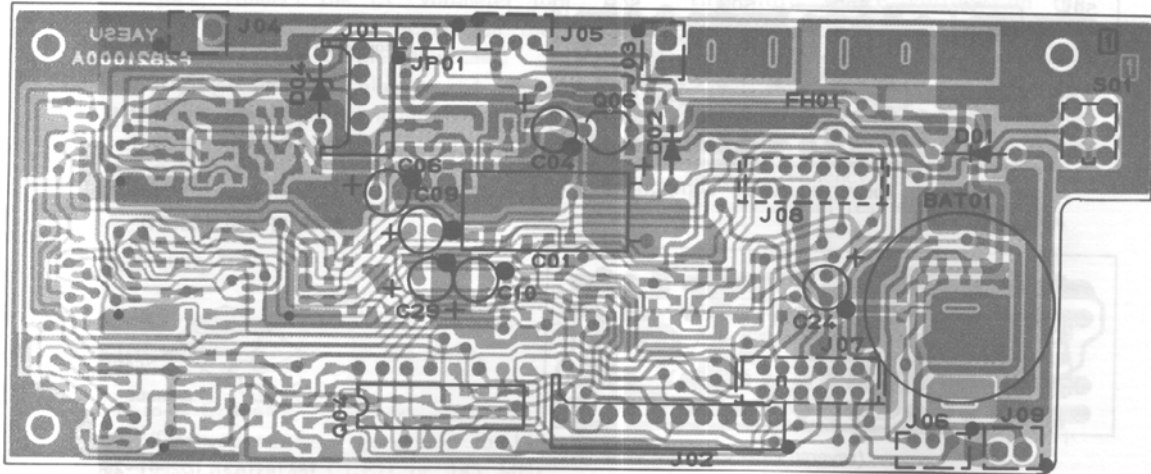

(obverse view of "component" side)

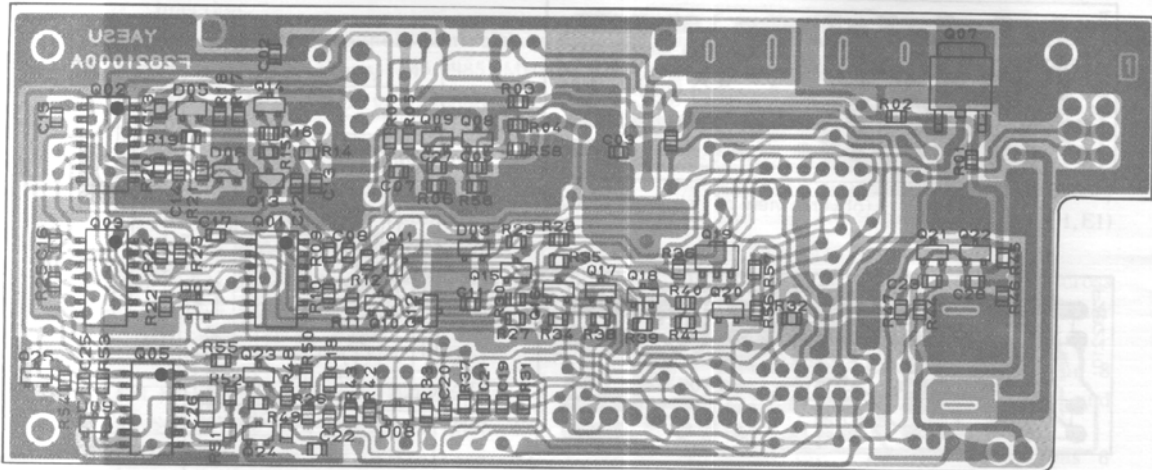

(reverse view of "chip-only" side)

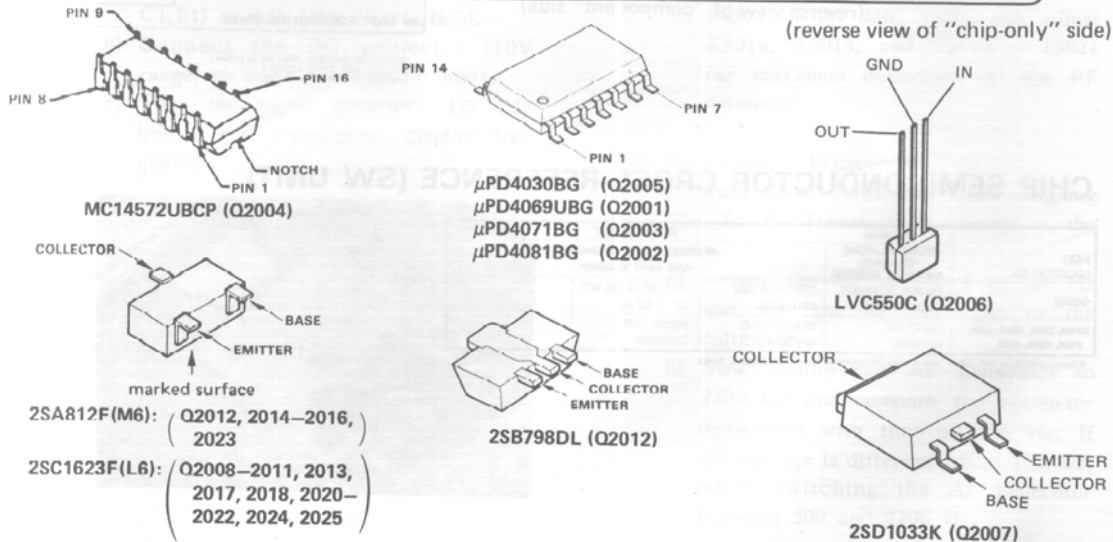

CNTL UNIT VOLTAGE CHART (DC VOLT)

◎CONNECTORS

PIN No.	1	2	3	4	5	6	7	8	9	10	REMARKS
J2001	4.5	0	4.9	0/5.9	0	-	-	-	-	-	LAMP OFF/ON
J2002	0	0	0	4.5	0	4.5	0	3.2	2.3	4.9	FM RX BUSY
J2003	12	12	-	-	-	-	-	-	-	-	
J2004	0	12	-	-	-	-	-	-	-	-	
J2005	4.6/0	4.6	3.1	-	-	-	-	-	-	-	BACK UP OFF/ON
J2006	0	0	0	-	-	-	-	-	-	-	RX
J2009	0	12	-	-	-	-	-	-	-	-	RX
JP2001	12	7.9	11.5	-	-	-	-	-	-	-	

	13.8V	TX	5V	GND	U.L	CENT	MUTE	7V	-4V	FM	FM	CW	REMARKS
J2007	12	4.6	4.9	0	1.5	0	4.9	6.9	-4.5	4.5	0	0	FM RX

	TX	CW	USB/RX	USB/RX	BUSY/ MOD	GND	-4V	RL TXB	5V	TBB	TX7	RBB	FM/CW	7V	REMARKS
J2008	0	0	0	0	2.3	0	-4.5	-4.5	4.9	-4.5	0	0.7	4.9	6.9	FM RX

◎TRANSISTORS & FETS

	E (S)	C (D)	B (G)	REMARKS		E (S)	C (D)	B (G)	REMARKS
Q2007	0.7/6.3	12	0/6.9	LAMP OFF/ON	Q2017	0	11	0	RX
Q2008	4.1	11.5	4.6		Q2018	0	0	0.7	RX
Q2009	4.1	6.9	4.7		Q2019	12	-4.5	11.5	RX
Q2010	0	2.5	2.5		Q2020	0	0	0.6	RX
Q2011	2.7	6.9	2.5		Q2021	0	0	0	RX
Q2012	2.7	0	2.5		Q2022	0	0	0	RX
Q2013	0	0	0.6		Q2023	12	11.5	11	
Q2014	4.9	4.9	4.3		Q2024	0	4.5	0	
Q2015	0.8	-4.5	4.9	RX	Q2025	0	3.4	0	
Q2016	0.8	0.7	0	RX					

◎ICs

PIN No.	1	2	3	4	5	6	7	8	9	10	11	12	13	14	15	16
Q2001	2.5	2.8	2.8	2.1	2.1	2.4	0	0	4.9	4.9	0	0	4.5	4.9	-	-
Q2002	4.9	0	0	4.9	4.7	4.9	0	4.5	0	0	0	0	0	4.9	-	-
Q2003	0	4.5	4.9	4.9	4.5	0	0	0	0	0	0	0	0	4.9	-	-
Q2004	0	4.4	0	4.1	4.9	0	0	0	0	3.4	0	4.3	4.9	0	1.5	4.9
Q2005	4.9	4.9	0	4.9	0	4.9	0	0.5	0	0	0	4.9	4.5	4.9	-	-
Q2006	12	0	4.9	-	-	-	-	-	-	-	-	-	-	-	-	-

CHIP SEMICONDUCTOR CROSS-REFERENCE (CNTL UNIT)

PART LOCATION No.	ORIGINAL NOMENCLATURE (MARKING) AND PART NUMBER		REPLACEMENT NOMENCLATURE (MARKING) AND PART NUMBER		
	Q2012, 2014, 2015, 2016, 2023	2SA812F/G (M6/M7) G3108120F/G	2SA1162GR (SG) G3111620G	2SA1179F/G (M6/M7) G3111790F/G	
Q2008, 2009, 2010, 2011, 2013, 2017, 2018, 2020, 2021, 2022, 2024, 2025	2SC1623F/G (L6/L7) G3316230F/G	2SC2462C/D (LC/LD) G3324620C/D	2SC2712GR/BL(LG/LL) G3327120G/B	2SC2812F/G (L6/L7) G3328120F/G	
D2009	ISS181 (A3) G2070001	DCA015TA (A4) G2070014	MC2836 (A4) G2070024		
D2007	ISS184 (B3) G2070009	DCB015TA (A6) G2070012	MC2838 (A6) G2070018		
D2003, 2005, 2006, 2008	ISS226 (C3) G2070003	ISS123 (C3) G2070020			

*Semiconductors not listed above may be replaced only with original types.

CPU UNIT

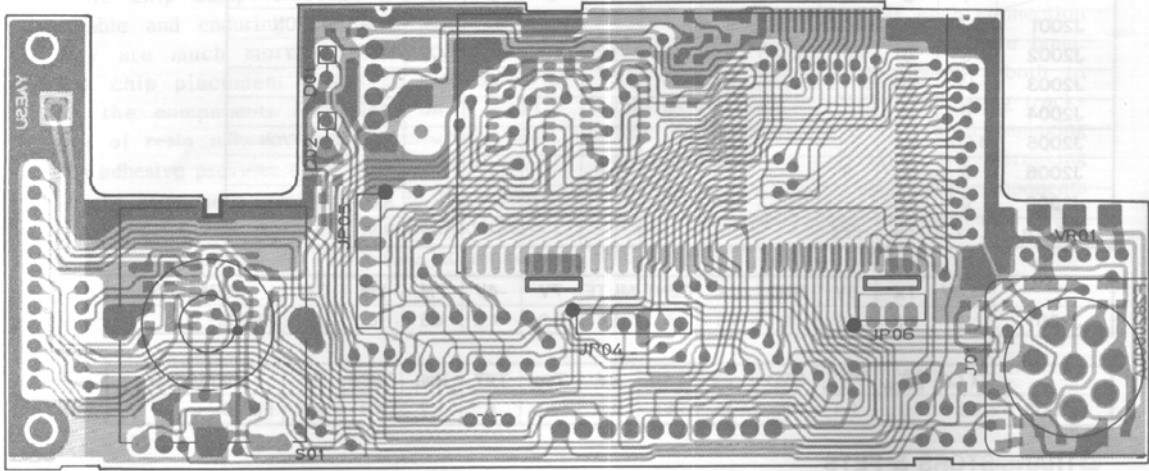

(obverse view of "LCD" side)

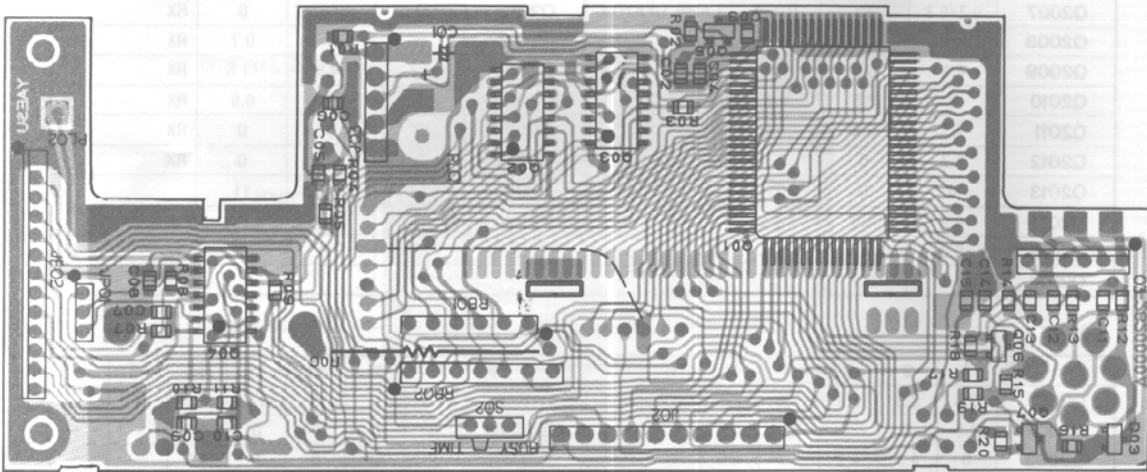

(reverse view of "IC" side)

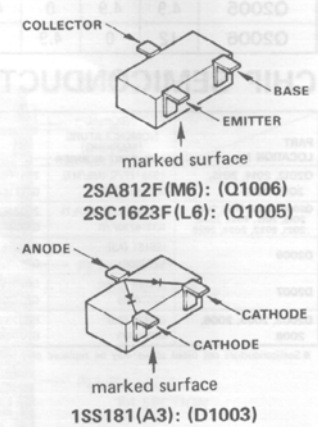
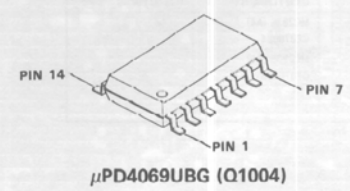
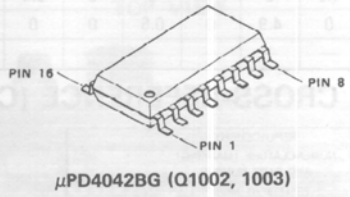
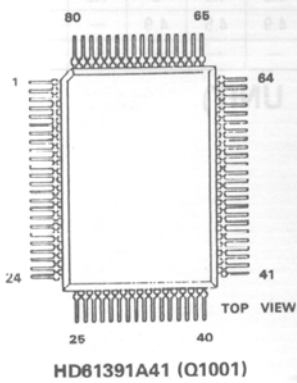

BOTTO 4 VIEW

SIGNAL PAT IS : FM
CPU UNIT

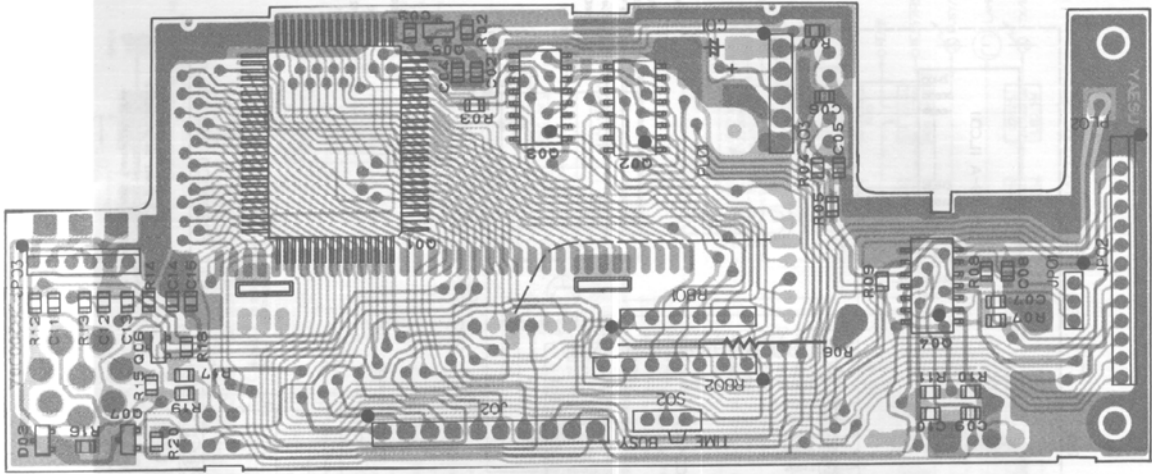

(obverse view of "IC" side)

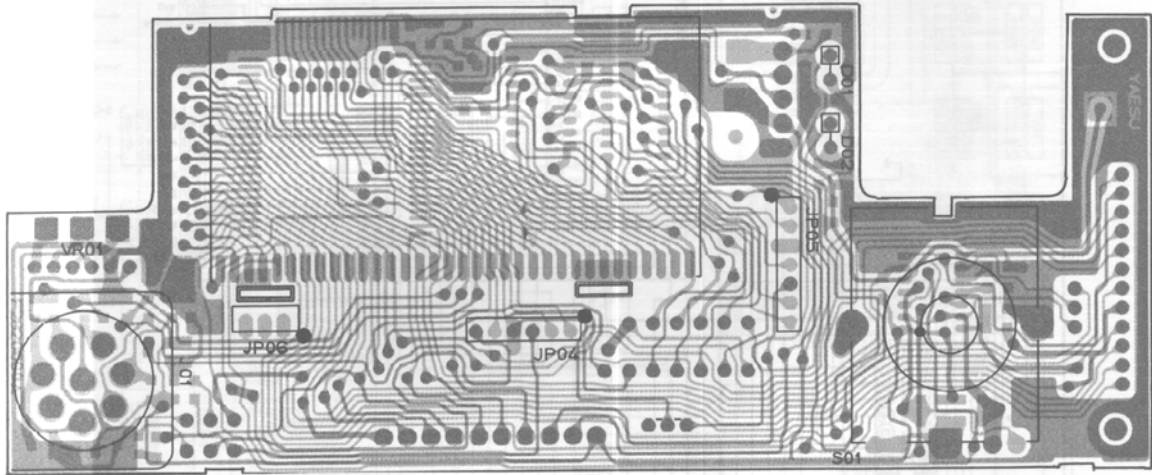

(reverse view of "LCD" side)

CPU UNIT

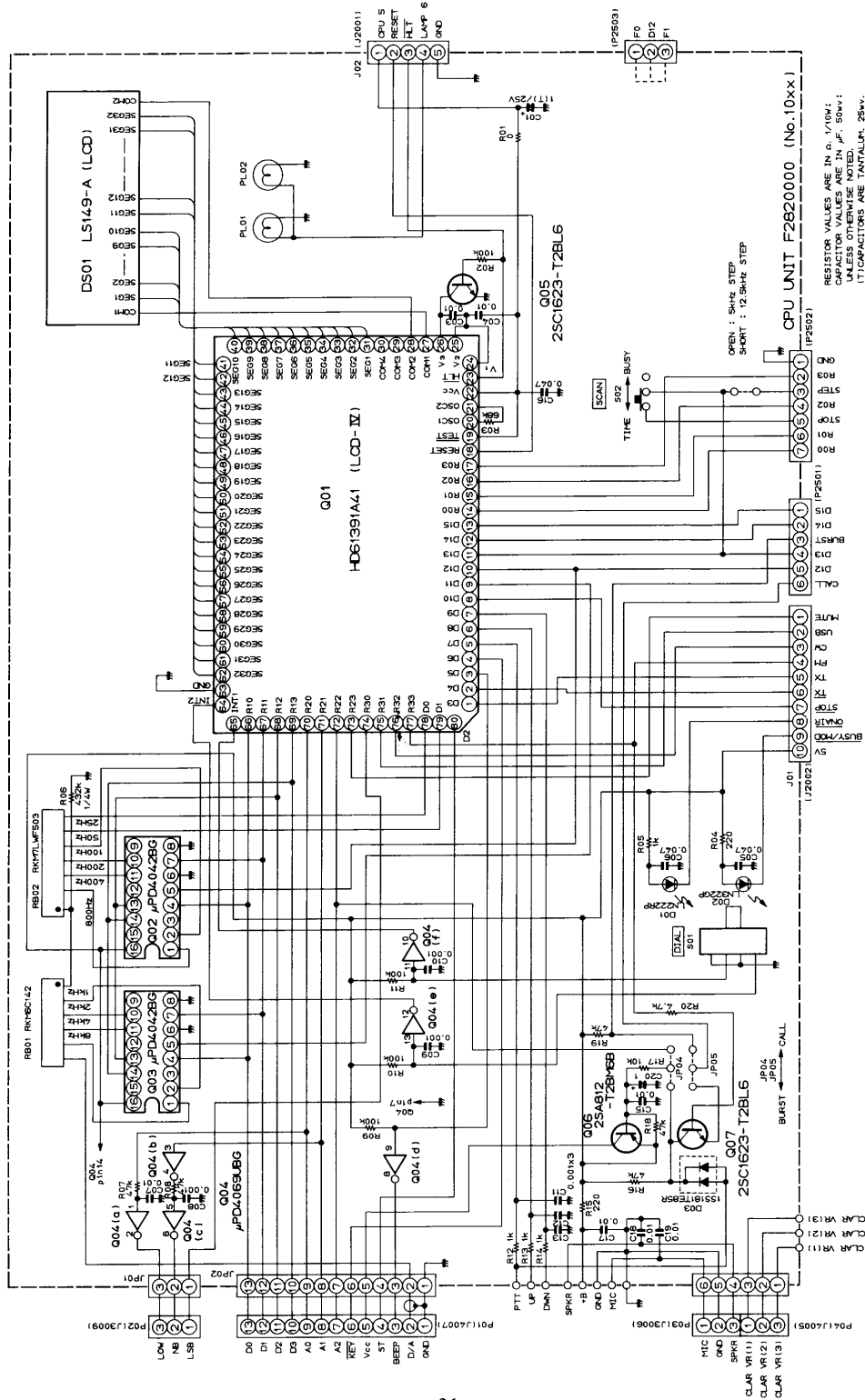

RESISTOR VALUES ARE IN Ω, KΩ, MΩ;
CAPACITOR VALUES ARE IN μF, nF;
UNLESS OTHERWISE NOTED.
(T) CAPACITORS ARE TANTALUM, 25V.

CPU UNIT VOLTAGE CHART (DC VOLT)

◎CONNECTORS

PIN No.	1	2	3	4	5	6	7	8	9	10	11	12	13	REMARKS
J1001	0/4.5	0	0	4.5	0/4.5	4.5/0	0/4.9	3.2/0	2.3/3.7	4.9	—	—	—	FM RX/TX
J1002	4.5	0	4.9	0/5.9	0	—	—	—	—	—	—	—	—	LAMP OFF/ON
JP1001	0	0	0	—	—	—	—	—	—	—	—	—	—	
JP1002	0	0	0	0	0(4.9)	4.5	4.5	0	4.5	0	0	0	0	(T CALL ON)

◎TRANSISTORS & FETS

	E (S)	C (D)	B (G)	REMARKS
Q1005	0	0	0.6	
Q1006	4.9	0/4.9(0)	4.9/4.3(4.6)	T CALL OFF/ON (CALL OFF, ON)
Q1007	4.1/0(4.1)	4.9/0(4.9)	4.5/0.7(4.5)	T CALL OFF/ON (CALL OFF, ON)

◎ICs

PIN No.	1	2	3	4	5	6	7	8	9	10	11	12	13	14	15	16
Q1002	0	0	4.9	0	4.5	0	0	0	4.9	0	0	4.9	0	0	4.9	4.9
Q1003	0	0	4.9	0	4.5	0	0	0	4.9	0	0	4.9	0	0	4.9	4.9
Q1004	4.5	0	0	4.9	4.9	0	0	0	4.9	0	4.9	0	4.9	4.9	—	—
Q1001	1	2	3	4	5	6	7	8	9	10	11	12	13	14	15	16
	0	4.5	4.9	4.5	4.5	4.5	4.5	0	4.5	4.5	※	0.9	0.9	4.5	4.5	4.5
	17	18	19	20	21	22	23	24	25	26	27	28	29	30	31	32
	4.5	0	4.5	2.2	2.2	4.5	4.9	2.2	2.2	0	2.3	2.3	2.3	2.3	2.3	2.3
	33	34	35	36	37	38	39	40	41	42	43	44	45	46	47	48
	2.3	2.3	2.3	2.3	2.3	2.3	2.3	2.3	2.3	2.3	2.3	2.3	2.3	2.3	2.3	2.3
	49	50	51	52	53	54	55	56	57	58	59	60	61	62	63	64
	2.3	2.3	2.3	2.3	2.3	2.3	2.3	2.3	2.3	2.3	2.3	2.3	2.3	2.3	0	0
65	66	67	68	69	70	71	72	73	74	75	76	77	78	79	80	
0	0	0	0	0	4.5	0	4.5	0	0	0	0	4.5	0	0	0	

SCAN MODE	STEP	5kHz	12.5kHz
	TIME	4.3	4.3
BUSY	0	4.3	

CHIP SEMICONDUCTOR CROSS-REFERENCE (CPU UNIT)

PART LOCATION No.	ORIGINAL	REPLACEMENT		
	NOMENCLATURE (MARKING) AND PART NUMBER	NOMENCLATURE (MARKING) AND PART NUMBER		
Q1006	2SA812F/G(M6/M7) G3108120F/G	2SA1162GR (SG) G3111620G	2SA1179F/G (M6/M7) G3111790F/G	
Q1005, 1007	2SC1623F/G (L6/L7) G3316230F/G	2SC2462C/D (LC/LD) G3324620C/D	2SC2712GR/BL(L6/L7) G3327120G/B	2SC2812F/G (L6/L7) G3328120F/G
D1003	ISS181 (A3) G2070001	DCA0151A (A4) G2070014	MC2836 (A4) G2070024	

*Semiconductors not listed above may be replaced only with original types.

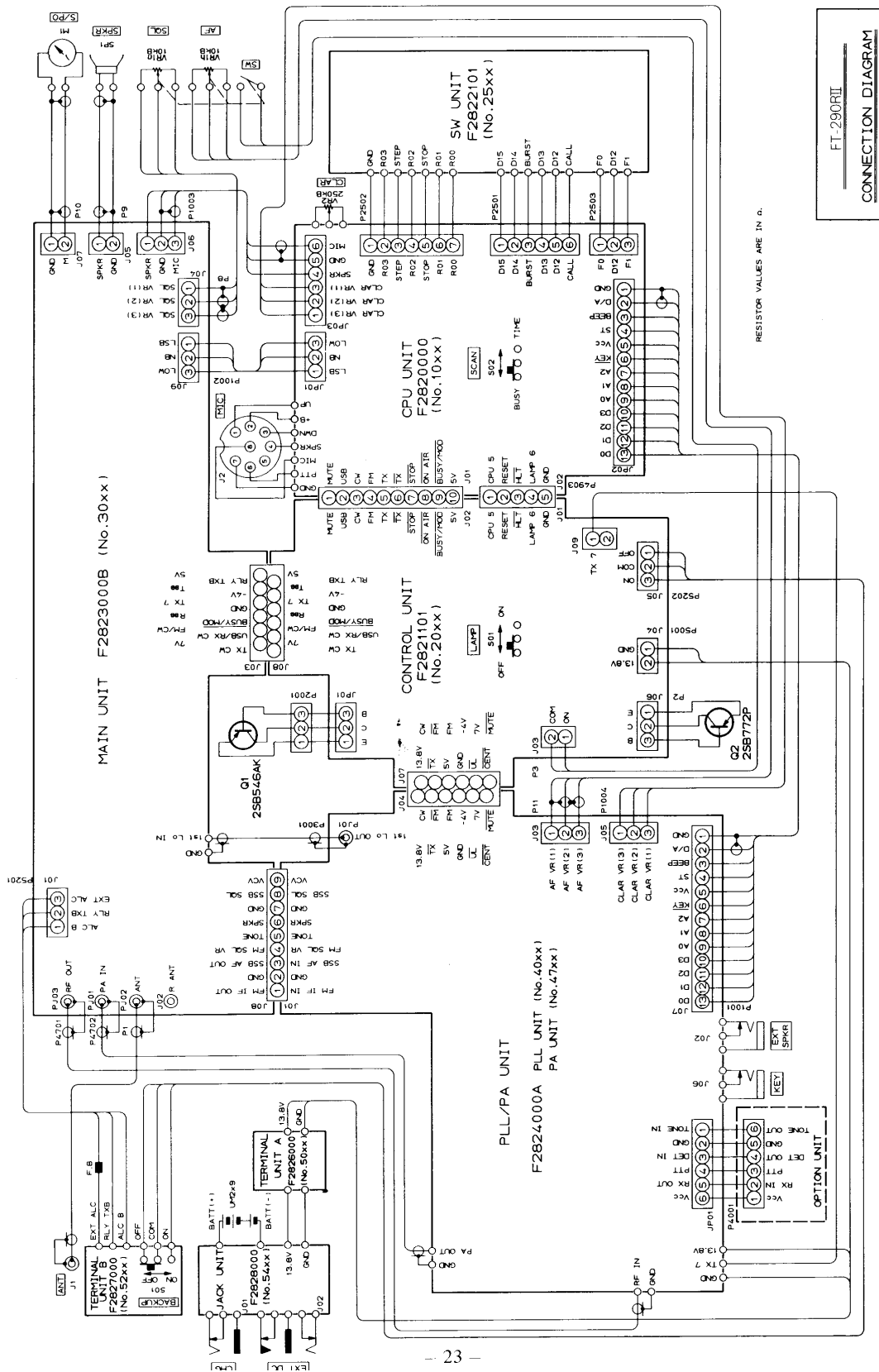

FT-290RI
CONNECTION DIAGRAM

FL-2025

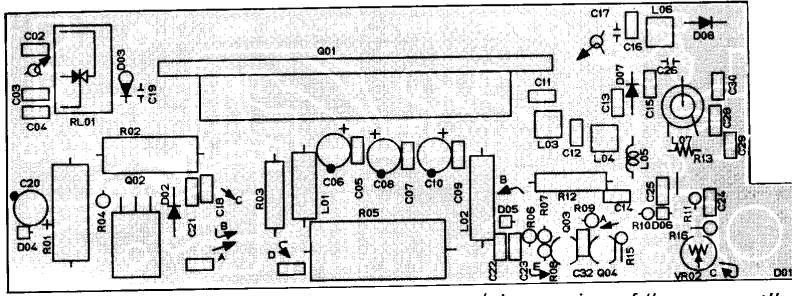

(obverse view of "component" side)

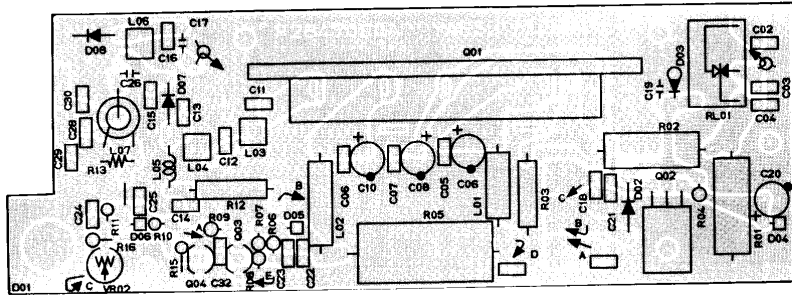

(reverse view of "component" side)

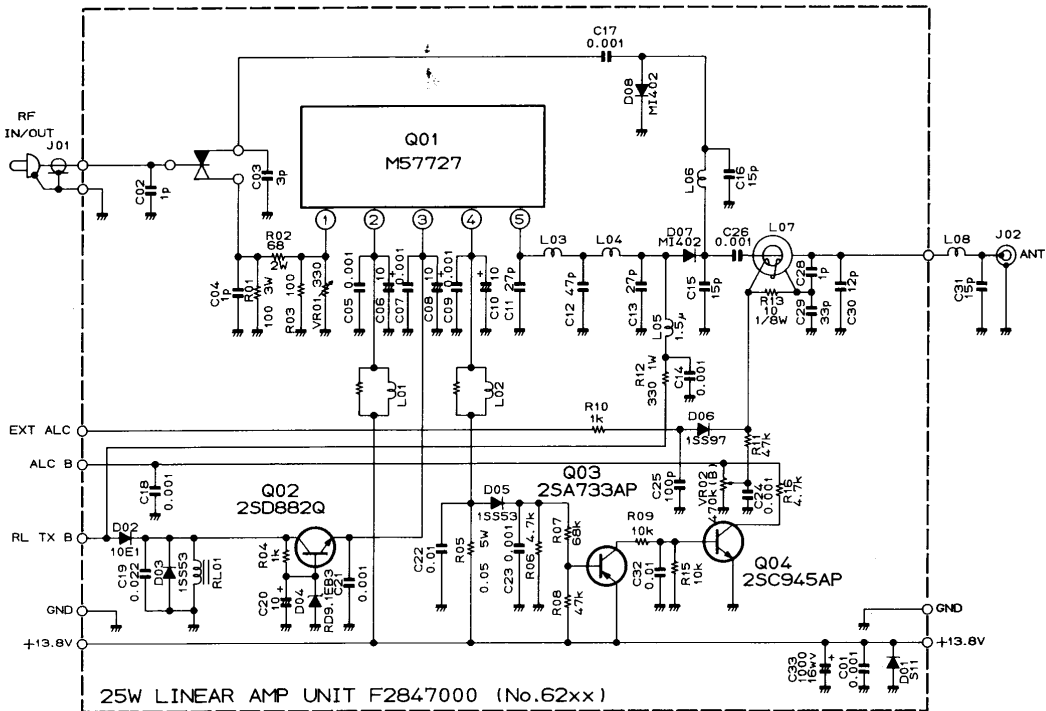
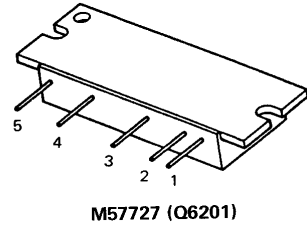
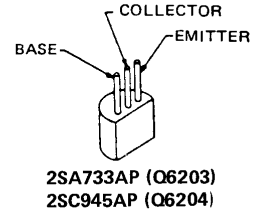
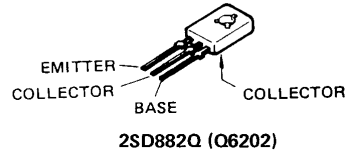

RESISTOR VALUES ARE IN Ω , 1/4W;
CAPACITOR VALUES ARE IN μ F, 50Vv;
INDUCTOR VALUES ARE IN HENRIES;
UNLESS OTHERWISE NOTED.

SIGNAL PATHS : CW

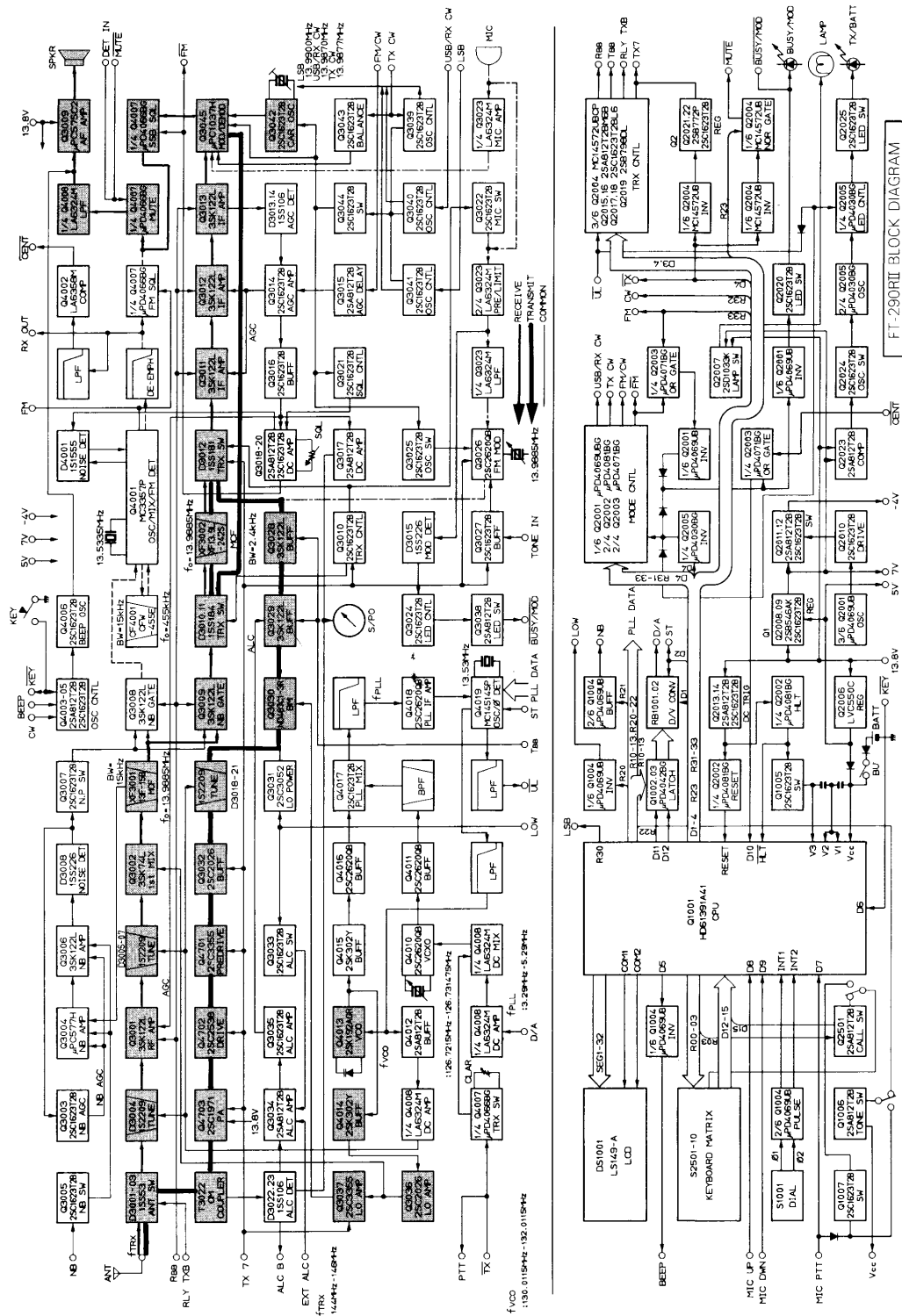

CHIP COMPONENT INFORMATION

While chip components are generally more reliable and enduring than lead components, they are much more difficult to replace. The chip placement robots at the factory set the components into place on a small spot of resin adhesive before soldering, and this adhesive provides rigid mechanical support for the component independently of the solder joints. Once the resin has been cured there is no way to remove it. Therefore, to remove

a chip component, it is necessary to first remove all of the solder at each connection and then forcefully break the adhesive bond. This must be done very carefully, both to avoid overheating the board and lifting tracks when desoldering, and to avoid damaging the board or underlying tracks when breaking off the component. Removed components should never be reused, as they are bound to be unreliable after removal.

BOARD LAYOUT

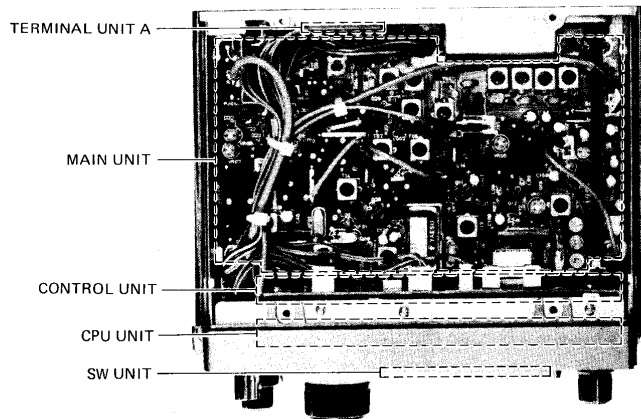

TOP VIEW

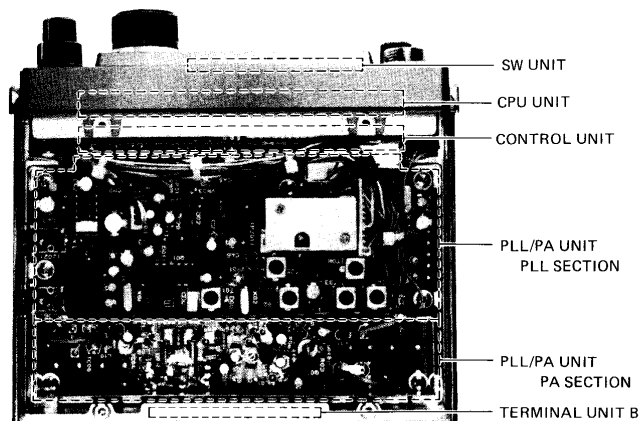

BOTTOM VIEW

ALIGNMENT

The high reliability of the chip components in the FT-290RII minimize the possibility that repair or realignment should be needed after leaving the factory. However, if damage occurs and some parts subsequently be replaced, realignment may be required. If a sudden problem occurs during normal operation, it is likely due to component failure; realignment should not be done until after the faulty component has been replaced.

Because of the compact circuitry of this transceiver, we recommend that servicing be performed only by authorized Yaesu service technicians who are experienced with the circuitry and fully equipped for repair and alignment. Therefore, if a fault is suspected, contact the dealer from whom the transceiver was purchased for instructions regarding repair. Authorized Yaesu service technicians realign all circuits and make complete performance checks to ensure compliance with factory specifications after replacing any faulty components.

Those who do undertake any of the following alignments are cautioned to proceed at their own risk. Yaesu must reserve the right to change circuits and alignment procedures in the interest of improved performance, without notifying owners.

Under no circumstances should any alignment be attempted unless the normal function and operation of the transceiver are clearly understood, the cause of the malfunction has been clearly pinpointed and any faulty components replaced, and the need for realignment determined to be absolutely necessary.

The following test equipment (and thorough familiarity with its correct use) is necessary for complete realignment. Correction of problems caused by misalignment resulting from use of improper test equipment is not covered under the warranty policy.

In those procedures so indicated, a 50-ohm dummy load that is non-reactive up to 150 MHz must be used. Correct alignment is not possible with an antenna.

Alignment Equipment

DC voltmeter (at least 20-kilohms/volt)
AF Millivoltmeter
150 MHz standard signal generator (SSG) with calibrated level and modulation (see note below)
AF signal generator
SINAD meter (SINADDER)
FM linear detector (deviation meter)
CM coupler (directional coupler)
RF wattmeter (50W, $\pm 5\%$ @ 150MHz)
50-ohm non-reactive (@150 MHz) dummy load
Frequency counter (100Hz resolution at 150MHz)
Oscilloscope

Note: SSG levels referred to in the alignment procedure are based on 0dBu=0.5uV.

Alignment Precautions

Correct alignment requires that the ambient temperature be the same as that of the transceiver and test equipment, and that this temperature be held constant between 20 and 30 °C (68 to 86 °F). When the transceiver is brought into the shop it should be allowed at least 2 hours for thermal equalization before alignment.

Alignments must not be made unless the oscillator shields and circuit boards are firmly affixed in place. Also, the frequency counter must be thoroughly warmed up before beginning.

Supply voltage during alignment must be held constant at 12.5V DC, except where specifically indicated otherwise. Use a well regulated, adjustable power supply capable of at least 10A continuous load.

A. PLL Unit, Part I

1) Reference Oscillator

Connect the frequency counter to pin 16 of Q4019 and adjust TC4002 for 13.530 MHz \pm 10 Hz. Remove the counter.

2) Loop Resonant Circuits

a) Connect the RF voltmeter to the junction of L4006 & C4098. Adjust T4002, T4003, T4004 and T4006 for maximum RF voltage. Remove the voltmeter.

NOTE: All of the remaining steps in this section (A) require that plug P3001 be removed from PJ4001 (1st Local Out), and a 50-ohm resistor (dummy load) be connected across PJ4001. P3001 will be replaced in step A. 4) d).

b) Connect the RF voltmeter across PJ4001 with the 50-ohm resistor, and adjust T4005 for maximum RF voltage. Remove the voltmeter.

3) D-to-A Converter

a) Connect the frequency counter across PJ4001 with the 50-ohm resistor, and adjust VR4003 for the same frequency in both transmit and receive (\pm 25 Hz).

b) Adjust T4001 for counter indications as follows (to within \pm 25 Hz);

Vers. A1, C1, E1 - 132.0115 MHz

Vers. B, D - 131.0115 MHz

c) Set the front panel controls to USB, 145.9985 MHz (Vers. A1, C1, E1), or 144.9985 MHz (Vers. B, D).

d) Slowly adjust the tuning knob until the display just steps down to xxx.9984 MHz (ie., to the highest step that shows this frequency).

e) Adjust VR4004 for the following frequency on the counter (\pm 50 Hz):

Vers. A1,C1,E1 - 132.011475 MHz

Vers. B,D - 131.011475 MHz

f) Remove the frequency counter.

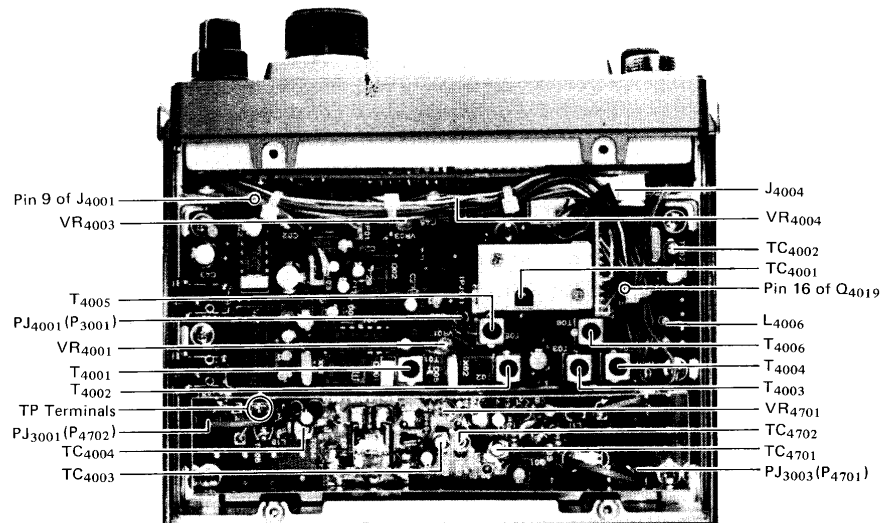

PLL/PA UNIT ALIGNMENT POINTS

- 4) PLL VCV (Varactor Control Voltage)
 - a) Select the FM mode and tune to the high band edge: 148.000 MHz (Vers. A1,C1,E1) or 146.000 MHz (Vers. B,D).
 - b) Connect the DC voltmeter to pin 9 of J4001, and adjust TC4001 for 3.6V DC (Vers. A1,C1,E1) or 2.8V DC (Vers. B,D), within $\pm 0.05V$.
 - c) Tune the transceiver to the low band edge (144 MHz) and confirm $2.2 \pm 0.2V$.
 - d) Remove the voltmeter and 50-ohm resistor and replace P3001 in PJ4001.

- 2) RF & IF Transformers
 - a) Connect the RF signal generator, tuned to 145 MHz, to the ANT jack.
 - b) Set the transceiver to USB, and tune for peak on the signal. Then reduce the injection level just below the S-meter (agc) threshold.
 - c) Connect the AF voltmeter to the EXT SP jack, and adjust T3001, T3002, T3003, T3005 and T3006 for maximum AF (adjust the VOL control as necessary to keep meter readings near mid-range).
 - d) Now set the injection level to -10dBu and adjust T3007, T3011 and T3012 for maximum AF. Then remove the voltmeter.

B. Main Unit, Receiver

NOTE: Remove plug P4701 from PJ3003 (RF Out) on the Main Unit for all of the steps in this section (B).

1) CW/FM Carrier Oscillator

- a) Touch the frequency counter probe to gate 1 of Q3029 for the following adjustments.
- b) Set the mode to CW, short the KEY jack to transmit, and adjust TC3003 for $13.9877 \text{ MHz} \pm 10 \text{ Hz}$.
- c) Now select the FM mode, close the PTT line and adjust T3013 for $13.9885 \text{ MHz} \pm 10 \text{ Hz}$. Remove the counter.

3) S-Meter Calibration

- a) In USB mode, with -10dBu injection, adjust VR3003 for S-5 indication on the S-meter.
- b) Adjust VR3001 just to the point where the S-meter reading begins to rise above S-5.
- c) Increase injection to -4dBu and readjust VR3003 for S-1 deflection.
- d) Increase injection to +16dBu and adjust VR3002 for S-9 deflection.

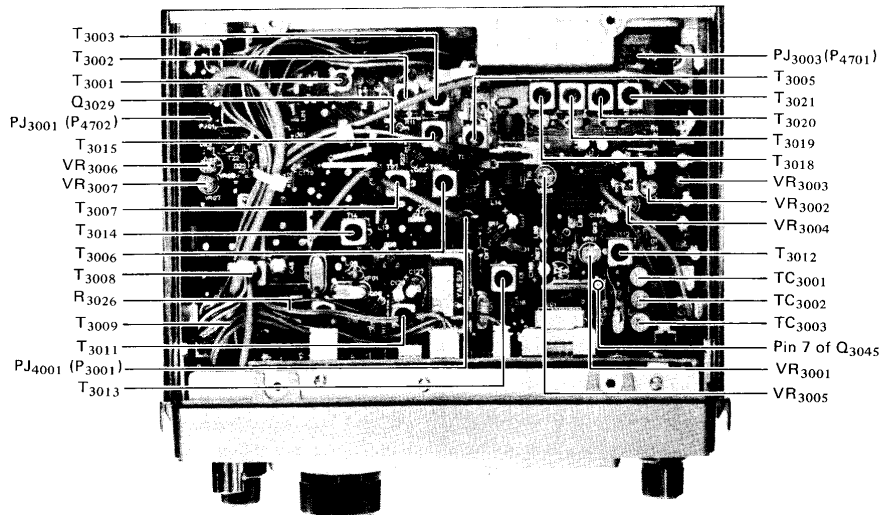

MAIN UNIT ALIGNMENT POINTS

- 4) Noise Blanker Transformers
 - a) With +16dB injection at the ANT jack, connect the DC voltmeter to the exposed end of R3026 on the component side of the Main Unit.
 - b) Turn on the noise blanker and adjust T3008 and T3009 for minimum voltage.
 - c) Remove the voltmeter, and replace P4701 in PJ3003.

C. PLL Unit, Part II

The RF signal generator must be connected to the ANT jack for all steps.

- 1) D-to-A Converter Linearity
 - a) Tune the signal generator to 146 MHz (Vers. A1,C1,E1) or 145 MHz (Vers. B,D), and set for 0dBu injection.
 - b) Set the front panel controls to USB, 25 Hz steps, 145.9985 MHz (Vers. A1, C1, E1), or 144.9985 MHz (Vers. B, D).
 - c) Slowly adjust the tuning knob back and forth around xxx.9985 and xxx.9984 MHz while listening to the beat of the injected carrier.
 - d) Adjust VR4004, if necessary, for smooth transition between the 25 Hz tuning steps.
- 2) FM Discriminator Center Detection
 - a) Select the FM mode, and tune the transceiver to 146 MHz (Vers. A1, C1,E1) or 145 MHz (Vers. B,D).
 - b) Connect the DC voltmeter (10V range) to the CENT pin of J4004.
 - c) Tune the signal generator 1.5 kHz below the transceiver display frequency.

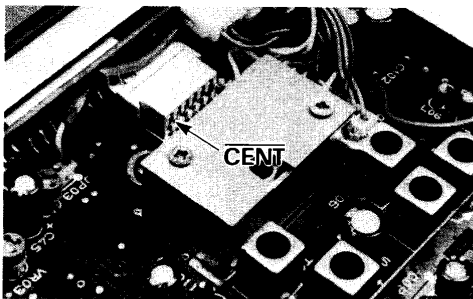

- d) Turn VR4001 fully clockwise, and then counterclockwise just over the threshold where voltage on the meter drops to zero.
- e) Referring to Figure 1, raise the signal generator frequency gradually to confirm that the voltage rises to 5V within 1.5 to 4.0 kHz above the display frequency.
- f) Disconnect all test equipment.

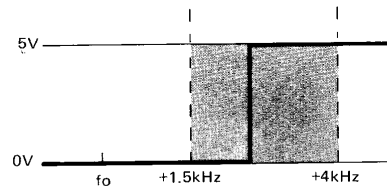

Figure 1

D. Main Unit, Transmitter

NOTE: Remove plug P4701 from PJ3003 (RF Out) on the Main Unit for all of the steps in this section (D).

- 1) Tx IF Transformers
 - a) Set the transceiver to USB mode, and tune to 146 MHz (Vers. A1,C1,E1) or 145 MHz (Vers. B,D).
 - b) Connect a 50-ohm resistor across PJ3003, and connect the RF voltmeter across the resistor.
 - c) Connect the AF generator to pin 8 (center pin) of the MIC jack, and inject 1 mV @ 1.5 kHz.
 - d) Close the PTT line (short pins 6 and 7 of the MIC jack), and adjust T3014, T3015, and T3018 - T3021 for maximum deflection on the RF voltmeter.
- 2) SSB Carrier Frequency

Perform these steps only after aligning the Tx IF Transformers. Setup is the same.

 - a) Retune the AF generator to 300 Hz and note the the deflection on the voltmeter.
 - b) Now retune the AF generator to 2700 Hz and compare the voltmeter deflection with that at 300 Hz. If the voltage is different adjust TC3002, while switching the AF generator between 300 and 2700 Hz.

- c) Select the LSB mode and repeat a) and b), adjusting TC3001 if necessary.
- d) Remove the test equipment, but do not replace P4701 in PJ3003 if you will be proceeding to the next section.

E. PA Unit

1) Idling Current

NOTE: Plug P4701 must be disconnected from PJ3003 during this procedure.

- a) Reduce the supply voltage to 8V DC.
- b) Connect the dummy load to the ANT jack.
- c) Temporarily remove the jumper between the terminal posts near L4712, and connect the milliammeter across these posts.
- d) Close the PTT line and adjust VR4701 for 50 ± 5 mA on the milliammeter.
- e) Remove the meter and replace the jumper between the posts.

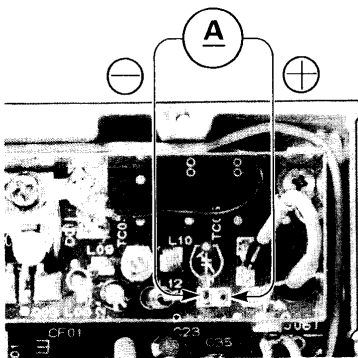

2) Interstage Matching Trimmers

- a) Connect plug P4701 (if removed earlier) to PJ3003.
- b) Connect the wattmeter and dummy load to the ANT jack.
- c) Select the FM mode, and set the transceiver to 146 MHz (vers. A1, C1,E1) or 145 MHz (vers. B,D).
- d) Close the PTT line and adjust trimmers TC4701 - TC4704 for maximum RF output.

F. Miscellaneous Transmitter Adjustments

1) ALC and PO Meter Calibration

- a) With the wattmeter and dummy load connected to the ANT jack, and the transceiver set to 146 MHz (vers. A1,C1,E1) or 145 MHz (vers. B,D), select the FM mode.
- b) Connect the AF generator to pin 8 (center pin) of the MIC jack, and inject 2 mV @ 1.5 kHz.
- c) Close the PTT line (short pins 6 and 7 of the MIC jack), and adjust VR3004 on the Main Unit for 2.8W output on the wattmeter.
- d) Increase the AF level to 6 mV and adjust VR3007 for 2.8W on the wattmeter.
- e) Adjust VR3006 so that the meter on the transceiver deflects to the center of the green zone.

2) FM IDC (Deviation Control)

- a) Connect the linear detector/deviation meter with the dummy load to the ANT jack.
- b) Set the AF generator (step b above) for 30 mV @ 1 kHz.
- c) Close the PTT line and adjust VR3005 for ± 4.5 kHz (± 100 Hz) deviation.
- d) Remove all test equipment.

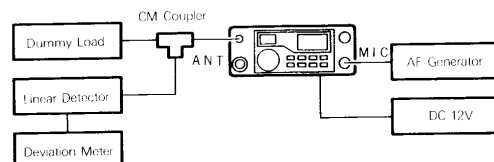

PARTS LIST

MAIN CHASSIS			R0115750 BOARD SPRING		
Symbol No.	Part No.	Description			
TRANSISTORS					
Q1	G3205461K	2SB546AK			
Q2	G3207720P	2SB772P			
POTENTIOMETERS			TERMINAL UNIT B		
VR1	J62800092	K12B61006 10KB/10KA AF, SQL	Symbol No.	Part No.	Description
VR2	J60800127	K121N0G0F 250KB CLAR		F2827000	Printed Circuit Board
				C028270AA	PCB with Components
CONNECTORS			SWITCH		
J1	P1090541	BNC-RM ANT			
J2	P0090384	FM214-8SSPY MIC	S5201	N6090061	SSJ-012M
METER			CONNECTOR		
M1	M0290023	T-22	P5201(w/wire)	T9205394A	
			P5202(w/wire)	T9205395	
SPEAKER			FERRITE BEADS		
SP1	M4090067	TL-57A		L9190001	4A RI3x3x1
	R3803451	PANEL			
	R7115680	WINDOW			
	R3115710	KNOB (FUNCTION)			
	R3115711	" RPT			
	R3115712	" VFO			
	R3115713	" STEP			
	R3115714	" MR			
	R3115715	" REV			
	R3115716	" UP			
	R3115717	" MODE			
	R3115718	" CALL			
	R3115719	" M			
	R3507740	" MAIN DIAL			
	R3115910	" VOL			
	R3115920	" SQL			
	R3115930	" CLAR			
	R0507650	TOP CASE			
	R0507660	BOTTOM CASE			
	R0507670A	SIDE PLATE L			
	R0507680A	SIDE PLATE R			
TERMINAL UNIT A			CPU UNIT		
Symbol No.	Part No.	Description	Symbol No.	Part No.	Description
	F2826000	Printed Circuit Board		F2820000	Printed Circuit Board
	C028260AA	PCB with Components		C028200AA	PCB with Components Model A1
				C028200AB	" " " Model A2
				C028200AC	" " " Model B
				C028200AD	" " " Model C1
				C028200AE	" " " Model C2
				C028200AF	" " " Model D
				C028200AG	" " " Model E1
				C028200AH	" " " Model E2
				C028200AJ	" " " Model E3
				C028200AK	" " " Model G
				C028200AL	" " " Model F
			ICs		
			Q1001	G1090734	HD61391A41 (LCD-IV)
			Q1002, 1003	G1090735	μPD4042BG
			Q1004	G1090584	μPD4069UBG
TRANSISTORS			DIODES		
			Q1005	G3316237F	2SC1623T2BL6
			Q1006	G3108127F	2SA812T2BM6B
CONNECTOR			DIODES		
P5001(w/wire)	T9205398		D1001	G2090070	LN222RP LED (RED)
			D1002	G2090071	LN322GP " (GREEN)

			CONTROL UNIT		
D1003	G2070001	1SS181TE85R Si	Symbol No.	Part No.	Description
				F2821000A	Printed Circuit Board
				C028210AA	PCB with Components w/o BAT2001
RESISTORS					
R1001, 1021	J24205000	RMC 1/10T 000J 1/10W 0Ω			
R1004, 1015	J24205221	" " 221J " 220Ω			
R1005, 1012, 1013, 1014	J24205102	" " 102J " 1kΩ			
R1017	J24205103	" " 103J " 10kΩ	Q2001	G1090584	μPD4069UBG
R1007, 1008, 1016, 1018, 1019	J24205473	" " 473J " 47kΩ	Q2002	G1090679	μPD4081BG
R1003	J24205683	" " 683J " 68kΩ	Q2003	G1090675	μPD4071BG
R1002, 1009-1011	J24205104	" " 104J " 100kΩ	Q2004	G1090037	MC14572UBCP
R1006	J21249001	Metallic Film 1/4W 432kΩ	Q2005	G1090714	μPD4030BG
			Q2006	G1090736	LVC550C
ICs					
TRANSISTORS					
			Q2007	G3410330K	2SD1033K
			Q2008-2011, 2013, 2017, 2018, 2020-2022, 2024, 2025	G3316237F	2SC1623T2BL6
			Q2012, 2014 -2016, 2023	G3108127F	2SA812T2BM6B
			Q2019	G3207987L	2SB798DL
DIODES					
			D2001, 2002	G2090118	1SS97 Schottky
			D2003, 2005, 2006, 2008	G2070003	1SS226TE85R Si
			D2004	G2090246	RD6.2EB2 Zener
			D2007	G2070009	1SS184TE85R Si
			D2009	G2070001	1SS181TE85R "
			D2010	G2090027	1SS53 "
RESISTORS					
			R2004, 2055	J24205000	RMC 1/10T 000J 1/10W 0Ω
			R2002	J24205479	" " 4R7J " 4.7Ω
			R2008	J24205470	" " 470J " 47Ω
			R2001	J24205101	" " 101J " 100Ω
			R2057	J24205331	" " 331J " 330Ω
			R2041	J24205102	" " 102J " 1kΩ
			R2007, 2030, 2040, 2044, 2047	J24205332	" " 332J " 3.3kΩ
			R2003, 2005	J24205472	" " 472J " 4.7kΩ
			R2045	J24205562	" " 562J " 5.6kΩ
			R2012	J24205682	" " 682J " 6.8kΩ
			R2006, 2021, 2028, 2038, 2046	J24205103	" " 103J " 10kΩ
			R2026	J24205153	" " 153J " 15kΩ
			R2011	J24205223	" " 223J " 22kΩ
			R2029, 2035, 2039, 2058	J24205333	" " 333J " 33kΩ
SWITCHES					
S1001	Q9000361	SRGFVV			
S1002	N6090061	SSJ-012M			
CONNECTORS					
J1001	P0090099	3022-10A			
J1002	P0090113	3022-05A			
LAMPS					
PL1001, 1002	Q1000061	HRS-3060A 8V 50mA			
LIQUID CRYSTAL DISPLAY					
DS1001	G6090053	LS149-A			

R2017, 2019, 2022-2024, 2027, 2032, 2034, 2050, 2053, 2054, 2056	J24205473	RMC 1/10T 473J 1/10W 47kΩ	I2007, 2008	P0090595	5418-12A
SWITCH					
	S2001	N4090094	SPH222A		
R2010, 2013, 2015, 2016, 2025, 2036 2043, 2048, 2049	J24205104	" " 104J " 100kΩ	BATTERY		
	BAT2001	Q9000106	CR2055-WTZ		
R2009, 2042	J24205334	" " 334J " 330kΩ	SW UNIT		
R2037	J24205474	" " 474J " 470kΩ			
R2014, 2018, 2033	J24205105	" " 105J " 1MΩ			
R2051, 2052	J24205225	" " 225J " 2.2MΩ			
R2020, 2031	J24205335	" " 335J " 3.3MΩ			
SW UNIT					
			Symbol No.	Part No.	Description
				F2822101	Printed Circuit Board
				C028221AA	PCB with Components Model A1
				C028221AB	" " " Model A2
				C028221AC	" " " Model B
				C028221AD	" " " Model C1
				C028221AE	" " " Model C2
				C028221AF	" " " Model D
				C028221AG	" " " Model E1
				C028221AH	" " " Model E2
				C028221AJ	" " " Model E3
				C028221AK	" " " Model G
				C028221AL	" " " Model F
CAPACITORS					
C2008	K22170237	Chip Ceramic 50WV CH 120pF (C2012CH1H121JFA)			
C2005, 2023, 2027, 2028	K22170805	" " " B 0.001μF (C2012B1H102MFA)			
C2014	K22170809	" " " " 0.0022μF (C2012B1H222MFA)			
C2021	K22170817	" " " " 0.01μF (C2012B1H103MFA)			
C2002, 2011	K22171004	" " " F 0.01μF (C2012F1H103ZFA)			
C2013, 2019, 2020, 2022	K22170821	" " " B 0.022μF (CM21W5R223M50VAT)	TRANSISTORS		
C2003, 2007, 2012, 2015- 2018, 2025	K22171008	" " " F 0.047μF (C2012F1H473ZFA)	Q2501	G3108127F	2SA812T2BM6
DIODES					
C2026	K22141904	" " 25WV D 0.1μF (C3216D1E104MFA)	D2501	G2070001	1SS181TE85R Si Models A1, A2, B, C1, C2, D, E1, E2, E3, G, F
C2004	K70107226	Tantalum 10WV 22μF (DN1A220M1S)	D2503	G2070001	1SS181TE85R Si Models A1, A2, B, C1, C2, D, E1, E2
C2009	K40179001	Electrolytic 50WV 1μF (RC2-50V010M)	D2502, 2504-2507	G2070001	1SS181TE85R Si
C2006, 2024	K40149012	" 25WV 10μF (RC2-25V100M)	RESISTORS		
C2010, 2029	K40129012	" 16WV 10μF (RC2-16V100M)	R2501	J24205472	RMC 1/10T 474J 1/10W 470kΩ
FUSE CLIP					
FH2001	P2000024	UF-0033#01	R2502*, 2503*	J24205000	" " 000J " 0Ω
FUSE					
F2001	Q0000020	MF-51 1A	SWITCHES		
			S2501-2510	N5090029	JPM1990-0101
CONNECTORS					
			CONNECTORS		
J2001	P1090304	3024-05CH	P2502 (w/wire)	T9205393A	
J2002	P1090126	3024-10CH	P2503 (")	T9205388B	Model F
J2003, 2004, 2009	P0090524	5483-02A			
J2005, 2006	P0090486	PI22A03M			

- Model B, D, F3, G
- Model A1, C1, E1

MAIN UNIT				D3013, 3014, 3022, 3024	G2090244	1SS106	Schottky
Symbol No.	Part No.	Description					
	F2823000	Printed Circuit Board		D3016	G2090180	FC-53M-5	Varactor
	C028230AA	PCB with Components Model A1		D3017	G9090017	MV-11 (KB262)	Varistor
	C028230AB	" "	Model A2	D3023	G2090118	1SS97	Schottky
	C028230AC	" "	Model B				
	C028230AD	" "	Model C1				
	C028230AE	" "	Model C2				
	C028230AF	" "	Model D				
	C028230AG	" "	Model E1				
	C028230AH	" "	Model E2				
	C028230AJ	" "	Model E3				
	C028230AK	" "	Model G				
	C028230AL	" "	Model F				
ICs							
Q3004	G1090072	μPC577H					
Q3023	G1090559	LA6324M					
Q3045	G1090101	μPC1037H					
FETs							
Q3001, 3006, 3008, 3009, 3011-3013, 3028, 3029	G4801220L	3SK122L		R3016, 3017, 3120, 3147, 3185	J24205000	RMC 1/10T 000J 1/10W 0Ω	
				R3156	J24205689	" " 6R8J " 6.8Ω	
				R3113, 3155	J24205100	" " 100J " 10Ω	
				R3152, 3194 3196	J24205150	" " 150J " 15Ω	
				R3027, 3168, 3170, 3213	J24205220	" " 220J " 22Ω	
Q3002	G4800740L	3SK74L		R3171, 3192	J24205330	" " 330J " 33Ω	
				R3007, 3021, 3031, 3032, 3040, 3045, 3065, 3071, 3078, 3144, 3150, 3190, 3208	J24205470	" " 470J " 47Ω	
TRANSISTORS							
Q3003, 3005, 3007, 3010, 3014, 3016, 3019-3022, 3024, 3025, 3027, 3033, 3035, 3039-3044	G3316237F	2SC1623T2BL6		R3022	J01215470	Carbon Film TJ 1/8W 47Ω	
				R3187	J24205680	RMC 1/10T 680J 1/10W 68Ω	
				R3001, 3002, 3030, 3053, 3057, 3062 3068, 3149 3205, 3211	J24205101	" " 101J " 100Ω	
Q3015, 3017, 3018, 3034, 3038	G3108127F	2SA812T2BM6B		R3079	J01215101	Carbon Film TJ 1/8W 100Ω	
Q3026	G3326207B	2SC2620QBTR		R3070, 3195	J24205151	RMC 1/10T 151J 1/10W 150Ω	
Q3031	G3330527F	2SC3052-T14-2F					
Q3032, 3036	G3320260	2SC2026		R3039, 3044, 3130, 3133	J24205221	" " 221J " 220Ω	
Q3037	G3333550	2SC3355		R3173	J20306221	Metallic Film 1W 220Ω	
				R3006, 3083, 3134, 3153, 3154, 3157	J24205331	RMC 1/10T 331J 1/10W 330Ω	
DIODES							
Q3030	G2090247	ND487C1-3R	Schottky	R3166	J24205391	" " 391J " 390Ω	
D3001-3003, 3009, 3025, 3028, 3030, 3032, 3033	G2090027	1SS53	Si	R3019, 3056, 3129, 3143	J24205471	" " 471J " 470Ω	
D3004-3007, 3018-3021	G2022090	1S2209	Varactor	R3063, 3069, 3076, 3172	J24205681	" " 681J " 680Ω	
D3008, 3015	G2070003	1SS226TE85R	Si	R3003, 3043, 3061, 3066, 3086, 3095, 3104, 3178, 3180, 3207	J24205102	" " 102J " 1kΩ	
D3010, 3011	G2070009	1SS184TE85R	"				
D3012, 3031	G2070001	1SS181TE85R	"				

R3072, 3203, 3219 [■]	J01215102	Carbon Film	TJ	1/8W	1k Ω	R3004, 3011, 3085, 3160	J01215104	Carbon Film	TJ	1/8W	100k Ω		
R3029, 3035, 3038, 3058, 3059	J24205152	RMC	1/10T	152J	1/10W	1.5k Ω	R3126, 3177	J24205184	RMC	1/10T	184J	1/10W	180k Ω
R3008, 3042, 3047, 3055, 3121, 3167, 3188	J24205222	"	"	222J	"	2.2k Ω	R3049, 3137	J01215224	Carbon Film	TJ	1/8W	220k Ω	
R3023, 3097	J24205272	"	"	272J	"	2.7k Ω	R3075, 3093, 3123, 3146	J24205334	RMC	1/10T	334J	1/10W	330k Ω
R3067	J01215332	Carbon Film	TJ	1/8W	3.3k Ω	R3074, 3089, 3106, 3118	J24205474	"	"	474J	"	470k Ω	
R3034, 3052, 3054, 3073, 3077, 3151, 3206, 3212	J24205332	RMC	1/10T	332J	1/10W	3.3k Ω	R3082, 3109, 3117, 3136, 3181	J24205105	"	"	105J	"	1M Ω
R3050, 3102, 3107, 3110, 3131, 3132, 3174, 3186, 3197, 1199, 3201, 3218	J24205472	"	"	472J	"	4.7k Ω	R3220	J24205275	"	"	275J	"	2.7M Ω
R3025, 3046, 3148	J24205682	"	"	682J	"	6.8k Ω	R3005, 3103, 3139, 3184	J24205335	"	"	335J	"	3.3M Ω
R3096	J01215682	Carbon Film	TJ	1/8W	6.8k Ω	POTENTIOMETERS							
R3088, 3091, 3122, 3127, 3140, 3158, 3198, 3200, 3202, 3204, 3214	J24205103	RMC	1/10T	103J	1/10W	10k Ω	VR3001	J51745221	H0651A003-220B	220 Ω B			
R3026, 3182	J01215103	Carbon Film	TJ	1/8W	10k Ω								
R3024, 3084, 3108, 3114, 3128, 3176, 3189	J24205153	RMC	1/10T	153J	1/10W	15k Ω	VR3002	J51762225	H0521A127A-2.2MB	2.2M Ω B			
R3036, 3100, 3115, 3116, 3124, 3179, 321 ^f	J24205223	"	"	223J	"	22k Ω	VR3003	J51762103	H0521A113A-10KB	10k Ω B			
R3018, 3037, 3081, 3098, 3175, 3183, 3209	J24205333	"	"	333J	"	33k Ω	VR3004	J51762102	H0521A107A-1KB	1k Ω B			
R3101	J01215333	Carbon Film	TJ	1/8W	33k Ω								
R3080, 3094, 3099, 3111, 3193, 3215	J24205473	RMC	1/10T	473J	1/10W	47k Ω	VR3005, 3007	J51745473	H0651A017-47KB	47k Ω B			
R3033, 3092, 3112, 3141	J24205683	"	"	683J	"	68k Ω	VR3006	J51745103	H0651A013-10KB	10k Ω B			
R3009, 3010, 3012-3015, 3020, 3041, 3048, 3051, 3060, 3087, 3090, 3125, 3138, 3142, 3159, 3161-3165, 3110, 3221, 3222	J24205104	"	"	104J	"	100k Ω	THERMISTORS						
								TH3001	G9090022	SDT-09			
								TH3002	G9090002	D22A			
CAPACITORS													
								C3162	K22170201	Chip Ceramic	50WV	CH	0.5pF
								C3031, 3143, 3147, 3149, 3153	K22170202	"	"	"	1pF
								C3009, 3023, 3027, 3193	K22170203	"	"	"	2pF
								C3176	K22170205	"	"	"	4pF
								C3024, 3035	K22170206	"	"	"	5pF
								C3141, 3145, 3151, 3156	K22170207	"	"	"	6pF
								C3040, 3194, 3206	K22170309	"	"	"	8pF
								C3005, 3030, 3130, 3222	K22170211	"	"	"	10pF
								C3022, 3026, 3032	K22170311	"	"	"	10pF
								C3065, 3142, 3146, 3150, 3154, 3178, 3186	K22170313	"	"	"	12pF
								C3148, 3161, 3204	K22170215	"	"	"	15pF

■ Model E3, F, G

L3006	L1190258	C3A 100K	10 μ H	ICs		
L3007	L1190256	C3A-6R8K	6.8 μ H	Q4001	G1090145	MC3357P
L3008, 3009	L1190252	C3A-3R3K	3.3 μ H	Q4002	G1090626	LA6358M
L3011	L0020725			Q4007	G1090602	(μ PD4066BG) LC4066BM
L3013	L0020724			Q4008	G1090559	LA6324M
L3014	L1190275	LAL02NAR22M	0.22 μ H	Q4009	G1090073	μ PC575C2
				Q4019	G1090550	MC145145P1
FERRITE BEADS						
	L9190001	4A RI3x3x1		FETs		
				Q4013	G3801921G	2SK192AGR
				Q4014, 4015	G3803027Y	2SK302Y TE85R
TRANSFORMERS						
T3001	L0190128	MC119		TRANSISTORS		
T3002, 3003, 3005, 3018-3021	L0021665		145MHz	Q4003, 4004, 4012	G3108127F	2SA812T2BM6B
T3006	L0021670		145MHz	Q4005, 4006, 4010 [•] , 4020-4022	G3316237F	2SC1623T2BL6
T3007, 3010-3012, 3014, 3015	L0021667		13.9MHz	Q4011, 4016-4018	G3326207B	2SC2620QBTR
T3008, 3009	L0021666		13.9MHz			
T3013	L0021672		13.9MHz			
T3016, 3017	L0190007	FKMA070 PB01-BR		DIODES		
T3022	L0021669			D4001, 4002, 4009	G2015550	1S1555 Si
				D4003, 4004, 4008	G2070009	1SS184TE85R "
PJ3001-3003	P1090210	TMP-JV		D4005, 4011	G2090248	1T32 Varactor
J3001, 3004, 3006, 3009	P0090486	PI22A03M		D4006, 4007	G2090271	1T33 "
J3002	P1090539	JPJ-1000-01-010		D4010	G2090181	HZ7B1L Zener
J3003	P1090542	5410-12A PB				
J3005, 3007	P0090485	PI22A02M				
J3008	P0090090	3022-09A		CRYSTALS		
P5001 (w/wire)	T9316503			X4001	H0102708	HC-18/T 3P 13.5335MHz
				X4002 [•]	H0102710	HC-18/T 3P 122.0315MHz
				X4002 [■]	H0102711	HC-18/T 3P 126.7215MHz
				X4003	H0102707	HC-18/T 3P 13.53MHz
CERAMIC FILTER						
				CF4001	H3900200	CFW455F
PLL/PA UNIT (PLL)						
Symbol No.	Part No.	Description				
	F2824000A	Printed Circuit Board				
	C028240AA	PCB with Components	Model A1	CERAMIC DISCRIMINATOR		
	C028240AB	" " "	Model A2	CD4001	H7900180	CDB455C7
	C028240AC	" " "	Model B			
	C028240AD	" " "	Model C1			
	C028240AE	" " "	Model C2	RESISTORS		
	C028240AF	" " "	Model D	R4017, 4039, 4040	J24205000	RMC 1/10T 000J 1/10W 0 Ω
	C028240AG	" " "	Model E1	R4053	J01215689	Carbon Film TJ 1/2W 6.8 Ω
	C028240AH	" " "	Model E2	R4092, 4094, 4111	J24205470	RMC 1/10T 470J 1/10W 47 Ω
	C028240AJ	" " "	Model E3	R4012, 4028, 4041, 4054, 4057, 4075, 4079, 4085, 4089, 4090,	J24205101	" " 101J " 100 Ω
	C028240AK	" " "	Model G			
	C028240AL	" " "	Model F			

- Model A1, A2, B, C1, C2, D, E1, E2
- Model E3, F, G

R4098, 4102, 4108, 4114	J24205101	RMC 1/10T 101J 1/10W 100Ω	VR4004	J51762472	H0521A111A-4.7KB 4.7kΩB
R4048	J24205151	" " 151J " 150Ω			
R4078	J24205221	" " 221J " 220Ω			CAPACITORS
R4096, 4103, 4105	J24205331	" " 331J " 330Ω	C4085, 4090	K22170202	Chip Ceramic 50WV CH 1pF (C2012CH1H010CFA)
R4013, 4034, 4080, 4083	J24205471	" " 471J " 470Ω	C4078, 4110*	K22170203	" " " " 2pF (C2012CH1H020CFA)
R4004, 4074	J24205681	" " 681J " 680Ω	C4074, 4082, 4089	K22170204	" " " " 3pF (C2012CH1H030CFA)
R4002, 4023, 4052, 4101, 4109	J24205102	" " 102J " 1kΩ	C4061	K22170205	" " " " 4pF (C2012CH1H040CFA)
R4007, 4010, 4011, 4033	J24205152	" " 152J " 1.5kΩ	C4057	K22170206	" " " " 5pF (C2012CH1H050CFA)
R4035, 4068	J24205332	" " 332J " 3.3kΩ	C4054, 4059, 4062	K22170207	" " " " 6pF (C2012CH1H060DFA)
R4001, 4029, 4030, 4059, 4060, 4076, 4081, 4082, 4084, 4110	J24205472	" " 472J " 4.7kΩ	C4073	K22170208	" " " " 7pF (C2012CH1H070DFA)
R4032	J24205682	" " 682J " 6.8kΩ	C4072 [▲] , 4075, 4086	K22170211	" " " " 10pF (C2012CH1H100DFA)
R4019, 4020, 4024, 4042, 4066, 4067, 4070, 4112, 4113, 4117, 4118, 4122	J24205103	" " 103J " 10kΩ	C4051	K22170313	" " " " UJ 12pF (C2012UJ1H120JFA)
R4005, 4061, 4099, 4100, 4106	J24205153	" " 153J " 15kΩ	C4072*	K22170215	" " " " CH 15pF (C2012CH1H150JFA)
R4014-4016, 4025, 4031, 4037, 4063, 4072, 4077, 4107	J24205223	" " 223J " 22kΩ	C4070	K22170217	" " " " 18pF (C2012CH1H180JFA)
R4036, 4055, 4064, 4069, 4071	J24205333	" " 333J " 33kΩ	C4119	K22170219	" " " " 22pF (C2012CH1H220JFA)
R4008, 4009, 4021, 4049, 4073, 4115	J24205473	" " 473J " 47kΩ	C4095	K22170221	" " " " 27pF (C2012CH1H270JFA)
R4058	J24205563	" " 563J " 56kΩ	C4009, 4032	K22170323	" " " " UJ 33pF (C2012UJ1H330JFA)
R4027, 4065	J24205683	" " 683J " 68kΩ	C4104	K22170225	" " " " CH 39pF (C2012CH1H390JFA)
R4018, 4022, 4026, 4038, 4043, 4044, 4062, 4091, 4095, 4116, 4119	J24205104	" " 104J " 100kΩ	C4096	K22170227	" " " " 47pF (C2012CH1H470JFA)
R4006, 4050, 4051	J24205154	" " 154J " 150kΩ	C4105	K22170229	" " " " 56pF (C2012CH1H560JFA)
R4056	J24205224	" " 224J " 220kΩ	C4116 [▲]	K22170235	" " " " 100pF (C2012CH1H101JFA)
R4003, 4045-4047	J24205334	" " 334J " 330kΩ	C2052, 2053	K22170335	" " " " UJ 100pF (C2012UJ1H101J [▲] FA)
R4088	J24205474	" " 474J " 470kΩ	C4010	K22170237	" " " " 120pF (C2012CH1H121JFA)
R4086, 4087	J24205335	" " 335J " 3.3MΩ	C4012	K22170239	" " " " CH 120pF (C2012CH1H151JFA)
		POTENTIOMETERS	C4030	K22170243	" " " " 220pF (C2012CH1H221JFA)
VR4001, 4002, 4003	J51745333	H0651A016-33KB 33kΩB	C4031, 4044	K22170802	" " " " B 560pF (C2012B1H561MFA)
			C4005, 4006, 4039, 4041, 4058, 4060, 4076, 4080, 4081, 4084, 4087, 4088, 4092, 4112, 4113	K22170805	" " " " 0.001μF (C2012B1H102MFA)
			C4068	K22170809	" " " " 0.0022μF (C2012B1H222MFA)
			C4066	K22170817	" " " " 0.01μF (C2012B1H103MFA)
			C4120 [▲]	K13179008	Ceramic Disc " F 0.01μF (DD106F103Z50)

- Model A1, A2, B, C1, C2, D, E1, E2
- ▲ Model E3, F, G

C4001, 4008, 4038, 4049, 4050, 4055, 4063, 4065, 4083, 4093, 4094, 4098- 4101, 4103, 4107, 4111	K22171004	Chip Ceramic 50WV F 0.01 μ F (C2012F1H103ZF A)	CONNECTORS		
			J4001	P1090251	3024-09CH
			J4002, 4006	P1090370	HSJ0836-01-010
			J4003, 4005	P0090486	PI22A03M
			J4004	P1090542	S410-12APB
			J4007	P0090496	PI22A13M
C4027, 4114	K19149013	Semiconductor Ceramic 25WV 0.01 μ F (UAT05X103K-L05AE)	PJ4001	P1090210	TMP-JV
				R0115290	Shield Case
				R0115300	Shield Case Top
C4020-4022	K22170821	Chip Ceramic 50WV B 0.022 μ F (CM21W5R223M50VAT)		R0507690A	Shield Case
C4011, 4013, 4018, 4019, 4047, 4048, 4106	K22171008	" " " F 0.047 μ F (C2012F1H473ZF A)	PLL/PA (PA) UNIT		
			Symbol No.	Part No.	Description
C4004, 4007, 4014, 4026, 4037, 4040	K22141904	" " 25WV D 0.1 μ F (C3216D1E104MF A)	TRANSISTORS		
			C4067	K70127225	Tantalum 16WV 2.2 μ F (DN1C2R2M1S)
C4002, 4028	K40179010	Electrolytic 50WV 0.47 μ F (RE-50VR47M)	Q4701	G3333550	2SC3355
C4003, 4025	K40179013	" " " 1 μ F (RE-50V010M)	Q4702	G3325380	2SC2538
			C4002, 4028	K40179010	Electrolytic 50WV 0.47 μ F (RE-50VR47M)
C4042	K40149001	" 25WV 4.7 μ F (RE-25V4R7M)	DIODES		
			D4701, 4702	G2015550	1S1555
C4016, 4017, 4023, 4024, 4029, 4033, 4045, 4046	K40129004	" 16WV 10 μ F (RE-16V100M)	RESISTORS		
			R4705	J24205100	RMC 1/10T 100J 1/10W 10 Ω
C4064	K40129012	" 16WV 10 μ F (RC2-16V100M)	R4707	J02245100	Carbon Film SJ 1/4W 10 Ω
			R4713	J02245470	" " " " 47 Ω
C4034,	K40129002	" " 4 μ F (RE-16V470M)	R4709	J24205680	RMC 1/10T 680J 1/10W 68 Ω
			R4712	J00275181	Carbon Film VJ 1/2W 180 Ω
C4015	K40129054	" " 47 μ F (RE2-16V470M)	R4702	J24205221	RMC 1/10T 221J 1/10W 220 Ω
			R4704	J24205331	" " 331J " 330 Ω
C4073	K40129007	" " 100 μ F (RE-16V101M)	R4708	J01245561	Carbon Film TJ 1/4W 560 Ω
			R4703	J01245152	" " " " 1.5k Ω
C4036	K40129049	" " 470 μ F (RE2-16V471M)	POTENTIOMETER		
			VR4701	J51762221	H0521A103A-220 220 Ω B
C4035	K40129046	" " 1000 μ F (RE2-16V102M)	CAPACITORS		
			C4710	K22170211	Chip Ceramic 50WV CH 10pF (C2012CH1H100DFA)
TC4001	K91000148	VCT31A157A 6pF	C4704	K22170215	" " " " 15pF (C2012CH1H150JFA)
TC4002	K91000149	VCT31E161A 20pF	C4723	K22170225	" " " " 39pF (C2012CH1H390JFA)
INDUCTORS					
L4001, 4002	L1190005	FL4H1R0M 1 μ H	C4701, 4702, 4705, 4707, 4712, 4718, 4720, 4725, 4731	K22170805	" " " B 0.001 μ F (C2012B1H102MF A)
L4003	L0190129	MC122 4.5T			
L4004	L1190004	FL4HR68M 0.68 μ H			
L4005, 4006	L1190250	L-C3A 2R2MA 2.2 μ H			
L4007	L1190258	L-C3A 100KA 10 μ H			
L4008	L1190287	LAL02NA2R2M 2.2 μ H			
TRANSFORMERS					
T4001 [•]	L0021644		C4714, 4716, 4719	K22141904	" " 25WV D 0.1 μ F (C3216D1E104MF A)
T4001 [▲]	L0021645	2.45 μ H	C4726	K22171004	" " 50WV F 0.01 μ F (C2012F1H103MF A)
T4002-4006	L0021646	2.33 μ H			
		132MHz			

			FL-2020, 2025		
C4732	K13179008	Ceramic Disc 50WV F 0.01μF (DD106F103Z50)			
C4727, 4728	K21170002	Feed Thru 50WV (ECK-Y2H102WE)			
C4706, 4708, 4713, 4717, 4721	K40129004	Electrolytic 16WV 10μF (RE-16V100M)			
C4736	K40129046	" " 1000μF (RE2-16V102M)			
TRIMMER CAPACITORS					
TC4701, 4703	K91000028	ECV-1ZW10x53 10pF			
TC4702, 4704	K91000029	ECV-1ZW20x53 20pF			
INDUCTORS					
L4701, 4710	L0020725				
L4702, 4705, 4711, 4712	L1020683				
L4704, 4708, 4709	L0021155				
L4706	L0020427				
L4707	L0021660				
FERRITE BEADS					
	L9190001	4A R13x3x1			
ACCESSORIES					
Symbol No.	Part No.	Description	Symbol No.	Part No.	Description
ANTENNA *			CONNECTORS		
	Q3000037	YHA-14A	J6201	P0090597A	
MICROPHONE *			J6202	P1090352	FM-MDR-M1 Antenna
	M3090052	MH-10E8		R4803630A	HEAT SINK
	M3090060	MH-15C8 w/DTMF		S5000028	CATCH CLIP
	M3090053	MH-10F8 w/SPKR	POWER MODULES		
	S6000094	Shoulder Belt *	Q6201 (25W)	G1090474	M57727
PLUG			Q6201 (10W)	G1090295	M57713
	P1090140	DP55-01-1A EXT DC	POWER AMP UNIT		
	P0090034	C-107 EXT SP	Symbol No.	Part No.	Description
Battery Case *				F2847000A	Printed Circuit Board
	FBA-8			C028470	PCB with Component w/o Q6201
* Some models are optional			TRANSISTORS		
			Q6202	G3408820Q	2SD882Q
			Q6203	G3107331P	2SA733AP
			Q6204	G3309451P	2SC945AP
			DIODES		
			D6201	G2090232	S11B Si
			D6202	G2090306	10E1 "
			D6203, 6205	G2090027	1SS53 "
			D6204	G2090197	RD9.1EB3 Zener
			D6206	G2090118	1SS97 Schottky
			D6207(25W), 6208(25W)	G2090017	MI402 PIN
			D6207(10W), 6208(10W)	G2090337	MI308 "
			RESISTORS		
			R6201 (25W)	J22355101	ERG-3SJ101 3W 100Ω
			R6201 (10W)	J22355680	ERG-3SJ680 " 68Ω
			R6202 (25W)	J20336680	RS2B2WK68 2W 68Ω
			R6202 (10W)	J20336151	RS2B2WK150 " 150Ω
			R6203 (25W)	J01245101	RD14TJ101 1/4W 100Ω
			R6203 (10W)	J01245680	RD14TJ680 " 68Ω
			R6204, 6210	J02245102	RD14SJ102 " 1kΩ
			R6205 (25W)	J30379001	ERF5AKR05 5W 0.05Ω
			R6205 (10W)	J30356019	ERF3AK0R1 3W 0.1Ω
			R6206, 6216	J02245472	RD14SJ472 1/4W 4.7kΩ
			R6207 (25W)	J02245683	RD14SJ683 " 68kΩ
			R6207 (10W)	J02245563	RD14SJ563 " 56kΩ
			R6208, 6211	J02245473	RD14SJ473 " 47kΩ
			R6209, 6215	J02245103	RD14SJ103 " 10kΩ
			R6212	J20306331	RS1B1WK330 1W 330Ω
			R6213 (25W)	J01215100	RD18TJ100 1/8W 10Ω

• Model A1, A2, B, C1, C2, D, E1, E2

				ACCESSORIES		
				Symbol No.	Part No.	Description
R6213 (10W)	J01215220	RD18TJ220	1/8W 22Ω			
POTENTIOMETERS						
VR6201	J50747331	P6-S2X330	330ΩB		T9015610	(25W)
VR6202	J51745474	H0651A023-470KB	470kΩB		T9015405	(10W)
CAPACITORS						
C6202 (25W)	K00172010	Ceramic Disc 50WV SL 1pF (DD104SL010C50)			Q0000007	10A (25W)
C6202 (10W)	K00173060	" " " " 6pF (DD104SL060D50)			Q0000005	5A (10W)
C6203 (25W)	K00172030	" " " " 3pF (DD104SL030C50)			MOBILE MOUNTING BRACKET	
C6203 (10W)	K00173060	" " " " 6pF (DD104SL060D50)			D6000046	MMB-31
C6230 (25W)	K00175180	" " " " 18pF (DD104SL180J50)		FTS-7 TONE ENCODER/DECODER (D3000321)		
C6230 (10W)	K00175150	" " " " 15pF (DD104SL150J50)		Symbol No.	Part No.	Description
C6204, 6208	K00172010	" " " " 1pF (DD104SL010C50)			F2578101A	Printed Circuit Board
C6215, 6216, 6231	K00175150	" " " " 15pF (DD104SL150J50)		IC		
C6211, 6213	K00175270	" " " " 27pF (DD104SL270J50)		Q1001	G1090577	MN6520
C6229	K00175330	" " " " 33pF (DD104SL330J50)		DIODES		
C6212	K00175470	" " " " 47pF (DD104SL470J50)		D1001, 1002	G2090244	Schottky Barrier 1SS106
C6225	K00175101	" " " " 100pF (DD105SL101J50)		CRYSTAL		
C6201, 6205, 6207, 6209, 6214, 6217, 6218, 6223, 6224, 6226, 6232	K12171102	" " " " E 0.001μF (DD104E102P50)		X1001	H0102571	MS-309 4.194304MHz
C6222	K13179008	" " " " F 0.01μF (DD106F103Z50)		RESISTORS		
C6219, 6221	K13179010	" " " " 0.022μF (DD108F223Z50)		R1009, 1010	J24205102	Chip RMC 1/10T 102J 1kΩ
C6206, 6208, 6210, 6220	K40179014	Electrolytic 50WV 10μF (RE-50V100M)		R1002	J24205222	" " " 222J 2.2kΩ
C6233	K40129046	" " 16WV 1000μF (RE2-16V102M)		R1006	J24205472	" " " 472J 4.7kΩ
INDUCTORS				R1003,1007,1008	J24205103	" " " 103J 10kΩ
L6201	L1020673			R1004,1005	J24205123	" " " 123J 12kΩ
L6202	L1020663			R1001	J24205104	" " " 104J 100kΩ
L6203, 6204, 6206	L0020679			POTENTIOMETER		
L6205	L1190248	L-C3A1R5MA		VR1001	J51750473	H0423A047-47KB 47kΩB
L6207	L0021677			CAPACITOR		
L6208	L0021676			C1008, 1009	K22170217	Chip Ceramic 50WV 18pF CH (C2012CH1H180JFA)
RELAY				C1005	K22171004	" " " 0.01μF F (C2012F1H103ZFA)
RL6201	M1190045	AG2013		C1002, 1004	K22141904	" " " 25WV 0.1μF D (C3216D1E104MFA)
CONNECTOR				C1003	K72080002	Chip Tantalum 6.3WV 4.7μF (F950J475MA1)
SWITCH				C1001, 1006	K72080003	" " " 10μF (F950J106MC1)
RELAY				C1007	K72060007	" " " 4WV 100μF (F950G107MH1)
CONNECTOR				S1001	N7090030	SGK1072
RELAY				CONNECTOR		
RELAY				J1001	P0090373	5703-06CPB



MANUALE DI SERV. X
FT-290R II
05910740



E2230900(006E-BT)