

YAESU

FT-2400H

*2-m, 50-Watt Mobile
Paging Transceiver*



Specifications

General

- Frequency Range: 144 ~ 146 or 148 MHz, or
140 ~ 150 MHz Tx, 140 ~ 174 MHz Rx
- Channel Steps: 5, 10, 12.5, 15, 20, 25 & 50 kHz
- Frequency Stability: < 10 ppm (-20 to +60 °C)
- Mode of Emission: F3
- Antenna Impedance: 50 ohms, unbalanced
- Supply voltage: 13.8V DC \pm 10%, negative ground
- Current Consumption (typical):
Rx: 400 mA, Tx hi/med/low: 12/9/5A
- Operating Temperature Range: -20 to +60 °C
- Case Size (WHD):
160 x 50 x 180 mm (w/o knobs)
- Weight: 1.5 kg (3.3 lb)

Transmitter

- Output Power (high/med/low): 50/25/5W
- Modulation Type: Variable Reactance
- Maximum Deviation: \pm 5 kHz
- Spurious Radiation: less than -60 dB
- Microphone Impedance: 2k Ω

Receiver

- Circuit Type:
Double Conversion Superheterodyne
- IFs: 21.4 MHz & 455 kHz
- Sensitivity (for 12dB SINAD):
better than 0.2 μ V
- Selectivity (-6/-60 dB): 12/30 kHz
- IF Rejection: better than 70 dB
- Image Rejection: better than 70 dB
- Maximum AF Output:
2W into 8 ohms @10% THD

Specifications subject to change without notice or obligation.

Accessories

- | | |
|---------------------------|----------------|
| FTS-17A CTCSS Unit | p/n- A03700002 |
| FRC-6 DTMF Pager Unit | A03740001 |
| MH-26G8J Hand Mic w/Burst | A04290001 |
| MH-27A8J DTMF Keypad Mic | A04270001 |
| SP-7 External Loudspeaker | A03590001 |

Controls & Connectors

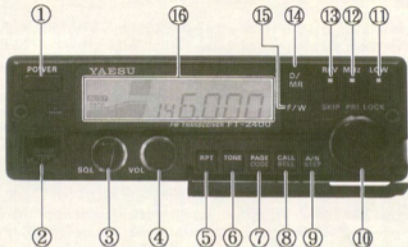

(1) POWER Button

Press this button to turn on the transceiver. Press and hold it for $\frac{1}{2}$ -second to turn it off.

(2) Microphone Jack

This 8-contact modular jack accepts transmit audio, tone call (burst) or dial/memory selection and scanning control from the microphone, and provides receiver audio for a speaker/mic. Memories can be copied to and from another FT-2400H through this jack, and a packet tnc can be connected.

(3) SQL Control

This control sets the threshold level at which a received signal (or noise) opens the squelch and can be heard. For maximum squelch sensitivity set this control from counter-clockwise just until noise is silenced (and the "BUSY" indicator on the display is off) when the channel is clear.

(4) VOL Control

This control adjusts the volume of the receiver audio and of the button beeper.

Function Buttons (behind flip-down door)

To open the flip-down door, pry the right edge (next to the selector knob) out gently with a fingertip. To close the door, press upwards on the bottom edge of the door at its center. *Do not try to close the door by pushing from the front.*

The five buttons behind the door control most of the programmable features. If the beeper is enabled, one or more beeps will sound when a button is pressed, if the resulting command is accepted. The white label shows the primary function of each button. However, if you press the **F/W** button first, these buttons will perform alternate functions. On three of these, the alternate function is indicated by the blue label on or beneath the button. These are described in the *Operation* chapter.

For descriptions in this manual, we refer to alternate button functions by preceding the button name with "**F/W →**" to remind you to press the **F/W** button first. For example, "**F/W →** ^{LOW}**LOCK**" indicates that you should press the **F/W** button followed by the ^{LOW}**LOCK** button (within five seconds).

(5) RPT Button

This button toggles repeater shift: + (up), - (down) or off. The alternate function displays shift offset and ARS status.

(6) TONE Button

This button toggles the CTCSS (subaudible tone) features: encode (on transmission only), encode/decode (on both transmission and reception), and off. If the optional FTS-

17A Tone Squelch Unit is not installed, only encode and off modes are available. The alternate function displays the CTCSS tone frequency and button beeper status.

(7) ^{PAGE}**CODE** Button

This button activates DTMF paging (or code squelch) if the FRC-6 Paging/Code Squelch option is installed. The alternate function displays DTMF Code Memories.

(8) **CALL
BELL** Button

Press this button to jump to and from your CALL channel memory. The alternate function toggles the CTCSS paging bell, described later.

(9) **A/N
STEP** Button

While receiving on a memory, pressing this button toggles the display between frequency and alphanumeric name. The alternate function displays (and allows changing) the tuning step size, and the scan-resume mode, as described later.

(10) Selector Knob

This 24-position detented rotary switch is used for tuning, memory selection and most function settings. The **DWN** and **UP** buttons on the microphone duplicate the functions of this knob.

(11) **LOW
LOCK** Button

Press this button while receiving to toggle high/medium and low transmitter power (50/25 and 5 watts, respectively). The display shows "LOW" (above the S-meter) when

either low or medium power is selected. The alternate function of this button disables the selector knob and most of the front panel buttons (except itself, **F/W** and **POWER**, and the microphone buttons). Press **F/W** and this button again to unlock the panel.

(12) **MHz
PRI** Button

This button allows tuning in 1-MHz steps (the kHz digits blank on the display). If receiving on a memory, pressing this button the first time activates the *Memory Tune (MT)* mode, and pressing it again enables 1-MHz steps. The alternate function of this button activates priority monitoring, described in the *Operation* chapter ("P" displayed instead of the memory number to the upper left of the frequency).

(13) **REV
SKIP** Button

During split-frequency operation, such as through a repeater, this button reverses transmit and receive frequencies. During memory operation, the alternate function sets the current memory to be skipped during scanning.

(14) **D/** **MR** Button

This button switches operation between the two main tuning modes: dial and memory. The alternate function marks the current memory to be skipped during scanning. This button is duplicated by a button on the microphone in non-European versions.

(15) **F/W** Button

This button activates the alternate functions (blue labels) of most of the other buttons. It

is also used to store current operating data into a memory (by holding it down for 1/2-second, releasing and pressing again), and to toggle several programmable features.

(16) Display

The display segments are as shown below. The main digits on the display may show operating frequency, memory name, or any of many parameters during setting, such as tuning step size, CTCSS tone frequency, or

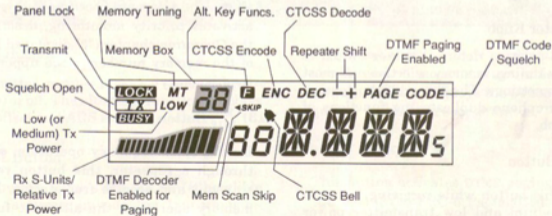

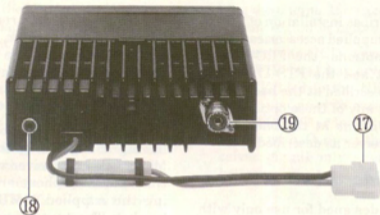

(17) 13.8V DC Cable Pigtail w/Fuse

This is the power supply connection for the transceiver. Use the supplied DC cable to connect this pigtail to the car battery or other DC power supply capable of at least 12 Amperes (continuous duty). Make certain that the red lead connects to the positive side of the supply. The fuse is 15-A, fast-blow.

(18) EXT SP Jack

This 2-contact mini phone jack accepts a 4- to 16-ohm external speaker such as the

Yaesu SP-3, SP-4, SP-7 or SP-55. Inserting a plug into the jack disables the internal speaker.

(19) ANT Coaxial Socket

Connect a 144-MHz antenna to this type-M (SO-239) socket using 50-ohm coaxial cable and a type-M (PL-259) plug. Make sure the antenna is designed specifically for use on the operating frequency.

Installation

This chapter describes installation of the FT-2400H with typical supplied accessories. Installation of internal options (the FRC-6 DTMF Paging/SelCall Unit and the FTS-17A CTCSS Decoder Unit) are described at the back of this manual. If you have any of these options, turn to *Installation of Options* at the back before installing the transceiver as described below.

Antenna Considerations

The FT-2400H is designed for use only with an antenna having an impedance near 50 ohms on the 2-meter band. For optimum performance use a high quality, carefully designed antenna. The antenna should always be connected when operating the transceiver, to avoid damage that could otherwise result if transmission occurs accidentally without an antenna.

Make sure your antenna is designed to handle 50 watts continuous transmitter power.

For best performance and safety in mobile installations, mount the antenna in the center of a flat surface, out of reach of human hands: 50 watts can cause an RF burn to anyone touching the antenna during transmission!

Also for best performance use the shortest possible length of thick, top-quality coaxial cable for your feedline. Be sure to use a matching type-M plug for the jack on the transceiver.

Mobile Installation

The FT-2400H must only be installed in cars having a negative ground electrical system. Mount the transceiver where the display, controls and microphone are easily accessible, using the supplied MMB-48 mobile mounting bracket. The transceiver may be installed in any position, but should not be near a heater vent or where it could interfere with driving. Make sure to provide plenty of space at the top and rear so that air can flow freely through the heatsink. Refer to the diagrams on the next page for installation.

- Decide the mounting location with sufficient clearance for the transceiver, plus space for ventilation above and behind the set. Use the mounting bracket as a template to mark the locations of the mounting holes. Use a 4.8-mm ($\frac{3}{16}$ ") bit to drill the holes, and secure the bracket with the four supplied long screws, washers and nuts (see diagram).

- ❑ Position the transceiver in the bracket so that the holes in the sides are aligned with those in the sides of the bracket, and bolt the transceiver into place with the supplied short screws and flat washers.
- ❑ The microphone hanger may be installed wherever convenient.

Mobile Power Connections

To minimize voltage drop and avoid blowing the car fuses, connect the supplied DC cable directly to the battery terminals. *Do not attempt to defeat or bypass the fuse — it is there to protect you and the equipment.*

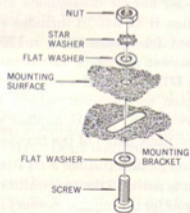

- ❑ Before connecting the transceiver, check the voltage at the battery terminals while revving the engine. If it exceeds 15 volts, adjust the car regulator before proceeding.
- ❑ Connect the RED power cable lead to the POSITIVE (+) battery terminal, and the BLACK lead to the NEGATIVE (-) terminal. If you need to extend the power cable use #14 AWG or larger insulated, stranded copper wire. Connect the cable to the transceiver pigtail only after connecting to the battery.

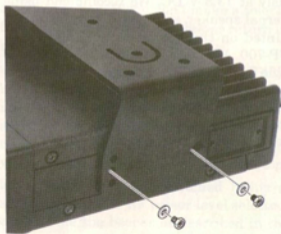

Warning!

Never apply AC power to the power cable of the transceiver, nor more than 15 volts DC. When replacing the fuse, use only a 15-A fast-blow type. Damage resulting from failure to adhere to these precautions may not be covered by warranty.

Base Station Installation

Operation from the AC line requires a power supply capable of providing at least 12 A continuously at 13.8 V DC. We recommend using an external speaker, since the internal speaker is mounted on the bottom of the transceiver. The FP-700 AC power supply/loudspeaker is available from your Yaesu dealer to meet these needs. Use the DC power cable supplied with the transceiver for making power connections, and connect the external speaker cable to the speaker jack on the rear panel.

External Speakers

Using an external speaker with the FT-2400H lets you position the source of audio where it is most convenient to overcome background noise in and around the car. The optional SP-7 External Speaker includes its own swivel-type mounting bracket, and is available from your Yaesu dealer. Of course the older SP-3, SP-4 or SP-55 External Speakers may also be used. Plugging in an external speaker disables the speaker in the transceiver.

Microphones

The MH-26G8J handie microphone for the European version B FT-2400H includes a button on the front for transmitting a 1750-Hz burst tone, to access repeaters that require it. The MH-27A8J DTMF keypad microphone also includes a button on the front, which, when used with a version A FT-2400H, duplicates the **D/ MR** button on the front panel of the transceiver.

Both microphone models include a PTT (Push-To-Talk) switch to activate the transmitter, and **DWN** and **UP** buttons for tuning and memory selection.

Operation

This chapter describes the transceiver functions in detail. After studying these descriptions, keep the *FT-2400H Operator's Quick Reference Card* handy in case you need to refresh your memory.

Preliminary Setup

Before operating the transceiver, recheck power supply and antenna connections, and connect your microphone to the front panel jack. Never operate the transceiver without a proper antenna for the operating band. Also, please read the earlier *Controls & Connectors* section, if you have not already, to familiarize yourself with the controls.

As mentioned before, references to alternate button functions have "F/W →" in front of the button name to remind you to press the F/W button first momentarily, and then the other button within five seconds (while "F" appears in reverse) above the leftmost frequency digit on the display). Don't hold the F/W button down, as that will give you a different result, and don't press two buttons at the same time (except the PTT switch, when storing a separate transmit frequency). When a button should be held down

Turning Power Off

To turn the transceiver off, you must press *and hold* the **POWER** button for ½-second.

(as opposed to just pressed momentarily) the instructions will say so.

A five-second timer starts when you press F/W, and clears when you pressing a button to make a new selection. If you don't make a selection in five seconds, the button functions return to normal (white labels).

A button beeper provides useful audible feedback when buttons are pressed, at a level determined by the volume control. Each button has a different beep pitch, and each function has a unique beep combination. For example, when you press the **LOW LOCK** button, you will hear a pair of low-, medium- or high-pitched beeps corresponding with the RF power level selected. You can disable the beeper as described in the box on the next page, but we recommend you keep it enabled while getting to know the controls.

Beeper Disabling

If you want to turn the beeper off (or back on), you can press **F/W** → **TONE** → **F/W** → **TONE** (each button twice, alternately). If you lock the controls (page 14) and have the beeper enabled, pressing a button will sound a different musical note for as long as it is held.

If you have trouble getting the transceiver to work as described, see *In Case of Problems* on page 34.

Squelch Setup

Before turning on the transceiver for the first time:

- Preset the **VOL** and **SQL** controls fully counter-clockwise.
- Then press the **POWER** button (if the transceiver is off) and adjust the **VOL** control for comfortable volume on the noise or any received signal. "**BUSY**" should be displayed in reverse letters at the far left.
- If you hear a signal, turn the selector knob to a clear channel (only noise).

- Turn the **SQL** knob clockwise just to silence the noise. The "**BUSY**" indicator will disappear. Setting the **SQL** further clockwise reduces sensitivity to weak signals. Whenever a signal reaches the receiver that is strong enough to open the squelch, "**BUSY**" will be displayed.

Note that while receiving, one or more bargraph segments may appear at the lower left corner of the display, indicating signal strength of received signals. This is not affected by the squelch setting, so even squelched signals can give some indication. If more than two bargraph segments appear while the squelch is closed, try reducing the squelch control setting (if you want to hear weak signals).

Frequency Selection Modes

Dial Mode

This mode is for tuning or scanning the band when looking for a channel on which to operate, when you don't have a specific frequency in mind. In this mode, the selector knob and microphone buttons each tune the band in the selected step size, or in 1-MHz steps, and the scanning function tunes in the selected step size.

Memory Mode

This mode is mainly for operating only on specific frequency channels known in advance (and programmed into the memories). For example, after storing the frequencies of your local repeaters into memories, you can confine operation to those channels by selecting the memory mode. In this mode, the selector knob, microphone buttons and scanning function select sequentially from the stored memories. The FT-2400H gives you 31 memories, each of which can store repeater shift and direction, CTCSS settings, and separate receive and transmit frequencies. There is also a *Memory Tune* mode, in which you can tune just like the dial mode, and store the resulting retuned memory into the same or another memory. This and other special memory mode functions are described later, but you will want to keep these terms in mind.

You can tell at a glance which channelling mode is in by looking in the shaded memory box above and to the left of the frequency display. If the box is empty, you are in the dial mode. If you see a number or an "L", "U" or "C" in the box, you are in the memory mode.

The $\frac{D}{MR}$ button near the top right corner of the display (and the button on the front of the MH-

27A&J microphone) toggles between the dial and memory modes. While in the memory mode, your previous dial mode selections are preserved. Also, when you switch from the dial to the memory mode, the last-selected memory is recalled.

Frequency & Step Selection

You can select a new operating frequency from either the dial mode or by retuning a memory. For now, we suggest using the dial mode. If you see a memory number in the memory box, press the $\frac{D}{MR}$ button to switch to dial mode. There are two ways to select your operating frequency: by the selector knob, or with the microphone buttons. However, holding one of the microphone buttons for more than 1/2-second starts the scanner. This is described later, but if you've already started it, just press a microphone button again to stop.

To select the MHz range in which you wish to operate: first press the $\frac{MHz}{PRI}$ button above the selector knob so that the kHz digits are blanked, and then turn the knob. To return to normal tuning and display, just wait five seconds, or press $\frac{MHz}{PRI}$ again to redisplay the kHz digits, and then turn the selector knob.

Locked Controls

If nothing happens when you press a button or turn the selector knob, the controls may be locked. Check for "LOCK" at the top left corner of the display, and if you see it, press **F/W** → **LOW LOCK** to unlock the controls. Later you will want to enable the lock (with the same button sequence) to prevent having your settings disturbed. Pressing buttons while locked sounds different musical notes for as long as a button is held, but only the unlock sequence affects operation.

Default channel (tuning) steps are 5 kHz in version A, and 12.5 kHz in version B (for Europe). To select another step size, press **F/W** → **A/N STEP**; turn the selector knob for the desired steps, and press **A/N STEP** again. See the box above if the buttons or knob fail to operate.

Transmitting

Press the **LOW LOCK** button at the upper right, several times, if necessary, to select low power output. The display will return to normal after a few seconds, and "LOW" is displayed to the left of the memory box (when either low or medium

power is selected). When you wish to transmit, wait until the channel is clear ("BUSY" not displayed), and squeeze the PTT switch on the microphone while talking across the front of it. During transmission, "TX" appears at the left side of the display, and the S&PO bargraph shows relative transmitter power output (4 segments for low power, 8 for medium, and full-scale for high). Release the PTT switch to receive.

If you require more power press the **LOW LOCK** button again (to switch to medium or high power). However, we recommend using low power whenever possible to minimize possible interference, current consumption and heating.

If using a European version, press the button on the front of the microphone to transmit a 1750-Hz Burst Tone to access repeaters that require it.

Repeater Splits

The FT-2400H offers several methods to set up split frequency operation for repeaters: manual (band, and memory-specific), automatic (ARS) and independently stored transmit/receive frequencies. The manual and automatic methods shift the transmit frequency above or below the receive frequency by a programmable

offset. This offset is preset at the factory to 600 kHz, but can be easily changed as described in the box at the right.

When in the dial mode, only one offset at a time can be used. This offset can only be changed while in the dial mode, and is applied any time repeater shift is activated (manually, or by ARS) in the dial mode. For repeaters that require an odd split, you can either program a memory-specific offset, or store an independent transmit frequency in the same memory. These methods are described later in the discussion on memories.

To activate the standard shift manually, just press the **RPT** button: once for minus shift, again for plus shift, and again to return to simplex. A small “-” or “+” sign appears at the top center of the display when minus or plus shift is selected, respectively.

Example: To operate through a 146.34/146.94 MHz repeater:

- Tune the display to 146.94 MHz (to receive on the output frequency).
- Press **RPT** once. A “-” (minus) should appear at the top center of the display (if not keep pressing **RPT** until it does).

Changing Repeater Offset

To display the current repeater offset, press **F/W**→**RPT**. The offset is displayed in MHz, to three decimal places. You can change the offset in 50-kHz steps with the selector knob or microphone **DWN** and **UP** buttons. In most cases you will want to keep the repeater offset programmed to the most commonly used split in your area.

Also, you can enable/disable ARS (Automatic Repeater Shift), by pressing **F/W** at any time while the offset is displayed. An “A” appears in the memory box when ARS is enabled.

When set as desired, press the **RPT** button to return the display to the operating frequency.

- When the channel is clear, press the PTT switch on the microphone and send your call sign. The display should shift to 146.34 MHz while you transmit.

Of course this example only works if the offset is set to 600 kHz, as supplied from the

factory. You can change it as described in the box on the previous page.

With repeater split activated, you can reverse the transmit and receive frequencies by pressing the **REV SKIP** button above the selector knob. Use this to display the transmit frequency without transmitting, and to check the strength of signals on a repeater uplink frequency. The repeater shift sign blinks while reverse split is selected. Press **REV SKIP** again to return to the normal shift direction.

Automatic Repeater Shift

The ARS (Automatic Repeater Shift) feature activates repeater offset automatically whenever you tune to the standard repeater subbands (see chart below). With this feature enabled, a small “-” or “+” at the top center of the display indicates that repeater shift is ac-

tive, and closing the push-to-talk switch changes to the (shifted) transmit frequency.

The ARS function is disabled at the factory. See the box on the previous page to enable it.

As already mentioned, you can use the manual shift method (**RPT** button) at any time to select a new shift state, whether ARS is activated or not. However, if you change frequency inside a repeater subband with ARS activated, manual repeater shift selections are cancelled.

Simple Memory Storage & Recall

The FT-2400H offers 31 memories, labelled 1 ~ 28, C, L and U. Each can initially store the current operating data from the dial mode or a retuned memory. Once a memory has been stored, its repeater shift and offset, CTCSS tone data and settings for the DTMF Paging and CTCSS options can be modified, a 4-character name can be assigned, and a separate transmit

Automatic Repeater Shift - Repeater Subbands

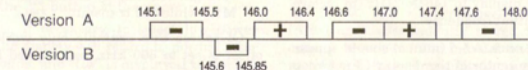

frequency can be stored. Memory C (the CALL channel memory) can be recalled instantly by the **CALL BELL** button, and memories L and U store programmable subband limits, described later, in addition to general purpose operation.

To store a frequency in memory:

- Select the desired frequency (and repeater split direction, if desired) in the dial mode as already described, or by retuning a memory.
- Press and hold the **F/W** button for 1/2-second, until a second beep sounds. A memory number or letter appears blinking in the memory box.
- Within five seconds of pressing **F/W**, use the selector knob or microphone **DWN** and **UP** buttons to select the desired memory for storage (in the memory box). If you select one that was already being used, it will be overwritten with new data in the next step.
- Press **F/W** momentarily to store the displayed data into the selected memory. The memory label will stop blinking for a second, and then disappear as operation continues in the dial mode.

Example: Store the 146.34/146.94 repeater data in memory 5.

- First perform the steps in the example on page 15 to set up the desired frequency and offset on the dial.
- Press and hold the **F/W** button for 1/2-second to display a memory label in the memory box, then do the next step within 5 seconds.
- Turn the selector knob so that "5" (the memory number to store) shows in the memory box.
- Press **F/W** again, momentarily. That's it. The dial data has been stored in memory 5. After a few seconds the memory box will clear, and you are left operating on the dial.

To confirm that this worked, turn the selector knob to change the dial frequency (to anything), then press **D/MR** to change from dial to memory mode. The numeral 5 should appear in the memory box, and 146.94 (the receive frequency) should appear on the display. Press **REV SKIP** to confirm the transmit frequency of 146.34 MHz.

You can use any memory (except C, the CALL channel) with the same result. Memory C requires a slightly different procedure. Notice that pressing **D/MR** from the dial mode always recalls the last stored or used memory.

Recalling Memories

In confirming the results of the last example, we used the **D/MR** button to change from the dial mode to the memories after they were stored. The memory label appears in the memory box at the upper left corner of the frequency display whenever operating on a memory.

When more than one memory has been stored, you can select a memory for operation with either the selector knob or the microphone **DWN** and **UP** buttons. If you use the microphone buttons, press and release the button for each memory: if you hold the button down for $\frac{1}{2}$ -second, memory scanning will start.

Odd-Split Memories

After storing a frequency, with or without repeater shift, from the dial, you can modify the repeater shift and offset of that memory only. Just recall the memory, press **RPT** as necessary to set the shift direction, and then follow the steps in the "Changing Repeater Offset" box on page 15. If you want to make the new offset permanent for that memory, remember to press and hold the **F/W** button for $\frac{1}{2}$ -second, until the second beep sounds and then press it again momentarily. Of course you could also store a

separate transmit frequency in the memory (described later) to obtain the same result, but you may find this more straightforward when dealing with repeaters.

Naming Memories

Once you have stored a memory, you can assign it a name to be displayed when it is recalled, in place of the frequency. Names can be up to four characters long, using capital A - Z, 0 - 9 and an underline. To store a name, first store the memory and then recall it as already described.

- Press and hold the **F/W** button for $\frac{1}{2}$ -second, until the second beep sounds and the memory number starts blinking in the memory box.
- Within five seconds of pressing **F/W**, press the **A/N STEP** button. Unless a name was previously stored for this memory, the frequency will be replaced by ("-- -- -- --", with the first pair of hyphens blinking).
- You can now use the selector knob to choose the first character of the name to be displayed.

- After selecting the desired character, use **MHZ STEP** or the microphone **DWN** and **UP** buttons to get the next pair of hyphens blinking, and use the selector knob to set this character.
- Repeat the last step until all characters are set as desired, and then press **A/N STEP** twice. At the first press, the display will return to the memory frequency. After the second press, the memory name will be displayed — for this and any other memories that have been assigned names (unnamed memories will still be displayed as channel frequencies).

Once you have stored names for several memories, you can toggle between frequency and name views for all of them at any time while receiving on a memory, by pressing **A/N STEP**.

CALL Channel Memory

Although invisible to the memory recall method described so far, the CALL channel memory can be instantly toggled by the **CALL BELL** button. “c” appears in the memory box when the CALL memory is active. The factory default for the CALL channel memory is the bottom edge of the band. You can reprogram it from the dial with any frequency and repeater state, or even a separate transmit frequency. After storing the

frequency, you can also set and change repeater settings, and give it a name to display in place of frequency, just by recalling it before following those procedures.

To store the current dial frequency/repeater state in the CALL channel memory, hold the **F/W** button for ½-second to display something in the memory box, then press the **CALL BELL** button. To store a name for the CALL channel, follow the same steps for a regular memory after pressing **CALL BELL** (so the procedure is done while “c” appears in the memory box). To store a separate transmit frequency in the CALL channel, after storing the receive frequency, tune the dial to the transmit frequency and repeat the storing procedure above, but this time holding the PTT switch when you press the **CALL BELL** button.

Separate Transmit Frequency Memories

Besides the CALL memory, all other memories can store independent receive and transmit frequencies (however, if you are working through a repeater, you might find storing a unique repeater offset to be simpler — see “*Odd-Split Memories*”, above). To store a separate transmit frequency,

- Store the receive frequency using the method already described under Simple Memory Storage (it doesn't matter if a repeater offset is active).
- Tune to the desired transmit frequency.
- Press and hold the **F/W** button for 1/2-second to display the memory label box again.
- Press and hold the PTT switch while pressing **F/W** once more momentarily (this will not key the transmitter).

Whenever you recall a separate transmit frequency memory, “- +” appear together at the top center of the display. As with regular repeater offset operation, you can press the **REV SKIP** button to display the transmit frequency, but in this case *both* shift symbols will blink.

After storing a memory with a separate transmit frequency, if you rewrite the receive frequency, the separate transmit frequency is deleted.

Memory Tuning

While receiving on a recalled memory, you are free to change settings such as repeater shift and offset as already described, as well as CTCSS and DTMF Paging settings, described

later. However, in the memory mode, the selector knob and microphone buttons normally just select from among the stored memories. To change the function of these controls so that you can retune the current memory, press the **MHZ PRI** button momentarily. “**MT**” appears to the left of the memory label in the memory box, and you can tune in the same ways as described before for the dial mode (including MHz steps). If you are displaying the memory name instead of frequency, the display will change to frequency while you tune, and then automatically back to the name after a few seconds.

You can store the new frequency and settings in the current, or another, memory. Just press and hold **F/W** for 1/2-second, select the new memory (if desired), and press **F/W** again momentarily. Operation remains on the (new) memory as the old memory reverts to its original state.

Note

Names stored in memories always stay with the memory number - they are not copied or overwritten when storing a retuned memory into another memory.

After retuning a memory, if you don't want to save your changes, just press $\frac{D}{MR}$ once to return to the original memory data, or twice if you want to leave the memories and return to the dial mode.

Hiding and Erasing Memories

As already mentioned, storing data in a memory automatically overwrites previously stored data (except the memory name). However, if you regularly move from one area to another, you may not always want to use the same memories. With the FT-2400H, you can select and alter which memories are available during memory selection and scanning without having to rewrite them from scratch. This is done by masking certain memories so that they are hidden from operation, and unmasking them only when desired.

To mask a memory,

- Recall the memory to be masked.
- Press the **F/W** button for $\frac{1}{2}$ -second (until the second beep and the memory label blinks). If you were displaying the memory name, it will revert to frequency at this point.

- Press the $\frac{REV}{SKIP}$ button. This causes the display to change to the next lower stored memory, and the previously selected memory to be no longer selectable manually, or by scanning (described later).

To unmask a hidden memory for operation,

- Recall any memory.
- Press and hold the **F/W** button for $\frac{1}{2}$ -second.
- Select the memory number to be restored.
- Press the $\frac{REV}{SKIP}$ button (*not F/W!*).

When you have hidden some memories, be careful not to overwrite them accidentally. If you do, you will lose all previous contents except the name.

Scanning

Before you start scanning, make sure the **SQL** control is set to squelch off the noise on a clear channel. You start and stop scanning with the **DWN** and **UP** buttons on the microphone. Just press and hold the button for more than $\frac{1}{2}$ -second to start scanning. If the transceiver is in the dial mode, band scanning will result. Otherwise, if a memory label is displayed, only the memories will be scanned.

The scanner pauses when a signal opens the squelch, and the decimal point on the display blinks. You can also stop the scanner manually by pressing $\frac{D}{MR}$.

Memory Skip Scanning

When you have some very active channels stored in memories you may wish to skip them

Scan Resume Mode Selection

You have a choice of two scan-resume modes: either *Pause* mode, in which the scanner pauses for as long as the carrier keeps the squelch open; or the *5-second* mode, in which the scanner pauses for five seconds and then resumes scanning whether the signal is still present or not. The 5-second mode is the factory default.

To change the scan-resume mode (when not scanning), press $F/W \rightarrow \frac{A/N}{STEP}$. A "P" or "5" in the memory box indicates the current mode. If you want to change it, press F/W momentarily. Press $\frac{A/N}{STEP}$ again to return to the frequency display when the scan-resume mode is set the way you want it.

when scanning, but still have them available for manual selection. You can mark a memory to be skipped by pressing $F/W \rightarrow \frac{REV}{SKIP}$ while receiving on the memory. "SKIP" appears in tiny letters just to the right of the memory number box to show that this memory will be skipped during scanning (although you can still recall it manually). Once set, the scan skip state remains with the memory until it is specifically cancelled.

To to this and re-enable the memory for scanning, just repeat the steps you took to disable it: select the memory manually, and press $F/W \rightarrow \frac{REV}{SKIP}$.

Programmable Subband Limits

Besides band and memory scanning, the FT-2400H can be set to tune or scan only the frequencies between two frequency limits of your choice (with the selected channel steps). Briefly, the procedure is to store the limits in the special memories labelled *L* (lower) and *U* (upper), and then with either memory recalled, press the $\frac{MHz}{PRI}$ button momentarily.

As described previously in *Memory Tuning*, "MT" appears in the memory box (but this time it is blinking), and you can tune the memory, al-

though the frequencies stored in memories *L* and *U* now limit the tuning and scanning range to the resulting subband. If the either ARS or manual repeater shift is activated, repeater offset is applied automatically when you transmit (even if the resulting transmit frequency is outside the subband limits). If you store an odd repeater offset (this is, one different from the dial mode's repeater offset) in one of the limits, the odd offset will be applied.

Note: The frequency resolution of subband limits is 100 kHz, although the channel resolution of memories *L* and *U* is the selected channel step size. Therefore the frequencies stored in both memories *L* and *U* are rounded down to the nearest 100 kHz to determine the actual subband limits. Since they are not limited to a specific frequency, you can still use the *L* and *U* memories for other purposes on any frequency within the 100-kHz range above the intended subband limit.

Example: To limit reception to 146.0 – 148.0 MHz (only applicable to certain transceiver versions)

Tune the dial to *any channel between 146.000 and 146.095 MHz.*

- Hold the **F/W** button for ½-second, tune the selector knob so that *L* appears in the memory box, and then press **F/W** again momentarily. The displayed frequency is now stored to provide an effective lower subband limit of 146.000 MHz.
- Tune the dial to any channel between 148.000 and 148.095 MHz.
- Repeat the second step, selecting *U* in the memory box. This stores the effective upper subband limit of 148.000 MHz.
- Press **D/ MR** to change to memory operation.
- Press the **MHz PRI** button momentarily to activate the 146.000 – 148.000 subband limits for tuning and scanning.

To cancel your subband limits and return to memory operation, press **D/ MR** (if you are scanning, or want to return to dial operation, you must press it twice). Pressing the **CALL BELL** button also cancels subband limits as operation switches to the CALL channel.

Once you have stored the *L* and *U* memories, you can reactivate the subband just by recalling either memory and pressing **MHz PRI**. However, you cannot activate the subband when the *L* or

U memories are marked for skip-scanning (you'll get ordinary memory tuning), or if either of these memories are masked (hidden).

Priority Channel Monitoring

Priority monitoring provides automatic checking for activity on a priority channel (memory) every five seconds while operating on the dial or other memories. When the receiver detects a signal on the priority channel, operation automatically shifts to that memory while the signal is present (plus a few seconds). If you transmit while paused on the priority channel, priority monitoring ceases and operation stays on the priority memory.

To set up for priority monitoring:

- Preset the squelch, and store the frequency to be monitored in a memory (this must be memory 1 if you will be operating on other memories during priority monitoring).
- Press $\frac{D}{MR}$ to operate in the dial mode, or else select the memory you want to operate on, and then press $F/W \rightarrow \frac{MRZ}{PRI}$.

A "P" appears in the memory box, and about every five seconds the displayed frequency

shifts to the priority memory briefly while the receiver checks for a signal.

While no signal appears on the priority channel to open the squelch, you can tune, transmit and receive on the dial, or select and operate on other memories (but not scan them). If a station you wish to talk with appears on the priority memory, press the PTT switch momentarily while receiving their signal, to stop priority checking. Otherwise, when a signal appears on the priority memory, priority checking will pause and the decimal on the display will blink. Priority monitoring will resume according to how you set the scan-resume mode - either after a 5-second pause, or after the carrier drops (see page 22). To cancel priority monitoring manually, press $\frac{D}{MR}$.

Note that you can use any other memory as a priority channel in the above procedure when you are going to be operating in dial mode. You cannot, however, switch from memory to dial operation or vice-versa without first cancelling priority monitoring (pressing $\frac{D}{MR}$ cancels priority monitoring). You also cannot scan during priority monitoring.

CTCSS Operation

The built-in tone encoder function can be used to access repeaters and stations that require a CTCSS (subaudible) tone, by sending a tone whenever you transmit. Also, if you have the FTS-17A CTCSS Decoder Unit option installed, you can silently monitor for calls on busy channels. The encode function superimposes a subaudible tone (at a frequency too low to be heard) on the transmitted carrier. The optional (FTS-17A) decode function monitors receiver audio through a narrow filter at the same subaudible frequency, keeping the squelch closed until you receive a matching tone. *Installation of Options* at the back of this manual describes installation of the FTS-17A.

To check or set the CTCSS tone frequency, press **F/W** → **TONE** to display the tone frequency in Hz. To change the tone frequency, rotate the selector knob or press the microphone **DWN** and **UP** buttons until the display shows the tone frequency you require (from the choices in the table at the right). Press **TONE** to return to the operat-

ing frequency display after checking or selecting the tone frequency.

To activate CTCSS operation just press **TONE** when the operating frequency is displayed. "ENC" (encode) appears at the top of the display and the tone generator is activated for transmission. If you press **TONE** again without the FTS-17A option, the encoder turns off. If the FTS-17A is installed, both "ENC" and "DEC" (decode) are displayed together as tone squelch is activated for both transmission and reception (requiring a matching tone frequency to open the squelch). Pressing **TONE** once more disables tone squelch.

You can store different CTCSS tones (and encode/decode states) in each memory in the same manner (and at the same time) as storing operating frequencies. Later, to change the tone or state stored in a memory, just recall it, reset the tone frequency or function, and store the memory again.

FTS-17A Tone Frequencies (Hz)			
67.0	100.0	141.3	203.5
71.9	103.5	146.2	210.7
74.4	107.2	151.4	218.1
77.0	110.9	156.7	225.7
79.7	114.8	162.2	233.6
82.5	118.8	167.9	241.8
85.4	123.0	173.8	250.3
88.5	127.3	179.9	
91.5	131.8	186.2	
94.8	136.5	192.8	

"CTCSS Bell" Paging with the FTS-17A

CTCSS Bell operation is very similar to the CTCSS encode/decode operation just described, in that subaudible tones open the squelch. However, if you are waiting for a call, it is sometimes convenient to have the transceiver "ring" to get your attention. The CTCSS Bell mode displays a small bell above the 10's-of-MHz frequency digit on the display (or to the left of the name, if displaying a memory by name). When you

receive a matching CTCSS call, the small bell on the display blinks to indicate you received a call, and the transceiver rings like a telephone if you have the ringer enabled (see box below). To activate the CTCSS Bell:

- Tune to the desired frequency or memory.
- Select a CTCSS tone frequency using the **F/W** and **TONE** buttons as described on the previous page, if you have not already.

Ringer Alerting Tone

You can control the way the transceiver rings when either a selective call (CTCSS Bell, or DTMF Page) is received. You can set the ringer to sound differently for each of these modes. To check or change the state of the ringer, press and hold **F/W** for $\frac{1}{2}$ -second, then press **PAGE CODE**. The number in the center of the display indicates the length of each ring, and can be set to 0, 1, 3, 5 or 8 (ringing tone pairs) with the selector knob or mic buttons (0 = no ringing).

The display also shows either "P" (for DTMF pager) or "b" (for CTCSS Bell) in the memory box, indicating to which response mode the displayed ringer length setting applies. Press **MRZ PRI** to display and allow changing the other mode's ringer setting.

There may also be a letter "S" displayed just above the **VOL** control. If present, the ringer is set to ring only once (single ring) when a call is received. If it is not displayed, the ringer will sound when a call is received, and every 2 minutes thereafter until reset by the **PTT**, or corresponding tone button. Press the **F/W** button to toggle between single and multiple ringing.

- When you expect to receive calls from stations using tone squelch (decoding, or CTCSS Bell at their end), activate tone squelch encode/decode operation as described above, so they will not miss your signal when you turn off the CTCSS Bell later to reply.
- Press **F/W** → **CALL BELL** to activate CTCSS Bell paging (the small bell icon will appear).

As with CTCSS decoding, all calls without a matching CTCSS tone will be ignored by your receiver, but those with the matching tone will cause the transceiver to ring and the squelch to open while the caller transmits. The bell icon begins to blink, and continues until you manually reset it (by pressing the PTT switch to transmit, retuning, or pressing **D/MR**). Note that the other station does not need to be using the CTCSS Bell function to call you: they can use normal CTCSS encode-only (or encode/decode) functions of their transceiver.

When you receive a call, if you have the ringer enabled, you will need to disable the CTCSS Bell feature to prevent ringing every time the other station transmits: press **F/W** → **CALL BELL** to turn it off.

The CTCSS Bell system is not memory-specific: turning it on or off affects the dial and all memories.

Note: If you activate the Bell without having an FTS-17A installed, it will ring every time the squelch opens.

DTMF Paging & Code Squelch *(with the FRC-6 Option)*

The FRC-6 option includes a DTMF tone encoder/decoder and a dedicated microprocessor providing paging and selective calling features under DTMF control. The paging and code squelch systems use 3-digit numeric codes (000 - 999), transmitted as DTMF (Dual-Tone, Multi-Frequency) tone pairs. The FRC-6 has eight Code Memories in which to store 3-digit DTMF paging codes.

The primary function of the DTMF signaling system allows your receiver to remain silent until it receives one of the stored 3-digit codes. Then the squelch opens so the caller is heard, and in the paging mode, the transceiver also rings like a telephone (if desired - see the box on the previous page). When you close the PTT to transmit, the same three prestored DTMF code digits are sent automatically. In the paging mode, three more DTMF digits are also

sent, representing your personal station identification.

The DTMF paging and code squelch systems are selected by the **PAGE CODE** button. Either "PAGE" or "CODE" appears at the top of the display when DTMF paging or code squelch is activated, respectively.

DTMF Code Squelch

The code squelch mode is very simple. Both you and the other station communicate using the same 3-digit DTMF sequence, sent automatically by the FT-2400H at the start of every transmission. Your receiver normally remains silent to all signals that are not prefixed by your selected 3-digit code. After you receive the tones, your squelch opens and stays open during their transmission.

To use the code squelch mode, you must first store and then manually select the one Code Memory holding the 3-digit DTMF code required to open both your squelch and that of the other station (as described on the following pages). Also, in the code squelch mode, Code Memories 1 - 7 always function the same — the distinctions and special settings described below for the paging mode do not apply.

In either code squelch or paging modes, any DTMF-equipped station can call you (they can use a DTMF keypad to send the three digits if you are in code squelch mode, or six digits if you are in paging mode).

DTMF Paging

In the DTMF paging mode, you can receive signals that are prefixed with any of up to seven different pre-stored 3-digit codes, according to the way you program the Code Memories. When you receive a paging call, the selected Code Memory changes automatically, and the display responds by displaying a Code Memory number (blinking) in the memory box, and with the 3-digit DTMF code of the caller in place of the frequency display. The meaning of the Code Memory number and 3-digit code displayed depends on how you stored the paging code:

Individual Codes

These are personal ID codes to identify each station uniquely. You store one of these for your ID, in Code Memory 1. You can store up to six other Individual Codes of stations you call often, in Code Memories 2 - 7. When someone else transmits your Individual Code your display shows Code Memory "0" blinking in the memory box, with the other station's Individual

Code appearing in place of the operating frequency, so you can see who called.

Group Codes

This type of code identifies a group of stations. You would generally share a Group Code with other club members or friends. When you receive a call with a Group Code the Code Memory number (2 - 7) in which you stored that 3-digit Group Code appears blinking in the memory box, with the corresponding 3-digit Code number (in which you stored that code) to the right.

Note that for a Group Code, the display does not show the ID and code of the caller, but those of the group instead. Code Memories 2 - 7 can be used to store either Individual Codes (for calling purposes only) or Group Codes (for both calling and receiving), as you desire.

When either an individual page directed to you, or a call to a group is received, the *PAGE* indicator starts blinking, and continues until you reset it (unless you have activated the auto-transpond feature, described in the box on page 31). This is convenient to let you know if someone called while your attention was elsewhere. Also, the ringer sounds once, or every two minutes, according to how you have it set (page 26).

Remember, with code squelch operation (but not with paging), you can only receive a call on the currently-selected Code Memory, and the display does not change, nor the ringer sound, when a call is received. So for code squelch, as mentioned before, the Individual/Group distinction does not apply (although you must still store the 3-digit Code Memories).

Storing Code Memories

The first thing to do before using the paging or code squelch systems is to store your Individual Code in Code Memory 1.

- Activate the DTMF Code Memory display by pressing **F/W** → **PAGE CODE**. The current Code Memory number appears blinking in the memory box, and the frequency display is replaced by the corresponding 3-digit DTMF Code ("000", if not used before).
- Turn the selector knob to select Code Memory 1 (the Code Memory digit can be set to 0 - 7, with 0 being "read-only", and 2 - 7 programmable with group or other individual's IDs). Code Memory 1 is for your personal DTMF paging ID Code.
- Press either the **MHz PRI** button or the **UP** button on the microphone. The Code Memory num-

ber will stop blinking, and the first digit of the 3-digit DTMF Code will start blinking.

- Turn the selector knob to select a DTMF Code digit between 0 and 9, corresponding to the first digit of the personal ID code for your station (whatever you wish to use).
- Press **MHz** or the microphone **UP** button again to cause the next digit to the right to blink, and again turn the selector knob to select the next digit of your ID code.
- Repeat the above step to set the last digit.

At this point, if you want to go back and change one of the three code digits, you can press the **DWN** button on the microphone.

Your ID code is now stored in Code Memory

1. You can press **PAGE CODE** to return to the frequency display now, or you can store other code memories in the same way: press **MHz** or the microphone buttons again to get the Code Memory number in the memory box blinking, turn the selector knob, and repeat the above steps. However, before storing more Code Memories, you will need to consider an additional feature for Code Memories 2 - 7, described next.

Generally, you store another station's ID Code so you can page them, but you probably do not want to have *your* transceiver ringing every time someone else calls *them*. On the other hand, you store group codes with the intention of receiving any pages to the group (so you want your squelch to open and the transceiver to ring, if paging).

During the Code Memory storage procedure described above, when storing Code Memories 2 - 7, you have an opportunity to decide whether your transceiver should respond to incoming paging calls on a particular Memory Code. At any time when a Code Memory is displayed, you can press the **F/W** button to toggle DTMF squelch paging capability on and off. When on, that is, when the decoder is enabled to receive paging calls with this Code Memory, an underbar appears beneath the memory box.

Therefore, if you are setting a Group Code, you want to have the underbar on, and if setting another station's Individual Code, you want it off. As already mentioned, this distinction does not apply to code squelch only (non-paging) operation: code squelch behavior is the same, regardless of this setting.

Note that the underbar is displayed permanently on Code Memory 1, since this is your own

ID (that you will always want to receive when paging is activated). Also, the underbar never appears on Code Memory 0, since this is reserved for display of the ID of incoming paging calls.

Replying to a DTMF Page, and Resetting

After setting a Code Memory, even before returning to the frequency/memory display (by pressing ^{PAGE}/_{CODE}), you can receive DTMF Paging calls directed to you. Any DTMF-equipped station can call you by sending your 3-digit code, followed by their 3-digit ID Code. If you monitor with the code squelch activated ("CODE" displayed), your squelch will open when you receive the currently-selected DTMF Code - even if it is not your ID in Code Memory 1. If you are monitoring with the DTMF Paging feature activated ("PAGE" displayed, blinking after a call is received), the transceiver reacts according to how you stored your Code Memories, as described above. The paging ringing tones can be set as described in the box on page 26, to suit your preference. For paging, you can also have your transceiver respond automatically when you are paged, as described in the box at right.

If you press your PTT switch after receiving a call, the Code (either Individual or Group) is

Auto-Transpond Paging

Normally, after a page is received, the indicator blinks on the display until you transmit to respond to the page, or press ^{PAGE}/_{CODE} or ^{D/}/_{MR} to return to the frequency/memory display. This lets you know if a call came in while you were distracted, but it does not let the caller know whether you received his call, or not. The auto-transpond feature addresses this problem. When enabled, your display still changes to show Memory Code 0 and the caller's code, and the ringer still sounds (if it is enabled), but the radio also automatically transmits your ID Code back to the caller. Thus he can tell that you are in range, although possibly not able to answer his page right away.

To activate auto-transpond, just press the RPT button while the DTMF Code setting display is active. An "R" appears to the right of the displayed Memory Code when the feature is enabled.

Note that auto-transpond is not Code Memory-specific: it is either enabled or disabled for all paging calls (including groups).

transmitted automatically, and if paging is enabled, your ID Code is sent as well.

DTMF Code Delay

When calling other stations with DTMF paging or code squelch, particularly through repeaters, you may find some are unable to receive your calls. This can be caused by their receiver squelch not opening fast enough (after receiving your carrier) to allow all of the DTMF codes to be received and decoded. To correct this problem, you can set a longer delay between the time your transmitter is activated and the time that the first DTMF digit is transmitted.

Press **F/W** → **PAGE CODE**, if necessary, to activate the DTMF Code setting display (the number in the memory box blinks). Then press **D/HR** to toggle the DTMF Code delay between 250 and 750 ms (an "L" appears at the left side of the DTMF Code when the longer delay is selected).

As with the auto-transpond feature, the DTMF Code Delay selection applies to all Paging Codes.

To respond to an individual call, when your display shows Code Memory 0, pressing your PTT switch causes your transceiver to transmit your ID Code and the other station's ID Code automatically (that is, the one displayed in Code Memory 0), and resets the blinking indicator. The other station will then hear a ring from their receiver, as their squelch opens.

You will probably want to switch from paging to code squelch mode once contact is established, or your transceiver will continue to ring every time the other station transmits. To do this, both stations must both have the same 3-digit code selected, so at least one of you will have to change your Code Memory selection (recall that when a DTMF paging contact is established, the transceivers at both ends are set to Code Memory 0, with the other station's unique ID displayed). If you change your Code Memory selection to Code Memory 1, it will then match his Code Memory 0, and all he will have to do is switch from paging to code squelch mode.

To do this, after you have exchanged initial paging calls, press **PAGE CODE** twice (to change from paging to code squelch mode), then **F/W** → **PAGE CODE** to bring up the code setting display, and then turn the selector knob one click clockwise (to display

a blinking 1 in the memory box). If, while you were doing this, he just changed from paging to code squelch mode, when you again transmit he should hear you, and you hear him, without the ringing.

With Code Squelch activated in this manner, you will hear three DTMF code digits at the start of each of his transmissions, and your set will also transmit the same three digits when you press your PTT switch. These digits are those stored in the current Code Memory, and they

will open the squelch of both stations. Therefore, at the start of each transmission, you must wait a second or two after pressing the PTT switch for the DTMF code to be sent and his squelch to open before you start speaking.

When you finish your conversation, to reactivate DTMF Code Paging, press **PAGE CODE** twice so that "PAG" is again displayed.

In Case of Problems

Although basic operation of the FT-2400H is simple, some of the newer features may seem somewhat complicated at first. The small number of controls belies the variety of features that are available, and some buttons have more functions than are indicated by their labels. So it is not difficult to get lost, at least until you have had the chance to familiarize yourself with all of the features. This section provides some tips to help you navigate the various display and button modes.

If the display shows nothing at all, push the power switch, and check the power supply connections and the fuse in the power cable pigtail. If the fuse is blown, you will need to find out and correct the cause before replacing it. Replace the fuse only with one of the same type and capacity: 15-A, fast-blow.

The display usually tells a lot about the current state of operation. With the FRC-6 option installed, the display can take on many different states. Most of these are shown at the right, together with the button to press in each case to return to the main (operating frequency) display. You will also see a (programmable) 4-letter word displayed in place of frequency when a

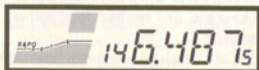

Main Frequency Display

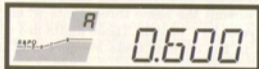

Repeater Shift & ARS - press RPT

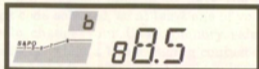

CTCSS Freq. & Beeper - press TONE

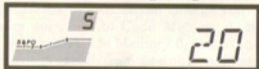

Step & Scan Resume - press A/N



DTMF Code Setting (option) - press PAGE

named memory is displayed. Pressing $\frac{A/N}{STEP}$ will display the frequency. Except for the main frequency and the memory name displays, most or all of the other buttons will be disabled anyway.

It is well worthwhile to study the main frequency display diagram on page 6 carefully. This display is the basis for basic operation. For example, if the frequency display changes unexpectedly when you transmit (or if "Err" appears), check for a small "+" or "-" at the top center, indicating that repeater shift is active, but that the resulting transmit frequency is out of range.

If the main frequency or memory name display is visible, but pressing a button appears to do nothing, first check for "LOCK" at the top left corner of the display. If you see it, press F/W \rightarrow $\frac{LOW}{LOCK}$ to unlock the buttons. Otherwise, you can press the $\frac{D/}{MR}$ button, which will usually terminate any partially entered commands.

If the number in the memory box is blinking, the display is showing a DTMF Memory Code. This occurs spontaneously when a DTMF page is received. Press $\frac{PAGE}{CODE}$ to return the frequency display to normal.

If you still cannot enter data, check to see if the "TX" indicator near the upper left of the display is on, indicating that the transceiver is transmitting. Releasing the PTT switch should return the set to receive. If still nothing happens, switch the transceiver off, and then back on.

If the display shows all segments at the same time, or shows "C-Rx" and you cannot turn the set off, you may have inadvertently started memory cloning - press the PTT switch (the display will change to "Err", and then hit the power switch to return to normal operation.

As a last resort, if you are unable to gain sensible control of the transceiver, reset the CPU as described in the next section.

To avoid confusion resulting from inadvertent button presses, set the keypad lock on (press F/W \rightarrow $\frac{LOW}{LOCK}$) if you leave the transceiver unattended while it is on. Remember to set the lock back off when you wish to enter data.

Resetting the CPU

The FT-2400H has three levels of resetting: memory-only, all-setting soft reset, and all-setting hard reset:

To reset only the memories, hold the **F/W** and **D/ MR** buttons while switching the set on. Your step, repeater shift and other setting will be retuaniend, while the memories will be cleared.

To clear all setting to their factory defaults, hold **D/ MR** and **REV SKIP** while turning the transceiver on. Then turn the transceiver off and hold only **D/ MR** while switching it back on again. If for some reason this fails, you can perform a hard reset by removing the top cover, and shorting across the split solder pad on the circuit board exposed on the inside of the front panel, just behind the top left corner of the display. Then hold **D/ MR** while switching on.

Memory Backup

Normally, a lithium battery inside the transceiver retains all settings and memories while power is off or disconnected. If the transceiver loses its memories (but still operates properly), this battery should be replaced.

The front panel must be removed to gain access to the battery, which is on the inside of the front panel, just behind the memory box on the display. It should be replaced only by an Yaesu-authorized technician to ensure that it is installed properly.

Memory Cloning

All memory data stored in one transceiver can be moved to another by connecting the microphone jacks together with the optional cloning cable, available from your Yaesu dealer.

- Turn both transceivers off, and connect the mic jacks together. Press and hold the **F/W** buttons while turning the power switches on. All segments of the displays will be on.
- Press the **REV SKIP** button on the destination transceiver (the display will show "C-Rx" in place of frequency).
- Press the **RPT** button on the source transceiver. The display will show "C-Tx" while the data is being transferred, and should then return to normal. If "Err" appears on the destination display, turn both transceivers off and try again. If the display of the destination transceiver remains all blank or all on, and you cannot turn the transceiver off, press the **PTT** switch (the display will change to "Err", and then hit the power switch to return to normal operation. Recheck your cable, and then try again.
- Turn both transceivers off and remove the cloning cable.

Packet Radio

Packet radio operation with the FT-2400H requires a later-model tnc with a PLL-type DCD circuit, since there is no readily-accessible squelch status output from the radio to tell the tnc when the channel is clear. Connections between the tnc and the microphone jack of the FT-2400H can be made as indicated in the table below.

You must use an 8-pin modular telephone-type plug for the mic jack connections. Use shielded cable for the audio lines, and keep it as short as possible to avoid RF pickup.

"RADIO" Jack on TNC	FT-2400H Mic Jack	Comment
Receiver Audio in	pin 2	8 ohms, de-emphasized
PTT out	pin 3	ground to transmit
Transmit Audio out	pin 4	400 ohms, pre-emphasized
Ground	pin 5	Audio signal ground

Internal Adjustments

Inside the top cover are several adjustments that you may wish to make to match the transceiver to your operating requirements (the top cover can be removed as described on the next page). You can adjust the volume of the button beeper (relative to the front panel **VOL** control) by the **BEEP** trimmer, and medium and low power output levels by the **MID** and **LOW** trimmers if you have a VHF wattmeter. See the *Caution* box below.



Caution!

The other trimmers inside the front panel should not be adjusted without the proper test equipment. Doing so could degrade performance, or even damage the transceiver, and will void your warranty. Ask your Yaesu dealer for help if you need any other adjustments made.

Installation of Options

This section describes the installation procedures for the FRC-6 DTMF Pager and FTS-17A Tone Squelch Unit. These options are available from your Yaesu dealer.

The FRC-6 provides DTMF paging/selcall features using 3-digit DTMF station ID codes. Seven code memories store your ID code plus those of six frequently-called stations or groups. Control is provided through the front panel of the transceiver. See the "Operation" chapter for operational details.

The FTS-17A includes a decoder for 38 EIA standard subaudible CTCSS tones, programmable from the front panel of the FT-2400H. It provides silent monitoring of busy channels when activated by the ENCode/DECode Tone Squelch function.

- ❑ Disconnect the DC power cable, and referring to Figure 1, remove the four screws affixing the top cover (two on either side), and loosen the one on top from the back by

several turns. Lift the rear edge of the cover slightly, then remove it.

- ❑ Referring to Figure 2, note the accessory mounting locations. If installing the FTS-17A, remove the paper from the double-sided adhesive pad.
- ❑ Carefully align the pins with the white connectors on the board, and press the unit(s) into place. The FTS-17A goes over the smaller connector, and the FRC-6 over the larger one.
- ❑ The factory adjusts the output tone levels (the small trimmers accessible through the option boards) for the proper deviation, so they should require no further adjustment.
- ❑ Replace the top cover and four screws removed in the first step, and remember to tighten the screw at the back of the top panel from the rear.

Figure 1

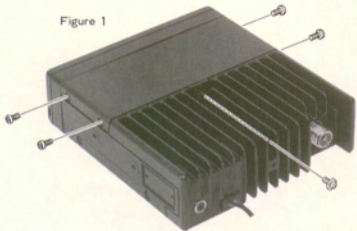
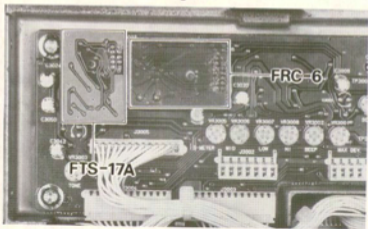
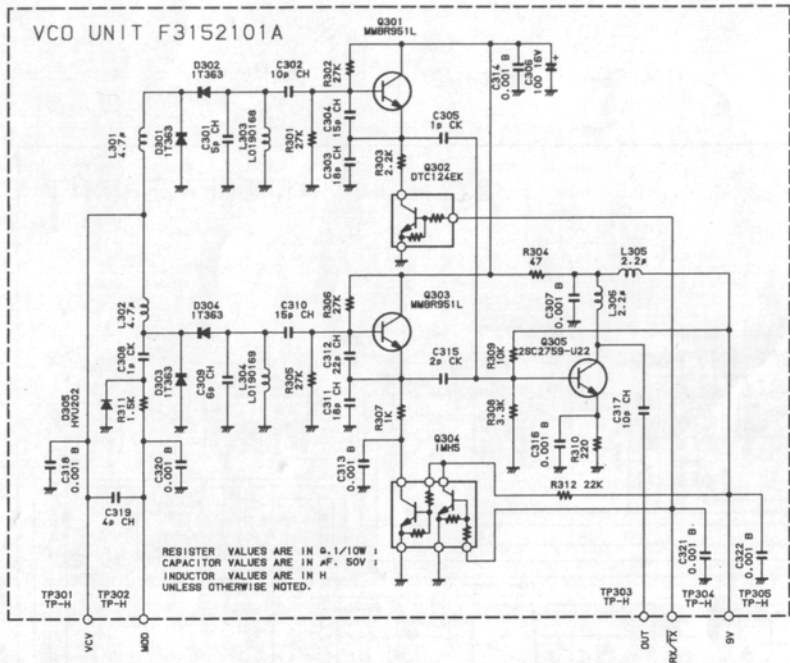

Figure 2



VCO UNIT F3152101A



MIC-UNIT

F3227102

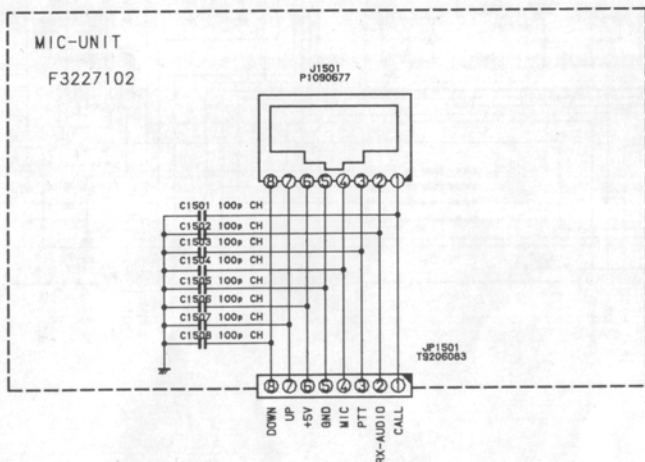

MAIN UNIT

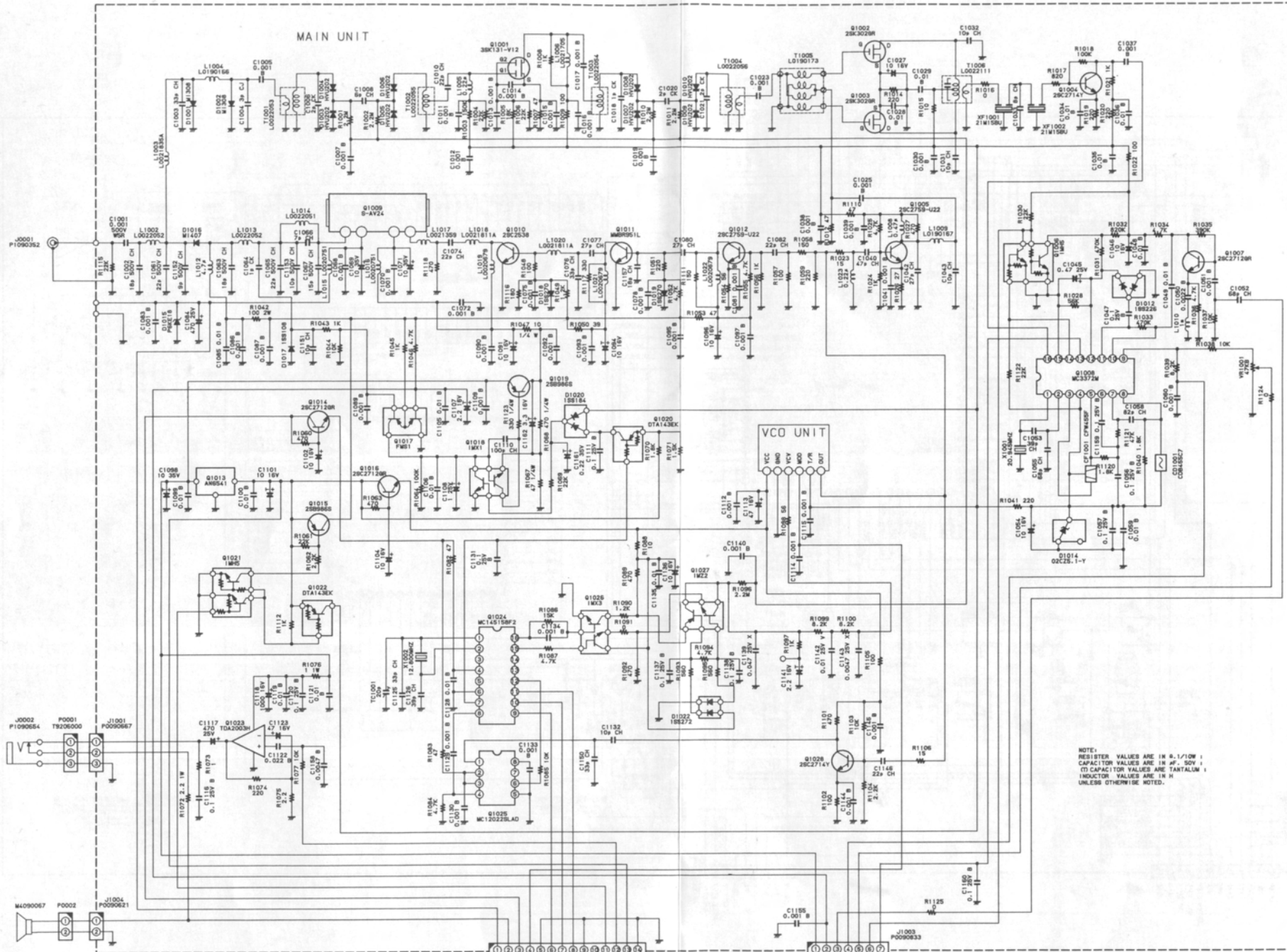

VCO UNIT

NOTE:
RESISTOR VALUES ARE IN Ω , 1/ Ω , 10 Ω ,
CAPACITOR VALUES ARE IN μ F, 50V,
IF CAPACITOR VALUES ARE IN μ F, 50V,
INDUCTOR VALUES ARE IN H
UNLESS OTHERWISE NOTED.

J0002 P1090654 P0001 T9205000

M4090067 P0002 J1004 P0090621

J1005 P0090627
13.8 V BND
AF BP
AF 5V
BND
BND
CLOCK
DATA
LE ENAB
MC BND
MC 1/4
AF 5V
BND

J1003 P0090633
13.8 V BND
V/A/V
NOISE INPUT
DISE OUT
50 VV
SCAN STOP
B-METER

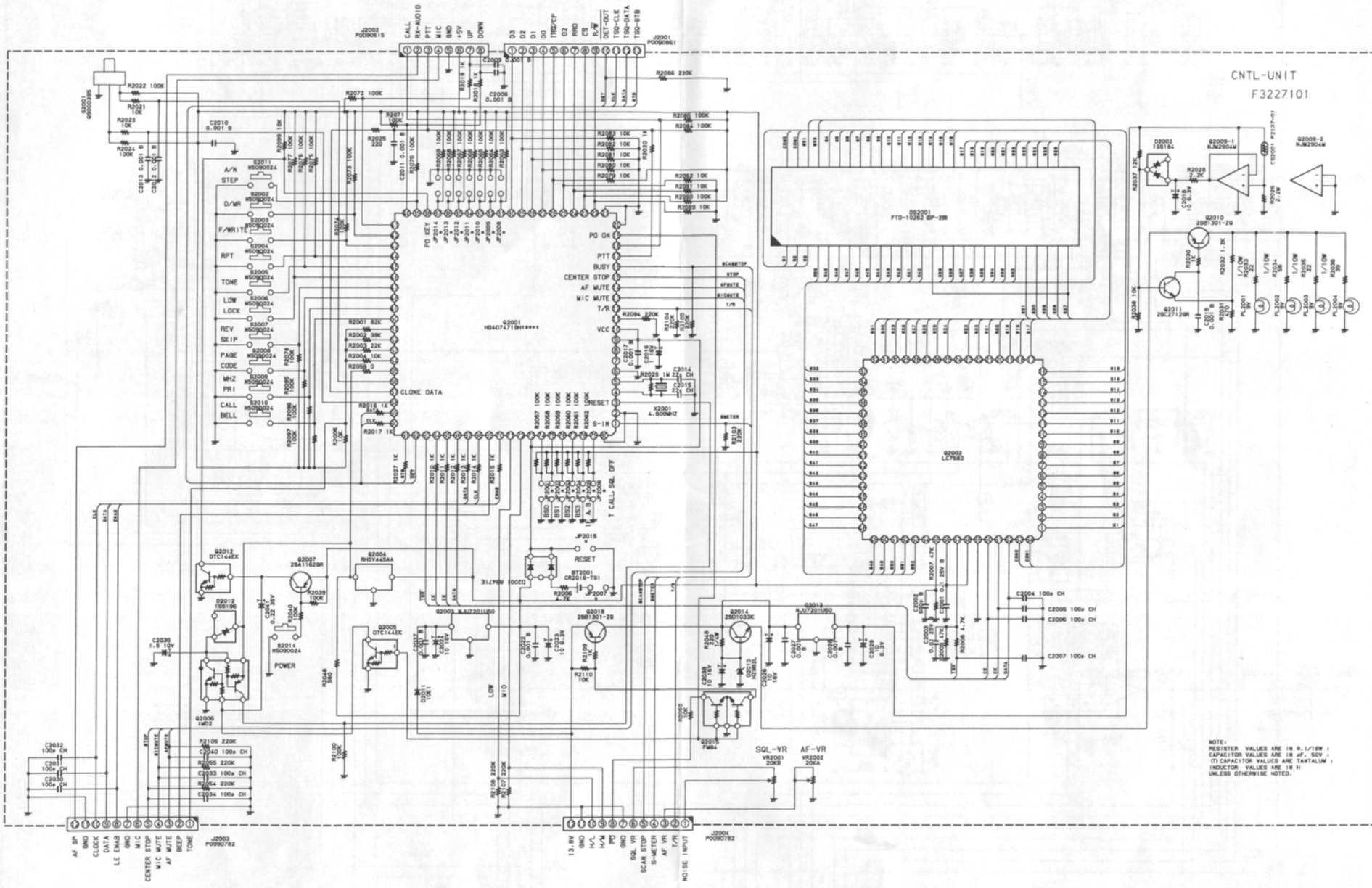

CNTL-UNIT
F3227101

NOTE:
RESISTOR VALUES ARE IN Ω , 1/10W ;
CAPACITOR VALUES ARE IN μ F, 50V ;
(T) CAPACITOR VALUES ARE TANTALUM ;
INDUCTOR VALUES ARE IN H
UNLESS OTHERWISE NOTED.