

Signal Generators

2018A and 2019A

(80 kHz - 520 MHz)
Code No. 52018-910P
and combination versions
in 2018-400 series
from 52018-401R
to 52018-413N

(80 kHz - 1040 MHz)
Code No. 52019-910E
and combination versions
in 2019-400 series
from 52019-401L
to 52019-413P

© Marconi Instruments Ltd. 1984
Printed in the UK

Part No. 46881-511A
Print code : F-10/86, MI 6.0c

CONTENTS

PRELIMINARIES

Title page
Contents
Notes and cautions



CHAPTERS

- 1 General information
- 2 Installation
- 3 Operation
- 4 Technical description
- 5 Maintenance
- 6 Replaceable parts
- 7 Servicing diagrams
- 8 Modifications and supplements

} These chapters are contained in a separate volume available as an optional extra.

HAZARD WARNING SYMBOLS

The following symbols appear on the equipment.

Symbol	Type of hazard	Reference in manual
	Static sensitive device	Page (iv)
	Component containing beryllia	Page (iv)

Note ...

Each page bears the date of the original issue or the code number and date of the latest amendment (Am. 1, AM. 2 etc.). New or amended material of technical importance introduced by the latest amendment is indicated by triangles positioned thus ►.....◄ to show the extent of the change. When a chapter is reissued the triangles do not appear.

Any changes subsequent to the latest amendment state of the manual are included on inserted sheets coded C1, C2 etc.

NOTES AND CAUTIONS

ELECTRICAL SAFETY PRECAUTIONS

This equipment is protected in accordance with IEC Safety Class 1. It has been designed and tested according to IEC Publication 348, 'Safety Requirements for Electronic Measuring Apparatus', and has been supplied in a safe condition. The following precautions must be observed by the user to ensure safe operation and to retain the equipment in a safe condition.

Defects and abnormal stresses

Whenever it is likely that protection has been impaired, for example as a result of damage caused by severe conditions of transport or storage, the equipment shall be made inoperative and be secured against any unintended operation.

Removal of covers

Removal of the covers is likely to expose live parts although reasonable precautions have been taken in the design of the equipment to shield such parts. The equipment shall be disconnected from the supply before carrying out any adjustment, replacement or maintenance and repair during which the equipment shall be opened. If any adjustment, maintenance or repair under voltage is inevitable it shall only be carried out by a skilled person who is aware of the hazard involved.

Note that capacitors inside the equipment may still be charged when the equipment has been disconnected from the supply. Before carrying out any work inside the equipment, capacitors connected to high voltage points should be discharged; to discharge mains filter capacitors, if fitted, short together the L (live) and N (neutral) pins of the mains plug.

Mains plug

The mains plug shall only be inserted in a socket outlet provided with a protective earth contact. The protective action shall not be negated by the use of an extension lead without protective conductor. Any interruption of the protective conductor inside or outside the equipment is likely to make the equipment dangerous.

Fuses

Note that there is a supply fuse in both the live and neutral wires of the supply lead. If only one of these fuses should rupture, certain parts of the equipment could remain at supply potential.

To provide protection against breakdown of the supply lead, its connectors, and filter where fitted, an external supply fuse (e.g. fitted to the connecting plug) should be used in the live lead. The fuse should have a continuous rating not exceeding 6 A.

Make sure that only fuses with the required rated current and of the specified type are used for replacement. The use of mended fuses and the short-circuiting of fuse holders shall be avoided.

RADIO FREQUENCY INTERFERENCE

This equipment conforms with the requirements of IEC Directive 76/889 as to limits of r.f. interference.

CAUTION : STATIC SENSITIVE COMPONENTS

Components identified with the symbol Δ on the circuit diagrams and/or parts lists are static sensitive devices. The presence of such devices is also indicated in the equipment by orange discs, flags or labels bearing the same symbol. Certain handling precautions must be observed to prevent these components being permanently damaged by static charges or fast surges.

(1) If a printed board containing static sensitive components (as indicated by a warning disc or flag) is removed, it must be temporarily stored in a conductive plastic bag.

(2) If a static sensitive component is to be removed or replaced the following anti-static equipment must be used.

A work bench with an earthed conductive surface.

Metallic tools earthed either permanently or by repeated discharges.

A low-voltage earthed soldering iron.

An earthed wrist strap and a conductive earthed seat cover for the operator, whose outer clothing must not be of man-made fibre.

(3) As a general precaution, avoid touching the leads of a static sensitive component. When handling a new one, leave it in its conducting mount until it is required for use.

(4) If using a freezer aerosol in fault findings take care not to spray programmable ICs as this may affect their contents.

CAUTION : LCD HANDLING

When operating or servicing this equipment take care not to depress the front or rear faces of the display module as this may damage the liquid crystal display elements.

WARNING : HANDLING HAZARDS

This equipment is formed from metal pressings and although every endeavour has been made to remove sharp points and edges care should be taken, particularly when servicing the equipment, to avoid minor cuts.

WARNING : TOXIC HAZARD

Many of the electronic components used in this equipment employ resins and other chemicals which give off toxic fumes on incineration. Appropriate precautions should therefore be taken in the disposal of these items.

▲ Beryllia (beryllium oxide) is used in the construction of the following components in this equipment :

Unit AC4 : Transistor TR10

.....

This material, when in the form of fine dust or vapour and inhaled into the lungs, can cause a respiratory disease. In its solid form, as used here, it can be handled quite safely although it is prudent to avoid handling conditions which promote dust formation by surface abrasion.

Because of this hazard you are advised to be very careful in removing and disposing of these components. Do not put them in the general industrial or domestic waste or despatch them by post. They must be separately and securely packed and clearly identified to show the nature of the hazard and then disposed of in a safe manner by an authorized toxic waste contractor.

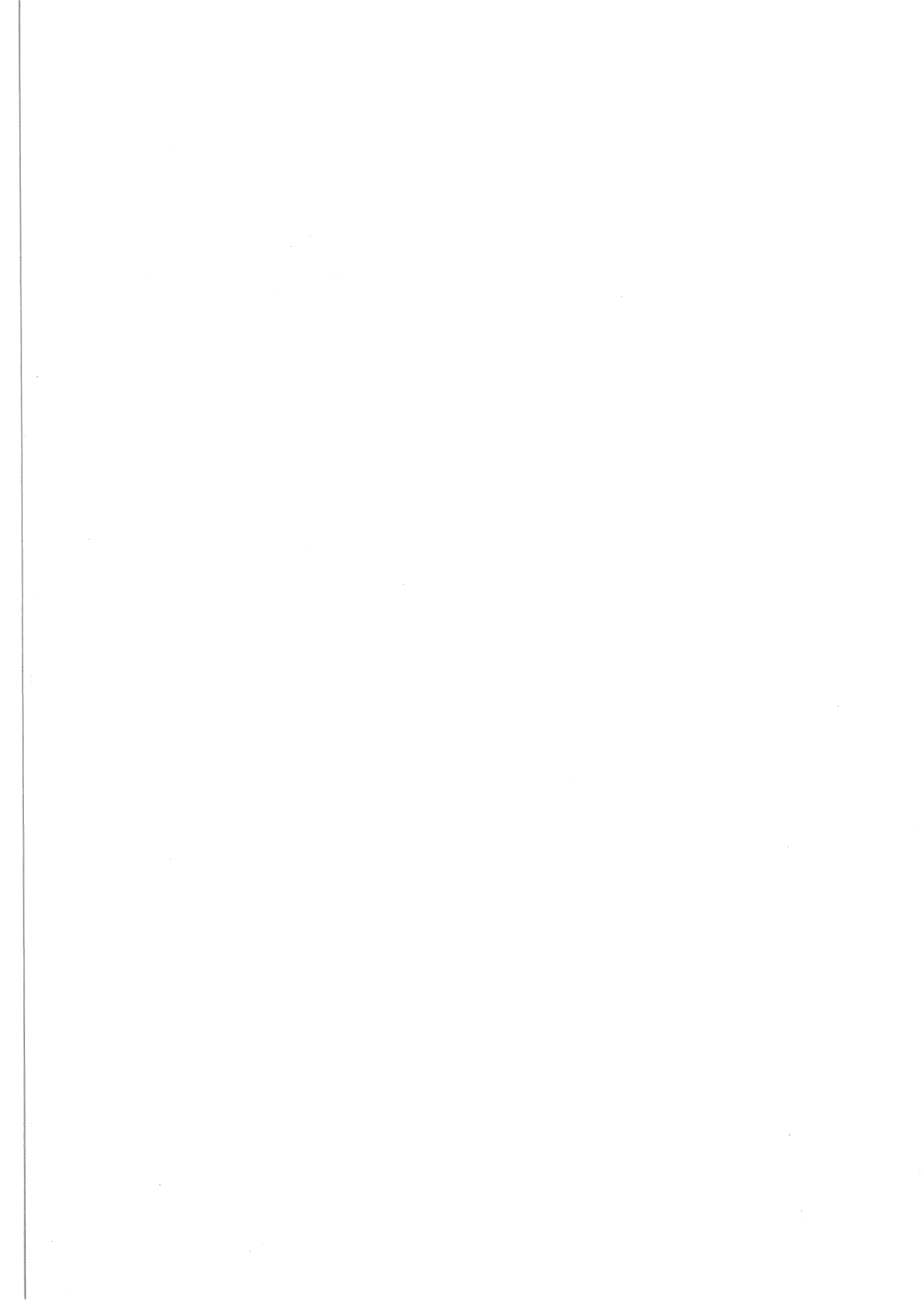

Chapter 1

GENERAL INFORMATION

CONTENTS

Para.	
1	Features
3	Output
4	Modulation
5	Front panel
7	Variants 2018A/2019A
8	Performance data
9	Carrier frequency 2018A/2019A
10	RF output 2018A/2019A
11	Spurious signals 2018A/2019A
12	Frequency modulation 2018A/2019A
14	Carrier frequency
15	RF output
16	Spurious signals
17	Frequency modulation
18	Phase modulation
19	Amplitude modulation
20	Pulse modulation
21	AF oscillator
22	Frequency standard
23	Auxiliary inputs and outputs
24	Keyboard and displays
25	GPIB interface
26	Environmental
27	Safety
28	Radio frequency interference
29	Power requirements
30	Weight and dimensions
31	Accessories
31	Supplied accessories
32	Optional accessories

Fig.		Page
1	80 kHz to 1040 MHz AM/FM Synthesized Signal Generator 2019A	2

FEATURES

1. 2018A and 2019A are stable, a.m./f.m. synthesized signal generators. 2018A covers the frequency range 80 kHz to 520 MHz. 2019A includes a frequency doubler which increases the frequency range to 1040 MHz. Both are phase locked to a frequency standard and can be set to a resolution of 10 Hz at frequencies up to 520 MHz, and in the case of 2019A resolution of 20 Hz for frequencies above 520 MHz.

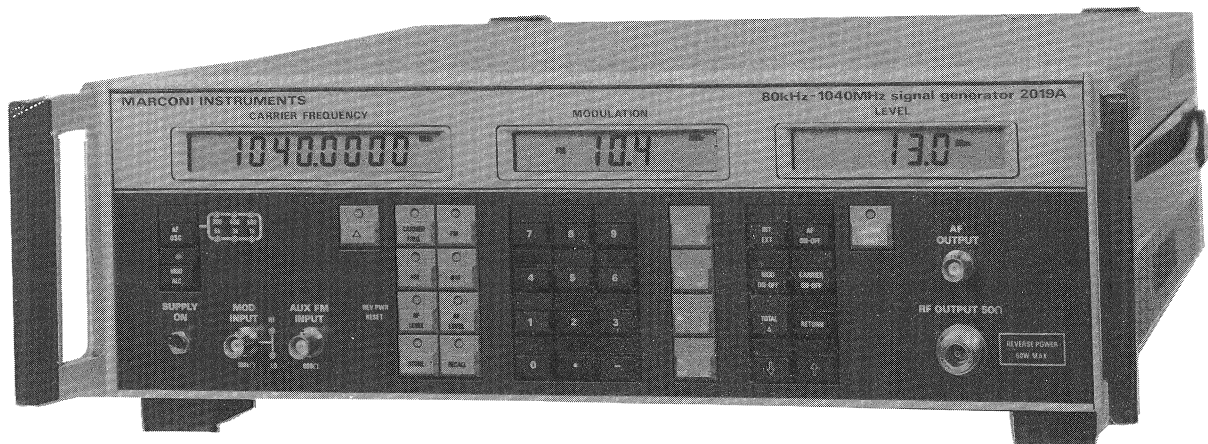

Fig. 1 80 kHz to 1040 MHz AM/FM Synthesized Signal Generator 2019A

2. Front panel operation is carried out by direct entry of required settings via the keyboard. Microprocessor control ensures maximum flexibility and allows programming by the General Purpose Interface Bus (GPIB).* This facility is offered as an optional accessory enabling the instrument to be used both as a manually operated bench mounted instrument or as part of a fully automated test system. Provision is also made for the use of either 1 MHz or 10 MHz external standard frequency reference when this is preferred.

Output

3. Calibrated output levels from -127 dBm to +13 dBm (0.2 μ V to 2 V e.m.f.) in the c.w., f.m., and ϕ .m. modes and up to +7 dBm (1 V e.m.f.) in the a.m. mode are provided. A choice of nine output level calibration units can be obtained on the front panel. The r.f. output level can be set to a resolution of 0.1 dB or better over the entire output voltage range and features a total cumulative accuracy of ± 1 dB up to 520 MHz (± 2 dB, 520 MHz - 1040 MHz). Protection against the accidental application of up to 50 W of reverse power is provided by a fast responding reed relay.

Modulation

4. Amplitude and frequency modulation can be carried out from either external or internal modulation sources. The internal modulation source provides six fixed modulation frequencies suitable for most normal applications.

*GPIB - Marconi Instruments General Purpose Interface Bus in accordance with IEEE Standard 488 - 1978 and IEC Publication 625-1 and BS 6146 Pt. 1.

Front panel

5. The instrument settings are displayed by three liquid crystal displays that include annunciators to show the units of the displayed data. All data is entered on a keyboard that has been designed to be simple and logical to use. Non-volatile store and recall facilities are also provided by using an electrically alterable read only memory store that does not require a battery back-up system. Carrier frequency, f.m., ϕ .m., a.m., r.f., and a.f. level functions may be incremented or decremented using the up/down keys.

6. Second function mode of operation. This includes the means of setting the GPIB address, selection of alternative r.f. level calibration units, access to various calibration routines, instrument running hours and an identity string that displays instrument type, software issue and serial number. Up to 32 ASCII characters may also be stored in non-volatile memory by the user via the GPIB bus. Modulation input level status information is also available via the GPIB bus if required.

Variants

7. Four individual variants are available in both 2018A and 2019A. A single option or a combination involving up to three of the four options may be fitted to the instrument, these are as follows:-

- (1) (Extended f.m.) bandwidth, stereo and digital signalling capability.
- (2) (Avionics) providing the capability for testing VOR & ILS.
- (4) (10 kHz Carrier) frequency extended range.
- (8) (Pulse Mod)ulation.

Single & Combination options

52018-	or 52019-	(1)	(2)	(4)	(8)
401R	401L	Extended f.m.	-	-	-
402B	402J	-	Avionics	-	-
403K	403F	Extended f.m.	Avionics	-	-
404A	404G	-	-	10 kHz Carrier	-
405Z	405V	Extended f.m.	-	10 kHz Carrier	-
408U	408D	-	-	-	Pulse Mod
409Y	409T	Extended f.m.	-	-	Pulse Mod
410E	410W	-	Avionics	-	Pulse Mod
411U	411D	Extended f.m.	Avionics	-	Pulse Mod
412Y	412T	-	-	10 kHz Carrier	Pulse Mod
413N	413P	Extended f.m.	-	10 kHz Carrier	Pulse Mod

Confirmation of the variant(s) fitted can be obtained by comparing the number on the identification plate affixed to the rear of the instrument and the above list.

PERFORMANCE DATA

8. The performance specifications for 2018A and 2019A are in most respects identical, therefore the following data applies to both instruments except where otherwise stated. Other variants having different parameters are specified only where a more limiting parameter applies. Where a combination of options causes a parameter to be specified more than once then the more limiting parameter will apply. Alternative parameter information that is specific to a variant is shown in bold type.

Characteristic	Performance	
	<u>2018A version</u>	<u>2019A version</u>
<u>Carrier frequency</u>		
9. Range:	80 kHz to 520 MHz (usable down to 30 kHz).	80 kHz to 1040 MHz (usable down to 30 kHz).

AVIONICS VARIANTS

Range:	1.5 MHz to 520 MHz	1.5 MHz to 1040 MHz
--------	--------------------	---------------------

10 kHz CARRIER VARIANTS

Range:	10 kHz to 520 MHz	10 kHz to 1040 MHz
Resolution:	10 Hz up to 520 MHz	10 Hz up to 520 MHz 20 Hz from 520 MHz to 1040 MHz

RF output

10. Level accuracy: ± 1 dB	± 1 dB from 80 kHz to 520 MHz ± 2 dB from 520 MHz to 1040 MHz
--------------------------------	--

AVIONIC VARIANTS

Level accuracy: ± 2 dB from 1.5 MHz to 5 MHz	± 2 dB from 1.5 MHz to 5 MHz
± 1 dB from 5 MHz to 520 MHz	± 1 dB from 5 MHz to 520 MHz
± 2 dB from 520 MHz to 1040 MHz	± 2 dB from 520 MHz to 1040 MHz

10 kHz CARRIER VARIANTS

Level accuracy: ± 1 dB from 10 kHz to 520 MHz	± 1 dB from 10 kHz to 520 MHz
± 2 dB from 520 MHz to 1040 MHz	± 2 dB from 520 MHz to 1040 MHz

Characteristic

Performance

2018A version

2019A version

PULSE MOD VARIANTS

Level accuracy:
(With pulse mod
not selected)

±1 dB from 80 kHz
to 520 MHz

±1 dB from 80 kHz to 520 MHz
±3 dB from 520 MHz to 1040 MHz

Level accuracy
(With pulse mod
selected and +5V
applied to input,
i.e. Carrier on)

±1.5 dB from 10 MHz
to 520 MHz

±1.5 dB from 10 MHz to 520 MHz
±4.5 dB from 520 MHz to 1040MHz

Note ...

With pulse mod selected the maximum output
level is reduced to +3 dBm.

VSWR:
(for output levels
below 300 mV
e.m.f.)

<1.2:1

<1.2:1, up to 520 MHz,
<1.5:1, 520 MHz to 1040 MHz

Spurious signals

11. Harmonically
related signals:
for output levels
<1 V e.m.f.)

<-30 dBc for
carrier fre-
quencies from
80 kHz to 520 MHz

<-30 dBc for carrier frequencies
from 80 kHz to 520 MHz
<-20 dBc for carrier frequencies
from 520 MHz to 1040 MHz.

Sub-harmonics

None

<-20 dBc for carrier frequencies
from 520 MHz to 1040 MHz.

Frequency modulation

12. Resolution

3 digits or 10 Hz (which-
ever is the larger) up
to 520 MHz.

3 digits or 10 Hz (which-
ever is the larger) up to
520 MHz.
3 digits or 20 Hz (which-
ever is the larger) up to
1040 MHz.

Characteristic

Performance

13. The remaining characteristics are common to both 2018A and 2019A.

Carrier frequency

14. Selection: By keyboard entry.

Frequency indication: 8 digit l.c.d. - for details see under Keyboard and displays.

Accuracy: Equal to the frequency standard accuracy - see under Frequency standard.

RF output

15. Level: 0.2 μ V to 2 V e.m.f. (-127 to +13 dBm) in c.w. and f.m. modes.
0.2 μ V to 1 V e.m.f. (-127 to +7 dBm) when a.m. is selected.

Selection: By keyboard entry - units may be μ V, mV, V, e.m.f. or p.d. or dB relative to 1 μ V, 1 mV, 1 V, e.m.f. or p.d. or dBm.

Conversion between dB and voltage units may be achieved by pressing the appropriate unit key (dB or V, mV, μ V).

Display: 4 digit l.c.d. with units annunciators - see under Keyboard and displays.

Resolution: 0.1 dB or better over entire voltage range.

Output impedance: 50 Ω , Type N female socket to MIL 39012/3D.

Reverse power protection: An electronic trip protects the generator output against reverse power of up to 50 W from d.c. to 1 GHz. The trip may be reset from the front panel or via the GPIB.

Spurious signals

16. Non-harmonically related signals: <-70 dBc at offset frequencies greater than 3 kHz for carrier frequencies from 2.03126 MHz to 1040 MHz.
<-60 dBc at offset frequencies greater than 3 kHz for carrier frequencies from 80 kHz to 2.03125 MHz.

Characteristic	Performance
Residual f.m.:	Less than 6 Hz r.m.s. in CCITT telephone psophometric band at 520 MHz and improving by approximately 6 dB/octave with reducing carrier frequency down to 2.03126 MHz.
Single side band phase noise:	Better than -130 dBc/Hz at 90 MHz and 20 kHz offset from carrier.
RF leakage:	Less than 0.5 μ V p.d. generated in a 50 Ω load by a 2 turn 25 mm loop, 25 mm or more from the case of the generator with the output level set to less than -10 dBm and the output terminated in a 50 Ω sealed load.

Frequency modulation

17. Range:	(i) Peak deviation from 0 Hz to up to 1% of carrier frequency for carrier frequencies from 2.03126 MHz to 1040 MHz. (ii) Peak deviation from 0 Hz to 100 kHz for carrier frequencies up to 2.03125 MHz.
Selection:	Internal modulation oscillator or external modulation input may be selected by the front panel keyboard.
Display:	3 digit l.c.d. - see under keyboard and displays.
Deviation accuracy:	\pm 5% of deviation at 1 kHz modulating frequency excluding residual f.m.
Frequency response:	\pm 1 dB from 50 Hz to 100 kHz relative to 1 kHz. Usable down to 10 Hz with reduced deviation.

EXTENDED FM VARIANTS

Frequency response:	\pm 1 dB from 50 Hz to 100 kHz relative to 1 kHz. Usable down to 1 Hz with reduced deviation. The instrument is suitable for testing receivers requiring signalling tones with a frequency modulation content down to 1 Hz. Settling time with FM on is up to approximately 5 seconds to be within 100 Hz of final frequency.
---------------------	--

Characteristic

Performance

Stereo separation:

Better than 50 dB at 1 kHz for carrier frequencies from 88 MHz to 108 MHz.

Typical separation:

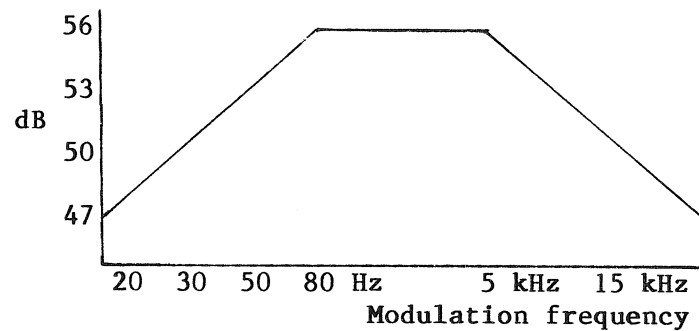

Distortion:

<3% total harmonic distortion at 1 kHz modulating frequency and a deviation of up to 70% of the maximum available at any carrier frequency.

<0.3% total harmonic distortion at 75 kHz deviation at carrier frequencies from 88 MHz to 108 MHz at 1 kHz internal modulating frequency or external source with a.l.c. off.

External modulation:

With modulation a.l.c. on, the deviation is calibrated for input levels between 0.8 V and 1.2 V p.d. With modulation a.l.c. off, the deviation is calibrated for an input level of 1 V p.d. HI or LO l.e.d's are provided as an aid to maintain calibrated modulation in the a.l.c. off mode. Input impedance is nominally 100 k Ω .

Phase modulation

18. Range:

Modulation index; 0 to 10 radians for carrier frequencies below 2.03125 MHz. 0 to a value in radians equal to the carrier frequency in MHz for carrier frequencies above 2.03125 MHz subject to a maximum available phase modulation index of 999 radians.

Selection:

Internal modulation oscillator or external modulation may be selected by the front panel keyboard.

Display:

3 digit l.c.d - see under keyboard and display.

Frequency response:

50 Hz to 10 kHz \pm 1 dB w.r.t. to 1 kHz.

Accuracy:

\pm 5% excluding residual phase modulation.

Characteristic

Performance

External modulation: With modulation a.l.c. on, the deviation is calibrated for input levels between 0.8 V and 1.2 V p.d. With modulation a.l.c. off, the deviation is calibrated for an input level of 1 V p.d. HI or LO l.e.d's are provided as an aid to maintain calibrated modulation in the a.l.c. off mode. Input impedance is nominally 100 k Ω .

Distortion: <3% total harmonic distortion at 1 kHz modulating frequency and at maximum deviation (equal to the carrier frequency in MHz) at any carrier frequency.

Amplitude modulation

19. Range: 0 to 99% in 1% steps.

Selection: Internal modulation oscillator or external modulation input may be selected.

Display: 2 digit l.c.d. - see under keyboard and display.

Accuracy: Better than \pm (4% of depth setting +1%) for modulation depths up to 95% and 1 kHz modulating frequency for carrier frequencies up to 400 MHz.

Frequency response: \pm 1 dB from 20 Hz to 50 kHz relative to 1 kHz at 80% depth d.c. coupled.

10 kHz CARRIER VARIANTS

Frequency response: At 10 kHz carrier frequency AM is usable with up to 1 kHz mod. rate.

Envelope distortion: Less than 3% total harmonic distortion for modulation depths up to 80% at 1 kHz modulating frequency for carrier frequencies up to 400 MHz.
Less than 2% total harmonic distortion for modulation depths up to 90% at 1 kHz modulating frequency for carrier frequencies up to 32 MHz.

AVIONICS VARIANTS

ILS performance: <0.045% a.m. difference in depth of modulation for ILS tones at 90 Hz and 150 Hz each at 40% modulation depth.

Characteristic

Performance

External modulation input:

With the modulation a.l.c. on, the modulation depth is calibrated for input levels between 0.8 V and 1.2 V p.d. With the modulation a.l.c. off, the modulation depth is calibrated for an input level of 1 V p.d. HI or LO l.e.d's are provided as an aid to maintain calibrated modulation in the a.l.c. off mode. Input impedance is nominally 100 k Ω , d.c. coupled.

Pulse modulation

PULSE MOD VARIANTS

20. Carrier pulse response:

Rise time <100 ns
Fall time <100 ns

Carrier on/off ratio:

>65 dB at 70 MHz carrier frequency, reducing to
>50 dB at 520 MHz carrier frequency and then to
>35 dB at 800 MHz carrier frequency (usable to 1040 MHz)

Propagation delay pulse input to carrier pulse:

Typically 280 ns

Input:

Rear panel BNC connector
Input impedance 50 Ω
Nominal signal levels 0 V for carrier off, +5 V for carrier on

Selection and display:

Pulse modulation is selected by pressing the two keys [^{AM} PULSE ^{ϕ M} PULSE] simultaneously, followed by the MOD ON-OFF key. The modulation window then displays P and EXT.

AF oscillator

21. Frequencies:

300 Hz, 400 Hz, 500 Hz, 1 kHz, 3 kHz and 6 kHz selected sequentially by repetitive pressing of the AF OSC key.

Display:

Six l.e.d's indicate selected frequency.

Frequency accuracy:

± 5 %

Internal AF OSC output:

A front panel BNC socket provides an output for the AF signal.

Characteristic	Performance
Output level selection:	0.1 mV to 5 V r.m.s., selected by keyboard entry. Output may be entered in mV, V or as dBm into 600 Ω . Conversion between dB and voltage units may be achieved by pressing the appropriate key (dB,mV,V). The output frequency is always that of the AF OSC and is short circuit proof. At switch-on the AF level is set to 1 V.
Output level accuracy:	$\pm 5\%$ above 50 mV r.m.s. $\pm 10\%$ from 0.5 mV to 50 mV r.m.s.
Maximum output:	Capable of driving a 2 k Ω load for output levels up to 5 V r.m.s. Capable of driving a 600 Ω load for output levels up to 2 V r.m.s.
Distortion	Less than 0.1% total harmonic distortion for a 1 kHz output frequency at an audio level of 5 V r.m.s. into 100 k Ω .
Source impedance	<10 Ω

Frequency standard

22.	Internal or external frequency standard may be selected from the front panel. Either 1 MHz or 10 MHz standard may be selected by second function control. Annunciators show which is selected.
Frequency standard Input/ Output:	A rear panel BNC socket provides an output from the internal frequency standard at either 1 or 10 MHz when internal standard is selected. This socket becomes the external standard input when external standard is selected.
Internal standard:	High stability, oven controlled 10 MHz crystal oscillator.
Temperature stability:	< ± 0.1 p.p.m. over temperature range of 0 to 40 $^{\circ}$ C.
Warm-up time:	Within 0.5 p.p.m. of final frequency within 5 minutes from switch on at an ambient temperature of 20 $^{\circ}$ C.

Characteristic	Performance
Internal standard output:	Either 1 or 10 MHz, nominally 3 V p-p square wave may be selected by second function control. Source impedance 100 Ω nominal.
External standard input:	Accepts 1 MHz or 10 MHz of at least 1 V r.m.s. Maximum recommended input level, 2.5 V r.m.s. Input impedance is nominally 100 Ω .

Auxiliary inputs and outputs

23. Modulation input:	A front panel BNC socket accepts an external modulation input. The input signal may be levelled by selecting the MOD ALC ON/OFF key. Two l.e.d. indicators, HI and LO provide an aid to maintain calibrated modulation in the a.l.c. off mode.
External modulation input :	ALC ON; Input level nominally 1 V r.m.s. into 100 k Ω - see under Frequency modulation and Amplitude modulation. ALC OFF; 1 V r.m.s. is required for calibrated conditions. When the HI and LO l.e.d's are extinguished the input voltage will be within the range 1 V \pm 5%.
Auxiliary FM input:	The auxiliary FM input can be used to add sub-audio tones to the main modulation set. The input is enabled whenever FM or ϕ M is selected and is independent of whether the instrument is set to internal or external modulation.
Deviation	With the FM on (INT or EXT) the application of 1 V r.m.s. to the AUX FM INPUT will result in an f.m. deviation of 10% of that indicated in the modulation display. With ϕ .m. selected (INT or EXT) the application of 1 V r.m.s. will result in an f.m. deviation in kHz equal to the phase deviation in radians shown in the modulation display.
Accuracy	\pm 15%.
Impedance	600 Ω . This facility is intended to allow the insertion of signalling tones used in receiver testing.

Characteristic	Performance
Frequency standard input/output:	A rear panel BNC socket provides an output from the internal frequency standard when internal standard is selected and becomes the external standard input when external standard is selected. The choice of 1 MHz or 10 MHz reference standard may be made by a second function control.
Internal standard output:	1 MHz or 10 MHz at nominally 3 V p-p square wave. Source impedance 100 Ω nominal.
External standard input:	Accepts either a 1 MHz or 10 MHz signal of at least 1 V r.m.s. Maximum recommended input level 2.5 V r.m.s. Frequency selected by second function control. Input impedance 100 Ω nominal.
Alternative RF and modulation sockets	Blanked holes are provided so that the RF output and modulation input socket can be fitted to the rear panel for systems use etc.

Keyboard and displays .

24. Main and secondary keyboard functions:

These are described in Chap. 3, Operation. All instrument settings are controlled by the front panel keyboard.

Displays:

The main function of the three liquid crystal displays is to provide a simultaneous readout of carrier frequency, modulation and r.f. level.

- (i) Carrier frequency display - 8 digit with annunciators to show frequency units, external frequency standard, frequency limit exceeded, remote operation selected and instrument addressed.
- (ii) Modulation display - 3 digit with annunciators to show modulation units, f.m., ϕ .m., a.m., modulation off, external modulation selected, and modulation limit exceeded.
- (iii) RF level display - 4 digit with annunciators to show r.f. level units, r.f. output off, reverse power trip operated, and r.f. level limit exceeded and a.f. level units.

Characteristic

Performance

GPIB interface

25.

A GPIB interface is available as an optional accessory and can be easily fitted by the user. All functions except the SUPPLY ON switch are remotely programmable. In addition to allowing full GPIB control of the instrument, the GPIB module has an auxiliary output socket which can be used to control relays etc.

Capabilities:

Complies with the following subsets as defined in IEEE 488 - 1978 and IEC Publication 625-1: SH1, AH1, T6, TEO, L4, LEO, SR1, RL1, PPO, DC1, DTO, CO, E1.

Environmental

26. Conditions of storage and transport

Temperature: -40⁰C to +70⁰C.

Humidity: Up to 90% relative humidity.

Altitude: Up to 2500 m (pressurized freight at 27 kPa differential i.e. 3.9 lbf/in²).

Rated range of use
(Over which full
specification is met)
Temperature:

0 to 55⁰C.

Safety

27.

Complies with Publication IEC 348.

Radio frequency interference

28.

Conforms to the requirements of EEC Directive 76/889 as to limits of r.f. interference.

Power requirements

29. Voltage

AC supply. Voltage ranges (switchable)

105 V - 120 V
210 V - 240 V } ±10%

Frequency: 45 Hz - 440 Hz.

Consumption: 85 VA maximum.

Characteristic	Performance
<u>Weight and dimensions</u> (over projections but excluding optional front panel handles).	
30. Height:	152 mm (6 in).
Width:	425 mm (16.7 in).
Depth:	525 mm (20.7 in).
Weight:	16 kg (35.2 lb).

ACCESSORIES**Supplied accessories**

31. AC supply lead	Code no.
Operating manual H 52018-910P (Vol. 1)	43123-076Y
Front panel blanking kit	46881-511A
	46883-654E

Optional accessories

32. Service manual H 52018-910P (Vol. 2)	46881-512Z
GPIB module	54433-001U
Maintenance kit, includes r.f. extender cables, l.c.d. insertion and extraction tools etc.	54711-033E
Rack mounting kit	46883-506M
Front handle kit	46883-511R
GPIB manual H 54811-010P (Contains details of general GPIB protocols)	46881-365R
GPIB lead assy.	43129-189U
GPIB IEEE/IEC connector adapter	46883-408K
RF connecting cable TM 4969/3; 50 Ω , 1.5 m (5 ft) BNC	43126-012S
RF coaxial cable (N to N type)	54311-095C
Impedance adapter 50/75 Ω	54411-051X

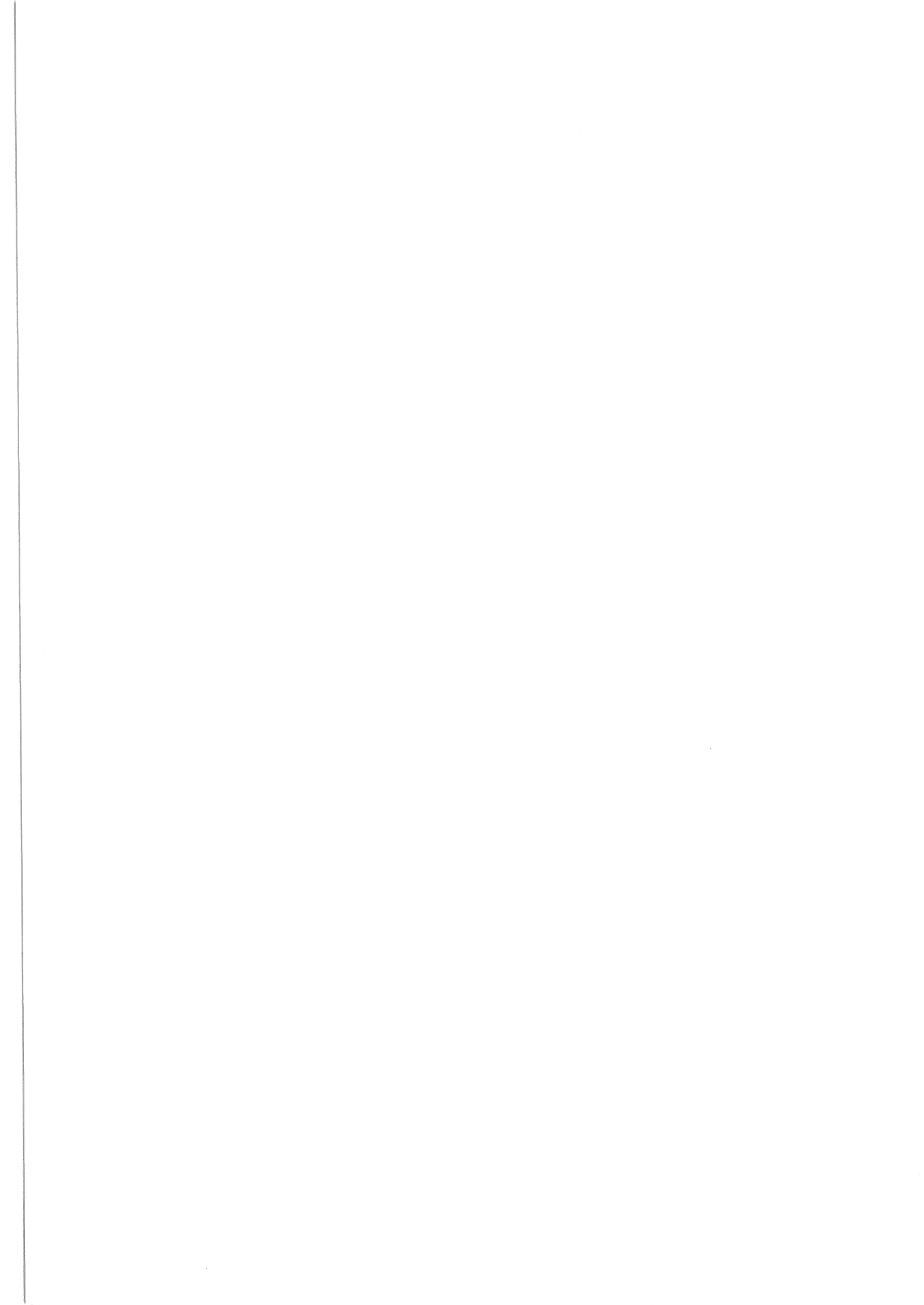

Chapter 2

INSTALLATION

CONTENTS

Para.

- 1 Unpacking and repacking
- 3 Mounting arrangements
- 4 Connecting to supply
- 6 Safety testing
- 7 GPIB interface
- 8 Rack mounting
- 9 Front panel handles

Fig.

1 Voltage ranges	Page
	3

UNPACKING AND REPACKING

1. Retain the container, packing material and the packing instruction note (if included) in case it is necessary to reship the instrument.

2. If the instrument is to be returned for servicing attach a label indicating the service required, type or model number (on rear label), serial number and your return address. Pack the instrument in accordance with the general instructions below or with the more detailed information in the packing instruction note.

(1) Place supply lead in suitable plastic bag and tape it to the instrument rear panel.

(2) Place the instrument within its plastic cover.

(3) Ensure that the padded fitting is in place within the inner carton and slide the instrument in, rear panel first, leaving the front panel exposed at the open end.

(4) Fit the separate front panel protecting cover over the panel and close and seal the inner carton.

(5) Place one of the moulded plastic cushions in the bottom of the outer carton and insert the inner carton to locate in the cushion recess.

(6) Place the other plastic cushion over the other end of the inner carton and close and seal the outer carton.

(7) Wrap the container in waterproof paper and secure with adhesive tape.

(8) Mark the package FRAGILE to encourage careful handling.

Note ...

If the original container or materials are not available, use a strong double-wall carton packed with a 7 to 10 cm layer of shock absorbing material around all sides of the instrument to hold it firmly. Protect the front panel controls with a plywood or cardboard load spreader; if the rear panel has guard plates or other projections a rear load spreader is also advisable.

MOUNTING ARRANGEMENTS

3. Excessive temperatures may affect the instrument's performance; therefore, completely remove the plastic cover, if one is supplied over the case, and avoid standing the instrument on or close to other equipment that is hot.

CONNECTING TO SUPPLY

4. Before connecting the instrument to the a.c. supply check the position of the two voltage selector switches on the rear panel. A locking plate fixes both switches into one of four possible combinations and only the selected voltage range is displayed when the locking plate is fixed to the back panel. The instrument is normally despatched with the switches selected to 230/240 V. To select a different voltage range remove the locking plate and re-position the switches to the required range as shown in Fig. 1 below and refit the locking plate into its alternative position.

Note ...

The a.c. supply fuse may also have to be changed. An indication of the correct fuse rating is given with each displayed voltage range:-

i.e. 1 A-T (1 amp time lag)	105 V - 120 V \pm 10%
0.5 A-T (0.5 amp time lag)	210 V - 240 V \pm 10%

The fuses are 20 mm x 5 mm cartridge type.

5. The free a.c. supply cable is fitted at one end with a female plug which mates with the a.c. connector at the rear of the instrument. When fitting a supply plug ensure that conductors are connected as follows:

Earth	-	Green/yellow
Neutral	-	Blue
Live	-	Brown

When attaching the supply lead to a non-soldered plug it is recommended that the tinned ends of the lead are first cut off owing to the danger of cold flow resulting in intermittent connections.

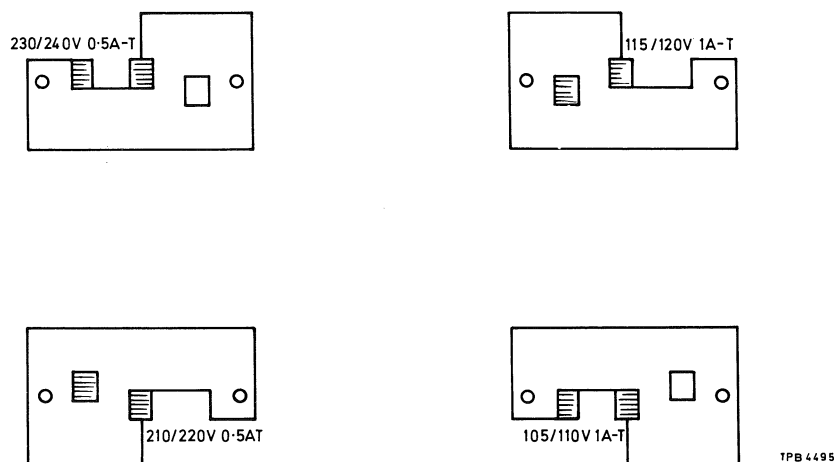

Fig. 1 Voltage ranges (alternative switch and locking plate positions)

SAFETY TESTING

6. Where safety tests on the a.c. supply input circuit are required, the following procedures can be applied. These comply with BS 4743 and IEC Publication 348. Tests are to be carried out as follows and in the order given, under ambient conditions, to ensure that a.c. supply input circuit components and wiring (including earthing) are safe.

(1) Earth lead continuity test from any part of the metal frame to the bared end of the flexible lead for the earth pin of the user's a.c. supply plug. Preferably a heavy current (about 25 A) should be applied for not more than 5 seconds.

Test limit : not greater than 0.5 Ω .

(2) 500 V d.c. insulation test from the a.c. supply circuit to earth.

Test limit : not less than 2 M Ω .

GPIB INTERFACE

7. The GPIB interface is an optional accessory and can easily be fitted by the user as follows:-

(1) Remove and discard the rectangular cover plate from the left-hand side of the rear panel.

(2) Withdraw the interconnecting lead from inside the instrument and connect this to the GPIB assembly taking care that the ribbon cable connector SKAK is correctly aligned with GPIB module connector PLAK.

(3) Switch instrument on temporarily and check that the front panel displays data correctly. If satisfactory switch off and continue with step (4). If display is corrupted however then re-check the alignment of SKAK and PLAK as indicated in step (2).

(4) Using the four retaining screws provided, secure the GPIB assembly to the rear panel where four pre-positioned captive nuts are fitted. The interface is now ready for GPIB operation.

RACK MOUNTING

8. The instrument may be mounted in a standard 19 inch rack using the kit 46883-506M available as an optional accessory. Fitting instructions are as follows:-

- (1) Remove both top and bottom outer covers, detach and discard front and rear feet on bottom cover.
- (2) Detach and discard side trim infills, countersunk screws and screw cups.
- (3) If it is desired to have the r.f. output and modulation input sockets on the rear panel complete steps 4 to 10. If rear panel connections are not required proceed to step 11.
- (4) Remove the front panel assembly by slackening the two screws exposed in each side and lay face down protecting the l.c.d's.
- (5) Disconnect the semi-rigid coaxial plug PLAV situated at the rear of the top r.f. box and remove the four r.f. box securing screws (one in each corner bracket); raise the box into the servicing position.
- (6) Unsolder the yellow and orange wires from the front panel MOD-IN socket and adjacent earth tag. Unfasten and remove the socket from the front panel mounting, remove and discard the blind grommet from the MOD-IN alternative rear panel position. Uncleat excessive modulation cableform from the lower r.f. box and re-route this to the rear panel. Refix MOD-IN b.n.c. socket to the rear panel position. Now reconnect the yellow wire to the MOD-IN socket and the orange wire to the adjacent earth point. Select a b.n.c. replacement blind grommet (issued with the included blanking kit) and fit this into the front panel position. Reclate the cable to the lower r.f. box.
- (7) Disconnect the r.f. output connector from SKBA on ATO/1 attenuator, and also the RF OUTPUT socket from the front panel assembly. Withdraw the connector and socket through the front panel. Similarly, remove the blind grommet from the alternative rear panel RF OUT position, discard this and fit the replacement 'N' type grommet (supplied in the blanking kit) into the front panel position.
- (8) Pass the r.f. output connector through the alternative rear panel position and secure the RF OUTPUT socket to the rear panel. Re-route the cable over the bottom r.f. box and reconnect SKBA to ATO/1 attenuator.
- (9) Lower the top r.f. box and secure this, reconnect PLAV to the rear of the box. Replace and secure the front panel assembly and side trim, also refit front handles if previously fitted.
- (10) Fit rack brackets in front panel handles or side trim recesses using M4 x 16 pan head screws and washers, finally refit top and bottom covers.

Note ...

When fitting the unit into the rack; support at the rear should also be given e.g. a shelf located within the rack or cubicle.

FRONT PANEL HANDLES

9. Front handles are supplied only as optional accessories, fitting instructions are as follows:-

(1) Remove the side trim infills and side trims. Discard the side trims but retain the side trim infills, screws and washers for re-use. Position the instrument on its side.

(2) Fit the panel handles without the side trim infills first, aligning all four screws. Tighten down the two inner screws and washers and remove the two outer screws.

(3) Refit the side trim infills, replace the outer two screws and washers and tighten down.

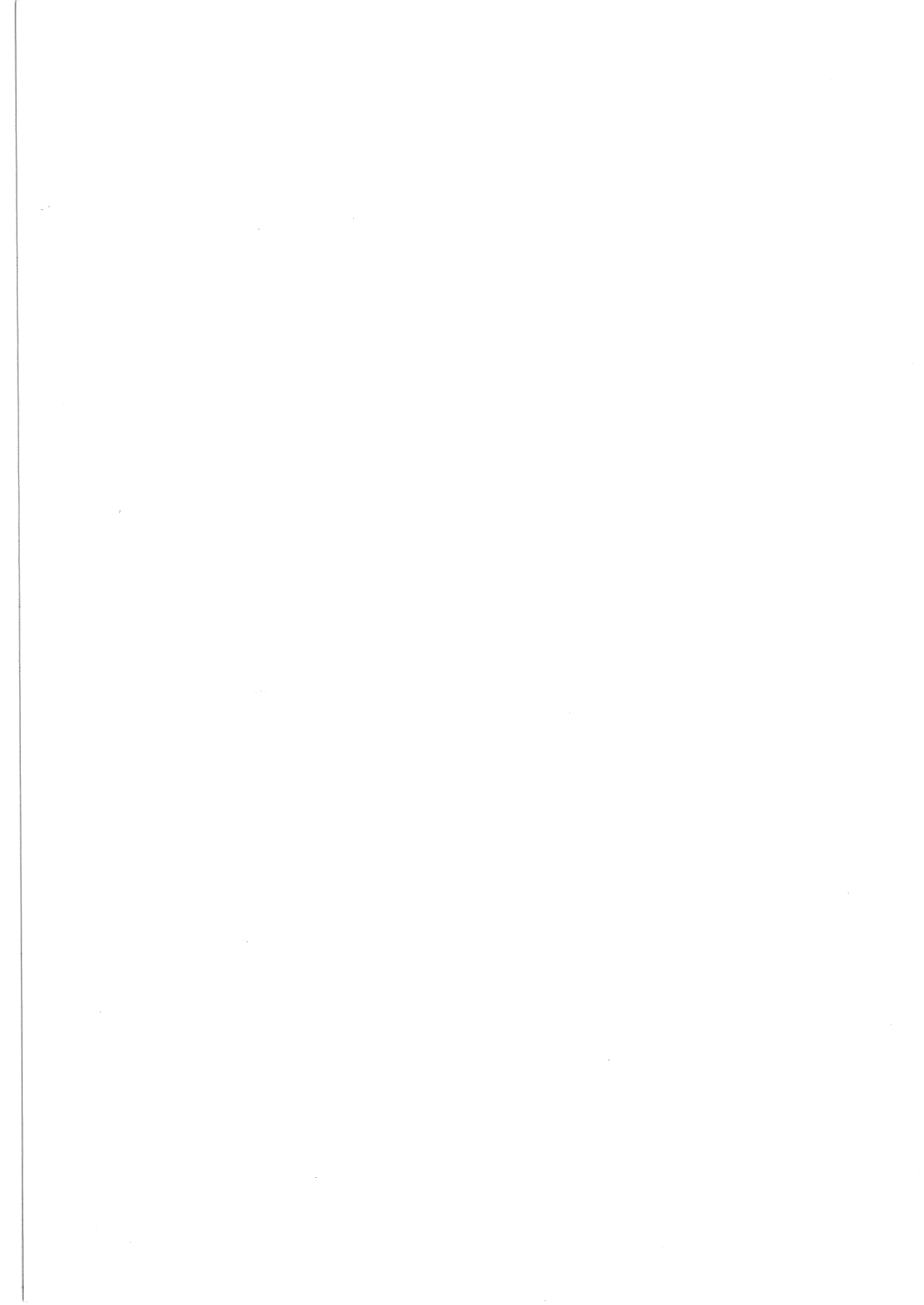

Chapter 3

OPERATION

CONTENTS

Para.	
1	Principles of control
2	Front panel control
3	Rear panel control
4	Preparation for use
4	Switching on
5	Operating procedures
6	Setting a carrier frequency
7	Incrementing and decrementing
8	Internal modulation source
9	Setting a.f. level
10	External modulation
11	Setting f.m.
12	Setting ϕ .m.
13	Auxiliary f.m. input socket
14	Setting a.m.
15	Setting r.f level
16	Setting pulse modulation
17	On-Off keys
18	Reverse power protection
19	Store and recall
23	Second function operations
25	Second function 0 'Unlock'
26	Second function 1 'Status'
27	Second function 2 'GPIB address setting'
28	Second function 3 'Manual latch setting'
29	Second function 4 'SRQ mask setting'
31	Second function 5 'RF level units setting'
32	Second function 6 'RF level offsets'
33	Second function 9 'Elapsed time display'
34	Second function 11 'Read identity string'
35	Second function 12 'Write user-definable string'
36	Second function 13 'Read user - definable string'
37	Second function 14 '1 or 10 MHz standard setting'
38	Second function 15 'Old /new GPIB command set'
39	Second function 16 'Recall STORE 10 at switch on'
40	Second function 18 'Set data on GPIB Aux. output pins'
41	Second functions 7,8,9,10,17,190,191 and 192, (Second level operation)
42	Operation with 75 Ω loads
43	General purpose interface (GPIB) functions
53	Setting the GPIB address
54	GPIB programming codes
55	Listening function
58	Talking function
62	SF1, QU Status string
63	SF11, QU Identity string
64	SF12, User string write facility
65	SF13, QU User string read facility
66	Service requests (SRQ)
67	Error numbers

continued ...

CONTENTS (continued)

Para.

68	SRQ mask
70	Reverse power protection
71	Clear, switch on, and return to local
72	Fast output facility (GPIB only)
73	GPIB connector contact assignments
74	GPIB auxiliary output facility

Table		Page
1	Modulation string (GPIB)	22
2	Frequency string (GPIB)	23
3	Levels string (GPIB)	23

Fig.		Page
1	Front panel controls	3
2	Rear panel controls	4
3	2018A Initial operating mode	5
4	2018A Second function '1' status mode	13
5	SRQ mask setting display	14
6	'Read Identity' display	16
7	GPIB auxiliary output plug and socket connections	18
8	GPIB connector contact assignments	27
9	2018A/2019A Simplified Block Diagram	28/29

PRINCIPLES OF CONTROL

1. All operations of the generator are carried out from the front panel keyboard which is divided into five distinct areas. Remote operation via a GPIB controller is possible if the optional GPIB interface is fitted. If an illegal operating condition is selected, either by local or remote control, this is indicated by a limit annunciator on the front panel display.

Front panel control

2. (1) SUPPLY switch. Applies the a.c. supply voltage.
- (2) AF OSC, MOD ALC. The two black keys control the internal modulation frequency and the modulation automatic level control. The MOD ALC key has an integral l.e.d. to indicate that selection has been made. When MOD ALC is selected a MOD input of between 0.8 - 1.2 V will be automatically levelled.
- (3) MOD INPUT (100 kΩ) socket. Accepts an input from an external modulation source. When the HI and LO l.e.d's are extinguished the input voltage will be within the range 1 V ±5%.
- (4) AUX FM INPUT socket. Enables the use of additional modulation tones either with internal or external modulation source applied. With 1 V r.m.s. applied the additional f.m. deviation produced is 10% of the f.m. display value.
- (5) Function keys. The nine orange keys each have an integral l.e.d. to indicate the function currently selected.

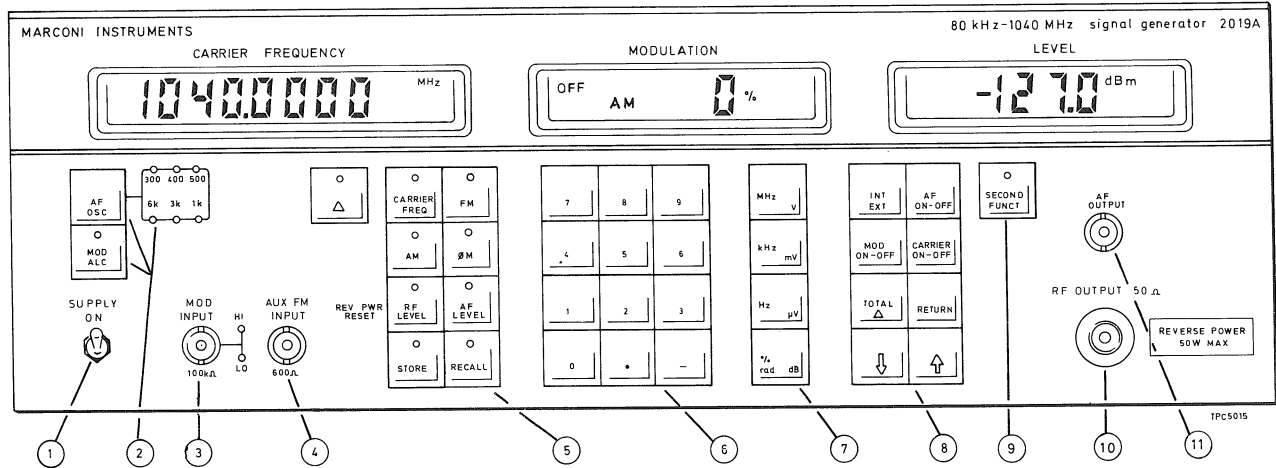

Fig. 1 Front panel controls

(6) Numerical keypad. Enters the required value for the function currently selected, includes a minus sign and a decimal point.

(7) Units. The four grey keys are used to terminate the numerical entry.

(8) Miscellaneous functions. This right-hand group of eight black keys is concerned with such operations as AF ON/OFF, INT/EXT, MOD ON/OFF, CARRIER ON/OFF, RETURN, DECREMENT (\downarrow down), INCREMENT (\uparrow up) and TOTAL Δ .

(9) SECOND FUNCT. This blue key with an integral l.e.d. is used to provide further less commonly used facilities.

(10) RF OUTPUT : 50 Ω N type output socket. Indication of the r.f. level is shown on the RF LEVEL display.

(11) AF OUTPUT. This is a low impedance output at the frequency selected by the internal AF OSC control and is available when either INT or EXT modulation is selected. This allows the testing of transceiver audio circuits (microphone inputs etc.).

Rear panel control

3. (1) REMOTE CONTROL GPIB INTERFACE. This optional accessory allows remote control of the instrument and in addition has an auxiliary output socket which can be used to control relays etc. Accepts the 24-way IEEE GPIB connector.

(2) MOD INPUT/RF OUT. These blanked holes provide alternative fittings when the instrument is rack mounted. Fitting instructions are included in Chap. 2.

(3) PULSE MOD IN. This blanked hole is used only if the pulse modulator option is fitted.

(4) STD FREQ IN-OUT. BNC socket provides an output from one of two possible internal reference standard frequencies (1 MHz or 10 MHz), or alternatively allows the use of a 1 MHz or 10 MHz external reference. The required function is selected by the front panel keys. If EXT STD

is selected when power is initially applied Error No.15 will be displayed in the carrier frequency window. After a delay of approximately one minute the external and internal frequencies will synchronize and the error number will be removed. Subsequent changes from INT and EXT when the instrument is at, or near, normal operating temperature can be made, without this delay.

(5) VOLTAGE SELECTOR switches, selects in a combination of four positions 105-110 V/115-120 V, or 210-220 V/230-240 V, each has a 10% tolerance to afford a complete cover over the voltage ranges 95 V-132 V and 190 V-264 V respectively.

(6) Selector switch plate. Secures the VOLTAGE SELECTOR switches into one of four pre-selected positions by either turning and/or reversing the plate before re-affixing to the rear panel.

(7) AC fuses. Supply input fuses are rated at 0.5 amp (slow-blow) for 190 V-264 V range or 1 amp (slow-blow) for the 95 V-132 V range.

(8) AC supply input. The a.c. supply is connected through this plug which mates with the connector fitted to the supply lead.

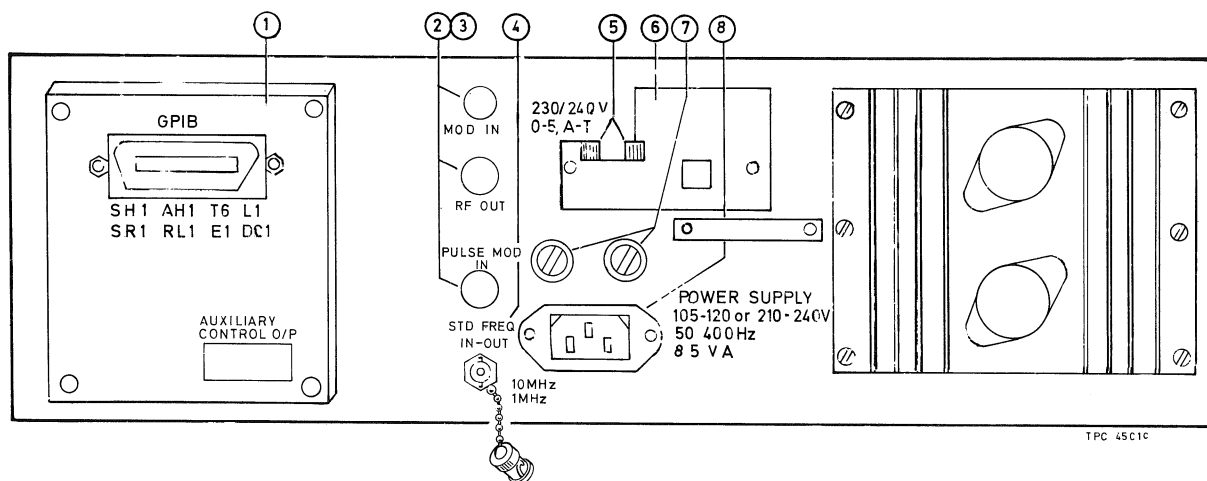

Fig. 2 Rear panel controls with optional GPIB interface

PREPARATION FOR USE

Switching on

4. With the instrument connected to a suitable a.c. supply proceed as follows:-

(1) Switch SUPPLY ON and check that the instrument has taken up the correct initial operating mode, that is CARRIER FREQ 520 MHz (1040 MHz for 2019A) internal MOD OSC 1 kHz, no MODULATION and minimum RF LEVEL (-127 dBm or equivalent). The instrument may be set to the contents of store 10 if second function 16 has previously been set. For details see the paragraph, 'Recall STORE 10 at switch on'.

(2) Before the initial operating mode is displayed an indication of the software issue number is shown in the level window e.g. 01,02,03 for approximately one second. If the instrument has developed a fault condition an error number will be continuously displayed. Details of these are given in the GPIB functions paragraphs.

(3) Check that the carrier frequency window does not indicate EXT STD, unless an external frequency standard input is required. If this has been inadvertently selected press CARRIER FREQ and INT/EXT keys to reselect internal frequency standard.

(4) During normal operation the instrument's internal reference standard will give an accuracy within the rated performance after a warm-up period of 5 minutes at normal ambient temperatures.

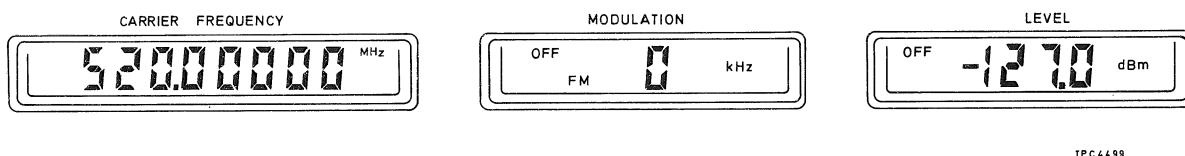
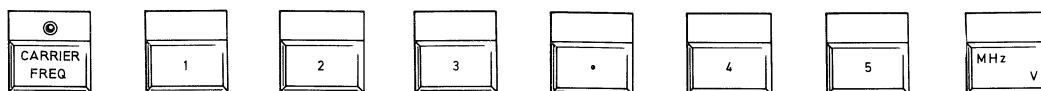

Fig. 3 2018A initial operating mode

OPERATING PROCEDURES

5. Selection of data is carried out by first pressing the required function key and this is then indicated by an integral l.e.d. Follow this with the numerals including a decimal point or negative sign if required, a positive sign is otherwise implied. If an error is made in the entry re-selection of the function key will clear the previous entry. Complete the entry by pressing the appropriate UNITS terminator key. If a request outside the operating range of the instrument is made a LIMIT annunciator will be set on the relevant display and the generator will tune to either the minimum or the maximum value nearest to the initial request. One exception to this is if a carrier frequency less than 80 kHz is selected, for details see next para.

Setting a carrier frequency



6. If the l.e.d. in the orange CARRIER FREQ key is off press the CARRIER FREQ key. If the l.e.d. is on this will not be necessary. Enter the required value via the numerical key pad including the decimal point if required, the data entered will appear in the carrier frequency display. Terminate the instruction by pressing the appropriate UNITS terminator key. If a request lower than the minimum specified frequency 80 kHz is made, the LIMIT annunciator is displayed and the instrument tunes to the requested frequency but with a degraded performance. When selections below 30 kHz are made the accuracy

of the r.f. level output will be impaired. Subsequent OFF/ON control is achieved by operation of the CARRIER ON/OFF key.

Note ...

If the 10 kHz Carrier frequency variant is fitted the accuracy of the selected output level will be accurate down to the lower specified limit of 10 kHz. If the Avionics variant is fitted then the lowest specified limit is 1.5 MHz.

Incrementing and decrementing

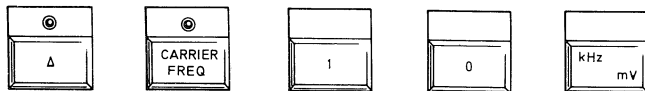

7. To display current increment values press the orange key identified by a delta sign Δ. Initially the instrument will automatically select and display an increment for each of the main functions as follows:- Carrier frequency 1 kHz, Modulation, either FM 1 kHz, φM 1 Rad or AM 1%. RF level 1 dB and AF level 1 dB. If an AF level increment is required, selecting Δ, AF LEVEL, causes the LEVEL window indication to change from the RF level increment initially displayed to that of the requested AF level increment. To return the instrument to normal operation without affecting any current increment value that may have been selected press any function key twice. To enter a new value of increment such as a carrier frequency step of 10 kHz, press the keys shown in the example above. FM, φM, AM, AF or RF LEVEL may be similarly incremented, note that if incrementing the RF LEVEL the only valid terminator is the dB key.

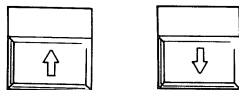

(1) Each press of the UP key will then increment the carrier frequency by 10 kHz, likewise pressing the DOWN key will decrement the carrier frequency by a similar amount.

(2) Holding the UP or DOWN key pressed will result in continuous incrementing or decrementing after a brief delay.

(3) Changing from the incrementing mode to the decrementing mode without the delay can be achieved by keeping the UP key continuously pressed allowing the instrument to increment, then following this selection press the DOWN key also. When the UP key is released the instrument will immediately decrement. A reversal from down to up without delay can then be achieved by pressing the UP key before releasing the DOWN key, and when the DOWN key is released the instrument will then immediately increment.

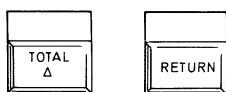

(4) To find the total shift from the original setting press the TOTAL shift key. While this key is pressed all the displays will show the total shift of each function from their starting values. To return to the initial value of the selected function press the RETURN key.

Internal modulation source

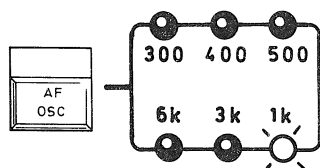

8. The internal AF modulation oscillator frequency can be controlled by successive presses of the AF OSC key. The six l.e.d's adjacent to the AF OSC key will indicate the oscillator frequency selected.

Setting a.f. level



9. Entry is similar to the r.f. level selection, both logarithmic and linear scales are available. Linear scale is always p.d. and logarithmic is dBm into 600 Ω . Units can be converted in the same manner as the r.f. level units. Data is displayed in the level display, modulation and carrier frequency are kept blank at this time. A level of 1 V r.m.s. is set at the Power on default mode or a different setting if 'Recall store 10' setting has been set (see Second function 16 for details).

External modulation

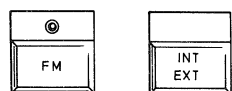

10. Press FM, ϕ M, or AM function key as appropriate followed by the INT/EXT key to select external, this is indicated on the modulation display by an EXT annunciator. Further pressing the INT/EXT key will return the instrument to the internal mode. The external mod. level is monitored and HI or LO l.e.d's are provided as an aid to maintain calibrated modulation in the a.l.c. off mode.



(1) With MOD ALC, ON and external modulation selected the signal from the externally applied modulation source can be set internally to the correct level (providing the applied voltage is between 0.8 V and 1.2 V). MOD ALC, ON selection is indicated by the integral l.e.d.

(2) With MOD ALC, OFF selected, an input of 1 V r.m.s. will produce the displayed modulation value. The instrument will normally power-up with MOD ALC off when in EXT MOD mode.

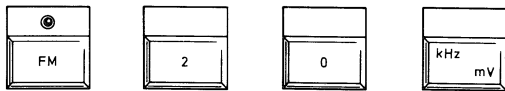
Setting f.m.

11. Select the modulation frequency (300 Hz, 400 Hz, 500 Hz, 1 kHz, 3 kHz or 6 kHz) as required by successive presses of the AF OSC key. Continue the selection shown above to select a deviation of 20 kHz. The instrument normally switches on in the Internal mode.

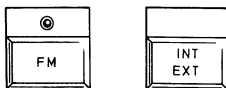

(1) To select external f.m. first press the FM key if its l.e.d. is not lit, then press the INT/EXT key. The f.m. will then be selected to external, and the EXT annunciator will set in the modulation display window. Pressing the INT/EXT key again will return the f.m. to the internal mode.



(2) To turn f.m. off whilst still retaining the current value of entered deviation press MOD ON/OFF key. The off condition is indicated by the setting of an OFF annunciator in the modulation display window. Entering a new value of f.m. deviation will automatically select the f.m. on again.

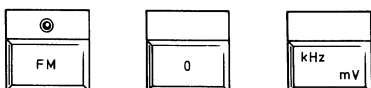

(3) If the 2018A is to be utilized for signal-to-noise measurements within a narrow bandwidth a useful reduction of residual noise level may be obtained from the instrument at frequencies adjacent to the carrier frequency. This can be achieved by the selection of FM and a setting of '0' deviation. A useful alternative method for controlling the FM deviation setting if required is to use the DOWN key to reduce the value to zero and the 'RETURN' key to return to a previous setting.

Setting ϕ .m.

12. The procedure for selecting a value of phase modulation is the same as for f.m. with the RAD key terminating the entry.

Auxiliary f.m. input socket

13. Applying a 1 V r.m.s. signal to the AUX FM INPUT socket enables the value of the displayed f.m. to be increased by 10% of the same numerical deviation, e.g., indicated deviation of 10 kHz + auxiliary f.m. of 1 kHz increases the total deviation to 11 kHz. If ϕ .m. is selected the total number of radians will be changed in a similar manner.

Setting a.m.

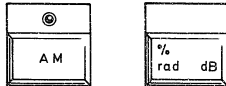

14. Again the procedure for selecting a value of a.m. depth is similar to that described for setting f.m., the only differences being that the AM function key is pressed and the instruction data is ended by the % terminating key.

Setting r.f. level

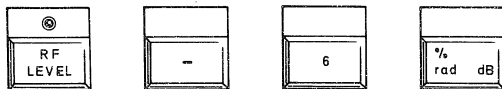

15. Press the RF LEVEL key and enter the required data including any decimal point or minus sign as required. The terminator keys give a choice of volts, millivolts, microvolts or decibels. Linear voltage scales can be calibrated in either e.m.f. or p.d. and are set up by a second function control. Further references for the logarithmic dB scales are also set up by the second function control, for details see Second function operations. An r.f. level displayed in logarithmic units can be converted to linear units by pressing V, mV or μ V keys with the RF LEVEL l.e.d. lit if no data is entered. The reverse operation can be carried out under the same conditions by pressing the 'dB' key.

Setting pulse modulation



16. The above keys are only fitted if the Pulse modulation option is fitted to the instrument. To select pulse modulation press both keys simultaneously. Pulse modulation is indicated by a "P" in the modulation display.

On-Off keys

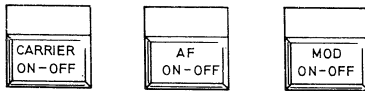

17. Each of the above keys may be operated independently of the function key to allow control of r.f. output, a.f. output or modulation. ON-OFF control is carried out by the toggle action of each key.

Reverse power protection



18. The instrument is protected from accidental application of reverse power, if the reverse power protection (RPP) unit is tripped the integral RF LEVEL l.e.d. will flash and the REV PWR LIMIT annunciator will be set on the RF LEVEL display. During this time the keyboard will not respond except to reset commands. After the source of power has been disconnected the RPP is reset by pressing the RF LEVEL function key. When the instrument is switched OFF, the output socket is automatically disconnected from the output attenuator - a further safety feature.

Store and recall

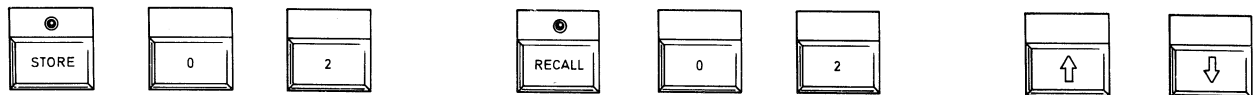

19. The instrument has 100 non-volatile stores available. Stores numbered 00 - 19 store complete instrument settings (including increment values). Stores 20 - 99 store settings of carrier frequency only. Store key selection is indicated by an integral l.e.d. and the store number currently selected is displayed in the levels window.

(1) To store press STORE followed by a two digit numerical entry.

(2) To recall, press RECALL and the appropriate numerals. Increment keys can be used to sequence the recall of stores if required.

20. To store a set of modulation and r.f. levels that can be applied to any carrier frequency first enter a carrier frequency of 0 Hz followed by the required modulation and r.f. level values. Press the STORE key followed by one of the instrument store numbers 00 to 19 to retain the settings. Subsequently recalling the store with the RECALL key will retrieve the modulation and r.f. level leaving the current setting of carrier frequency selected. This is a useful method of transferring a standard set of modulation/level settings onto carrier frequencies entered by the operator.

Storing CF 0 Hz will enable the Carrier frequency currently displayed being kept when the store is recalled. Store 10 can be used to implement a pre-selected set of conditions when power on is initiated. For details of this facility see the paragraph Second function 16.

21. Access to stores may be protected using second function 191. Any attempt to over-write a store will result in Error number 11 being displayed in the carrier frequency window. Digital information within the store will be retained. Details of this second level operation are given in Vol. 2, Service Manual.

22. Another second level operation, second function 192 can be used to disable carrier frequency, modulation and level displays when Stores 01 to 99 are recalled. (Recall store 00 will always produce a valid display). As stores are recalled all display windows will remain blank unless incremental values have been used. In this event pressing the TOTAL SHIFT key will give a valid display of the total shift in the appropriate window. This facility is of value when secrecy is important.

SECOND FUNCTION OPERATIONS

23. Second function operations provide a means of controlling various secondary features and calibrations within the instrument. Access to many of these operations is generally not required during routine use of the instrument and some should only be accessed by skilled personnel during the course of realignment, fault finding, or repair. There are three levels of operation as follows.

(1) Normal operation (second functions 0,1,2,3,4,9,11,12,13 and 18 are unprotected and can be accessed directly).

(2) First level operation (second functions 5,6,14,15 and 16 have a first degree protection). Access to this level can be gained after operating an unlocking procedure described in para. 25.

(3) Second level operation (second functions 7,8,9,10,17,190,191 and 192 have second degree protection and can only be accessed by the operation of a special key code). Details of the code are given in the Service Manual.

24. In general the second function mode is entered by pressing the blue SECOND FUNCT key followed by the numerals corresponding to the second function required. Pressing the second function key inhibits the action of some keys, however the instrument can always be restored to its normal operating mode by pressing any of the orange function keys. This means of exit from second function operation is always safe, i.e. it will not corrupt any data, or alter any status bits and the displays will revert to their normal functions.

No data will be permanently altered unless the store key is pressed. The operation of each of the secondary functions is as follows:-

Second function 0 'Unlock'

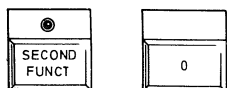

25. Switching on the instrument, automatically sets all second functions with first and second degree protection to the Locked mode. Normal operation only can then be accessed directly. To gain access to the First level operation press the SECOND FUNCT and '0' keys followed by the MOD ALC and AF ON-OFF keys, both of which must be pressed simultaneously until a "1" appears in the CARRIER FREQUENCY window. The instrument will then be unlocked at the First level and allow further selection of the required second function in that group. If the sequence is in error, or aborted part way through, the instrument will remain locked. Once unlocked the instrument remains so until either the SECOND FUNCT and '0' keys are once more pressed or until the instrument power is switched off.

Notes ...

- (1) Access to all levels of operation is always available over the GPIB (where fitted). Care must therefore be taken when selection of either First or Second level operations are required. Access to second functions via GPIB selection should be restricted to personnel who have a full knowledge of these operations and require access to them in the course of realignment, fault finding or repair only. If inadvertent selections are made it is possible to invalidate the instrument's calibration.
- (2) The instrument always reverts to the locked state after using the bus.

Second function 1 'Status'



26. Entering Second function 1 will result in the instrument displaying status information as shown below in Fig. 4.

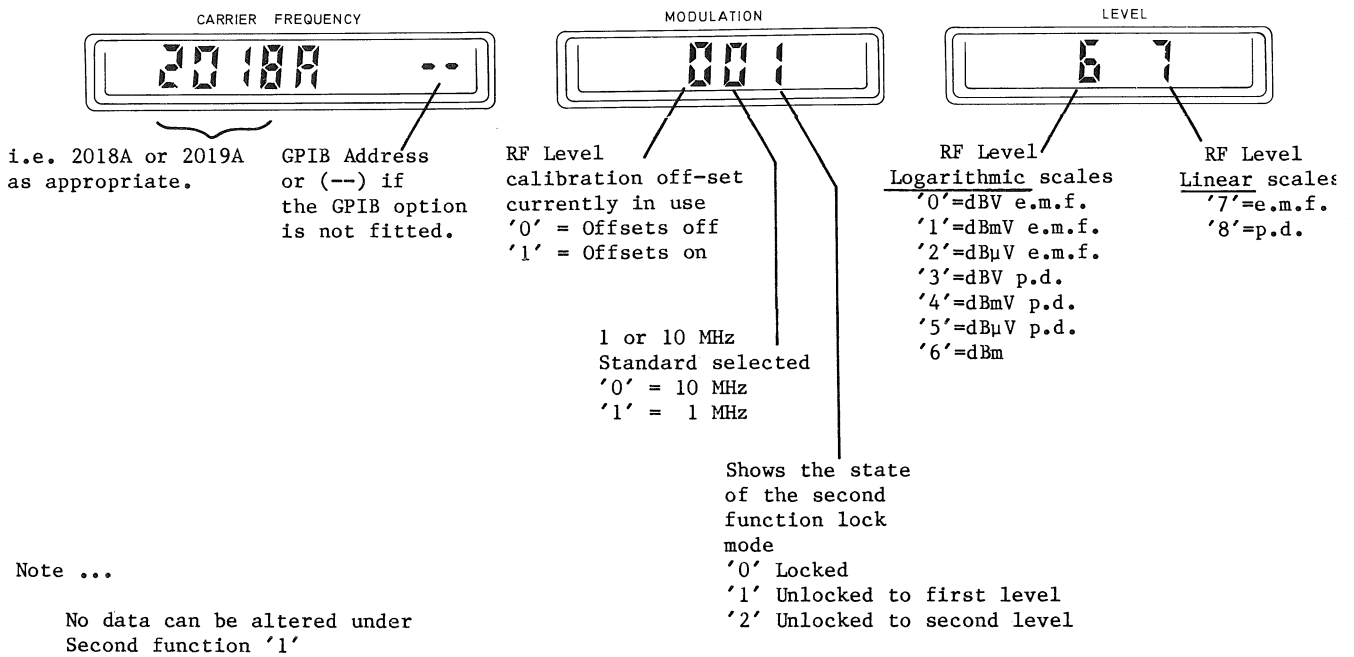
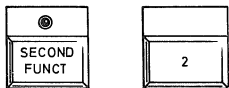

Fig. 4 2018A Second function '1' status mode

Second function 2 'GPIB address setting'



27. If the GPIB option is not fitted the sign "--" is displayed in the carrier frequency display; otherwise the current GPIB address is displayed. If a new address is required, this may be entered via the keyboard. Numbers rotate in from the right. When the required address is displayed pressing the



key will, if the address is acceptable (00 - 30), replace the previous one. If the address is too large it will be ignored and the current address re-displayed instead. Except for second function 1 where the display has an alternative use, current second function selection is normally shown in the modulation window.

Second function 3 'Manual latch setting'

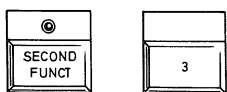

28. This function allows an 8 bit binary instruction to be directed to any of the instruments internal latches for testing and fault finding. On entering the latch address (i.e. A7L1), current data on the latch is displayed in

binary in the Carrier frequency display. Information is entered from the left and rotates to the right. A decimal point indicates the "pointer" between old and new data. Pressing the STORE key sends the displayed data to the latch. This facility is fully described in the Service manual and is an invaluable aid when diagnosing internal instrument bus or latch faults. On exiting from second function 3 all latch data which may have been over-written is restored.

Second function 4 'SRQ mask setting'

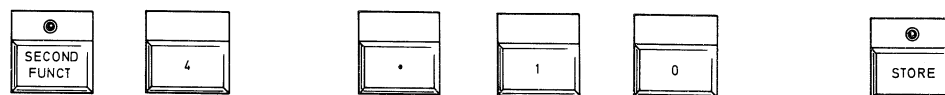

29. Select SECOND FUNCT mode followed by the numeral 4. The SRQ mask allows an instruction to be made for the instrument not to request service over the GPIB for particular conditions. 24 possible error conditions are listed in the GPIB functions paragraphs although provision has been made for 30. At switch on all error numbers previously masked are automatically reset to the unmasked state i.e. '0' and displayed as a 6-bit binary number in the frequency display. To give access to error numbers 1 to 30 inclusive requires five pages. At switch on, page 1 is automatically selected and error numbers 1-6 are represented from right to left as shown in Fig. 5. To access error numbers 7-12 press the '.' (decimal point) key, this selects page 2 of 5, pressing this key again selects 3 of 5 to represent error numbers 13-18 etc. To reselect page 1 after selecting page 5, further press the decimal point key. The page number currently selected is shown in the level display.

Note ...

In a GPIB controlled system the SRQ mask setting will normally be selected by a GPIB instruction sent by the controller.

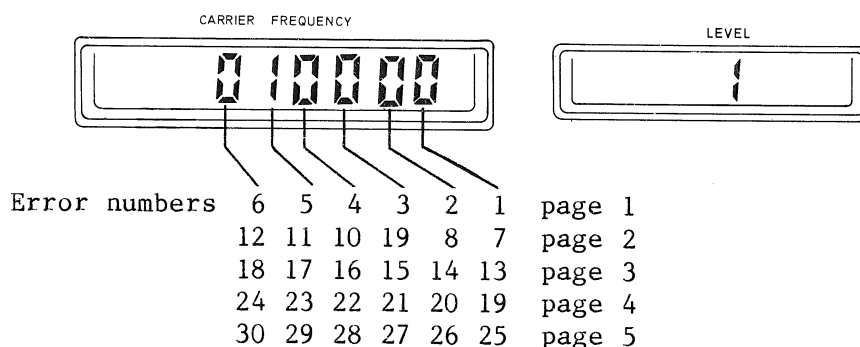
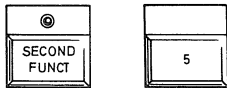

Fig. 5 SRQ mask setting display

30. Binary entry is entered via the keyboard and ones or zeroes rotate in from the right. Enter a bit '1' to mask the required error(s). When these are in position press the STORE key to terminate the entry. Fig. 5 shows the mask set to ignore a GPIB bus error (Error No. 05).

Second function 5 'RF level units setting'



31. Unlock the instrument to the first level of operation completing the unlocking procedure given in para. 25, then select SECOND FUNCT and the numeral 5 keys. On entering second function 5 two digits are displayed in the r.f. level display. These represent the two scales of r.f. level units which are currently selected, the left-hand digit represents the logarithmic scales and the right-hand digit the linear scales as shown below:-

<u>Left digit (logarithmic scale)</u>	<u>Right digit (linear scale)</u>
0. dBV e.m.f.	7. e.m.f.
1. dBmV e.m.f.	8. p.d.
2. dB μ V e.m.f.	
3. dBV p.d.	
4. dBmV p.d.	
5. dB μ V p.d.	
6. dBm	

These units may be selected via the keyboard by entering the numbers corresponding to the units required and then pressing the STORE key.

Second function 6 'RF level offsets'

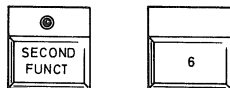

32. First select a carrier frequency within the chosen band (see below) followed by a suitable r.f. level. Complete the unlocking procedure given in para. 25, then select SECOND FUNCT and numeral 6 keys. In addition to the standard calibration for r.f. output level, the instrument has a capability for overall level adjustment to facilitate matching with other equipment. The output level can be raised or lowered by approximately 2 dB in the offset mode. In 2018A there are two carrier frequency bands, 0-260 MHz and 260-520 MHz, and in 2019A an additional band 520-1040 MHz. One offset value may be set for each frequency band as follows:-



Selection on or off is made with the above keys, '1' selecting offset on, or '0' offset off. Indication of the selected state is displayed in the frequency display window with either a '1' or '0' as appropriate. Having set the Offset ON select either the \uparrow (UP) or the \downarrow (DOWN) key to increment or decrement the r.f. level by 0.1 dB. Each successive 'UP' or 'DOWN' selection will then increment or decrement the r.f. by a further 0.1 dB. When sufficient offset has been determined press the 'STORE' key to finalize the selection which will, together with the offsets on selection, remain valid until further adjustment is made. If an offset value of +0.1 dB is selected when the instrument is set to the limit of its operating range i.e. +13 dBm or

equivalent, a maximum r.f. level of +12.9 dBm will be imposed, (a further +0.1 dB offset increment will decrease this to +12.8 dBm).

Note ...

When an offset value has been selected and stored it will remain valid for all subsequent power on sequences. RF level accuracy of the instrument is therefore impaired and care should be taken to account for this.

Second function 9 'Elapsed time display'

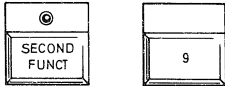

33. This facility enables the user to observe the total number of instrument running hours accumulated since the facility was last set to zero. The elapsed time is shown in the Frequency display in hours with a resolution of 0.5 hrs. and is not updated while being viewed. After switch on the timer is updated by 0.25 hrs. after 7.5 min. of operation (to avoid rounding errors) and thereafter at 15 minute intervals. The purpose of this display is to allow calculation of calibration intervals or similar periodicities. Reset to zero can be achieved by first unlocking the instrument to the second level of operation, then selecting SECOND FUNCTION 9 followed by 0 and STORE keys. Details of the unlocking procedure are restricted to the Service Manual Vol. 2. A further elapsed time display second function 10, "Read total instrument running hours" can also be accessed after unlocking to second level of operation. No means of reset is available for this display.

Second function 11 'Read identity string'

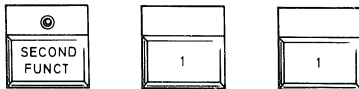

34. Selection of this facility enables the user to confirm the Type number, Serial number and Software issue number of the instrument. This is indicated with two separate displays, the first display shows type and software issue number. The second half of the string indicating the instrument serial number is displayed when the decimal point key is pressed. Both displays are shown in Fig. 6 below.

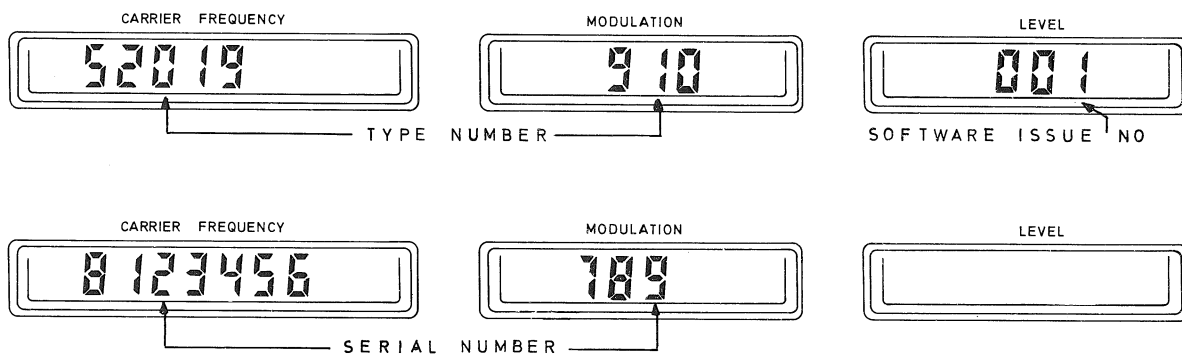

Fig. 6 'Read identity' display

Second function 12 'Write user - definable string'

35. This is a GPIB only facility whereby a string of data may be set at the user's convenience, details are given in the GPIB functions SF12 paragraph.

Second function 13 'Read user - definable string'

36. This read only facility provides the means of reading back data set by means of the GPIB, SF12 write facility and like Second function 12 this is used only in conjunction with GPIB, see GPIB functions SF13 paragraph.

Second function 14 '1 or 10 MHz standard setting'

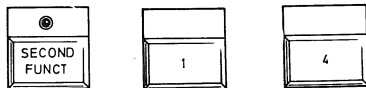

37. This function allows the user to select either 1 MHz or 10 MHz internal frequency standard. First carry out the unlocking procedure given in para. 25 then select SECOND FUNCT and the numeral keys 1 and 4. The frequency standard currently selected is then displayed in the carrier frequency window (display shows "1 MHz" or "10 MHz").

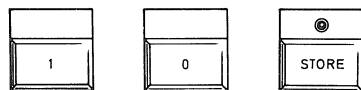

To select 1 MHz std. press the numeral '1', or '0' to select 10 MHz std. followed by the STORE key.

Second function 15 'Old/new GPIB command set'

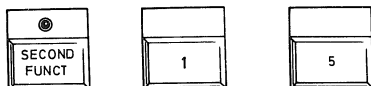

38. This function is of use in automatic test areas where a 2018A or a 2019A is required for test purposes to be addressed with a 2018 or 2019 set of instructions. This allows a full range of tests to be carried out using 2018A/19A where parameters are the same as the 2018/19 series. Unlock to first level as described in para. 25 and select SECOND FUNCT and the numerals 1 and 5. The carrier frequency window will then display the current selection, '0' for 2018A GPIB set or '1' for 2018 GPIB set. To select 2018A press the numeral '0' key, to select 2018 press the numeral '1' key. Terminate the selection by pressing the STORE key.

Second function 16 'Recall STORE 10 at switch on'

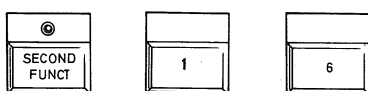

39. This facility allows the instrument to be operated in a remote or unattended location with a pre-selected set of conditions which will remain unchanged in the event of inadvertent switching off and on of the input supply voltage. In the normal operating mode if this happens, the instrument would resume the initial operating mode, that is CARRIER FREQ 520 MHz (2019A, 1040 MHz), internal MOD OSC 1 kHz, no MODULATION and minimum RF LEVEL (-127 dBm or equivalent). These conditions can be superseded by storing the

required operating conditions into 'STORE 10' and carrying out an automatic recall of the 'STORE 10' settings using the Second function 16 mode.

- (1) First select by means of the front panel keyboard, the required CARRIER FREQ. MODULATION and RF LEVEL settings.
- (2) Press the 'STORE' key followed by the numerals '10'.
- (3) Complete the unlocking procedure given in para. 25, select SECOND FUNCT mode and press the numerals '16'. Then press the "1" key to select automatic recall of STORE 10. Finally press the 'STORE' key.

If the supply voltage is interrupted, then restored, the instrument will first reset to the initial operating mode then automatically carry out a 'RECALL 10' instruction and reset to the 'STORE 10' conditions previously set. To disable the facility first unlock the instrument to First level operation, select 'SECOND FUNCT' 16 followed by the numeral '0'. and finally the 'STORE' key.

Second function 18 'Set data on GPIB Aux. output pins'

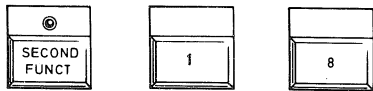

40. In addition to allowing full GPIB control of the Signal Generator, the GPIB module AGO has an auxiliary output socket which can be used to control external relays or similar. This 14 pin plug fitted on the rear panel GPIB interface can easily be accessed by removing a plastic cover. Data is set to control the eight external data lines after selecting second function 18. Connections from the Auxiliary output are best made using an IDC ribbon cable connector (provided with the Optional GPIB interface kit). Interconnections and operation is as follows:-

- (1) Plug PLDW pin 5 may be keyed to prevent incorrect insertion of the IDC connector. Pin connections as seen from the rear panel are shown below:

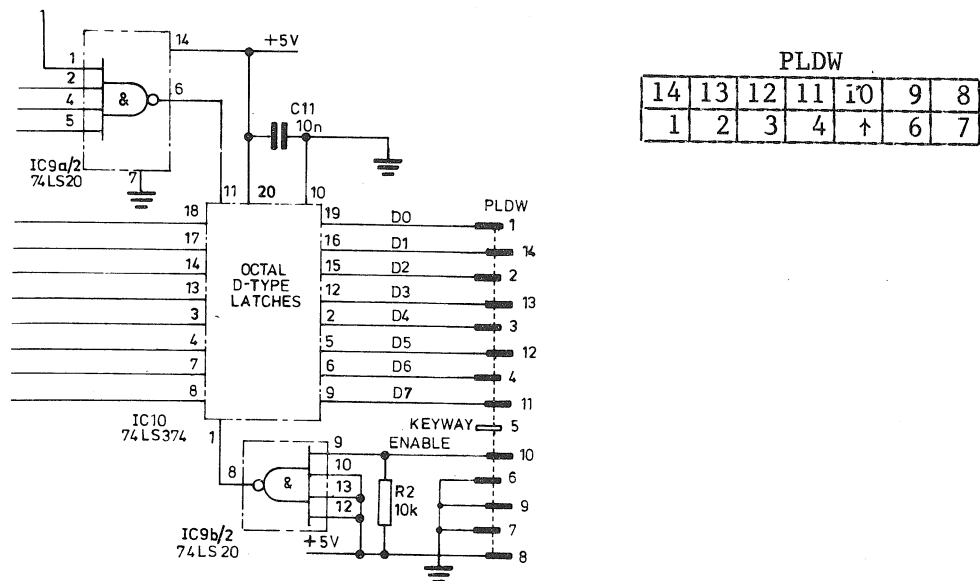

Fig. 7 GPIB auxiliary output plug and socket connections

(2) Data is set on the pins in the same manner as Second function 3 Manual latch setting. Current data (if any) is displayed in the carrier frequency window. New data is entered in binary using the front panel '0' and '1' keys, most significant bit first.

(3) If the outputs are to be connected to a load that has its own integral +5 V supply line available it is preferable to connect this to the enable line on pin 10, (pins 6,7 and 9 are internally connected to earth). In the event of an external power failure the enable circuit will then be set 'low' and the data lines disabled.

Second functions 7,8,9,10,17,190,191 and 192 (Second level operation)

41. All the following facilities have second degree protection, further information on these facilities and details of the special key code to access them are contained in the Service manual.

Second function	7	: RF level calibration
Second function	8	: FM tracking
Second function	9	: Reset of elapsed time display
Second function	10	: Read - total instrument operating time
Second function	17	: Calculation and storage of amended EAROM checksum
Second function	190	: Write - identity string setting
Second function	191	: Protection of store settings
Second function	192	: Display blanking of recalled stores

OPERATION WITH 75 Ω LOADS

42. The performance specification for the instrument assumes operation into 50 Ω external loads, but often it is desirable to work into mismatched loads. This is in general possible although an uncertainty of performance may be introduced. When external loads of 75 Ω are employed these can be accurately matched for carrier frequencies up to 500 MHz by using a 50/75 Ω Impedance Adapter Code No. 54411-051X offered as an optional accessory. This 25 Ω series load maintains the correct open circuit voltage calibration and allows the reverse power protection circuit to function correctly.

GENERAL PURPOSE INTERFACE BUS (GPIB) FUNCTIONS

43. The GPIB interface, offered as an optional accessory allows the instrument to be coupled to a controller. The essential purpose of the GPIB functions are described below. Further information on the general features and applications of the GPIB system can be obtained from the separate GPIB manual offered as an optional accessory.

44. 2018A/2019A have both talker and listener capabilities. One address is used for both talking and listening and is set via the front panel or via the GPIB using Second function 2. The instrument can request service (assert SRQ) on certain error conditions under the control of an SRQ mask which is set using Second function 4.

45. SH1 : Source handshake (complete capability)

The source handshake sequences the transmission of each data byte from the instrument over the bus data lines. The sequence is initiated when the function becomes active, and the purpose of the function is to synchronize the rate at which bytes become available to the rate at which accepting devices on the bus can receive the data.

46. AH1 : Acceptor handshake (complete capability)

The acceptor handshake sequences the reading of the data byte from the bus data lines.

47. T6 : Talker function (no talk only function)

The talker function provides the 2018A with the ability to send device dependent messages over the bus to other devices. The ability of any device to talk exists only when it has been addressed as a talker.

48. L4 : Listener function (no listen only function)

The listener function provides a device with the ability to receive device dependent messages over the bus. The capability only exists where the device is addressed to listen via the bus by the controller.

49. SRI : Service request function (complete capability)

The service request function gives the 2018A the capability to inform the controller when it requires attention.

50. RL1 : Remote/local function (complete capability)

The remote/local function allows the 2018A to be controlled either by the local front panel keys or by device dependent messages over the bus.

51. DCL : Device clear function (complete capability)

Device clear is a general reset and may be given to all devices in the system simultaneously (DCL) or only to addressed devices (SDC). 2018A resets to the default power-up mode, that is

Maximum carrier frequency (2018A - 520 MHz) (2019A - 1040 MHz)
No a.m., f.m., ϕ .m. or pulse modulation
Minimum r.f. level - 127 dBm or equivalent
Modulation oscillator frequency 1 kHz
Internal modulation selected
Increment settings; Carrier freq. 1 kHz, f.m., 1 kHz, ϕ .m., 1 rad, a.m.,
1%, r.f. level, 1 dB or a.f. level 1 dB.

Before these conditions are set, a checksum is calculated for the calibration data (FM tracking and RF level) and referred to a number held in the non-volatile memory. If this test of calibration validity fails, the instrument responds by asserting SRQ. The status byte will contain the number 6 to signal a calibration data fault in addition to the 'SRQ asserted' bit. In order to continue with the device clear (and normal operation thereafter) the instrument must be restarted by sending any valid instruction code (e.g. "CF"). This serves only as a reset and will not be interpreted in the normal way.
Chap. 3
Page 20

52. E1 : Open collector drivers

The GPIB drivers fitted to 2018A have open collector, rather than tristate, outputs.

Setting the GPIB address

53. The instrument's talk/listen address is selected by means of the second function mode 2. Acceptable addresses (00 to 30) can be set by this means and the instrument's internal address register will be updated by reading the address at power-on and on receipt of a device clear message. The current GPIB address is shown in the frequency display when the interface is correctly installed.

GPIB programming codes

54. Functions

DE Delta (Increment/Decrement)
 CF Carrier frequency
 FM Frequency modulation
 PM Phase modulation
 AM Amplitude modulation
 PU Pulse modulation (if option is fitted)
 LV RF level
 AL Audio output level
 IS Internal Freq. Std.
 XS External Freq. Std.
 QU Query - send current function setting to GPIB buffer - see Talking function
 SF Second function (see Chap. 3, para. 25, Notes)
 RS Reset RPP

Units

MZ Megahertz
 KZ Kilohertz
 HZ Hertz
 PC Percentage
 VL Volt
 MV Millivolt
 UV Microvolt
 DB Decibel
 RD Radians

Miscellaneous functions

CI Carrier On
 CO Carrier Off
 ST Store } followed by a
 RC Recall } number 00-99
 RT Return
 UP Increment up
 DN Increment down
 HO Set triggered output mode Off
 HI Set triggered output mode On
 GO Trigger output
 QL Query modulation input level

Mod OSC/ALC

F0 Mod osc freq. 300 Hz
 F1 Mod osc freq. 400 Hz
 F2 Mod osc freq. 500 Hz
 F3 Mod osc freq. 1 kHz
 F4 Mod osc freq. 3 kHz
 F5 Mod osc freq. 6 kHz
 M1 Modulation On
 M0 Modulation Off
 IM Internal modulation
 XM External modulation
 A1 Audio output On
 A0 Audio output Off
 L1 Mod ALC On
 L0 Mod ALC Off

Listening function

55. The 2018A is remotely controlled over the GPIB by strings of two-character codes and digits sent in upper case ASCII format. Where possible these codes correspond directly to the front panel keys : however where the normal front panel control requires a knowledge of the previous state of the instrument (e.g. toggling controls such as on/off), special codes are provided to simplify programming.

56. In order to improve the readability of control strings, the codes may be separated by commas or spaces after each code pair or data group. These are ignored by the instrument. When data is entered, the syntax is the same over the GPIB as that used in control from the front panel. For example to enter a complex string of instructions such as a carrier frequency of 123.45 MHz with an increment of 25 kHz and an r.f. level of 1.2 μ V the string can be sent as follows, "CF 123.45 MZ, DE CF 25 KZ, LV 1.2 UV". Or similarly, if it required to change the r.f. level units setting to dBm (second function mode 5, logarithmic scale 6), the string "SF 5, 6, ST" should be sent.

57. The ON/OFF and INT/EXT controls operate on the function currently active for data entry. This may be specified, e.g. "FM M1"; "AM XM" or implied, e.g. "FM 1.5 KZ, IM" but it is recommended that the function is specified within the string to ensure that the string will always have the same result. Selection of a second function via the GPIB will result in a display of the SF number being shown in the instruments modulation window.

Talking function

58. On receipt of the QU command the current function setting (e.g. CF,FM) is transferred to the GPIB output buffer in a format corresponding to the GPIB commands needed to set the instrument to the current state. RF level will be displayed in log. or linear units but without a specific reference since this information cannot be re-entered directly. Increment settings are also available if QU is sent whilst in DELTA mode with a current function l.e.d. lit. The following tables give the format for each type of string.

TABLE 1 MODULATION STRING (18 characters)

NUMBER OF CHARACTERS IN FIELD							
2	2	4	2	2	2	2	2
DE	FM	3 digits or leading spaces plus decimal point or space	MZ	MO	IM	L0	F0
**	PM		KZ	M1	XM	L1	F1
	AM		HZ			**	F2
	PU		PC				F3
			RD				F4
						F5	**

* Represents a space which is used when the field has no relevance, such as the levelling field when internal modulation is selected.

e.g. DE,FM,1.00, KZ,M1,IM,**,**
or **,FM,1.23,KZ,M1,IM,**,F2

TABLE 2 FREQUENCY STRING (17 characters)

NUMBER OF CHARACTERS IN FIELD					
2	2	9		2	2
DE **	CF	8 digits or leading spaces plus decimal point or space		MZ KZ	IS XS

e.g. **,CF,123.45678,MZ,IS

TABLE 3 LEVELS STRING (14 characters)

NUMBER OF CHARACTERS IN FIELD						
2	2	1	1	4	2	2
DE **	LV AL	- *	1 0 *	3 digits or leading spaces plus decimal point or space	DB VL MV UV	CO C1 AO A1

e.g. **,LV,*,1.000,VL,C1

59. Provision for talking second function values can also be made by a similar use of QU when the function is engaged, the format being numeric strings only for calibration data etc., e.g. FM tracking, and a numeric string representing hours for the elapsed time indicator. Three further data strings are available, Status string, Identity string and a User string, these are accessed by means of second function controls and the QU function.

60. The external modulation input level status indicated by the front panel HI and LO l.e.d's can also be accessed on receipt of the QL command. The current level is transferred to the GPIB output using two ASCII characters to indicate one of the three possible states:

HI input too high
LO input too low
OK input within range

61. Requesting a string to be output will overwrite any string data waiting to be sent. Addressing the instrument to talk without specifying a string to be sent or re-addressing to talk after a string has been completed will result in an error (and SRQ if not masked).

SF1, QU Status string

62. When accessed by SF1, QU the status of the instrument is sent to the controller, each data field being delimited by one space in the following format:-

2018A	┌	XX	┌	X	┌	X	┌	X	┌	X	┌	X
or		GPIB		OFFSETS		FREQ STD.		LEVEL OF		LOG		LINEAR
2019A		ADDRESS		ON/OFF		1/10 MHZ		PROTECTION		UNITS		UNITS

GPIB Address 00-30

Offsets on '1', off '0'

1 MHz std. '1', 10 MHz std. '0'

Level of protection '0' Locked, 1-2 Unlocked to 1st or 2nd level

Log units 0-6 see Second function 5 para. for details

Linear units 7,8 see Second function 5 para. for details

SF11, QU Identity string (read only)

63. The identity string accessed by SF11, QU allows instrument type number, software issue number and serial number to be read by the controller. The information is stored in non-volatile memory and in 2018A is also used to tell the software which version of instrument it is to drive. The string is displayed as described under second function 11. Each data field is delimited by one space.

SF12, User string write facility

64. Up to 32 ASCII characters can be stored in non-volatile memory by the user. This bus only facility is useful for recording such information as date next calibration is due, test gear numbers etc. The string is terminated by the LINEFEED character (ASCII code 10) which is included as the last character stored. If an attempt is made to store too many characters then <lf> is automatically inserted as the 32nd.

SF13, QU User string read facility

65. This facility provides a means of reading back data set by means of SF12 write facility and is again a bus only facility.

Service requests (SRQ)

66. The 2018A can request service to warn the controller of certain error conditions. In response to a serial poll after asserting the SRQ line, the 2018A will provide a status word (8 bits) in which bit 6 is set to indicate an SRQ request and the first five bits 0 to 4 indicate an error number. The error number is also displayed in the carrier frequency window. Errors 10,12,13,14 will result in the instrument not functioning. Error 06 can be overridden with a restart command (any function code or digit). Similarly the RPP tripped, Error 01 can be overridden with the reset instruction (RS).

Error numbers

67.	<u>No.</u>	<u>Error condition</u>	<u>Action taken</u>
	01	RPP TRIPPED	Wait for reset instruction (RS)
	02	INVALID FM TRACKING DATA (Greater than 255)	
	03	INVALID GPIB CHARACTER	
	04	OPTION NOT FITTED	
	05	GPIB BUS ERROR	
	06	CAL DATA CHECKSUM FAILURE	Wait for restart instruction
	07		(any function code or digit)
	08		
	09		
	10	PROM CHECKSUM FAILURE	
	11	ATTEMPT TO OVERWRITE PROTECTED STORE	
	12	MAIN RAM CHECKSUM FAILURE (IC18)	
	13	STACK RAM CHECKSUM FAILURE (IC12)	
	14	BOTH RAMS CHECKSUM FAILURE	
	15	EXTERNAL FREQ. STD. ERROR	
	16	ILLEGAL STORE NUMBER	
	17	INVALID STORED DATA RECALL	
	18	EAROM WRITE FAILURE	
	19	INVALID FIRST CHARACTER OF PAIR	
	20	INVALID SECOND CHARACTER OF PAIR	
	21	INCOMPLETE CHARACTER PAIR	
	22	NO TALK FUNCTION SELECTED	
	23	NO SUCH FUNCTION	
	24	EAROM READ FAILURE	

SRQ mask

68. The SRQ response to the errors listed above can be suppressed by setting a 3 page 8-bit mask via second function 4. The first 8 bits of page 1 refer (reading from right to left) to error numbers 1 to 8, page 2, error numbers 9 to 16, and page 3, error numbers 17 to 24, i.e. the right most bit set on page 1 indicates no response to error 1, the second from right no response to error 2, etc. The modulation display gives an indication of the page currently selected.

69. The mask is displayed by selection of second function 4, and may be changed by entering '1's and '0's via the keyboard. The store key is pressed to finalize a change. The SRQ mask is not stored, either in the instrument setting stores or when power is removed: when the instrument is initially switched on the mask is set to all '0's.

Reverse power protection

70. When tripped by an overload applied to the RF OUTPUT socket, the GPIB SRQ line is asserted, and the status byte (obtainable by the controller conducting a serial poll) will contain the value 65 (decimal). The RPP can be reset via the bus by sending the RS command.

Clear, switch on, and return to local

71. SDC and DCL clear 2018A to the following state:-

Max. carrier freq. 520 MHz (2019A - 1040 MHz)
Min. output level, -127 dBm or the equivalent
Carrier on
FM, a.m., pulse modulation, off
Internal modulation selected.
Increment settings, Carrier freq. 1 kHz, FM mod. 1 kHz, Φ M 1 Rad, AM 1%,
RF level 1 dB or AF level 1 dB.

To revert from GPIB to front panel control, press the 'RETURN' key.

If a Local lock out command has been given the return key operation will be ignored.

Notes ...

- (1) Int/Ext frequency standard selection and instrument stores are unaffected by the SDC and DCL commands.
- (2) Switching on clears the 2018A to the same state as SDC or DCL unless 'Recall STORE 10 at switch on', conditions apply.

Fast output facility (GPIB only)

72. This facility enables the instrument to be changed from one complete setting to another with the minimum possible transition time. Two ASCII character pairs H1 and H0 are used to set the facility on or off and a third 'GO' Trigger output, is used to implement the instruction as follows:-

- (1) Set H1 - Trigger output mode is set to on causing all instrument outputs to remain unchanged when new settings are entered, thus allowing the pre-setting of several functions.
- (2) Set GO - Trigger output now instructs the instrument to change settings.
- (3) Set H0 - Trigger output mode is set to off and instrument resumes normal operation.

GPIB connector contact assignments

73. The contact assignment of the GPIB cable connector and the device connector is as shown in Fig. 8 below.

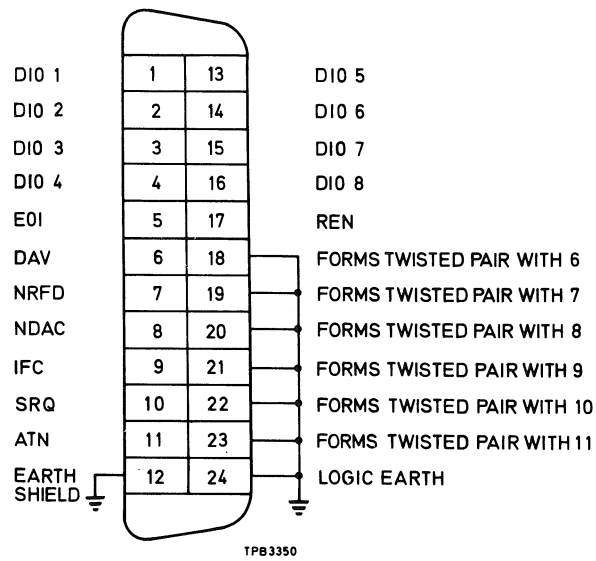

Fig. 8 GPIB connector contact assignments

Note . . .

2018A comprises basic instrument with board AC3 fitted.
2019A includes board AC13 in lieu of AC3, this board provides AC3 functions and an additional frequency doubler circuit. The diagram does not include differences that would be created by the addition of variants.

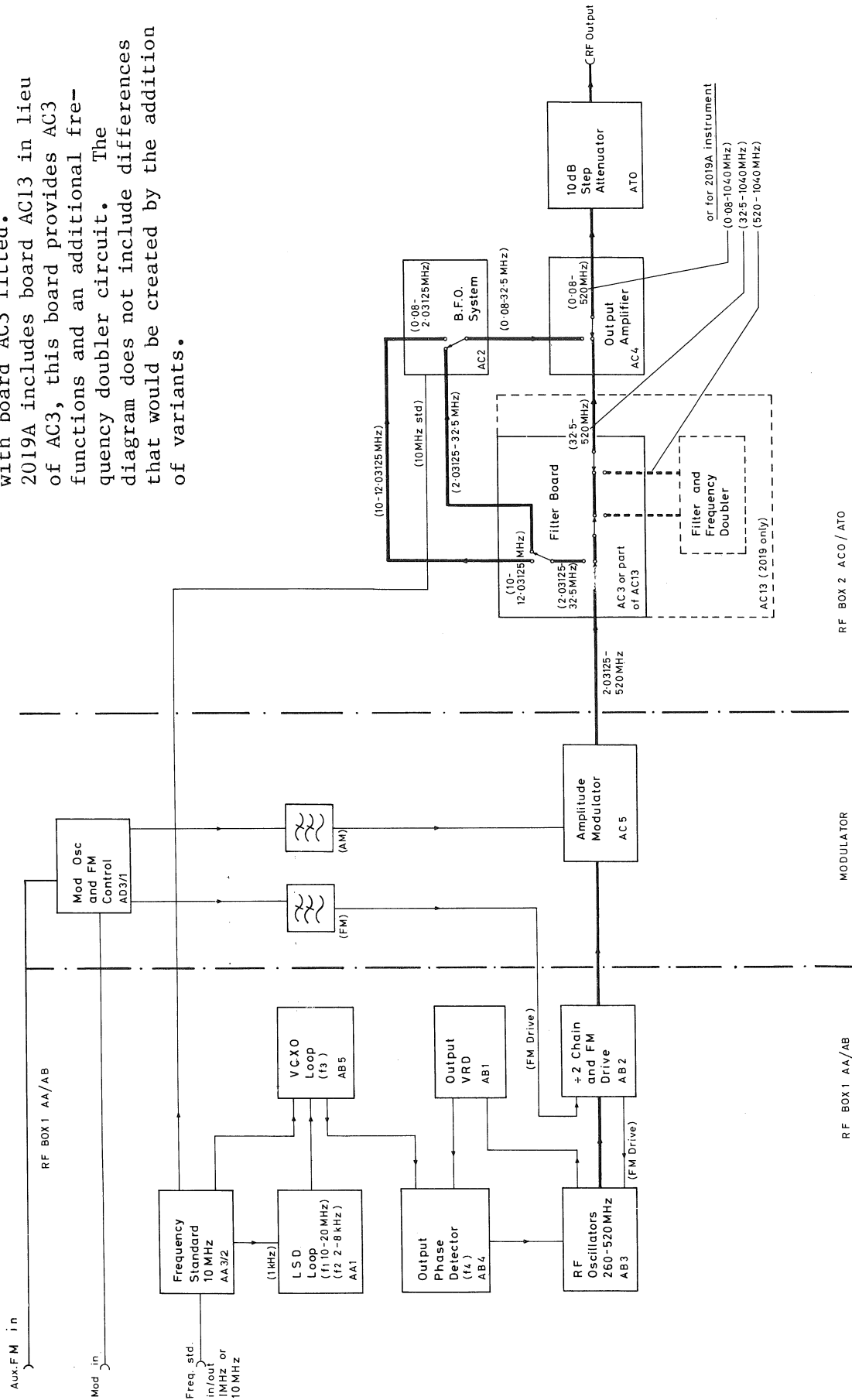

Fig. 9 2018A/2019A Simplified Block Diagram