

HP 8657D
 $\pi/4$ DQPSK
SIGNAL GENERATOR
(Including Option 001)

Operation and Calibration Manual

SERIAL NUMBERS

This manual provides complete information for instruments with serial-number prefix:

3119A and above and all MAJOR changes that apply to your instrument.

First Edition

This material may be reproduced by or for the U.S. Government pursuant to the Copyright License under the clause at DFARS 52.227-7013 (APR 1988).

Copyright ©HEWLETT-PACKARD COMPANY 1989
EAST 24001 MISSION AVENUE, TAF C-34, SPOKANE, WASHINGTON, U.S.A. 99220

Operation and Calibration Manual HP Part 08657-90107

Other Documents Available:

Service Manual HP Part 08657-90126

Microfiche Operation and Calibration Manual HP Part 08657-90127

Microfiche Service Manual HP Part 08657-90128

Printed in U.S.A.: May 1991



CERTIFICATION

Hewlett-Packard Company certifies that this product met its published specifications at the time of shipment from the factory. Hewlett-Packard further certifies that its calibration measurements are traceable to the United States National Institute of Standards and Technology, to the extent allowed by the Institute's calibration facility, and to the calibration facilities of other International Standards Organization members.

WARRANTY

This Hewlett-Packard instrument product is warranted against defects in material and workmanship for a period of one year from date of shipment. During the warranty period, Hewlett-Packard Company will at its option, either repair or replace products which prove to be defective.

For warranty service or repair, this product must be returned to a service facility designated by HP. Buyer shall prepay shipping charges to HP and HP shall pay shipping charges to return the product to the Buyer. However, Buyer shall pay all shipping charges, duties, and taxes for products returned to HP from another country.

HP warrants that its software and firmware designated by HP for use with an instrument will execute its programming instructions when properly installed on that instrument. HP does not warrant that the operation of the instrument, or software, or firmware will be uninterrupted or error free.

LIMITATION OF WARRANTY

The foregoing warranty shall not apply to defects resulting from improper or inadequate maintenance by Buyer, Buyer-supplied software or interfacing, unauthorized modification or misuse, operation outside of the environmental specifications for the product, or improper site preparation or maintenance.

NO OTHER WARRANTY IS EXPRESSED OR IMPLIED. HP SPECIFICALLY DISCLAIMS THE IMPLIED WARRANTIES OF MERCHANTABILITY AND FITNESS FOR A PARTICULAR PURPOSE.

EXCLUSIVE REMEDIES

THE REMEDIES PROVIDED HEREIN ARE BUYER'S SOLE AND EXCLUSIVE REMEDIES. HP SHALL NOT BE LIABLE FOR ANY DIRECT, INDIRECT, SPECIAL, INCIDENTAL, OR CONSEQUENTIAL DAMAGES, WHETHER BASED ON CONTRACT, TORT, OR ANY OTHER LEGAL THEORY.

ASSISTANCE

Product maintenance agreements and other customer assistance agreements are available for Hewlett-Packard products.

For any assistance, contact your nearest Hewlett-Packard Sales and Service Office.

REGIONAL SALES AND SERVICE OFFICES

ASIA

Hewlett-Packard Asia Ltd.
22/F Bond Centre, West
Tower
89 Queensway, Central
HONG KONG
G.P.O. Box 863 Hong Kong
Tel: 5-8487777
Telex: 76793 HPA HX
Cable: HPASIAL TD

CANADA

Hewlett-Packard (Canada) Ltd.
6877 Goreway Drive
**MISSISSAUGA, Ontario L4V
1M8**
Tel: (416) 678-9430
Telex: 069-8644

EASTERN EUROPE

Hewlett Packard Ges. m.b.h.
Liebigasse 1
P.O. Box 72
A-1222 **VIENNA, Austria**
Tel: (222) 2500-0
Telex: 1 3 4425 HEPA A

NORTHERN EUROPE

Hewlett-Packard S.A.
V.D. Hooplaan 241
P.O. Box 999
NL-118 LN 15 **AMSTELVEEN**
The Netherlands
Tel: 20 5479999
Telex: 18919 hpser

SOUTH EAST EUROPE

Hewlett-Packard S.A.
World Trade Center
110 Avenue Louis-Casai
1215 Cointrin, **GENEVA,**
Switzerland
Tel: (022) 98 96 51
Telex: 27225 hpner
Mail Address:
P.O. Box
CH-1217 Meyrin 1
GENEVA
Switzerland

MIDDLE EAST AND CENTRAL AFRICA

Hewlett-Packard S.A.
Middle East/Central
Africa Sales H.Q.
7, rue du Bois-du-Lan
P.O. Box 364
CH-1217 Meyrin 1
GENEVA
Switzerland
Tel: (022) 83 12 12
Telex: 27835 hmea ch
Telefax: (022) 83 15 35

UNITED KINGDOM

Hewlett Packard Ltd.
Nine Mile Ride
WOKINGHAM
Berkshire, RG113LL
Tel: 0344 773100
Telex: 848805/848814/848912

UNITED STATES OF AMERICA

Customer Information
Center
Tel: (800) 752-0900
6:00 AM to 5:00 PM
Pacific Time

EASTERN USA

Hewlett-Packard Co.
4 Choke Cherry Road
ROCKVILLE, MD 20850
Tel: (301) 670-4300

MIDWESTERN USA

Hewlett-Packard Co.
5201 Tollview Drive
ROLLING MEADOWS,
IL 60008
Tel: (312) 255-9800

SOUTHERN USA

Hewlett-Packard Co.
2015 South Park Place
ATLANTA, GA 30339
Tel: (404) 955-1500

WESTERN USA

Hewlett-Packard Co.
5161 Lankershim Blvd.
NORTH HOLLYWOOD,
CA 91601
Tel: (818) 505-5600

OTHER INTERNATIONAL AREAS

Hewlett-Packard Co.
Intercontinental
Headquarters
3495 Deer Creek Road
PALO ALTO, CA 94304
Tel: (415) 857-5027
Telex: 034-8300
Cable: HEWPACK

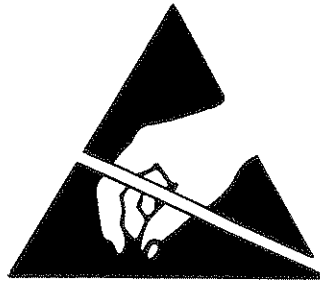

**ATTENTION
Static Sensitive
Devices**

This instrument was constructed in an ESD (electro-static discharge) protected environment. This is because most of the semi-conductor devices used in this instrument are susceptible to damage by static discharge.

Depending on the magnitude of the charge, device substrates can be punctured or destroyed by contact or mere proximity of a static charge. The results can cause degradation of device performance, early failure, or immediate destruction.

These charges are generated in numerous ways such as simple contact, separation of materials, and normal motions of persons working with static sensitive devices.

When handling or servicing equipment containing static sensitive devices, adequate precautions must be taken to prevent device damage or destruction.

Only those who are thoroughly familiar with industry accepted techniques for handling static sensitive devices should attempt to service circuitry with these devices.

In all instances, measures must be taken to prevent static charge build-up on work surfaces and persons handling the devices.

SAFETY CONSIDERATIONS

GENERAL

This product and related documentation must be reviewed for familiarization with safety markings and instructions before operation.

This product is a Safety Class I instrument (provided with a protective earth terminal).

BEFORE APPLYING POWER

Verify that the product is set to match the available line voltage and the correct fuse is installed.

SAFETY EARTH GROUND

An uninterruptible safety earth ground must be provided from the main power source to the product input wiring terminals, power cord, or supplied power cord set.

SAFETY SYMBOLS



Instruction manual symbol: the product will be marked with this symbol when it is necessary for the user to refer to the instruction manual (refer to Table of Contents.)



Indicates hazardous voltages.



Indicates earth (ground) terminal.

WARNING

The WARNING sign denotes a hazard. It calls attention to a procedure, practice, or the like, which, if not correctly performed or adhered to, could result in personal injury. Do not proceed beyond a WARNING sign until the indicated conditions are fully understood and met.

CAUTION

The CAUTION sign denotes a hazard. It calls attention to an operating procedure, practice, or the like, which, if not correctly performed or adhered to, could result in damage to or destruction of part or all of the product. Do not proceed beyond a CAUTION sign until the indicated conditions are fully understood and met.

WARNING

Any interruption of the protective (grounding) conductor (inside or outside the instrument) or disconnecting the protective earth terminal will cause a potential shock hazard that could result in personal injury. (Grounding one conductor of a two conductor outlet is not sufficient protection).

Whenever it is likely that the protection has been impaired, the instrument must be made inoperative and be secured against any unintended operation.

If this instrument is to be energized via an autotransformer (for voltage reduction) make sure the common terminal is connected to the earth terminal of the power source.

Servicing instructions are for use by service trained personnel only. To avoid dangerous electric shock, do not perform any servicing unless qualified to do so.

Adjustments described in the manual are performed with power supplied to the instrument while protective covers are removed. Energy available at many points may, if contacted, result in personal injury.

Capacitors inside the instrument may still be charged even if the instrument has been disconnected from its source of supply.

For continued protection against fire hazard, replace the line fuse(s) only with 250V fuse(s) of the same current rating and type (for example, normal blow, time delay, etc.) Do not use repaired fuses or short circuited fuseholders.

TABLE OF CONTENTS

Section 1—General Information

Introduction	1-1
Information Covered by this Manual	1-1
Specifications	1-1
Safety Considerations	1-1
Instruments Covered by this Manual	1-2
Options	1-2
Electrical Options	1-2
Mechanical Options	1-2
Documentation Options	1-3
Warranty Option	1-3
Accessories Supplied	1-3
Accessories Available	1-3
Recommended Test Equipment	1-3
Instrument Description	1-3
Carrier Frequency	1-3
Output Amplitude	1-4
Modulation Capabilities	1-4
Hewlett-Packard Interface Bus	1-4

Section 2—Installation

Introduction	2-1
Initial Inspection	2-1
Installation Check list	2-1
Preparation For Use	2-2
Power Requirements	2-2
Line Voltage Selection and Fuse Replacement	2-2
Power Cables	2-3
Operating Environment	2-5
Time Base Selection	2-5
Hewlett-Packard Interface Bus (HP-IB)	2-6
HP-IB Address Selection	2-6
Connection to the HP-IB	2-6
Cabling Restrictions	2-7
HP-IB Address Codes	2-8
Coaxial Connectors	2-9
Timebase Looping Cable	2-9
Pulse Modulation Input Impedance	2-9
I/Q Output Levels	2-10
Assembly/Disassembly Instructions	2-11
Mounting Kit Parts and Parts List	2-11
Assembly/Disassembly of the Units	2-12
Bench Operation	2-13
Rack Mounting	2-13
Internal Battery	2-13
Storage and Shipment	2-14
Environment	2-14
Packaging	2-14

Section 3—Operation

Introduction	3-1
Local Operation (description of)	3-1
Remote Operation (HP-IB) (description of)	3-1
User Confidence Tests (description of)	3-1
Power ON/STBY Instructions	3-2
Error Codes	3-2
Quick Start Operating Instructions	3-3
Remote Operation (HP-IB)	3-14
HP-IB Program Codes	3-20
Switching Characteristics	3-25
Detailed Operating Instructions	3-27
Amplitude	3-29
Amplitude Conversion	3-31
Amplitude Offset	3-33
Amplitude Up/Down	3-34
Display Amplitude Offset	3-36
Display	3-37
Display Sequence	3-38
Frequency	3-39
Frequency, Coarse and Fine Tune	3-41
Frequency, Phase Up/Down	3-43
Frequency, Up/Down	3-44
HP-IB Address Display	3-46
Increment Value Change	3-47
Increment Value Display	3-49
Instrument Preset	3-51
Modulation, AM	3-52
Modulation, AM Up/Down	3-54
Modulation, DC FM	3-56
Modulation, DC FM Up/Down	3-58
Modulation, External Source	3-60
Modulation, FM	3-62
Modulation, FM Up/Down	3-64
Modulation, Mixed	3-66
Modulation, Off	3-70
Modulation, Pulse	3-72
Modulation, $\pi/4$ DQPSK	3-73
Recall	3-75
RF ON/OFF	3-76
Save	3-77
Sequence	3-78
User Confidence Tests	3-80
Frequency Check	3-81
Output Level Checks	3-82
FM Check	3-83
DC FM Check	3-83
AM Check	3-83
Pulse Check	3-84
$\pi/4$ DQPSK Check	3-84
HP-IB Functional Checks	3-86

Section 4—Performance Tests

Introduction	4-1
Equipment Required	4-1
Performance Test Record	4-1
Calibration Cycle	4-1
Abbreviated Performance Testing	4-1
Test Procedures	4-2
Performance Test 1-Spectral Purity	4-3
Performance Test 2-Output Level Accuracy and Flatness	4-13
Performance Test 3-Modulation	4-18
Performance Test 4-Output Leakage	4-36
Performance Test Record	4-38

Section 5—Adjustments

Introduction	5-1
Safety Considerations	5-1
Equipment Required	5-1
Factory-Selected Components	5-1
Post-Repair Adjustments	5-1
Related Adjustments	5-1
Adjustment 1—Power Supply Voltage	5-4
Adjustment 2—Reference Voltage	5-5
Adjustment 3—Audio Oscillator Level	5-6
Adjustment 4—AM Offset	5-7
Adjustment 5—50 MHz Reference Oscillator Level	5-8
Adjustment 6—50 MHz Reference Oscillator Frequency	5-9
Adjustment 7—122 MHz Harmonic	5-10
Adjustment 8—200/400 MHz Bandpass Filter	5-11
Adjustment 9—690 to 740 MHz IF Flatness and Level	5-12
Adjustment 10—Notch Filter	5-14
Adjustment 11—400 MHz Notch Filter	5-17
Adjustment 12—Level and ALC Loop Detector	5-18
Adjustment 13—AM% and ALC Loop AM	5-20
Adjustment 14—FM Calibration Pretune	5-22
Adjustment 15—API 1,2,3, and 4	5-24
Adjustment 16—Pedestal	5-26
Adjustment 17—Integrator Input Offset	5-27
Adjustment 18—DC FM Spurious Signal	5-28
Adjustment 19—Voltage Offset	5-30
Adjustment 20—DC FM Offset	5-31
Adjustment 21—FM In-Band Gain	5-32
Adjustment 22—FM Deviation	5-34
Adjustment 23—Option 001 10 MHz Reference Oscillator Frequency	5-36
Adjustment 24— $\pi/4$ DQPSK Modulator	5-37

Section 1

GENERAL INFORMATION

1-1. INTRODUCTION

This manual contains information required to install, operate, test, and adjust the Hewlett-Packard Model 8657D $\pi/4$ DQPSK Signal Generator. Information required to troubleshoot and repair the HP 8657D is contained in the Service Manual, HP part 08657-90126. Listed on the title page of this manual, below the manual part number, is a *Microfiche* part number. This number may be used to order 100 × 150 millimeter (4 × 6 inch) microfilm transparencies of this manual. Each microfiche contains up to 96 photo-duplicates of the manual's pages. The microfiche package also includes the latest MANUAL UPDATES supplement, as well as all pertinent Service Notes.

1-2. INFORMATION COVERED BY THIS MANUAL

This manual consists of five sections as listed below:

Section 1 General Information, describes the instruments documented by this manual, it covers instrument description, options, accessories, specifications, and other basic information.

Section 2 Installation, provides information about initial inspection, preparation for use (which includes time-base selection, HP-IB address selection for remote operation and Assembly/Disassembly Instructions), and storage and shipment.

Section 3 Operation, provides information for local and remote operation (which includes Quick Start and Detailed Operating Instructions). This section also includes User Confidence Tests.

Section 4 Performance Tests, describes the procedures required to check the performance of the HP 8657D against the specifications listed in Table 1-1.

Section 5 Adjustments, describes the adjustment procedures required to enable the HP 8657D to meet the specifications listed in Table 1-1.

1-3. SPECIFICATIONS

HP 8657D specifications are listed in Table 1-1. These specifications are the performance standards or limits against which the HP 8657D may be tested. Supplemental characteristics are also listed in Table 1-1. Supplemental characteristics are not warranted specifications, but are typical characteristics included as additional information for the user.

1-4. SAFETY CONSIDERATIONS

This product is a Safety Class 1 instrument, that is, one provided with a protective earth terminal. The HP 8657D and all related documentation must be reviewed for familiarization with safety markings and instructions before operation. Refer to the Safety Considerations page found at the beginning of this manual for a summary of the safety information.

1-5. INSTRUMENTS COVERED BY THIS MANUAL

This instrument has a two-part serial number, in the form of 0000A00000. This is stamped on the serial number plate attached to the rear panel of the HP 8657D. The first four digits and the letter constitute the serial number prefix, and the last five digits form the suffix. The prefix is the same for all identical instruments. It changes only when a change is made to the instrument. The suffix is different for each instrument. The contents of this manual apply directly to instruments having the same serial number prefix(es) as listed under SERIAL NUMBERS on the title page.

Manual Updates. An instrument manufactured after the printing of this manual may have a serial prefix that is not listed on the title page. An unlisted serial prefix number indicates that the instrument differs in some way from those documented in this manual.

A *MANUAL UPDATES* packet is shipped with the manual, when necessary, to provide you with the most current information available at the time of shipment. These packets consist of replacement and addition pages which should be incorporated into the manual to bring it up to date.

Hewlett-Packard offers a *Documentation Update Service* that will provide you with further updates as they become available. If you operate or service instruments of different serial prefixes, we recommend that you join this service immediately to ensure that your manual is kept current. For more information refer to the Documentation Update Service reply card included with this manual.

1-6. OPTIONS

The following options are available and may have been ordered and received with your HP 8657D.

Electrical Option

High Stability Timebase Option 001. A 10 MHz crystal reference for increased frequency accuracy and stability is installed. You can add Option 001 after you have received your HP 8657D by ordering:

- HP part number 08657-61054.

Mechanical Options

To add any of the mechanical options after you have received your HP 8657D, order the appropriate HP part number listed with each option.

Rack Flange Kit Option 913. This kit contains all necessary hardware and installation instructions for mounting the HP 8657D in a rack with 482.5 millimeter (standard 19-inch) spacing. Order HP part 5062-4073 (for instruments with previously supplied handles).

Documentation Options

Extra Manual Set Option 910. Provides an additional copy of the Operation and Calibration Manual and two copies of the Service Manual.

Add Service Manual Option 915. Provides a copy of the Service Manual. The Service Manual contains information to enable qualified service personnel to troubleshoot and repair the HP 8657D.

Warranty Option

Three-Year Extended Hardware Support Option W30. Provides two additional years of return-to-HP hardware service support (for second and third years).

1-7. ACCESSORIES SUPPLIED

The accessories supplied with the HP 8657D are:

- Appropriate power cords, see table 2-2 in Section 2.
- An Operating and Calibration Manual.
- A coaxial looping cable (Option 001 only).

1-8. ACCESSORIES AVAILABLE

The following accessories are available for use with the HP 8657D:

- 50 Ω to 75 Ω Adapter, HP model number 11687A (Frequency to 1.3 GHz).
- HP 8657D Transit Case, HP part number 9211-2663.
- Slide Rack Mount Kits - see paragraph 2-18 for further information.

1-9. RECOMMENDED TEST EQUIPMENT

Table 1-2 lists the test equipment required for testing, adjusting, and servicing the HP 8657D. The Critical Specifications column describes the essential requirements for each piece of test equipment. Other equipment can be substituted if it meets or exceeds these critical specifications.

Table 1-4 lists alternate test equipment that can be used. Alternate models may be suggested for additional features that would make them a better choice in some applications. For example, some reasons for recommending an alternate model might be:

- HP-IB programmability,
- Multi-function capability (that is, one model can replace two or more single purpose models).

1-10. INSTRUMENT DESCRIPTION

The Hewlett-Packard Model 8657D $\pi/4$ DQPSK is a dual mode synthesized signal generator with a carrier frequency range of 100 kHz to 1040 MHz. Its output amplitude is leveled and calibrated from +13 to -143.5 dBm. AM and/or FM functions can be individually selected. Pulse modulation and $\pi/4$ DQPSK digital modulation are available, but require external inputs. The carrier frequency, output amplitude, and modulation functions can be remotely programmed via the Hewlett-Packard Interface Bus. The unique modular design and incorporated service features permit rapid and easy calibration and service.

Carrier Frequency

The HP 8657D covers a carrier frequency range of 100 kHz to 1040 MHz (10 kHz with uncalibrated output and modulation). Frequency resolution is 1 Hz. A 10-digit LED display of the carrier frequency in MHz is provided. Pushbutton keys permit coarse tuning, fine tuning, and incrementing of the carrier frequency.

Frequency accuracy and stability are dependent on the reference source being used, either the internal 50 MHz reference oscillator or an external source that operates at 1, 5, or 10 MHz. With Option 001, a 10 MHz crystal reference is available for increased accuracy and stability.

Output Amplitude

The HP 8657D has precise power levels from +13 to -143.5 dBm (114 dB μ V to 36.5 dB μ V) with overrange to +17 dBm at decreased accuracy. The output amplitude from +3.5 to -127 dBm is accurate to less than ± 1.0 dB. Level flatness at 100 kHz to 1040 MHz is less than ± 0.5 dB with an output amplitude setting of 0.0 dBm. Output amplitude resolution is 0.1 dB. A 3^{1/2}-digit LED display of output amplitude is provided with 7 LED annunciators used to display unit information.

Power levels at $\pi/4$ DQPSK digital frequency bands are as follows:

10 to 129.9 MHz	+3dBm to -143.5dBm
810 to 965 MHz	+7dBm to -143.5dBm
1420 to 1540 MHz	+3dBm to -143.5dBm

Modulation Capabilities

The HP 8657D features a versatile internal and external modulation capability for AM and FM. A 3-digit display of AM depth or FM peak deviation is provided with 11 LED annunciators used to display internal or external modulation source information. Keyboard entries of AM depth up to 100% with a resolution of 1%, and FM peak deviation up to 400 kHz. The resolution of the FM peak deviation depends on the frequency of the carrier signal.

Pulse modulation requires an external signal source and $\pi/4$ DQPSK digital modulation requires external clock and data inputs. $\pi/4$ DQPSK digital modulation capabilities fulfill the testing requirements of the North American Digital Cellular System and the Japanese Digital Cellular System.

$\pi/4$ DQPSK digital modulation is available in the following frequencies:

- 810 MHz to 965 MHz (North American Digital Cellular System)
- 1420 MHz to 1540 MHz (Japanese Digital Cellular System)
- 10 MHz to 129.9 MHz

Hewlett-Packard Interface Bus

The HP 8657D has an HP-IB interface and can be used with any HP-IB computing controller or computer for automatic system applications. The HP 8657D is fully programmable via the HP-IB. The HP 8657D's complete compatibility with HP-IB is defined by the following list of interface functions: SH0, E1, AH1, T0, L2, SR0, RL1, PP0, DC1, DT0, and C0. The Signal Generator interfaces with the bus via open collector TTL circuitry. An explanation of the compatibility codes can be found in the IEEE Standard 488 and the identical ANSI Standard MC1.1.

Table 1-1. HP 8657D Digital Specifications

SPECIFICATIONS describe the instruments warranted performance and apply after a 30 minute warm-up. All SPECIFICATIONS are valid over the signal generator's entire Operating/Environmental Range unless otherwise noted.

SUPPLEMENTAL CHARACTERISTICS (shown in Italics) are intended to provide additional information useful in applying the instrument by giving typical (expected), but not warranted performance.

Analog Modulation Mode:

All specifications for the HP 8657D in analog mode are identical to those of the HP 8657B Signal Generator for frequencies from 100 kHz to 1030 MHz (overrange to 1040 MHz). Please refer to the HP 8657B specifications on the following pages for complete HP 8657D analog mode specifications.

$\pi/4$ DQPSK Modulation Mode

FREQUENCY

Range (10-digit LED display):

10 MHz to 129.9 MHz.

810 MHz to 965 MHz.

1420 MHz to 1540 MHz.

Resolution: 1 Hz.

Switching Speed (to be within 100 Hz of final frequency):

<35 ms.

Accuracy and Stability: Same as timebase used.

SPECTRAL PURITY

SUPPLEMENTAL CHARACTERISTICS

Harmonics: Typically <-30 dBc.

Nonharmonic Spurious: Typically <-50 dBc.

Residual FM (no data clock): Typically <6 Hz rms in a 300 Hz to 3 kHz BW.

SSB Phase Noise (no data clock): Typically <-105 dBc/Hz at a 20 kHz offset.

OUTPUT

Level Range: -143.5 dBm minimum in all ranges. +3 dBm maximum; 1420 to 1540 MHz and 10 MHz to 129.9 MHz. +7 dBm maximum; 810 to 965 MHz.

Resolution: 0.1 dB.

Level Accuracy: ± 1.0 dB (-127 dBm to +3 dBm).

$\pi/4$ DQPSK MODULATION

Modulation Format: $\pi/4$ DQPSK.

Data Rate:

Symbol Clock: 20 kHz to 25 kHz.

Bit Clock: 40 kHz to 50 kHz.

Pre-modulation Filter: Square-root raised cosine.

Filter Shape Factor: $\alpha = 0.35$ or $\alpha = 0.50$.

Error Vector Magnitude (+15° C to +35° C):

<4%; 10 MHz to 129.9 MHz and 1420 to 1540 MHz, level

< +3 dBm. <3.5%; 810 MHz to 965 MHz, level < +7 dBm.

I/Q Origin Offset (+15° C to +35° C):

-35 dB (RF output only).

Inputs: Serial data and clock (bit or symbol).

Outputs: Baseband $\pi/4$ DQPSK I and Q signals.

SUPPLEMENTAL CHARACTERISTICS

Input Levels: Nominally TTL.

Input Impedance: Nominally 1 k Ω .

Output Levels:

Symbol Clock: Nominally TTL level.

N \times Symbol Clock: Nominally TTL level.

128 \times Symbol Clock: Nominally TTL level.

Baseband $\pi/4$ DQPSK I and Q Output Level: Typically 0.35 volts into a 50 Ω load.

Simultaneous Modulation: $\pi/4$ DQPSK and pulse (AM and FM are not available in $\pi/4$ DQPSK modulation mode).

PULSE MODULATION

(standard on HP 8657D, pulse modulation is available in either the analog or $\pi/4$ DQPSK modulation mode.)

On/Off Ratio: >70 dB; $f_c \leq 1030$ MHz. >50 dB; 1420 MHz $\leq f_c \leq 1540$ MHz ($\pi/4$ DQPSK mode).

Rise/Fall Time (10% to 90%): 35 ns, typically 10 ns.

GENERAL

Remote Operation: HP-IB. All functions but the line switch, sequence control, digital modulation polarity, and digital filter shape factor are remotely programmable.

Operating Temperature Range: 0 to +55°C.

Storage Temperature Range: -55 to +75°C.

Power Requirements: HP 8657D: 100 or 120 or 200 or 240 volts ($\pm 10\%$) from 48 to 440 Hz; 200 VA maximum. $\pi/4$ DQPSK modulator: 90 to 264 volts from 48 to 66 Hz; 75 VA maximum.

Weight: Net 26.4 kg (58 lb); shipping 37.3 kg (82 lb).

Dimensions: 223H \times 425W \times 575 mm (8.75 \times 16.8 \times 22.6 inches).

Table 1-1. HP 8657B Specifications (1 of 3)

All specifications in analog mode are identical to those of the HP 8657B from 100 MHz to 1030 MHz (overrange to 1040 MHz).

SPECIFICATIONS describe the instruments warranted performance and apply after a 30 minute warm-up. All SPECIFICATIONS are valid over the signal generator's entire Operating/Environmental Range unless otherwise noted.

SUPPLEMENTAL CHARACTERISTICS (shown in italics) are intended to provide additional information useful in applying the instrument by giving typical (expected), but not warranted performance.

FREQUENCY

Range (10-digit LED display): 100 kHz to 2060 MHz.

Resolution: 1 Hz.

Switching Speed (to be within 1 dB of level and within 100 Hz of carrier frequency): <35 ms⁷.

30 ms typical at 25°C.

Accuracy and Stability: Same as time base used.

SUPPLEMENTAL CHARACTERISTICS

Frequency Underrange: To 10 kHz with uncalibrated output and modulation.

Phase Offset: Output signal phase is adjustable in 1 degree increments.

Timebase Characteristics:

	Standard	Option 001
Aging Rate	±2 ppm/year	1.0 x 10 ⁻⁹ /day after 45 days
Temperature (0-55°C)	±10 ppm	7 x 10 ⁻⁹
Line Voltage	—	2 x 10 ⁻⁹ (+5%,-10%)
Frequency	50 MHz	10 MHz
Timebase Reference Signal (Rear Panel)	Available at a level of >0.15 V _{rms} into 50 Ω (Output of 10, 5, or 1 MHz is selectable via internal jumper). If external reference is used, output will be the same frequency.	
External Reference Input (Rear Panel)	Accepts any 10, 5, or 1 MHz (±0.002%) Input (Rear Panel) frequency standard at a level >0.15 V _{rms} into 50 Ω.	

SPECTRAL PURITY

Spurious Signals (≤+7 dBm output levels)¹:

Type of Spurious	Frequency (MHz)		
	0.1-1030	1030-1800	1800-2060
Harmonic	<- 30 dBc	<- 25 dBc	<- 25 dBc
Sub-harmonic	None	<- 40 dBc	<- 35 dBc

Nonharmonic Spurious:

Carrier Frequency	Carrier Offset	
	>5 kHz (Typical)	>2 MHz
0.1 to 130	<- 63 dBc	<- 60 dBc
130 to 260	<- 75 dBc	<- 60 dBc
260 to 520	<- 66 dBc	<- 60 dBc
520 to 1030	<- 63 dBc	<- 60 dBc
1030 to 2060	<- 57 dBc	<- 54 dBc

Residual FM in Hz rms (in CW mode):

Post Detection Bandwidth	Frequency Range (MHz)				
	0.1-130	130-260	260-520	520-1040	1040-2060
0.3 - 3 kHz	<4 Hz	<1 Hz	<2 Hz	<3 Hz	<6 Hz
0.05 - 15 kHz	<6 Hz	<1.5 Hz	<3 Hz	<4 Hz	<8 Hz
Typical Residual FM:					
0.3 - 3 kHz	<2 Hz	<0.5 Hz	<0.5 Hz	<1 Hz	<2 Hz
0.3 - 3 kHz (CCITT)	<1.25 Hz	<0.25 Hz	<0.25 Hz	<0.5 Hz	<1.0 Hz
0.05 - 15 kHz	<3 Hz	<1 Hz	<1 Hz	<1.5 Hz	<3 Hz

Residual AM (50 Hz to 15 kHz post-detection noise bandwidth, in CW mode): <0.04% AM.

SSB Phase Noise (in CW Mode):

Carrier Frequency	SSB φ-Noise 20 kHz offset	Typical 20 kHz offset
0.1 to 130 MHz	<- 124 dBc/Hz	<- 130 dBc/Hz
130 to 260 MHz	<- 136 dBc/Hz	<- 140 dBc/Hz
260 to 520 MHz	<- 130 dBc/Hz	<- 136 dBc/Hz
520 to 1040 MHz	<- 124 dBc/Hz	<- 130 dBc/Hz
1040 to 2060 MHz	<- 118 dBc/Hz	<- 123 dBc/Hz

SUPPLEMENTAL CHARACTERISTICS

Typical SSB Phase Noise

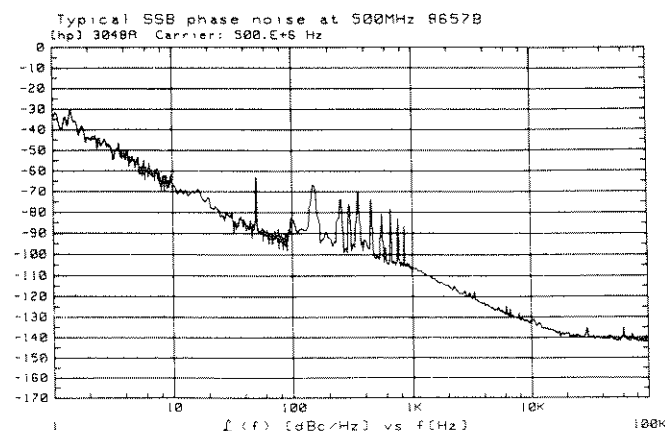

Table 1-1. HP 8657B Specifications (2 of 3)

All specifications in analog mode are identical to those of the HP 8657B from 100 MHz to 1030 MHz (overrange to 1040 MHz).

OUTPUT

Level Range (3 1/2-digit LED display): +13 dBm to -143.5 dBm into 50Ω².

Resolution: 0.1 dB.

Absolute Level Accuracy³:

< ±1.0 dB (+3.5 to -127 dBm),

< ±1.5 dB (level >+3.5 dBm).

Level Flatness (100 kHz to 2060 MHz): ±0.5 dB, output level setting of 0 dBm.

Reverse-Power Protection: Protects the signal generator from applications of up to 50 watts of RF power (from a 50Ω source) to 2060 MHz into generator output; DC voltage cannot exceed 25 V.

SUPPLEMENTAL CHARACTERISTICS

Attenuator Repeatability: 0.01 dB

Impedance: 50 Ω Nominal.

Output Level Overage: To +17 dBm

Absolute level Accuracy: 1.5 dB, output levels ≤ -127 dBm.

SWR: <1.5 for levels ≤ -6.5 dBm.

<2.0 for levels ≤ +13 dBm.

AMPLITUDE MODULATION

AM Depth ($f_c > 400$ kHz⁴):

0 to 100%, level ≤ +7 dBm.

0 to 30%, level ≤ +10 dBm.

Resolution: 1%.

AM Rate Internal: 400 Hz and 1 kHz, ± 2%.

External: 20 Hz to 40 kHz (1 dB bandwidth)

20 Hz to 100 kHz (3 dB bandwidth) Typical.

AM Distortion (at 400 Hz and 1 kHz rates, levels ≤ +7 dBm):

AM Depth	$f_c < 1030$	$f_c > 1030$
0 to 30 % AM	1.5%	4%
31 to 70 % AM	3.0%	4%
71 to 90 % AM	4.0%	7%

Indicator Accuracy (for depths < 90%, 400 Hz and 1 kHz rates and levels ≤ +7 dBm): ±(6% of setting + 2%).

Incidental Phase Modulation (at 30% AM depth, internal rates): < 0.3 radians peak.

FREQUENCY MODULATION

Maximum FM Peak Deviation:

Center Frequency	Maximum Peak Deviation	
	AC Mode (the lesser of)	DC Mode
0.1 to 130 MHz	200 kHz or 4000 x rate (Hz)	200 kHz
130 to 260 MHz	50 kHz or 1000 x rate (Hz)	50 kHz
260 to 520 MHz	100 kHz or 2000 x rate (Hz)	100 kHz
520 to 1040 MHz	200 kHz or 4000 x rate (Hz)	200 kHz
1040 to 2060 MHz	400 kHz or 8000 x rate (Hz)	400 kHz

FM specified when peak deviation is > ($f_c + 100$ Hz)

FM Setting Resolution:

FM Deviation	Carrier Frequency	
	$f_c < 1040$ MHz	$f_c > 1040$ MHz
<100 kHz	100 Hz	200 Hz
>100 kHz	1 kHz	2 kHz

FM Rate Internal: 400 Hz and 1 kHz, ±2%.

External: (referenced to 1 kHz)

dc/5 Hz to 100 kHz, 3 dB bandwidth.

dc/20 Hz to 50 kHz, 1 dB bandwidth.

Center Frequency Accuracy in dc Mode:

Carrier Frequency	Center Frequency Accuracy
0.1 to 130 MHz	± 500 Hz
130 to 260 MHz	± 125 Hz
260 to 520 MHz	± 250 Hz
520 to 1040 MHz	± 500 Hz
1040 to 2060 MHz	± 1000 Hz

Center Frequency Stability in dc Mode: <10 Hz per hour drift.

FM Distortion (at 400 Hz and 1 kHz rates): <0.5% THD plus noise at deviations shown in the following table.

FM Distortion (at 400 Hz and 1 kHz rates):

Center Frequency	Deviation kHz
0.1 to 130 MHz	3 to 100 kHz
130 to 260 MHz	3 to 25 kHz
260 to 520 MHz	3 to 50 kHz
520 to 1040 MHz	3 to 100 kHz
1040 to 2060 MHz	6 to 200 kHz

Indicator Accuracy (400 Hz and 1 kHz): < 5% of setting
Incidental AM (peak dev. <20 kHz, 400 Hz and 1 kHz rates): <0.5% $f_c > 1030$ <0.1% AM, $f_c > 500$ kHz.

SUPPLEMENTAL CHARACTERISTICS

FM Distortion: Worst case distortion at all specified deviations, rates, and carrier frequencies is 1.5%.

External Sensitivity: 1 volt peak for indicated accuracy (1 volt dc when in dc-FM mode).

External Modulation Input: Front panel BNC, 600 Ω dc-coupled; front panel annunciators indicate 1 V peak signal ± 5%.

Modulating Signal Output: Internal modulating signal is provided at the front panel BNC connector at nominally 1 volt peak into a 600 Ω resistive load.

Simultaneous Modulation:

Internal/External: AM/FM, FM/AM, AM/AM, FM/FM, AM/FM/Pulse⁵

Table 1-1. HP 8657B Specifications (3 of 3)

All specifications in analog mode are identical to those of the HP 8657B from 100 MHz to 1030 MHz (overrange to 1040 MHz).

Long Term Carrier Stability in dc FM Mode.

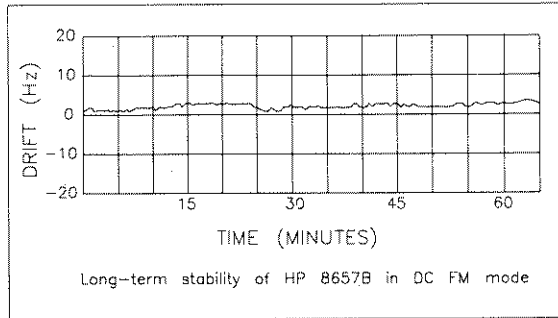

PULSE MODULATION ⁵

ON/OFF Ratio: >70 dB, $f_c \geq 130$ MHz.
>95 dB, $f_c \geq 1030$ MHz.

Rise/Fall Time: < 35 nanoseconds, $f_c \leq 130$ MHz
< 50 nanoseconds, $f_c \geq 1030$ MHz

Supplemental Characteristics:

Typical Rise/Fall Time: 10 ns, $f_c < 1030$ MHz;
18 ns, $f_c > 1030$ MHz.

Maximum Repetition Rate: DC - 30 MHz.

Level Accuracy: ± 1.0 dB absolute level accuracy in Pulse Mode.

Duty Cycle: 0 - 100%. (limited by rise/fall time)

Pulse Modulation Input: BNC, 50 ohms nominal or high impedance (internally selectable), can be driven directly by TTL.

Maximum Input Level: ± 15 V.

Nominal Input Threshold: 1.6 V.

Video Feedthrough: <15%.

Pulse Time Delay ⁶:

Off to On: 47 nanoseconds

On to Off: 34 nanoseconds

REMOTE PROGRAMMING

Interface: HP-IB (Hewlett-Packard's implementation of IEEE Standard 488).

Interface Functions Implemented: SH0, AH1, T0, L2, SR0, RL1, PP0, DC1, DT0, C0, E1.

GENERAL

Operating Temperature Range: 0 to +55°C.

Storage Temperature Range: -40 to +70°C.

Leakage: Conducted and radiated interference is within the requirements of CE03 and RE02 of MIL STD 461B, except broadband conducted below 70 kHz and FTZ 1115.

Furthermore, RF leakage of less than 1.0 μ V is induced in a two-turn loop, 2.5 cm in diameter, held 2.5 cm away from the front surface. (Typical leakage <0.05 μ V levels <-40 dBm.)

Save/Recall/Sequence Storage Registers:

100 non-volatile registers are available to save front panel settings.

Rear Panel SEQ Input Level: TTL low to recall next storage register contents.

Power Requirements: 100 or 120 or 220 or 240 volts ($\pm 10\%$) from 48 to 440 Hz; 200 VA maximum.

Weight: Net 19.5 kg (43 lb); shipping 25.0 kg (55 lb).

Dimensions: 133H x 425W x 574D mm
(5.25 x 16.75 x 22.6 inches.)

HP System II module size: 5 1/4H x 1MW x 17 D.

¹ Spurious specifications apply for output levels $\leq +4$ dBm and $f_c < 1030$ MHz when pulse modulation is installed.

² Maximum output power is +10 dBm with pulse modulation installed at $f_c < 1030$ MHz.

³ Absolute level accuracy includes allowances for detector linearity, temperature, flatness, attenuator accuracy and measurement uncertainty.

⁴ When pulse modulation is installed, maximum specified output level in AM is reduced by 3 dB when $f_c < 1030$ MHz.

⁵ Pulse modulation specifications apply for carriers >130 MHz and levels $\leq +7$ dBm (frequency switching speed typically increases by 30 ms with pulse modulation on). Additionally, AM is unspecified with pulse modulation turned on at $f_c \geq 1030$ MHz.

⁶ Time delay between a change in input pulse and carrier response.

⁷ Add 5 ms to amplitude switching settling when switching to $f_c \geq 1030$ MHz.

Table 1-2. Recommended Test Equipment (1 of 4)

Instrument Type	Critical Specifications	Recommended Model	Use ¹
AM/FM Test Source (required for Measuring Receiver verification)	Range: 10 MHz Residual AM ² FM Flatness: $\pm 1\%$ (dc to 250 kHz) Peak Deviation: to 100 kHz	HP 11715A	P
Audio Source	Level: 0.0 to 1 Vpk into 50 and 600 ohms Frequency: 25 Hz to 40 kHz	HP 8903B	P, A, T
Controller, HP-IB	HP-IB compatibility as defined as IEEE Standard 488 and the identical ANSI Standard MC1.1: SHO, E1, AH1, T4, TEO, LO, LEO, SRO, RLO, PPO, DCO, DTO, and C1, 2, 3, 28.	Use any HP controller and HP-IB interface to implement HP-IB functional checks	T
DC Power Supply	Output: 0-1 V Current: 500 mA	HP 6214C	A
Digital Multimeter	Accuracy: $4\frac{1}{2}$ digit, $\pm 0.05\%$ of reading ± 3 Ranges: 20 mV to 30 Vdc and 2 Vac Sensitivity: 100 μ V	HP 3466A or HP 3455A (see Table 1-3)	P, A, T
Distortion Analyzer	Distortion Range: $< 0.1\%$ Range: 20 Hz to 40 kHz	HP 8903B	P, T
Frequency Counter	Range: 1300 MHz Resolution: 1 Hz	HP 5328B Opt. 031	A, T
Pulse/Function Generator	Freq Range: 1 MHz to 50 MHz Function: Sine, Square, Pulse, etc. Output Level: 16 Vpp max into 600 ohms	HP 8116A	P
Function Generator	Frequency Range: 500 Hz Function: Square wave Output Level: 1 Vp into 600 ohms	HP 3312A	T
Loop Antenna	To ensure measurement accuracy, no substitution is possible. Fabrication depends upon machining and assembling to close tolerances.	HP 08640-60501	P
Measuring Receiver and Sensor Module	Frequency Range: 150 kHz to 1300M Hz Input Level: -127 to $+13$ dBm RF Power: 0.2 dB Tuned RF Level: 0.36 dB RSS Referenced to -10 dBm input	HP 8902A and 11722A (option 003 required for Residual FM Optional Performance Test)	P, A, T

¹ A = Adjustments; P = Performance Tests; T = Troubleshooting.

² The residual AM specification of both the HP 8902A Measuring Receiver and HP 11715A AM/FM Test Source are stated in a 50 Hz to 3 kHz bandwidth. In order to assure the validity of the residual AM measurement in the bandwidths stated for the HP 8657D Signal Generator (namely, 50 Hz to 15 kHz) the combined performance of both the HP 8902A and HP 11715A must be verified to be better than 0.022% rms for the 50 Hz to 15 kHz bandwidth.

Table 1-2. Recommended Test Equipment (2 of 4)

Instrument Type	Critical Specifications	Recommended Model	Use ³
Measuring Receiver and Sensor Module (Cont'd)	<p>Amplitude Modulation:</p> <p>Rates⁴: 25 Hz to 25 kHz Depth: to 99% Accuracy: Flatness: $\pm 0.5\%$ Demodulated Output Distortion: 0.3% for 50% depth; <0.6% for 90% depth Incidental ΩM: <0.05 radians for 50% depth at 1 kHz rate (50 Hz to 3 kHz bandwidth) Residual AM⁵</p> <p>Frequency Modulation:</p> <p>Rates: 5 Hz to 100 kHz Deviation to 400 kHz Accuracy $\pm 2\%$ at 1 kHz Demodulated Output Distortion: <0.3% Incidental AM⁵ Residual FM: <8 Hz rms at 1300 decreasing linearly with frequency to <1 Hz rms for 1000 MHz and below (50 Hz to 3 kHz bandwidth)</p> <p>Audio Distortion:</p> <p>Frequencies: 400 Hz and 1 kHz, $\pm 5\%$ Display Range: < 0.1% Accuracy: ± 1 dB of reading</p>	<p>HP 8902A and 17722A</p> <p>$\pm 2\%$ at 1 kHz</p>	<p>P, A, T</p>
Oscilloscope and Probes	<p>Vertical Sensitivity: 100 mV/div Pods: 54002A 50 Ω input 54003A 1MΩ input and 10:1 probe 54003-61617 Bandwidth: 50 MHz Time Base: .05 μsec Input: Dual Channel</p>	<p>HP 54100A⁶</p>	<p>P, A, T</p>

³ A = Adjustments; P = Performance Tests; T = Troubleshooting.

⁴ The incidental AM specification for the HP 8657D is not equivalent to the published specification of the HP 8902A Measuring Receiver. In order to assure the validity of the Incidental AM measurement, the incidental AM of the modulation analyzer must be verified to be less than 0.002% for the 300 Hz to 20 kHz peak deviation at internal rates.

⁵ The residual AM specification of both the HP 8902A Measuring Receiver and HP 11715A AM/FM Test Source are stated in a 50 Hz to 3 kHz bandwidth. In order to assure the validity of the residual AM measurement in the bandwidths stated for the HP 8657D Signal Generator (namely, 50 Hz to 15 kHz) the combined performance of both the HP 8902A and HP 11715A must be verified to be better than 0.022% rms for the 50 Hz to 15 kHz bandwidth.

⁶ See Table 1-4 for an alternate oscilloscope listing.

Table 1-2. Recommended Test Equipment (3 of 4)

Instrument Type	Critical Specifications	Recommended Model	Use ⁷
Phase Noise Measurement System	Frequency Range: 0.1 to 1600 MHz Offset: 20 kHz Accuracy: ± 2 dB Noise Floor: -145 dB	HP 3048A	P
Reference Source	Frequency: 0.1 to 1600 MHz Level: $+13$ dBm SSB Phase Noise (20 kHz offset): < -124 dBc/Hz, 0.1 to 130 MHz < -136 dBc/Hz, 130 to 260 MHz < -130 dBc/Hz, 260 to 520 MHz < -124 dBc/Hz, 520 to 1040 MHz	HP 8657D or HP 8662A	P
Signal Source (optional)	Residual SSB phase noise in 1 Hz Bw ($320 \text{ MHz} \leq f_c < 640 \text{ MHz}$) with an offset from the carrier of: -100 dBc at 10 Hz, -121 dBc at 1 kHz, and -131 dBc at 10 kHz	HP 8662A (for Optional Residual FM Test)	P
Signature Analyzer	Provides preferred method for troubleshooting digital circuitry	HP 5005A	T
Spectrum Analyzer, RF	Frequency Range: 0.1 to 2060 MHz Resolution Bandwidth: < 1 kHz to 3 kHz	HP 8562B or HP 8555A/8552B/141T	P, A, T
Wideband Amplifier	Gain: 20 or greater Frequency Range: 10 MHz to 1300 MHz Impedance: 50 ohms Connector: Type N	HP 8447D Option 010	P
Termination	Frequency Range: 0.1 to 2060 MHz Termination: 50ohms SWR: < 1.05	HP 908A	P
Multifunction Synthesizer	Frequency Range: 24.3 kHz Resolution: 10 Hz Amplitude: 10 Volts Waveform: Sine	HP 8904A Option 002	P,T
RF Signal Generator	Frequency range: 100 kHz to 990 MHz Output Level ≥ 17 dBm	HP 8656B	P,T

⁷ A = Adjustments; P = Performance Tests; T = Troubleshooting.

Table 1-2. Recommended Test Equipment (4 of 4)

Instrument Type	Critical Specifications	Recommended Model	Use ⁷
Spectrum Analyzer	Frequency Range: 2 GHz Resolution Bandwidth: 1 MHz	HP 8562A, HP 8566B, HP 8592A	P,A,T
$\pi/4$ DQPSK Modulator	No Substitute	HP 11847A, HP 70001A, HP 70700A, HP 70912A, Series 300 Computer, Printer (HP-IB) or Display	P

⁷ A = Adjustments; P = Performance Tests; T = Troubleshooting.

Table 1-3. Recommended Accessories

Adapter/Cable	Quantity	Type	Recommended Model	Use ¹
Coaxial	1	BNC(f) to BNC(f)	HP 1250-0080	A, T
Coaxial	1	N(f) to BNC(m)	HP 1250-0077	A
Coaxial	3	N(m) to BNC(f)	HP 1250-0780	P, A, T
Probe	2	SMC(f) to RF Test Point	HP 1250-1598	A, T
RF	2	BNC(f) to SMC(f)	HP 08662-60075	P
RF	1	Connector: UG-21D/U Type N(m)	HP 11500A	P, A, T
RF	2	Connector: UG-21D/U Type N(m)	HP 11500B	P, A, T
RF	1	BNC to BANANA	HP 1100-60001	P
RF	2	BNC to BNC	HP 10503A or 8120-1840	P, A
PROBE	1	Alligator Clip to BNC	8120-1292	A

¹ A = Adjustments; P = Performance Tests; T = Troubleshooting.

Table 1-4. Alternate Test Equipment

Instrument	Recommended Model	Suggested Alternative	Advantages of Alternative
Digital Voltmeter (DVM)	HP 3466A	HP 3455A	HP-IB* Compatible
Oscilloscope	HP 54100A	HP 54110A	Availability

* HP-IB is Hewlett-Packard's implementation of IEEE Standard 488 and the identical ANSI Standard MC1.1

Section 2 INSTALLATION

2-1. INTRODUCTION

This section provides installation instructions for the the HP 8657D. Included is information regarding initial inspection, power requirements, line voltage and fuse selection, power cables, time base selection, HP-IB address selection, interconnection, mating connectors, operating environment, rack mounting, storage, and shipment.

2-2. INITIAL INSPECTION

WARNING

To avoid hazardous electrical shock, do not apply power to the HP 8657D when there are any signs of shipping damage to any part of the HP 8657D.

Inspect the shipping container for damage. If the shipping container or cushioning material is damaged, it should be kept until the contents of the shipment have been checked for completeness and the instrument has been checked mechanically and electrically. Procedures for checking electrical performance are given in Section 4. If the contents are incomplete, if there is mechanical damage or defect, or if the instrument does not pass the electrical performance test, notify the nearest Hewlett-Packard office. If the shipping container is damaged, or the cushioning material shows signs of stress, notify the carrier as well as the Hewlett-Packard office. Keep the shipping materials for the carrier's inspection.

2-3. INSTALLATION CHECK LIST

Before connecting the HP 8657D to the line (mains) voltage, take the following steps:

1. Read through the following paragraphs:
 - 2-4. PREPARATION FOR USE.
 - 2-5. POWER REQUIREMENTS.
 - 2-6. LINE VOLTAGE SELECTION AND FUSE REPLACEMENT.
 - 2-7. POWER CABLES.
2. *Before* assembling the two units together, read the following:
 - The HP-IB address is factory set to 07. If you wish to change the HP-IB address, read paragraph 2-11. **HP-IB ADDRESS SELECTION.**
 - The pulse modulation input impedance is factory set high. If you wish to change this setting, read paragraph 2-15. **PULSE MODULATION INPUT IMPEDANCE.**
 - I/Q output level is factory set for 0.35 Vp. If you wish to change this setting, read paragraph 2-16. **I/Q OUTPUT LEVELS.**
3. To assemble the two units together, see paragraph 2-17. **ASSEMBLY/DISASSEMBLY INSTRUCTIONS.**

2-4. PREPARATION FOR USE

WARNING

This is a Safety Class 1 product (i.e., provided with a protective earth terminal). An uninterruptible safety earth ground must be provided from the Mains power source to the product input wiring terminals, power cord, or supplied power cord set. Whenever it is likely that the protection has been impaired, the instrument must be made inoperative and be secured against any unintended operation. If this instrument is to be energized via an external autotransformer for voltage reduction, make sure that the common terminal is connected to the earthed pole of the power source. Before connecting the HP 8657D, the protective earth terminal of the HP 8657D must be connected to the protective conductor of the (Mains) power cord. The Mains plug shall only be inserted in a socket outlet provided with a protective earth contact. The protective action must not be negated by the use of an extension cord (power cable) without a protective conductor (grounding). Grounding one conductor of a two-conductor outlet is not sufficient protection.

2-5. POWER REQUIREMENTS

The HP 8657D requires a power source of 100, 120, 220 or 240 Vac, 48 to 440 Hz single phase. Power consumption for the HP 8657D is 200 VA.

$\pi/4$ DQPSK Modulator Assembly requires a power source of 90 to 264 Vac, 48 to 66 Hz single phase. Power consumption for the $\pi/4$ DQPSK Modulator Assembly is 75 VA.

2-6. LINE VOLTAGE SELECTION AND FUSE REPLACEMENT

CAUTION

Before connecting the HP 8657D to the line (mains) voltage ensure that the correct operating voltage and fuse have been selected.

A rear-panel, line power module permits operation from 100, 120, 220, or 240 Vac. The number visible in the window (located on the module) indicates the nominal line voltage to which the instrument must be connected. Verify that the Line Voltage Selection Cam is matched to the power source. See Figure 2-1, Line Voltage Selection and Fuse Replacement. Table 2-1 lists the ratings and the HP part number of the line fuses.

NOTE

The line voltage and line fuse rating are selected at the factory according to the line voltage specified when the HP 8657D $\pi/4$ DQPSK Signal Generator was ordered. If the voltage was not specified, the line voltage and line fuse rating for the 8657D is selected according to the country of destination.

It is not necessary to change the line fuse in the $\pi/4$ DQPSK Modulator Assembly for different line voltages. Two fuses protect the assembly from over-voltage and over-current. One is the rear panel line fuse and the other is located in the power supply.

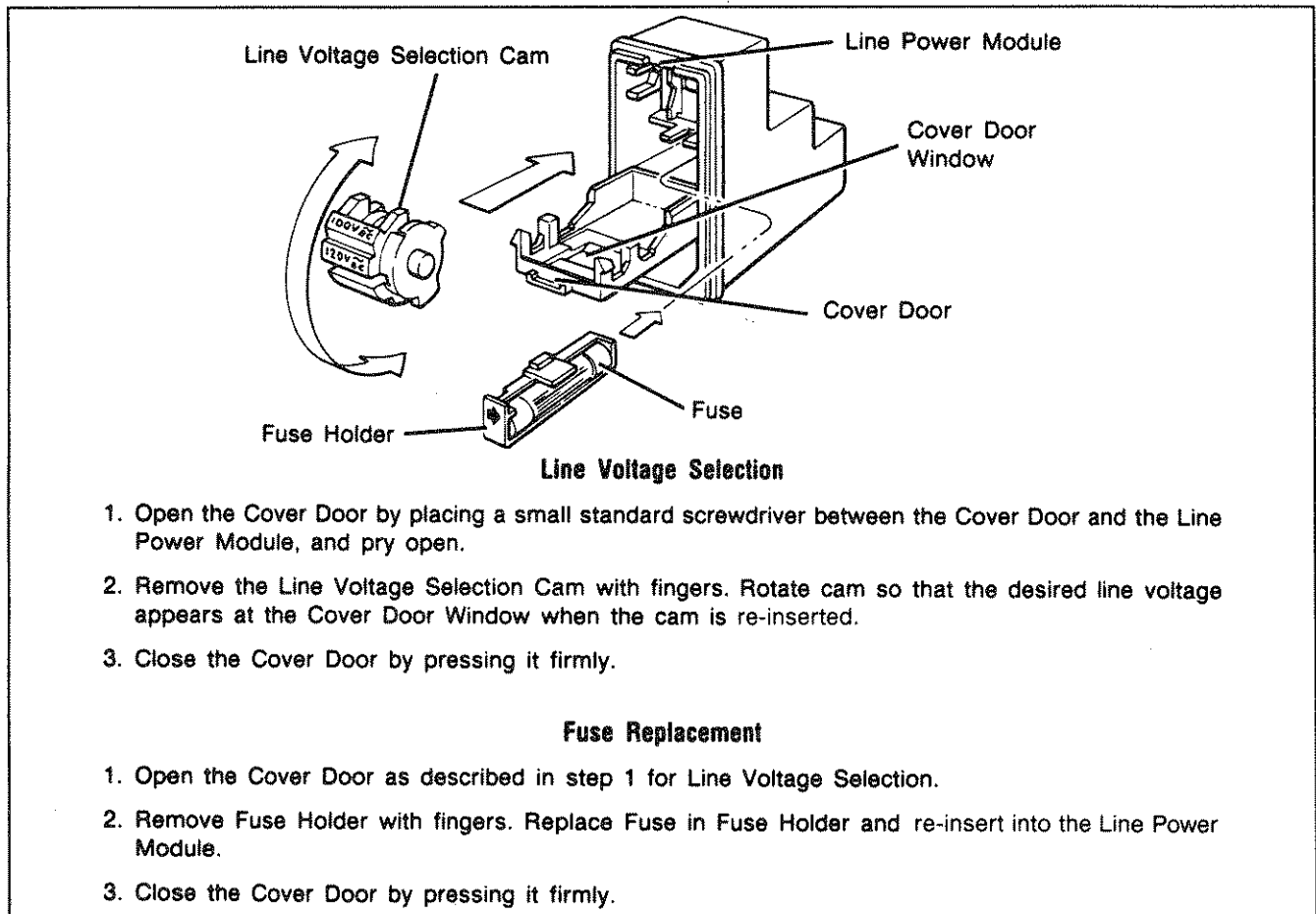

Figure 2-1. Line Voltage Selection and Fuse Replacement

WARNING

For protection against fire hazard, the line fuse should only be a 250V fuse with the correct current rating.



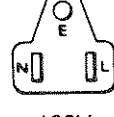
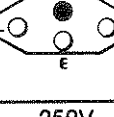

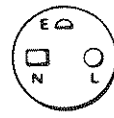

Table 2-1. Line Fuse Rating and HP Part Number

Model	Line Voltage	Rating	Part Number
HP 8657D	100, 120 Vac	2AT, 250V	2110-0303
	220, 240 Vac	1.5AT, 250V	2110-0304
$\pi/4$ DQPSK	90 to 264 Vac	1.5A, 250V	2110-0043

2-7. POWER CABLES

This instrument is equipped with a three-wire power cable. When connected to an appropriate ac power receptacle, this cable grounds the instrument cabinet. The type of mains plug shipped with each instrument depends on the country of destination. Refer to Table 2-2 for the part numbers of the power cables and mains plugs available.

Table 2-2. Power Cable and Mains Plug Part Numbers

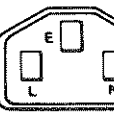
Plug Type	Cable HP Part Number	C D	Plug Description	Cable Length (inches)	Cable Color	For Use In Country
250V 	8120-1351 8120-1703	0 4	90°/STR BS1363A* 90°/90°	90 90	Mint Gray Mint Gray	United Kingdom, Cyprus, Nigeria, Rhodesia, Singapore
250V 	8120-1369 8120-0696	0 4	STR/STR NZSS198/ASC112* STR/90°	79 80	Gray Gray	Australia, New Zealand
250V 	8120-1689 8120-1692	7 2	STR/STR* STR/90°	79 79	Mint Gray Mint Gray	East and West Europe, Saudi Arabia, Egypt, (unpolarized in many nations)
125V 	8120-1378 8120-1521 8120-1751	1 6 1	STR/STR NEMA5-15P* STR/90° STR/STR	80 80 90	Jade Gray Jade Gray Jade Gray	United States, Canada, Mexico, Phillipines, Taiwan U.S./Canada
100V (Same plug as above)	8120-4753 8120-4754	2 3	STR/STR STR/90°	90 90	Dark Gray Dark Gray	Japan only Japan only
250V 	8120-2104 8120-2296 8120-3997	3 4 4	STR/STR SEV1011 1959-24507 Type 12 STR/90° STR/90°	79 79 177	Gray Gray Gray	Switzerland
250V 	8120-0698	6	STR/STR NEMA6-15P	90	Black	United States, Canada
250V 	8120-2956 8120-2957 8120-3997	3 4 4	90°/STR 90°/90° STR/STR	79	Gray	Denmark
250V 	8120-4211 8120-4600	7 8	STR/STR*IEC83-B1 STR/90°	79 79	Black Gray	South Africa, India
250V 	8120-1860 8120-1575 8120-2191 8120-4379	6 0 8 8	STR/STR*CEE22-V1 (Systems Cabinet Use) STR/STR STR/90° 90°/90°	59 31 59 80	Jade Gray Jade Gray Jade Gray Jade Gray	

* Part number shown for plug is industry identifier for plug only. Number shown for cable is HP Part Number for complete cable including plug. E = Earth Ground; L = Line; N = Neutral; STR = Straight

2-8. OPERATING ENVIRONMENT

The operating environment should be within the following limitations:

- Temperature..... 0° C to + 55° C
- Humidity < 95% relative at 40° C
- Altitude < 4570 meters (15,000 feet)

2-9. TIME BASE SELECTION

This section provides information about selecting the frequency of the time base output signal and selecting the frequency that can be used as an external reference time base.

The time base output signal, which is available at the rear panel TIME BASE OUTPUT connector, can be set for a frequency of 1, 5 or 10 MHz. When the HP 8657D is shipped, the time base output is set to 10 MHz. If you require a 1 or 5 MHz time base output, follow the procedure detailed below.

If you want to use an external time base reference, you can use a 1, 5, or 10 MHz signal.

The external time base signal is connected to the TIME BASE INPUT connector on the rear panel. When the HP 8657D is shipped, it is set to accept a 10 MHz signal. If you want to use either a 1 or 5 MHz external time base signal, follow the procedure detailed below.

NOTE

When you select a timebase input or output frequency, the HP 8657D timebase output or timebase input, will be set for the same frequency.

- a. Switch off the HP 8657D and remove the power cable.
- b. Remove the four screws which secure the strap handle and handle caps. Remove the top cover.
- c. Refer to Figure 2-2. Locate the A3 50 MHz Reference Oscillator. Using a 1/4 inch wrench (spanner), slacken the eight retaining nuts(2 per side) which secures the top cover. Then remove the top cover. Locate the time base selection link.
- c. Unsolder the end of the selection link and resolder it in the appropriate position for the time base output or the external time base signal you require.
- d. Reassemble the HP 8657D by reversing the procedure given in step b and then in step a.

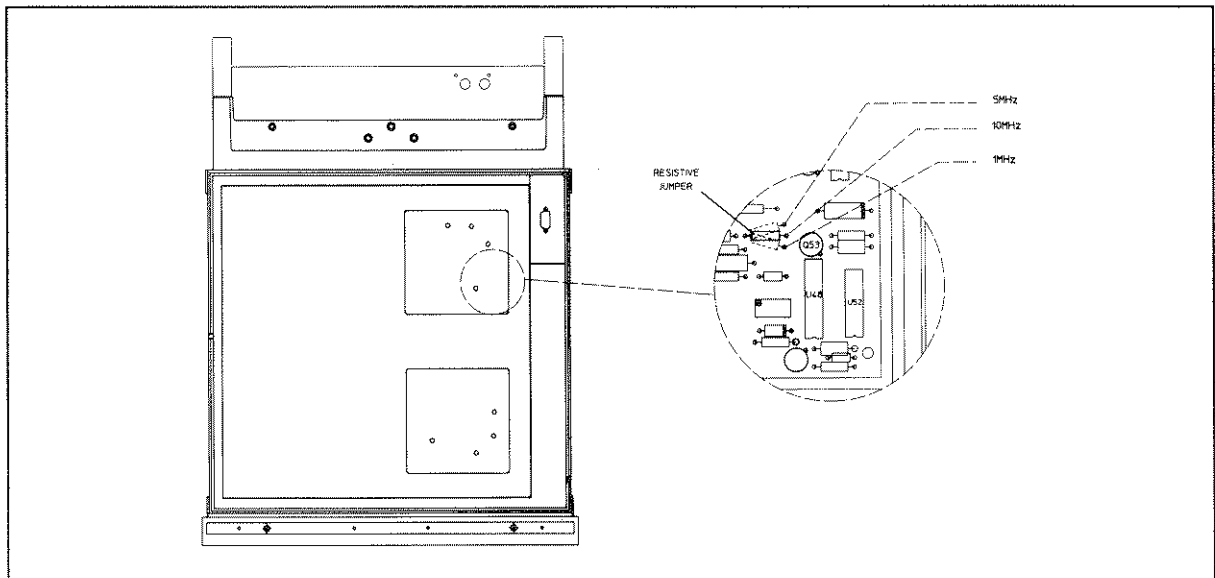

Figure 2-2. Time Base Jumper Location

2-10. HEWLETT-PACKARD INTERFACE BUS (HP-IB)

This section contains information about installing the HP 8657D into a Hewlett-Packard Interface Bus (HP-IB) System.

The HP-IB is Hewlett-Packard's implementation of the IEEE Standard 488-1978 (Digital Interface for Programmable Instrumentation). This standard defines a physical interface and protocol which enables the remote control of instrumentation systems.

2-11. HP-IB ADDRESS SELECTION

The HP-IB address of the HP 8657D is factory set to 07 (decimal). You can set the HP-IB address to any one of 31 valid addresses in the range 00 to 30 (decimal). If you want to set the HP-IB address to another value, use the following procedure.

NOTE

The HP-IB address must be set with the power removed from the HP 8657D.

- a. Switch off the HP 8657D and remove the power cable.
- b. Remove the four screws which secure the strap handle and handle caps. Remove the top cover.
- c. Refer to Figure 2-3. Locate the HP-IB address switch S1 on the A13 Microprocessor assembly.
- d. Using table 2-3 as a reference, set S1 to the HP-IB address you require. For example to set the HP-IB address to 03 (decimal), switch segments A1 and A2 would be set to open and switch segments A3, A4 and A5 would be set to closed.

CAUTION

Change only the switch segments marked A1 thru A5. The remaining switch segments are used to invoke built-in service utilities. Changing the position of these switch segments could prevent the HP 8657D from operating correctly.

- e. Replace the bottom cover by reversing the procedure given in step b.
- f. Plug in the HP 8657D and switch on.
- g. To confirm the HP-IB address, press the SHIFT key, and hold the LOCAL key. The decimal HP-IB address is displayed in the MODULATION Display as long as the LOCAL key remains pressed.

2-12. CONNECTION TO THE HP-IB

The HP-IB connector on the rear panel, provides the interface to connect the HP 8657D into an HP-IB system. Refer to Figure 2-4 for information about the connector.

HP-IB Cables, The following HP-IB cables are available:

- HP 10833A (1m, 3.3ft)
- HP 10833B (2m, 6.6ft)
- HP 10833C (4m, 13.2ft)
- HP 10833D (0.5m, 1.6ft)

Cabling Restrictions, devices in an HP-IB system can be connected in any suitable arrangement (star, delta, etc). However the following cabling restrictions must be observed:

- The HP-IB system must contain no more than 2 meters (6.6 ft.) of connecting cable per device.
- The maximum accumulative length of connecting cable for the HP-IB system is 20 metres (65.6 ft.).

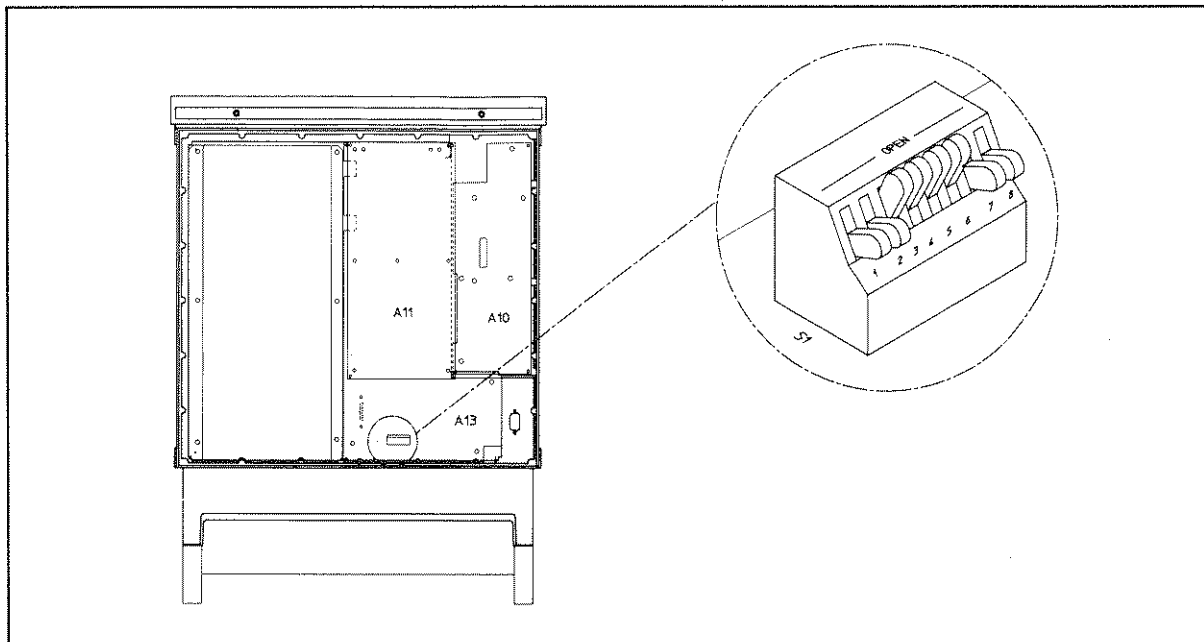

Figure 2-3. HP-IB Address Switch Location

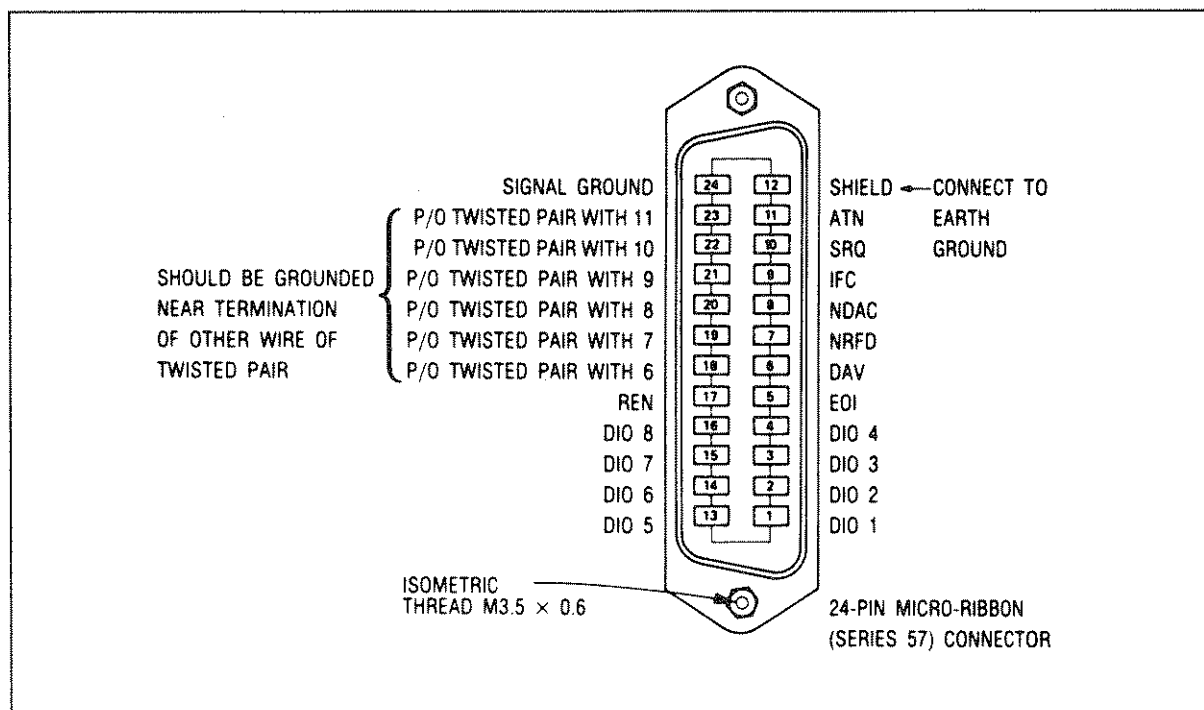

Figure 2-4. HP-IB (rear panel) connector

Table 2-3. HP-IB Address Codes

Address Switch					Equivalent ASCII Character (LISTEN)	Equivalent Decimal Value (LISTEN)
A5	A4	A3	A2	A1		
0	0	0	0	0	SP	00
0	0	0	0	1	!	01
0	0	0	1	0	"	02
0	0	0	1	1	#	03
0	0	1	0	0	\$	04
0	0	1	0	1	%	05
0	0	1	1	0	&	06
0	0	1	1	1	'	07 ⁽¹⁾
0	1	0	0	0	(08
0	1	0	0	1)	09
0	1	0	1	0	*	10
0	1	0	1	1	+	11
0	1	1	0	0	,	12
0	1	1	0	1	-	13
0	1	1	1	0	.	14
0	1	1	1	1	/	15
1	0	0	0	0	0	16
1	0	0	0	1	1	17
1	0	0	1	0	2	18
1	0	0	1	1	3	19
1	0	1	0	0	4	20
1	0	1	0	1	5	21
1	0	1	1	0	6	22
1	0	1	1	1	7	23
1	1	0	0	0	8	24
1	1	0	0	1	9	25
1	1	0	1	0	:	26
1	1	0	1	1	;	27
1	1	1	0	0	<	28
1	1	1	0	1	=	29
1	1	1	1	0	>	30

⁽¹⁾ Factory-set address.

2-13. COAXIAL CONNECTORS.

Coaxial mating connectors used with the Signal Generator should be either 50-ohm BNC male connectors or 50-ohm Type N male connectors that are compatible with those specified in US MIL-C-39012.

2-14. TIMEBASE LOOPING CABLE (OPTION 001 ONLY)

The coaxial Timebase Looping cable, supplied with Option 001, should be connected between the HIGH STABILITY TIME BASE OUTPUT connector and the TIME BASE INPUT connector on the rear panel of the HP 8657D.

2-15. PULSE MODULATION INPUT IMPEDANCE

You can set the input impedance of the Pulse Modulation Input to 50 ohms or high impedance. The input impedance is set to high impedance when the HP 8657D is shipped. To change the input impedance use the following procedure:

- a. Switch off the HP 8657D and remove the power cable.
- b. Disassemble the $\pi/4$ DQPSK Modulator Assembly from the HP 8657D (if already assembled); see paragraph 2-17. ASSEMBLY/DISASSEMBLY INSTRUCTIONS.
- c. Remove the four screws which secure the strap handle and handle caps. Remove the bottom cover.
- d. Refer to Figure 2-5. Locate the selection link W1. When this is set to position 1, the input impedance is set to 50 ohms; when it is set to position 2, the input impedance is set to high impedance. Set W1 into the position you require.
- e. Replace the bottom cover by reversing the procedure in step c.

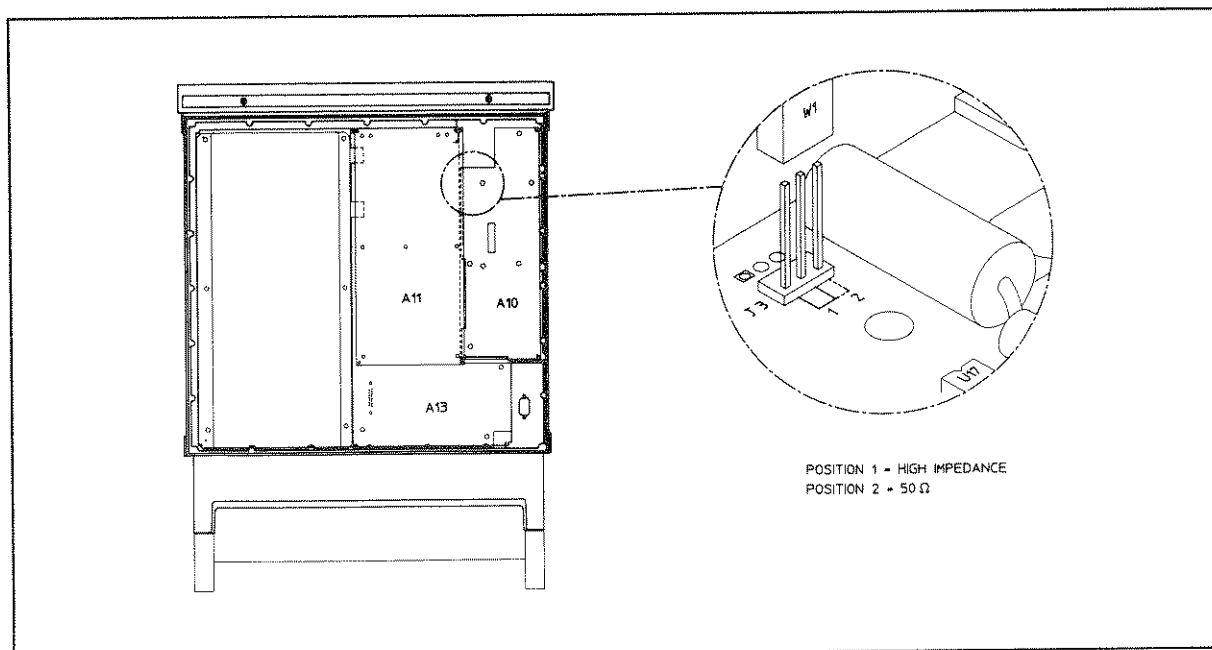

Figure 2-5. Pulse Modulation Input Impedance Selection

2-16. I/Q OUTPUT LEVELS

This procedure will enable you to change the I/Q Modulator output level. The output level is factory set for 0.35 Vp.

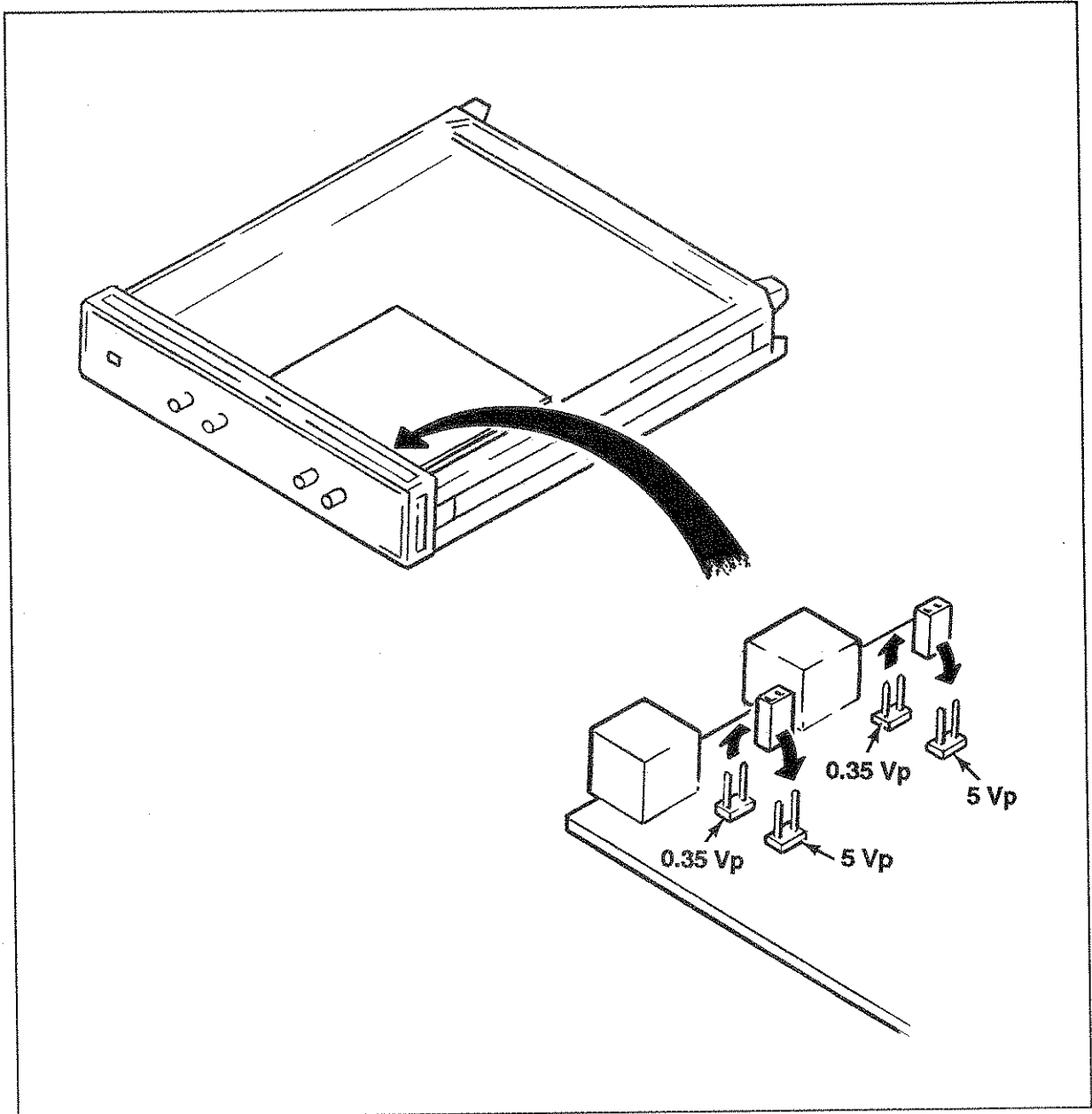
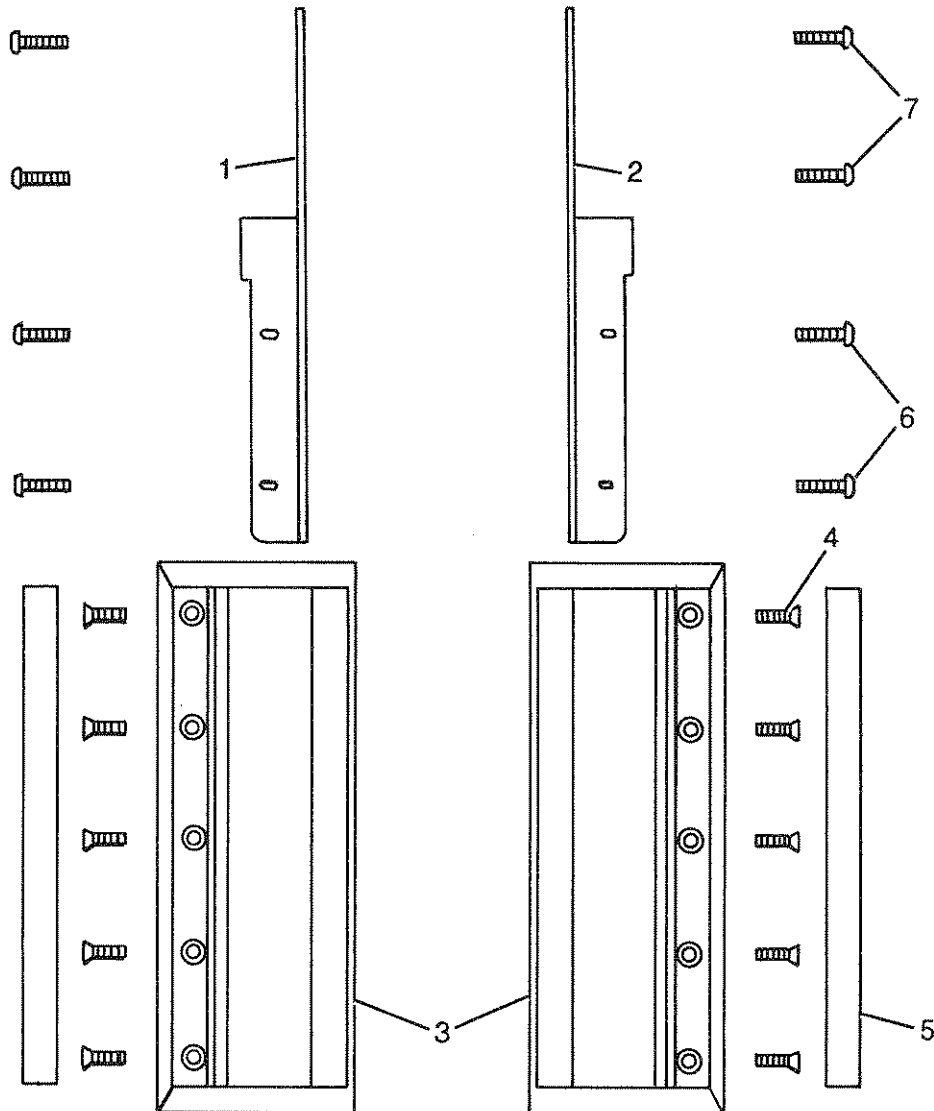

Figure 2-6.

To change the I/Q output levels to 5 Vp, move the jumpers shown in figure 2-6. to their alternate positions.

2-17. ASSEMBLY/DISASSEMBLY INSTRUCTIONS

Mounting Kit Parts and Parts List



Item	HP Part Number	Qty	Description
1	08657-00074	1	Left Bracket
2	08657-00075	1	Right Bracket
3	6052-3801	2	Handle, Front
4	0515-2044	10	Machine Screw M4X.07 10mmLG FLHDTX
5	5021-8498	2	Trim Strip
6	0515-1232	4	Machine Screw M3.5X0.6 8mmLG PNHD
7	2200-0149	4	Machine Screw M4-40 .625-IN-LG PNHD POZI
8	08902-60133	2	Rear Panel Cables (shown on following page)

Mounting Kit Parts and Parts List

Assembly/Disassembly of the Units

STEP 1

POSITION UNITS
UPSIDE DOWN AS SHOWN

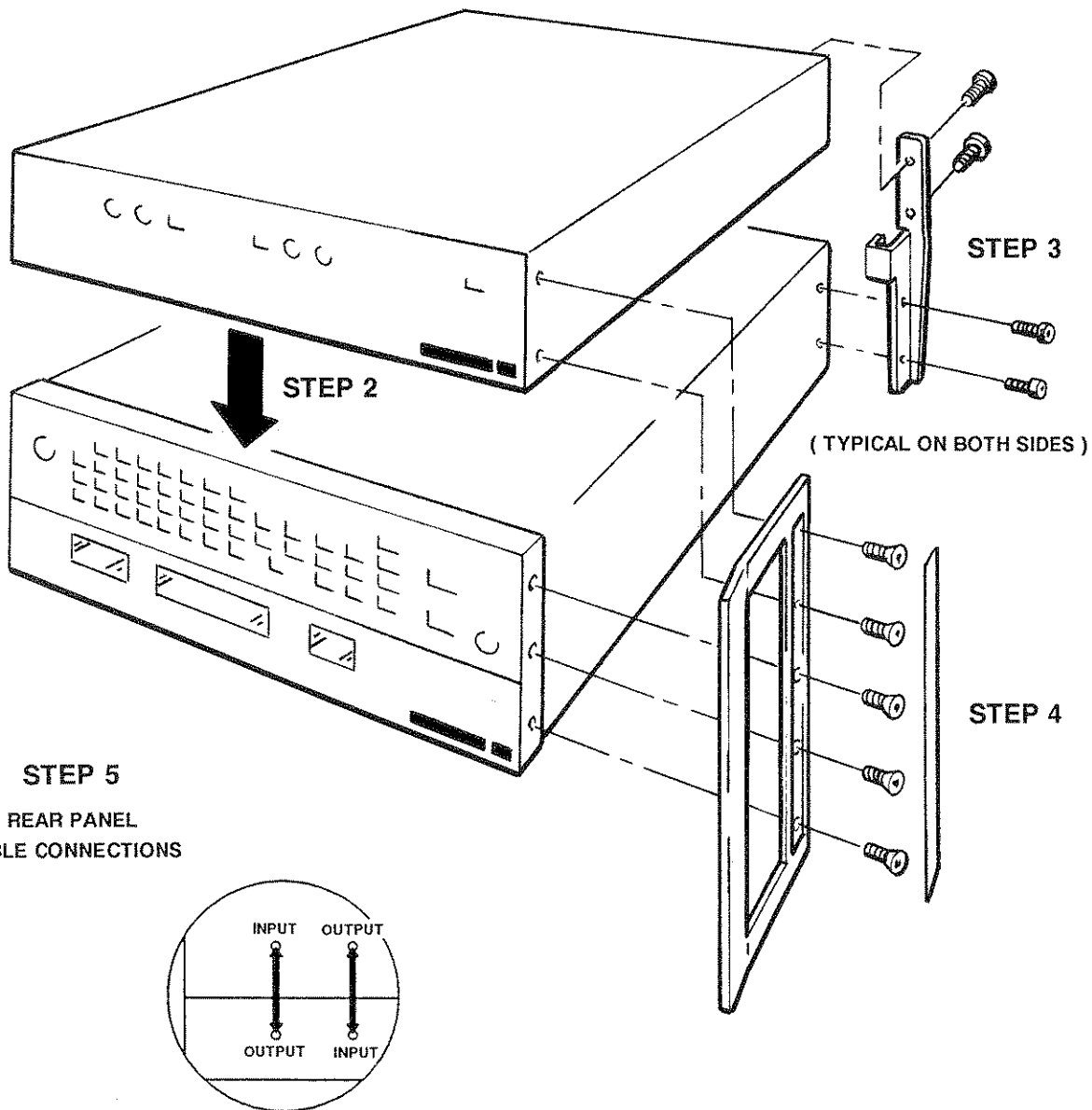

STEP 5

REAR PANEL
CABLE CONNECTIONS

CAUTION

To provide sufficient airflow through the $\pi/4$ DQPSK Modulator, be sure to completely install all bracketing before turning the power on. Insufficient airflow may damage the instrument.

2-18. BENCH OPERATION

The instrument cabinet has plastic feet and foldaway tilt stands for convenience in bench operation. (The plastic feet are shaped to ensure self-alignment of instruments when they are stacked.) The tilt stands raise the front of the HP 8657D $\pi/4$ DQPSK Signal Generator for easier viewing of the front-panel.

2-19. RACK MOUNTING

NOTE

The HP 8657D weighs 26.4 kg (58 lb). Care must be exercised when lifting to avoid personal injury. Use equipment slides when rack mounting.

Rack mounting information is provided with the rack mounting kits. If a kit was not ordered with the HP 8657D as an option, it may be ordered through the nearest Hewlett-Packard office. Slide rack mount kits are discussed in this paragraph; refer to paragraph 1-6, Mechanical Options, in Section 1 for information and part numbers pertaining to other rack mount kits.

Slide rack mount kits allow the convenience of rack mounting with the flexibility of easy access. The slide kits for the HP 8657D are listed below.

- Standard Slide Kit for HP rack enclosures HP 1494-0060
- Slide Adapter Bracket Kit for Standard Slides (for non HP rack enclosures).... HP 1494-0061

2-20. INTERNAL BATTERY

WARNING

This product uses a lithium battery which may explode if mishandled. DO NOT recharge or disassemble the battery, and do not dispose of it by burning. Check your local country regulatory requirements for the disposal of lithium batteries. When the battery needs replaced, use only the battery listed in Section 6 of the Service Manual.

The lithium battery on the A13 Processor board, which is used as a power supply for the non volatile memory, should be replaced at approximately 3 year intervals.

When the battery needs to be replaced, the HP 8657D will display **CLEARING** in the frequency window, at power on. Refer to the Service Manual for information about replacing the battery.

NOTE

You can still use all the features of the HP 8657D except for Storing and Recalling front-panel set-ups, when the battery needs replaced. However, it is recommended that you replace the battery as soon as the error occurs.

2-21. STORAGE AND SHIPMENT

Environment

The instrument should be stored in a clean, dry environment. The following environmental limitations apply to both storage and shipment.

Temperature.....	-55° C to + 75° C
Humidity	< 95% relative
Altitude	15,300 meters (50,000 feet)

Packaging

Original Packaging.

Containers and materials identical to those used in factory packaging are available through Hewlett-Packard offices. If the instrument is being returned to Hewlett-Packard for servicing, attach a tag indicating the type of service required, return address, model number, and full serial number. Also, mark the container **FRAGILE** to assure careful handling. In any correspondence, refer to the instrument by model number and full serial number.

Other Packaging.

The following general instructions should be used for repackaging with commercially available materials.

- a. Wrap the instrument in heavy paper or plastic. (If shipping to a Hewlett-Packard office or service center, attach a tag indicating the type of service required, return address, model number, and full serial number.)
- b. Use a strong shipping container. A double-wall carton made of 2.4 MPa (350 psi) test material is adequate.
- c. Use enough shock-absorbing material (75 to 100 millimeter layer; 3 to 4 inches) around all sides of the instrument to provide a firm cushion and to prevent movement in the container. Protect the front-panel with cardboard.
- d. Seal the shipping container securely.
- e. Mark the shipping container **FRAGILE** to assure careful handling.
- f. The HP 8657D and $\pi/4$ DQPSK Modulator Assembly are shipped unassembled. When returning one or both, they must be shipped unassembled. See paragraph 2-17. **ASSEMBLY/DISASSEMBLY INSTRUCTIONS.**

Section 3 OPERATION

3-1. INTRODUCTION

This section provides complete operating information for the HP 8657D. The information contained in this section is detailed below.

3-2. LOCAL OPERATION

Information covering front-panel operation of the HP 8657D is contained in two areas of this section.

Quick Start Operating Instructions (refer to paragraph 3-6). This section is designed to prepare you to use the HP 8657D quickly. It takes you through general operation instructions, and provides simple procedures to demonstrate how easy the HP 8657D is to use.

Detailed Operating Instructions (refer to paragraph 3-9). The detailed operating instructions provide comprehensive information about all of the HP 8657D functions and features. Table 3-8 is an index (in functional order) to the detailed operating instructions.

3-3. REMOTE OPERATION (HP-IB)

If you have a suitable controller, the HP 8657D can be operated remotely via the Hewlett-Packard Interface Bus (HP-IB). If you are not familiar with the HP-IB, you may want to refer to the document "Tutorial Description of the HP-IB", HP part number 5952-0156.

HP-IB information for the HP 8657D is contained in the following areas of this section:

- a. General HP-IB information begins with paragraph 3-7.
- b. A summary of program codes is provided in Tables 3-4 and 3-5.
- c. A summary of HP-IB capabilities is provided in Table 3-7.
- d. Detailed information relating to the HP 8657D HP-IB programmable features together with tables and examples of associated program codes, are provided in the detailed operating instructions at the end of this section.

3-4. USER CONFIDENCE TESTS

The User Confidence Tests provide procedures to allow you to check that the HP 8657D is operating correctly, in both local and remote modes. Refer to paragraph 3-10.

3-5. POWER ON/STBY INSTRUCTIONS

WARNING

Before the Signal Generator is switched on, all protective earth terminals, extension cords, autotransformers, and devices connected to it should be connected to a protective earth grounded socket. Any interruption of the protective earth grounding will cause a potential shock hazard that could result in personal injury or loss of life.

For continued protection against fire hazard, replace the line fuse only with a 250V fuse of the same rating. Do not use repaired fuses or short circuited fuse holders.

CAUTION

Before the Signal Generator is switched on, it must be set to the same line voltage as the power source being used, and that a correctly rated line fuse is fitted.

The Signal Generator is protected against reverse power applications up to 50 watts. However, for maximum protection of expensive internal components, ensure that you do not apply any reverse power to the RF OUTPUT connector.

Power ON Instructions

1. Ensure that the Signal Generator has the correct line voltage and that the correct fuse has been installed. (Refer to Section 2, *Line Voltage and Fuse Selection* for details).
2. Plug in the power cable. (The Option 001 High Stability Timebase is turned on when the power cable is plugged in.)
3. Press the POWER switch to the ON position. (All front-panel annunciators and LED segments momentarily turn on for a visual inspection.)

Error Codes

If the error code, **CLEARING** appears at power ON, the NVM battery needs to be replaced, refer to section 2. If an error code, **ERROR XXXX**, appears, refer to the Service Manual for more information.

4. The Signal Generator is now ready for use.

Power STBY Instructions

Press the POWER switch to the STBY position.

All Signal Generator settings and storage register contents are saved in RAM. When the Signal Generator is turned back ON, the instrument functions last displayed will be active, even if power has been disconnected.

NOTE

If the Signal Generator is switched to STBY with RF ON/OFF set to off, the RF will be turned on when the Signal Generator is turned back ON.

3-6. QUICK START OPERATING INSTRUCTIONS

Illustrations in this section of the manual provide you with general operating instructions for setting the following Signal Generator features:

- Setting Frequency (page 3-4).
- Setting Amplitude (page 3-5).
- Setting Modulation, AM and FM (page 3-6).
- Setting Modulation, Pulse (page 3-7).
- Setting Modulation, $\pi/4$ DQPSK (page 3-7).
- Saving and Recalling Front-Panel Settings (page 3-8).
- Modifying Front-Panel Settings (page 3-10).
- Additional Operating Features (page 3-12).

Each illustration is accompanied with directions and comments to provide further information.

Setting Frequency

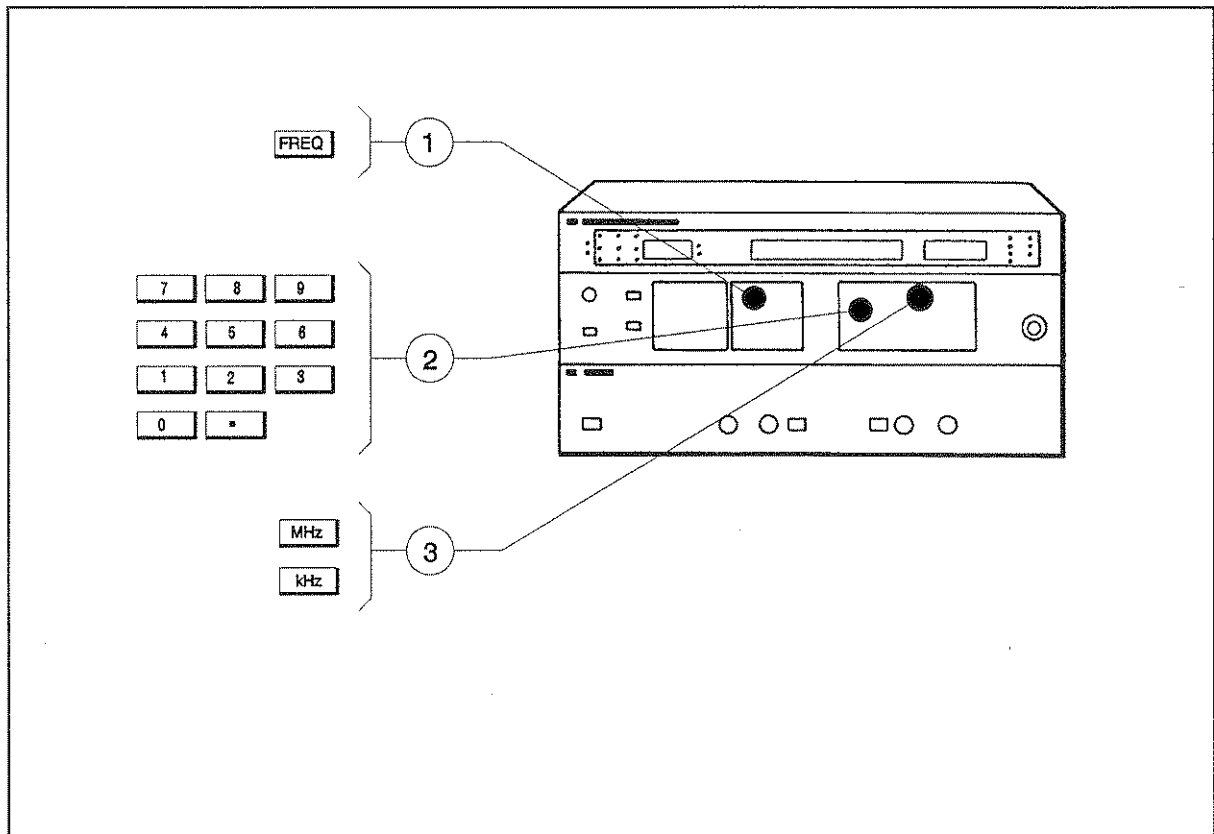

Setting Frequency

Directions:

1. Press the **FREQ** key.
2. Enter the numeric frequency value.
3. Complete the entry in MHz or kHz.

Comments:

- Skip step 1 (above) for subsequent frequency changes.
- Carrier frequencies below 100 kHz result in an uncalibrated output amplitude.
- The **MODULATION** display flashes if you enter a carrier frequency outside of the Signal Generator's operating limits for the selected FM peak deviation. Change the carrier frequency or the FM peak deviation to correct the error.

Setting Amplitude

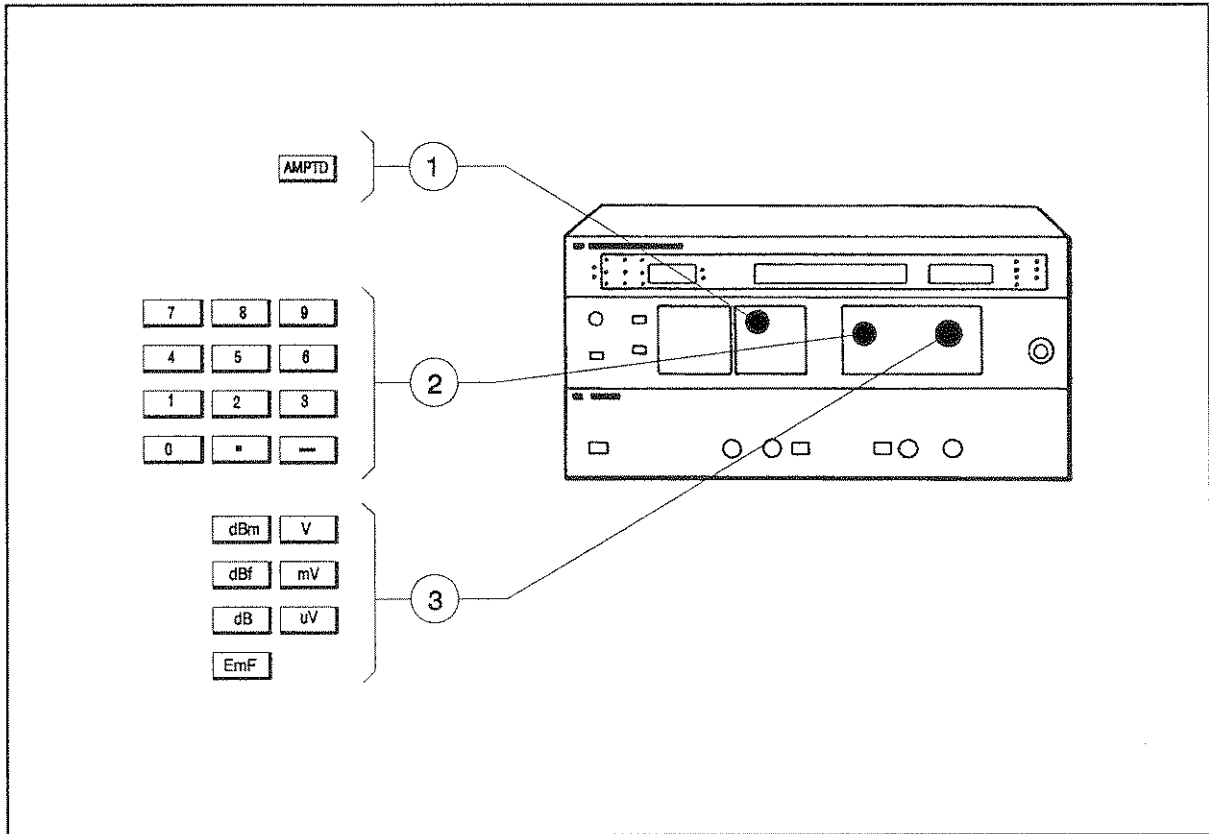

Setting Amplitude

Directions:

1. Press the **AMPTD** key.
2. Enter the numeric amplitude value.
3. Complete the entry in any one of the following 14 entries:

dBm	dB μ V	V	EMF mV
dBf	dB EMF V	mV	EMF μ V
dBV	dB EMF mV	μ V	
dBmV	dB EMF μ V	EMF V	

Comments:

- The minus sign may be entered at any time before completing the entry.
- Digits selected beyond the specified resolution of the **AMPLITUDE** display are truncated.
- Whenever a reverse power condition is detected, the **AMPLITUDE** display and its associated annunciators flash until the source of reverse power is removed and the **AMPTD** key is pressed.

Setting Modulation, AM and FM

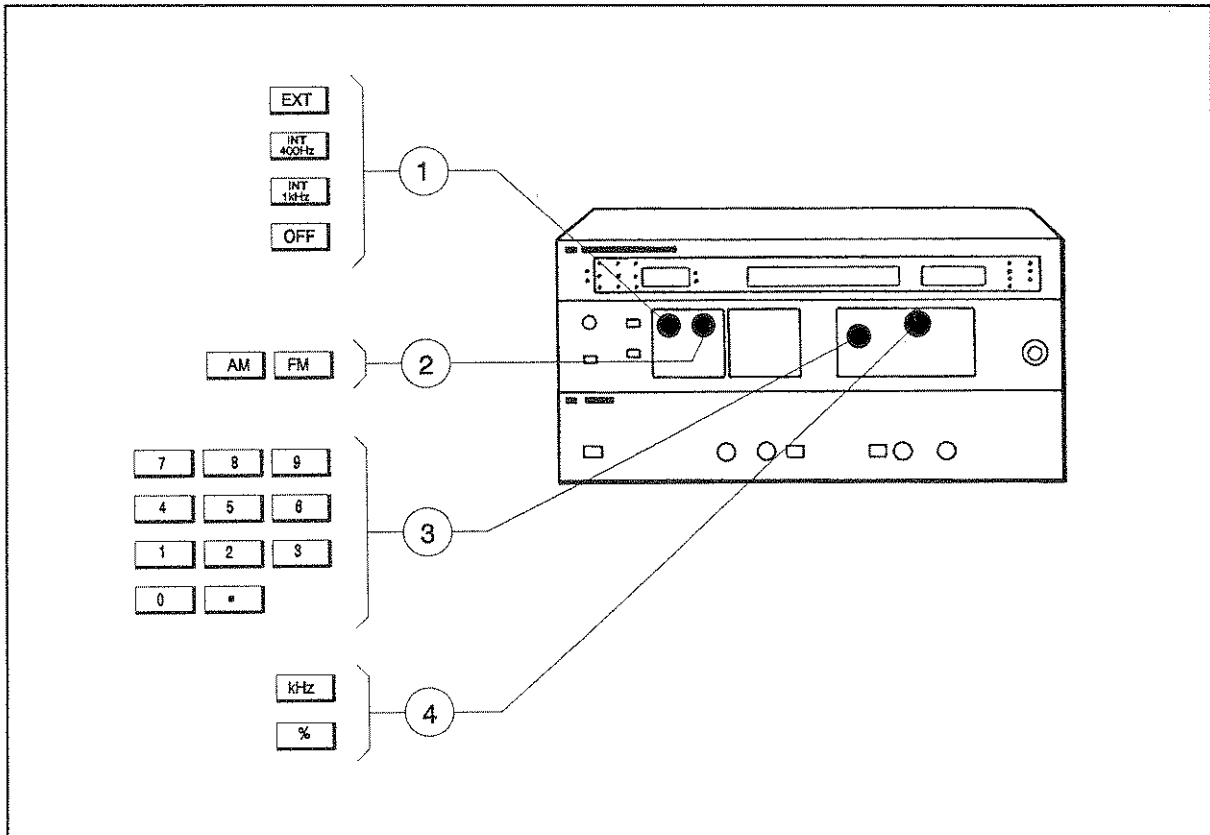

Setting Modulation, AM and FM

Directions:

1. Press one of the **MODULATION SOURCE** keys (for either internal or external source).
2. Press either the **AM** or **FM** key.
3. Enter the numeric modulation depth or deviation value.
4. Complete the entry in % for AM, or kHz for FM.

Turn modulation off by first pressing the **AM** or **FM** key, and then the **MODULATION SOURCE OFF** key.

Comments:

- DCFM is turned on by first pressing the blue **SHIFT** key, and then the **FM** key.

CAUTION

Maximum allowable input level for DCFM is ± 15 Vdc. Exceeding this limit may cause damage to the Signal Generator.

- Only one internal modulation source can be selected at any time, either 400 Hz or 1 kHz.
- The modulation value is retained when modulation is switched off.
- AM and FM is not available in the $\pi/4$ DQPSK modulation mode.

Setting Modulation, Pulse

Directions:

1. Press the blue **SHIFT** key and then the **AM** key.
2. Connect an external modulation source to the **PULSE INPUT** connector. When a pulse waveform from the external modulation source goes high, the Pulse output turns on.
3. Vary the external pulse's waveform rate, amplitude, and width to simulate the pulse signal you require.

CAUTION

The maximum allowable input level for Pulse modulation is ± 15 Vdc. Exceeding this limit may cause damage.

Comments:

- Pulse specifications are listed in Section 1, Table 1-1.
- The **PULSE INPUT** impedance can be selected for 50 Ω , or for high impedance. The HP 8657D is set at the factory for high impedance (refer to Section 2).
- Pulse modulation is available in analog or $\pi/4$ DQPSK mode.

Setting Modulation, $\pi/4$ DQPSK

Directions:

1. Press the blue **SHIFT** key, then the **EXT** key.
2. Connect the external symbol clock to the **CLOCK INPUT** and the serial data to the **DATA INPUT**.

Comments:

- The clock and data input impedance is nominally 1 k Ω .
- AM and FM are not available in the $\pi/4$ DQPSK modulation mode.
- When in the $\pi/4$ DQPSK modulation mode, the frequency range is limited to the following three bands:
 - 10 to 129.9 MHz
 - 810 to 965 MHz
 - 1420 to 1540 MHz
- Generator frequency defaults to 860 MHz under two conditions:
 1. The operating frequency is not within 10 to 129.9 MHz or 810 to 965 MHz when the $\pi/4$ DQPSK modulation mode is selected.
 2. Operating in the $\pi/4$ DQPSK modulation mode at a frequency within 1420 to 1540 MHz and turning $\pi/4$ DQPSK modulation mode off.

Saving and Recalling Front-Panel Settings

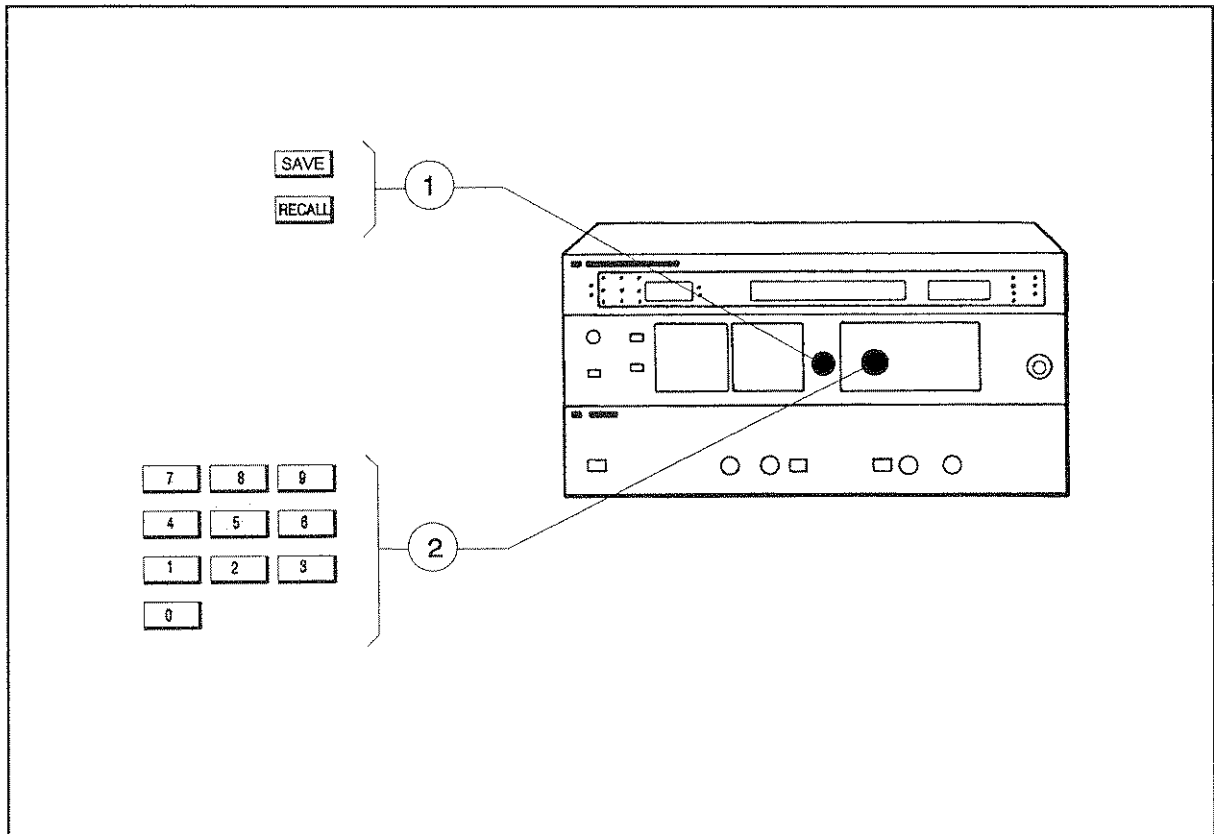

Saving and Recalling Front-Panel Settings

Directions for Saving:

1. Press the **SAVE** key.
2. Enter the memory location number (00-99).

Directions for Recalling:

1. Press the **RECALL** key.
2. Enter the memory location number (00-99).

Comments:

- The HP 8657D has 100 memory locations (00-99) for storing/saving front-panel setups (exclusive of increment settings).
- The HP 8657D uses a lithium battery to save its memory locations. The error message "CLEARING" appears on the front-panel display when it is time to replace the battery.

WARNING

The lithium battery, in the HP 8657D A13 Processor board, may explode if mishandled. DO NOT recharge or disassemble the battery, and do not dispose of it by burning. Check your local country regulatory requirements for the disposal of lithium batteries.

Directions for Creating a Sequence

1. Set the Signal Generator to the desired set-up.
2. Press the **SAVE** key. Enter the memory location number (00-99).
3. Repeat steps 1 and 2 until all the set-ups are saved.

Directions for Recalling a Sequence

1. Use the **RECALL** key and the data keys to recall the set-up you want the sequence to start with.
2. Press the **SEQ** key to recall the next set-up.
3. To reverse the sequence, press **SHIFT** **SEQ**, and then **RECALL**.

Directions for Creating a Flexible Sequence

1. Use the **RECALL** key and the data keys to recall the last sequence.
2. Press **SHIFT**, **SAVE**, then four data keys. In the example below, the data keys are **5** **0** and **4** **5**.

Comments:

- The reverse sequence is flexible.

Modifying Front-Panel Settings

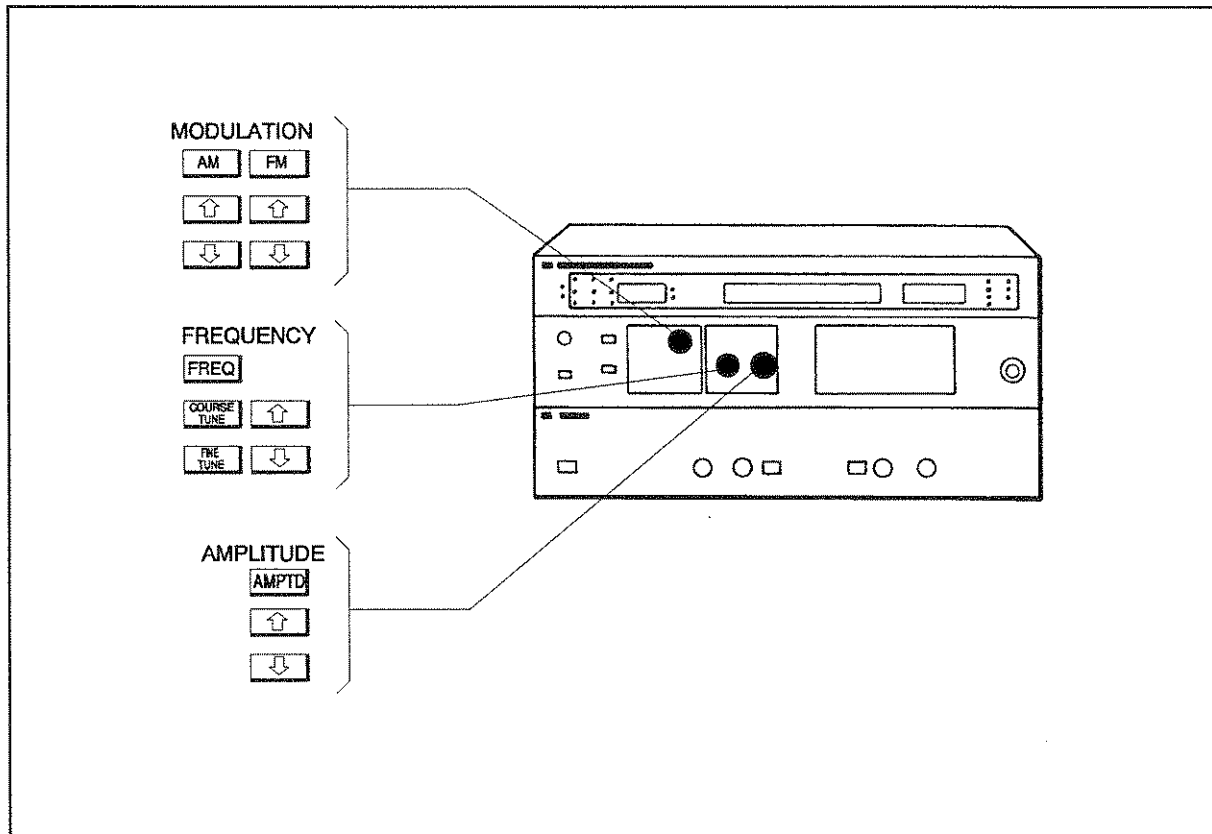

Modifying Front-Panel Settings

Directions to Modify Modulation:

1. Press the **AM** or **FM** key.
2. Press the \uparrow or \downarrow key as many times as needed. The AM depth or FM deviation changes each time you press the \uparrow or \downarrow key by the value in its increment register.

Directions to Modify Frequency:

1. Press the **FREQ** key.
2. Press the \uparrow or \downarrow key as many times as needed. The frequency changes each time you press the \uparrow or \downarrow key by the value in its increment register.
3. Press the **COARSE TUNE** or **FINE TUNE** key and change the Signal Generator's frequency using the \uparrow or \downarrow keys.

NOTE

COARSE TUNE and **FINE TUNE** value settings are lost when an instrument preset is done.

Directions to Modify Amplitude:

1. Press the **AMPTD** key.
2. Press the \uparrow or \downarrow key as many times as needed. The amplitude value of the RF output changes each time you press the \uparrow or \downarrow key by the value in its increment register.

Comments:

- Press and hold the **INCR SET** key to view the contents of the increment register. You can modify the contents of the increment register after it has been pressed.
- Increment entries are checked against maximum and minimum allowable increment limits. If a limit is exceeded, the increment entry is either truncated or rejected.
- If the increment register is set to a value that would cause the Signal Generator to exceed its operating range for modulation, frequency, or amplitude, the \uparrow or \downarrow keys would become inoperative. A correct decrease in the increment setting re-enables the \uparrow or \downarrow keys.

Additional Operating Features

The Signal Generator has the following additional operating features:

- Amplitude offset.
- Display a memory location.
- Display the HP-IB address.
- Frequency phase up and down.
- HP-IB to local.
- Instrument preset.
- RF on and off.

How to Set Amplitude Offset:

The following steps show you how to change the RF output amplitude without altering the value shown in the **AMPLITUDE** display.

1. Press the blue **SHIFT** key, and then press the **AMPTD** (AP OFS) key.
2. Enter the numeric amplitude offset value, and then press the **dB** key.
3. To verify the amplitude offset value, press the blue **SHIFT** key first, then press and hold the **AMPTD** key.

NOTE

To reset the output amplitude to the displayed value, enter an offset of 0 dB. The Amplitude Offset initializes to 0 dB when the Signal Generator is PRESET.

How to Display a Memory Location:

The following steps show you how to display the contents of any memory location without affecting the actual output of the Signal Generator.

1. Press the blue **SHIFT** key, and then the **SEQ** (DSPL) key.
2. Press the first digit of the memory location number, then press and hold the second digit of the memory location number (00-99).

How to Display the HP-IB Address:

The following steps show you how to display the internally set, decimal HP-IB address.

1. Press the blue **SHIFT** key, and then press and hold the **LOCAL** (ADRS) key.
2. The decimal HP-IB address is shown in the **MODULATION** display for as long as you hold the **LOCAL** (ADRS) key.

The firmware revision number is also displayed in the **FREQUENCY** display when the HP-IB address is being shown.

How to Set Frequency Phase Up and Down:

The following steps show you how to change the carrier frequency's phase in one-degree steps, referenced to the internal or external timebase.

1. Press the blue **SHIFT** key, and then either the $\phi\uparrow$ or the $\phi\downarrow$ associated with the **FREQ** key.
2. Holding the $\phi\uparrow$ or the $\phi\downarrow$ key down continually changes the carrier frequency in one-degree steps.

How to go from HP-IB to Local Control:

Press the **LOCAL** key to make the Signal Generator go from HP-IB to local front-panel control. You'll notice that the **RMT** annunciator turns off when local front-panel control is returned.

How to Perform an Instrument Preset:

Press the blue **SHIFT** key, and then press the **0** (**PRESET**) key. All front-panel annunciators and LED segments will momentarily light up for a visual inspection.

How to Turn the RF On and Off:

Press the **RF ON/OFF** key to turn the Signal Generator's **RF OUTPUT** on and off.

3-7. REMOTE OPERATION, HEWLETT-PACKARD INTERFACE BUS

The HP 8657D can be operated through the Hewlett-Packard Interface Bus (HP-IB). Bus compatibility, programming, and data formats are described in the following paragraphs.

All front-panel functions (except for DSPL, DSPL in conjunction with SEQ, display Amplitude Offset, Backspace (\Leftarrow), COARSE TUNE, FINE TUNE, clearing the NVM and displaying the HP-IB address) are programmable through HP-IB.

A quick check of the HP 8657D HP-IB input/output capability is described in paragraph 3-19, HP-IB Functional Checks. These checks can be used to verify that the HP 8657D responds correctly to the HP-IB messages described in Table 3-7.

HP-IB Compatibility

The HP 8657D has an open-collector, TTL, HP-IB interface. The HP 8657D can be used with any HP-IB computing controller or computer for automatic system applications. The HP 8657D is fully programmable via the HP-IB. The HP 8657D programming capability is described by the 13 HP-IB messages listed in Table 3-7. Foremost among these messages is the Data message. Data messages contain the program codes that control the HP 8657D output signal. The HP 8657D's complete compatibility with HP-IB is further defined by the following list of interface functions: SH0, E1, AH1, T0, L2, SR0, RL1, PP0, DC1, DT0, and C0. A more detailed explanation of these compatibility codes can be found in the IEEE Standard 488 (and the identical ANSI Standard MC1.1). For more information about HP-IB, refer to the Hewlett-Packard Electronic Instruments and Systems catalog and the booklet titled "Tutorial Description of the HP-IB" (HP part number 5952-0156).

Remote Operation

Remote Capability. In remote operation, the front-panel keys are disabled (except for the POWER switch and the LOCAL key). The HP 8657D can only be addressed to listen. When addressed to listen, the HP 8657D responds to the following messages: Data, Clear, Remote, Local, Local Lockout, Clear Lockout/Set Local, and Abort. Each is discussed in detail further on in this section.

Local-to-Remote Change. The HP 8657D switches to remote operation when the Remote message is received. The Remote message is comprised of two parts. They are:

- Remote Enable bus control line (REN) set true.
- Device listen address received once (while REN is true). The HP 8657D RMT and ADRS annunciators will both light, and its output signal and all preselected functions remain unchanged when the local-to-remote transition occurs.

Local Operation

Local Capability. In local operation, the HP 8657D front-panel is fully operational, and will respond to the Remote message. Whether addressed or not, the HP 8657D also responds to the Clear, Local Lockout, Clear Lockout/Set Local, and Abort messages. It will not, however, respond to the Data message unless it has been previously addressed.

Remote-to-Local Change. The HP 8657D returns to local operation when the Local message (GTL) or Clear Lockout/Set Local message is received. The Clear Lockout/Set Local message sets the Remote Enable bus control line (REN) false. The HP 8657D can always be set to local operation by pressing the front-panel LOCAL key, provided that local lockout is not set. The output signal remains unchanged, and all preselected functions remain unchanged when the remote-to-local transition occurs.

Local Lockout. When a data transmission is interrupted, which can happen if the HP 8657D is returned to local operation by pressing the LOCAL key, the data could be lost. This would leave the HP 8657D in an unknown state. To prevent this, a local lockout is recommended. Local lockout disables the LOCAL key and allows return-to-local only under program control.

NOTE

Return-to-local can also be accomplished by setting the POWER switch to STBY, and then back to ON. This technique, however, has some potential disadvantages.

It defeats the purpose and advantage of local lockout, since the system controller will lose control of the HP 8657D.

Some HP-IB conditions are reset to their default state during turn on.

Addressing

The HP 8657D interprets the byte of information on its eight data input/output bus lines as either an address or a bus command. Whenever the bus is in the command entry mode, the Attention bus control line (ATN) is true and the Interface Clear bus control line (IFC) is false. Whenever the HP 8657D is being addressed (whether in local or remote operation), the front-panel ADRS annunciator will light.

The HP 8657D listen address is set by an internal switch. The address selection procedure is described in Section 2, Installation. The decimal equivalent of the listen address can be displayed in the MODULATION Display by pressing the SHIFT key first and then pressing and holding the LOCAL key.

Refer to Table 3-1 for a list of the valid decimal (listen address) values and their equivalent ASCII characters.

Table 3-1. Valid Decimal Values vs. Equivalent ASCII Characters

Equivalent Decimal Value (Listen)	Equivalent ASCII Character (Listen)	Equivalent Decimal Value (Listen)	Equivalent ASCII Character (Listen)
00	SP	16	0
01	!	17	1
02	"	18	2
03	#	19	3
04	\$	20	4
05	%	21	5
06	&	22	6
07 ⁽¹⁾	'	23	7
08	(24	8
09)	25	9
10	*	26	:
11	+	27	;
12	,	28	<
13	-	29	=
14	.	30	>
15	/		

⁽¹⁾ Factory-set address.

Data Messages

The HP 8657D communicates on the interface bus with Data messages. Each Data message consists of one or more bytes of information sent over the eight data input/output bus lines DIO1 through DIO8 during the data entry mode. The data entry mode is established when the Attention bus control line (ATN) is false. Data messages include the program codes listed in Tables 3-4 and 3-5. These program codes contain the necessary information to program virtually all of the HP 8657D functions available in local operation. The only exceptions are DSPL, DSPL in conjunction with SEQ, display Amplitude Offset, Backspace, COARSE TUNE, FINE TUNE, and display HP-IB ADRS.

Receiving the Data Message

The HP 8657D must be in remote operation and addressed to listen before it can respond to Data messages. The HP 8657D remains addressed to listen until it receives an Abort message or a universal unlisten command from the controller.

The paragraph entitled Switching Characteristics, shows how the HP 8657D responds to Data Messages. Timing considerations and other characteristics pertinent to operation are included.

Data Message Input Format. Data messages contain the controller's talk address, the HP 8657D listen address, a string of program codes, and an End of String message (EOS). The string of program codes follows the same protocol as a front-panel keystroke sequence in local operation. The EOS message can be a Line Feed (LF), a bus END message (EOI and ATN bus control lines both set true), or an internally produced EOS.

The following paragraphs explain other key elements of the program code strings. Figure 3-1 provides some examples of Data messages.

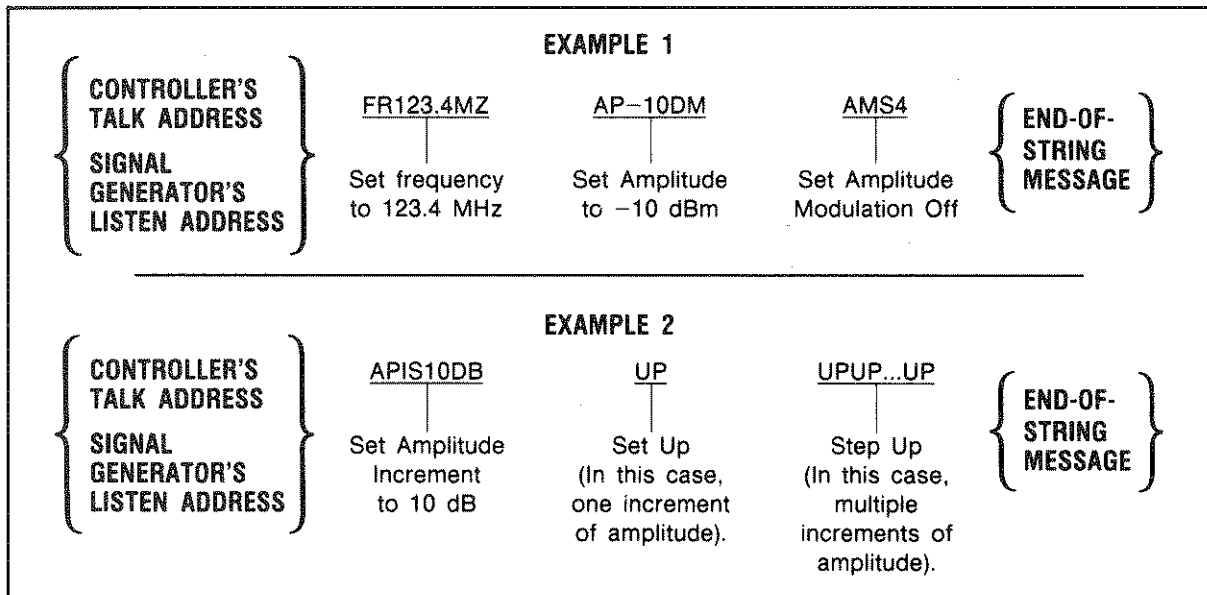

Figure 3-1. Data Message Example.

NOTE

After any function terminator (UNITS entry) is sent to the HP 8657D, the HP 8657D is unable to respond to the interface bus until the microprocessor has completed execution of the particular task. Any attempt to send data to the HP 8657D delays bus operation until the execution is complete. The normal terminators carriage-return, and line-feed are considered further data. Data cannot be sent on the bus until the HP 8657D has processed the carriage-return, and line-feed. The bus is free, however, for communication between controller and other equipment. It is recommended that the carriage-return, and line-feed be omitted from data messages sent to the HP 8657D by using a semicolon after the function terminator.

Keyboard-to-Program Code Correlation. There is a program code that corresponds to nearly every front-panel key. The exceptions are DSPL, DSPL in conjunction with SEQ, display Amplitude Offset, Backspace, COARSE TUNE, FINE TUNE, and display HP-IB ADRS. In addition, the program code HZ is available for carrier frequency entries, RP is available to reset the reverse power protection circuitry after the source of reverse power has been removed, and R0 and R1 are available to place the HP 8657D in the STBY and ON states, respectively.

Value-Selectable Parameters. Carrier parameters are set using a Function-Data-Units sequence of program codes, while modulation parameters are set using a Source-Function-Data-Units sequence of program codes.

Single-value parameters; such as, INT 400 Hz, INT 1 kHz, and so forth, are set with a single program code sequence.

Data. The term "Data" in each program sequence refers to the numeric value and not to the entire Data message. Data can be any number of arbitrary length in fixed point notation. Digits that exceed the maximum data length for the particular function will be truncated. This maximum limit includes any embedded decimal points. In the case of the Amplitude function, this maximum limit also includes the minus sign. The minus sign is only applicable during Amplitude Data entries. Table 3-2 summarizes these input data restrictions. A complete list of ASCII characters with conversions to binary, octal, decimal, and hexadecimal is provided in Table 3-6.

Table 3-2. Input Data Restrictions

Function	Maximum Data Length	Decimal Point Allowed	Minus Sign Allowed
Frequency	10 Digits	Yes	No
Amplitude	9 Digits (1)	Yes	Yes
AM	3 Digits	Yes	No
FM	3 Digits	Yes	No
Increment Set	Same as for selected function	Yes	No
NOTES: 1. In the Amplitude function, leading zeros are not counted. 2. Unused or unidentifiable characters are ignored. 3. Either upper or lower case letters can be used in Data messages. 4. Only the following ASCII characters are recognized by the HP 8657D: A-Z a-z 0-9 LF - % All other characters, including spaces, are ignored.			

Sending the Data Message

The HP 8657D does not have the capability to talk; therefore, it cannot send Data messages.

Receiving the Trigger Message

The HP 8657D does not have the capability to respond to the trigger message.

Receiving the Clear Message

The HP 8657D responds to a Clear message by setting each function parameter to the value listed in Table 3-3. The HP 8657D responds equally to the Selected Device Clear (SDC) bus command when addressed to listen, and to the Device Clear (DCL) bus command whether addressed or not.

Table 3-3. Response to Clear Message.

Parameter	Value
Carrier Frequency	100.00000 MHz
Output Amplitude	-143.5 dBm
AM Depth	0%
FM Peak Deviation	0.0 kHz
Carrier Frequency Increment	10.00000 MHz
Output Amplitude Increment	10.0 dB
AM Depth Increment	1%
FM Peak Deviation Increment	1.0 kHz
Coarse and Fine Tune Pointer	10.00000 MHz
Sequence Counter	0
100 Saved Set Ups	Remain unchanged

Receiving the Remote Message

The Remote message is comprised of two parts. First, the Remote Enable bus control line (REN) is held true, then the device listen address is sent by the controller. These two actions combine to place the HP 8657D into remote operation. Therefore, the HP 8657D is enabled to go into remote operation when the controller begins the Remote message, but it does not actually make the transition until it is addressed to listen for the first time. All HP 8657D settings remain unchanged when the transition from local-to-remote operation occurs. The front-panel RMT and ADRS annunciators will both light once the HP 8657D has received the Remote message and is addressed to listen.

Receiving the Local Message

The Local message is the means by which the controller sends the Go to Local (GTL) bus command. If addressed to listen, the HP 8657D returns to local operation (full front-panel control) when it receives the Local message. If the HP 8657D is in local lockout when the Local message is received, full front-panel control is returned, but local lockout remains in effect. Unless the HP 8657D receives the Clear Lockout/Set Local message, it returns to local lockout the next time it receives a Remote message. All HP 8657D settings remain unchanged when the transition from remote-to-local operation occurs.

The front-panel RMT annunciator turns off when the HP 8657D switches to local operation. However, the front-panel ADRS annunciator remains lit if the HP 8657D is still being addressed to listen (whether in remote or local operation).

The front-panel LOCAL key can also be used to return the HP 8657D to local operation. However, pressing the LOCAL key (when the HP 8657D is not in local lockout) might interrupt a Data message

being sent to the HP 8657D. This would leave the HP 8657D in a state unknown to the controller. This situation is undesirable and can be avoided by sending the Local Lockout message to disable the LOCAL key.

Receiving the Local Lockout Message

The Local Lockout message is the means by which the controller sends the Local Lockout (LLO) bus command. If the HP 8657D is in remote operation, it responds to the Local Lockout message by disabling the front-panel LOCAL key. Local lockout prevents the loss of data or system control due to someone accidentally pressing any of the front-panel keys. If the HP 8657D is in local operation when it is enabled to remote operation (that is, REN is set true) and it receives the Local Lockout message, it switches to remote with local lockout operation the first time it is addressed to listen. Once in local lockout, the HP 8657D can only be returned to local operation by the controller or by unplugging or switching the HP 8657D to STBY and then back to ON.

Receiving the Clear Lockout/Set Local Message

The Clear Lockout/Set Local message is the means by which the controller sets the Remote Enable bus control line (REN) false. The HP 8657D returns to local operation (full front-panel control) when it receives the Clear Lockout/Set Local message. All HP 8657D settings remain unchanged when the transition from remote with lockout to local operation occurs.

The front-panel RMT annunciator is turned off when the HP 8657D switches to local operation.

Receiving the Pass Control Message

The HP 8657D does not respond to the Pass Control message because it cannot act as a controller.

Sending the Require Service Message

The HP 8657D does not have the capability to require service by setting the Service Request bus control line (SRQ) true.

Sending the Status Byte Message

The HP 8657D does not have the capability to respond to a Serial Poll Enable (SPE) bus command; therefore, it cannot send the Status Byte message.

Sending the Status Bit Message

The HP 8657D does not have the capability to respond to a Parallel Poll Enable (PPE) bus command; therefore, it cannot send the Status Bit message.

Receiving the Abort Message

The Abort message is the means by which the controller sets the Interface Clear bus control line (IFC) true. When the Abort message is received, the HP 8657D becomes unaddressed and stops listening.

Table 3-4. HP-IB Program Codes (Alphabetical Order) (1 of 2)

Program Code ¹	Parameter	Comments
AM	Amplitude Modulation	Function Entry
AO	Amplitude Offset	Function Entry
AP	Amplitude (carrier)	Function Entry
DB	dB	Units Entry
DF	dBf	Units Entry
DM	dBm	Units Entry
DN	Step Down (I)	Function Feature
EM	EMF	Units Entry
FM	Frequency Modulation	Function Entry
FR	Frequency (carrier)	Function Entry
GT	Flexible Sequence	Feature
HI	HI ALC	Function Feature
HZ	Hz	Units Entry
IS	Increment Set	Function Qualifier
KZ	kHz	Units Entry
LO	LO ALC	Function Feature
MV	mV	Units Entry
MZ	MHz	Units Entry
PC	Percent ²	Units Entry
PD	Phase Decrement	Function Feature
PI	Phase Increment	Function Feature
PM	Pulse Modulation	Function Entry
P4	$\pi/4$ DQPSK Modulation	Turns On
P0	$\pi/4$ DQPSK Modulation	Turns Off
QS	Reverse Sequence	Feature
RC	Recall (0-9)	Feature
RL	Recall (0-99)	Feature
RP	Reverse Power Protection Reset ³	Feature
R0	Standby ⁴	Feature
R1	On ⁴	Feature
R2	RF OFF	Function Feature
R3	RF ON	Function Feature
R5	RF Dead	Function Feature
SQ	Sequence	Feature
ST	Save (0-9)	Feature
SV	Save (0-99)	Feature
S1	External Modulation Source	Source Qualifier
S2	Internal 400 Hz Modulation Source	Source Qualifier
S3	Internal 1 kHz Modulation Source	Source Qualifier
S4	Modulation Source Off	Source Qualifier
S5	DC FM	Function Entry

¹ Program codes can be either upper or lower case.
² Either PC or % can be used.
³ The source of reverse power must be removed.
⁴ The POWER switch must be set to the ON position.

Table 3-4. HP-IB Program Codes (Alphabetical Order) (2 of 2)

Program Code ¹	Parameter	Comments
UP	Step Up (\uparrow)	Function Feature
UV	μ V	Units Entry
VL	Volts	Units Entry
0-9	Numerals 0-9	Data Entries
-	Minus Sign	Data Entry
.	Decimal Point	Data Entry
%	Percent ²	Units Entry

¹ Program codes can be either upper or lower case.
² Either PC or % can be used.
³ The source of reverse power must be removed.
⁴ The POWER switch must be set to the ON position.

Table 3-5. HP-IB Program Codes (Functional Order)

Parameter	Program Code ¹	Parameter	Program Code ¹
Frequency		Units (Cont'd)	
Frequency (carrier)	FR	EMF	EM
		Volts	VL
Amplitude		mV	MV
Amplitude (carrier)	AP	μ V	UV
Amplitude Offset	AO	Hz	HZ
		kHz	KZ
Modulation		MHz	MZ
Amplitude Modulation	AM	Percent ²	PC
Frequency Modulation	FM	Percent ²	%
External Modulation Source	S1		
Internal 400 Hz Modulation Source	S2	Other	
Internal 1 kHz Modulation Source	S3	HI ALC	HI
Modulation Source Off	S4	LO ALC	LO
DC FM	S5	Step Up (\uparrow)	UP
Pulse Modulation	PM	Step Down (\downarrow)	DN
$\pi/4$ DQPSK Modulation (turns on)	P4	Increment Set	IS
$\pi/4$ DQPSK Modulation (turns off)	P0	Phase Increment	PI
		Phase Decrement	PD
Data		Standby ³	R0
Numerals 0-9	0-9	On ³	R1
Minus Sign	-	RF OFF	R2
Decimal Point	.	RF ON	R3
		Save (0-9)	ST
Units		Recall (0-9)	RC
dB	DB	Save (0-99)	SV
dBf	DF	Recall (0-99)	RL
dBm	DM	Sequence	SEQ
		Flexible Sequence	GT
		Reverse Sequence	QS
		Reverse Power Protection Reset ⁴	RP

¹ Program codes can be either upper or lower case.
² Either PC or % can be used.
³ The POWER switch must be in the ON position.
⁴ The source of reverse power must be removed.

Table 3-6. Commonly Used Code Conversions

ASCII	Binary	Octal	Decimal	Hexadecimal
NUL	00 000 000	000	0	00
SOH	00 000 001	001	1	01
STX	00 000 010	002	2	02
ETX	00 000 011	003	3	03
EOT	00 000 100	004	4	04
ENQ	00 000 101	005	5	05
ACK	00 000 110	006	6	06
BEL	00 000 111	007	7	07
BS	00 001 000	010	8	08
HT	00 001 001	011	9	09
LF	00 001 010	012	10	0A
VT	00 001 011	013	11	0B
FF	00 001 100	014	12	0C
CR	00 001 101	015	13	0D
SO	00 001 110	016	14	0E
SI	00 001 111	017	15	0F
DLE	00 010 000	020	16	10
DC1	00 010 001	021	17	11
DC2	00 010 010	022	18	12
DC3	00 010 011	023	19	13
DC4	00 010 100	024	20	14
NAK	00 010 101	025	21	15
SYN	00 010 110	026	22	16
ETB	00 010 111	027	23	17
CAN	00 011 000	030	24	18
EM	00 011 001	031	25	19
SUB	00 011 010	032	26	1A
ESC	00 011 011	033	27	1B
FS	00 011 100	034	28	1C
GS	00 011 101	035	29	1D
RS	00 011 110	036	30	1E
US	00 011 111	037	31	1F
SP	00 100 000	040	32	20
!	00 100 001	041	33	21
"	00 100 010	042	34	22
#	00 100 011	043	35	23
\$	00 100 100	044	36	24
%	00 100 101	045	37	25
&	00 100 110	046	38	26
'	00 100 111	047	39	27
(00 101 000	050	40	28
)	00 101 001	051	41	29
*	00 101 010	052	42	2A
+	00 101 011	053	43	2B
,	00 101 100	054	44	2C
-	00 101 101	055	45	2D
.	00 101 110	056	46	2E
/	00 101 111	057	47	2F
0	00 110 000	060	48	30
1	00 110 001	061	49	31
2	00 110 010	062	50	32
3	00 110 011	063	51	33
4	00 110 100	064	52	34
5	00 110 101	065	53	35
6	00 110 110	066	54	36
7	00 110 111	067	55	37
8	00 111 000	070	56	38
9	00 111 001	071	57	39
:	00 111 010	072	58	3A
;	00 111 011	073	59	3B
<	00 111 100	074	60	3C
=	00 111 101	075	61	3D
>	00 111 110	076	62	3E
?	00 111 111	077	63	3F

ASCII	Binary	Octal	Decimal	Hexadecimal
@	01 000 000	100	64	40
A	01 000 001	101	65	41
B	01 000 010	102	66	42
C	01 000 011	103	67	43
D	01 000 100	104	68	44
E	01 000 101	105	69	45
F	01 000 110	106	70	46
G	01 000 111	107	71	47
H	01 001 000	110	72	48
I	01 001 001	111	73	49
J	01 001 010	112	74	4A
K	01 001 011	113	75	4B
L	01 001 100	114	76	4C
M	01 001 101	115	77	4D
N	01 001 110	116	78	4E
O	01 001 111	117	79	4F
P	01 010 000	120	80	50
Q	01 010 001	121	81	51
R	01 010 010	122	82	52
S	01 010 011	123	83	53
T	01 010 100	124	84	54
U	01 010 101	125	85	55
V	01 010 110	126	86	56
W	01 010 111	127	87	57
X	01 011 000	130	88	58
Y	01 011 001	131	89	59
Z	01 011 010	132	90	5A
[01 011 011	133	91	5B
\	01 011 100	134	92	5C
]	01 011 101	135	93	5D
^	01 011 110	136	94	5E
_	01 011 111	137	95	5F
`	01 100 000	140	96	60
a	01 100 001	141	97	61
b	01 100 010	142	98	62
c	01 100 011	143	99	63
d	01 100 100	144	100	64
e	01 100 101	145	101	65
f	01 100 110	146	102	66
g	01 100 111	147	103	67
h	01 101 000	150	104	68
i	01 101 001	151	105	69
j	01 101 010	152	106	6A
k	01 101 011	153	107	6B
l	01 101 100	154	108	6C
m	01 101 101	155	109	6D
n	01 101 110	156	110	6E
o	01 101 111	157	111	6F
p	01 110 000	160	112	70
q	01 110 001	161	113	71
r	01 110 010	162	114	72
s	01 110 011	163	115	73
t	01 110 100	164	116	74
u	01 110 101	165	117	75
v	01 110 110	166	118	76
w	01 110 111	167	119	77
x	01 111 000	170	120	78
y	01 111 001	171	121	79
z	01 111 010	172	122	7A
{	01 111 011	173	123	7B
	01 111 100	174	124	7C
}	01 111 101	175	125	7D
~	01 111 110	176	126	7E
DEL	01 111 111	177	127	7F

Table 3-7. HP-IB Message Reference Table

HP-IB Capability	Applicable	Response	Related Commands and Controls*	Interface Functions*
Data	Yes	All Front-Panel functions, except for DSPL, DSPL in conjunction with SEQ, display Amplitude Offset, Backspace, COARSE TUNE, FINE TUNE, and display HP-IB ADRS are programmable. The front panel ADRS annunciator lights when the HP 8657D is addressed to listen.		T0, L2, AH1, SH0
Trigger	No	The HP 8657D does not have a device trigger (DT0) capability.	GET	DT0
Clear	Yes	Resets the HP 8657D to a carrier frequency of 100 MHz, an output amplitude of -143.5 dBm, and no modulation. Responds equally to Device Clear(DCL) and Selected Device Clear (SDC) bus commands.	DCL, SDC	DC1
Remote	Yes	Remote operation is entered when the Remote Enable (REN) bus control line is true and the HP 8657D is first addressed to listen. The front-panel RMT and ADRS annunciators both light when remote operation is entered, all front-panel keys are disabled (except for the LOCAL key and the POWER switch), and the output signal remains unchanged.	REN	RL1
Local	Yes	The HP 8657D returns to local operation (full front-panel control) when either the Go to Local (GTL) bus command is received or the front-panel LOCAL key is pressed. The output signal remains unchanged.	GTL	RL1
Local Lockout	Yes	Disables the front-panel LOCAL key so that only the controller can return the HP 8657D to local operation.	LLO	RL1
Clear Lockout/Set Local	Yes	The HP 8657D returns to local operation and local lockout is cleared when the REN bus control line goes false.	REN	RL1
Pass Control/Take Control	No	The HP 8657D has no control capability.		C0
Require Service	No	The HP 8657D does not have the capability to request service.		SR0
Status Byte	No	The HP 8657D does not have the capability to respond to a serial poll.		T0
Status Bit	No	The HP 8657D does not have the capability to respond to a parallel poll enable.		PP0
Abort	Yes	The HP 8657D stops listening.	IFC	T0, L2
Driver Electronics	Yes	The HP 8657D has an open-collector, TTL, interface.		E1

* Commands, Control lines and Interface Functions are defined in IEEE Std 488 (and the identical ANSI Standard MC1.1). Knowledge of these might not be necessary if your controller's manual describes programming in terms of the twelve HP-IB Messages shown in the left column. Complete HP-IB capability as defined in IEEE Std 488 (and the identical ANSI Standard MC1.1) is: SH0, E1, AH1, T0, L2, SR0, RL1, PP0, DC1, DT0, and C0.

3-8. SWITCHING CHARACTERISTICS

The HP 8657D switching characteristics are an important consideration in applications involving a computer controller. If the timing requirements are not taken into account in the controller's program, it will be impossible in many situations to make meaningful measurements on a device driven by the HP 8657D.

Switching times for frequency, modulation, and amplitude have several characteristics in common. In each case a finite amount of time passes from the command (manual or computer generated) until the required output occurs. Software execution time is required for the microprocessor and related digital circuits to process the data. This begins with a valid final terminator (keystroke or data entry) and ends with the execution in the hardware. The software time may vary considerably depending on the function. Examples are internal instructions to more than one hardware location (may be serial, parallel, or both) and differing amounts of control data and calculations.

Hardware execution time will also vary considerably. This depends on the number of circuits affected, the length of time each takes to change, and whether the changes occur one at a time or concurrently.

When the frequency of the HP 8657D is changed, the RF OUTPUT is turned off, then turned back on to ensure no power spikes. The RF OUTPUT off period is approximately 15 ms.

To disable the 15 ms RF power drop-out select SHIFT \uparrow (FM); the up-arrow located below the FM button. This leaves the power output constant during frequency changes; that is, power transients are avoided by using a high bandwidth ALC (HI ALC) in the output section. To restore the HP 8657D to normal operation, select SHIFT \downarrow (FM); the down-arrow located below the FM button. This restores low bandwidth ALC (LO ALC), 15 ms RF power drop-out during frequency switching.

The HI ALC mode (no RF power drop-out) is volatile and cannot be saved as part of a storage register. However, recalling a register or sequence will not change the current ALC mode. Power up condition is LO ALC.

Frequency Switching The HP 8657D will typically be within 100 Hz of the final frequency and 1 dB of the required level within 25 ms after receiving the valid units data (terminator). Figure 3-2 shows the sequence of events and the typical error frequency relative to time. Area I shows the software execution time. Areas II through IV make up the hardware execution time.

At times certain events in the frequency switching cycle may be bypassed. For example, small frequency changes will often eliminate event II, the loop settling time or event III, the FM calibration cycle. However, the frequency change that allows these events to be bypassed depends on an involved algorithm that is a function of frequency. Therefore, it is best to assume that the entire sequence of events shown in Figure 3-2 occurs every time a frequency change is made.

To minimize the effects of variety in frequency switching times (especially near the frequency band edges), switch to the desired frequency from the same direction each time, that is, from either above or below the desired frequency. Ideally, the frequency change should be made from the same preset frequency.

During the FM calibration cycle caused by a frequency change, FM modulation is disabled (if it was enabled). This also applies to mixed modulation such as FM from two sources, or simultaneous AM and FM. After the frequency change and FM calibration is complete, FM modulation is turned back on.

In the $\pi/4$ DQPSK Modulation Mode, the frequency is typically within 100 Hz of the final frequency within 35ms after receiving the valid units data (terminator).

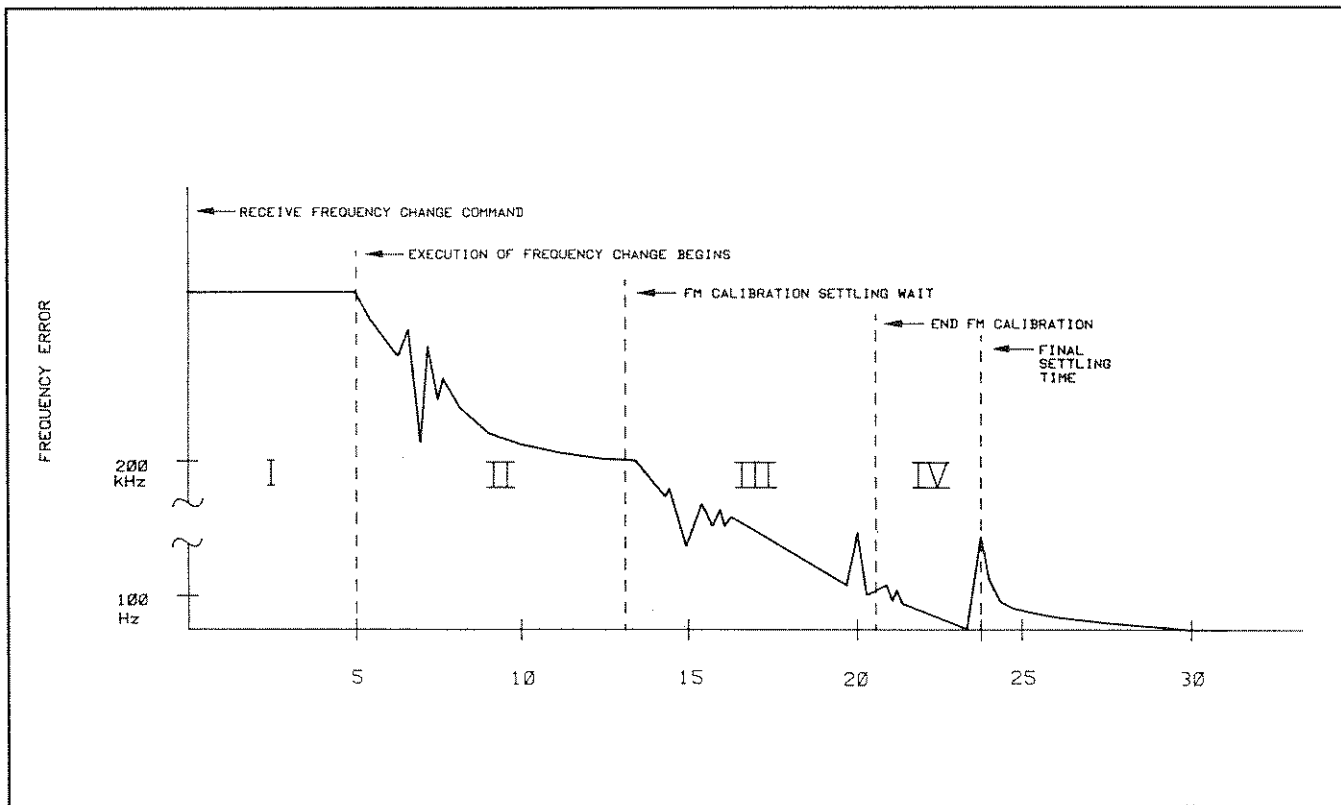

Figure 3-7. Frequency Switching Characteristics

Amplitude Switching. During an RF amplitude change, the final level is always approached from a lower level. This means that a critical amplitude level is never exceeded in the course of normal Signal Generator operation.

Software correction of amplitude with respect to frequency may cause the amplitude to be uncalibrated while a frequency change occurs.

The basic unit for amplitude in the Signal Generator is dBm. An input in other units requires calculations. This tends to increase the software execution time considerably. For example, an input in dBm generally will take about 30 ms from the terminator to the end of software execution. Example of a change with calculations involved are:

- a preset level in mV with a change in dB, 30 ms
- a preset level and change in mV, 300 ms
- a preset level in dBm with a change in mV, 340 ms

A 10 dB change without modulation (narrowband Automatic Level Control-ALC) may take up to 50 ms in the vernier hardware circuits. With modulation (wideband ALC), the switching time is typically 40 ms. The step attenuator switching time is approximately 12 ms.

Minimal software and hardware execution time is 40 to 50 ms. The most complex change may take up to 400 ms.

Modulation Switching. If the RF OUTPUT is modulated, depending on the type of modulation selected, the switching time may be increased. There are applications where it is necessary to turn modulation on or off, or to change to another modulation level. It takes about 400 ms for the modulation accuracy (AM or FM) to be within tolerance from the time the modulation (audio oscillator) is initially turned on. An FM deviation change typically occurs 60 ms after the final terminator (Units Key) triggers the change. Turning the FM off takes about 20 ms. Amplitude modulation normally takes about 120 ms to turn off or to change to a new depth.

3-9. DETAILED OPERATING INSTRUCTIONS

The information contained in this section is presented as follows:

Title: Lists the main feature or function to be discussed.

Description: Describes the feature or function.

Keystroke Sequence: Provides information to allow you to use the feature or function.

Example: Describes the necessary steps required to accomplish one or more of the features or functions discussed in the "Keystroke Sequence."

Keys and Program Codes: Lists a table with the associated keys and HP-IB program codes for controller execution of that feature or function.

Indications: Describes the response of the HP 8657D when the keystroke sequence is performed; which annunciators will light, and which displays are used.

Comments: Describes any miscellaneous information or information to clarify the feature or function capabilities.

Related Instructions: Lists other features or functions which are related.

Table 3-8. Index of Detailed Operating Instructions

Instruction	Page	Instruction	Page
Frequency	3-39	Increment Value Change	3-47
Frequency, Coarse and Fine Tune	3-41	Increment Value Display	3-49
Frequency, Phase Up/Down	3-43	Display	3-37
Frequency, Up/Down	3-44	Display Amplitude Offset	3-36
Amplitude	3-29	Display Sequence	3-38
Amplitude Conversion	3-31	Instrument Preset	3-51
Amplitude Offset	3-33	Recall	3-75
Amplitude, Up/Down	3-34	RF OFF/ON	3-76
Modulation, AM	3-52	Save	3-77
Modulation, AM Up/Down	3-54	Sequence	3-78
Modulation, DC FM	3-56	HP-IB Address Display	3-46
Modulation, DC FM Up/Down	3-58		
Modulation, External Source	3-60		
Modulation, FM	3-62		
Modulation, FM Up/Down	3-64		
Modulation, Mixed	3-66		
Modulation, Off	3-70		
Modulation, Pulse	3-72		
Modulation, $\pi/4$ DQPSK	3-73		

The detailed operating instructions are arranged in alphabetical order beginning on page 5-29.



Amplitude

Description

This instruction details how to set the output amplitude.

Operating Characteristics

Range: +13 dBm to -143.5 dBm (+120 dB μ V to -35.5 dB μ V)

$\pi/4$ DQPSK Modulation Mode:

- +3 dBm to -143.5 dBm 10 to 129.9 MHz
- +7 dBm to -143.5 dBm 810 to 945 MHz
- +3 dBm to -143.5 dBm 1420 to 1540 MHz

Resolution: 0.1 dB

Keystroke Sequence

Press the AMP/DI Function key, the desired Data keys, and a valid Units key or combination of valid Units keys.

Examples

Set the output amplitude to -12.3 dBm.

	FUNCTION	DATA	UNITS
LOCAL (keys)	AMP/DI	- 1 2 . 3	dBm
HP-IB (program codes)	AP -12.3 DM		

Set the output amplitude to -2.0 dB EMF μ V.

	FUNCTION	DATA	UNITS
LOCAL (keys)	AMP/DI	- 2 . 0	dB EMF μ V
HP-IB (program codes)	AP -2.0 DB EM UV		

Keys and Program Codes

Keys	Codes
AMPTD	AP
dBm	DM
dBf	DF
dB	DB
EMF	EM
V	VL
mV	MV
μ V	UV

Indications

The selected output amplitude (with sign and units) will be displayed in the AMPLITUDE Display.

Comments

Digits selected beyond the specified resolution of the AMPLITUDE Display are truncated.

Leading zeros are blanked.

Calibrated level is from -127 dBm to +3.5 dBm with underrange to -143.5 dBm and overrange to +17 dBm.

Minus sign may be entered at any time before the final terminator.

Amplitude Data entries that would cause the peak envelope power of the HP 8657D to exceed +17 dBm are rejected.

Amplitude function remains selected until:

- a. One of the three remaining functions is selected (AM, FM, or FREQUENCY).
- b. One of the SAVE, RECALL, SEQUENCE keys or Display (SHIFT, DSPL) is pressed.
- c. The HP 8657D is preset, unplugged, or switched to standby.

Fourteen valid units entries are possible which will cause one or more AMPLITUDE annunciators to light. They are as follows:

dBm	dB μ V	V	EMF mV
dBf	dB EMF V	mV	EMF μ V
dBV	dB EMF mV	μ V	
dBmV	dB EMF μ V	EMF V	

Whenever a reverse power condition is detected, all segments and all eight LED annunciators associated with the AMPLITUDE Display flash until the source of reverse power is removed and the AMPTD key is pressed.

Related Instructions

Amplitude Conversion
Amplitude, Up/Down

Amplitude Conversion

Description

This instruction details how to change the AMPLITUDE Display from power units in dBm to any one of 13 other valid unit configurations. This feature does not affect the actual output amplitude of the HP 8657D.

Keystroke Sequence

Press any valid Units key or combination of valid Units keys with the amplitude function selected.

Example

The AMPLITUDE display shows 10.0 dBm. Change the display to units of dB μ V. (The resulting display will be 117.0 dB μ V.)

LOCAL (keys)	PREFIX TERMINATOR	FINAL TERMINATOR
	dB	μ V
HP-IB (program codes)	DB UV	

Keys and Program Codes

Keys	Codes
dBm ¹	DM ¹
dBf ¹	DF ¹
dB ^{2,3}	DB ^{2,3}
EMF ²	EM ²
V ¹	VL ¹
mV ¹	MV ¹
μ V ¹	UV ¹
¹ Final Terminator. ² Prefix Terminator. ³ Final Terminator for Increment Set.	

Indications

The AMPLITUDE Display changes to reflect the newly selected units, and the corresponding annunciator(s) will light.

Comments

The Amplitude function must be selected before the conversion entry or entries are made.

Logarithmic Data entries (dBm or dBf) will be displayed in the AMPLITUDE Display with 0.1 dB resolution.

The dBm or dBf Units terminator overrides a dB or EMF terminator.

If a dB or EMF Units terminator is selected, the AMPLITUDE Display is blanked, the corresponding annunciator lights, and the HP 8657D waits for a final terminator to be entered.

Linear Data entries (V, mV, or μ V) are displayed in the three most significant digits of the AMPLITUDE Display, and the linear terminator is autoranged (or adjusted) to comply with this condition.

Conversion formulas used are as follows:

$$\begin{aligned}
 dB &= dBm \\
 dBf &= dBm + 120.0 \\
 dBV &= dBm - 13.0 \\
 dBmV &= dBm + 47.0 \\
 dB \mu V &= dBm + 107.0 \\
 dB \text{ EMF } V &= dBm - 7.0 \\
 dB \text{ EMF } mV &= dBm + 53.0 \\
 dB \text{ EMF } \mu V &= dBm + 113.0 \\
 V &= 10^{(dBm-13.0)/20} \\
 mV &= 10^{(dBm+47.0)/20} \\
 \mu V &= 10^{(dBm+107.0)/20} \\
 \text{EMF } V &= 10^{(dBm-7.0)/20} \\
 \text{EMF } mV &= 10^{(dBm+53.0)/20} \\
 \text{EMF } \mu V &= 10^{(dBm+113.0)/20}
 \end{aligned}$$

Related Instructions

Amplitude
Amplitude, Up/Down

Amplitude Offset

Description

This instruction details how to use the Amplitude Offset feature. This feature can be used to compensate the output amplitude for gains or losses in a test system due to cables, mixers, etc.

Keystroke Sequence

Press the SHIFT key, the AMPTD key, then use the Data keys to select the offset you want. Enter the offset by pressing the dB key.

Keys and Program Codes

Keys	Codes
AMPTD dB	AO DB

Indications

The RF OUTPUT amplitude is increased or decreased by the value of the offset, and the OFFSET annunciator lights.

The displayed amplitude does not change.

Comments

To check the value of offset, press the SHIFT key then press and hold the AP OFS key.

To reset the output amplitude to the displayed value, enter an offset of 0 dB.

The Amplitude Offset initializes to 0 dB when the HP 8657D is PRESET.

A change in RF OUTPUT amplitude that would make the sum of the amplitude and offset to be above or below the operating limits of the HP 8657D, will cause the HP 8657D to output only a maximum or minimum output limit.

Performing this feature clears any previously selected function.

Related Instructions

Display Amplitude Offset

Amplitude, Up/Down

Description

This instruction details how to change the output amplitude by the stored value of amplitude increment.

Keystroke Sequence

Press the AMPTD \uparrow or AMPTD \downarrow key.

Keys and Program Codes

Keys	Codes
AMPTD \uparrow \downarrow	AP UP DN

NOTE

During remote operation, repeated UP or DN codes can be sent over the bus once the amplitude function is selected.

Indications

The output amplitude changes by the stored value of amplitude increment.

Comments

Keeping either key pressed continues to change the output amplitude.

If the output amplitude increment is set to a value that would cause the HP 8657D to exceed its amplitude range (+17 dBm to -143.5 dBm), the AMPTD \uparrow or AMPTD \downarrow key becomes inoperative (this is determined by which amplitude limit would be exceeded).

A correct decrease in the increment setting re-enables the AMPTD \uparrow or AMPTD \downarrow key.

Performing this feature places the HP 8657D in the Amplitude Data entry mode, and clears any previously selected function.

Increment entries are checked against maximum and minimum allowable increment limits. If a limit is exceeded, the increment entry is either truncated or rejected.

Initialized value and limits of the output amplitude increment are as follows:

Initialized Value	Minimum Value	Maximum Value
10.0 dB	0.1 dB	160.5 dB

Related Instructions

- Amplitude
- Amplitude Conversion
- Increment Value Change
- Increment Value Display

Display Amplitude Offset

Description

This instruction details how to display the value of the Amplitude Offset.

Keystroke Sequence

Press the SHIFT key, then press and hold the AMPTD key.

Indications

The Amplitude Offset value is shown in the AMPLITUDE display as long as the AMPTD key remains pressed.

Comments

The Amplitude Offset initializes to a value of 0 dB when the HP 8657D is preset. If RF ON/OFF is switched to OFF, you can still check the value of Amplitude Offset.

Performing this feature:

- Clears any previously selected function.
- Does not affect the original AMPLITUDE display setting.
- Keeps the HP 8657D in the Amplitude Offset mode until another function key is pressed.

Related Instructions

Amplitude Offset
Display
Display Sequence
HP-IB Address Display
Increment Value Display

Display

Description





This instruction details how to review a saved front-panel set-up.

Keystroke Sequence

Press the SHIFT key then press the DSPL key. Use the Data keys to select the set-up you want to review (press and hold the second Data key).

Example

Review the front-panel set-up saved in memory location 02.

<p>LOCAL (keys)</p>				
<p> (program codes)</p>	<p>This feature is not accessible via HP-IB.</p>			

Indications

The selected set-up is displayed as long as the last Data key remains pressed and will remain for 1 second after the second Data key is released.

Comments

You can save up to 100 (00-99) front-panel set-ups (exclusive of increment settings).

Performing this feature:

- Does not affect the current set-up of the HP 8657D.
- Does not change the position of the sequence counter.
- Clears any previously selected function.

All displays are restored to the current HP 8657D set-up when the Data key is released.

Related Instructions

Display Amplitude Offset
 Display Sequence
 Recall
 Sequence
 Store

Display Sequence

Description

This instruction details how to display the current position of the sequence counter.

Keystroke Sequence

Press the SHIFT key, press DSPL, and then press and hold the SEQ key.

Indications

The amplitude and modulation displays will blank and the frequency display will appear as XX...YY. XX is the current active register and YY is the next register the HP 8657D will jump to when given a SEQUENCE command. This display will remain for 1 second after the SEQUENCE command is released.

Comments

Performing this feature:

- Clears any previously selected function.
- Does not affect the actual output of the HP 8657D.

The AMPLITUDE Display is restored to reflect the actual HP 8657D output when the SEQ key is released.

Related Instructions

Display
Display Amplitude Offset
Sequence

Frequency

Description

This instruction details how to set the carrier frequency.

Keystroke Sequence

Press the FREQUENCY Function key, the desired Data keys, and a valid Units key.

Example

Set the carrier frequency to 123.45 MHz.

LOCAL (keys)	FUNCTION	DATA	UNITS
	FREQ	1 2 3 . 4 5	MHz
HP-IB (program codes)	FR 123.45 MZ		

Keys and Program Codes

Keys	Codes
FREQ	FR
MHz	MZ
kHz	KZ
No key	HZ

Indications

The selected carrier frequency is displayed in megahertz in the FREQUENCY Display.

Comments

Digits selected beyond the specified resolution of the FREQUENCY Display are truncated.

Leading zeros are blanked.

Carrier frequencies below 100 kHz will result in an uncalibrated output amplitude.

$\pi/4$ DQPSK Frequency Bands are:

- 10 to 129.9 MHz
- 810 to 965 MHz
- 1420 to 1540 MHz

If you select a carrier frequency that makes the currently selected FM Peak Deviation outside the Signal Generator operating limits, then the MODULATION Display flashes. To clear this error condition enter a new carrier frequency in the correct band for the selected Peak Deviation. To automatically select the maximum permitted Peak Deviation for the carrier frequency, press the FM, FM \uparrow or FM \downarrow key.

HP 8657D Carrier Frequency (MHz)	Maximum Peak Deviation	
	AC Mode	DC Mode
	(the lesser of)	
0.1 to 130	200 kHz or $4000 \times \text{rate (Hz)}$	200 kHz
130 to 260	50 kHz or $1000 \times \text{rate (Hz)}$	50 kHz
260 to 520	100 kHz or $2000 \times \text{rate (Hz)}$	100 kHz
520 to 1040	200 kHz or $4000 \times \text{rate (Hz)}$	200 kHz

The Frequency function remains selected until:

- a. One of the three remaining functions is selected (AM, FM, or AMPTD).
- b. One of the SAVE, RECALL, SEQUENCE keys or Display (SHIFT, DSPL) is pressed.
- c. The Signal Generator is preset, unplugged, or switched to standby.

Related Instructions

Frequency, Coarse and Fine Tune
 Frequency, Up/Down

Frequency, Coarse and Fine Tune

Description

This instruction details how to quickly tune the carrier frequency in decade steps using the step-up and step-down keys associated with the carrier frequency function.

Keystroke Sequence

This feature is enabled by pressing either the COARSE TUNE or FINE TUNE key.





Pressing either key will increase (COARSE TUNE) or decrease (FINE TUNE) the carrier frequency tuning value by a factor of 10.

Pressing the step-up key increases the carrier frequency by the newly selected carrier frequency tuning value, while pressing the step-down key decreases the carrier frequency.

This feature is disabled and the original carrier frequency increment value is enabled by pressing the INCR SET key (with the frequency function selected).

Example

Enable a carrier frequency tuning value of 10 kHz (assuming a starting value of 10 MHz).

LOCAL (keys)			
 (program codes)	This feature is not accessible via HP-IB.		

Indications

Whenever the COARSE TUNE or FINE TUNE key is pressed and held, the frequency digit that corresponds to the carrier frequency tuning value will flash.

When the COARSE TUNE key is pressed again, the next digit to the left will flash to indicate the new tuning value.

When the FINE TUNE key is pressed again, the next digit to the right will flash to indicate the new tuning value.

Comments

This feature only applies to the carrier frequency function.

COARSE TUNE and FINE TUNE keys are always available to change the carrier frequency tuning value by a factor of 10.

Performing this feature:

- Places the Signal Generator into the frequency Data entry mode, and clears any previously selected function, once either the step-up or step-down key is pressed.
- Enables the last valid carrier frequency increment value when the INCR SET key is pressed.

Related Instructions

Frequency
Frequency, Up/Down
Increment Value Change

Frequency, Phase Up/Down

Description

This instruction details how to change the carrier frequency phase in one-degree increments or decrements with respect to the internal or external timebase.

Keystroke Sequence

Press the SHIFT key, then press the \uparrow ($\Phi\uparrow$) or \downarrow ($\Phi\downarrow$) keys associated with the carrier frequency function.

Keys and Program Codes

Keys	Codes
$\Phi\uparrow$	PI
$\Phi\downarrow$	PD

NOTE

During remote operation, repeated PI or PD codes can be sent over the bus. Phase changes in 1 degree steps each time code is executed.

Indications

The carrier frequency phase changes in 1 degree steps each time the keystroke sequence is followed.

Comments

The carrier frequency phase continues to increment or decrement in 1 degree steps, if either key remains pressed.

Selecting this feature does not affect any previously selected function.

Performing this feature:

1. Places the HP 8657D into frequency Data entry mode, and clears any previously selected function, once either the \uparrow or \downarrow key is pressed.
2. Enables the last valid carrier frequency increment value when the INCR SET key is pressed.

Related Instructions

Frequency
Frequency, Up/Down
Increment Value Change

Frequency, Up/Down

Description

This instruction details how to change the carrier frequency by the stored value of frequency increment.

Keystroke Sequence

Press the **FREQ** \uparrow or **FREQ** \downarrow key.

Keys and Program Codes

Keys	Codes
FREQ \uparrow \downarrow	FR UP DN

NOTE

During remote operation, repeated UP or DN codes can be sent over the bus once the frequency function is selected.

Indications

The carrier frequency changes by the stored value of frequency increment.

Comments

Performing this feature:

- Places the Signal Generator in the Frequency Data entry mode, and clears any previously selected function.
- Continues to change the carrier frequency by the stored value of frequency increment if either key remains pressed.

Increment entries are checked against maximum and minimum allowable increment limits. If a limit is exceeded, the increment entry is either truncated or rejected.

If the carrier frequency increment is set to a value that would cause the Signal Generator to exceed its frequency range, then either the **FREQ** \uparrow or **FREQ** \downarrow key is made inactive (determined by which frequency limit would be exceeded). Decreasing the frequency increment reactivates the key.

If you select a carrier frequency that makes the currently selected FM Peak Deviation outside the Signal Generator's operating limits, then the MODULATION Display flashes. To clear this error condition enter a new carrier frequency in the correct band for the selected Peak Deviation. To automatically select the maximum permitted Peak Deviation for the carrier frequency, press the FM, FM \uparrow or FM \downarrow key.

HP 8657D Carrier Frequency (MHz)	Maximum Peak Deviation	
	AC Mode	DC Mode
	(the lesser of)	
0.1 to 130	200 kHz or $4000 \times \text{rate (Hz)}$	200 kHz
130 to 260	50 kHz or $1000 \times \text{rate (Hz)}$	50kHz
260 to 520	100 kHz or $2000 \times \text{rate (Hz)}$	100 kHz
520 to 1040	200 kHz or $4000 \times \text{rate (Hz)}$	200 kHz

Initialized value and limits of the carrier frequency increment are as follows:

Model	Initialized Value	Minimum Value	Maximum Value
HP 8657D	1 kHz	0.001 kHz	≤ 999.999999 kHz

Related Instructions

- Frequency
- Frequency, Coarse and Fine Tune
- Increment Value Change
- Increment Value Display

HP-IB Address Display

Description

This details how to display the Signal Generator's decimal HP-IB address.

Keystroke Sequence

Press the SHIFT key, then press and hold ADRS.

Indications

The internally set, decimal HP-IB address is displayed in the MODULATION display as long as ADRS remains pressed.

Comments

The HP-IB address is factory-set to 07 decimal. (In binary, this is 00111, the equivalent ASCII character is an apostrophe).

The HP-IB address is updated only when the Signal Generator is powered up.

To change the HP-IB address, refer to HP-IB Address Selection in Section 2.

The MODULATION Display is restored to reflect the actual output when ADRS is released.

Related Instructions

Display Amplitude Offset

Increment Value Change

Description

This instruction details how to change the value of the stored increments which are controlled by the step-up (⬆) and step-down (⬇) keys associated with each of the four main functions. Increment values for the carrier frequency, output amplitude, AM depth, and FM peak deviation can be stored. The initialized value of each stored increment is listed as follows:





Functions	Initialized Value
Carrier Frequency	100 MHz
Output Amplitude	10 dB
AM Depth	1%
FM Peak Deviation	1.0 kHz

Keystroke Sequence

Press a Function key, the INCR SET key, the desired Data keys, and a valid Units Key.

Example

Set a carrier frequency increment of 1 MHz.

	FUNCTION	INCREMENT SET	DATA	UNITS
LOCAL (keys)				
 (program codes)	FR IS 1 MZ			

Keys and Program Codes

Keys	Codes	Keys	Codes
INCR SET	IS	%	% or PC
FREQ	FR	dBm	DM
AMPTD	AP	dBf	DF
AM	AM	dB	DB

Indications

The value of the increment appears in the display associated with the selected function as the data is entered.

Comments

FM peak deviation increments are selected in units of kHz only. AM depth is selected without fractional digits. All fractional digits are truncated.

If the increment value change is set to a value that would cause the HP 8657D to exceed a minimum or maximum range, the step-up and step-down key associated with that function become inoperative. A correct decrease in the increment setting re-enables the step-up and step-down keys.

Increment entries are checked against maximum and minimum allowable increment limits. If a limit is exceeded the increment entry is either truncated or rejected.

Minimum and maximum allowable increment values for each of the four main functions are listed as follows:

Function	Minimum Value	Maximum Value
Carrier Frequency	0.001 kHz	999.999999 MHz
Output Amplitude	0.1 dB	160.5 dB
	0.001 μ V	1.57 V
	0.001 EMF μ V	3.15 EMF V
AM Depth	1%	100%
FM Peak Deviation	0.1 kHz	200 kHz

All displays are restored to reflect the actual HP 8657D output as soon as a valid increment terminator is selected.

Related Instructions

Amplitude, Up/Down
 Frequency, Coarse and Fine Tune
 Frequency, Up/Down
 Increment Value Display Modulation, AM Up/Down
 Modulation, DC FM
 Modulation, FM Up/Down

Increment Value Display

Description



This instruction details how to display the stored value of the increments which are controlled by the step-up and step-down keys associated with each of the four main functions. Increment values for the carrier frequency, output amplitude, AM depth, and FM peak deviation can be displayed.

Keystroke Sequence

Press a function key, then press and hold the INCR SET key.

Example

Display the stored carrier frequency increment.

	FUNCTION	INCREMENT SET
LOCAL (keys)		
 (program codes)	FR IS	

Keys and Program Codes

Keys	Codes
AM	AM
FM	FM
INCR SET	IS
FREQ	FR
AMPTD	AP

Indications

The stored value of the increment is displayed in the display associated with the selected function as long as the INCR SET key remains pressed.

Comments

The initialized value of each stored increment is listed as follows:

Functions	Initialized Value
Carrier Frequency	100 MHz
Output Amplitude	10 dB
AM Depth	1%
FM Peak Deviation	1.0 kHz

The display is restored to reflect the actual HP 8657D output when the INCR SET key is released.

Related Instructions

Amplitude Up/Down
Display Amplitude Offset
Frequency, Up/Down
Increment Value Change
Modulation, AM Up/Down
Modulation, DC FM
Modulation, FM Up/Down

Instrument Preset

Description

This instruction details how to preset the HP 8657D.

Keystroke Sequence

Press the SHIFT key, and then the 0 units key.

NOTE

Sending the Clear message via HP-IB is equivalent to performing an instrument preset.

Indications

When a preset is performed, the HP 8657D resets to the following:

Carrier Frequency and Amplitude: 100 MHz, -143.5 dBm
Carrier Frequency Increment: 10 MHz
Output Amplitude Increment: 10 dB
Output Amplitude Offset: 0 dB
AM Depth: 0%
AM Depth Increment: 1%
FM Peak Deviation: 0.0 kHz
FM Peak Deviation Increment: 1 kHz
Sequence Counter: Resets to 0

Comments

Performing this feature does not affect any saved front panel set-ups.

Related Instructions

None

Modulation, AM

Description

This instruction details how to select Internal Amplitude Modulation.

Operating Characteristics:







- Depth: 0 - 100%, level \leq +7 dBm, fc >400 kHz
- 0 - 30%, level \leq +10 dBm, fc >400 kHz
- Resolution: 1%
- Rate (internal): 400 Hz and 1 kHz, $\pm 2\%$

Keystroke Sequence

Press an Internal Source key, the AM function key, the desired Data keys, and a valid Units key. (You do not need to press an Internal Source key if you require a 1 kHz modulation rate).

Example

Select Internal AM with a modulation depth of 75% and a modulation rate of 400 Hz.

	SOURCE	FUNCTION	DATA	UNITS
LOCAL (keys)			 	
 (program codes)	S2 AM 75 PC or %			

Keys and Program Codes

Keys	Codes
INT 400 Hz	S2
INT 1 kHz	S3
AM	AM
%	PC or %

Indications

Selected AM depth is displayed in the MODULATION Display, and the source annunciators (INT AM, 400 Hz, and %) will light.

Comments

Amplitude modulation is not available in $\pi/4$ DQPSK Modulation Mode.

Digits selected beyond the specified resolution for AM depth are truncated.

Leading zeros are blanked.

AM depth Data entries that would cause the peak envelope power of the HP 8657D to exceed +17 dBm are rejected.

The External Source key may be selected in place of the Internal Source key.

AM function remains selected until:

- a. One of the three remaining functions is selected (AMPTD, FM, or FREQuency).
- b. One of the SAVE, RECALL, SEQuence keys or Display (SHIFT, DSPL) is pressed.
- c. The HP 8657D is preset, unplugged, or switched to standby.

A one key sequence acts as a select between the two internal modulation sources.

Only one internal modulation source can be selected at any time either 400 Hz or 1 kHz.

Related Instructions

Modulation, AM Up/Down
Modulation, External Source
Modulation, Mixed
Modulation, Off
Modulation, Pulse

Modulation, AM Up/Down

Description

This instruction details how to change the percentage of AM depth by the stored value of AM depth increment.

Keystroke Sequence

Press the AM \uparrow or AM \downarrow key.

Keys and Program Codes

Keys	Codes
AM \uparrow \downarrow	AM UP DN

NOTE

In remote operation, repeated UP or DN codes can be sent over the bus once the AM function is selected.

Indications

The percentage of AM depth changes by the stored value of AM depth increment.

Comments

Performing this feature:

- Places the HP 8657D in the AM Data entry mode, and clears any previously selected function.
- Selects default modulation source (internal 1 kHz) if no other source is selected.
- Will automatically stop incrementing when the maximum percentage of AM depth permitted for a selected output amplitude is reached.
- Continues to change the percentage of AM depth by the value stored in the AM depth increment register if either key remains pressed.

If the AM depth increment is set to a value that would cause the HP 8657D to exceed a modulation depth of 1 to 100%, either the AM \uparrow or AM \downarrow key becomes inoperative (determined by which limit would be exceeded). A correct decrease in the increment setting re-enables the AM \uparrow or AM \downarrow key.

Increment entries are checked against maximum and minimum allowable increment limits. If an AM depth increment limit is exceeded the entry is truncated.

Initialized value and limits of the AM depth increment are as follows:

Initialized Value	Minimum Value	Maximum Value
1%	1%	100%

Related Instructions

- Increment Value Change
- Increment Value Display
- Modulation, AM
- Modulation, Off
- Modulation, DC FM Up/Down
- Modulation, FM Up/Down
- Modulation, Pulse

Modulation, DC FM

Description

This instructions details how to select DC FM modulation.

Operating Characteristics:

Band	Carrier Frequency (MHz)	Maximum Peak Deviation
		DC Mode (kHz)
1	0.1-130	200
2	130-260	50
3	260-520	100
4	520-1040	200

Resolution: 0.1 kHz for peak deviations < 100 kHz (Frequency=0.1 to 1040 MHz)

1 kHz for peak deviations ≥ 100 kHz (Frequency=0.1 to 1040 MHz)

DC calibrated input level: ±1 Vdc

CAUTION

Maximum allowable input level is ±15 Vdc. Exceeding this limit may cause damage to the HP 8657D.

Keystroke Sequence

Press the SHIFT key, the FM function key, the desired Data Keys and a valid Units key.

Example

Select DC FM with a peak deviation of 50 kHz.

LOCAL (keys)	FUNCTION	DATA	UNITS
	SHIFT FM	5 0	kHz
HP 1B (program codes)	S5 50 KZ		

Keys and Program Codes

Keys	Codes
DC FM kHz	S5 KZ

Indications

DC FM is not available in $\pi/4$ DQPSK modulation mode.

Selected DC FM peak deviation are displayed in the MODULATION Display, and the Modulation annunciators (DC FM, EXT FM, and LO EXT) will light.

Comments

Selecting DC FM automatically enables the front-panel MOD INPUT/OUTPUT connector for an external modulation source.

The LO EXT Modulation annunciator remains on regardless of the dc input level applied to the MOD INPUT/OUTPUT connector.

The LO EXT Modulation annunciator turns off if external AM or FM is selected along with DC FM, and the external source has been adjusted to 1 Vpk (0.707 Vrms $\pm 5\%$).

Digits selected beyond the specified resolution for DC FM peak deviation are truncated.

Leading zeros are blanked.

DC FM peak deviation Data entries that would be out-of-range for the selected carrier frequency are rejected.

If you select a carrier frequency that makes the currently selected FM Peak Deviation outside the HP 8657D operating limits, then the MODULATION Display flashes. To clear this error condition enter a new carrier frequency in the correct band for the selected Peak Deviation. To automatically select the maximum permitted Peak Deviation for the carrier frequency, press the FM, FM \uparrow or FM \downarrow key.

DC FM function remains selected until:

- One of the three remaining functions is selected (AM, AMPTD, or FREQUENCY).
- One of the SAVE, RECALL, SEQUENCE keys or Display (SHIFT, DSPL) is pressed.
- The HP 8657D is preset, unplugged, or switched to standby.

Related Instructions

Modulation, DC FM Up/Down
 Modulation, External Source
 Modulation, Mixed
 Modulation, Off
 Modulation, Pulse

Modulation, DC FM Up/Down

Description

This instruction details how to change the DC FM peak deviation by the stored value of FM peak deviation increment.

Keystroke Sequence

Press the FM \uparrow or FM \downarrow key.

Keys and Program Codes

Keys	Codes
DC FM	S5
\uparrow	UP
\downarrow	DN

NOTE

During remote operation, repeated UP or DN codes can be sent over the bus once the DC FM function is selected.

Indications

The DC FM peak deviation changes by the stored value of FM peak deviation increment.

Comments

Performing this feature:

- Continues to change the DC FM peak deviation by the stored value of FM peak deviation increment if either key remains pressed.
- Will automatically stop incrementing when the maximum FM peak deviation permitted for a selected carrier frequency is reached.

If an out-of-range condition exists (MODULATION Display flashing) pressing either the FM, FM \uparrow or FM \downarrow key automatically selects the maximum FM peak deviation permitted for the currently selected carrier frequency.

Initialized value and limits of the FM peak deviation increment are as follows:

Initialized Value	Minimum Value	Maximum Value
1 kHz	0.1 kHz	200 kHz

NOTE

The maximum value of FM peak deviation increment you can select is determined by the Carrier Frequency selected.

Related Instructions

Increment Value Change
Increment Value Display
Modulation, AM Up/Down
Modulation, DC FM
Modulation, FM Up/Down
Modulation, Off
Modulation, Pulse

Modulation, External Source

Description

This instruction details how to apply an external modulation signal via the front-panel MOD INPUT/OUTPUT connector.

Operating Characteristics:

Rate: (AM) 20 Hz to 40 kHz; 1 dB bandwidth, ac coupled
 (FM) 5 Hz to 100 kHz; ± 3 dB, ac coupled
 20 Hz to 50 kHz; ± 1 dB, ac coupled
 dc to 100 kHz; ± 3 dB, dc coupled
 dc to 50 kHz; ± 1 dB, dc coupled

Input Impedance: 600 ohms (resistive)

Input Level: 1 Vpk (0.707 Vrms)

Keystroke Sequence

Press the EXT key to enable the front-panel MOD INPUT/OUTPUT connector, then set the signal level of the external modulation source to 1 Vpk (0.707 Vrms) for calibrated internal control of the AM depth or FM peak deviation.

Keys and Program Codes

Keys	Codes
AM	AM
FM	FM
EXT	S1
%	% or PC
kHz	KZ

Indications

The HI EXT annunciator lights if the external modulation signal is greater than 1.02 Vpk (0.721 Vrms), and the LO EXT annunciator lights if the signal is less than 0.98 Vpk (0.693 Vrms). Both annunciators are off when the input level is 1.00 ± 0.02 Vpk (0.707 Vrms), except when exclusively in the DC FM Mode in which case the LO EXT annunciator remains on.

NOTE

If greater accuracy is required, use a calibrated voltmeter to measure the external modulation signal.

Comments

The 400 Hz or 1 kHz modulation signal is available at the MOD INPUT/OUTPUT connector when INTERNAL modulation is selected (level 1 Vpk - 0.707 Vrms).

For AM or FM the front-panel MOD INPUT/OUTPUT connector is ac coupled. For DC FM the front-panel MOD INPUT/OUTPUT connector is dc coupled.

Related Instructions

Modulation, AM
Modulation, DC FM
Modulation, FM
Modulation, Mixed
Modulation, Off
Modulation, Pulse

Modulation, FM

Description

This instruction details how to select Internal Frequency Modulation.

Operating Characteristics:

Carrier Frequency (MHz)	Maximum Peak Deviation	
	AC Mode	DC Mode
	(the lesser of)	
0.1 to 130	200 kHz or $4000 \times \text{rate (Hz)}$	200 kHz
130 to 260	50 kHz or $1000 \times \text{rate (Hz)}$	50kHz
260 to 520	100 kHz or $2000 \times \text{rate (Hz)}$	100 kHz
520 to 1040	200 kHz or $4000 \times \text{rate (Hz)}$	200 kHz

Resolution: 0.1 kHz for peak deviations < 100 kHz (frequency <1040 MHz)
 1 kHz for peak deviations \geq 100 kHz (frequency <1040 MHz)







Rate (internal): 400 Hz or 1 kHz, $\pm 2\%$

Keystroke Sequence

Press an internal Source key, the FM Function key, the desired Data keys, and a valid Units key. (You do not need to press an Internal Source key if you require a 1 kHz modulation rate).

Example

Select Internal FM with a peak deviation of 25 kHz and a modulation rate of 400 Hz.

	SOURCE	FUNCTION	DATA	UNITS
LOCAL (keys)			 	
 (program codes)	S2 FM 25 KZ			

Keys and Program Codes

Keys	Codes
FM	FM
INT 200 Hz	S2
INT 1 kHz	S3
kHz	KZ

Indications

The FM peak deviation is displayed in the MODULATION Display, and the source annunciators (INT FM and 400 Hz) light.

Comments

Frequency modulation is not available in $\pi/4$ DQPSK Modulation Mode.

Digits selected beyond the specified resolution for FM peak deviation are truncated.

Leading zeros are blanked.

A one-key sequence acts as a select between the two internal modulation sources.

The External Source key may be selected in place of the Internal Source key.

Only one internal modulation source can be selected at any time, either 400 Hz or 1 kHz.

FM peak deviation Data entries are rejected if they would cause the selected carrier frequency to be out-of-range.

If you select a carrier frequency that makes the currently selected FM Peak Deviation outside the HP 8657D operating limits, then the MODULATION Display flashes. To clear this error condition enter a new carrier frequency in the correct band for the selected Peak Deviation.

To automatically select the maximum permitted Peak Deviation for the carrier frequency, press the FM, FM \uparrow or FM \downarrow key.

The FM function remains selected until:

- One of the three remaining functions is selected (AM, AMPTD, or FREQUENCY).
- One of the SAVE, RECALL, SEQUENCE keys or Display (SHIFT, DSPL) is pressed.
- The HP 8657D is preset, unplugged, or switched to standby.

Related Instructions

Modulation, FM Up/Down
 Modulation, External Source
 Modulation, Mixed
 Modulation, Off
 Modulation, Pulse

Modulation, FM Up/Down

Description

This instruction details how to change the FM Peak Deviation by the stored value of FM Peak Deviation increment.

Keystroke Sequence

Press the FM \uparrow or FM \downarrow key.

Keys and Program Codes

Keys	Codes
FM \uparrow \downarrow	FM UP DN

NOTE

In remote operation, repeated UP or DN codes can be sent over the bus once the FM function is selected.

Indications

The FM peak deviation changes by the stored value of FM peak deviation increment.

Comments

If the FM peak deviation increment is set to a value that would cause the HP 8657D to exceed its peak deviation range, the step-up and step-down keys become inoperative. A correct decrease in the increment setting re-enables the step-up and step-down keys.

Performing this feature:

- Places the HP 8657D in the FM Data entry mode, and clears any previously selected function.
- Selects default modulation source (internal 1 kHz) if no other source is selected.
- Continues to change the FM peak deviation by the value stored in the FM peak deviation increment register if either key remains pressed.
- Will automatically stop incrementing when the maximum FM peak deviation permitted for a selected carrier frequency is reached.

If an out-of-range condition exists (MODULATION Display flashing), pressing either the FM, FM \uparrow or FM \downarrow key automatically selects the maximum FM peak deviation permitted for the currently selected carrier frequency.

Increment entries are checked against maximum and minimum allowable increment limits. If a limit is exceeded, the increment entry is either truncated or rejected.

Initialized value and limits of the FM peak deviation increment are as follows:

Initialized Value	Minimum Value	Maximum Value
1.0 kHz	0.1 kHz	200 kHz

NOTE

The maximum value of FM peak deviation increment you can select is determined by the Carrier Frequency selected.

Related Instructions

Increment Value Change
Increment Value Display
Modulation, AM Up/Down
Modulation, FM
Modulation, DC FM Up/Down
Modulation, Off
Modulation, Pulse

Modulation, Mixed

Description

These instructions detail the selection of mixed modulation. Modulation is selected in one of six ways.

1. Simultaneous AM and FM is selected using common or separate modulation sources (rate).
2. Simultaneous AM or FM at two rates is selected by using internal and external modulation sources. Only one AM depth or one FM deviation can be selected.
3. Three simultaneous modulation signals, AM and FM using a common source (rate) and either AM or FM from a separate source, may be selected.
4. Four simultaneous modulation signals, two AM and two FM, may be selected. Each AM/FM pair must have a common modulation source (rate). Only one AM depth and one FM deviation can be selected.
5. DC FM may be selected and entered along with any of the four ways mentioned in statements 1-4.
6. Pulse Modulation may be selected along with AM and FM (Internal and/or External) and/or DC FM Modulation (Option 003 only).

Keystroke Sequence 1

To select simultaneous AM and FM, press the Source key to provide the desired AM rate, the AM Function key, the desired Data keys, and the % Units key. Then press the Source key to provide the desired FM rate, the FM Function key, the desired Data keys, and the kHz Units key. (The Source key need not be pressed for FM if the AM and FM rate is the same. Only one internal rate can be used at a time.)

Example 1

Simultaneously select AM with a depth of 70% and FM with a peak deviation of 3 kHz using the internal 400 Hz source, and an external 1 kHz source respectively.

	SOURCE	FUNCTION	DATA	UNITS
LOCAL (keys)	INT 400 Hz	AM	7 0	%
	EXT	FM	3	KHz
HP-16 (program codes)	S2 AM 70 PC or % S1 FM 3 KZ			

Keystroke Sequence 2

To select simultaneous AM or FM, press the desired Source key, the desired Function key, the desired Data keys, and a valid Units key. Then press the other Source key, and the same Function key that was selected previously.

Example 2

Select FM with a peak deviation of 5 kHz using both an internal 1 kHz modulation source and an external 150 Hz modulation source.

	SOURCE	FUNCTION	DATA	UNITS
LOCAL (keys)	INT 1 kHz	FM	5	kHz
	EXT	FM		
HP-IB (program codes)	S3 FM 5 KZ S1 FM			

Keystroke Sequence 3

To select three simultaneous modulation signals, AM and FM using a common source (rate) and AM or FM from a separate source, press the Source key to provide the common AM and FM rate. Then press a Function key, the desired Data keys, and the valid Units key. Press the other Function key, the desired Data keys, and the valid Units key. Press the other Source key, the appropriate Function key, the desired Data keys, and the valid Units key.

Example 3

Simultaneously select AM with a depth of 90% and FM with a peak deviation of 25 kHz using the internal 400 Hz source, and AM with a depth of 90% using an external 6 kHz modulation source.

	SOURCE	FUNCTION	DATA	UNITS
LOCAL (keys)	INT 400 Hz	AM	9 0	%
		FM	2 5	kHz
	EXT	AM		
HP-IB (program codes)	S2 AM 90 PC or % FM 25 KZ S1 AM			

Keystroke Sequence 4

To select four simultaneous modulation signals, press the appropriate Source key, a Function key, the desired Data keys, and the valid Units key. Press the other Function key, the desired Data keys and valid Units key. Press the other Source key, and then both Function keys.

Example 4

Simultaneously select AM with a depth of 10% and FM with a peak deviation of 50 kHz using the internal 1 kHz modulation source. AM and FM with the same depth and deviation as selected previously are also selected using an external 5 kHz source.

	SOURCE	FUNCTION	DATA	UNITS
LOCAL (keys)	INT 1 kHz	AM	1 0	%
		FM	5 0	KHZ
	EXT	AM		
	EXT	FM		
 (program codes)	S3 AM 10 PC or % FM 50 KZ S1 AM S1 FM			

Keys and Program Codes

Keys	Codes
AM	AM
FM	FM
EXT	S1
INT 400 Hz	S2
INT 1 kHz	S3
DC FM	S5
PULSE	PM

Indications

The last selected AM depth or FM peak deviation is displayed in the MODULATION Display, and the source annunciators will light. In the case where an external modulation source is used, the HI EXT and LO EXT annunciators will also light until the signal level of the external source is adjusted to 1 Vpk (0.707 Vrms) ±5%.

Comments

FM and AM are not available in the $\pi/4$ DQPSK modulation mode.

Digits selected beyond the specified resolution for AM depth or FM peak deviation are truncated.

Leading zeros are blanked.

AM depth Data entries that would cause the peak envelope power of the HP 8657D to exceed +17 dBm are rejected.

FM peak deviation Data entries that are out-of-range for the selected carrier frequency are rejected.

If you select a carrier frequency that makes the currently selected FM Peak Deviation outside the HP 8657D operating limits, then the MODULATION Display flashes. To clear this error condition enter a new carrier frequency in the correct band for the selected Peak Deviation. To automatically select the maximum permitted Peak Deviation for the carrier frequency, press the FM, FM \uparrow or FM \downarrow key.

Carrier Frequency (MHz)	Maximum Peak Deviation	
	AC Mode	DC Mode
	(the lesser of)	
0.1 to 130	200 kHz or $4000 \times \text{rate (Hz)}$	200 kHz
130 to 260	50 kHz or $1000 \times \text{rate (Hz)}$	50kHz
260 to 520	100 kHz or $2000 \times \text{rate (Hz)}$	100 kHz
520 to 1040	200 kHz or $4000 \times \text{rate (Hz)}$	200 kHz

The AM or FM function remains selected until:

- a. One of the three remaining functions is selected.
- b. One of the SAVE, RECALL, SEQUENCE keys or Display (SHIFT, DSPL) is pressed.
- c. The HP 8657D is preset, unplugged, or switched to standby.

Setting the level of the external modulation source is described under Modulation, External Source.

Related Instructions

- Modulation, AM
- Modulation, DC FM
- Modulation, External Source
- Modulation, FM
- Modulation, OFF
- Modulation, Pulse

Modulation, Off

Description

This instruction details how to selectively turn off Modulation functions and sources.

Keystroke Sequences

To turn off a modulation function (AM or FM), press the Function key, then the OFF key.

To turn off a modulation source (internal 400 Hz, internal 1 kHz, or external), press the associated Function key, Source key, then the OFF key.

To turn off Pulse Modulation, when only Pulse Modulation is selected, press the OFF key. To turn off Pulse Modulation, when Pulse Modulation is selected with AM or FM, press the PULSE then the OFF key.

Examples

Selectively turn off AM modulation function with only one in use.

	FUNCTION	SOURCE
LOCAL (keys)	AM	OFF
HP-IB (program codes)	AM S4	

Selectively turn off internal 400 Hz source.

	FUNCTION	SOURCE
LOCAL (keys)	AM	INT 400 Hz OFF
HP-IB (program codes)	AM S2 S4	

Keys and Program Codes

Keys	Codes
AM	AM
FM	FM
EXT	S1
INT 400 Hz	S2
INT 1 kHz	S3
OFF	S4
DC FM	S5
PULSE	PM

Indications

The current MODULATION display is blanked or the modulation source (including its annunciator) is turned off when the OFF key is pressed.

Comments

The currently selected modulation function (AM or FM) is turned off when the OFF key is pressed, provided only one source (internal 400 Hz or 1 kHz, or external) is selected for use.

If more than one source is selected, then a Source key (INT 400 Hz, INT 1 kHz, or EXT) has to be pressed before the OFF key is pressed. In this case, the currently selected modulation function remains selected, and only the chosen source (including its annunciator) is turned off.

If both modulation functions are simultaneously selected and share the same source, then; only the currently selected modulation function is turned off when the OFF key is pressed, and the MODULATION Display is restored to show the modulation parameters of the remaining function.

Related Instructions

- Modulation, AM
- Modulation, AM Up/Down
- Modulation, DC FM
- Modulation, DC FM Up/Down
- Modulation, FM
- Modulation, FM Up/Down
- Modulation, External Source
- Modulation, Mixed
- Modulation, Pulse

Modulation, Pulse

Description

This instruction details how to select Pulse Modulation.

Operating Characteristics

On/Off Ratio: > 70 dB (0.1 to 1040 MHz)

> 50 dB ($\pi/4$ DQPSK frequency band: 1420 to 1540 MHz)

Rise/Fall Time: < 35 ns, for analog and $\pi/4$ DQPSK frequency bands.

Duty Cycle: 0 - 100%

Nominal Input Threshold: 1.6 V

CAUTION

Maximum allowable input level is ± 15 Vdc. Exceeding this limit may cause damage to the HP 8657D.

Keystroke Sequence

Press the SHIFT key then the AM function key. Connect the external modulation source to the PULSE INPUT. When the pulse waveform from the external source goes high, the pulse output from the HP 8657D turns on. Vary the external pulse rate, amplitude and width to simulate the pulse modulated signal you require.

Keys and Program Codes

Keys	Codes
PULSE	PM

Indications

The PULSE annunciator lights.

Comments

The Pulse Input Impedance can be selected for 50 ohms or high impedance. The factory setting is high impedance. If you want to select 50 ohms, refer to paragraph 2-15.

Pulse Modulation is available in analog or $\pi/4$ DQPSK modulation modes.

Related Instructions

Modulation, AM
 Modulation, AM Up/Down
 Modulation, External Source
 Modulation, Mixed
 Modulation, Off
 Modulation, $\pi/4$ DQPSK

Modulation, $\pi/4$ DQPSK

Description

This instruction details how to select $\pi/4$ DQPSK (Differential Quadrature Phase Shift Keying) Modulation.

Operating Characteristics:

Modulation Data Clock Frequency Range	
Clock	Range
Symbol	20 kHz to 25kHz
Bit	40 kHz to 50kHz

Error Vector Magnitude (15°C to 35°C)		
Frequency Band (MHz)	Maximum Value	
	Output Level (dBm)	Error (%)
10 to 129.9	+3	4
810 to 965	+7	3.5
1420 to 1540	+3	4

Filter Shape Factor: $\alpha = 0.35$ or $\alpha = 0.50$ (Selectable from the front panel)

Inputs: Serial data and clock (bit or symbol).

I/Q Origin Offset (15°C to 35°C): ≤ -35 dBm, RF Output only.

Input Levels: Nominally TTL.

Polarity: Inverted and Non-inverted Modulation (Selectable from the front panel – see table below)

$\pi/4$ DQPSK Modulation Polarity		
FREQUENCY BAND	Modulation	
	NON-INVERTED	INVERTED
10 TO 129.9 MHz	POLARITY switch - NORM	POLARITY switch - INV
810 to 965 MHz	POLARITY switch- NORM	POLARITY switch - INV
1420 to 1540 MHz	POLARITY switch - INV	POLARITY switch- NORM

Front Panel Inputs

Connect the external symbol clock to the CLOCK input and serial data to the DATA input.

Keystroke Sequence

Press the SHIFT key, then the EXT ($\pi/4$ DQPSK) key.

Keys and Program Codes

Keys	Codes
$\pi/4$ DQPSK	P4 (Turns ON)
$\pi/4$ DQPSK	P0 (Turns OFF)

Indications

The modulation display reads "Pi 4".

Comments

When operating in the $\pi/4$ DQPSK modulation mode, AM, FM and DCFM are not available.

The Clock and Data Input Impedance is nominally 1 k Ω .

The front panel I and Q outputs are baseband $\pi/4$ DQPSK.

I and Q signals typically are 0.35 volts into a 50 Ω load.

Rear-panel Connectors:

SYMBOL CLK OUTPUT (nominally TTL)

N \times SYMBOL OUTPUT (nominally TTL): N is selected by the Premod Filter Control Switch

128 \times SYM CLK (nominally TTL)

SAMPLING CLOCK OUT (nominally TTL): N \times SYMBOL OUTPUT, low for 100 ns to 250 ns per cycle.

BUFFER IN: 0.1 to 0.3 volts, 10 to 230 kHz

BUFFER OUT: 1.0 to 3.0 volts into 50 Ω , 10 to 230 kHz

The $\pi/4$ DQPSK modulation mode is limited to the following three frequency bands:

10 to 129.9 MHz

810 to 965 MHz

1420 to 1540 MHz

Generator frequency defaults to 860 MHz under two conditions:

1. The operating frequency is not within 10 to 129.9 MHz or 810 to 965 MHz when the $\pi/4$ DQPSK modulation mode is selected.
2. Operating in the $\pi/4$ DQPSK modulation mode at a frequency within 1420 to 1540 MHz and turning $\pi/4$ DQPSK modulation mode off.

Related Instructions

Modulation, Pulse

Recall

Description

This instruction details how to recall a saved front-panel set-up.

Keystroke Sequence

Press the RECALL key, and then use the Data keys to recall the set-up you want.

Example

Recall the front-panel set-up saved in memory location 02.

LOCAL (keys)	RECALL	0	2
HP-IB (program codes)	RC 02		

Keys and Program Codes

Keys	Codes
RECALL	RL

Indications

The front-panel set-up saved in memory location 02 is recalled and the HP 8657D output is changed to the new set-up.

Comments

You can save up to 100 (00-99) complete front-panel set-ups (exclusive of increment settings).

NOTE

If the Non-Volatile memory battery needs replaced (frequency displays shows CLEARING at power on), then you cannot use the recall feature. For information about replacing the battery, refer to Section 2.

To clear all your front-panel set-ups from memory, press and hold the ⇐ key at switch on. The FREQUENCY display will show CLEARING to confirm that the memory is being cleared.

Related Instructions

- Display
- Save
- Sequence

RF ON/OFF

Description

This instruction details how to turn OFF and ON the carrier frequency at the RF OUTPUT of the HP 8657D.

Keystroke Sequence

Press the RF ON/OFF key.

Keys and Program Codes

Keys	Codes
RF OFF	R2
RF ON	R3
SHIFT RF OFF	R5

Indications

The AMPLITUDE Display, and Amplitude annunciators are blanked when RF ON/OFF is off. Pressing RF ON/OFF again turns on the RF and restores the AMPLITUDE Display and annunciators.

Comments

The RF ON/OFF key turns off the carrier frequency to the output without affecting the attenuators.

If your application includes measuring equipment sensitive to noise (i.e receivers), pressing the SHIFT key and then the RF ON/OFF key will reduce spurious noise by switching in all the attenuator pads.

Performing this feature does not affect the current set-up.

Related Instructions

None

Save

Description

This instruction details how to save complete front-panel set-ups (exclusive of increment settings) in Non-Volatile Memory.

Keystroke Sequence

Press the SAVE key, then two Data keys sequentially to identify the memory location of the set-up.

Example

Save the current front-panel set-up in memory location 02.

LOCAL (keys)	SAVE	0	2
HP IB (program codes)	SV 02		

Keys and Program Codes

Keys	Code
Save	SV

Indications

The current instrument state will be saved in register XX (register 02 in the above example). The display will also flash after the second numeric value is entered. The sequence pointer associated with register XX will default to XX+1 (register 03 in the above example).

Comments

You can save up to 100 (00-99) front-panel set-ups.

NOTE

If the Non-Volatile memory battery needs to be replaced (frequency displays shows CLEARING at power on), then you cannot use the recall feature. For information about replacing the battery, refer to Section 2.

To clear all your front-panel set-ups from memory, press and hold the ← key at switch on. The FREQUENCY display will show CLEARING to confirm that the memory is being cleared.

Related Instructions

Display
Recall
Sequence

Sequence

Description

This instruction details how to recall a sequence of saved front-panel set-ups.

Keystroke Sequence

Use the SAVE and DATA keys to save the set-ups you want. Press the RECALL and DATA keys to recall the set-up you want the sequence to start at. Press the SEQ key to recall the next set-up.

Keys and Program Codes

Keys	Codes
SEQ	SQ
Flexible ¹	GT
Reverse ¹	QS
(1) See comments.	

Indications

Each time you press the SEQ key, the next front-panel set-up is recalled and the HP 8657D is changed to the new set-up.

Comments

You can save up to 100 (00-99) complete front-panel setups (exclusive of increment settings).

NOTE

If the Non-Volatile memory battery needs to be replaced (frequency displays show CLEARING at power on), then you cannot use the recall feature. For information about replacing the battery, refer to Section 2.

To clear all your front-panel set-ups from memory, press and hold the ⇐ key at switch on. The FREQUENCY display will show CLEARING to confirm that the memory is being cleared. This will set all memory location pointers to their default locations (i.e location 00 will point to location 01).

Sequencing

The default operation of the sequence function is to recall the next storage register in the order 00 \Rightarrow 01 \Rightarrow 02 \Rightarrow 98 \Rightarrow 99 \Rightarrow 00 \Rightarrow 01 and so on. However, the Signal Generator is capable of stepping through a set of storage locations and returning to a predetermined starting location defined by the user, hence creating a loop within the Signal Generator's 100 storage registers. For example, to create a sequence of 00 \Rightarrow 01 \Rightarrow 02 \Rightarrow 03 \Rightarrow 00.

1. Set the Signal Generator to the desired state. Save this state in storage location 00. Press SAVE 00.
2. Set the Signal Generator to the next desired state you want and save this in storage location 01. Press SAVE 01.
3. Repeat steps 1 and 2 until all other desired states are saved.
4. To create the sequence, press SHIFT, SAVE 0300. Storage location 03 will now be pointing back to storage location 00. To check that this is so, follow the instructions under DISPLAY SEQUENCE in this section, and verify that the front panel displays 03...00.
5. Press RECALL 00 to retrieve your initial state. Each time the SEQ key is pressed, the next storage location will be recalled. When the Signal Generator reaches storage location 03, the next SEQ key pressed will recall storage location 00.
6. To reverse the sequence, press SHIFT, SEQ and RECALL. When the Signal Generator reaches storage location 00, the next keystroke sequence will recall storage location 03. Repeatedly keying SHIFT, SEQ, RECALL will result in the sequence 03 \Rightarrow 02 \Rightarrow 01 \Rightarrow 00 \Rightarrow 03 being carried out.

There can be a conflict when reverse sequencing if more than one register is pointing to the current sequence register. For example, if the current sequence register is 05 and registers 10 and 15 both point to 05, a reverse sequence operation could go to either register 10 or 15. When this conflict arises, the register which is recalled is the first one found by searching forward in the sequence table. In this case, register 10 would be recalled.

Both the forward and reverse sequencing can be controlled via the HP-IB codes shown. Code GT is used in place of the keyboard operation, SHIFT, SAVE, in order to modify the sequence pointer over the HP-IB. For example, SHIFT, SAVE 0304 from the keyboard would be replaced by GT 0304 over the HP-IB. To sequence forward using the HP-IB, use code SQ and to sequence in reverse, use code QS.

Related Instructions

Display
Display Sequence
Recall
Store

3-10. USER CONFIDENCE TESTS

The User Confidence Tests provide procedures to allow you to check that the HP 8657D is operating correctly. Two sets of tests are provided; Basic Functional Checks and HP-IB Functional Checks

3-11. BASIC FUNCTIONAL CHECKS

Description

This procedure requires a frequency counter, a spectrum analyzer, a power supply, and the interconnecting cables and adapters. It provides assurance that most of the front-panel controlled functions are being executed by the HP 8657D.

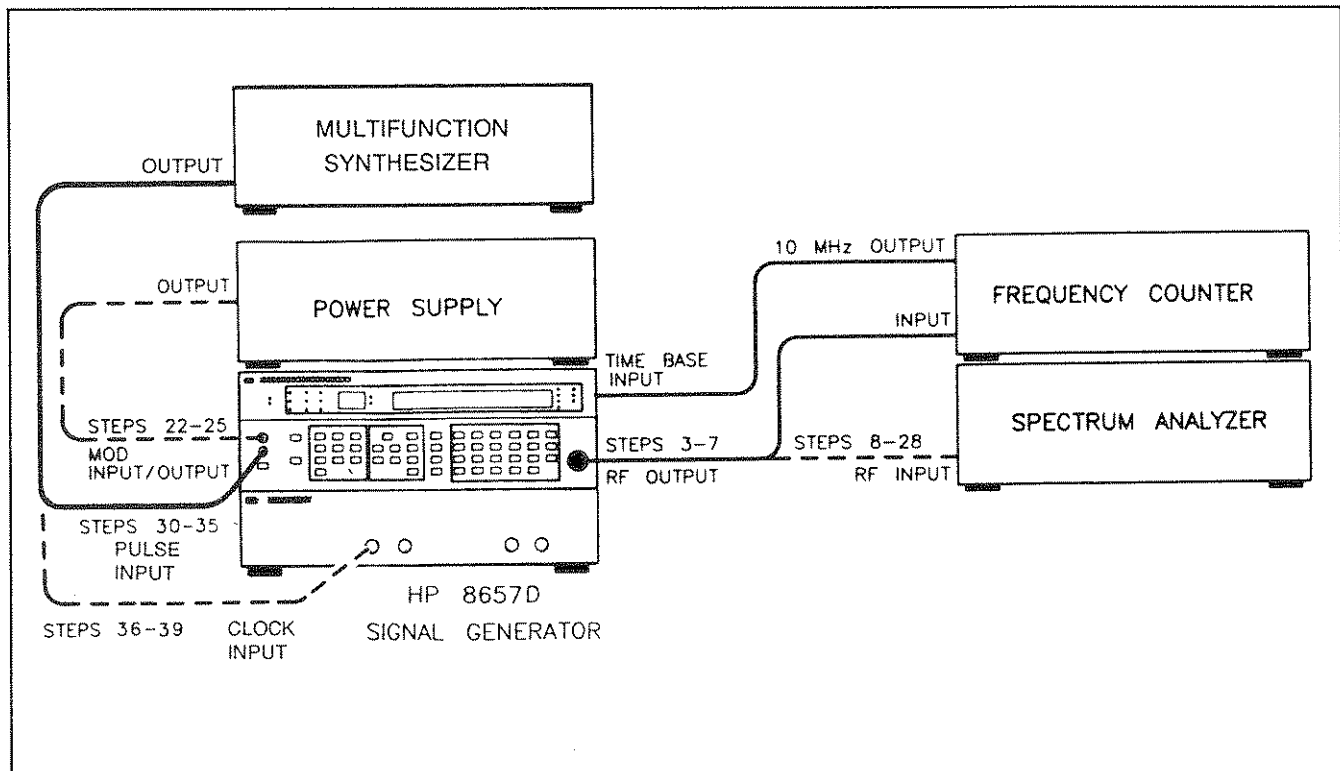

Figure 3-8. Test Setup for Basic Functional Checks

Equipment

Frequency Counter	HP 5328A Option 031
Spectrum Analyzer	HP 8668B/182T
Power Supply	HP 6235A

Procedure

1. Ensure that the power cable is plugged into a suitable source of Mains power (refer to paragraph 2-4).
2. Turn on the HP 8657D by pressing the POWER key. The HP 8657D automatically performs a self-test check at power on (this takes approximately 6 seconds). During this time all front panel indicators and displays will light.

When the self-test is complete, the HP 8657D is set to the same conditions as when it was turned off.

NOTE

If the HP 8657D is turned off with RF ON/OFF set to OFF, then it will power-on with RF set to ON.

If any of the self-tests fail at power-on, an error code is displayed in the FREQUENCY window (see paragraph 3-5). The error code remains displayed until any front panel key is pressed.

3. Connect the RF OUTPUT of the HP 8657D to the input of the frequency counter, and the 10 MHz reference output from the frequency counter to the TIME BASE INPUT located at the rear of the HP 8657D as shown in Figure 3-8. The two instruments are now locked to the same time base.

NOTE

If the HP 8657D is equipped with the high stability time base (Option 001), disconnect its cable from the TIME BASE INPUT before performing this step.

Frequency Check

4. Set the output amplitude of the HP 8657D to -10.0 dBm and the carrier frequency to the values listed in the following table:

Carrier Frequency (MHz)
100.000000
140.000000
200.000000
300.000000
400.000000
600.000000
800.000000
990.000000
1040.000000

Verify that the FREQUENCY Display on the HP 8657D agrees with the frequency displayed on the frequency counter (except for the resolution of the frequency counter being used).

5. Set the carrier frequency of the HP 8657D to 111.111111 MHz and the frequency increment value to 111.111111 MHz. Leave the output amplitude set at -10.0 dBm.

Verify that the FREQUENCY display on the HP 8657D agrees with the frequency displayed on the frequency counter.

6. Quickly press and release the frequency step-up key to increase the carrier frequency.

Verify that the FREQUENCY Display on the HP 8657D agrees with the frequency displayed on the frequency counter.

Continue to increase the carrier frequency to the maximum value listed in the following table:

Carrier Frequency (MHz)
111.111111
222.222222
333.333333
444.444444
555.555555
666.666666
777.777777
888.888888
999.999999

Verify that the FREQUENCY Display on the HP 8657D agrees with the frequency displayed on the frequency counter each time the carrier frequency is increased.

7. Quickly press and release the frequency step-down key to decrease the carrier frequency.

Verify that the FREQUENCY Display on the HP 8657D agrees with the frequency displayed on the frequency counter.

Continue to decrease the carrier frequency to the minimum value listed in the previous table.

Verify that the FREQUENCY Display on the HP 8657D agrees with the frequency displayed on the frequency counter each time the carrier frequency is decreased.

Output Level Checks

8. Connect the RF OUTPUT of the HP 8657D to the input of the spectrum analyzer as shown in Figure 3-8.
9. Set the output amplitude of the HP 8657D to 0.0 dBm, carrier frequency to 0.1 MHz, and frequency increment value to 10 MHz.
10. Set the spectrum analyzer frequency to 0.1 MHz, Marker ON, amplitude to 1 dB/division, and make the necessary adjustments to properly display the output signal from the HP 8657D.
11. Slowly increase the carrier frequency through its entire calibrated frequency range (0.1 to 1040 MHz) and observe the level displayed on the spectrum analyzer. The level should not vary more than a total of 4 dBm (± 2.0 dB from 0.0 dBm).
12. Set the carrier frequency of the HP 8657D to 600 MHz, output amplitude to +13 dBm, and output amplitude increment value to 1.0 dB.
13. Adjust the spectrum analyzer as necessary to display the output signal from the HP 8657D. The displayed carrier should be positioned in the center of the graticule with its maximum level positioned near the top of the graticule.
14. Slowly decrease the output amplitude down to -4.0 dBm and observe the level displayed on the spectrum analyzer. The level should decrease in relatively uniform 1 dB steps.
15. Set the output amplitude of the HP 8657D to -10.0 dBm and the output amplitude increment value to 5 dB. Leave the carrier frequency set to 600 MHz.
16. Set the spectrum analyzer amplitude to -10 dBm, span to 50 kHz, amplitude 10 dB/division, and make the necessary adjustments to properly display the output signal from the HP 8657D. The displayed carrier should be positioned in the center of the graticule with its maximum level positioned near the top of the graticule.
17. Slowly decrease the output amplitude down to -80 dBm and observe the level displayed on the spectrum analyzer. The level should decrease in relatively uniform 5 dB steps.

FM Check

18. Set the output amplitude of the HP 8657D to 0.0 dBm. Leave the carrier frequency set to 600 MHz. Select FM with a peak deviation of 200 kHz using the internal 1 kHz source. Set the FM peak deviation increment value to 10 kHz.
19. Set the spectrum analyzer span for 500 kHz, and a reference level of 0 dBm. The waveform displayed should be similar to that shown in Figure 3-9.

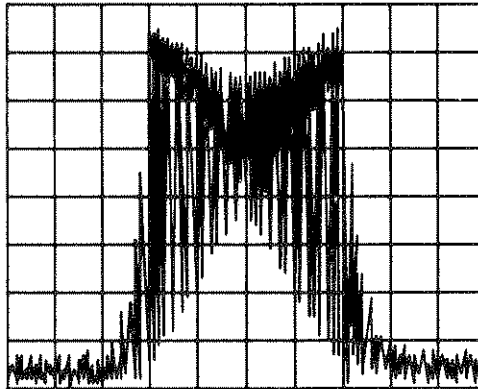

Figure 3-9. FM Functional Check Waveform

20. Slowly decrease the FM peak deviation to zero. The deviation displayed on the spectrum analyzer should decrease in relatively uniform steps.
21. Press FM, then OFF to turn off the FM function.

DC FM Check

22. Leave the output amplitude of the HP 8657D set to 0.0 dBm, and the carrier frequency set to 600 MHz. Select external DC FM with a peak deviation of 60 kHz.
23. Set the spectrum analyzer for a 200 kHz frequency span/division and a reference level of 0 dBm. Adjust the spectrum analyzer as necessary to display the output signal from the HP 8657D in the center of the display.
24. Connect a power supply to the MODulation INPUT/OUTPUT Connector of the HP 8657D as shown in Figure 3-8. Set the power supply for a +1 Vdc output and switch the voltage line on. Notice the LO EXT annunciator will remain on. The carrier frequency displayed on the Spectrum Analyzer should move three divisions to the right. The carrier frequency is offset by 60 kHz.
25. Press FM, then OFF to turn off the DC FM function.

AM Check

26. Leave the carrier frequency set to 600 MHz, and the output amplitude set to 0.0 dBm. Select AM with a depth of 50% using the internal 400 Hz source.
27. Set the spectrum analyzer span for 4 kHz.
28. The spectrum analyzer should display a signal of 600 MHz with 400 Hz side bands.
29. Press AM, then OFF to turn off the DC FM function.

Pulse Check

30. Set the carrier frequency to 900 MHz, and amplitude to 0.0 dBm. Select Pulse Modulation.
31. Set the multifunction synthesizer to 24.3 kHz, 3.0 volts, sinewave.
32. Set the spectrum analyzer frequency to 900 MHz, amplitude to 0.0 dBm, and span to 50 kHz.
33. Connect the multifunction synthesizer to the HP 8657D PULSE INPUT, as shown in Figure 3-8.
34. The spectrum analyzer should display a signal of 900 MHz with two side bands offset by 24.3 kHz.
35. Press SHIFT key, AM (PULSE) key, then the OFF key to turn pulse modulation off.

$\pi/4$ DQPSK Check

36. Connect the multifunction synthesizer to the HP 8657D CLOCK INPUT. The ACTIVE indicator will light.
37. Press SHIFT key, then EXT ($\pi/4$ DQPSK), to select $\pi/4$ DQPSK modulation.
38. The frequency is offset by ≈ 9 kHz with side bands.
39. Press SHIFT, then EXT ($\pi/4$ DQPSK), to turn $\pi/4$ DQPSK modulation off.

I and Q OUTPUT Check

40. I and Q front-panel OUTPUTS can be checked with an oscilloscope. Connect the I and Q outputs to separate channels of an oscilloscope that has the capability to display two channels in X/Y mode.
41. Set the oscilloscope to X/Y mode and adjust the VOLTS/DIV scale on both channels to display the waveform shown in figure 3-10.

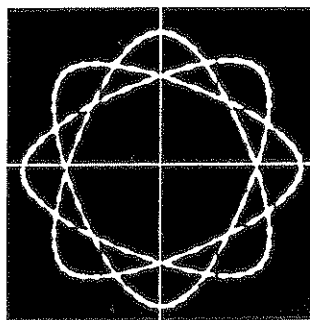

Figure 3-10

42. Connect a 50Ω termination to the data input. This will produce a TTL 0. The oscilloscope display should resemble figure 3-11.

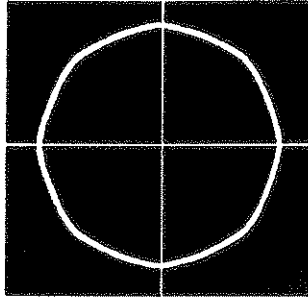

Figure 3-11

3-12. HP-IB FUNCTIONAL CHECKS

Description

The following procedures check the HP 8657D's ability to recognize its own HP-IB (listen) address, properly make remote/local transitions, and process all the applicable HP-IB messages described in Table 3-7. During the process, all of the HP 8657D HP-IB data input/output bus, control, and handshake lines are checked, except for DIO8 (the most significant data input/output bus line which is not used by the HP 8657D). Only the HP 8657D, a bus controller, and an HP-IB interface with appropriate cabling are required to perform these procedures. The checks are intended to be as independent of one another as possible, since each begins with the HP 8657D being reset to its initialized condition. Nevertheless, it is suggested that the first four checks be performed in order before any other check. Any special initialization steps or requirements for a given check are provided at the beginning of the check.

The validity of these checks is based on the following assumptions:

- The HP 8657D performs properly when operated via the front-panel keys (that is, in local operation). This can be verified by performing the basic functional checks as outlined in paragraph 3-11.
- The bus controller properly executes HP-IB operations.
- The bus controller's HP-IB interface properly transfers the controller's instructions.
- The select code of the bus controller's interface is set to 7.
- The HP-IB address of the HP 8657D is set to 07 (the factory-set address).
- The select code address combination (that is, 707) is not necessary for these checks to be valid, however, the program lines presented in the following procedures would have to be modified for any other combination.

If the HP 8657D appears to fail any of the remote functional checks, the validity of the preceding assumptions should be confirmed before attempting to service the HP 8657D.

If all of these checks are performed successfully, the HP 8657D HP-IB capability can be considered to be operating properly. These procedures do not check whether or not all of the HP 8657D program codes are being properly interpreted and executed by the HP 8657D, however, if the front-panel operation is confirmed to be working properly and its HP-IB capability operates correctly, then there is a high probability that the HP 8657D will respond properly to all of its program codes.

Initial Setup

The test setup is the same for all of the checks. That is, the HP 8657D is connected to the bus controller through the bus controller's HP-IB interface via the appropriate cable.

Equipment

Use any HP Controller and HP-IB Interface to implement HP-IB functional checks.

Procedure

Address Recognition

This check determines whether or not the HP 8657D recognizes when it is being addressed and when it is not. It is assumed that the HP 8657D is in local operation and that it can properly handshake on the bus. Before beginning this check, verify that the HP 8657D is in local operation and unaddressed by the controller.

Description	BASIC
Set the Remote Enable (REN) bus control line false. Send the listen address to the HP 8657D.	LOCAL 7 OUTPUT 707

1. Verify that the HP 8657D RMT annunciator remains off, and that its ADRS annunciator lights.

Description	BASIC
Unaddress the HP 8657D by sending a different address.	OUTPUT 715

2. Verify that the HP 8657D RMT and ADRS annunciators are both off.

Remote and Local Messages and the LOCAL Key

This check determines whether the HP 8657D properly switches from local to remote operation, switches from remote to local operation, and whether the LOCAL key can return the HP 8657D to local operation. It is assumed that the HP 8657D is able to both handshake and recognize its own address. Before beginning this check verify that the HP 8657D is in local operation and unaddressed by the controller.

Description	BASIC
Send the Remote message which sets the Remote Enable (REN) bus control line true and addresses the HP 8657D to listen.	REMOTE 707

1. Verify that the HP 8657D RMT and ADRS annunciators both light.

Description	BASIC
Send the Local message to the HP 8657D.	LOCAL 707

2. Verify that the HP 8657D RMT annunciator turns off, and that its ADRS annunciator remains on.

Description	BASIC
Send the Local message to the HP 8657D.	REMOTE 707

3. Verify that the HP 8657D RMT and ADRS annunciators are both on. Press the LOCAL key on the front-panel of the HP 8657D and verify that the RMT annunciator turns off, and that the ADRS annunciator remains on.

Data Message

This check determines whether or not the HP 8657D properly receives Data messages. Because the HP 8657D is only a listener, it can only receive Data messages, but never send them. It is assumed that the HP 8657D is able to handshake, recognize its own address, and properly make remote/local transitions. The Data message that is sent will cause the 7 least significant HP-IB data lines to be placed in both their true and false states. Before beginning this check, verify that the HP 8657D is in local operation and unaddressed by the controller.

Description	BASIC
Send first part of the Remote message (enables the HP 8657D remote operating mode).	REMOTE 707
Address the HP 8657D to listen (which completes the Remote message) and send the Data message (which tunes the HP 8657D to 1040 MHz).	OUTPUT 707; "FR1040MZ"

1. Verify that the HP 8657D RMT and ADRS annunciators both light, and that the FREQUENCY Display shows a carrier frequency of 1040.0000 MHz.

Local Lockout and Clear Lockout/Set Local Messages

This check determines whether or not the HP 8657D properly receives the Local Lockout message which disables all of the front-panel keys. In addition, this check determines whether or not the Clear Lockout/Set Local message is properly received and executed by the HP 8657D. It is assumed that the HP 8657D is able to handshake, recognize its own address, and properly make remote/local transitions. Before beginning this check, verify that the HP 8657D is in local operation and unaddressed by the controller.

Description	BASIC
Send first part of the Remote message (enables the HP 8657D remote operating mode).	REMOTE 707
Send the Local Lockout message.	LOCAL LOCKOUT 7
Address the HP 8657D to listen (completes the Remote message).	OUTPUT 707

1. Verify that the HP 8657D RMT and ADRS annunciators both light. Press the LOCAL key on the front-panel of the HP 8657D, and verify that its RMT and ADRS annunciators both remain on.

Description	BASIC
Send the Clear Lockout/Set Local Message.	LOCAL 7

2. Verify that the HP 8657D RMT annunciator is turned off, and that its ADRS annunciator remains on.

Clear Message

This check determines whether or not the HP 8657D properly responds to the Clear message. It is assumed that the HP 8657D is able to handshake, recognize its own address, properly make remote/local transitions, and receive Data messages. Before beginning this check, verify that the HP 8657D is in local operation, and unaddressed by the controller.

Description	BASIC
Send first part of the Remote message (enables the HP 8657D remote operating mode).	REMOTE 707
Address the HP 8657D to listen (which completes the Remote message) and send the Data message (which sets the output amplitude of the HP 8657D to 3.0 dB mV).	OUTPUT 707; "APD3DBMV"

1. Verify that the HP 8657D RMT, ADRS, dB, and mV annunciators all light, and that the AMPLITUDE Display shows an output amplitude of 3.0 dBmV.

Description	BASIC
Send the Clear message.	CLEAR 707

2. Verify that the HP 8657D RMT and ADRS annunciators remain on, and that a frequency of 100 MHz and amplitude of -143.5 dBm is displayed. The dB and mV annunciators will now be off and the dBm annunciator will be on.

Abort Message

This check determines whether or not the HP 8657D becomes unaddressed when it receives the Abort message. It is assumed that the HP 8657D is able to handshake, recognize its own address, and properly make remote/local transitions. Before beginning this check, verify that the HP 8657D is in local operation and unaddressed by the controller.

Description	BASIC
Send the complete Remote message.	REMOTE 707

1. Verify that the HP 8657D RMT and ADRS annunciators both light.

Description	BASIC
Send the Abort message (which unaddresses the HP 8657D to listen.)	ABORTIO 7

2. Verify that the ADRS and RMT annunciators turn off.

Section 4

PERFORMANCE TESTS

4-1. INTRODUCTION

The procedures in this section test the HP 8657D electrical performance using the specifications of Table 1-1 as the performance standards. All tests can be performed without access to the interior of the instrument. A simpler operational test is included in Section 3 under User Confidence Tests.

NOTE

If the performance tests are to be considered valid, the following conditions must be met:

- a. The HP 8657D must have a 30-minute warmup.*
- b. Refer to paragraph 2-6 for line voltage selection.*
- c. The ambient temperature must be 0° C to 55° C for the Level Accuracy and Flatness Test.*
- c. The ambient temperature must be 15° C to 35° C for the Error Vector Magnitude and I/Q Origin Offset tests.*

4-2. EQUIPMENT REQUIRED

Equipment required for the performance tests is listed in Table 1-2, Recommended Test Equipment. Any equipment that satisfies the critical specifications given in the table may be substituted for the recommended model(s).

4-3. PERFORMANCE TEST RECORD

You can record the results of the performance tests in the Performance Test Record, located at the end of this section. The Test Record lists all of the tested specifications and their acceptable limits. The results recorded at incoming inspection can be used for comparison in periodic maintenance and troubleshooting and after repairs or adjustments.

4-4. CALIBRATION CYCLE

The HP 8657D requires periodic verification of performance. Depending on the use and environmental conditions, the HP 8657D should be checked using the following performance tests at least once each year.

4-5. ABBREVIATED PERFORMANCE TESTING

In most cases, it is not necessary to perform all of the tests in this section. Table 4-1 shows which tests are recommended for various situations. The User Confidence Tests in Section 3 should be the first step in all testing situations.

4-6. TEST PROCEDURES

It is assumed that if you are performing the following tests, that you know how to operate the specified test equipment. Equipment settings, other than those for the HP 8657D, are stated in general terms. For example, a test might require that a spectrum analyzer's resolution bandwidth be set to 100 Hz; however, the time per division setting would not be specified and you would set that control so that the analyzer operates correctly.

It is also assumed that you will supply whatever cables, connectors, and adapters are necessary.

Table 4-1. Abbreviated Performance Tests

Testing Situations		Section 3 Confidence Tests		Performance Test Number and Name			
		Basic	HP-IB	1	2	3	4
				Spectral Purity	Output Level Accuracy And Flatness	Modulation	Output Leakage
Incoming Inspection or Overall Performance Verification		X	X	X	X	X	X
After Complete Adjustment		X		X	X	X	X
After Repairs to Assembly:	Reference Service Sheet No.						
A1	21	X					
A2	21-23	X					
A3A1	9	X		X		FM	
A3	9	X					
A3	10	X		X		FM	
A3	11	X		X			
A3	12	X		X			
A3	13	X		X		FM	
A3	14	X		X		FM	
A3	15	X		X		FM	
A3	16	X		X			
A4	1	X		X			
A4	2	X		X			
A6	4	X		X	X	AM	
A6	5	X		X	X		
A8	3	X		X			
A10	8	X		X	X	PULSE	
A11	6-7	X				AM/FM	
A12		X		X	X	X	
A13	17-20	X	X		X	X	
A15	24	X					
A16	16	X					
A17						DIGITAL	
A18						DIGITAL	
FL1	3	X		X			

Performance Test 1

SPECTRAL PURITY TESTS

- Spurious Signals
- Residual AM
- Residual FM
- SSB Phase Noise (1 Hz Bandwidth)

Specifications

Electrical Characteristics	Performance Limits	Conditions
Spurious Signals:		
Harmonics	< -30 dBc	≤ +7 dBm output levels 0.1 to 1040 MHz
Non-harmonics		> 5 kHz to 2 MHz from carrier in CW mode
	< -63 dBc	0.1 to 130 MHz
	< -75 dBc	130 to 260 MHz
	< -66 dBc	260 to 520 MHz
	< -63 dBc	520 to 1040 MHz
	< -60 dBc	≥ 2 MHz from carrier in CW mode
Sub-harmonics	None	0.1 to 1040 MHz
Residual Modulation CW Mode:		
AM	< 0.04%	0.1 to 1040 MHz
(0.5 to 15 kHz Post Detection Noise Bandwidth)		
FM	< 4 Hz rms	0.1 to 130 MHz
(0.3 to 3 kHz Post Detection Noise Bandwidth)	< 1 Hz rms	130 to 260 MHz
	< 2 Hz rms	260 to 520 MHz
	< 3 Hz rms	520 to 1040 MHz
FM	< 6 Hz rms	0.1 to 130 MHz
(0.05 to 15 kHz Post Detection Noise Bandwidth)	< 1.5 Hz rms	130 to 260 MHz
	< 3 Hz rms	260 to 520 MHz
	< 4 Hz rms	520 to 1040 MHz
SSB Phase Noise		20 kHz offset from carrier
	< -124 dBc/Hz	0.1 to 130 MHz
	< -136 dBc/Hz	130 to 260 MHz
	< -130 dBc/Hz	260 to 520 MHz
	< -124 dBc/Hz	520 to 1040 MHz

Description

Spurious signals are checked using a spectrum analyzer. Residual AM and FM Modulation are checked using a measuring receiver. SSB phase noise is measured to 1040 MHz using a phase noise measurement system.

NOTE

Spectral purity specifications are typical for $\pi/4$ DQPSK Modulation Mode.

Equipment

- Spectrum Analyzer HP 8562A or HP 8555A/8552B/141T (Harmonics/Spurious Tests)
- Measuring Receiver..... HP 8902A (Option 003 for Optional Residual FM Tests)
- Sensor Module..... HP 11722A
- Digital Multimeter..... HP 3466A
- AM/FM Test Source..... HP 11715A
- Cable (UG-21D/U type N connectors) HP 11500B
- Cable (UG-88C/U BNC and dual banana plug connectors)HP 11001-60001
- Synthesized Signal Generator/(LO for Optional Residual FM Test)..... HP 8662A
- Phase Noise Measurement System..... HP 3048A

PROCEDURE

Spurious Signals Test

1. Set the spectrum analyzer as follows:

- Center Frequency 100 kHz
- Frequency Span 30 kHz
- Resolution Bandwidth 300 Hz
- Reference Level +7 dBm

2. Set the HP 8657D as follows:

- Frequency 100 kHz
- Frequency Increment 100 kHz
- Amplitude +7 dBm
- Modulation Off

3. Connect the RF OUTPUT of the HP 8657D to the input of the spectrum analyzer as shown in Figure 4-1. Verify that all harmonics are within the specifications shown in the following table:

Spurious Signals	Results	
	Actual	Max.
Harmonics	_____	< - 30 dBc, 0.1 to 1040 MHz
Non-Harmonics	_____	< - 60 dBc, 0.1 to 1040 MHz
5 kHz to 2 MHz from carrier	_____	< - 63 dBc, 0.1 to 130 MHz
	_____	< - 75 dBc, 130 to 260 MHz
	_____	< - 66 dBc, 260 to 520 MHz
	_____	< - 63 dBc, 520 to 1040 MHz
Sub-Harmonics	_____	None, 0.1 to 1040 MHz

NOTE

Adjust the Center Frequency, Frequency Span, and Resolution Bandwidth controls as required.

Change the frequency increment from 100 kHz to 10 MHz at 10 MHz, if desired.

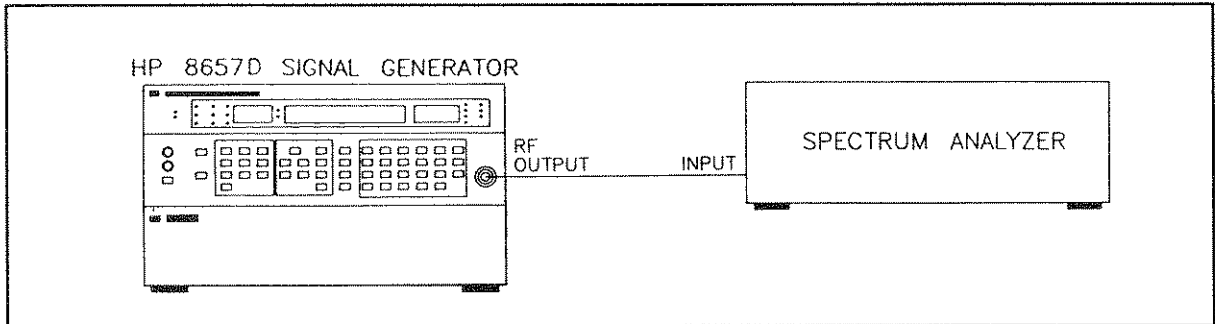

Figure 4-1. Spurious Signals Test Setup

Residual AM

4. Verify the residual AM of the measuring receiver as follows:

- a. Connect the modulation output of the measuring receiver to the input of the digital multimeter and the AM output of the AM/FM test source to the input of the measuring receiver as shown in Figure 4-2. Nothing should be connected to the audio input of the AM/FM test source.

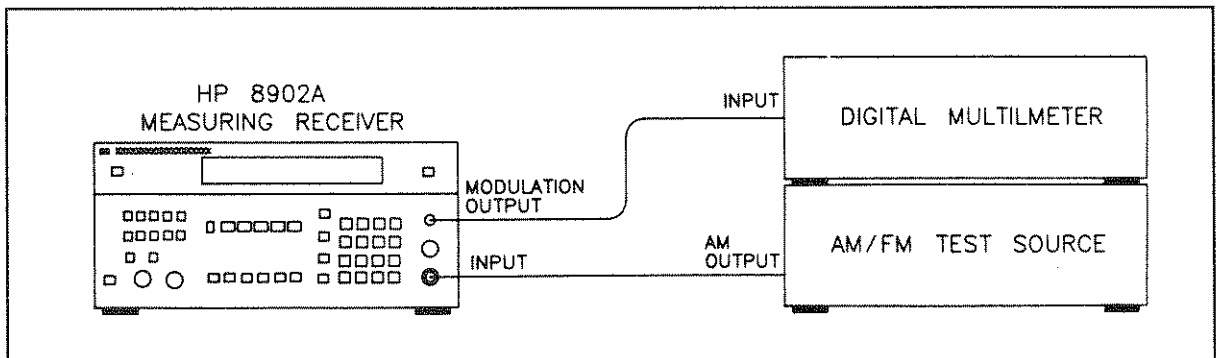

Figure 4-2. Measuring Receiver Residual AM Verification Test Setup

NOTE

The residual AM specification of the HP 8657D is not equivalent to the published specification of the HP 8902A Measuring Receiver. To make a valid residual AM measurement, the residual AM of the measuring receiver should be at least 3 dB better than the specification being tested. The residual AM of the Measuring Receiver must be verified to be adequate to measure the HP 8657D residual AM specification to ensure the validity of the measurement. If residual AM is measured frequently, it is not necessary to verify the residual AM of the measuring receiver each time; however, it is recommended that it be verified monthly to ensure an accurate measurement.

- b. Set the measuring receiver as follows:
 Measurement Frequency
- c. Set the AM/FM test source as follows:
 Test Mode FM
- d. Tune the carrier frequency on the AM/FM test source for a measuring receiver reading of 12.5 ± 0.1 MHz.
- e. Set the digital multimeter as follows:
 Function Vac
 Range 200 mV
- f. Set the measuring receiver as follows:
 Measurement AM
 HP Filter 50 Hz
 LP Filter 15 kHz
- g. The digital multimeter should indicate 2.80 mV or less.

NOTE

To make a valid residual AM measurement, the residual AM of the measuring receiver should be at least 3 dB better than the specification being tested or 0.028%. With an output sensitivity of 10%/V, the corresponding output level is 2.80 mV.

- 5. Set the measuring receiver as follows:
 Measurement AM
 Detector Peak+
 HP Filter 50 Hz
 LP Filter 15 kHz
 FM De-Emphasis Off
- 6. Set the HP 8657D as follows:
 Frequency Any
 Amplitude 0.0 dBm
 Modulation Off
- 7. Set the digital multimeter as follows:
 Function Vac
 Range 200 mV
- 8. Connect the RF OUTPUT of the HP 8657D to the input of the measuring receiver and the modulation output of the measuring receiver to the input of the digital multimeter as shown in Figure 4-3.
- 9. The digital multimeter should indicate <4.00 mVrms.

Actual	Maximum
_____	< 4.00 mVrms

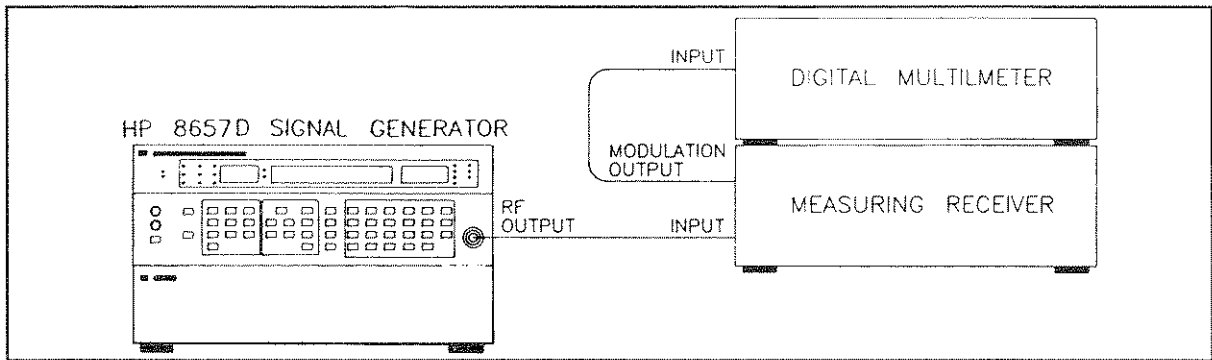

Figure 4-3. Residual AM Test Setup

Residual FM

NOTE

A standard HP 8902A can be used to verify the residual FM specifications in the heterodyne band of frequencies. Tests performed at these frequencies will verify that in all probability, the instrument meets its specifications. If the HP 8657D has been repaired or the heterodyne band of frequencies do not pass, the Optional Residual FM Test (steps 10a-13a) should be performed.

10. Set the measuring receiver as follows:

Measurement	FM
Detector	RMS
FM De-Emphasis	Off
Automatic Operation.....	Selected

11. Set the HP 8657D under test as follows:

Frequency	Any From Chart
Amplitude	0.0 dBm
Modulation	Off

12. Connect the RF OUTPUT of the HP 8657D under test to the input of the measuring receiver as shown in Figure 4-4.

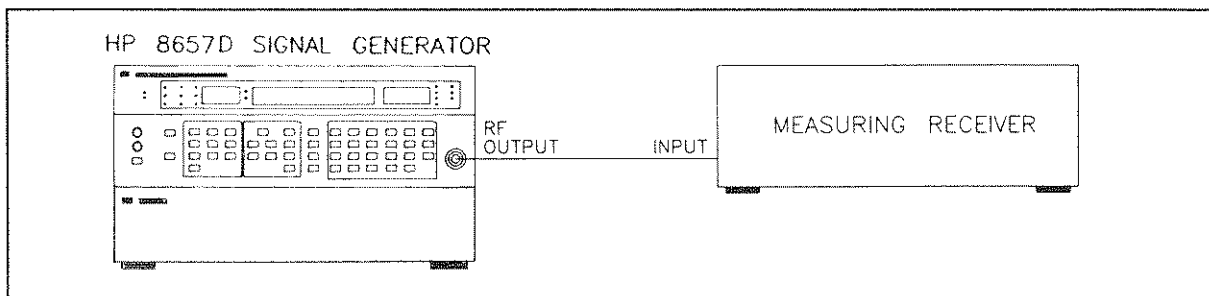

Figure 4-4. Residual FM Test Setup

13. Set the HP 8657D frequency and select the measuring receiver high-pass and low-pass filters as indicated in the following table. Verify that the measured results do not exceed the limits specified.

HP 8657D Frequency (MHz)	Modulation Analyzer Filter		Results (Hz rms)	
	High Pass (Hz)	Low Pass (kHz)	Actual	Max.
0.15 to 129.99999	300	3	_____	4
0.15 to 129.99999	50	15	_____	6

Optional Residual FM Test

The Residual FM Test gives confidence that the HP 8657D is passing all its Residual FM specifications. The Residual FM of the HP 8657D can be checked at all frequencies with an HP 8902A Option 003 and an external local oscillator (LO). The residual FM of the external LO must be less than the residual FM of the HP 8657D under test.

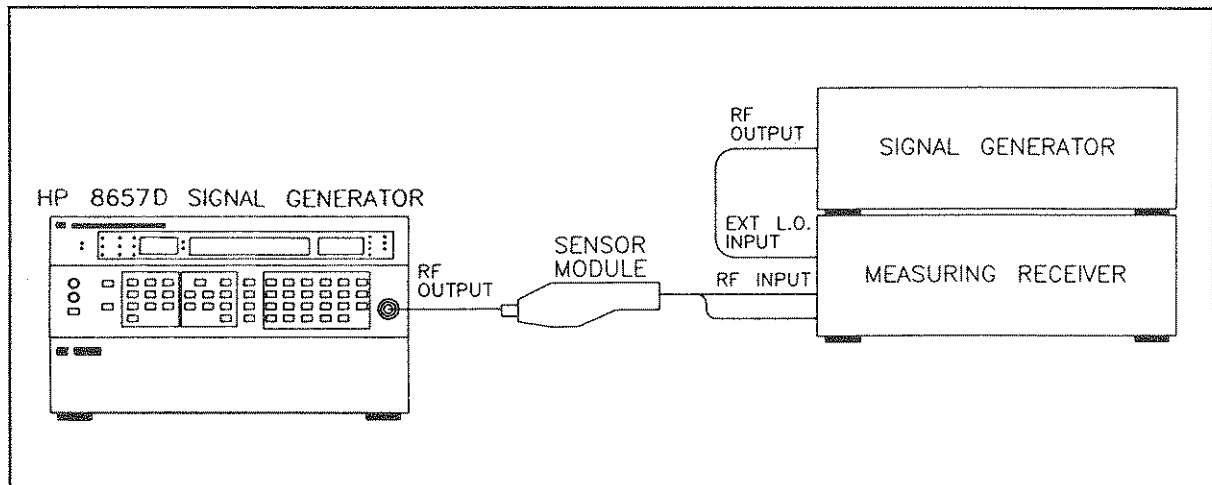

Figure 4-4a. Optional Residual Test Setup

- 10a. Set the measuring receiver as follows:
 - Measurement FM
 - Detector RMS
 - FM De-Emphasis Off
 - Automatic Operation..... Selected
- 11a. Set the HP 8657D under test and the LO Signal Generator as follows:
 - Frequency Any From Chart
 - Amplitude 0.0 dBm
 - Modulation Off
- 12a. Connect the test equipment as shown in Figure 4-4a.
- 13a. Set frequency on the Test HP 8657D and the LO Signal Generator and select the measuring receiver high-pass and low-pass filters as indicated in the following table. Verify that the measured results do not exceed the limits specified.

Optional Residual FM Test Specifications

Test HP 8657D Frequency (MHz)	LO Signal Generator Frequency (MHz)	Modulation Analyzer Filter		Results (Hz rms)	
		High Pass (Hz)	Low Pass (kHz)	Actual	Max.
245	246.5	300	3	_____	1
410	411.5	300	3	_____	2
775	776.5	300	3	_____	3
245	246.5	50	15	_____	1.5
410	411.5	50	15	_____	3
775	776.5	50	15	_____	4

SSB Phase Noise (1 Hz Bandwidth)

Description

Single-sideband (SSB) phase noise of the HP 8657D is measured at the offset frequency of 20 KHz and output frequencies to 1600 MHz by the HP 3048A Phase Noise System using its Phase Lock Loop measurement type. The system software provides both the measurement program and the BASIC operating system for the controller. This procedure provides the steps for entering the specific measurement parameters required for this test.

NOTE

This test measures the total SSB phase noise of both generators. This test assumes that the noise level of the reference source you are using is lower than or equal to the noise level of the HP 8657D being tested. If the reference source's phase noise level is equal to the HP 8657D's, the actual noise level for both sources is 3 dB below the level measured by the HP 3048A.

1. The HP 3048's BASIC operating system and system software must be loaded, the HP 8657D's HP-IB address entered, and system operation verified before this test is run. Refer to the HP 3048A Phase Noise Measurement System Operating Manual, Appendix A for the required procedures.
2. If you are not at the HP 3048A's Main Software Level, press the **Done** or **Abort** Softkey. The Main Software Level menu provides access to each of the HP 3048's main functions. You will always return to this menu when you exit the selected function.

Defining the Measurement

3. Press the **Define Msrmt** Softkey to display the Measurement Definition Menu.
4. Press the **Test Files** softkey.
5. Position the cursor at the file labeled HP EXAMPLE RF SYNTHESIZER (8662/3 DCFM).
6. Press the **Load File** key. After the HP 3048A has completed the file loading sequence, press the **Done** key.

NOTE

This example file contains many of the measurement parameters required for this test. Table 4-2 lists the parameters that have been loaded from this file. The following steps will guide you through the process of making the necessary changes to the parameters to meet the specific requirements of this test.

7. Press the **Instr Params** key. Enter a carrier frequency of 640 E+6 Hz. Enter a Detector/Disc. Input frequency of 640 E+6 Hz. Enter a VCO Tuning Constant of 1 E+3 Hz/volt. Enter the Voltage Tuning Range of VCO as 5 volts. The remaining entries do not need to be changed.

Press the **Done** key.

8. Press the **Calibr Process** key. Press the **Tuning Const** key to select Compute from expected T. Constant. Press the **Done** key.
9. Press the **Source Control** key. Press the **Ref. Source** key as needed to select 8657D SYSTEM CNTRL. Press the **Done** key when you have completed this operation.

NOTE

*The HP 8657D under test is configured as the reference source in this display to enable the HP 3048A to control it using control routines built into the HP 3048A's software. The measurement results will still reflect the noise level of the HP 8657D under test. If you are not able to select the HP 8657D as the reference source using the Ref. Source key, then the HP 8657D has not yet been entered into the HP 3048A's Configuration Table. To enter the HP 8657D, return to the Main Software Menu and press the **System Config** key.*

10. Press the **Define Graph** key. Enter an appropriate graph title for your test. Press the **Done** key to exit this menu, and then press the **Done** key again to return to the Main Software level.

Beginning the Measurement

11. Press the **New Msrmt** key to begin the phase noise measurement.
12. When the hardware connect diagram appears in the display, connect the HP 8657D and reference source to the HP 3048A as shown. (Note that the reference source is labeled USERS's DUT on the screen. Figure 4-5 also shows the cable connections for this measurement.)
13. Adjust the reference source's center frequency to 640 MHz and its amplitude to 0 dBm. (The HP 8657D's setting will be adjusted by the HP 3048A via its HP-IB connection.)

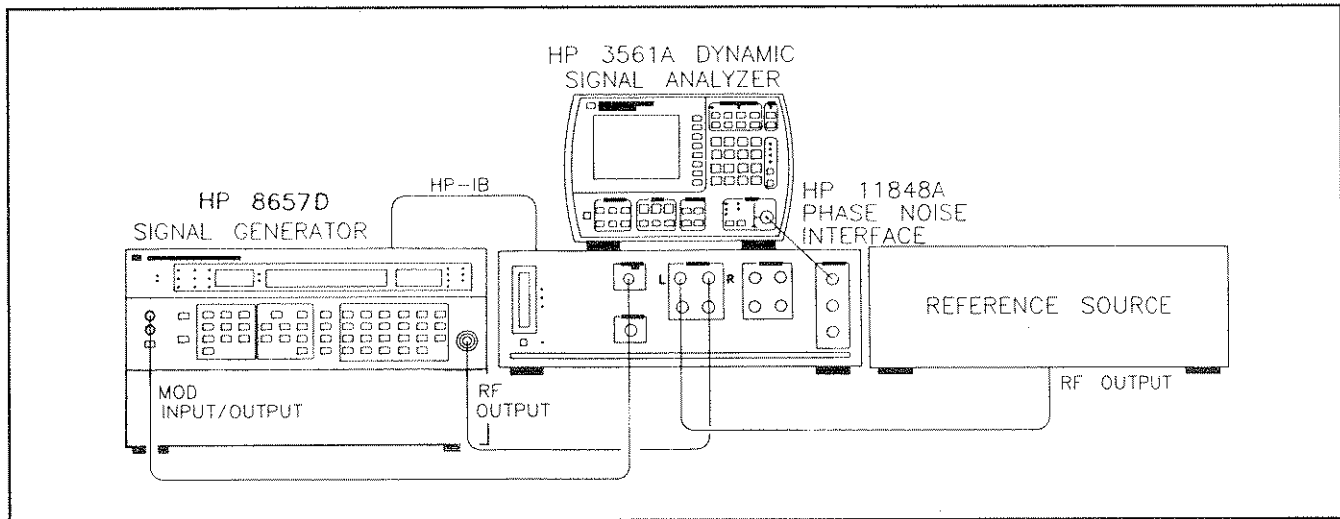

Figure 4-5. Setup Diagram for SSB Phase Noise Measurement

14. After you have connected the cables, press the **Proceed** key to run the measurement. (If you wish to measure the phase noise level of the HP 8657D at other center frequency settings after this test is completed, change the center frequency on the reference source to the desired frequency. Enter the desired frequency as the carrier frequency and detector/disc input frequency in the Source and Interface Parameter Entry menu.)

NOTE

If the noise level measured by the HP 3048A exceeds the HP 8657D's specified noise level and the exact noise level of the reference source is not known, the exact level of each source should be determined by measuring each source against a third signal source and comparing the measurement results for all three measurements.

15. The Measured SSB Phase Noise should be at or below the specified value.

Offset from Carrier	SSB Phase Noise		Carrier Frequency (MHz)
	Min.	Actual	
20 kHz	-124 dBc/Hz	_____	0.1 to 129
	-136 dBc/Hz	_____	130 to 260
	-130 dBc/Hz	_____	260 to 520
	-124 dBc/Hz	_____	520 to 1040

Table 4-2. Parameter Data Loaded from HP Example RF Synthesizer (HP 8662/3 DCFM file)

Parameters	Data
Measurement Type Frequency Range Start Freq. Stop Freq. Averages	Phase Noise Using a Phase Lock Loop 1 Hz 100 E + 3 Hz 4
Source Parameters Carrier Frequency Detector/Discr. Input Frequency VCO Tuning Constant Center Voltage of VCO Tuning Curve Voltage Tuning Range of VCO VCO Tune-Port Input Resistance Internal Phase Detector	500 E + 6 Hz 500 E + 6 Hz 25 E + 3 Hz/V 0 Volts ±2 Volts 600 ohms 5 MHz to 1600 MHz
Phase Detector Constant VCO Tuning Constant PLL Suppression	Measure the Detector Constant Measure the VCO Tuning Constant Will be verified
Source Control	
Define Graph Title Minimum X Maximum X Minimum Y Maximum Y Graph Type	RF SYNTHESIZER VERSUS HP 8662/3A USING DC FM. 1 Hz 100 E + 3 Hz -170 0 Single Sideband Phase Noise (dBc/Hz)

Performance Test 2

OUTPUT LEVEL ACCURACY AND FLATNESS TESTS

- Level Flatness
- Absolute Level Accuracy

Specifications

Electrical Characteristics	Performance Limits	Conditions
Output		
Level Range (into 50 ohms)		
Analog Mode:	+13 dBm to -143.5 dBm	100 kHz to 1040 MHz
$\pi/4$ DQPSK Mode:	+3 dBm to -143.5 dBm +7 dBm to -143.5 dBm +3 dBm to -143.5 dBm	10 to 129.9 MHz 810 to 965 MHz 1420 to 1540 MHz
Resolution	0.1 dB	
Absolute Level Accuracy ⁽¹⁾	$\leq \pm 1.0$ dB	Output levels of: +3.5 dBm to -127 dBm ⁽²⁾ +3.0 dBm to -127 dBm ⁽³⁾
	$< \pm 1.5$ dB	$> +3.5$ dBm ⁽²⁾
Level Flatness ⁽²⁾	$\leq \pm 0.5$ dB	Output level setting of 0.0 dBm; frequencies from 100 kHz to 1040 MHz
<p>⁽¹⁾ Absolute level accuracy includes allowances for detector linearity, temperature, flatness, attenuator accuracy, and measurement errors.</p> <p>⁽²⁾ Analog only.</p> <p>⁽³⁾ $\pi/4$ DQPSK only.</p>		

Description

Output level accuracy and flatness are verified using a measuring receiver and a sensor module.

Equipment

Measuring Receiver..... HP 8902A
 Sensor Module..... HP 11722A

PROCEDURE

Level Flatness

1. Connect the sensor module to the measuring receiver. Zero and calibrate the sensor module and measuring receiver.
2. Connect the sensor module to the HP 8657D as shown in Figure 4-6.

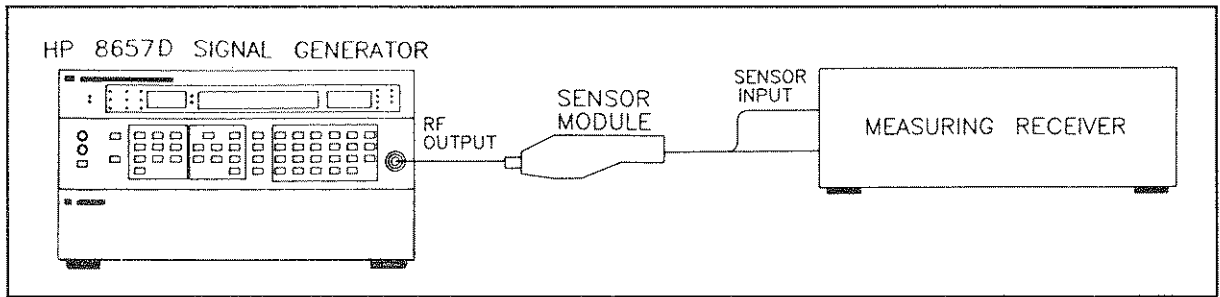

Figure 4-6. Output Level Accuracy and Flatness Test Setup

3. Set the measuring receiver as follows:
 - Measurement RF POWER
 - Display LOG
 - Frequency100 MHz
4. Set the HP 8657D as follows:
 - Frequency 100 kHz
 - Amplitude 0.0 dBm
 - Modulation Off
5. Wait for the power measurement to settle and then select DISPLAY RATIO on the measuring receiver to set a 0.0 dB. reference.
6. Set a Frequency Increment value on the Measuring Receiver and HP 8657D according to the frequency band of the measurements. Frequency Increment on the measuring receiver is set by entering the numeric value in kHz and pressing the kHz (up or down) keys. Upon entering that value the measuring receiver will also change the center frequency by that amount, the HP 8657D should be stepped to match. Use increments of 100 kHz (100 kHz to 1 MHz), 1 MHz (1 MHz to 10 MHz), 10 MHz (10 MHz to 100 MHz), 100 MHz and (100 MHz to 1040 MHz).
7. Step the HP 8657D and measuring receiver through the frequency range of 100 kHz to 1040 MHz. Record the highest and lowest power levels and their frequencies and calculate the maximum variation.

_____ Highest Reading	_____ Frequency
_____ Lowest Reading	_____ Frequency

The amplitude variation should not exceed 1.0 dB. Record the maximum variation (highest reading – lowest reading).

_____ <1.0 dB

Absolute Level Accuracy – Analog Mode

8. Step the HP 8657D and measuring receiver through the frequency range of 3 MHz to 1040 MHz. Record the highest and lowest reading to be used in the Absolute Level Accuracy test.

_____ Highest Reading	_____ Test Frequency 1
_____ Lowest Reading	_____ Test Frequency 2

9. Set the HP 8657D as follows:

Frequency From Step 8
 Amplitude +3.0 dBm
 Amplitude Increment 5 dBm
 Modulation Off

10. Set the measuring receiver as follows:

Frequency From Step 8
 Measurement RF POWER

11. Absolute Level Accuracy must be tested on the HP 8657D using the frequencies from step 8. Begin decrementing the HP 8657D amplitude in 5 dB steps. At each step, the measuring receiver reading must be within the tolerances shown in the following Table, RF Output Frequencies. Step the amplitude down to -2 dBm. Change the measuring receiver's measurement to TUNED RF LEVEL. If RECAL or UNCAL is displayed press and release the CALIBRATE key. Continue to step the amplitude down to -127 dBm; and each time RECAL is displayed press and release the CALIBRATE key.

RF Output Test Frequency 1 _____

RF Output Test Frequency 2 _____

Amplitude Setting (dBm)	Minimum (dBm)	Actual (dBm)	Maximum (dBm)
+3.0	+2.0	_____	+4.0
-2.0	-3.0	_____	-1.0
-7.0	-8.0	_____	-6.0
-12.0	-13.0	_____	-11.0
-17.0	-18.0	_____	-16.0
-22.0	-23.0	_____	-21.0
-27.0	-28.0	_____	-26.0
-32.0	-33.0	_____	-31.0
-37.0	-38.0	_____	-36.0
-42.0	-43.0	_____	-41.0
-47.0	-48.0	_____	-46.0
-52.0	-53.0	_____	-51.0
-57.0	-58.0	_____	-56.0
-63.0	-63.0	_____	-61.0
-67.0	-68.0	_____	-66.0
-72.0	-73.0	_____	-71.0
-77.0	-78.0	_____	-76.0
-82.0	-83.0	_____	-81.0
-87.0	-88.0	_____	-86.0
-92.0	-93.0	_____	-91.0
-97.0	-98.0	_____	-96.0
-102.0	-103.0	_____	-101.0
-107.0	-108.0	_____	-106.0
-112.0	-113.0	_____	-111.0
-117.0	-118.0	_____	-116.0
-122.0	-123.0	_____	-121.0
-127.0	-128.0	_____	-126.0

Amplitude Setting (dBm)	Minimum (dBm)	Actual (dBm)	Maximum (dBm)
+3.0	+2.0	_____	+4.0
-2.0	-3.0	_____	-1.0
-7.0	-8.0	_____	-6.0
-12.0	-13.0	_____	-11.0
-17.0	-18.0	_____	-16.0
-22.0	-23.0	_____	-21.0
-27.0	-28.0	_____	-26.0
-32.0	-33.0	_____	-31.0
-37.0	-38.0	_____	-36.0
-42.0	-43.0	_____	-41.0
-47.0	-48.0	_____	-46.0
-52.0	-53.0	_____	-51.0
-57.0	-58.0	_____	-56.0
-63.0	-63.0	_____	-61.0
-67.0	-68.0	_____	-66.0
-72.0	-73.0	_____	-71.0
-77.0	-78.0	_____	-76.0
-82.0	-83.0	_____	-81.0
-87.0	-88.0	_____	-86.0
-92.0	-93.0	_____	-91.0
-97.0	-98.0	_____	-96.0
-102.0	-103.0	_____	-101.0
-107.0	-108.0	_____	-106.0
-112.0	-113.0	_____	-111.0
-117.0	-118.0	_____	-116.0
-122.0	-123.0	_____	-121.0
-127.0	-128.0	_____	-126.0

Absolute Level Accuracy – $\pi/4$ DQPSK Mode

12. Step the HP 8657D and measuring receiver through the three digital frequency ranges:

- 10 to 129.9 MHz
- 810 to 965 MHz
- 1420 to 1540 MHz

13. Set the HP 8657D as follows:

Frequency From Step 12
 Amplitude +3.0 dBm
 Amplitude Increment 5 dBm
 Modulation $\pi/4$ DQPSK

14. Set the measuring receiver as follows:

Frequency From Step 12
 Measurement RF POWER

15. Absolute Level Accuracy must be tested on the HP 8657D using the frequencies from step 12. Begin decrementing the HP 8657D amplitude in 5 dB steps. At each step, the measuring receiver reading must be within the tolerances shown in the following Table, RF Output Frequencies. Step the amplitude down to -2 dBm. Change the measuring receiver's measurement to TUNED RF LEVEL. If RECAL or UNCAL is displayed press and release the CALIBRATE key. Continue to step the amplitude down to -127 dBm; and each time RECAL is displayed press and release the CALIBRATE key.

Amplitude Setting (dBm)	Minimum (dBm)	Actual (dBm)	Maximum (dBm)
+3.0	+2.0	_____	+4.0
-2.0	-3.0	_____	-1.0
-7.0	-8.0	_____	-6.0
-12.0	-13.0	_____	-11.0
-17.0	-18.0	_____	-16.0
-22.0	-23.0	_____	-21.0
-27.0	-28.0	_____	-26.0
-32.0	-33.0	_____	-31.0
-37.0	-38.0	_____	-36.0
-42.0	-43.0	_____	-41.0
-47.0	-48.0	_____	-46.0
-52.0	-53.0	_____	-51.0
-57.0	-58.0	_____	-56.0
-63.0	-63.0	_____	-61.0
-67.0	-68.0	_____	-66.0
-72.0	-73.0	_____	-71.0
-77.0	-78.0	_____	-76.0
-82.0	-83.0	_____	-81.0
-87.0	-88.0	_____	-86.0
-92.0	-93.0	_____	-91.0
-97.0	-98.0	_____	-96.0
-102.0	-103.0	_____	-101.0
-107.0	-108.0	_____	-106.0
-112.0	-113.0	_____	-111.0
-117.0	-118.0	_____	-116.0
-122.0	-123.0	_____	-121.0
-127.0	-128.0	_____	-126.0

Performance Test 3

MODULATION TESTS

- **AC Modulation**
 - AM Indicator Accuracy
 - Incidental Phase Modulation
 - AM Distortion
 - FM Indicator Accuracy
 - Incidental AM
 - FM Distortion
- **DC Modulation**
 - DC FM Center Frequency Accuracy
 - DC FM Center Frequency Stability
- **Pulse Modulation**
 - ON OFF Ratio
 - Rise/Fall Time
- **$\pi/4$ DQPSK Modulation**
 - Error Vector Magnitude
 - I/Q Origin Offset

Specifications

Electrical Characteristics	Performance Limits	Conditions
Amplitude Modulation		
Depth ⁽¹⁾	0 to 100%	Output levels ≤ 4 dBm; frequencies from 400 kHz to 1040 MHz
	0 to 30%	Output levels ≤ 6 dBm; frequencies from 400 kHz to 1040 MHz
Resolution	1%	
Incidental Phase Modulation	< 0.3 radian peak	30% AM depth and internal rates.
Indicator Accuracy	$\pm(2\% + 6\%$ of reading)	Depths $< 90\%$ and internal rates and levels $\leq +4$ dBm.
AM Rates		
Internal	400 and 1 kHz, $\pm 2\%$	
External	20 Hz to 40 kHz	1 dB bandwidth, ac coupled
AM Distortion, 1 kHz internal rate	$< 1.5\%$	0 to 30% AM frequencies < 1040
Levels ≥ 7 dBm	$< 3\%$	31 to 70% AM frequencies < 1040
	$< 4\%$	71 to 90% AM frequencies < 1040
(1) AM Depth is further limited by the Indicator Accuracy specification.		

Electrical Characteristics	Performance Limits	Conditions
<p>FM Modulation</p> <p>Maximum Peak Deviation (Δf_{pk}):⁽²⁾ 20 Hz to 50 kHz 1 dB Bandwidth</p> <p>Rates (dc mode)</p> <p>Center Frequency Accuracy (dc mode)</p> <p>Stability (dc mode)</p> <p>Resolution</p> <p>Incidental AM</p> <p>Indicator Accuracy⁽²⁾</p> <p>FM Distortion (Total Harmonic Distortion)⁽³⁾</p> <p>FM Rates: Internal External External</p> <p>Pulse Modulation ON/OFF Ratio: Rise/Fall Time:</p> <p>$\pi/4$ DQPSK Modulation Error Vector Magnitude: (15° C to 35° C)</p> <p>I/Q Origin Offset: (15° C to 35° C)</p>	<p>200 kHz 50 kHz 100 kHz 200 kHz 4000 × Rate Hz 1000 × Rate Hz 2000 × Rate Hz 4000 × Rate Hz</p> <p>200 kHz 50 kHz 100 kHz 200 kHz</p> <p>±500 Hz ± 125 Hz ± 250 Hz ± 500 Hz</p> <p>< 10 Hz/hour</p> <p>0.1 kHz 1 kHz</p> <p>< 0.1%</p> <p>±5% of reading</p> <p><0.5%</p> <p>400 and 1 kHz, ±2% 20 Hz to 50 kHz 5 Hz to 100 kHz dc to 50 kHz dc to 100 kHz</p> <p>>70 dB >50 dB</p> <p>< 35 ns</p> <p>≤ 4% ≤ 3.5% ≤ 4%</p> <p>≤ -35 dB</p>	<p>0.1 to 130 MHz (fc) 130 to 260 MHz (fc) 260 to 520 MHz (fc) 520 to 1040 MHz (fc) 0.1 to 130 MHz (fc) 130 to 260 MHz (fc) 260 to 520 MHz (fc) 520 to 1040 MHz (fc)</p> <p>0.1 to 130 MHz (fc) 130 to 260 MHz (fc) 260 to 520 MHz (fc) 520 to 1040 MHz (fc)</p> <p>0.1 to 130 MHz (fc) 130 to 260 MHz (fc) 260 to 520 MHz (fc) 520 to 1040 MHz (fc)</p> <p>Deviations < 100 kHz, fc <1040 MHz Deviations ≥ 100 kHz, fc <1040 MHz</p> <p>< 20 kHz peak deviation and internal rates: 500 kHz to 1040 MHz</p> <p>At internal 1kHz rate</p> <p>≥ 6 kHz peak deviations and at internal 1kHz rate</p> <p>ac coupled, ±1 dB. ±3 dB. dc coupled, ±1 dB. ±3 dB.</p> <p>< 1040 MHz 1420 to 1540 MHz ($\pi/4$ DQPSK mode) < 1040 MHz</p> <p>10 to 129.9 MHz, level ≤ +3dBm 810 to 965 MHz, level ≤ +7dBm 1420 to 1540 MHz, level ≤ +3dBm</p> <p>RF output only</p>

(2) FM deviation is further limited by the Indicator Accuracy specification.

(3) FM distortion only applies at deviation at 1/2 maximum, $f_c < 520$ MHz. Typical total FM distortion (harmonic and non-harmonic) is less than 1.5% for all specified deviations and external rates of dc to 100 kHz.

AC MODULATION

Description

AC modulation specifications are verified by measuring the specified parameters with a measuring receiver. Distortion is verified by measuring the demodulated output from the measuring receiver with a distortion analyzer.

Equipment

Measuring Receiver	HP 8902A
Sensor Module	HP 11722A
Audio Analyzer and Source	HP 8903B
AM/FM Test Source	HP 11715A
Cable (UG-21D/U type N connectors)	HP 11500B
Cable (UG-88C/U BNC and dual banana plug connectors)	HP 11001-60001

PROCEDURE

AM Indicator Accuracy

1. Connect the RF OUTPUT of the HP 8657D to the input of the measuring receiver as shown in Figure 4-7.

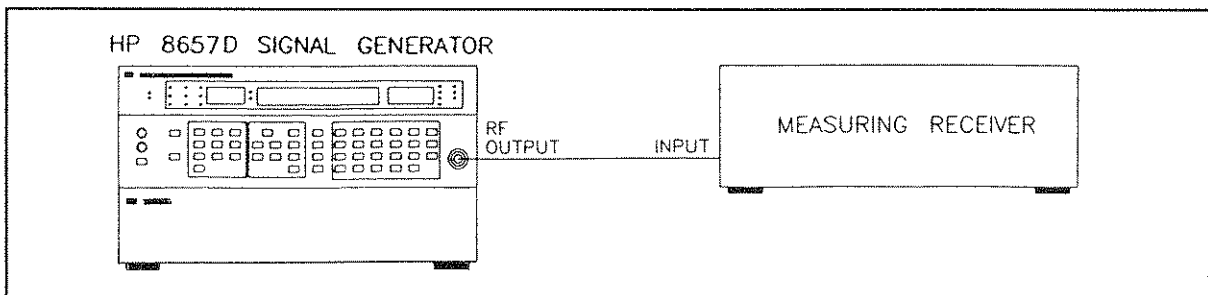

Figure 4-7. Modulation Test Setup

2. Set the measuring receiver as follows:

Measurement	AM
Detector	Peak+ and Peak -
HP Filter	300 Hz
LP Filter	15 kHz
FM De-Emphasis	Off
Automatic Operation	Selected

3. Set the HP 8657D as follows:

Frequency	100 MHz
Amplitude	+1 dBm
Modulation	1 kHz (Int.) AM 10%

4. Set the AM depth to the values listed in the following table and verify that the measured results are within the limits specified.

MHz	AM Depth	Results		
		Min.	Actual	Max.
100	10%	7.4%	_____	12.6%
	30%	26.2%	_____	33.8%
	70%	63.8%	_____	76.2%
	90%	82.6%	_____	97.4%
240	10%	7.4%	_____	12.6%
	30%	26.2%	_____	33.8%
	70%	63.8%	_____	76.2%
	90%	82.6%	_____	97.4%
400	10%	7.4%	_____	12.6%
	30%	26.2%	_____	33.8%
	70%	63.8%	_____	76.2%
	90%	82.6%	_____	97.4%
1040	10%	7.4%	_____	12.6%
	30%	26.2%	_____	33.8%
	70%	63.8%	_____	76.2%
	90%	82.6%	_____	97.4%

Incidental Phase Modulation

5. Set the measuring receiver as follows:

Measurement Phase Modulation
 HP Filter 300 Hz
 LP Filter 15 kHz
 Detector Peak+

6. Set the HP 8657D as follows:

Frequency 150 kHz
 Frequency Increment 150 kHz
 Amplitude +4 dBm
 Modulation 1 kHz (Int.) AM 30%

7. Step the HP 8657D through the frequency range of 150 kHz to 1040 MHz use 10 MHz steps above 10 MHz) and record the highest reading. The highest reading should not exceed the limit specified.

HP 8657D Frequency		Result	
Min.	Max.	Actual	Max.
150 kHz	1040 MHz	_____	< 0.3 radian peak

AM Distortion

8. Set the Measuring Receiver as follows:

MeasurementAM
 HP Filter 300 Hz
 LP Filter 15 kHz
 DetectorPeak+ and Peak-

9. Set the Audio Analyzer as follows:

Measurement Distortion

10. Set the HP 8657D as follows:

Frequency 10 MHz
 Amplitude+1 dBm
 Modulation 1 kHz (Int.) AM 30%

11. Set the AM depth to the values listed in the following table and verify that the measured results do not exceed the limits specified.

MHz	AM Depth	Results <1040 MHz	
		Actual	Max.
100	30%	_____	< 1.5%
	70%	_____	< 3.0%
	90%	_____	< 4.0%
240	30%	_____	< 1.5%
	70%	_____	< 3.0%
	90%	_____	< 4.0%
400	30%	_____	< 1.5%
	70%	_____	< 3.0%
	90%	_____	< 4.0%
1040	30%	_____	< 1.5%
	70%	_____	< 3.0%
	90%	_____	< 4.0%

FM Indicator Accuracy

12. Set the measuring receiver as follows:

Measurement FM
 Detector Peak+
 HP Filter 300 Hz
 LP Filter 3 kHz

13. Set the HP 8657D as follows:

Frequency 100 MHz
 Amplitude +1 dBm
 Modulation 1 kHz (Int) FM 5 kHz

14. Set FM deviation to the values listed in the following table and verify that the measured results are within the limits specified.

FM Deviation for 100 MHz	Results		
	Min.	Actual	Max.
5.0 kHz	4.75 kHz	_____	5.25 kHz
30.0 kHz	28.50 kHz	_____	31.50 kHz
70.0 kHz	66.50 kHz	_____	73.50 kHz
99.0 kHz	94.05 kHz	_____	103.95 kHz

Incidental AM

The incidental AM specification of the HP 8657D is not equivalent to the published specification of the HP 8902A Measuring Receiver. To make a valid incidental AM measurement, the incidental AM of the measuring receiver must be four times better than the specification being tested. In order to verify that the incidental AM of the measuring receiver is adequate to measure the HP 8657D's incidental AM specification, the incidental AM of the measuring receiver must be verified to ensure the validity of the measurement. If the HP 8657D's incidental AM is measured frequently, it is not necessary to verify the incidental AM of the measuring receiver each time; however, it is recommended that it be verified monthly to ensure an accurate measurement.

15. Verify the incidental AM of the measuring receiver as follows:

- a. Connect the FM divide-by-4 output of the AM/FM test source to the input of the measuring receiver, and the 50 ohm output of the test oscillator to the audio input of the AM/FM test source, as shown in Figure 4-8.
- b. Set the measuring receiver as follows:

Measurement Frequency

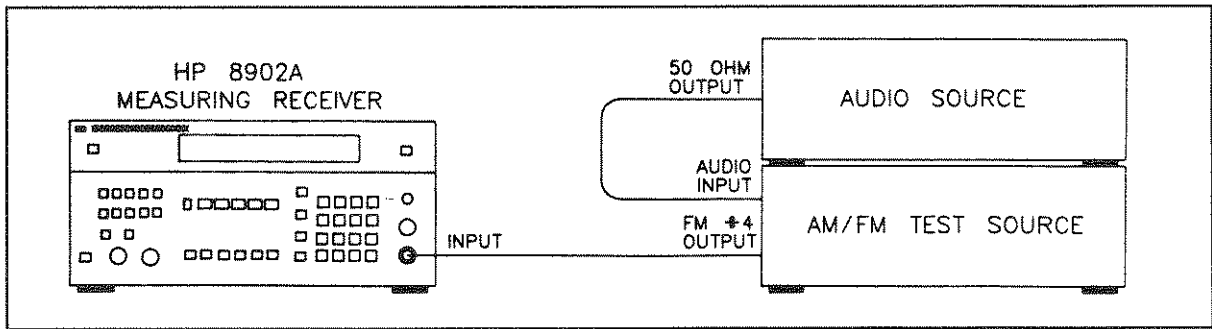

Figure 4-8. Measuring Receiver Incidental AM Verification Test Setup

- c. Set the AM/FM test source as follows:
 - Test Mode FM
- d. Tune the carrier frequency on the AM/FM test source for a measuring receiver reading of 100 MHz \pm 0.1 MHz.
- e. Set the test oscillator as follows:
 - Frequency 1 kHz
 - Output Attenuator -10 dBm
 - Amplitude Course Fully ccw
- f. Set the measuring receiver as follows:
 - Measurement FM
 - Detector Peak+
 - HP Filter 300 Hz
 - LP Filter 3 kHz
- g. Increase the output of the test oscillator by rotating the Amplitude Coarse control clockwise until the measuring receiver indicates 20.0 kHz \pm 0.1 kHz peak deviation.
- h. Set the measuring receiver as follows:
 - Measurement AM
- i. The modulation must be < 0.02% AM to test the incidental AM of the HP 8657D.

- 16. Set the measuring receiver as follows:
 - Measurement AM
 - Detector Peak+
 - HP Filter 300 Hz
 - LP Filter 3 kHz

- 17. Set the HP 8657D as follows:
 - Amplitude +1 dBm
 - Modulation 1 kHz (Int) FM 20 kHz

- 18. Connect the equipment as shown in Figure 4-7, Modulation Test Setup.

19. Set the HP 8657D frequency to a value within the range specified in the following table and verify that the measured result does not exceed the limit specified.

HP 8657D Frequency		Result	
Min.	Max.	Actual	Max.
10 MHz	1040 MHz	_____	< 0.1%

NOTE

Below 10 MHz, the incidental AM of the HP 8657D is less than that of the measuring receiver.

FM Distortion

20. Set the measuring receiver as follows:

Measurement FM
 Detector Peak+
 HP Filter 300 Hz
 LP Filter 3 kHz

21. Set the distortion analyzer as follows:

Function Distortion
 Analyzer Input Select Distortion
 Frequency 1 kHz

22. Set the HP 8657D as follows:

Frequency 150.0 MHz
 Amplitude +4 dBm
 Modulation 1 kHz (Int) FM

23. Connect the equipment as shown in Figure 4-7, Modulation Test Setup.

24. Verify that the measured Total Harmonic Distortion does not exceed 0.5%.

25. Set the HP 8657D FM deviation to a value within the range specified in the following table and verify that the measured result does not exceed the limit specified.

FM Deviation		Result	
Min.	Max.	Actual	Max.
6 kHz	99 kHz	_____	<0.5%

NOTE

At peak deviations less than 3 kHz, residual FM and other types of FM distortion become a greater portion of the distortion reading. If the distortion falls within tolerance at or above 3 kHz, it may be safely assumed that the HP 8657D meets the test requirements.

DC MODULATION

Description

DC FM specifications are verified by measuring the RF OUTPUT frequency offset with a frequency counter.

Equipment

Frequency Counter..... HP 5328B OPT 31

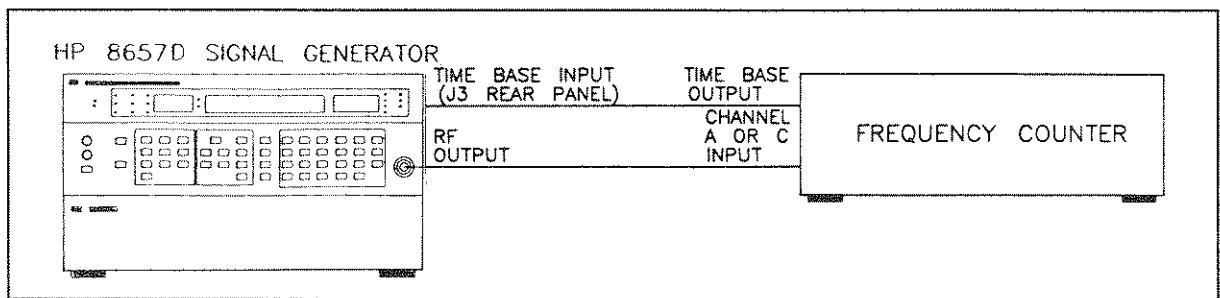

Figure 4-9. DC FM Test Setup

PROCEDURE

DC FM Center Frequency Accuracy and Stability

26. Connect the RF OUTPUT from the HP 8657D to the INPUT of the frequency counter, and connect the HP 8657D TIME BASE INPUT to the Frequency counter TIME BASE OUTPUT as shown in Figure 4-9.

27. Set the frequency counter as follows:

INPUT CHANNEL A
TRIGGER..... CHANNEL A

28. Set the HP 8657D as follows:

Frequency 100 MHz
Amplitude 0 dBm
Modulation DC FM

29. Set the HP 8657D FM deviation to a value for the frequency range specified in the following table. Verify that the measured frequency does not exceed the limits specified.

Frequency (MHz)	DC FM Deviation(kHz)	Accuracy	Stability
		Offset(kHz)	Drift(Hz/Hr)
0.1 to 130	1 to 99	±500 Hz	±10
130 to 260	1 to 50	±125 Hz	±10
260 to 520	1 to 99	±250 Hz	±10
520 to 1040	1 to 99	±500 Hz	±10

PULSE MODULATION

Description

The output of the HP 8657D is coupled to an oscilloscope and the Rise/Fall Time of the RF pulses is measured. The output of the HP 8657D is then coupled to a spectrum analyzer and the On/Off Level Ratio of the RF pulses is measured.

Equipment

Oscilloscope	HP 54100A
Oscilloscope Probe	HP 54002A
Pulse Generator	HP 8116A
Spectrum Analyzer	HP 8562A

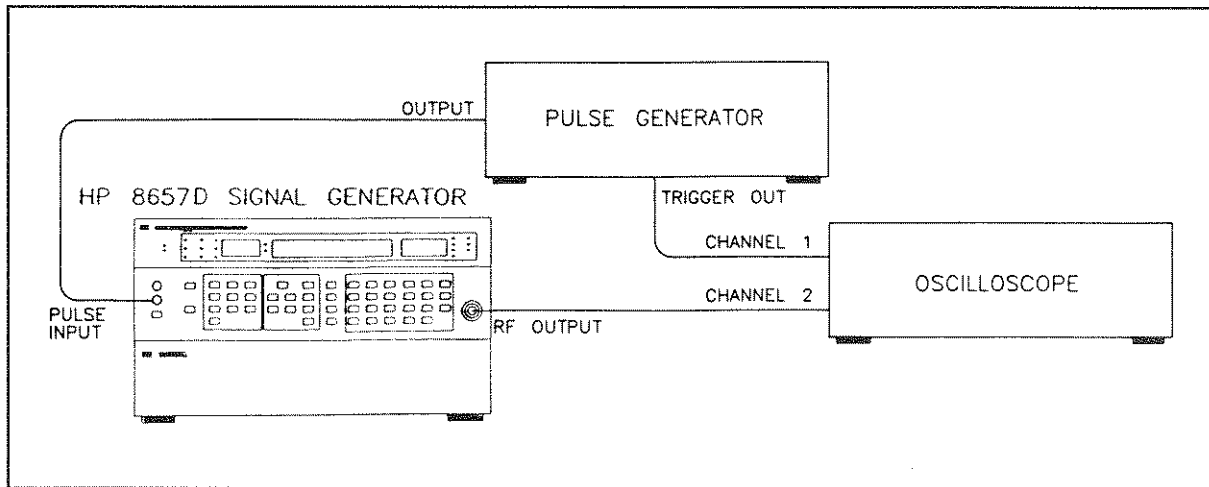

Figure 4-10. Modulation Test Setup

PROCEDURE

30. Connect the equipment as shown in Figure 4-10.

31. Set the HP 8657D as follows:

Frequency	See Table
Amplitude	0 dBm
Modulation	Pulse

32. Set the Pulse Generator as follows:

Mode	Normal
Function	Pulse
Frequency	50 kHz
Amplitude	2 Volts
Amplitude Offset	1 Volt
Pulse Width	10 μ sec
Output Disable	Off (LED Off)

33. Set the Oscilloscope as follows:

Timebase
 Sec/Div 10 ns
 Delay 100 ns
 Delay Reference Center
 Sweep Triggered

Trigger
 Mode Edge
 Source Chan 2
 Trigger Level 1.25 V
 Slope Pos

Display
 Mode Normal
 Display Time (Persistence) 2 sec
 Split Screen Off
 Graticle Grid

Channel 1
 Mode Normal
 Display On
 Volts/Div 100 mV
 Offset 0 V

Channel 2
 Mode Normal
 Display Off
 Volts/Div 500 mV
 Offset 1.25 V

Delta V
 VMarkers On/Chan1
 Marker 1 Position 0 Volt (To Start)
 Marker 2 Position To Maximum Settled Level

After positioning markers to initial position, press 10%-90%

Delta T
 TMarkers On
 Start Marker (see Figure 11) At 10% Level Pulse Crossing
 Stop Marker (see Figure 11) At 90% Level Pulse Crossing

Pulse Modulation Rise and Fall Time (Using an Oscilloscope)

NOTE

Figure 4-11 shows the RF Pulse as displayed on the oscilloscope. The Delta V markers are the approximate 10 and 90% Levels of the pulse envelope. The reading Δt is the Rise Time.

Figure 4-11. Oscilloscope Display

NOTE

If the oscilloscope does not have adequate bandwidth at the higher frequencies, proceed with the following steps using a crystal detector.

34. Set the HP 8657D to the frequencies shown in the following Table. For each frequency, measure the 10% to 90% Rise Time of the RF Pulse. The Delta V and Delta T Markers require repositioning after each frequency change. Measuring Fall Time requires a Delay of $\approx +10 \mu\text{sec}$ minimum on the oscilloscope to view the trailing edge of the pulse (including markers). Refer to Figure 4-11 for an example of the oscilloscope measurement display. The Rise and Fall Time should be within the limits shown in the Table.

Frequency MHz	Results		
	Rise Time Actual	Fall Time Actual	Max
100	_____	_____	<35ns
300	_____	_____	<35 ns
500	_____	_____	<35 ns
1040	_____	_____	<35ns

Pulse Modulation Rise and Fall Time (Using a Crystal Detector)

Additional Equipment

Crystal Detector (Negative)	HP 423A
Crystal Detector (Positive).....	HP 423A Opt. 003
Power Splitter	HP 11667A
15 MHz Low Pass Filter (2 Required)	(See Figure 4-13)

35. Connect the equipment as shown in Figure 4-12. Low Pass Filters can be constructed using the schematic in Figure 4-13.
36. Set the HP 8657D to the frequencies shown in the Table. For each frequency measure the 10 % and 90 % Rise and Fall Times of the RF Pulse. The waveform on the oscilloscope now is the peak-detected envelope . The Rise and Fall Time should be within the limits shown in the Table. The oscilloscope setups are the same as in step 33.

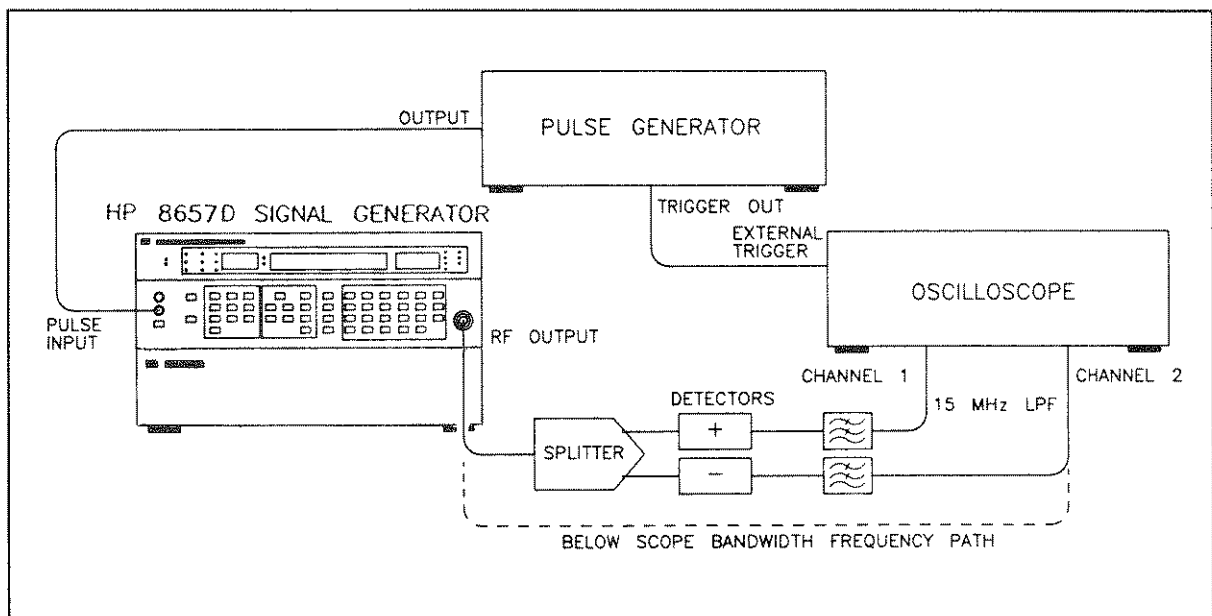

Figure 4-12. Rise/Fall Time Test Setup with Peak Detectors

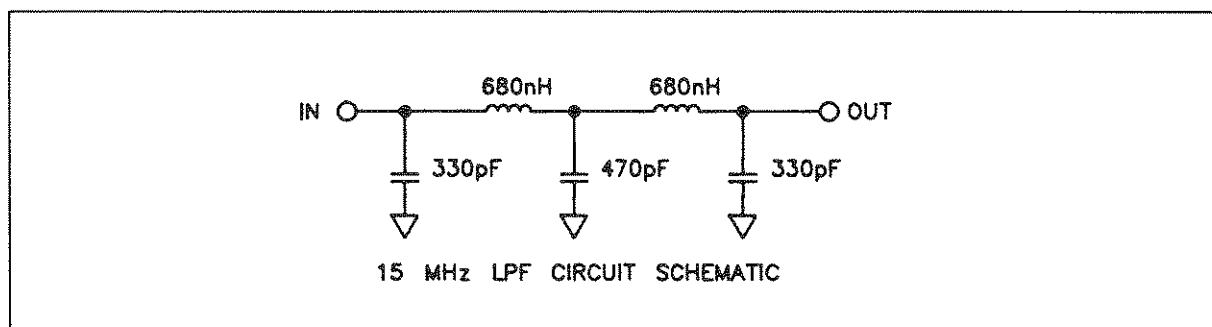

Figure 4-13. Schematic for 15 MHz Low Pass Filters

Pulse Modulation ON/OFF Ratio

37. Set the HP 8657D as follows:

Frequency	See Table
Amplitude	0 dBm
Modulation	Pulse

38. Connect the equipment as shown in Figure 4-14.

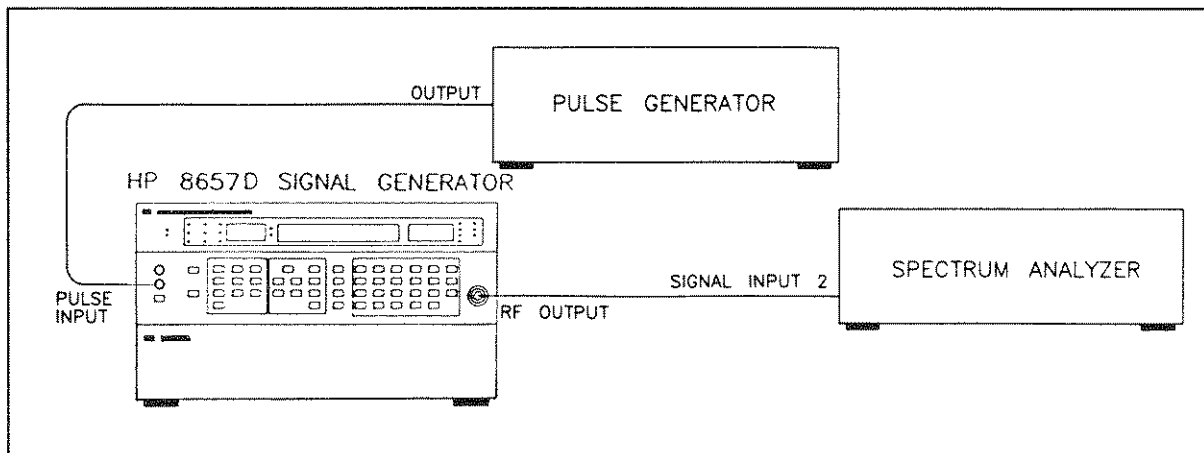

Figure 4-14. Pulse On/Off Ratio Test Setup

39. Set the pulse generator as follows:

Mode	Normal
Frequency	100 Hz
Function	Squarewave
Duty Cycle	50%
Amplitude	1 Volt
Offset	1 Volt

40. Set the spectrum analyzer as follows:

Center Frequency	See Table
Resolution BW	10 kHz
Video BW	1 MHz
Frequency Span	0 Hz
Reference Level	0 dBm
Reference Level/div	10 dB/div
Trigger	Video

41. Set the HP 8657D's frequency and the spectrum analyzer's center frequency to the frequencies shown in the following Table. For each frequency measure the change in amplitude as the HP 8657D is pulsed on and off. The amplitude should drop at least 70 dB for frequencies below 1040 MHz, and 50 dB for frequencies within 1420 to 1540 MHz ($\pi/4$ DQPSK mode) as the HP 8657D is pulsed on and off.

Frequency MHz	Results	
	On/Off Ratio Actual	Min
100	_____	>70 dB
300	_____	>70 dB
500	_____	>70 dB
1040	_____	>70 dB
1480 ¹	_____	>50 dB
(1) $\pi/4$ DQPSK mode.		

$\pi/4$ DQPSK MODULATION

Description

To check Error Vector Magnitude and I/Q Origin Offset, the generator is configured to modulate a random bit pattern in the $\pi/4$ DQPSK format. (The modulation symbol clock is nominally 24.3 kHz and the RF is not pulsed.) The signal is then demodulated by a system designed to decode and measure signals in the $\pi/4$ DQPSK format.

Equipment

Multifunction Synthesizer..... HP 8904A Option 002
 RF Signal Generator..... HP 8656B, HP 8657A, or HP 8657B

$\pi/4$ DQPSK Demodulation System Components:

$\pi/4$ DQPSK Measurement Software..... HP 11847A
 Computer with 4 MByte RAM, BASIC 6.0, and HP-IB* HP Series 300 Compatible
 Digitizer HP 70700A
 Downconverter HP 70912A
 Graphics Display (Optional) HP 70205A or HP 70206A
 HP-IB Printer (Optional)..... ThinkJet or equivalent HP-IB
 System Mainframe HP 70001A

* Run time can be significantly decreased by using the following:
 Series 300 Controller with a 68020 or 68030 CPU and a 68881 or 68882 math co-processor.

PROCEDURE

Error Vector Magnitude and I/Q Origin Offset

Initial Setup

42. Note the following, and connect the equipment as shown in figure 4-15.

- Connect the time bases of all instruments together; any one of the references can serve as the master reference. Connect the 10 MHz time base to the CLK IN input on the rear panel of the digitizer.
- HP-IB cables need only be connected to the HP 70001A Mainframe, RF Signal Generator, and the computer peripherals. Do not connect HP-IB cables to the HP 8657D or the multifunction synthesizer.
- *There is no connection to the front-panel input to the digitizer.*

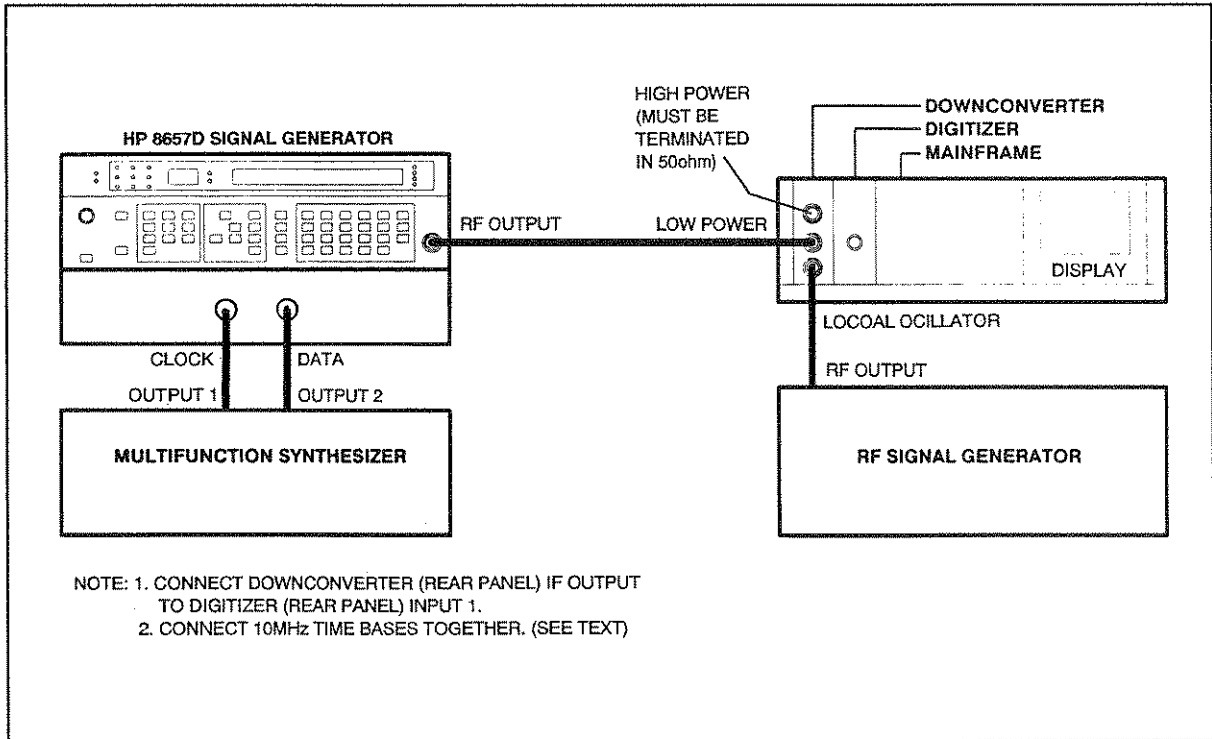

Figure 4-15. $\pi/4$ DQPSK Modulation Test Setup

43. Set the test Signal Generator (HP 8657D) as follows:

- Frequency 900.0 MHz
- Amplitude +7 dBm
- Modulation $\pi/4$ DQPSK
- Filter (for North American cellular only) 0.35
- Filter (for Japanese cellular only) 0.5

44. Set the Multifunction synthesizer as follows:

PRESET the Multifunction Synthesizer.

- OUTPUT 1 (for North American cellular only) 24.3 kHz sinewave at 3 V (pk)
- OUTPUT 1 (for Japanese cellular only) 21.0 kHz sinewave at 3 V (pk)

OUTPUT 2 86.0 kHz sinewave at 3 V (pk)

Comments:

- DO NOT float OUTPUT 1 or OUTPUT 2.
- For minimum phase jitter on the HP 8904A, a sinewave is necessary.
- The 86.0 kHz data gives a random number of zero crossings referenced to the symbol clock.
- An HP 8657B is required to test the frequency band of 1420 to 1540 MHz.

45. The Local Oscillator (reference signal generator) is set by the computer software.

Running the Program

46. Load and run the HP 11847A $\pi/4$ DQPSK Measurement Software.

NOTE

Use the program's **Help** softkey as needed to obtain more detailed instructions on operating the system. This softkey is available most of the time.

If a printer is available, the screen contents may be printed by pressing the **Dump Graph** softkey when shown.

47. From the main menu screen, press the **Config** softkey.
48. If your local oscillator is not the signal generator specified, use the TAB key or scroll to LOCAL OSCILLATOR, then use the LEFT/RIGHT ARROW keys to select a signal generator model.
49. Exit the CONFIG screen by pressing the **Exit** softkey.
50. Press the **Select Options** softkey. Compare the screen to figure 4-16 and change any differences to match. Press the **Done** softkey when finished.

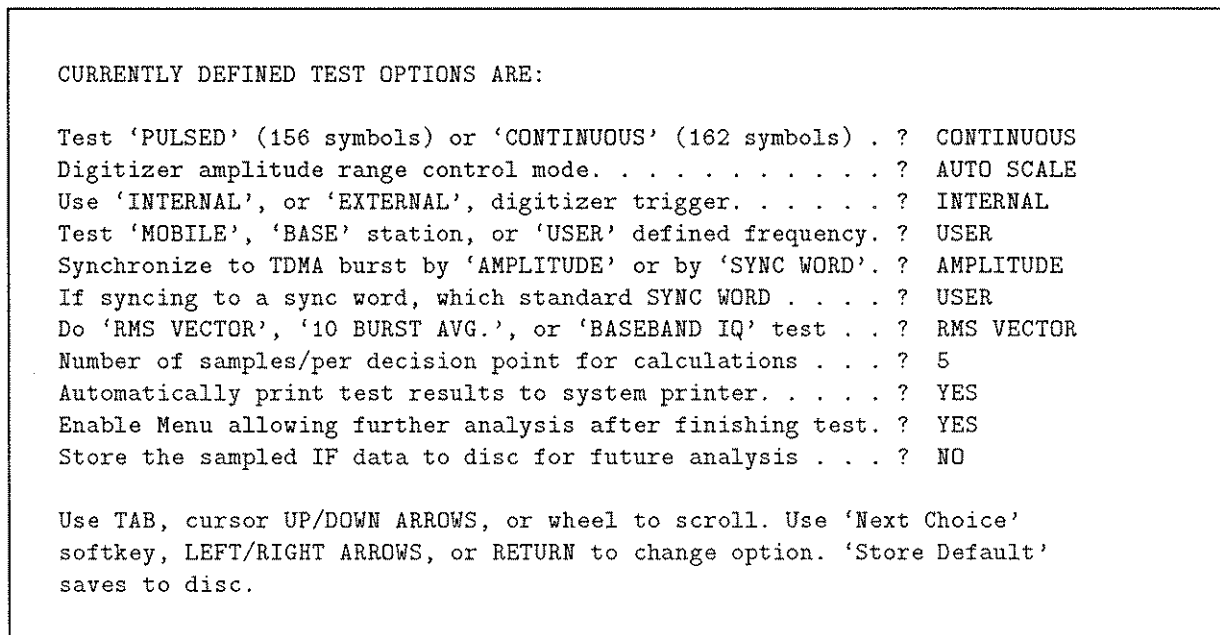

Figure 4-16. Select Options Screen

51. Press the **Run Test** softkey. When the "Enter desired test frequency" prompt appears, key in 900 and press the **Enter** or **Return key**.
52. When the "Connect as shown" prompt appears, verify the setup connections, then press the **Cont** softkey.
53. The test should run until the test results appear on the screen, with one exception:
- If a "WARNING: Check the signal amplitude" message appears, the level of the RF signal generator (going to the downconverter's low-power input) should be altered until the specified signal level is within 0 to 3 dB below its range. (Press the **Try Again** softkey to

rerun this part of the test.) If changing amplitude a few dB has little effect, check the signal level of all three signal sources and their connections in the test setup.

54. If a printer is connected, the test results may be printed by pressing the **Print Results** softkey.
55. Run the test at any additional frequencies shown in the table below:
 - a. Set the 8657D to any frequency within one of the three frequency bands.
 - b. Set the amplitude for that frequency band.
 - c. Repeat steps 46 through 55 until all desired tests have been run.
56. Record the Error Vector Magnitude values in the table below. Record the I/Q Origin Offset value in the space provided.

Error Vector Magnitude (15°C to 35°C)		
Frequency Band (MHz)	Maximum Value	
	Output Level (dBm)	Error (%)
10 to 129.9	+3	_____ ≤ 4
810 to 965	+7	_____ ≤ 3.5
1420 to 1540	+3	_____ ≤ 4

I/Q Origin Offset _____ ≤ -35 dB

Performance Test 4

OUTPUT LEAKAGE TESTS

Specification

Leakage limits are within those specified in MIL STD 461B, and FTZ 1115. Furthermore, less than 1.0 μV is induced in a two-turn, 2.5 cm (1 inch) diameter loop held 2.5 cm (1 inch) away from the front surface and measured into a 50 Ω receiver.

Description

Output leakage is verified by holding a loop antenna 2.5 cm (1 inch) from the front surface of the HP 8657D and measuring the resulting signal with a spectrum analyzer.

The loop antenna is suspended in a molding so that when the molding is in contact with a surface, the loop antenna is one inch from the surface.

NOTE

The use of a screen room may be necessary to reduce external radiated interference.

Equipment

One-Inch Loop Antenna	HP 08640-60501
26 dB Amplifier	HP 8447D
Spectrum Analyzer	HP 8562B
50 Ω Termination	HP 908A

PROCEDURE

1. Connect equipment as shown in Figure 4-17, for the signal path shown as 1-4.

NOTE

To avoid disturbing the antenna's field and causing measurement error, grasp the antenna at the end that has the BNC connector.

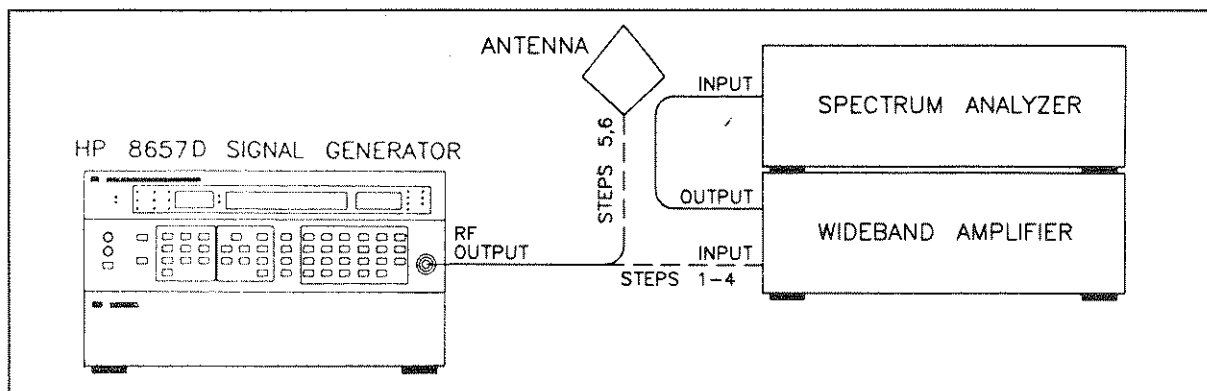

Figure 4-17. Output Leakage Test Setup

2. Set the HP 8657D as follows:

Frequency 100 MHz
 Amplitude -107 dBm
 Modulation Off

3. Set the spectrum analyzer as follows:

Center Frequency 100 MHz
 Input Attenuation -40 dB
 Reference Level -20 dBm
 Frequency Span 20 MHz
 Resolution Bandwidth 10 kHz

4. View the signal on the spectrum analyzer and adjust the reference level controls of the spectrum analyzer to set the amplified -107 dBm signal from the HP 8657D to a reference graticule line on the spectrum analyzer display. Set the video filter to further separate the signal from the noise. Disconnect the HP 8657D from the amplifier, and connect a 50 ohm termination to the HP 8657D's RF OUTPUT connector.

5. Connect the one-inch loop antenna to the analyzer through the amplifier as shown in Figure 4-18, for the signal path shown as 5,6. Hold the end of the loop antenna cylinder in contact with the front surfaces of the HP 8657D. All signals and noise should be below the reference graticule line (i.e., below -107 dBm).

_____ < -107 dBm (<1.0 μV) at 100 MHz

6. Repeat step 5 for frequencies of 300, 500, 700, 900, 990, 1040 MHz.

_____ < -107 dBm (<1.0 μV) at 300 MHz

_____ < -107 dBm (<1.0 μV) at 500 MHz

_____ < -107 dBm (<1.0 μV) at 700 MHz

_____ < -107 dBm (<1.0 μV) at 900 MHz

_____ < -107 dBm (<1.0 μV) at 990 MHz

_____ < -107 dBm (<1.0 μV) at 1040 MHz

Performance Test Record

SPECTRAL PURITY TESTS

Spurious Signals

Spurious Signals	Results	
	Actual	Max.
Harmonics	_____	< -30 dBc, 0.1 to 1040 MHz
Non-Harmonics	_____	< -60 dBc, 0.1 to 1040 MHz
5 kHz to 2 MHz from carrier	_____	< -63 dBc, 0.1 to 130 MHz
	_____	< -75 dBc, 130 to 260 MHz
	_____	< -66 dBc, 260 to 520 MHz
	_____	< -63 dBc, 520 to 1040 MHz
Sub-Harmonics	_____	None, 0.1 to 1040 MHz

Residual AM

The digital multimeter should indicate <4.0 mVrms.

Actual

Residual FM

HP 8657D Frequency (MHz)	Modulation Analyzer Filter		Results (Hz rms)	
	High Pass (Hz)	Low Pass (kHz)	Actual	Max.
0.15 to 129.99999	300	3	_____	< 4
0.15 to 129.99999	50	15	_____	< 6

Optional Residual FM Test

Optional Residual FM Test Specifications

Test HP 8657D Frequency (MHz)	LO Signal Generator Frequency (MHz)	Modulation Analyzer Filter		Results (Hz rms)	
		High Pass (Hz)	Low Pass (kHz)	Actual	Max.
245	246.5	300	3	_____	< 1
410	411.5	300	3	_____	< 2
775	776.5	300	3	_____	< 3
245	246.5	50	15	_____	< 1.5
410	411.5	50	15	_____	< 3
775	776.5	50	15	_____	< 4

SSB Phase Noise

Offset from Carrier	SSB Phase Noise		Carrier Frequency (MHz)
	Min.	Actual	
20 kHz	-124 dBc/Hz	_____	0.1 to 129
	-136 dBc/Hz	_____	130 to 260
	-130 dBc/Hz	_____	260 to 520
	-124 dBc/Hz	_____	520 to 1040

OUTPUT LEVEL ACCURACY AND FLATNESS TESTS

Step the HP 8657D and measuring receiver through the frequency range of 100 kHz to 1040 MHz. Record the highest and lowest power levels and their frequencies and calculate the maximum variation.

_____ Highest Reading _____ Frequency
 _____ Lowest Reading _____ Frequency

The amplitude variation should not exceed 1.0 dB. Record the maximum variation (highest reading – lowest reading).

_____ <1.0 dB

Absolute Level Accuracy – Analog Mode

Step the HP 8657D and measuring receiver through the frequency range of 3 MHz to 1040 MHz. Record the highest and lowest reading to be used in the Absolute Level Accuracy test.

_____ Highest Reading _____ Test Frequency 1
 _____ Lowest Reading _____ Test Frequency 2

RF Output Test Frequency 1 _____

RF Output Test Frequency 2 _____

Amplitude Setting (dBm)	Minimum (dBm)	Actual (dBm)	Maximum (dBm)
+3.0	+2.0	_____	+4.0
-2.0	-3.0	_____	-1.0
-7.0	-8.0	_____	-6.0
-12.0	-13.0	_____	-11.0
-17.0	-18.0	_____	-16.0
-22.0	-23.0	_____	-21.0
-27.0	-28.0	_____	-26.0
-32.0	-33.0	_____	-31.0
-37.0	-38.0	_____	-36.0
-42.0	-43.0	_____	-41.0
-47.0	-48.0	_____	-46.0
-52.0	-53.0	_____	-51.0
-57.0	-58.0	_____	-56.0
-63.0	-63.0	_____	-61.0
-67.0	-68.0	_____	-66.0
-72.0	-73.0	_____	-71.0
-77.0	-78.0	_____	-76.0
-82.0	-83.0	_____	-81.0
-87.0	-88.0	_____	-86.0
-92.0	-93.0	_____	-91.0
-97.0	-98.0	_____	-96.0
-102.0	-103.0	_____	-101.0
-107.0	-108.0	_____	-106.0
-112.0	-113.0	_____	-111.0
-117.0	-118.0	_____	-116.0
-122.0	-123.0	_____	-121.0
-127.0	-128.0	_____	-126.0

Amplitude Setting (dBm)	Minimum (dBm)	Actual (dBm)	Maximum (dBm)
+3.0	+2.0	_____	+4.0
-2.0	-3.0	_____	-1.0
-7.0	-8.0	_____	-6.0
-12.0	-13.0	_____	-11.0
-17.0	-18.0	_____	-16.0
-22.0	-23.0	_____	-21.0
-27.0	-28.0	_____	-26.0
-32.0	-33.0	_____	-31.0
-37.0	-38.0	_____	-36.0
-42.0	-43.0	_____	-41.0
-47.0	-48.0	_____	-46.0
-52.0	-53.0	_____	-51.0
-57.0	-58.0	_____	-56.0
-63.0	-63.0	_____	-61.0
-67.0	-68.0	_____	-66.0
-72.0	-73.0	_____	-71.0
-77.0	-78.0	_____	-76.0
-82.0	-83.0	_____	-81.0
-87.0	-88.0	_____	-86.0
-92.0	-93.0	_____	-91.0
-97.0	-98.0	_____	-96.0
-102.0	-103.0	_____	-101.0
-107.0	-108.0	_____	-106.0
-112.0	-113.0	_____	-111.0
-117.0	-118.0	_____	-116.0
-122.0	-123.0	_____	-121.0
-127.0	-128.0	_____	-126.0

Absolute Level Accuracy – $\pi/4$ DQPSK Mode

Step the HP 8657D and measuring receiver through the three digital frequency ranges:

- 10 to 129.9 MHz
- 810 to 965 MHz
- 1420 to 1540 MHz

Amplitude Setting (dBm)	Minimum (dBm)	Actual (dBm)	Maximum (dBm)
+3.0	+2.0	_____	+4.0
-2.0	-3.0	_____	-1.0
-7.0	-8.0	_____	-6.0
-12.0	-13.0	_____	-11.0
-17.0	-18.0	_____	-16.0
-22.0	-23.0	_____	-21.0
-27.0	-28.0	_____	-26.0
-32.0	-33.0	_____	-31.0
-37.0	-38.0	_____	-36.0
-42.0	-43.0	_____	-41.0
-47.0	-48.0	_____	-46.0
-52.0	-53.0	_____	-51.0
-57.0	-58.0	_____	-56.0
-63.0	-63.0	_____	-61.0
-67.0	-68.0	_____	-66.0
-72.0	-73.0	_____	-71.0
-77.0	-78.0	_____	-76.0
-82.0	-83.0	_____	-81.0
-87.0	-88.0	_____	-86.0
-92.0	-93.0	_____	-91.0
-97.0	-98.0	_____	-96.0
-102.0	-103.0	_____	-101.0
-107.0	-108.0	_____	-106.0
-112.0	-113.0	_____	-111.0
-117.0	-118.0	_____	-116.0
-122.0	-123.0	_____	-121.0
-127.0	-128.0	_____	-126.0

AC MODULATION

AM Indicator Accuracy

MHz	AM Depth	Results		
		Min.	Actual	Max.
100	10%	7.4%	_____	12.6%
	30%	26.2%	_____	33.8%
	70%	63.8%	_____	76.2%
	90%	82.6%	_____	97.4%
240	10%	7.4%	_____	12.6%
	30%	26.2%	_____	33.8%
	70%	63.8%	_____	76.2%
	90%	82.6%	_____	97.4%
400	10%	7.4%	_____	12.6%
	30%	26.2%	_____	33.8%
	70%	63.8%	_____	76.2%
	90%	82.6%	_____	97.4%
990	10%	7.4%	_____	12.6%
	30%	26.2%	_____	33.8%
	70%	63.8%	_____	76.2%
	90%	82.6%	_____	97.4%
1040	10%	7.4%	_____	12.6%
	30%	26.2%	_____	33.8%
	70%	63.8%	_____	76.2%
	90%	82.6%	_____	97.4%

Incidental Phase Modulation

HP 8657D Frequency		Result	
Min.	Max.	Actual	Max.
150 kHz	1300 MHz	_____	< 0.3 radian peak

AM Distortion

MHz	AM Depth	Results < 1040 MHz	
		Actual	Max.
100	30%	_____	< 1.5%
	70%	_____	< 3.0%
	90%	_____	< 4.0%
240	30%	_____	< 1.5%
	70%	_____	< 3.0%
	90%	_____	< 4.0%
400	30%	_____	< 1.5%
	70%	_____	< 3.0%
	90%	_____	< 4.0%
990	30%	_____	< 1.5%
	70%	_____	< 3.0%
	90%	_____	< 4.0%
1040	30%	_____	< 1.5%
	70%	_____	< 3.0%
	90%	_____	< 4.0%

FM Indicator Accuracy

FM Deviation for 100 MHz	Results		
	Min.	Actual	Max.
5.0 kHz	4.75 kHz	_____	5.25 kHz
30.0 kHz	28.50 kHz	_____	31.50 kHz
70.0 kHz	66.50 kHz	_____	73.50 kHz
99.0 kHz	94.05 kHz	_____	103.95 kHz

Incidental AM

HP 8657D Frequency		Result	
Min.	Max.	Actual	Max.
10 MHz	1040 MHz	_____	< 0.1%

FM Distortion

FM Deviation		Result	
Min.	Max.	Actual	Max.
6 kHz	99 kHz	_____	<0.5%

DC MODULATION

DC FM Center Frequency Accuracy And Stability

Frequency (MHz)	DC FM Deviation(kHz)	Accuracy	Stability
		Offset(kHz)	Drift(Hz/Hr)
0.1 to 130	1 to 99	_____ ±500 Hz	_____ ±10
130 to 260	1 to 50	_____ ±125 Hz	_____ ±10
260 to 520	1 to 99	_____ ±250 Hz	_____ ±10
520 to 1040	1 to 99	_____ ±500 Hz	_____ ±10

Pulse Modulation Rise and Fall Time

Frequency MHz	Results		
	Rise Time Actual	Fall Time Actual	Max
100	_____	_____	<35 ns
300	_____	_____	<35 ns
500	_____	_____	<35 ns
1040	_____	_____	<35 ns

Pulse Modulation ON/OFF Ratio

Frequency MHz	Results	
	On/Off Ratio Actual	Min
100	_____	>70 dB
300	_____	>70 dB
500	_____	>70 dB
1040	_____	>70 dB
1480 ¹	_____	>50 dB

(1) $\pi/4$ DQPSK mode.

$\pi/4$ DQPSK MODULATION

Error Vector Magnitude and I/Q Origin Offset

Error Vector Magnitude (15°C to 35°C)		
Frequency Band (MHz)	Maximum Value	
	Output Level (dBm)	Error (%)
10 to 129.9	+3	_____ \leq 4
810 to 965	+7	_____ \leq 3.5
1420 to 1540	+3	_____ \leq 4

I/Q Origin Offset _____ \leq -35 dB

OUTPUT LEAKAGE TESTS

Test for frequency of 100 MHz.

_____ $<$ -107 dBm ($<$ 1.0 μ V) at 100 MHz

Test for frequencies of 300, 500, 700, 900, 990, 1040 MHz.

_____ $<$ -107 dBm ($<$ 1.0 μ V) at 300 MHz

_____ $<$ -107 dBm ($<$ 1.0 μ V) at 500 MHz

_____ $<$ -107 dBm ($<$ 1.0 μ V) at 700 MHz

_____ $<$ -107 dBm ($<$ 1.0 μ V) at 900 MHz

_____ $<$ -107 dBm ($<$ 1.0 μ V) at 1040 MHz

Section 5 ADJUSTMENTS

5-1. INTRODUCTION

This section contains adjustments that assure peak performance of the HP 8657D $\pi/4$ DQPSK Signal Generator. The HP 8657D should be readjusted after repair or failure to pass a performance test. Allow a 30-minute warm-up prior to performing the adjustments. Each adjustment includes test setups and diagrams where applicable.

Adjustments 1 through 23 apply to the upper unit only. Removal of the lower unit ($\pi/4$ DQPSK Modulator Assembly) and top and bottom covers is required. To access the power supply adjustment locations, removal of the rear panel is required.

Adjustment location diagrams and disassembly instructions are provided at the end of this section. Assembly/Disassembly Instructions for removing the $\pi/4$ DQPSK Modulator Assembly are provided in Section 2.

Adjustment 24 applies to the lower unit ($\pi/4$ DQPSK Modulator Assembly) only. Adjustment 24 can be performed while the lower unit is separated from the upper unit. Removal of top and bottom covers is not required.

To determine which performance tests and adjustments to perform after a repair, refer to Table 5-2, Post-Repair Adjustments.

5-2. SAFETY CONSIDERATIONS

Refer to the Safety Considerations page found at the beginning of this manual for a summary of the safety information.

5-3. EQUIPMENT REQUIRED

All adjustment procedures contain a list of required test equipment. The test equipment is also identified by callouts in the test setup diagrams, where included. If substitutions must be made for the specified test equipment, refer to the Recommended Test Equipment table in Section 1 of this manual for the minimum specifications. It is important that the test equipment meet the critical specifications listed in the table if the HP 8657D is to meet its performance requirements.

5-4. FACTORY-SELECTED COMPONENTS

Factory-selected components are identified on the schematics and parts lists by asterisk (*) which follows the reference designator. The nominal value or range of the components is shown. Manual Update pages provide updated information pertaining to selected components. Table 5-1 lists the reference designator, selection criteria, the nominal value range, and the service sheet where the component is shown.

5-5. POST-REPAIR ADJUSTMENTS

Table 5-2 lists the adjustments related to repairs or replacement of the assemblies listed.

5-6. RELATED ADJUSTMENTS

The procedures in this section can be done in any order; however, it is suggested that the power supply voltage, reference voltage, and audio oscillator adjustments be performed first. Changes in these adjustments can affect other adjustments, especially level and modulation accuracies.

WARNING

Maintenance described herein is performed with power supplied to the instrument, and protective covers removed. Such maintenance should be performed only by service-trained personnel who are aware of the hazards involved (for example, fire and electrical shock). Where maintenance can be performed without power applied, the power should be removed.

Table 5-1. Factory Selected Components

Reference Designator	Service Sheet	Range of Values	Basis of Selection
A3C23	16	33 pF to 47 pF	Select capacitor so that the output level of the 50 MHz Reference Oscillator can be adjusted to greater than +17 dBm.
A3L6	16	680 nH or 470 nH	Select inductor so that the 50 MHz crystal can be tuned to 50 MHz \pm 1250 Hz using an external reference.
A3R303	11	3.16k to 4.64k	Nominal value 3.16k. Select alternate values (3.48k or 4.64k) to insure correct operation of Fractional-N IC (A3U17).
A4C155	1	10 pF to 33 pF	Decrease the value of C155 if the 520-1040 MHz oscillator fails to oscillate at 520 MHz only. Increase C15's value if spurs are present at half the fundamental frequency from 520-1040 MHz.
A6C232	4	0 or 1.8 pF	Removed to eliminate spurs at 1200 to 1400 MHz when the RF OUTPUT is 600 MHz to 700 MHz.
A8C5	3	47 pF to 82 pF	Select A8C5 to maximize DC voltage measured at J2 pin 4.
A8C19	3	20 pF to 39 pF	Select A8C19 to maximize DC voltage measured at J2 pin 6.
A8C40	3	0 or 1000 pF	Selected to eliminate a spurious signal at 700 MHz.

Table 5-2. Post-Repair Adjustments

Assembly Repaired or Replaced	Reference Service Sheet No.	Related Adjustments
A3	10 - 16	5,6,7,14,15,17,18,19,20
A3A1	9	7,14,16,17,18
A4	1 - 2	10,11
A6	4 - 5	12,13
A8	3	8,9
A11	6 - 7	2,3,4,12,13,19,20,21,22
A14	24	1
A16	17	23
A18A1	BD1	24
A18A3	BD1	24
FL1	3	9,10

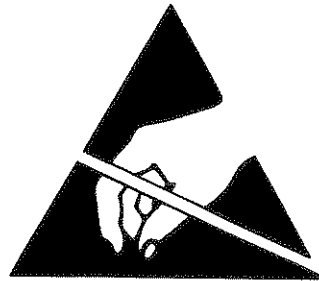

**ATTENTION
Static Sensitive
Devices**

When handling equipment containing static sensitive devices, adequate precautions must be taken to prevent device damage or destruction. Only those who are thoroughly familiar with industry accepted techniques for handling static sensitive devices should attempt to service circuitry with these devices.

Adjustment 1

POWER SUPPLY VOLTAGE ADJUSTMENTS

- Service Sheets 10 and 24.

Description

The power supplies are adjusted at A13J2 using a digital multimeter.

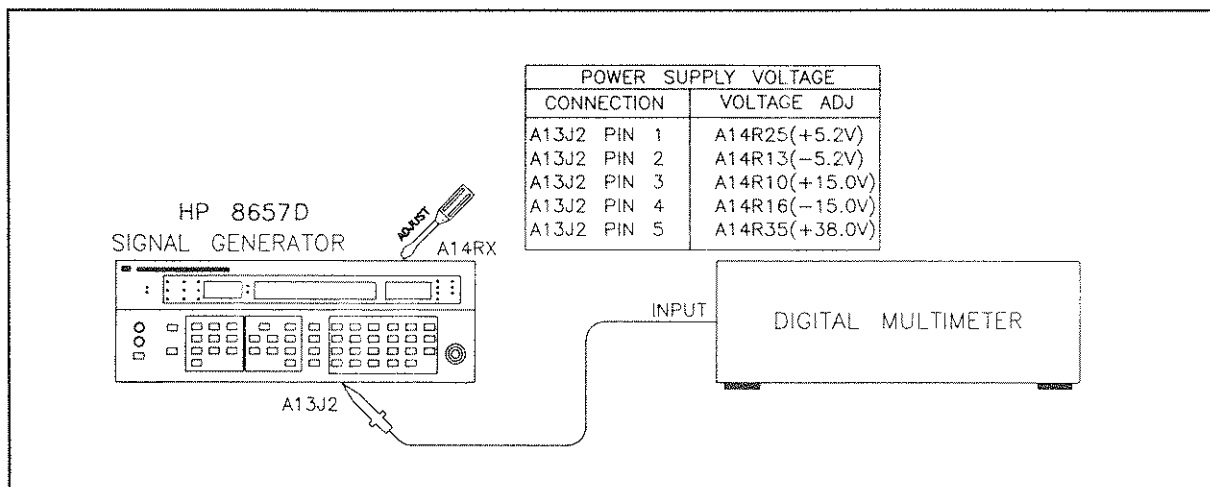

Figure 5-1. Power Supplies Adjustment Setup

Equipment

Digital Multimeter..... HP 3466A

Procedure

- Set the digital multimeter as follows:

Function	Vdc
Range	20V
- Preset the HP 8657D by pressing SHIFT and 0.
The front panel will display 100 MHz, -143.5 dBm.
- Connect the digital multimeter to A13J2 pin 1. Adjust A14R25 (+5.2V ADJ) for a reading of +5.2 Vdc \pm 0.02 Vdc on the digital multimeter.
- Connect the digital multimeter to A13J2 pin 2. Adjust A14R13 (-5.2V ADJ) for a reading of -5.2 Vdc \pm 0.02 Vdc on the digital multimeter.
- Connect the digital multimeter to A13J2 pin3. Adjust A14R10 (+15.0V ADJ) for a reading of +15.0 Vdc \pm 0.1 Vdc on the digital multimeter.
- Connect the digital multimeter to A13J2 pin4. Adjust A14R16 (-15.0V ADJ) for a reading of -15.0 Vdc \pm 0.1 Vdc on the digital multimeter.
- Set digital multimeter Range to 200 V. Connect the digital multimeter to A13J2 pin 5. Adjust A14R35 (+38.0V ADJ) for a reading of +38.0 Vdc \pm 0.3 Vdc on the digital multimeter.

Adjustment 2

REFERENCE VOLTAGE ADJUSTMENT

• Service Sheet 6

Description

The +2 Vdc reference is adjusted for +2.000 Vdc \pm 0.004 Vdc using a digital multimeter.

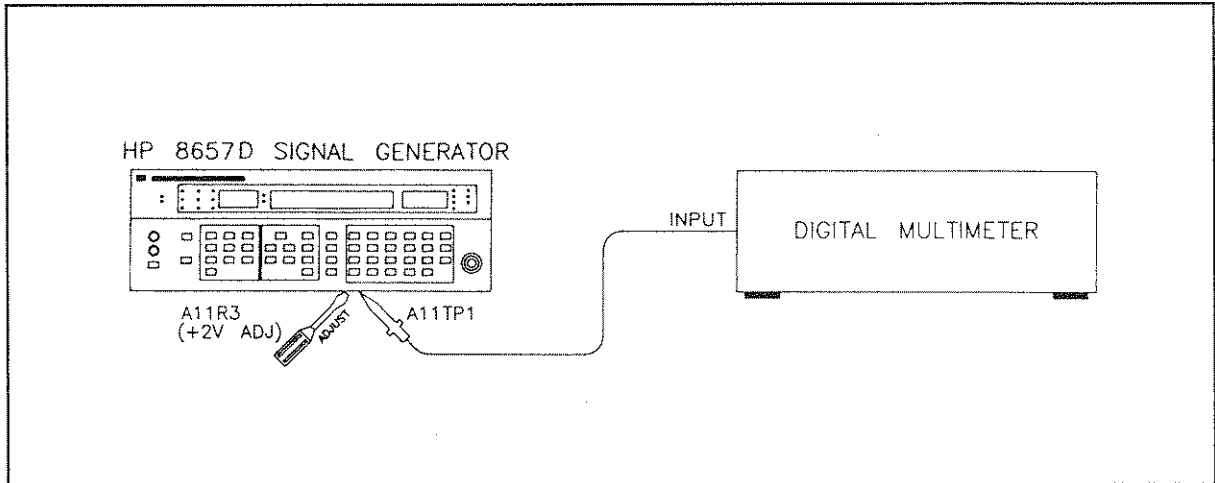

Figure 5-2. +2 Vdc Reference Adjustment Setup

Equipment

Digital Multimeter..... HP 3466A

Procedure

1. Set the digital multimeter as follows:
 - Function Vdc
 - Range 20V
2. Preset the Signal Generator by pressing SHIFT followed by 0.
3. Connect the digital multimeter to A11TP1 and adjust A11R3 (+2V ADJ) for a reading of 2.000 Vdc \pm 0.004 Vdc on the digital multimeter.

Adjustment 3

AUDIO OSCILLATOR LEVEL ADJUSTMENT

- Service Sheet 7

Description

The internal 1 kHz modulation source is adjusted to $0.707 \text{ V}_{\text{rms}} \pm 0.007 \text{ V}_{\text{rms}}$ at A11TP2 (OSC). Then, the internal 400 Hz modulation source is checked to ensure that it is within the same limits.

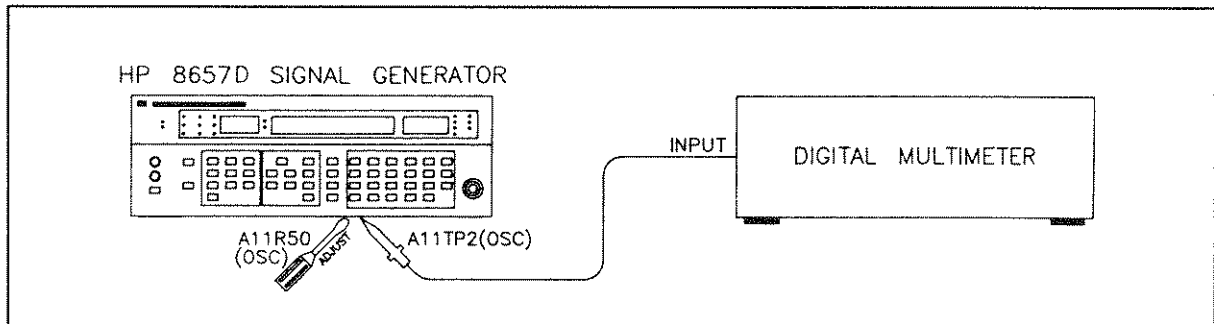

Figure 5-3. Audio Oscillator Level Adjustment Setup

Equipment

Digital Multimeter HP 3466A

Procedure

- Set the digital multimeter as follows:

Function	Vac
Range	2V
- Set the HP 8657D as follows:

Frequency	Any
Amplitude	Any
Modulation	AM
Source	1 kHz
- Connect the digital multimeter to A11TP2 (OSC) and adjust A11R50 (OSC) for a $0.707 \text{ V}_{\text{rms}} \pm 0.007 \text{ V}_{\text{rms}}$ reading on the digital multimeter.
- Select the internal 400 Hz modulation source. Check that the 400 Hz oscillator level is within $0.707 \text{ V}_{\text{rms}} \pm 0.007 \text{ V}_{\text{rms}}$. If it is not, repeat step 3 until both readings are within the specified limits.

Adjustment 4

AM OFFSET ADJUSTMENT

- Service Sheet 7

Description

The dc offset of the AM Offset Buffer is adjusted for 0.000 Vdc \pm 0.001 Vdc at A11TP6 (AM) with the reference inputs to the Level DAC and AM% DAC grounded, and the digital input to each programmatically set to zero.

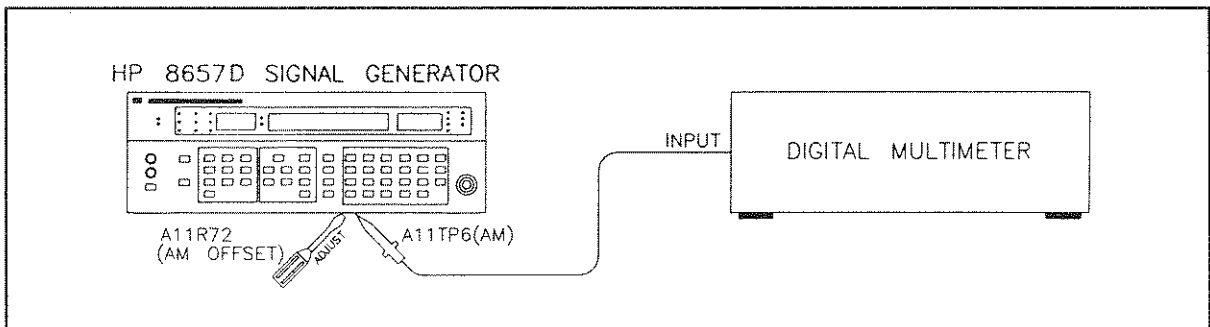

Figure 5-4. AM Offset Adjustment Setup

Equipment

Digital Multimeter..... HP 3466A

Procedure

1. Set the digital multimeter as follows:
 - Function Vdc
 - Range 200 mV
2. Reset the HP 8657D by pressing SHIFT and 0.
3. Move A11 W2 to its alternate position and short A11 TP5 to ground.
4. Connect the digital multimeter to A11TP6 (AM) and adjust A11R72 (AM OFFSET) for 0.000 Vdc \pm 0.001 Vdc.
5. Remove all shorts and return all jumpers to their original positions.

Adjustment 5

50 MHZ REFERENCE OSCILLATOR LEVEL ADJUSTMENT

- Service Sheet 16

Description

The output power level of the 50 MHz Reference Oscillator is adjusted for a maximum level between +16 and +19 dBm at A3J8 using a measuring receiver.

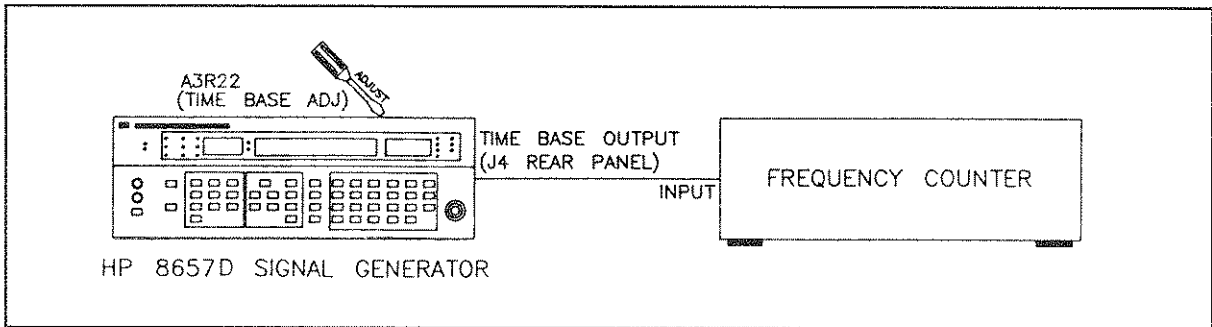

Figure 5-5. 50 MHz Reference Oscillator Level Adjustment Setup

Equipment

Measuring Receiver.....	HP 8902A
Sensor Module.....	HP 11722A
Cable BNC(m) to SMC(f).....	HP 08662-60075
Adapter N(f) to BNC(m).....	HP 1250-0077
Adapter BNC(f) to BNC(f).....	HP 1250-0080

Procedure

1. Set the measuring receiver with the sensor module precalibrated and connected as follows:

Measurement	RF POWER
Display	LOG
2. Disconnect coaxial cable W5 from A3J8 (50 MHz Reference Oscillator output). Connect the sensor module to A3J8 using the appropriate cable and adapters.
3. Press the FREQ key on the measuring receiver for calibration, then press the RF POWER key.
4. Adjust A3C21 (50 MHZ LEVEL ADJ) for a maximum RF Power reading from +16 dBm to +19 dBm. Do not adjust for a reading greater than +19 dBm.

NOTE

Do not remove the 50 MHz Section covers for this adjustment.

5. Disconnect the measuring receiver and reconnect W5 to A3J8.

Adjustment 6

50 MHZ REFERENCE OSCILLATOR FREQUENCY ADJUSTMENT

- Service Sheet 16

Description

The internal 50 MHz Reference Oscillator frequency is adjusted to 50.0000 MHz \pm 100 Hz by adjusting the TIME BASE OUTPUT for 10.000 000 MHz \pm 20 Hz (50 MHz reference divided-by-10) using a frequency counter.

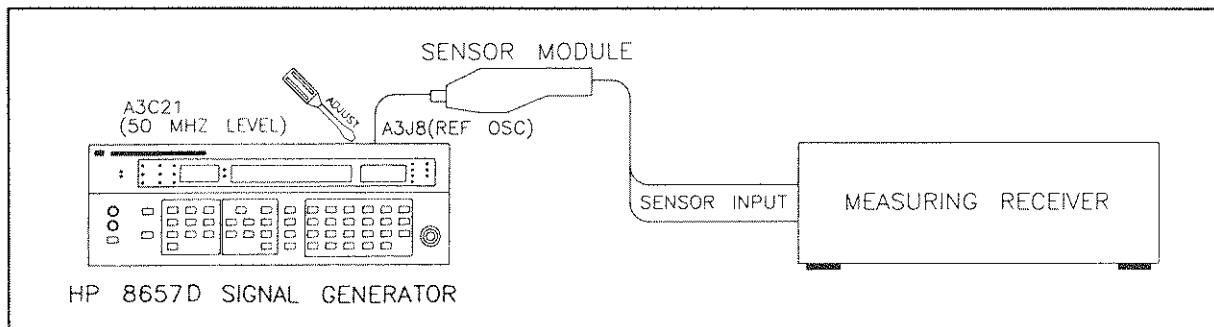

Figure 5-6. 50 MHz Reference Oscillator Frequency Adjustment Setup

Equipment

Frequency Counter	HP 5328B
Cable BNC(m)	HP 10503A

NOTE

If the HP 8657D has Option 001 installed, disconnect the coaxial looping cable from the rear-panel TIME BASE INPUT connector.

Procedure

1. Connect the frequency counter to J4 using the BNC cable.
2. Adjust A3R22 (TIME BASE ADJ) for a frequency counter reading of 10.000 000 MHz \pm 20 Hz.

Adjustment 7

122 MHz HARMONIC ADJUSTMENT

- Service Sheet 9

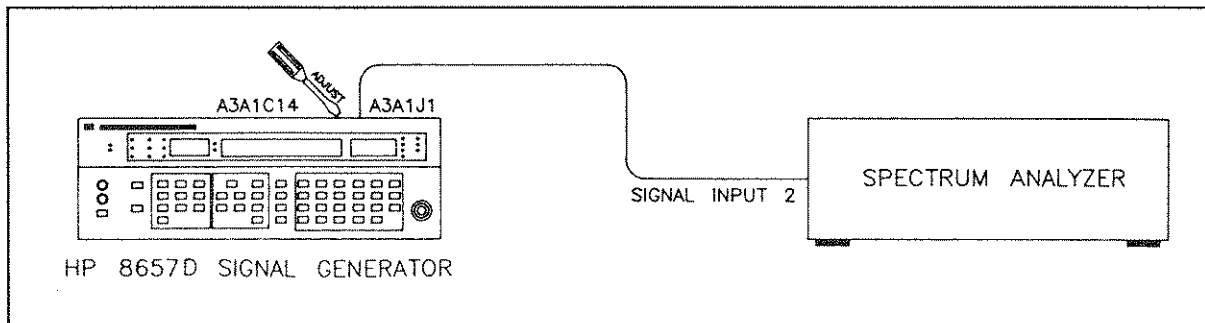

Figure 5-7. 122 MHz Harmonic Adjustment Setup

Description

The HP 8657D frequency is set to 539 MHz for a Low Frequency VCO Frequency of 61 MHz. The 122 MHz Harmonic is adjusted for a minimum.

Equipment

Spectrum Analyzer	HP 8562A
Cable BNC(m) to SMC(f)	HP 08662-60075
Adapter N(f) to BNC(m)	HP 1250-0077

Procedure

- Set the spectrum analyzer as follows:

Frequency (Center)	95 MHz
Span (Frequency)	100 MHz
Amplitude (Reference Level)	0 dBm
- Set the HP 8657D as follows:

Frequency	539 MHz
Amplitude	Any
Modulation	Off
- Connect the output of the A3A1 Assembly at A3A1J1 to the spectrum analyzer SIGNAL using the appropriate cable and adapter (HP 1250-0077 and HP 08662-60075).
- Adjust A3A1C14 for minimum 122 MHz harmonic.

Adjustment 8

200 / 400 MHZ BANDPASS FILTER ADJUSTMENT

• Service Sheet 3

Description

The 200 and 400 MHz Bandpass Filters are adjusted to peak the 800 MHz signal at RF Test Point A8TP3 using a measuring receiver.

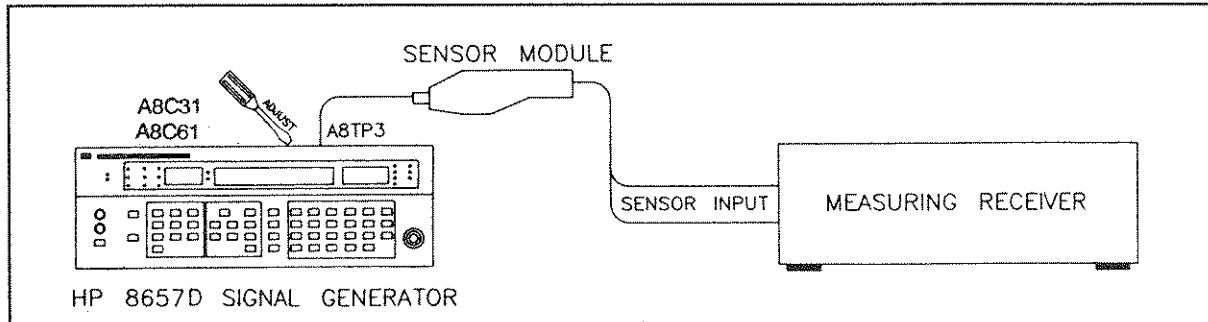

Figure 5-8. 200/400 MHz Bandpass Filter Adjustment Setup

Equipment

Measuring Receiver	HP 8902A
Sensor Module	HP 11722A
Adapter Probe	HP 1250-1598
Adapter N(f) to BNC(m)	HP 1250-0077
Adapter BNC(f) to BNC(f)	HP 1250-0080
Cable BNC(m) to SMC(f)	HP 08662-60075

Procedure:

1. Set the measuring receiver with the sensor module precalibrated and connected as follows:

Measurement	RF POWER
Display	LOG
2. Set the HP 8657D as follows:

Frequency	Any
Amplitude	-10 dBm
Modulation	Off
3. Zero the measuring receiver and wait for the zero LED to go out.
4. Connect the sensor module to the HP 8657D at RF Test Point A8TP3 using an adapter probe.
5. Tune the measuring receiver to 800 MHz. Adjust A8C61 and A8C31 for maximum RF power.

Adjustment 9

690 TO 740 MHz IF FLATNESS AND LEVEL ADJUSTMENT

- Service Sheets 1, 3, and 9

Description

A function generator is used to sweep the A3A1 Low Frequency VCO and provide a swept 690 to 740 MHz IF signal at A4TP3. The IF signal is adjusted for flatness within 3.5 dB and maximum level. The average power level of the IF signal is then set to approximately -9 dBm.

NOTE

The 690 to 740 MHz IF flatness and level adjustment must be performed whenever the A3A1, A8, or FL1 assemblies are replaced.

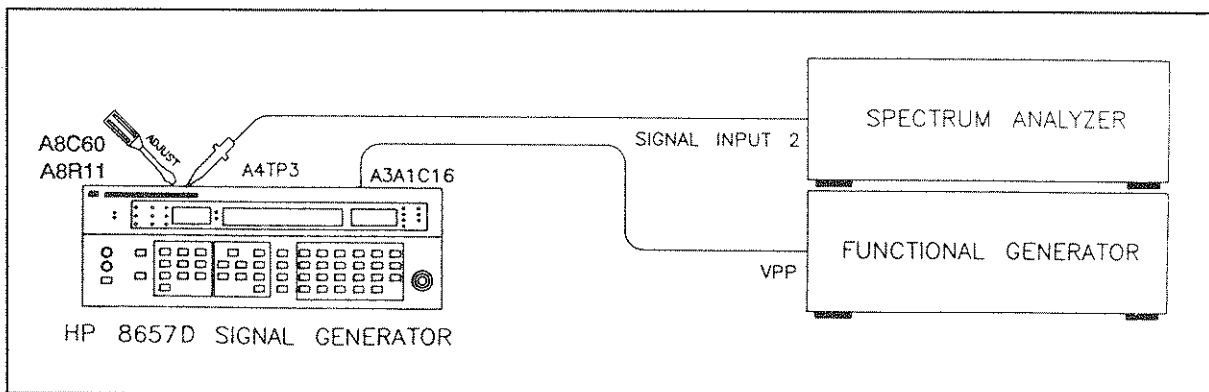

Figure 5-9. 690 to 740 MHz IF Flatness and Level Adjustment

Equipment

Spectrum Analyzer	HP 8562A
Function Generator	HP 3312A
Cable BNC	HP 8120-1840
Test lead clips to BNC	HP 8120-1292
Adapter N(f) to BNC(m)	HP 1250-0077
Adapter Probe	HP 1250-1598
Cable BNC(m) to SMC(f)	HP 08662-60075

Procedure

1. Set the HP 8657D as follows:

Frequency 700 MHz
 Amplitude Any
 Modulation Off

2. Set the function generator as follows:

Frequency 1.5 kHz
 Function Sine Wave
 Offset 0v
 Amplitude Range 10 Vp
 Symmetry Cal
 Modulation Off

3. Preset the spectrum analyzer and set as follows:

Frequency (START FREQ) 690 MHz
 Frequency (STOP FREQ) 740 MHz
 Amplitude (Reference Level) -3 dBm
 Amplitude (LOG dB/DIV) 1 dB/Div
 BW (RES BW) Max
 Sweep (SWEETIME) 500 ms

4. Remove jumper A3W6 and connect the function generator to the Low Frequency VCO at feedthrough capacitor A3A1C16 using the appropriate cable and adapter.
5. Connect the HP 8657D at A4TP3 to the spectrum analyzer INPUT using the appropriate cable and adapters.
6. If necessary, adjust the amplitude and offset of the function generator until the swept IF signal displayed on the spectrum analyzer starts just at 690 MHz and stops just at 740 MHz.
7. Adjust A8C60 for maximum level and flatness between 690 and 740 MHz. Flatness between maximum and minimum must be ≤ 3.5 dB. *Do not sacrifice level for flatness.*
8. Adjust A8R11 so the average level between 690 and 740 MHz is approximately -9 dBm.

NOTE

If the level is too low, the single sideband phase noise may be out of specification. If the level is too high, 800 MHz and other spurious signals may be out of specification.

Adjustment 10

NOTCH FILTER ADJUSTMENTS

- Service Sheet 1

Description

Jumper A4W4 is moved to place the HP 8657D in a mode to continuously ramp the High Frequency Loop Amplifier and to sweep the High Frequency VCO. The HP 8657D frequency is set to 765 MHz to select the 50 MHz IF and to not select the 50 MHz Notch Filter. The detected beat notes are monitored with an oscilloscope and the 350, 300, 250, 200, 150, and 100 MHz Notch Filters are adjusted to minimize their associated beat notes. The HP 8657D's frequency is then set to 965 MHz to not select the 50 MHz IF. The 50 MHz Notch Filter is adjusted to minimize its beat note. The HP 8657D frequency is then set to 1015 MHz and adjusted to maximize the 300 MHz beat note.

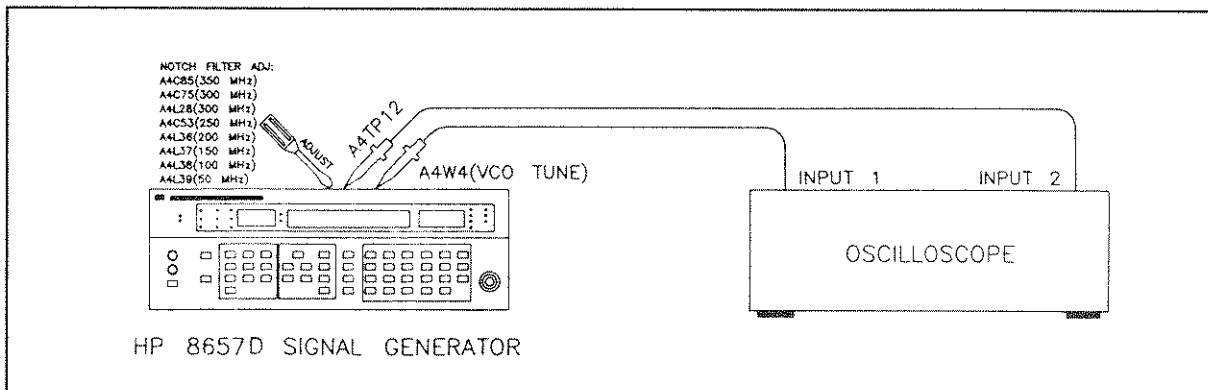

Figure 5-10a. Notch Filters Adjustment Setup

Equipment

Oscilloscope	HP 54100A
Oscilloscope Probe (2 required)	HP 54003A

Procedure

1. On the HP 8657D move A4W2 to the LOCK CANCEL position. This places the HP 8657D in a continual ramp and sweep mode.
2. Connect the oscilloscope channel 1 probe to A4W4. Connect the channel 2 probe to A4TP12.
3. Set the HP 8657D as follows:

Frequency	765 MHz
Amplitude	-3 dBm
Modulation	Off
4. Set the oscilloscope as follows: (settings are approximate, variations in voltages and times may require alternate settings)

CHANNEL 1

Volts/Div	500 mV
Display	Off
Offset	105 mV

CHANNEL 2

Volts/Div 20 mV
 Display On
 Offset 32 mV

TIMEBASE

Sec/Div 1 mSec
 Delay 0 mS
 Delay Ref Center

TRIGGER

Source Chan 1
 Level 105 mV
 Slope Neg

DISPLAY

Split Screen Off
 Graticle Grid
 Mode Normal
 Persistence Adjust As Required

5. The oscilloscope display for nonadjusted Notch Filters is shown in Figure 5-10b.

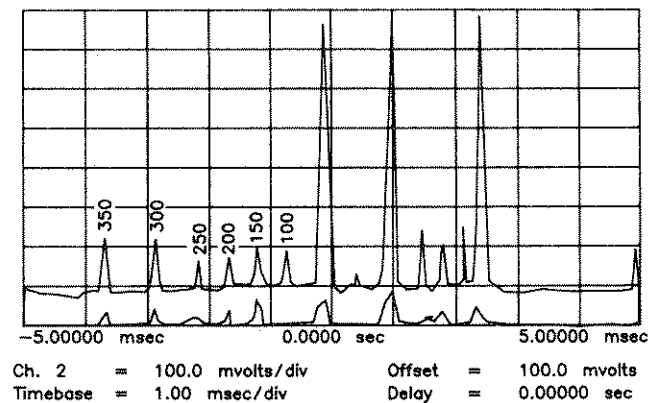

Figure 5-10b. Frequency Response of Notch Filters, 765 MHz Setting.

6. Observe the oscilloscope Chan 2 display (beat notes) and refer to Figure 5-10b. Adjust A4L38 (100 MHz Notch Filter) until you see the 100 MHz beat note change on the display, then adjust the beat note for minimum amplitude.
7. Adjust A4L37 (150 MHz Notch Filter) for minimum 150 MHz beat note.
8. Adjust A4L36 (200 MHz Notch Filter) for minimum 200 MHz beat note.
9. Adjust A4C53 (250 MHz Notch Filter) for minimum 250 MHz beat note.
10. Adjust A4L28 (300 MHz Notch Filter) for minimum 300 MHz beat note.
11. Adjust A4C75 (300 MHz Notch Filter) for minimum 300 MHz beat note.
12. Adjust A4C85 (350 MHz Notch Filter) for minimum 350 MHz beat note.

13. Set the HP 8657D frequency to 965 MHz and observe the oscilloscope Chan 2 display. The beat note levels should resemble those shown for channel 2 in Figure 5-10c. (the 50 MHz beatnotes are shown with non adjusted levels.) Adjust A4L39 (50 MHz Notch Filter) until the 50 MHz beat notes are at their minimum amplitude. Adjust A4C75 to maximize the 250 MHz signal while keeping the 300 MHz signal at minimum.

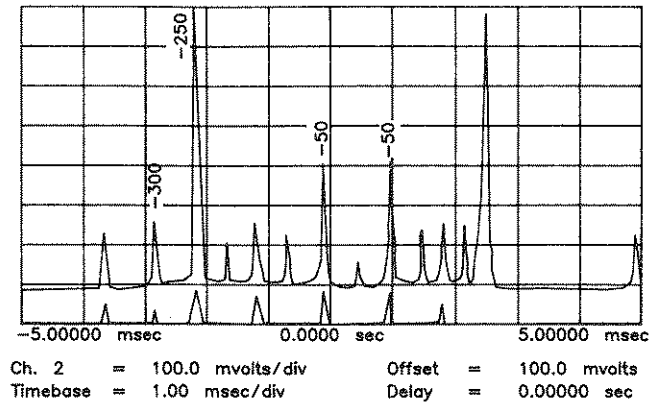

Figure 5-10c. Frequency Response of Notch Filters, 965 MHz Setting.

14. Set the HP 8657D to a frequency of 1015 MHz and observe the oscilloscope Chan 2 display. The beat note levels should resemble those shown for channel 2 in Figure 5-10d. Adjust A4C85 to maximize the 300 MHz beat note while keeping the 350 MHz beat note at a minimum.

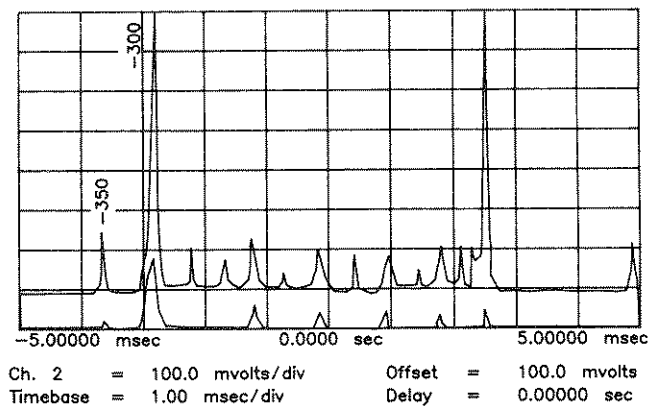

Figure 5-10d. Frequency Response of Notch Filters, 1015 MHz Setting.

15. When notch filter adjustments are complete, return A4W4 to the lock position.

Adjustment 11

400 MHz NOTCH FILTER ADJUSTMENT

- Service Sheet 1

Description

The 400 MHz Notch Filter is in the circuit all of the time and is adjusted for 1 MHz offset spurious signals from the selected frequency of 551 MHz.

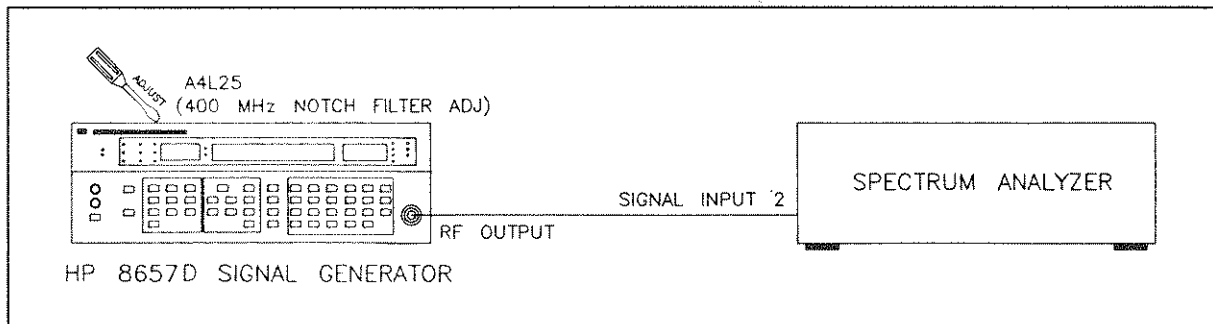

Figure 5-11. 400 MHz Notch Filter Adjustment Setup.

Equipment

Spectrum Analyzer	HP 8562A
Cable N(m) 2 183 cm	HP 11500A

Procedure

- Set the spectrum analyzer as follows:

Frequency (Center)	550 MHz
Span (Frequency)	10 MHz
Amplitude (Reference Level)	0 dBm
BW (RES BW)	30 kHz
- Set the HP 8657D as follows:

Frequency	547 MHz
Amplitude	0 dBm
Frequency Increment	1 MHz
Modulation	Off
- Connect the HP 8657D RF OUTPUT to spectrum analyzer INPUT.
- Step the HP 8657D frequency in 1 MHz steps from 547 to 553 MHz. Adjust A4L25 for minimum spurious signals in the frequency range. Ensure that all spurious signals are <60 dB.

Adjustment 12

LEVEL AND ALC LOOP DETECTOR ADJUSTMENTS

- Service Sheets 4 and 7

Description

First, the reference level to the Level Digital to Analog Converter (DAC) is adjusted for +3.50 dBm \pm 0.02 dB at the HP 8657D RF OUTPUT. Then the detector bias reference level to the ALC Amplifier is adjusted.

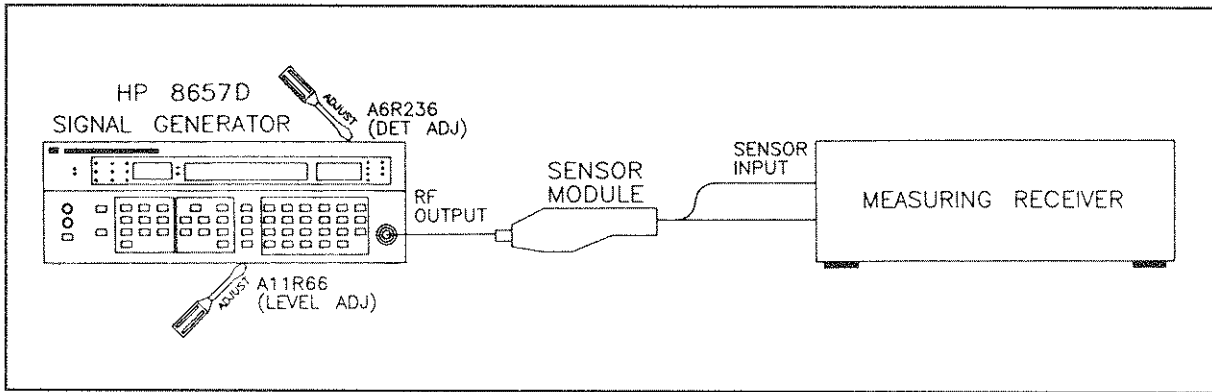

Figure 5-12. Level and ALC Loop Detector Adjustment Setup

Equipment

Measuring Receiver.....	HP 8902A
Sensor Module.....	HP 11722A

Procedure

1. Set the measuring receiver with the sensor module precalibrated and connected as follows:

Measurement.....	RF POWER
Display.....	LOG
2. Set the HP 8657D as follows:

Frequency.....	820 MHz
Amplitude.....	+3.5 dBm
Modulation.....	Off
Amplitude Increment.....	.5 dB

NOTE

Before making the adjustment, the HP 8657D must be warmed up for a minimum of 1/2 hour.

3. Zero the sensor module and connect it to the RF OUTPUT connector on the HP 8657D.
4. Tune the measuring receiver to the HP 8657D frequency by pressing the **FREQ** key. Press the **RF POWER** key and adjust A11R66 (**LEVEL ADJ**) for a reading of $+3.5 \text{ dBm} \pm 0.2 \text{ dB}$.
5. Press the **RATIO** key on the measuring receiver to set a reference level of 0.0 dB.
6. Step the HP 8657D amplitude down to -1.5 dBm .
7. Adjust A6R236 for an RF Power level of $-4.95 \text{ dB} \pm 0.1 \text{ dB}$ on the measuring receiver.
8. Repeat steps 4, 6, and 7 until both readings are within the required tolerance.

Adjustment 13

AM% AND ALC LOOP AM ADJUSTMENTS

- Service Sheets 4 and 7

Description

The reference level to the AM% Digital to Analog Converter (DAC) is adjusted for an average amplitude modulation of 21.21%. The AM reference to the ALC Amplifier is adjusted for minimum distortion of the modulation.

NOTE

The AM Offset, and Level and ALC Loop Adjustments must be performed before performing these adjustments. Refer to Adjustment 4 and Adjustment 12.

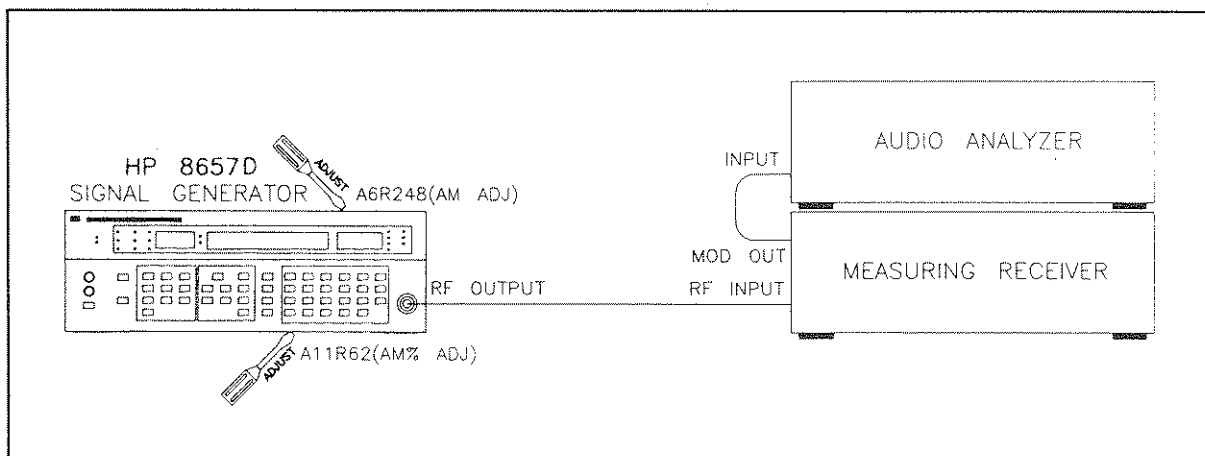

Figure 5-13. AM% and ALC Loop AM Adjustments Setup

Equipment

Measuring Receiver	HP 8902A
Audio Analyzer	HP 8903B
Cable N(m)2 183 cm.....	HP 11500A
Cable BNC(m)	HP 10503A

Procedure

1. Set the measuring receiver as follows:

Measurement	AM
Detector	AVG
HP Filter	50 Hz
LP Filter	15 kHz

2. Set the HP 8657D as follows:

Frequency 200 MHz
 Amplitude +1 dBm
 Modulation AM 30%
 Source 1 kHz (Int.)

3. Connect the measuring receiver to the RF OUTPUT connector on the HP8657D and connect the audio analyzer as shown in Figure 5-13.

4. Adjust A11R62 (AM% ADJ) for a reading of 21.21% on the measuring receiver.

NOTE

Do not remove any of the internal RF covers for this adjustment.

5. Set the HP 8657D as follows:

Frequency 200 MHz
 Amplitude -1.5 dBm
 Modulation AM 90%

6. Set the measuring receiver as follows:

Detector $\frac{PK^+ + PK^-}{2}$

7. Set the Audio Analyzer as follows:

Measurement Distortion

8. Adjust A6R248 (AM ADJ) for a minimum reading on the measuring receiver as close to 90% as possible, while keeping the 1 kHz audio distortion less than 4%.

Adjustment 14

FM CALIBRATION PRETUNE ADJUSTMENT

- Service Sheet 14

Description

The Low Frequency Loop is locked during this adjustment. The output of the integrator is adjusted so that the bottom of the integrator waveform is -6.0 volts. This adjustment assures that the VCO's tune voltage will have sufficient range.

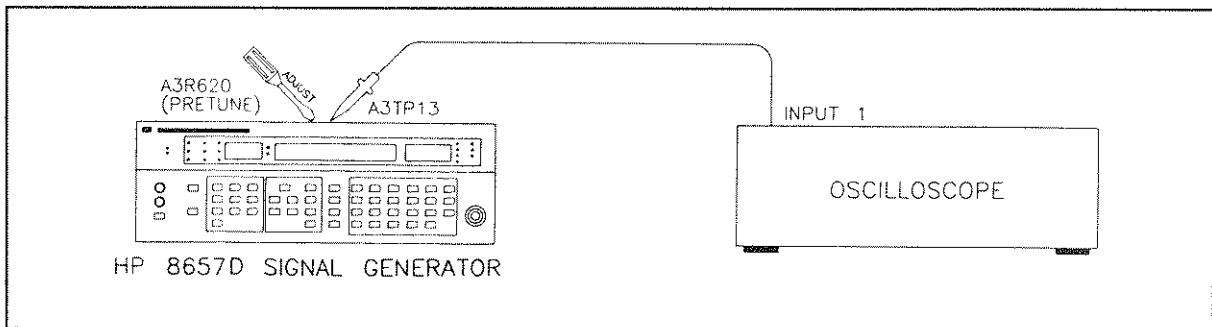

Figure 5-14a. FM Calibration Pretune Adjustment Setup

Equipment

Oscilloscope	HP 54100A/54110A
Oscilloscope Probe Pod (Chan 1).....	HP 54003A

Procedure

1. Set the HP 8657D as follows:

Frequency	117 MHz
Amplitude	Any
Modulation	Off

2. Connect the oscilloscope probe to A3TP13, Integrator Output.

3. Set the oscilloscope as follows: (with AUTO-SCALE, the oscilloscope should preset to approximately the following conditions)

CHAN

Channel.....	1
V/div	1V
Offset.....	-6V
Probe	10:1
Coupling	dc, 1M Ω

TIME

Sec/div	2 μ s
Delay.....	0 s
Reference	Center

TRIG

Mode - Edge
 Source Chan 1
 Slope Neg

DISPLAY

Mode Averaged
 Graticule Type Grid
 Averages 4

4. Adjust A3R620 (PRETUNE) for a voltage of $-6.0 \text{ volts} \pm 0.5 \text{ volts}$ at the bottom of the integrator waveform (the oscilloscope Delta V and marker functions can be used to set a reference line at -6V as a calibration aid). See Figure 5-14b.

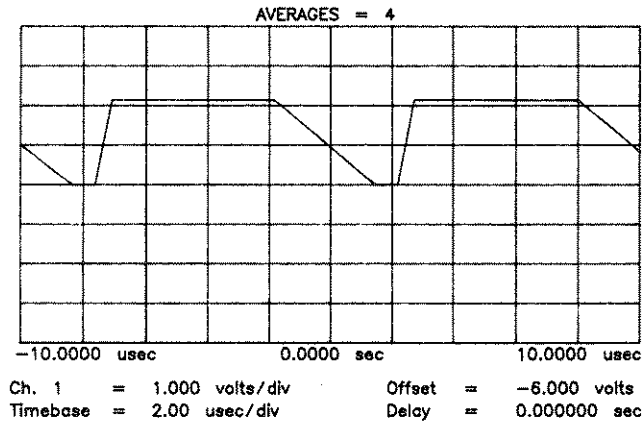

Figure 5-14b. Sample of Oscilloscope Display

Adjustment 15

API 1, 2, 3 AND 4 ADJUSTMENTS

- Service Sheet 12

Description

The API, Analog Phase Interpolation, spurious signals are adjusted for -60 dBc using a spectrum analyzer.

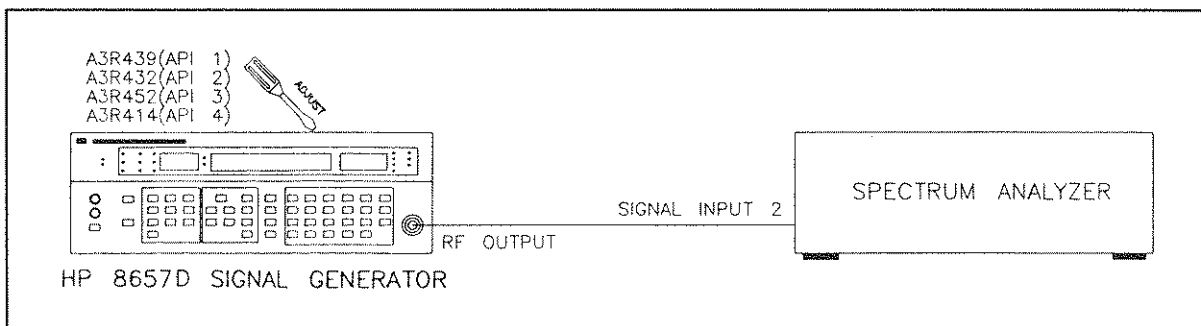

Figure 5-15. API 1, 2, 3 and 4 Adjustment Setup

Equipment

Spectrum Analyzer	HP 8562A
Cable N(m)2 183 cm.....	HP 11500A

NOTE

The A3 Assembly must be fastened to RFI cover (MP12) with hex nuts before making API adjustments.

Procedure

- Set the spectrum analyzer as follows:

Frequency (Center).....	65 MHz
Span (Frequency).....	10 kHz
Amplitude (Reference Level).....	0 dBm
- Set the HP 8657D as follows:

Frequency	65 MHz
Amplitude	0 dBm
Modulation	Off
- Connect the RF OUTPUT of the HP 8657D to the spectrum analyzer as shown in Figure 5-15.
- Change the HP 8657D frequency to 65.002 MHz.
- Adjust A3R439 (API 1) so the spurious signals 1 and 2 kHz from the carrier are at minimum (less than -60 dBc).
- Change the HP 8657D frequency to 65.0002 MHz.

7. Adjust A3R432 (API 2) so the spurious signals 1 and 2 kHz from the carrier are at minimum (less than -60 dBc).
8. Change the HP 8657D frequency to 65.00002 MHz.
9. Adjust A3R452 (API 3) so the spurious signals 1 and 2 kHz from the carrier are at minimum (less than -60 dBc).
10. Change the HP 8657D frequency to 65.00001 MHz.
11. Set the spectrum analyzer frequency span to 25 kHz.
12. Adjust A3R414 (API 4) so spurious signals 5 and 10 kHz from the carrier are at minimum (less than -60 dBc).

Adjustment 16

PEDESTAL ADJUSTMENT

- Service Sheet 13

Description

The Sample and Hold circuit current is adjusted for a spurious signal less than -60 dBc using a spectrum analyzer.

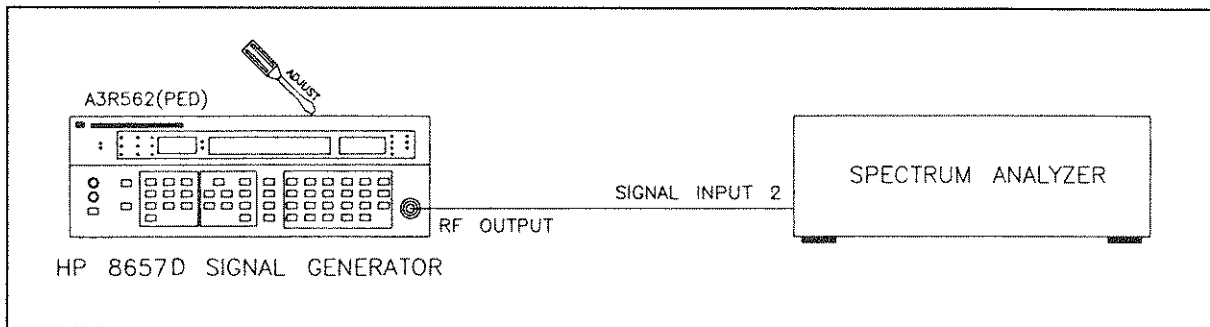

Figure 5-16. Pedestal Adjustment Setup

Equipment

Spectrum Analyzer	HP 8562A
Cable N(m)2 183 cm	HP 11500A

NOTE

The A3 Assembly must be fastened to RFI Cover (MP12) with hex nuts before making API adjustments.

Procedure

- Set the spectrum analyzer as follows:

Frequency (Center)	65.1 MHz
Span (Frequency)	10 kHz
Amplitude (Reference Level)	-30 dBm
- Set the HP 8657D as follows:

Frequency	65 MHz
Amplitude	Any
Modulation	Off
- Connect the RF OUTPUT of the HP 8657D to the spectrum analyzer as shown in Figure 5-16.
- Adjust A3R562 (PED) so the spurious signal 100 kHz from the carrier is at minimum (less than -60 dBc). Frequency span settings on the spectrum analyzer can be reduced to as low as 200Hz and center frequencies changed to facilitate viewing the spurious signal.

Adjustment 17

INTEGRATOR INPUT OFFSET ADJUSTMENT

• Service Sheet 13

Description

The voltage at the input to the integrator is adjusted such that the voltage at a VCO frequency of 60 MHz is always lower than a VCO frequency of 110 MHz at A3 W1.

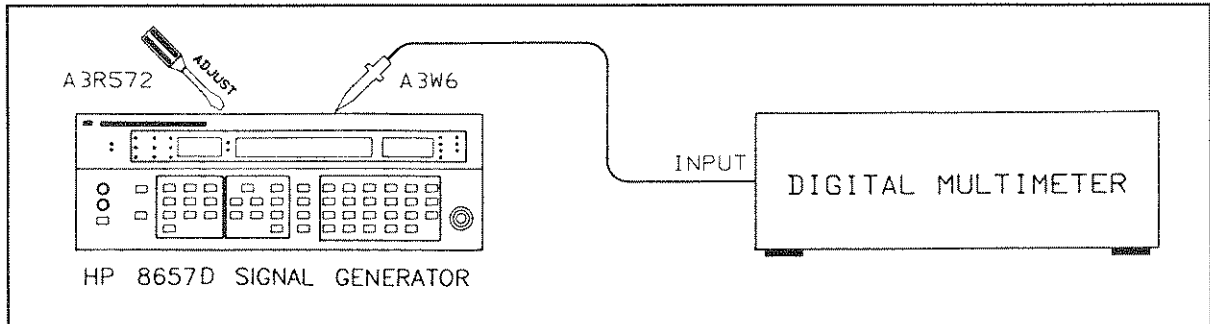

Figure 5-17. Integrator Input Offset Adjustment Set-up

Equipment

Digital Multimeter..... HP 3466A

Procedure

1. Set the HP 8657D to 715 MHz and then step up 25 MHz to 740MHz (this ensures that the Low Frequency VCO is set to 60 MHz).
2. Connect the digital multimeter between A3 W1 and ground and adjust A3 R572 for 0 V \pm 10mV.
3. Set the HP 8657D to 715 MHz and then step down 25 MHz to 690 MHz (this ensures that the Low Frequency VCO is set to 110 MHz).
4. Measure the voltage on A3 W1 and adjust A3 R572 until this voltage is halved. Call this voltage (V2).
5. Step from 690 MHz to 740 MHz and ensure that the voltage measured on A3 W1 is always less than (V2).

Adjustment 18

DC FM SPURIOUS SIGNAL ADJUSTMENT

- Service Sheet 15

Description

The DC FM spurious signals are adjusted using a spectrum analyzer and a dc power supply.

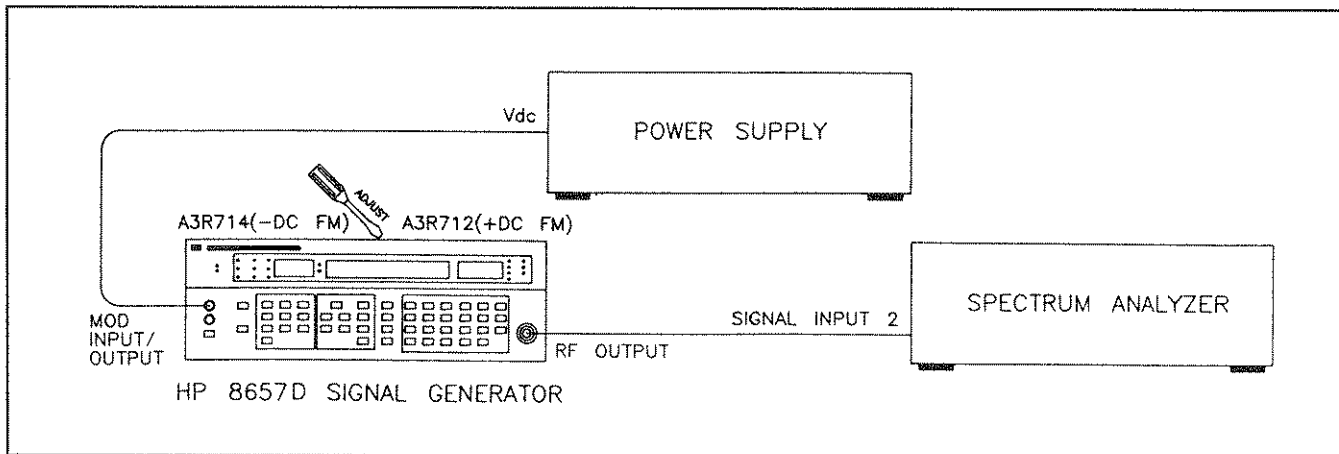

Figure 5-18. DC FM Spurious Signal Adjustment Setup

Equipment

Spectrum Analyzer	HP 8562A
Power Supply	HP 6214B
Cable N(m)2 183 cm.....	HP 11500A
Cable BNC to dual banana plug	HP 11001-60001

Procedure

1. Set the spectrum analyzer as follows:

Frequency (Center).....	65 MHz
Span (Frequency).....	10 kHz
Amplitude (Reference Level).....	0 dBm

2. Set the power supply as follows:

Meter.....	Volts
Voltage.....	1 Vdc

3. Set the HP 8657D as follows:

Frequency	65 MHz
Amplitude	0 dBm
Modulation	DC FM, 3 kHz

4. Connect the HP 8657D RF OUTPUT to the spectrum analyzer INPUT and the MOD INPUT/OUTPUT to the power supply +1 Vdc as shown in Figure 5-18.

NOTE

The HP 8657D LO EXT Modulation annunciator remains on regardless of the dc input level applied to the MOD INPUT/OUTPUT connector.

5. Adjust A3R712 (+DC FM) so spurious signals are < -50 dBc.
6. Connect -1 Vdc to the MOD INPUT/OUTPUT.
7. Adjust A3R714 ($-$ DC FM) so spurious signals are < -50 dBc.

Adjustment 19

VOLTAGE OFFSET ADJUSTMENT

- Service Sheet 7

Description

The DC offset of the FM Deviation Summing Amplifier is adjusted for $0.000 \text{ Vdc} \pm 0.001 \text{ Vdc}$ at A11TP3.

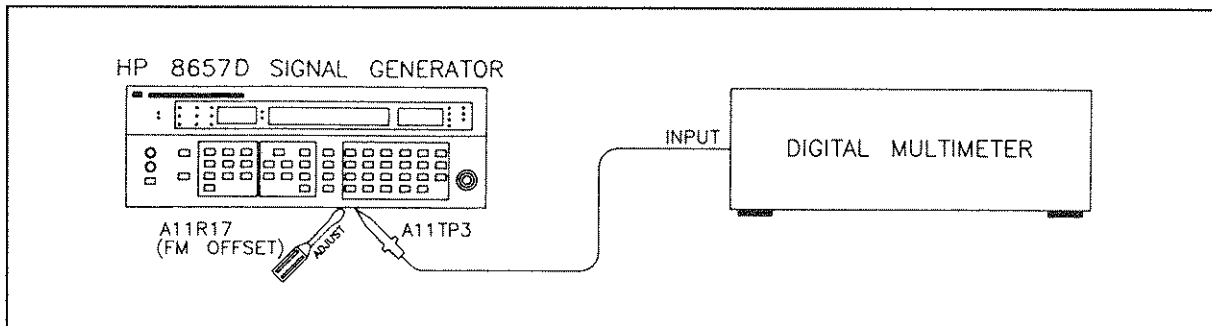

Figure 5-19. DC FM Offset Adjustment Setup

Equipment

Digital Multimeter HP 3466A

NOTE

The A11 Assembly must be fastened in the instrument before making the Voltage Offset Adjustment

Procedure

1. Set the digital multimeter as follows:

Function	Vdc
Range	200 mV
2. Set the HP 8657D as follows:

Frequency	65 MHz
Amplitude	Any
Modulation	DC FM, 99 kHz
3. Remove any signal connected to the HP 8657D MOD INPUT/OUTPUT connector.
4. Connect the digital multimeter to A11TP3 as shown in Figure 5-19.
5. Adjust A11R17 (FM OFFSET ADJ) for $0.000 \text{ Vdc} \pm 0.001 \text{ Vdc}$.

Adjustment 20

DC FM OFFSET ADJUSTMENT

- Service Sheet 7

Description

The DC Offset of the FM Deviation Amplifier is adjusted for an output frequency error of ± 10 Hz with DC FM selected.

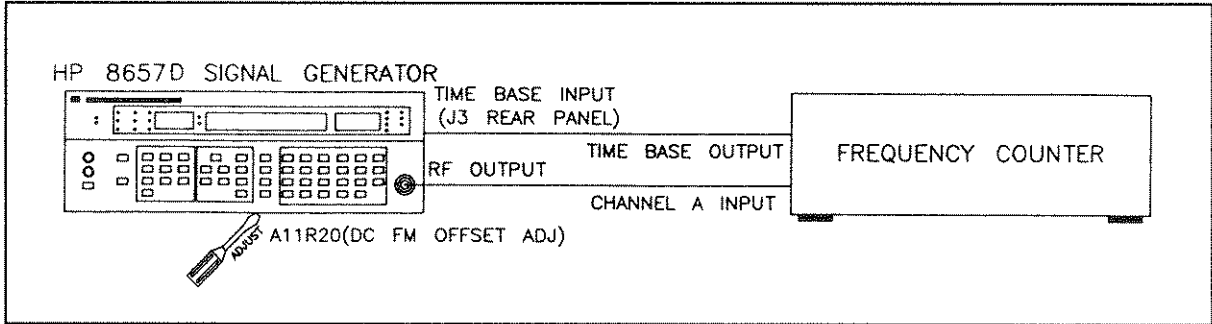

Figure 5-20. DC FM Frequency Offset Adjustment Setup

Equipment

- Frequency Counter HP 5328B
- Adapter, N(m) to BNC (f) HP 1250-0780
- Cable, BNC (2 ea) HP 10503A

NOTE

The A3 Assembly must be fastened to RFI cover (MP22) with hex nuts and the A11 Assembly fastened in the instrument before making the DC FM Adjustment.

Procedure

1. Set the frequency counter as follows:
 - Frequency Input A
2. Set the HP 8657D as follows:
 - Frequency 65 MHz
 - Amplitude 0 dBm
 - Modulation DC FM, 99 kHz
3. Connect the HP 8657D RF OUTPUT to the frequency counter CHANNEL A INPUT and the counter time base OUT to the HP 8657D Time Base INPUT as shown in Figure 5-20.
4. Adjust A11R20 (DC FM OFFSET ADJ) for a frequency counter reading of 65.000000 MHz ± 10 Hz.

Adjustment 21

FM IN-BAND GAIN ADJUSTMENT

- Service Sheet 15

Description

An external modulation signal whose frequency is outside the Low Frequency Loop bandwidth is used to frequency modulate the HP 8657D. The frequency modulation is measured with the EXT FM of the HP 8657D set to 50 kHz for a reference. The external modulation signal is changed to 100 Hz and the FM IN-BAND GAIN is adjusted for the same FM peak deviation.

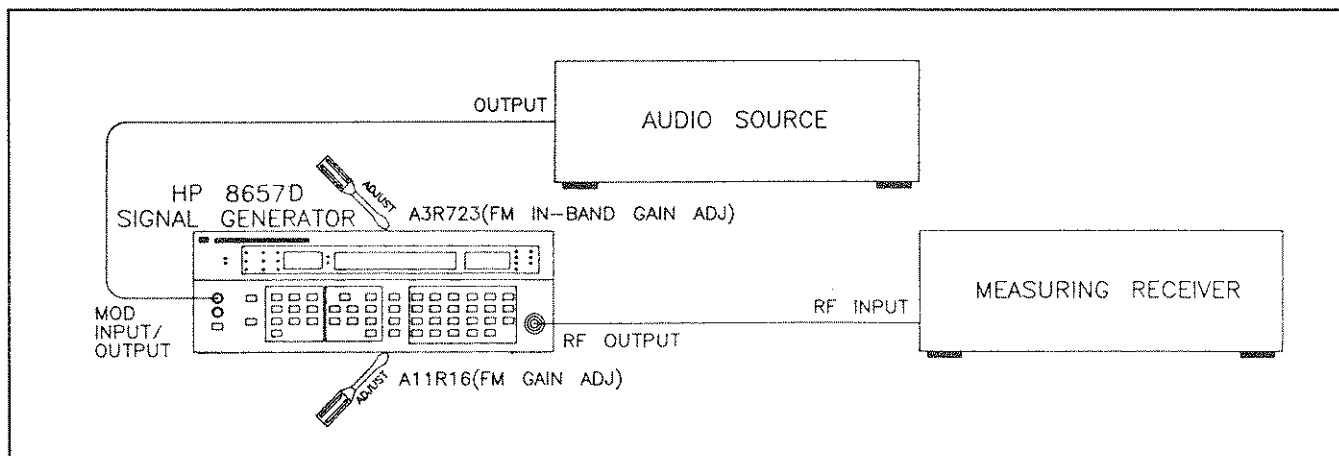

Figure 5-21. FM In-band Gain Adjustment Setup

Equipment

Measuring Receiver	HP 8902A
Audio Source	HP 8903B
Cable N(m)2 183 cm.....	HP 11500A
Cable, BNC	HP 10503A

Procedure

1. Set the measuring receiver as follows:

Measurement	FM, PEAK+
-------------------	-----------
2. Set the audio source as follows:

Frequency	20 kHz
Amplitude	1.414 Vac
3. Set the HP 8657D as follows:

Frequency	65 MHz
Amplitude	0 dBm
Modulation	EXT FM, 50 kHz

4. Connect the HP 8657D RF OUTPUT to the measuring receiver INPUT, and the HP 8657D MOD INPUT/OUTPUT to the audio source OUTPUT as shown in Figure 5-21. The HP 8657D LO EXT and HI EXT LED's should be out. Also insure that the HP 8657D INT 1 kHz modulation source is turned off.
5. Adjust A11R16 (FM Gain ADJ) if necessary, for a reading of 50.0 ± 0.2 KHz on the measuring receiver.

NOTE

If it is necessary to adjust A11R16, the FM Deviation Adjustment 22 must be performed.

6. Set the measuring receiver to RATIO and the audio source frequency to 100 Hz.
7. Adjust A3R723 (FM IN-BAND GAIN ADJ) for a reading of 100% on the measuring receiver.
8. Repeat steps 6 through 8 and readjust A3R723 if required.

Adjustment 22

FM DEVIATION ADJUSTMENT

- Service Sheet 7

Description

The FM deviation is adjusted with a maximum FM peak deviation of 99 kHz entered into the HP 8657D. The carrier frequency is stepped down in 10 MHz steps from 990 to 940 MHz and A11R16 is adjusted for an equal error around 99 kHz deviation.

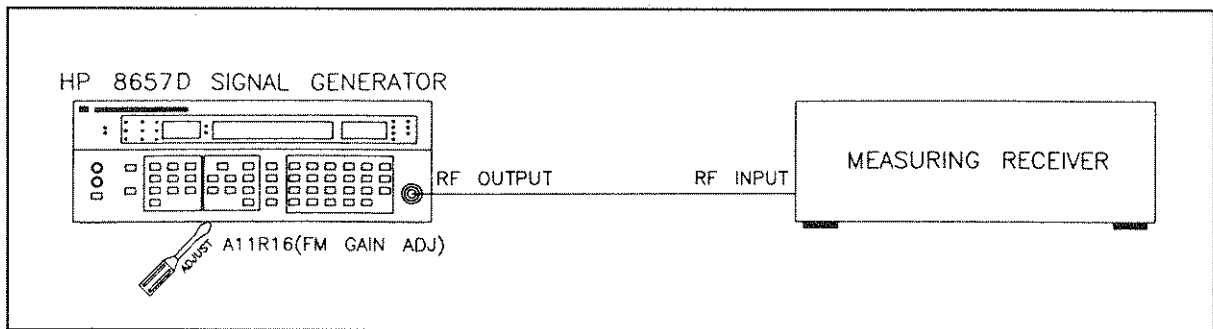

Figure 5-22. FM Deviation Adjustment Setup

Equipment

Measuring Receiver	HP 8902A
Cable N(m)2 183 cm	HP 11500A

Procedure

1. Set the measuring receiver as follows:

Measurement	FM
Detector	+Peak
HP Filter	300 Hz
LP Filter	3 kHz

2. Set the HP 8657D as follows:

Frequency	990 MHz
Frequency Increment	10 MHz
Amplitude	+4 dBm
Modulation	FM 99 kHz
Source	1 kHz (Int.)

3. Connect the measuring receiver input to the RF OUTPUT connector on the HP 8657D.
4. Adjust A11R16 (FM GAIN ADJ) for a 99.0 kHz deviation reading on the measuring receiver.
5. Step the frequency down from 990 to 940 MHz and record the deviation at each of the 10 MHz steps. Each frequency must be keyed into the measuring receiver.

6. Readjust A11R16 for equal error ± 2 kHz from 99 kHz at the frequencies of maximum and minimum peak kHz deviation.

- _____ 990 MHz
- _____ 980 MHz
- _____ 970 MHz
- _____ 960 MHz
- _____ 950 MHz
- _____ 940 MHz

Adjustment 23

OPTION 001 10 MHz REFERENCE OSCILLATOR FREQUENCY ADJUSTMENT

- Service Sheet 25

Description

The Option 001 10 MHz Reference Oscillator frequency is adjusted to $10.000 \text{ MHz} \pm 10.0 \text{ Hz}$ using a frequency counter.

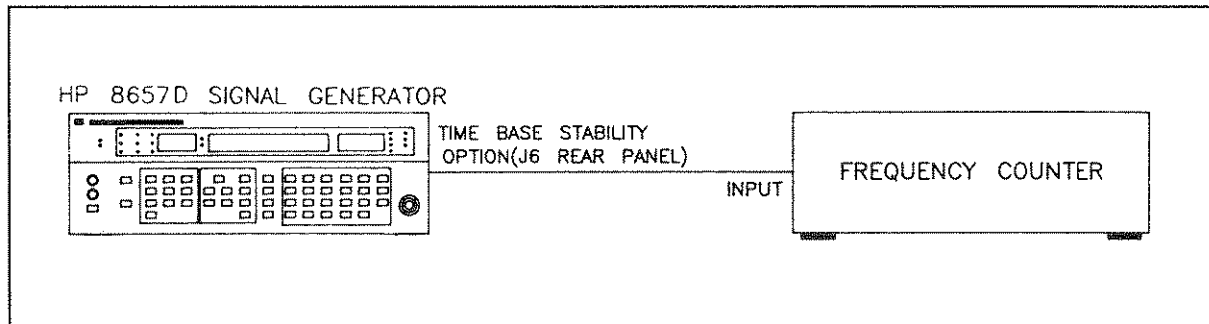

Figure 5-23. 10 MHz Reference Oscillator Frequency Adjustment Setup

Equipment

Frequency Counter	HP 5328B
Cable BNC(m)	HP 10503A

NOTE

Before making the adjustment, the HP 8657D must be warmed up for a minimum of 24 hours.

Procedure

1. Remove the COARSE and FINE screws on the oscillator cover (accessed through the rear panel).
2. Connect the frequency counter to the TIME BASE HIGH STABILITY OPTION connector (J6) on the rear-panel of the HP 8657D.
3. Adjust the COARSE and FINE adjustments for a reading of $10.000 \text{ MHz} \pm 10 \text{ Hz}$ on the frequency counter.
4. Replace the COARSE and FINE screws.

Adjustment 24

$\pi/4$ DQPSK MODULATOR ADJUSTMENT

Description

An 800 MHz, 0 dBm, CW signal is input to the $\pi/4$ DQPSK Modulator's 800 MHz input. A spectrum analyzer is connected to the 800 MHz output. The modulator's offset, Quadrature gain, and phase are adjusted. These adjustments should be done at an ambient temperature of 15°C to 35°C to validate specifications.

NOTE

No access to the interior of the instrument is required to make the adjustments.

Equipment

Spectrum Analyzer	HP 8562A
Multifunction Synthesizer	HP 8904A
Cable BNC(m) to SMC(f) (2 ea)	HP 08662-60075
Adapter N(m) to BNC(f) (2 ea)	HP 1250-0780
Termination 50 ohm, BNC(m)	HP 1250-0207

Procedure

1. Set the multifunction synthesizer as follows:

PRESET the multifunction synthesizer.

OUTPUT 1..... 24.3 kHz, sine wave at 3 V (pk)

2. Set the spectrum analyzer as follows:

Frequency (Center)..... 800 MHz

Span (Frequency)..... 50 kHz

Amplitude (Reference Level)..... 0 dBm

3. Set the Signal Generator as follows:

Frequency

Amplitude

Modulation

4. Connect the Signal Generator's rear-panel TIME BASE OUTPUT to the spectrum analyzer's rear-panel TIME BASE (REF) INPUT.

5. Connect the Signal Generator's RF OUTPUT to the $\pi/4$ DQPSK Modulator's 800 MHz MODULATOR INPUT.

6. Connect the $\pi/4$ DQPSK Modulator's 800 MHz MODULATOR OUTPUT to the spectrum analyzer's INPUT.

7. Set rear-panel switch PREMOD FILTER CONTROL S1 to the "1" position (SYMBOL CLK).

8. Connect the Multifunction Synthesizer's OUTPUT 1 to the $\pi/4$ DQPSK Modulator's front-panel CLOCK INPUT. The ACTIVE green LED will light.
9. Connect the 50 Ω termination to the $\pi/4$ DQPSK Modulator's front-panel DATA INPUT.
10. Set switch #1 of the eight section switch array to the "1" position (normal operating position). (The switches are numbered from 1 through 8, left to right.)

$\pi/4$ DQPSK I/Q MODULATOR QUADRATURE GAIN AND PHASE ADJUSTMENT

NOTE

$\pi/4$ DQPSK I/Q Modulator Quadrature Gain and Phase should not require adjustment unless the Premodulator Filter Assembly has been repaired.

The $\pi/4$ DQPSK I/Q Modulator adjustments are interactive. When Q Gain and PHASE QUAD (Quadrature Gain and Phase) are adjusted, the I and Q Offset must also be adjusted.

11. Adjust the $\pi/4$ DQPSK I/Q Modulator Quadrature Gain and Phase as follows:
12. Set the front panel POLARITY switch to NORM (out).
13. The spectrum analyzer will display a signal at 799.997 MHz (800 MHz - 3 kHz) with 3 kHz sidebands >799.997 MHz.
14. Set the $\pi/4$ DQPSK Modulator's front panel POLARITY switch to INV (in).
15. The spectrum analyzer will display a signal at 800.003 MHz (800 MHz + 3 kHz) with 3 kHz sidebands <800.003 MHz.
16. Alternately set the POLARITY switch between NORM and INV and alternately adjust the rear panel Q Gain and PHASE QUAD adjustments until the second sidebands (offset by 6 kHz) are < -40 dBm and levels within 2 dBm.

$\pi/4$ DQPSK I/Q MODULATOR OFFSET ADJUSTMENT

NOTE

$\pi/4$ DQPSK I/Q Modulator I and Q Offset should not require adjustment unless the Premodulator Filter Assembly has been repaired.

The $\pi/4$ DQPSK I/Q Modulator adjustments are interactive. After performing the I and Q Offset adjustment, you must go back and recheck the Q Gain and PHASE QUAD (Quadrature Gain and Phase) adjustments.

17. Adjust the $\pi/4$ DQPSK I/Q Modulator I and Q Offset as follows:
18. Alternately set the $\pi/4$ DQPSK Modulator's front panel POLARITY switch between NORM and INV and alternately adjust the rear panel I and Q OFFSET adjustments until the 800 MHz signal (first sideband) are < -55 dBm and levels within 2 dBm.

5-7. DISASSEMBLY INSTRUCTIONS

The following information provides disassembly instructions necessary to perform all adjustments.

Removing the Lower Unit ($\pi/4$ DQPSK Modulator Assembly) Assembly/Disassembly Instructions for disassembling the two units can be found in Section 2.

Top and Bottom Cover Removal Remove the four strap handle caps. To remove a cover, use a screwdriver to gently pry up the cover at the rear of the unit.

Rear Panel Removal To access the power supply adjustment locations, removal of the rear panel is required. Remove the screws as shown in the diagram below (there are three screws on the underside). Remove the BNC connector retaining nuts (the number of BNC connectors will depend on the options fitted).

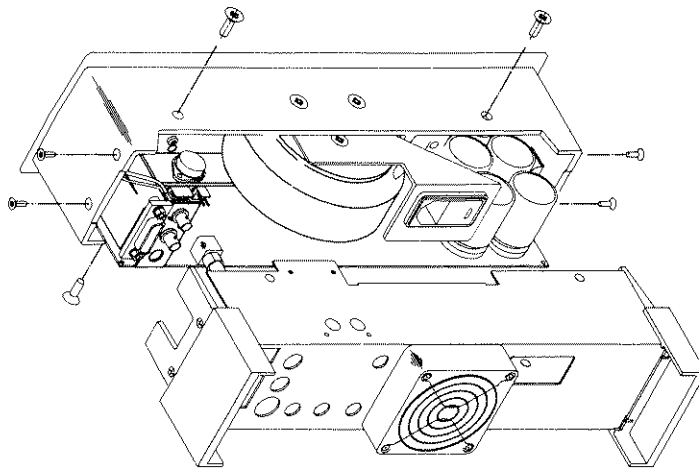

Level 2 Access - A4 and A8 Adjustments Remove the 10 nuts securing the A3 assembly. Raise A3 into the service position as shown in the diagram below. Remove two screws from the large RFI cover. To access A4 and A8, remove the appropriate RFI covers.

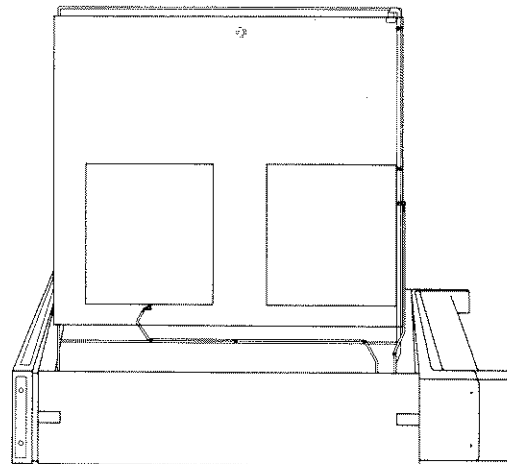

J6
TIME BASE(J3,J4)

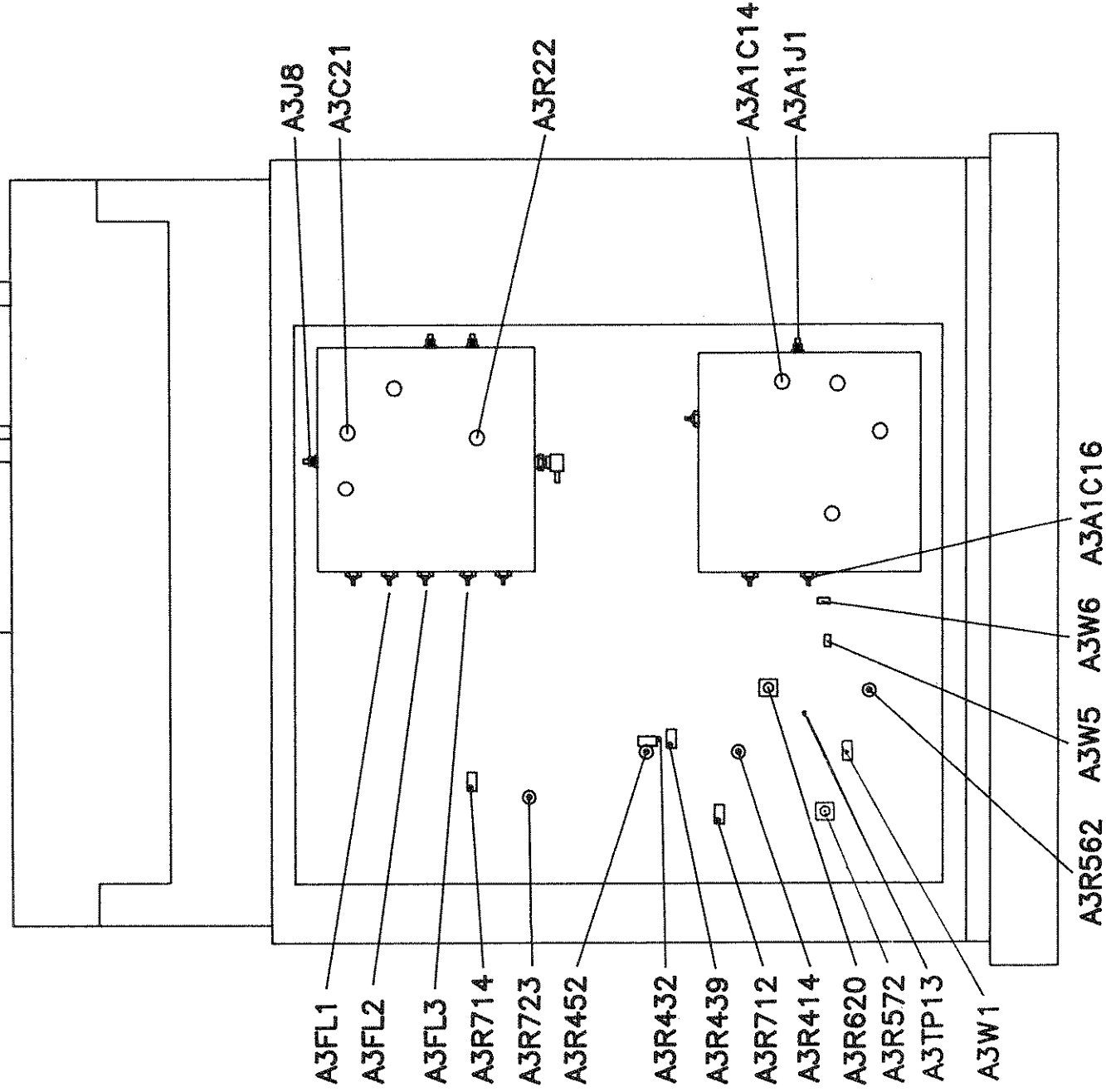

TOP INTERNAL VIEW -- LEVEL 1

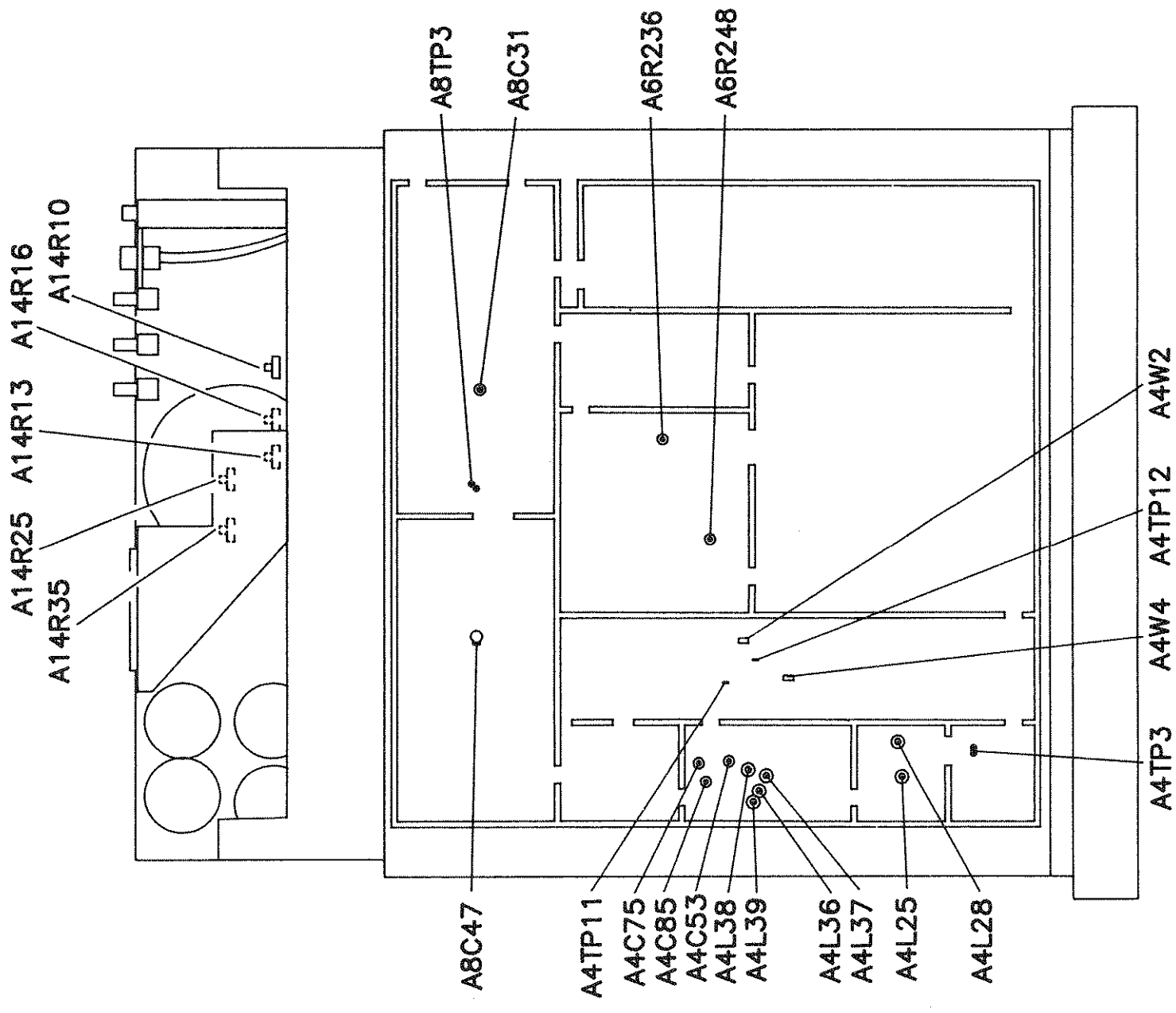

TOP INTERNAL VIEW -- LEVEL 2

Figure 5-25. Adjustment Locations

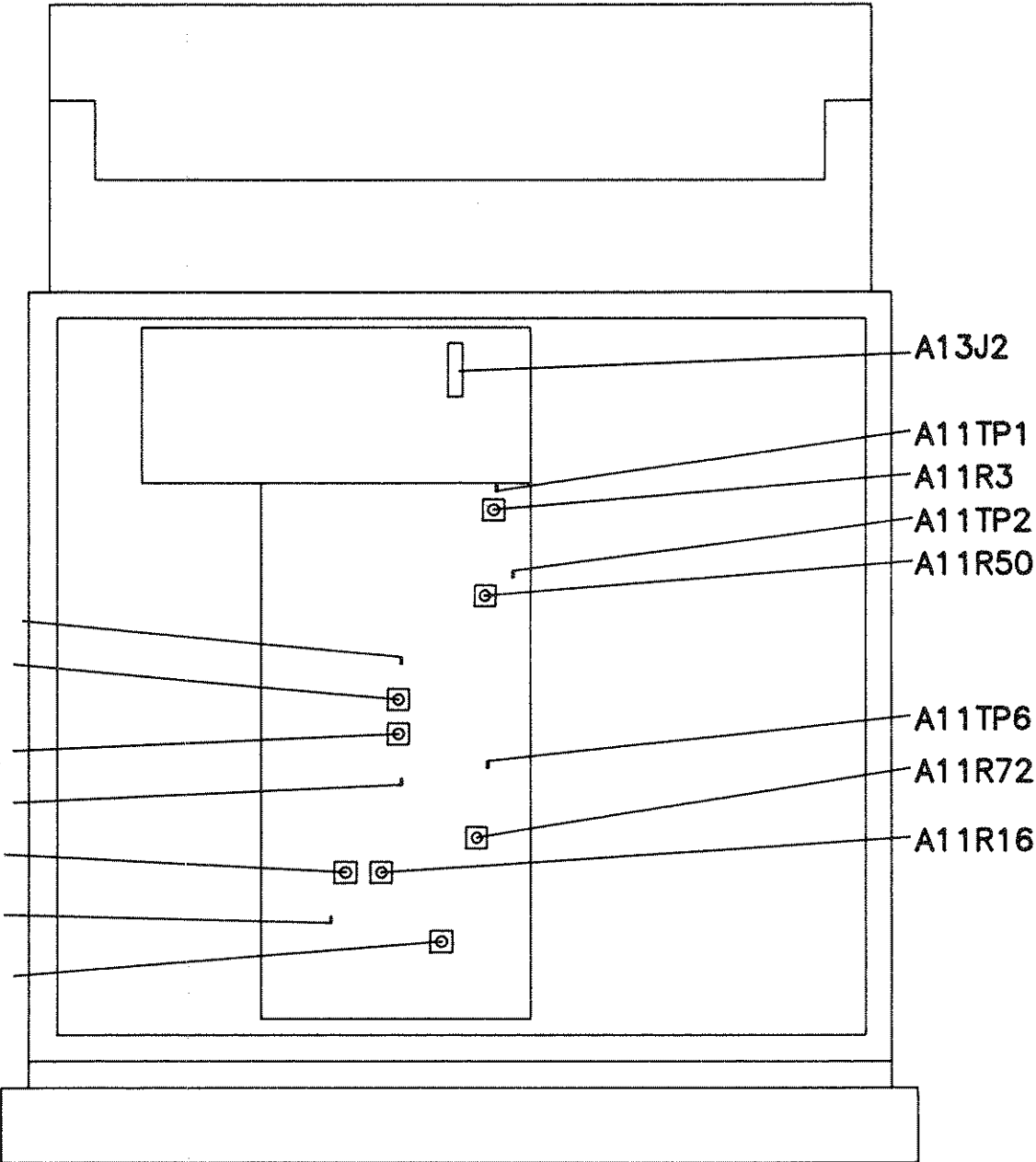

BOTTOM INTERNAL VIEW — LEVEL 4

