

INSTRUCTION BOOK
FOR
SCOTT MARINE
RADIO RECEIVER
SLR-M

SCOTT RADIO LABORATORIES INC.
4541 RAVENSWOOD AVE.
CHICAGO 40 ILLINOIS

TABLE OF CONTENTS

	Page
Section I - General Description	
1. General	1
2. Description	2
3. Construction	5
Section II - Circuit Description	
4. General	11
5. Signal Frequency Circuits	11
6. High Frequency Oscillator Circuits	12
7. I.F. Amplifier Circuits	13
8. Second Detector Circuits	14
9. C.W. Oscillator Circuits	15
10. A.F. Amplifier Circuits	15
11. Rectifier Power Circuits	17
Section III - Installation and Initial Adjustments	
12. Unpacking the Equipment	18
13. Installation	18
14. Connections to Receiver	18
Section IV - Operation	
15. Operation of Controls	20
Section V - Operators Maintenance	
16. Periodic Inspections	22
17. Emergency Checks	22
Section VI - Preventive Maintenance	
18. Periodic Check	23
Section VII - Corrective Maintenance	
19. Tube Replacement	25
20. Failure of the Radio Receiver	25
21. Voltage and Resistance Tests	26
22. Alignment Data	26
23. I.F. Amplifier Alignment	31
24. C.W. Oscillator Alignment	33
25. R.F. and H.F. Oscillator Alignment	33

LIST OF ILLUSTRATIONS

		Page
Fig. 1	Front View - Radio Receiver	iii
Fig. 2	Rear View - Radio Receiver	iv
Fig. 3	Block Diagram of Radio Receiver	1-2
Fig. 4	Top View Radio Receiver Chassis Cabinet Removed	1-7
Fig. 5	Bottom View Radio Receiver Chassis Cabinet Removed	1-8
Fig. 6	Bottom View Antenna Compartment Removed From Chassis	1-9
Fig. 7	Bottom View Mixer Compartment Removed from Chassis	1-10
Fig. 8	Dimensional Outline Drawing Scott Marine Radio Receiver	2-17
Fig. 9	Schematic Diagram RMA Standard Dummy Antenna	7-31
Fig. 10	Trimmer Positions	7-32
Fig. 11	Schematic Diagram Scott Marine Radio Receiver	60

LIST OF TABLES

Table 1	Tube Socket Voltages and Cathode Currents	7-27
Table 2	Point to Point Resistance	7-29
Table 3	Alignment Data	7-34
Table 4	Coil Data	7-35
Table 5	Condenser and Resistor Color Codes	7-39
Table 6	Parts List for Scott Marine Receiver	41



Fig. 1 Front View - Radio Receiver

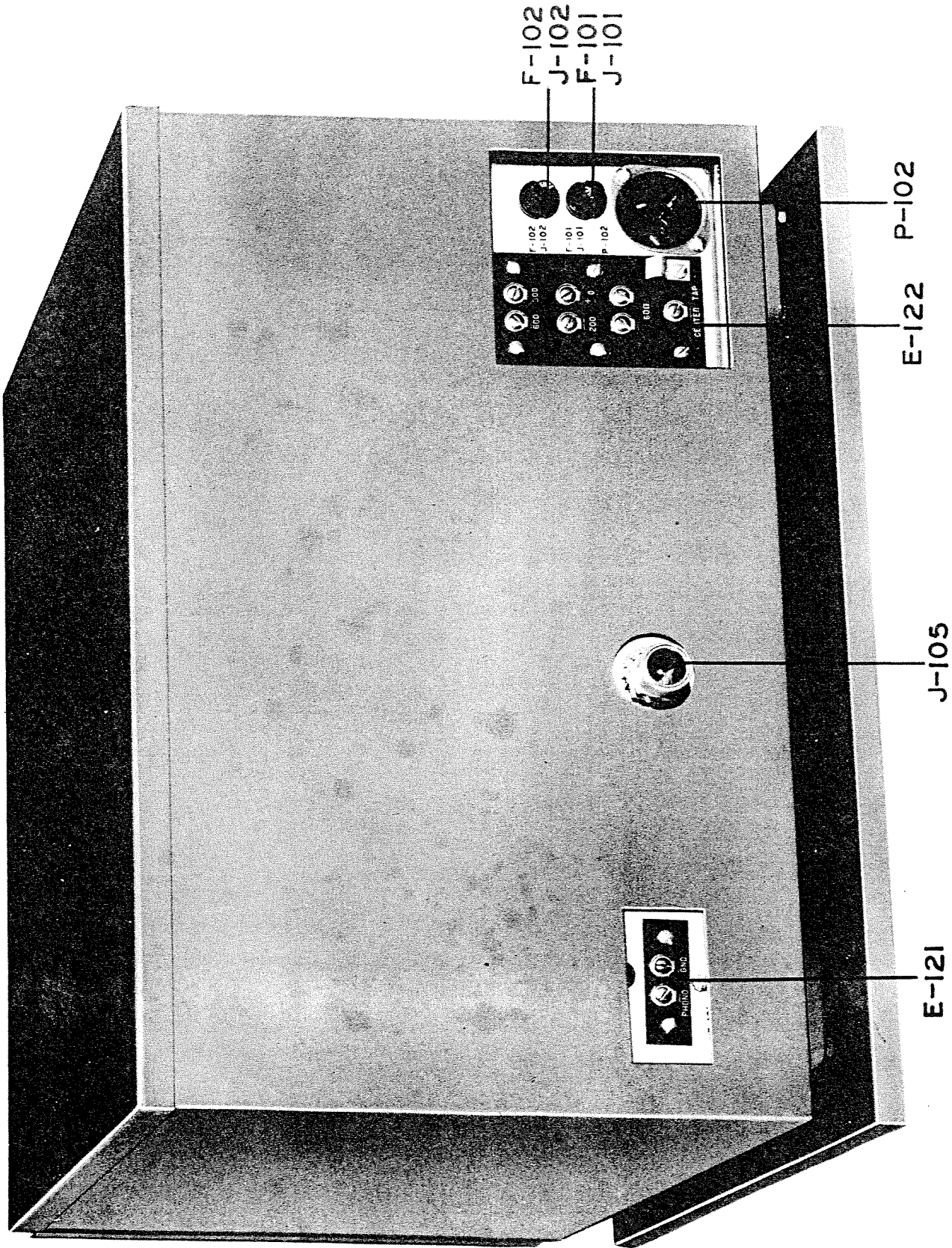

Fig. 2 Rear View - Radio Receiver

Section I GENERAL DESCRIPTION

1. GENERAL

These instructions cover the installation, operation and servicing of the Scott Marine Radio Receiver.

THEY SHOULD BE READ AND STUDIED WITH GREAT CARE BEFORE THE INSTALLATION OR OPERATION OF THE EQUIPMENT IS ATTEMPTED IN ORDER THAT OPTIMUM PERFORMANCE MAY BE OBTAINED.

The Scott Marine Radio Receiver is suitable and is primarily intended for use aboard seagoing vessels of all types. It is equally suitable for use at radio shore stations.

The receiver employs twelve tubes and covers the frequency range of 0.54 to 18.6 megacycles in four frequency bands and is suitable for reception of C.W., M.C.W. and tone modulated signals.

Special circuits and features are incorporated in the Scott Marine Radio Receiver to prevent its oscillator feeding voltages into the antenna circuit and radiating interferences which could be detected by sensitive radio receiving or radio direction finding equipments in the same or close vicinity.

The Scott Marine Radio Receiver is designed for operation from a 115 volt DC source or 115 volt 60 cycle single phase AC source. Power consumption is 78 watts.

The audio frequency circuits of the receiver are designed to permit the use of one pair of standard 600 ohm head telephones separately or in conjunction with a suitable loud-speaker of the permanent magnet type, coupled to the receiver with a 600 ohm matching transformer or with a number of loud-speakers with self-contained amplifiers, installed in various locations throughout the vessel and fed by low impedance transmission lines.

The Scott Marine Radio Receiver consists of one major unit. This unit as supplied, employs the cabinet type of construction and is designed for installation atop an operating table or bench.

All operating controls and phone jack are mounted on the front panel of the receiver. Power, antenna, ground, audio output, record player input and fuses are located at the rear of the receiver.

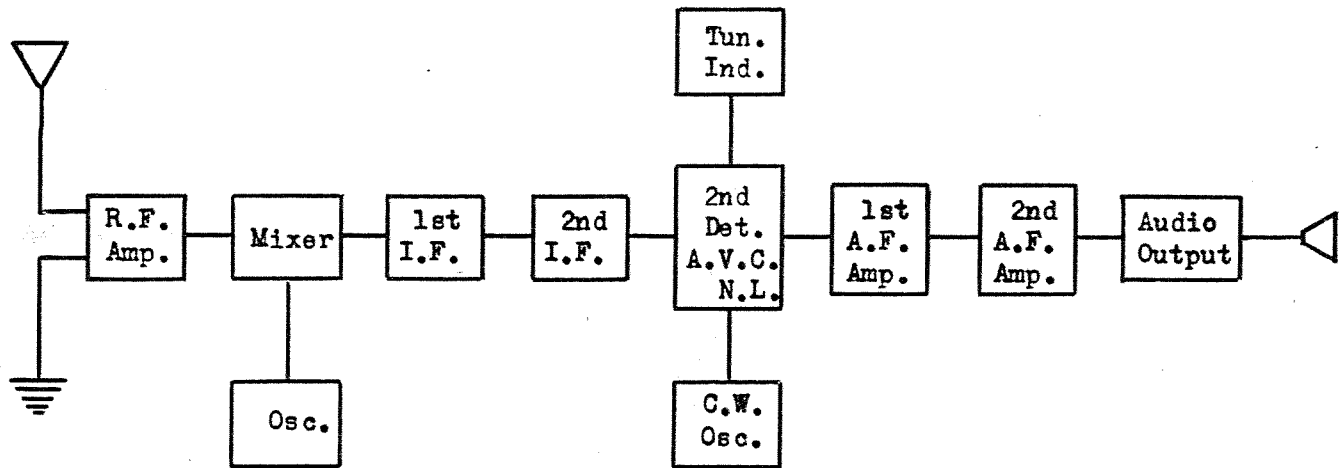

Fig. 3 Block Diagram of Radio Receiver

2. DESCRIPTION

2.1 General

The Scott Marine Radio Receiver is a superheterodyne type receiver. The electrical circuits employed for signal reception on all frequency ranges comprise one stage of R.F. amplification, first detector or mixer, a separate high frequency oscillator, two stages of intermediate frequency amplification operating at 455 kilocycles, a diode type second detector, two stages of resistance coupled audio amplification, and a push pull audio frequency power output stage. The second detector utilizes one set of elements of a dual diode, the other set of elements is utilized for an efficient peak noise limiter. A separate stage is provided for the C.W. oscillator. A self contained power supply provides the necessary DC voltages for operation of the receiver from either an AC or DC power source. Inverse feedback is incorporated on the 60 ohm audio output winding of the output transformer to maintain a relatively constant voltage across the primary of the output transformer when the output load, connected to the 60 ohm winding, is varied upon connection of one or more amplifier type loudspeakers.

2.2 Frequency Range

The receiver covers the frequency range of 0.54 to 18.6 megacycles in four bands as follows:

Band	Frequency range
1	0.54 - 1.6 megacycles
2	1.35 - 3.58 megacycles
3	3.4 - 8.8 megacycles
4	8.5 - 18.6 megacycles

2.3 Audio Output Connections

A phone jack is mounted on the front panel and is supplied from one of three secondary windings of the output transformer. A maximum of 100 milliwatts in a 600 ohm load is available at the phone jack.

The same secondary winding which supplies output to the phone jack is also connected to three terminals at the rear of the receiver, marked 60 ohms and center tap. This winding is centertapped for balanced line operation and is capable of supplying, by virtue of the inverse feedback associated with the audio circuits of the receiver, substantially constant voltage at the 60 ohm terminals of the receiver, for any variation in load impedance from 60 to 600 ohms. Undistorted audio output of 1.5 watts in a load of 600 ohms is available at these terminals. A second winding of the output transformer is connected to four terminals at the rear of the receiver, marked 0, 200, 300, 600. These terminals are provided for connection of one, two or three loudspeakers of the permanent magnet type having a matching transformer of 600 ohm input impedance. Undistorted audio output of 1.5 watts is available at these terminals.

FOR ANY INSTALLATION, ONLY ONE OF THE TWO SETS OF SPEAKER TERMINALS MAY BE EMPLOYED AT ANY ONE TIME FOR SUPPLYING AUDIO POWER TO LOUD SPEAKER CIRCUITS. Head-telephones may be used at any time in conjunction with either of the speaker connections.

A third winding of the audio output transformer is used to supply audio output to a monitor speaker mounted on the front panel. Undistorted audio output of 0.5 watts is available for the monitor speaker.

2.4 Antenna Connections

A concentric line jack J-105 is mounted at the rear of the receiver for antenna and ground connections. A concentric line plug P-101, which mates with the concentric jack is furnished as part of the equipment.

The input circuit of the Receiver is primarily designed for operation with a separate antenna not used for other equipment. A conventional single wire antenna will suffice. Such a single wire antenna should be spaced at least six feet away from any parallel stay, mast or stack. It should be well insulated and erected as high as possible. The recommended minimum overall length of antenna and lead-in is fifty feet. The antenna proper should be erected out in the open as much as possible. (A one-half megohm static-drain resistor should be permanently installed between the antenna and ground.

In an installation having a simple antenna-ground combination, solder the antenna lead-in to the center pin of the antenna plug P-101 and solder the ground lead to the shell of this plug. CAUTION: BEFORE CONNECTING A GROUND OF ANY KIND MAKE CERTAIN THAT THE POWER PLUG IS PROPERLY POLARIZED. See Para. 14.1

2.5 Power Requirements

The Radio Receiving Equipment is designed to operate from either 115 volts DC or 115 volts 60 cycle single phase AC. Line current at 115 volts is .62 amperes. The nominal power consumption at 115 volts AC or DC is 78 watts.

Connection to the power source should be made through the polarized receptacle J-103 at the rear of the receiver. This receptacle is a three pole polarized receptacle. Number one and three poles are used for connection to the power source and number two pole is grounded to the chassis frame. A mating plug P-102 is furnished for connection to the power source. The two leads of the power line should be connected to terminals one and three and the shield of the power cable connected to terminal two. When the receiver is to be used on a DC power source the polarity of the power source must be ascertained and the positive side connected to terminal 1 of the power input plug P-102, the negative side of the DC line should then connect to terminal 3 of plug P-102. The fuses in the power supply line are mounted adjacent to the power input receptacle at the rear of the receiver. The fuse mountings are of such design that the fuse, which is of the cartridge type, is replaceable without the use of tools, and without the necessity for the removal of the receiver chassis from its cabinet.

2.6 Record Player Connections

Provision is made at the rear of the chassis for connection of a record player pickup of the high-impedance type. A low impedance pickup may be used with the proper matching transformer.

2.7 Tube Complement

The vacuum tubes employed in the Scott Marine Radio receiver are as follows:

Symbol	Tube Type	Function
V-101	6K7	R.F. amplifier
V-102	12J5GT	H.F. oscillator
V-103	12SA7	First detector mixer
V-104	12SK7	First IF amplifier
V-105	12SK7	Second IF amplifier
V-106	12H6	Second detector, AVC, N.L.
V-107	12SN7GT	First audio, C.W. oscillator
V-108	12SN7GT	Second audio, phase inverter
V-109	25L6GT	Output audio amplifier
V-110	25L6GT	Output audio amplifier
V-111	1629	Tuning indicator
V-112	25Z6GT	Rectifier

3. CONSTRUCTION

The Scott Marine Radio Receiver is primarily designed for top of table or bench mounting. It is furnished with its chassis housed in a metal cabinet supported with rubber shock-mounts. The front panel to which the chassis is secured, forms the enclosure for one side of the cabinet. The general appearance and type of construction employed are shown in Figures 1 and 2. Clearance apertures in the rear provide access to the antenna and power receptacles, fuses, speaker and record player connections.

When the chassis assembly is housed in the cabinet, it is secured to the cabinet by the front panel through the use of eight knurled, captivated type thumb screws, which pass through four slots in opposite edges of the panel and engage with nuts in the flanged sides of the front opening of the cabinet. The captivated type thumb screws are retained, when loosened, in groups of four in removable angles which also serve as "trim" for the front side corners of the cabinet, by concealing the mounting screw slots in the front panel. Two knobs are conveniently arranged on the front panel to permit the insertion and removal of the chassis assembly without subjecting any of the operating controls to strain.

The construction of the chassis assembly and the arrangement and mounting of the component parts are clearly depicted in Figures 4 and 5. All vacuum tubes are accessible from the top side of the chassis upon removal of the chassis from the cabinet. The design and construction of the chassis assembly and arrangement of the component items provides a high degree of accessibility to all items for inspection, servicing or replacement. A bottom cover plate, not shown in Figure 5 completely encloses the bottom of the chassis proper. It is provided as an added shielding feature, and for the protection of the underside chassis mounted components against damage due to careless handling. It is secured to the chassis with captive type screws so that it is readily removable.

The receiver panel layout is shown in Figure 1 and the location and functions of the various controls are described in Section IV.

The Radio Receiver is designed to minimize radiation from the high frequency oscillator. This is accomplished by isolating the antenna input circuits from the first detector (or mixer) and the high frequency oscillator circuits, through the use of extensive shielding and filtering.

A separate shielded compartment, designed as a complete sub-assembly and easily detachable from the chassis for inspection or servicing of component parts, contains all the R.F. transformers and associated switches for the antenna section of the receiver. This sub-assembly as shown in Figure 5 is mounted at the rear under side of the chassis. Details of the construction and arrangement of the component parts is shown in Figure 6 which shows the compartment with the cover removed.

A second shielded compartment, constructed and mounted in the same manner as for that containing the antenna circuit elements, but larger in overall dimensions contains all the R.F. transformers and associated switches for the mixer and oscillator circuits. The arrangement of the component parts is shown in Figure 7 which shows the unit with the shield cover removed.

The R.F. amplifier tube is mounted in a horizontal position in a socket which is provided with a clamp for securely grounding the tube shell. The socket is mounted at the rear of the receiver chassis and is completely shielded with a removable shield cover.

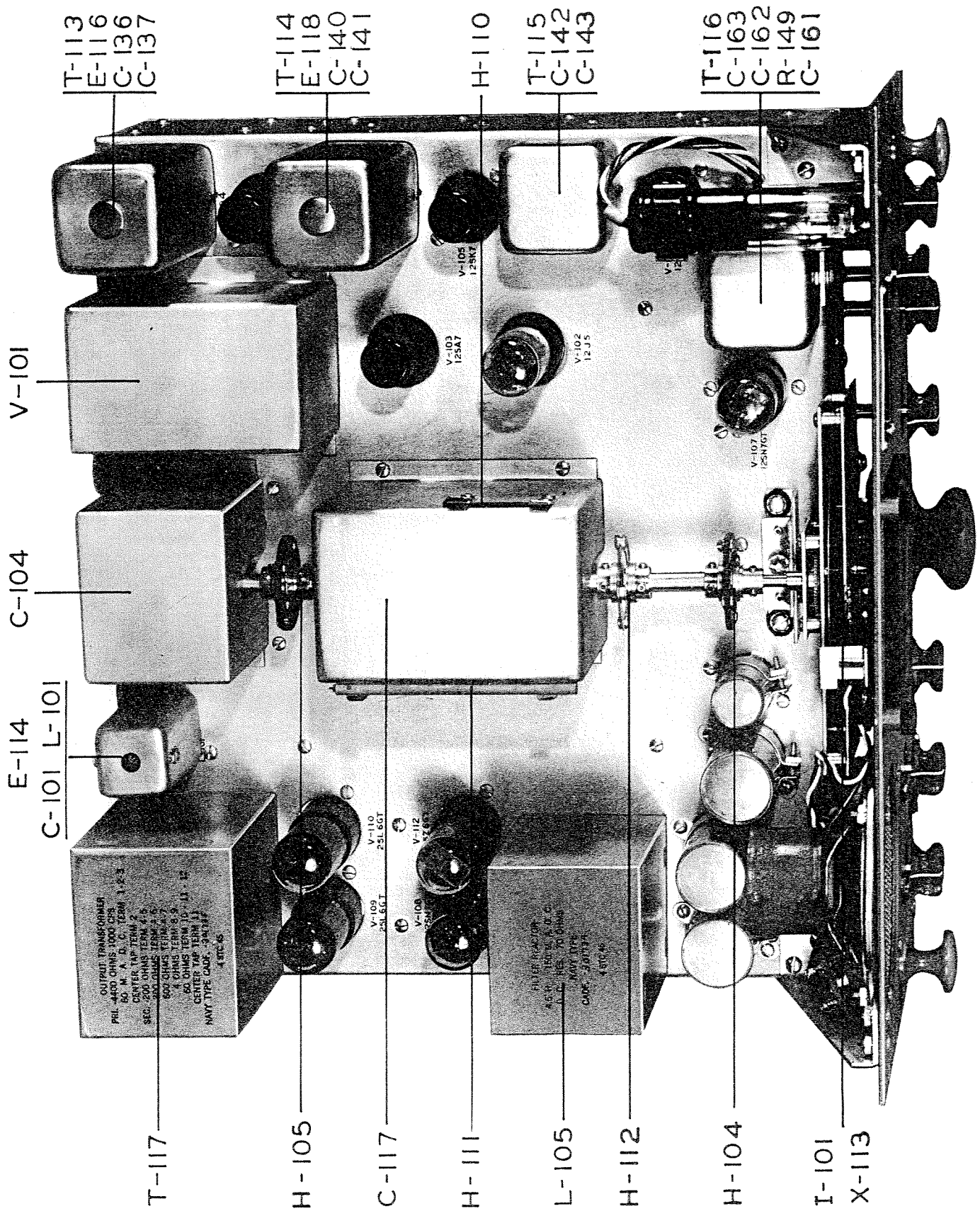

Fig. 4 Top View Radio Receiver Chassis

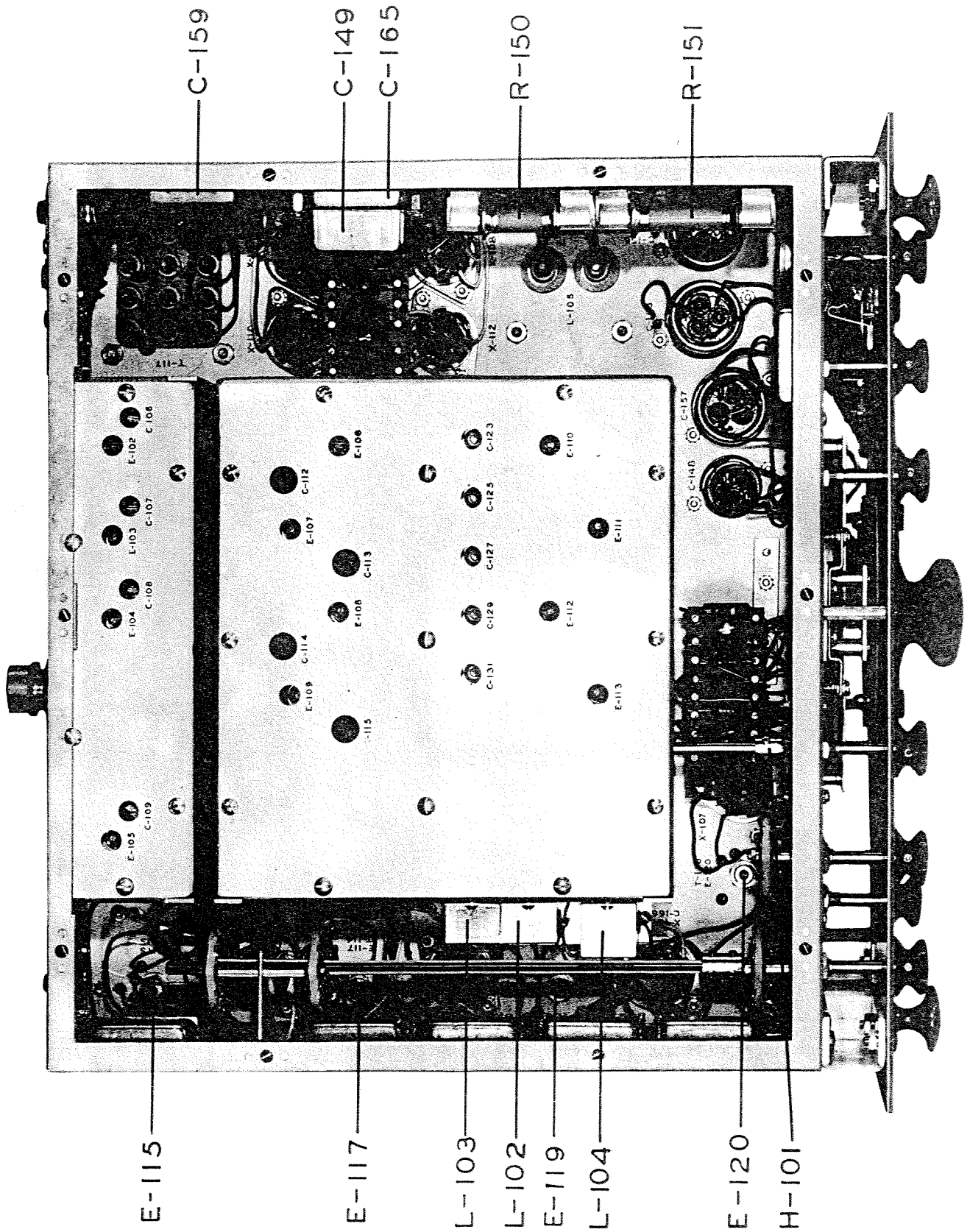

Fig. 5 Bottom View Radio Receiver Chassis

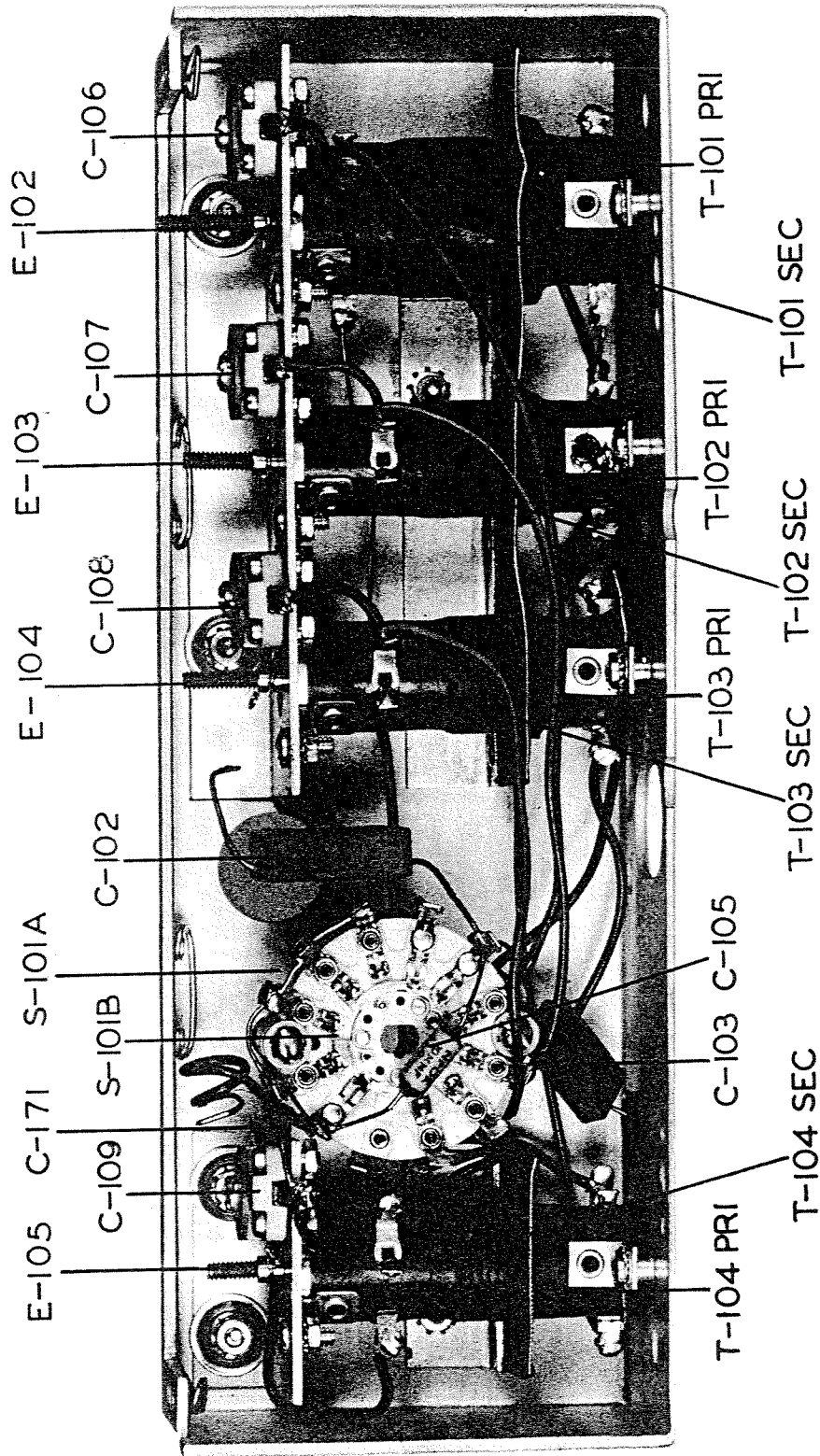

Fig. 6 Antenna Compartment Removed
From Receiver Chassis

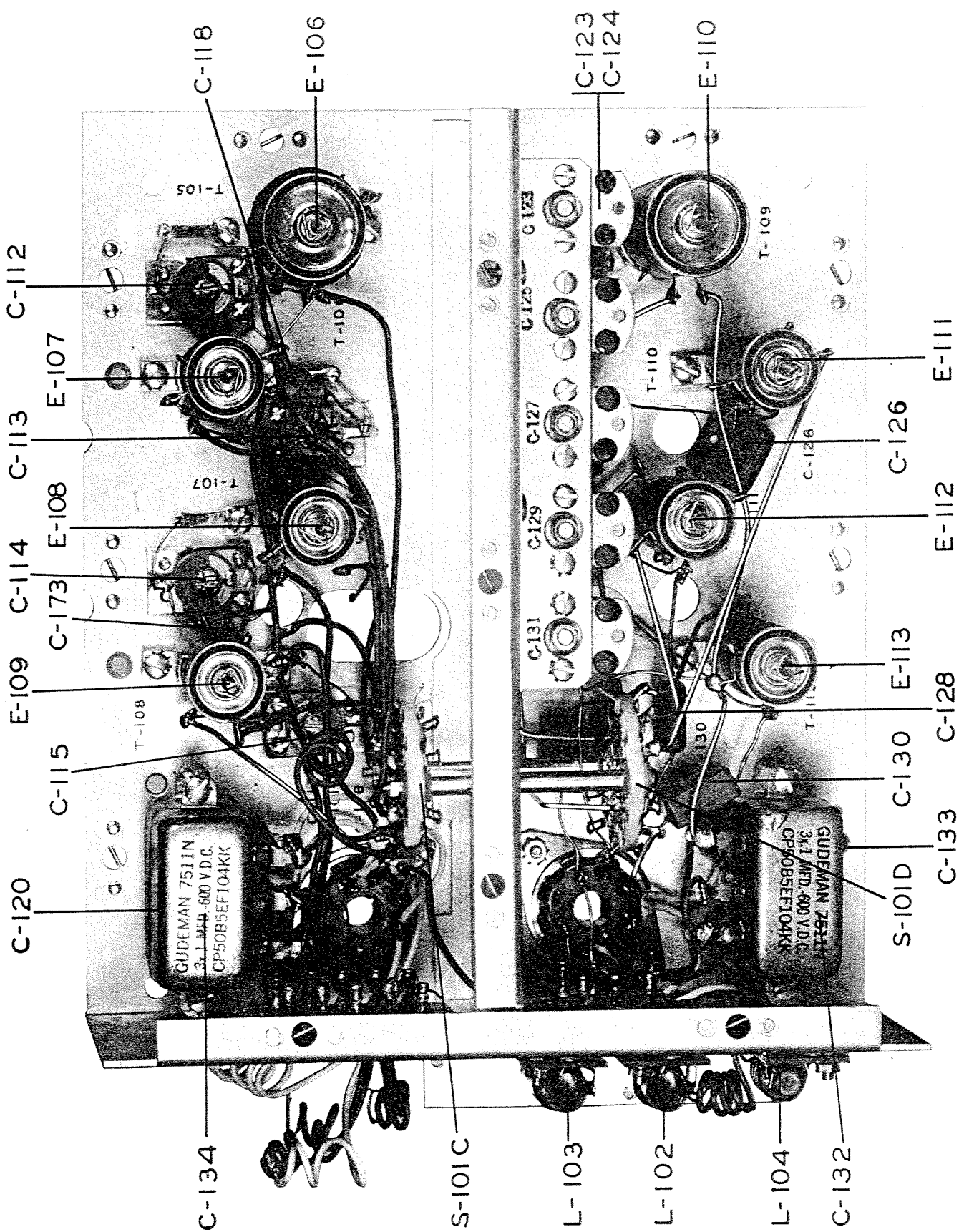

Fig. 7 Mixer Compartment Removed From Receiver Chassis

Section II CIRCUIT DESCRIPTION

4. GENERAL

The actual schematic diagram of the Scott Marine Radio Receiver is shown in Figure 11. For purposes of illustration, it will be assumed that the circuits are set up as for signal reception on Band 1 (.54 - 1.6 MC) as shown in the diagram. The following description will refer therefore, to the symbol numbers of the circuit elements of this band. It shall be assumed that unless otherwise noted, the description will be equally applicable to Bands 2 - 3 - 4.

5. SIGNAL FREQUENCY CIRCUITS

Signal input to the receiver through concentric jack J-105 is connected to the primary winding of antenna input transformer T-101 by switch S-101A. Wave trap inductor L-101 is provided to attenuate signals at IF frequency (455 KC). This circuit is tuned by series connected capacity C-101 and tuned to 455 KC by adjustable iron core E-114. An electrostatic shield, at ground potential, separates the secondary winding from the primary winding. The secondary winding together with variable air dielectric capacitor C-104 (A and B) constitutes the first tuned circuit. Transfer of r-f signal, at the resonant frequency of this tuned circuit, from the antenna to the control grid of R.F. amplifier tube V-101, is accomplished by inductive coupling through antenna input transformer T-101. Variable capacitor C-104 is a two section capacitor, both sections being connected in parallel on Bands 1, 2, and 3 by means of switch S-101B. On Band 4, capacitor section C-104B is switched out of the circuit and C-104A alone used. Variable capacitor C-104 is ganged with variable capacitor C-117 to provide uni-controlled tuning of the receiver. The secondary winding of transformer T-101 is provided with an adjustable iron core for inductance trimming and a shunt connected variable trimmer capacitor C-106. These trimmer elements permit the accurate alignment of the tuned circuit at both ends of the frequency band and are accessible for adjustment as shown in Figure 5. The high potential end of the tuned circuit is connected to the control grid of R.F. amplifier tube V-101 by switch S-101B and through coupling capacitor C-103. The low potential end of the tuned circuit is returned to chassis ground. The d-c bias return from the control grid of R.F. amplifier tube V-101 to the A.V.C. line is closed through resistor R-101.

Plate potential from the high voltage d-c line is applied to the plate of R.F. amplifier tube V-101 through decoupling resistor R-109, bypassed to ground by capacitor C-134A and through R.F. transformer T-105 primary. Screen potential is applied through resistor R-103 bypassed by capacitor C-111B. The suppressor is connected to the cathode. Initial grid bias is obtained by means of cathode resistor R-102 bypassed by capacitor C-111A. One side of the heater of V-101 connects to the power input circuit, the other side connects to the heater of V-107.

The amplified signal from the plate of R.F. amplifier tube V-101 is transferred to the signal grid of mixer tube V-103, through R.F. transformer T-105. The primary of T-105 is untuned, the secondary winding together with variable capacitor C-117 (A and B) constitute the second and final tuned circuit operating at signal frequency. The high potential end of the tuned circuit is connected to the signal grid of mixer tube V-103 by switch S-101C through coupling capacitor C-116. The low potential end of the tuned circuit connects to chassis ground. Adjustable iron core E-106 and parallel connected trimmer capacitor C-112 are provided for purposes of circuit alignment. The DC bias return from the control grid of mixer tube V-103 to the AVC line is closed through resistor R-104 and filter resistor R-113 bypassed to ground by capacitor C-144A.

Screen potential from the high voltage DC line is applied to the screen of mixer tube V-103 through resistor R-108 bypassed to ground by capacitor C-134B. The suppressor is internally connected to the shell of the tube. Initial bias is obtained by means of cathode resistor R-106 bypassed to ground by capacitor C-120B.

6. HIGH FREQUENCY OSCILLATOR CIRCUITS

The high frequency oscillator circuit is of the "electron-coupled" type. The tuned circuit consists of tapped inductor T-109, shunted with variable trimmer capacitor C-125 and is tuned by variable capacitor C-117 (C and D). Inductor T-109 is provided with an adjustable iron core for inductance adjustment. Fixed capacitor C-124 shunted by variable trimmer capacitor C-123 is provided to modify the tuning of the H.F. oscillator so that it will maintain a fixed frequency difference of 455 kilocycles with respect to the signal frequency when tuning capacitors C-104, C-117AB and C-117CD are varied from minimum to maximum capacity.

The high potential end of the tuned circuit is connected to the control grid of H.F. oscillator tube V-102, through switch S-101D and fixed capacitor C-122. This grid is returned to the ground bus through resistor R-110 and RF choke L-104. The low potential end of the tuned circuit is also returned to the ground bus through RF choke L-104. The cathode of the H.F. oscillator tube V-102 is connected to the tap of inductor T-109 through switch S-101D and through coupling capacitor C-121 to the oscillator injector grid of mixer tube V-103. This grid is returned to ground bus through resistor R-107. The plate of the H.F. oscillator tube V-102 is connected to the high voltage DC line through resistor R-111 and R-116 bypassed to ground by capacitor C-132A, C-132B and C-138B. One side of the heater circuit of the H.F. oscillator tube V-102 connects to the power input line through RF choke L-103 bypassed to ground by capacitor C-133A. The other side of the heater connects to the heater of second detector tube V-106 through RF choke L-102, bypassed to ground by capacitor C-133B.

7. I.F. AMPLIFIER CIRCUITS

The signal frequency arriving at the control grid of mixer tube V-103 and the H.F. oscillator frequency arriving at the injector grid of this tube are mixed (or heterodyned) and the resultant difference frequency (455 kilocycles) is fed to the input of the I.F. amplifier.

Transfer of IF signal from the plate of the mixer tube V-103 to second detector tube V-106 is accomplished by inductive coupling through IF transformers T-113, T-114, T-115 and amplified by tubes V-104 and V-105. First IF transformer T-113 consists of two tuned circuits, primary and secondary with the secondary tuned circuit operating in conjunction with switch S-102A and a tapped tertiary winding, to provide three degrees of selectivity by changing the coefficient of coupling with the primary circuit. The primary and secondary windings are each tuned to 455 kilocycles by fixed capacitors C-136 and C-137 and adjustable iron cores E-115 and E-116. These cores are accessible for adjustment through the top of the shield can for E-116 and at the bottom of the receiver for E-115. The high potential end of the primary tuned circuit connects to the plate of mixer tube V-103 through a shielded conductor while the low potential end connects to the high voltage DC line through resistor R-112, bypassed to ground by capacitor C-135A. The high potential end of the secondary tuned circuit is connected to the grid of first IF amplifier tube V-104 while the low potential end is connected to the AVC line through resistor R-105, bypassed to ground bus by capacitor C-138A. DC potential from the high voltage DC line is applied to the screen and plate of first IF amplifier tube V-104 through resistor R-115, bypassed to ground by capacitor C-135B. Initial cathode bias is obtained through resistor R-114, bypassed to ground by capacitor C-139A. The suppressor is connected to the ground bus. One side of the heater of the first IF amplifier tube V-104 is connected to the heater of tuning indicator tube V-111. The other side of the heater connects to the heater of mixer tube V-103.

Second IF transformer T-114 is identical to first IF transformer with respect to design, construction, and operating characteristics accordingly, except for differences in symbol designations. The circuit description of first IF transformer T-113 is applicable to this transformer.

The circuit arrangement of second IF amplifier tube V-105 is the same, except for symbol designations as for first IF amplifier tube V-104 except that the grid is returned to ground bus instead of A.V.C. One side of the heater of second IF amplifier tube V-105 connects to the heater of mixer tube V-103. The other side of the heater connects to the heater of second detector tube V-106.

Third IF transformer T-115 consists of a tuned primary circuit and an untuned secondary. The primary circuit consists of the primary winding shunted by a fixed capacitor C-142 and permeability tuned by iron core E-119 which is accessible for adjustment at the bottom of the chassis. Plate potential is applied to the plate and screen of second IF amplifier tube V-105 through resistor R-118, bypassed to ground by capacitor C-135C. The high potential end of the secondary winding feeds the second detector diode while its low potential end connects to ground bus through diode load resistors R-119 and R-120.

8. SECOND DETECTOR CIRCUITS

Tube V-106 is a dual diode tube, one section V-106A, is used as a second detector, the plate of which is connected to the high potential end of the secondary winding of the third IF transformer T-115. The cathode is connected to ground bus, thus the tube acts as a half wave rectifier. The voltage appearing across diode load resistors R-119 and R-120 is filtered by resistor R-121 and capacitor C-144B and the resulting direct current AVC voltage is used to control the gain of amplifier tubes V-101, V-103, V-104, the degree of control being dependent on the strength of the incoming signal.

The second section V-106B of the twin diode tube V-106 is utilized as a peak noise limiter. The audio voltage appearing at the junction of R-119 and R-120 as a result of the demodulating action of the second detector V-106A, is normally coupled to the input of the first AF amplifier when switch S-102C is set at the center ("OFF") position. When switch S-102C is set at the left ("N.L.") position, the input to the first audio amplifier is coupled to the cathode of V-106B which is biased negative by DC voltage developed across filter resistor R-122 and capacitor C-119A. In operation under conditions of reception of a steady signal or a signal which varies slowly in amplitude, the plate of V-106B is positive with respect to its cathode, thus permitting the audio voltage appearing on the plate of V-106B to be conducted to the cathode and then to the input of the first A.F. amplifier tube. If a surge noise potential suddenly appears across the diode load resistor R-119 and R-120 the plate momentarily assures a less positive or even a negative potential with respect to its cathode and the input to the audio amplifier is momentarily cut off. By the time the cathode has begun to assume an appreciably higher negative potential, the noise pulse will usually have decayed and the diode will again conduct allowing input to the audio amplifier.

DC potential from the A.V.C. line if further filtered by resistor R-145 and capacitor C-119B and applied to the control grid of electron-ray indicator V-111. This DC voltage regulates the shadow angle of the electron-ray tube to indicate when the receiver is tuned to resonance with the received signal.

9. C. W. OSCILLATOR CIRCUITS

One section of dual triode tube V-107 is utilized as a C.W. oscillator. The C.W. oscillator circuit normally operates at the IF frequency 455 kilocycles. It provides an R.F. potential with which an unmodulated IF signal at the second detector can heterodyne to produce an audible beat note and is intended for the reception of C.W. signals. The frequency of the C.W. circuit is determined by inductor T-116, parallel connected capacitor C-162 and adjustable iron core E-120. A variable air trimmer capacitor C-163 is connected across inductor T-116 and is controlled from the front operating panel, this capacitor is provided to control the frequency of the C.W. oscillator circuit within narrow limits. DC potential is applied to the plate of C.W. oscillator tube V-107B through switch S-102C and resistor R-143, bypassed to ground by capacitor C-160.

10. A. F. AMPLIFIER CIRCUITS

The A.F. voltage developed across the diode load resistors R-119 and R-120 as a result of the demodulating action of second detector diode V-106A, is applied to the control grid of first A.F. amplifier tube V-107A, through capacitor C-145 and A.F. gain potentiometer R-125.

Switch S-103 operates to transfer the audio input to A.F. gain control R-125 and hence the input circuit of the first A.F. amplifier tube V-107A from the second detector circuit to "PHONO" terminals E-121 to permit the operation of the audio amplifier system of the receiver with a high impedance record player pick-up. Low impedance pick-ups may also be employed provided that their connection to terminals E-121 are made through suitable matching transformers.

Amplification of the A.F. signals from the second detector is accomplished by resistance-capacity coupling between first A.F. amplifier tube V-107A and output power amplifier tubes V-109 and V-110. Transfer of audio frequency energy from the plate of output amplifier tubes V-109 and V-110, to head telephone jack J-104 and loud speaker terminal E-122 is accomplished through output transformer T-117 which matches the plate impedance of the tube with the various output loads with which the receiver is designed to work.

Resistor R-141 is connected in the phone jack circuit to reduce the maximum undistorted output available at the phone jack to approximately 100 milliwatts.

Inverse feedback is provided for the first and second A.F. amplifier circuits to maintain constant voltage output across the 60 ohm speaker terminals for a variation in output load impedance of 60 to 600 ohms.

DC potential is applied to the plate of first A.F. amplifier tube V-107A through plate load resistor R-128 and filter resistor R-129, bypassed to ground bus by electrolytic capacitor C-148. Bias is applied to the cathode through resistor R-126 which returns to ground bus. One side of the heater of V-107 connects to the heater of V-101, the other side connects the heater of V-108.

A.F. signal from the plate of first audio tube V-107A, is transferred to the grid of second audio tube V-108 through capacitor C-147 and series resistor R-130. The grid of V-108A is returned to ground bus through resistor R-131.

A.F. signal from the plate of V-108A is fed back through capacitor C-150 and resistor R-134 in series, to the grid of V-108B. This signal will be 180 degrees out of phase with that appearing on the plate of V-108B therefore, the two triode sections of V-108 will act as a push-pull driver. The grid of V-108B is returned to ground bus through resistor R-133. DC potential is applied to the plate of V-108A through resistor R-136 and to the plate of V-108B through resistor R-135. Bias is applied to the cathodes of both triode sections through resistor R-132 bypassed by electrolytic capacitor C-149.

A.F. signal is transferred from the plate of V-108A to the grid of V-109 through capacitor C-152 and from the plate of V-108B to the grid of V-110 through capacitor C-153. The grid of V-109 is returned to minus seven volts through resistor R-140 and the grid of V-110 is returned to minus seven volts through resistor R-139. Capacitor C-151 is connected across both grids to prevent parasitic oscillation due to unbalance in the push-pull amplifier.

DC potential is applied to the plates of output amplifier tubes V-109 and V-110 through output transformer T-117 primary which is centertapped. The cathodes of V-109 and V-110 are returned to ground bus. One side of the heater V-109 connects to the heater of V-108, the other side connects to the heater of V-110, the other side of the heater of V-110 connects to the heater of V-112.

AF signal from the plate of V-109 is fed back to the plate of V-108A through resistor R-137 and from the plate of V-110 to the plate of V-109B through resistor R-138. This feedback arrangement is provided to supply more constant voltage output at the loudspeaker terminals when the output load impedance is varied.

Variable potentiometer R-152 and series connected capacitor C-170 constitute the control for regulating the fidelity of the audio amplifier system of the receiver. The series combination is connected across the plates of twin triode tube V-108.

Output transformer T-117 is provided to transfer the A.F. signal from the audio amplifier of the receiver to the loudspeaker connections.

11. RECTIFIER POWER CIRCUITS

The Scott Marine Radio Receiver is designed for AC-DC operation, therefore, no power transformer is used. The heaters of all tubes are connected in series in two circuits. In one circuit V-101, V-107, V-108, V-110, V-109 and V-112 are connected in series with resistor R-150. The other heater circuit consists of V-102, V-106, V-105, V-103, V-104 and V-111 in series with resistor R-151.

Rectifier tube V-112 is utilized to supply DC potential for operation of the receiver when used with an AC power source. The pulsating DC potential from the cathodes of V-112 is filtered by iron core inductor L-105 and electrolytic capacitors C-156, C-157 and C-158A.

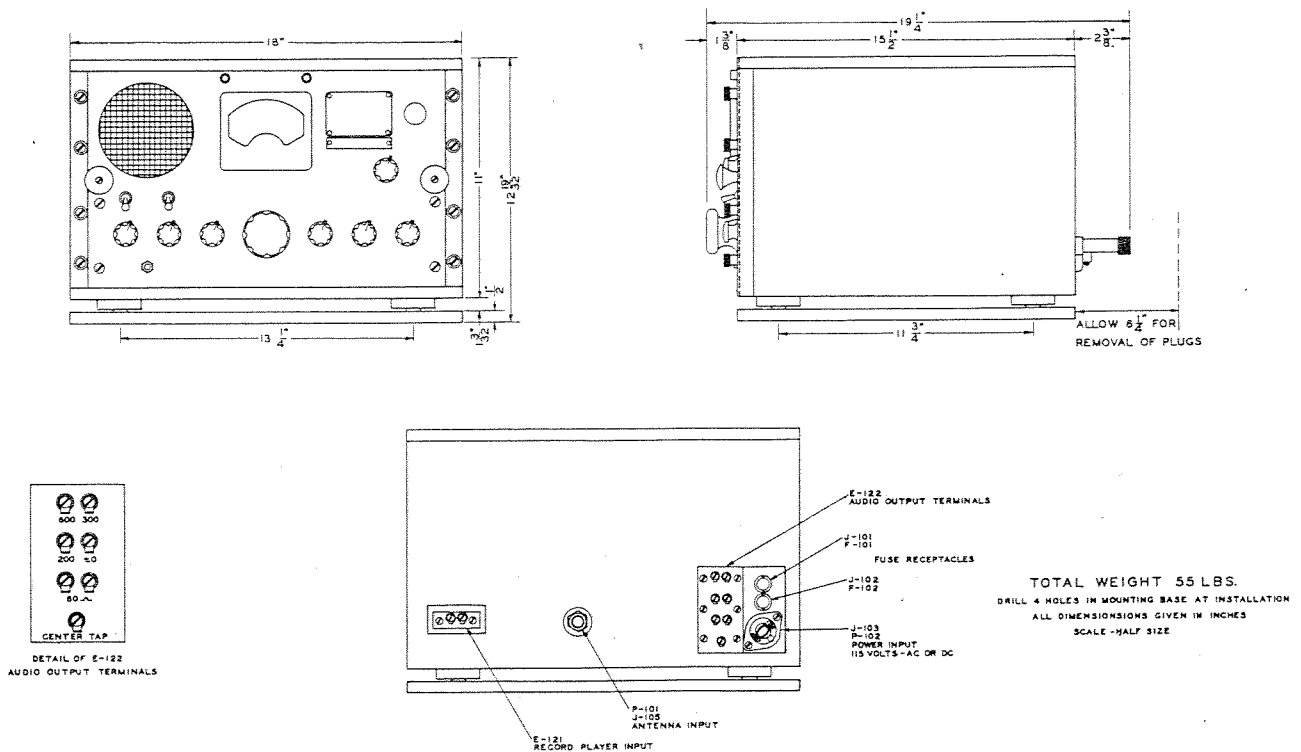

Fig. 8 Dimensional Outline Drawing
Scott Marine Radio Receiver

Section III INSTALLATION AND INITIAL ADJUSTMENTS

12. UNPACKING THE EQUIPMENT

After unpacking the equipment, it should be inspected for any possible damage that might have resulted from careless handling in transit. Make certain that all vacuum tubes are firmly seated in their sockets.

13. INSTALLATION

in planning an installation a location should be selected which is close to the antenna lead-in and power source. Care should be taken to provide adequate clearance from the back of the receiver to the bulkhead or nearest obstruction in order to provide access to the power input plug, antenna-ground plug, speaker output or record player input connections and fuse receptacles.

For a permanent installation, four holes, large enough to pass 3/8 inch bolts should be drilled in the mounting base of the cabinet which can then be mounted on the bench or table.

14. CONNECTIONS TO RECEIVER

14.1 Power Connections

The Receiver may be operated from a 115 volt DC supply or 115 volts 60 cycle single phase power source. Connection to the power source should be made by means of the three terminal polarized plug furnished with the equipment. CAUTION: When a DC power source is used, the positive side of the power source must be connected to terminal (1) of the power supply plug. When using an AC source the ungrounded side of the power plug. When using an AC source the ungrounded side of the power source must be connected to pin #1 of the power plug. An electrician's test lamp may be used to check polarity.

14.2 Antenna Connections

Antenna and ground connections are made to the receiver through the concentric line plug furnished with the equipment. Connections should be made as outlined in Paragraph 2.4.

14.3 Loudspeaker Connections

The Radio Receiving Equipment is primarily designed to be operated with a separate system of remotely located, parallel connected speaker amplifiers. The number of such units being governed by the size and type of vessel, and the number of loud speaker positions desired throughout the vessel. Connection between the remotely installed speaker amplifiers and the Radio Receiver should be made with two conductor shielded cable. The two conductors being connected to the speaker output terminals marked 60 ohms and the shield connected to the terminal marked CENTER TAP which is grounded to the chassis internally.

In installations where speaker amplifiers are not used, provision is made at the rear of the receiver for connection of one, two or three loudspeakers having a 600 ohm input impedance. If one loudspeaker is used, connection should be made to terminals 0-600. If two speakers are used, 0-300 and if three speakers are used terminals 0-200.

CAUTION: FOR ANY INSTALLATION, ONLY ONE SET OF LOUDSPEAKER TERMINALS SHOULD BE UTILIZED AT ANY ONE TIME.

14.4 Record Player Connections

A record player pickup may be connected to the terminals marked "PHONO" located at the rear of the chassis. If the pickup is high impedance such as a crystal, direct connection may be made. If the pickup is low impedance, a matching transformer must be used.

14.5 Installation Inspection

Before turning the receiver on, inspect all connections to ascertain that they have been properly made. Then set the panel controls as follows:

1. Monitor switch in monitor position.
2. R.F. gain control set at zero.
3. Fidelity control set at ten.
4. A.F. gain control set at zero.
5. Band selector control set to frequency band in which signals are desired.
6. N.L. control to center "OFF" position.
7. Selectivity control to "S" position.
8. C.W. oscillator control set at zero.

The equipment is now ready for operation and is turned on by means of switch S-104 when set at "Power" position.

Section IV OPERATION

15. OPERATION OF CONTROLS

All switches and controls (with the exception of the main tuning control) of the Type CZC-46270 Radio Receiver are identified by panel engraving.

For reception of Broadcast of M.C.W. signals the following procedure should be followed:

1. Set POWER switch to "Power" position.
2. Set MONITOR speaker switch to "Monitor" position.
3. Set BAND SELECTOR control to frequency band in which the desired signal is located.
4. Set SELECTIVITY control at "S" position.
5. Set N.L. control to "OFF" position.
6. Advance A.F. GAIN control to suitable noise level.
7. Tune the receiver to the approximate station frequency by means of the main tuning control. Slowly rotate the tuning knob back and forth until the signal is properly tuned in as indicated by tuning indicator tube.
8. Adjust the A.F. GAIN control to the proper output level.
9. Adjust the FIDELITY control to the desired position to eliminate background noise.

With the receiver set up as for M.C.W. reception as outlined above, the R.F. Gain Control and C.W. Oscillator controls are not effective.

For reception of C.W. signals the controls should be adjusted as follows:

1. Set POWER switch at "Power" position.
2. Set MONITOR speaker switch at "Monitor" position.
3. Set BAND SELECTOR control to frequency band in which the desired signal is located.
4. Set SELECTIVITY control at "C.W." position.

5. Set N.L. control at "OFF" position.
6. Set the A.F. GAIN control to 10.
7. Advance the R.F. GAIN control to suitable noise level.
8. Set C.W. OSCILLATOR control at 0.
9. Tune the receiver to the approximate station frequency by means of the main tuning control. Slowly rotate the tuning knob back and forth until the signal is at maximum volume.

The setting of the C.W. OSCILLATOR control will depend upon operating conditions. When the received signal is free from interference and is sufficiently strong to override static and circuit noise it is recommended that the C.W. OSCILLATOR be set at 0. As the control is turned to either side of zero, the C.W. Oscillator is detuned from the IF frequency of the receiver; the operator can determine the extent of this deviation by listening to the pitch of the background and circuit noises. When the pitch of the beat note is 2000 or 3000 cycles, it will be found that the receiver has definite "single signal" properties such that one side of the audio beat note of a received signal will be considerably louder than the other side. This characteristic is helpful in receiving weak signals through interference and utilizes the maximum available sensitivity and selectivity of the receiver.

If conditions of reception are such that peak noise levels interfere with received signals, the N.L. control should be set to the N.L. ON position. Under these conditions the peak noises will be chopped off and signals may be received through heavy interference.

Under conditions of reception for M.C.W. signals, in order to widen the IF selectivity and pass a wider band of frequencies for better fidelity, the SELECTIVITY control should be set at "M", "B" or "HF" position to suit conditions.

Section V OPERATORS MAINTENANCE

NOTE: SERVICE - EITHER ELECTRICAL OR MECHANICAL, SHOULD BE ATTEMPTED ONLY BY QUALIFIED PERSONNEL AUTHORIZED FOR SUCH WORK.

Operation of this equipment involves the use of high voltages. Operating personnel must at all times observe all safety regulations.

Trouble free reception will be insured through the proper installation and operation of the receiver and through the use of periodic inspections.

16. PERIODIC INSPECTIONS SHOULD BE MADE AS FOLLOWS

1. Daily: Operational check. Tune receiver through each frequency band and note operation of all controls.
2. Weekly: Complete operational check, inspect antenna and power connections.
3. Tube Testing: The tubes should be removed for checking only when the operation of the receiver causes doubt concerning their condition. When replacing a tube that has been removed for testing be certain that it is reinserted in the socket in which it originally was. This will prevent possible mis-alignment and poor operation of the receiver.
4. Fuse Failures: When a fuse blows on the receiver, and after replacing it with one of equal value it blows again immediately, do not attempt to operate the receiver until the cause has been located and repaired, as serious damage may be done to components in the receiver.

17. EMERGENCY CHECKS

Troubles developing suddenly during operation are usually of a minor nature that may be corrected without dismantling the receiver. Check as follows:

1. Set dead - dial lamp out.
 - a. Check setting of all controls to ascertain that they have not been inadvertantly set wrong.
 - b. Check power source connections.
 - c. Check both fuses at rear of receiver.
 - d. Replace dial lamp with spare furnished.
 - e. Check for burned out tubes. If any one of the tubes in the series filament string containing the 25Z6GT rectifier tube burns out, the dial lamp will not light and all tubes in this string will be out.

2. Set dead - dial lamp on.
 - a. Check setting of all controls to ascertain that they have not been inadvertantly set wrong.
 - b. Check for burned out tubes. If any one of the tubes in the series filament string containing V-102, V-103, V-104, V-105, V-106, and V-111, all tubes in this string will be out.

If none of the above corrections remedy the trouble, the receiver should be given a complete check to ascertain the fault.

Section VI PREVENTIVE MAINTENANCE

18. In order to insure trouble free service, periodic inspections as outlined in Section V should be maintained. In addition the receiver should be given a complete inspection quarterly, taking voltage measurements at each socket to ascertain that component parts are in good working order. All moving parts should be inspected to ascertain that they are in good working order.

SECTION 7

TROUBLE LOCATION CHART		
Sympton	Cause	Remedy
Weak or dead on all bands	Blown fuse	Replace from spares
	Defective tube	Replace from spares or stock
	Dial lamp burned out	Replace from spares
	Socket voltages wrong	Check associated bypass capacitors
		Check continuity of wiring and components
		Check resistors and switch contacts
No signal	Check receiver stage by stage	
	Check for disconnected or broken antenna connections	
Weak or dead one band only	No signal	Check all coils on specific band
		Check switch contacts
Noisy Reception	Defective tube	Tap all tubes lightly and replace any that are noisy
	Defective antenna	Check antenna installation and connection
	Defective component	Tap all components lightly with insulated rod, check carefully suspected parts
Oscillation	Defective tube	Replace tubes one at a time
	Open by-pass capacitor	Connect good capacitor across suspected unit, temporarily. Replace defective unit
Hum	Defective tube	Replace tubes one at a time
	Defective filter capacitor	Replace defective unit
	Improper power source connection	Reverse power input connection

Section VII CORRECTIVE MAINTENANCE

19. When servicing the Radio Receiver the first step should be a complete check of all tubes. This can be accomplished easily by replacing one at a time with tubes of known good quality. All tubes which are not defective should be reinserted in the socket from which they were taken. Failure of a vacuum tube in the receiver may reduce the sensitivity, cause intermittent operation or cause the receiver to be completely inoperative. Since the heaters of the vacuum tubes in the receiver are connected in series, in two strings, if one tube in a string burns out all the tubes in that string will be inoperative until the defective tube is replaced.

ALL TUBES OF A GIVEN TYPE SUPPLIED WITH THE EQUIPMENT SHALL BE CONSUMED PRIOR TO EMPLOYMENT OF TUBES FROM GENERAL STOCK.

20. FAILURE OF THE RADIO RECEIVER

In case of failure or breakdown of the receiver the fault must first be localized in one portion of the circuit, this can be accomplished by observation of some peculiar action of one of the controls or by checking the receiver against test data tabulated in Paragraph 26. It must be remembered that resistance or voltage checks will not positively locate certain faults. For instance, an open circuited by-pass capacitor will not appear in point to point resistance tests and may introduce regeneration or oscillation in certain circuits which effect the stage gain of other circuits. Similarly, a short circuit occurring in a low resistance inductor will not appear in a point to point resistance test and if the short appears in an R.F. coil, a false indication of the necessity for realignment may result.

By-pass or filter capacitors, which develop poor internal connections or which become open-circuited, will cause decreased sensitivity and/or poor stability. An open unit can be located by temporarily connecting a good capacitor in parallel with the unit under suspicion. Failures of any by-pass or filter capacitor may seriously overload resistors of associated circuits. Overloads of sufficient magnitude to permanently damage a resistor will cause the painted surface of the resistor to be scorched, making the defective unit easy to locate by visual inspection.

Loose connections, causing intermittent or noisy operation, and which cannot be found by point to point resistance tests, can usually be located by individually testing each circuit element, or by tapping or shaking the component under suspicion, when the receiver is adjusted for normal operation.

21. VOLTAGE AND RESISTANCE TESTS

Table 1 lists the tube socket voltages and cathode currents for various settings of the controls. All voltages are measured between the ground bus and socket terminals. Voltage measurements listed are made with a DC voltmeter 1000 ohms per volt using the highest range scale that can be easily read. The receiver should be connected for normal operation and the controls adjusted as listed in Table 1. Line voltage should be 115 volts AC or DC. Resistance measurements are listed in Table 2. All resistance measurements are made between ground bus and terminal. The most suitable scale for the measurement being taken, should be used. The receiver should be disconnected from the power source with controls adjusted as listed in Table 2.

22. ALIGNMENT DATA

Should realignment of the Radio Receiver become necessary, the following alignment data should be carefully studied before making any circuit adjustments. It is important that the operator understand the functions of each circuit element so that correct alignment may be made quickly and accurately.

All alignment and measurements may be made with a signal generator capable of producing both a 30% 400 cycle modulated signal or an unmodulated signal between 400 kilocycles and 20 megacycles and a General Radio Type 583A or equivalent output meter. For RF alignment and measurements at the antenna input a Standard RMA dummy antenna as shown in Figure 9 should be used.

Before proceeding with the alignment of any circuit of the receiver, the chassis must be removed from the cabinet, and the bottom cover plate of the chassis removed. For IF alignment the bottom cover shield of the oscillator-converter compartment must be removed.

The Receiver must be connected to a 115 volt AC or DC power source and the controls set as follows unless otherwise noted.

Control	Position
Power Switch	Power
Monitor Switch	Monitor
R.F. Gain	Maximum (10)
A.F. Gain	As noted
Fidelity	Maximum (10)
Band Selector	As noted
N.L. Control	Off
Selectivity	Mod. (S)
C.W. Osc.	0

Table 1 TUBE SOCKET VOLTAGES AND CATHODE CURRENT

Terminal	Pin	Variable		Voltages DC Volts	Currents DC MA		
		Symbol	Setting				
V-101 Grid Cathode Suppressor Screen Plate	Cap			0	8.1		
	8	S-102	MOD.	0.7			
		S-102	C.W.				
		R-148	0	17.5			
		R-148	10	0.7			
	5	S-102	MOD.	0.7			
		S-102	C.W.				
		R-148	0	17.5			
		R-148	10	0.7			
				105			
	4		105				
	3		105				
V-102 Grid Cathode Plate	5			0	10		
	8			0			
	3			105			
V-103 Grid #1 Cathode Grid #3 Grids #2 & 4 Plate	5			0	11.7		
	6	S-102	MOD.	0.5			
		S-102	C.W.				
		R-148	0	17			
		R-148	10	0.5			
	8			0			
	4			85			
	3			100			
	V-104 Grid Cathode Suppressor Screen Plate	4				0	17
		5	S-102	MOD.			
		S-102	C.W.				
		R-148	0	17.5			
		R-148	10	0.7			
3				0			
6				95			
8				95			
V-105 Grid Cathode Suppressor Screen Plate		4			0	17	
		5			5		
	3			0			
	6			95			
	8	S-103	N.L.	95			
		S-103	OFF	95			
S-103		PHONO	0				
V-106A Cathode Plate	4			0	0		
	3			0			

Table 1 TUBE SOCKET VOLTAGES AND CATHODE CURRENT (Cont)

Terminal	Pin	Variable		Voltages DC Volts	Currents DC MA
		Symbol	Setting		
V-106B Cathode	8			0	0
Plate	5			0	
V-107A Grid	1			0	
Cathode	3			0	10
Plate	2	S-102	MOD.	0	
		S-102	C.W.	6.5	
V-107B Grid	4			0	
Cathode	6			0.7	10
Plate	5			10	
V-108A Grid	1			0	
Cathode	3			1.4	10
Plate	2			50	
V-108B Grid	4			0	
Cathode	6			1.4	10
Plate	5			50	
V-109 Grid	5			3.5	
Cathode	8			0	53
Screen	4			110	
Plate	3			100	
V-110 Grid	5			3.5	
Cathode	8			0	53
Screen	4			110	
Plate	3			100	
V-111 Grid	5			0	
Cathode	8			0	3
Target	4			105	
Plate	3			3	
V-112 Cathode					
1 & 2	4-8				
Plate 1 & 2	3-5			115	

**Table 2: POINT TO POINT RESISTANCE
TERMINAL TO GROUND BUS**

Terminal	Pin	Variable		Resistance Ohms Plus or Minus 10%
		Symbol	Setting	
V-101 Grid	Cap	S-102	MOD.	1.91 meg.
		S-102	C.W.	.47 meg.
Cathode	8	S-102	MOD.	56
		S-102	C.W.	
		R-148	0	1556
		R-148	10	56
Suppressor	5	S-102	MOD.	56
		S-102	C.W.	
		R-148	0	1556
		R-148	10	56
Screen	4			12660
Plate	3			10260
V-102 Grid	5			47050
Cathode	8			50
Plate	3			9976
V-103 Grid #1	5			20000
Cathode	6	S-102	MOD.	56
		S-102	C.W.	
		R-148	0	1556
		R-148	10	56
Grid #3	8	S-102	MOD.	2.38 meg.
		S-102	C.W.	.94 meg.
Grids 2 & 4	4			12100
Plate	3			10380
V-104 Grid	4	S-102	MOD.	1.91 meg.
		S-102	C.W.	.47 meg.
Cathode	5	S-102	MOD.	56
		S-102	C.W.	
		R-148	0	1556
		R-148	10	56
Suppressor	3			0
Screen	6			10380
Plate	8			10380
V-105 Grid	4	S-102	MOD.	4.7
Cathode	5			680
Suppressor	3			0
Screen	6			10380
Plate	8	S-103	N.L.	10380
		S-103	OFF	10380
		S-103	PHONO	Infinite

Table 2: POINT TO POINT RESISTANCE (Continued)
 TERMINAL TO GROUND BUS

Terminal	Pin	Variable		Resistance Ohms Plus or Minus 10%
		Symbol	Setting	
V-106A Cathode Plate	4			0
	3	S-102	MOD.	.44 meg.
		S-102	C.W.	.305 meg.
V-106B Cathode Plate	8	S-102	MOD.	2.26 meg.
		S-102	C.W.	.69 meg.
	5	S-102	MOD.	.22 meg.
		S-102	C.W.	.137 meg.
V-107A Grid Cathode	4	R-125	0	0
	6	R-125	10	.25 meg±20%
Plate	5			1500
				.58 meg.
V-107B Grid Cathode	1			47000
	3			1.34
Plate	2	S-102	MOD.	Infinite
		S-102	C.W.	.229 meg.
V-108A Grid Cathode Plate	4			39000
	6			560
	5			52300
V-108B Grid Cathode Plate	1			47000
	3			560
	2			52300
V-109 Grid Cathode Screen Plate	5			0.2 meg.
	8			0
	4			9700
	3			9890
V-110 Grid Cathode Screen Plate	5			0.2 meg.
	8			0
	4			9700
	3			9890
V-111 Grid Cathode Target Plate	5	S-102	MOD.	2.42 meg.
		S-102	C.W.	2.2 meg.
	8			0
	4			9700
	3			2.2 meg.
V-112 Cathode 1 & 2 Plate 1 & 2	4-8			9770
	3-5			482

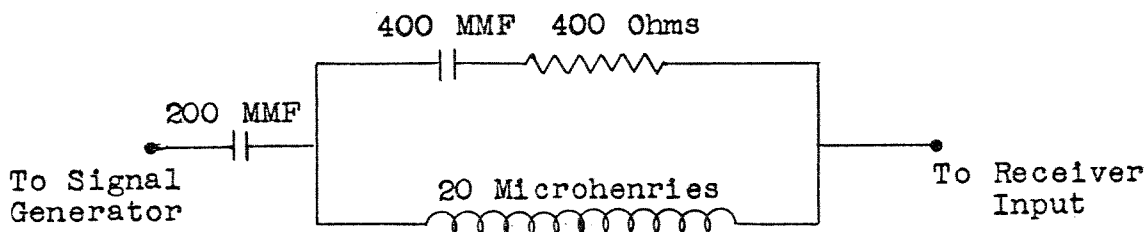

Fig. 9 Schematic Diagram RMA Standard Dummy Antenna

The complete alignment of the radio receiver may be divided into four steps.

- (1) I.F. Amplifier Alignment
- (2) C.W. Oscillator Alignment
- (3) High Frequency Oscillator Alignment
- (4) Radio Frequency Amplifier Alignment

NOTE: THE CIRCUITS MUST BE CHECKED IN THE ABOVE ORDER WHEN COMPLETE ALIGNMENT IS NECESSARY.

23. I. F. AMPLIFIER ALIGNMENT

The intermediate frequency of the Radio Receiver is 455 kilocycles.

Tuning adjustments are provided in each I.F. transformer. These adjustments consist of adjustable iron cores and are designated by symbol numbers E-115 to E-119 inclusive as indicated on Schematic Diagram, Figure 11.

The high potential lead of the signal generator should be connected to the control grid (terminal No. 8) of the mixer tube V-103 through a .01 mfd. capacitor and the ground lead to any metal part of the chassis.

The frequency of the signal generator should be carefully adjusted to 455 kilocycles modulated 30% at 400 cycles and the signal input to mixer tube V-103, adjusted to provide a reading on the output meter. Starting with the third I.F. transformer the trimmers should be adjusted in the following order: E-119, E-118, E-117, E-116 and E-115.

NOTE: IT IS ESSENTIAL THAT THE INPUT SIGNAL, FROM THE SIGNAL GENERATOR, BE KEPT BELOW THE THRESHOLD OF OPERATION OF THE AUTOMATIC VOLUME CONTROL. EXCESSIVE SIGNAL INPUTS WHICH WILL CAUSE OVERLOAD OF EITHER THE SECOND DETECTOR OR AUDIO CIRCUITS SHOULD ALSO BE AVOIDED.

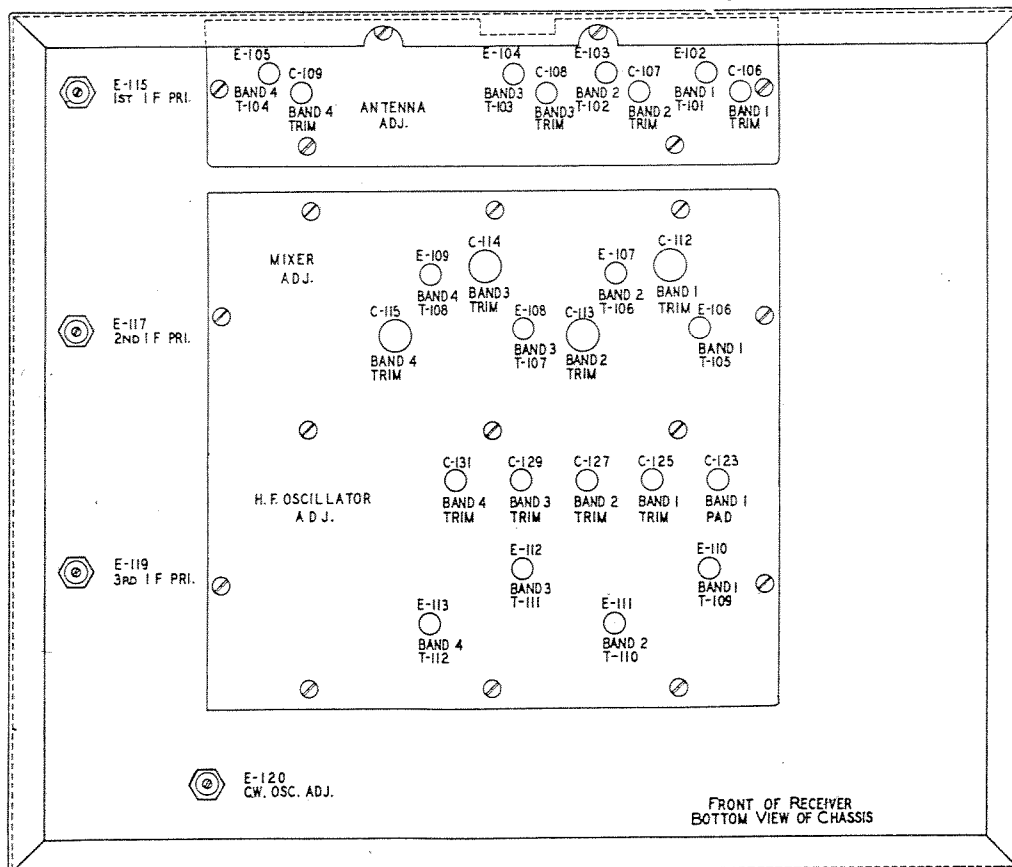
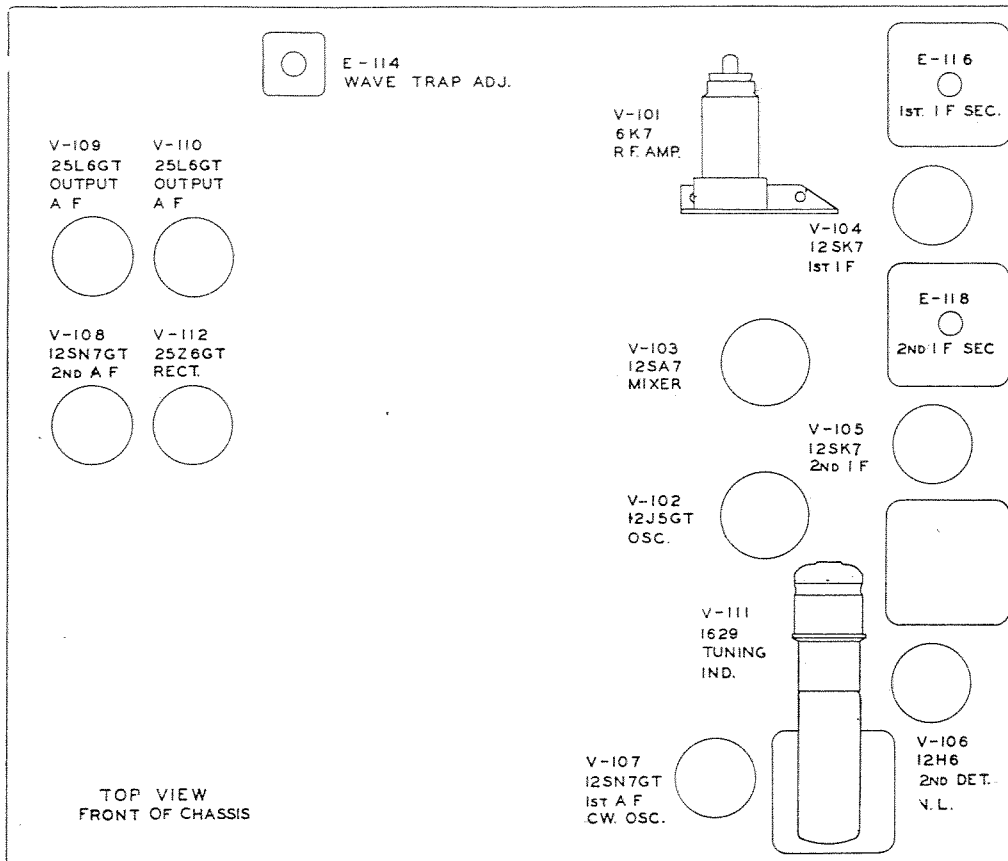

Fig. 10 Trimmer Positions and Tube Location

The performance of the I.F. amplifier can be checked against the following data. For an audio output of 6 milliwatts across a 600 ohm load the following input values should not be exceeded, if the I.F. amplifier is in proper operating condition.

V-103 grid	250	Microvolts
V-104 grid	1000	Microvolts
V-105 grid	10000	Microvolts

24. C.W. OSCILLATOR ALIGNMENT

With the signal generator connected to the mixer tube V-103 grid, as for I.F. alignment with a 455 kilocycle signal, with modulation off and the C.W. OSC. control set at zero, adjust the C.W. oscillator inductance trimmer E-120 until zero beat is obtained. This will properly align the C.W. oscillator circuit.

25. R.F. AND H.F. OSCILLATOR ALIGNMENT

CAUTION: READJUSTMENT OF THE H.F. OSCILLATOR CIRCUIT TRIMMERS SHOULD NOT BE ATTEMPTED UNTIL AFTER THE NEED FOR SUCH READJUSTMENT HAS BEEN POSITIVELY ESTABLISHED.

Table 3 gives the alignment frequency, trimmer adjustment and nominal sensitivity for each of the four frequency bands.

The signal generator should be connected through a Standard RMA dummy antenna to the antenna-ground input jack. A 400 cycle, 30% modulated signal should be used. The receiver controls should be adjusted as listed in Paragraph 22 with the band selector control set to the desired frequency band.

It is important that the H.F. oscillator circuits operate at a higher frequency than that of the R.F. amplifier circuits. This can be checked by tuning in the image of the test signal from the signal generator. This signal will appear 910 kilocycles lower in frequency on the dial than the signal frequency and will be considerably weaker than the signal at resonance, therefore, it may be necessary to increase the output of the signal generator in order to identify the image signal.

The following general procedure should be employed in the alignment of the H.F. oscillator and R.F. amplifier circuits. Set signal generator to high frequency alignment point of desired band. Set radio dial to high frequency alignment point and adjust corresponding trimmer adjustments for maximum output. Repeat this procedure for the low frequency alignment point.

The alignment of the R.F. and oscillator circuits may be considered satisfactory if the signal input necessary to produce a 60 milliwatt output, measured across a 600 ohm load at the 600 ohm speaker terminals, does not exceed the values given in Table 3.

Sensitivity measurements are made at a 10 to 1 signal to noise ratio as follows:

With the signal generator and receiver set to the same frequency, turn off the signal generator modulation; adjust the signal generator output to 10 microvolts; adjust the A.F. gain control on the receiver to give an output reading of 6 milliwatts. Turn the signal generator modulation on and adjust the signal generator output control to give an output reading from the receiver of 60 milliwatts. Repeat this procedure as a check. Then the output reading of the signal generator will be the sensitivity of the receiver at a 10 to 1 signal to noise ratio.

TABLE 3

Band	Freq.	Adjustment			Sensitivity
		Osc.	Mixer	Ant.	
1	1.3 MC	C-125	C-112	C-106	10 uv
	.9 MC	E-110			
	.6 MC	C-123	E-106	E-102	
2	3.3 MC	C-127	C-113	C-107	10 uv
	1.6 MC	E-111	E-107	E-103	
3	8.0 MC	C-129	C-114	C-108	10 uv
	4.0 MC	E-112	E-108	E-104	
4	17.0 MC	C-131	C-115	C-109	10 uv
	10.0 MC	E-113	E-109	E-105	

Table 4 COIL WINDING DATA

Symbol Desig.	Diagram	Description	No. Turns	Wire Size	DC Resis. Ohms
L-101		Universal wound coil, 7/16" dia. form, adjustable powdered iron core, includes C-101, wax impregnated. .51 MH @ 1000 CPS	195	7/41 litz	5.87
L-102 L-103		Solenoid wound, 3 layers, 60 T/layer, 7/16" dia. form. .15 MH @ 1000 CPS, wax impregnated	180	28 DGC	1.6
L-104		Universal wound, 4 pi, 210 T/pi, 1/4" dia. ceramic form, 2.5 MH @ 1000 CPS rated 125 MA DC, wax impregnated, pigtail leads	840	36 SSE	45
L-105		Filter reactor, laminated iron core, 4.5 H @ 3 V, 60 CPS with 150 MA DC, hermetically sealed	2060	28 E	70
T-101		Primary - universal wound on 1" dia. form, 1.27 uH @ 1000 CPS Secondary - progressive universal wound on 1" dia. form, 202 uH @ 1000 CPS, powdered iron core tuned, wax impregnated, electrostatic shield is separate unit	175 94 1/2	34 SCE 34 SCE	14 7.0
T-102		Primary - universal wound on 3/4" dia. form, 110 uH @ 1000 CPS Secondary - close wound on 3/4" dia. form, 30 uH @ 1000 CPS, powdered iron core tuned, wax impregnated, electrostatic shield separate unit.	60 42 1/2	34 SCE 29 E	3.55 0.71
T-103		Primary - universal wound on 3/4" dia. form, 26 uH @ 1000 CPS Secondary - closewound on 3/4" dia. form, 5.3 uH @ 1000 CPS, powdered iron core tuned, wax impregnated, electrostatic shield separate unit	32 15 1/2	34 SCE 24 E	1.65 .085

Table 4 COIL WINDING DATA (Cont)

Symbol Desig.	Diagram	Description	No. Turns	Wire Size	DC Resis. Ohms
T-104		Primary - closewound on 3/4" dia. form, 1.6 uH @ 1000 CPS Secondary - spacewound 16 T/inch 1.1 uH @ 1000 CPS, powdered iron core tuned, wax impregnated, electrostatic shield separate unit	23 1/2 6 3/4	32 E 24 E	0.8 .045
T-105		Primary - universal wound on 1" dia. form, 204 uH @ 1000 CPS Secondary - progressive universal wound on 1" dia. form, 203 uH @ 1000 CPS, powdered iron core tuned, wax impregnated	60 96 1/4	34 SCE 34 SCE	5.0 7.0
T-106		Primary - universal wound on 3/4" dia. form, 16.5 uH @ 1000 CPS Secondary - closewound on 3/4" dia. form, 30 uH @ 1000 CPS, powdered iron core tuned, wax impregnated	20 1/2 41 1/2	34 SCE 29 E	1.24 0.66
T-107		Primary - closewound on 3/4" dia. form, 2.9 uH @ 1000 CPS Secondary - closewound on 3/4" dia. form, 4.9 uH @ 1000 CPS, powdered iron core tuned, wax impregnated	9 1/2 14 1/2	28 DCC 24 E	.143 .082
T-108		Primary - interwound with secondary on 3/4" dia. form, 1.1 uH @ 1000 CPS Secondary - spacewound 16 T/inch on 3/4" dia. form, 1.1 uH @ 1000 CPS, powdered iron core tuned, wax impregnated	6 1/4 6 3/4	28 DCC 24 E	0.1 .05
T-109		Closewound on 1" dia. form. Primary - 7.6 uH @ 1000 CPS Secondary - 79.0 uH @ 1000 CPS, powdered iron core tuned, wax impregnated	12 61 1/4	32 E 32 E	0.55 2.2

Table 4 COIL WINDING DATA (Cont)

Symbol Desig.	Diagram	Description	No. Turns	Wire Size	DC Resis. Ohms
T-110		Closewound on 3/4" dia. form Primary - 2.9 uH @ 1000 CPS Secondary - 14.1 uH @ 1000 CPS, powdered iron core tuned, wax impregnated	9 1/2 24 1/2	29 E 29 E	0.18 0.44
T-111		Spacewound 22 T/inch on 3/4" dia. form Primary - 0.5 uH @ 1000 CPS Secondary - 2.7 uH @ 1000 CPS powdered iron core tuned, wax impregnated	4 1/2 12	24 E 24 E	.038 .075
T-112		Spacewound 16 T/inch on 3/4" dia. form Primary - .39 uH @ 1000 CPS Secondary - 0.72 uH @ 1000 CPS powdered iron core tuned, wax impregnated	2 4 1/2	24 E 24 E	.025 .037
T-113		Two universal windings on 7/16" dia. form spaced 1 1/4" on centers Primary - 320 uH @ 1000 CPS powdered iron core tuned Secondary - 331 uH @ 1000 CPS powdered iron core tuned Tertiary wound under primary and is centertapped Assembly includes C-136 and C-137, wax impregnated	155 162 6 Tap at 3	7/41 litz 7/41 litz 7/41 litz	4.72 4.73
T-114		Two universal windings on 7/16" dia. form spaced 1 1/4" on centers Primary - 352 uH @ 1000 CPS, powdered iron core tuned Secondary - 331 uH @ 1000 CPS, powdered iron core tuned Tertiary wound under primary and is centertapped Assembly includes C-140 and C-141, wax impregnated	162 162 6 Tap at 3	7/41 litz 7/41 litz 7/41 litz	4.93 4.73

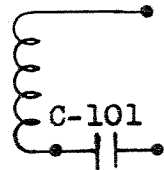
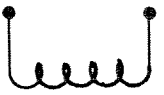
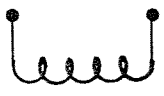
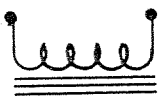
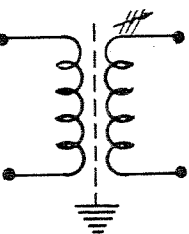
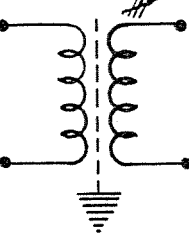
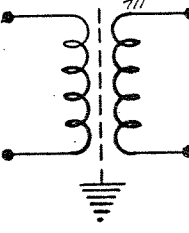
Table 4 COIL WINDING DATA (Cont)

Symbol Desig.	Diagram	Description	No. Turns	Wire Size	DC Resis. Ohms
T-115		Three universal windings on 7/16" dia. form, one secondary winding on each side of primary tightly coupled Primary - 885 uH @ 1000 CPS, powdered iron core tuned, includes C-142 Secondary - 1.45 uH @ 1000 CPS untuned Wax impregnated	210 160 each Pi total 320	34 SCE 34 SCE	12.3 Total 16.7
T-116		Universal winding on 7/16" dia. form Primary - 14.3 uH @ 1000 CPS Secondary - 363 uH @ 1000 CPS wound over primary, powdered iron core tuned Assembly includes C-162, C-161, R-149, wax impregnated	35 165	34 SCE 34 SCE	1.34 7.16
T-117		Output transformer Primary - terminals 1-2-3, impedance 4400 ohms @ 1000 CPS, 80 MA DC Secondary - terminals 4-5, 200 ohms Secondary - terminals 4-6, 300 ohms Secondary - terminals 4-7, 600 ohms Secondary - terminals 8-9, 4 ohms Secondary - terminals 10-11-12, 60 ohms Hermetically sealed	2380 tap 1190 380 460 655 53 206	34 E 27 E 27 E 27 E 22 E 30 E	380 9.5 12.0 16.5 0.59 12.55

Table 5

JAN 6-DOT COLOR CODE
For Capacitors (molded mica)

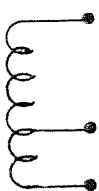
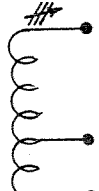
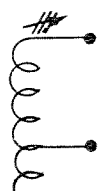
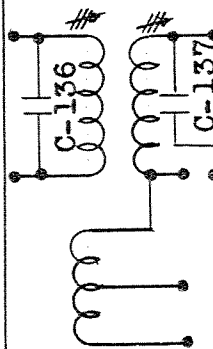
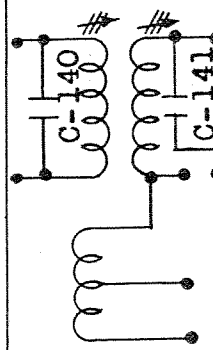
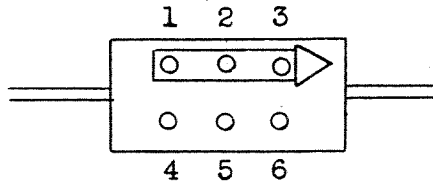

Color	1st Dot 1st Digit	2nd Dot 2nd Digit	3rd Dot 3rd Digit	4th Dot Decimal Multiplier	5th Dot Tolerance	6th Dot Character- istic
Black	0	0	0	1	± 20 %	A
Brown	1	1	1	10		B
Red	2	2	2	100	± 2 %	C
Orange	3	3	3	1000		D
Yellow	4	4	4			E
Green	5	5	5			F
Blue	6	6	6			G
Violet	7	7	7			
Gray	8	8	8			
White	9	9	9			
Gold					± 5 %	
Silver					± 10 %	

RMA STANDARD 6-DOT COLOR CODE
For Capacitors (molded mica)

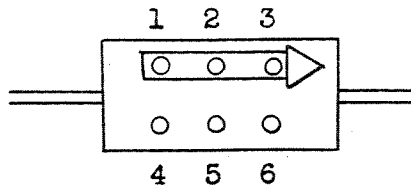

Color	1st Dot 1st Digit	2nd Dot 2nd Digit	3rd Dot 3rd Digit	4th Dot Decimal Multiplier	5th Dot Tolerance	6th Dot Voltage
Black	0	0	0	1		
Brown	1	1	1	10	± 1 %	100 V
Red	2	2	2	100	± 2 %	200 V
Orange	3	3	3	1000	± 3 %	300 V
Yellow	4	4	4		± 4 %	400 V
Green	5	5	5		± 5 %	500 V
Blue	6	6	6		± 6 %	600 V
Violet	7	7	7		± 7 %	700 V
Gray	8	8	8		± 8 %	800 V
White	9	9	9		± 9 %	900 V
Gold						1000 V
Silver					± 10 %	2000 V
Body					± 20 %	

JAN RESISTOR COLOR CODE

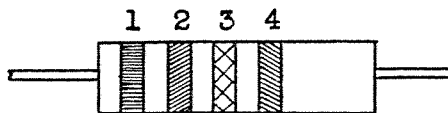

Color	1st Band 1st Digit	2nd Band 2nd Digit	3rd Band Decimal Multiplier	4th Band Tolerance
Black	0	0		
Brown	1	1		
Red	2	2		
Orange	3	3		
Yellow	4	4		
Green	5	5		
Blue	6	6		
Violet	7	7		
Gray	8	8		
White	9	9		
Gold			0.1	± 5 %
Silver			0.01	±10 %
No Color				±20 %

JAN COLOR CODE
Capacitors - Tubular Ceramic

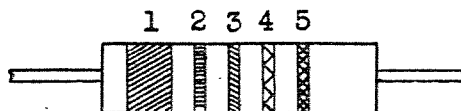

Color	1st Band Temperature Coefficient	2nd Band 1st Digit	3rd Band 2nd Digit	4th Band Decimal Multiplier	5th Band Capacity Tolerance
Black	0	0	0	1	± 20 %
Brown	-30	1	1	10	± 1 %
Red	-80	2	2	100	± 2 %
Orange	-150	3	3	1000	
Yellow	-220	4	4		
Green	-330	5	5		± 5 %
Blue	-470	6	6		
Violet	-750	7	7		
Gray	+30	8	8	0.01	
White	-330 ±500	9	9	.1	± 10 %

Table 6 Parts List For Scott Marine Receiver

Symbol Desig.	Description	Function	Contractor's Drawing and Part Number	All Symbol Designations Involved	Total Per Equip.
CAPACITORS					
C-101	Capacitor, silver mica, 200 MMF $\pm 5\%$, 500 V DC wkg., bakelite case	L-101 tuning	7569	C-101,136,162	3
C-102	Capacitor, mica, .01 MF $\pm 20\%$, 300 V DC wkg., bakelite case	Antenna series	8108	C-102,110,145,172,173	5
C-103	Capacitor, mica, 240 MMF $\pm 10\%$, 500 V DC wkg., bakelite case	V-101 grid coupling	5223	C-103,116	2
C-104	Capacitor, variable air, single unit, split stator. Section "A" 17 plates, min. cap. 12 MMF, max. cap. 262 MMF. Section "B" 9 plates, min. cap. 9 MMF, max. cap. 134 MMF. Air gap .015", shaft: 3/8" dia. x 1 3/32 long	Antenna tuning	5207	C-104	1
C-104A	Capacitor, silver ceramic, 10 MMF ± 1 MMF, 500 V DC wkg., insulated, pigtail leads	C-104A and C-104B shunt	8417	C-105,118,173	3
C-104B	Capacitor, ceramic trimmer, min. cap. 1.5 MMF, max. cap. 10 MMF, 500 V DC test	T-101 secondary trimmer	5457	C-106,112	2
C-105	Capacitor, ceramic trimmer, min. cap. 4.5 MMF, max. cap. 25 MMF, 500 V DC test	T-102 secondary trimmer	5422	C-107,108,109,113,114,115	6
C-108	Same as C-107	T-103 secondary trimmer			
C-109	Same as C-107	T-104 secondary trimmer			
C-110	Same as C-102	V-101 grid return bypass			
C-111	Capacitor, paper, 0.1/0.1/0.1 MFD $\pm 10\%$, 600 V DC wkg., bathtub container	Section "A", V-101 screen bypass	5065	C-111,120,132,134,135,139	6
C-111A	1 13/16 long x 1" wide x 7/8" high, mtg centers 2 1/8", hermetically sealed	Section "B", V-101 cathode bypass			
C-111B	Same as C-106	Section "C", +B bypass			
C-111C	Same as C-107	T-105 secondary trimmer			
C-112	Same as C-107	T-106 secondary trimmer			
C-113	Same as C-107	T-107 secondary trimmer			
C-114	Same as C-107	T-108 secondary trimmer			
C-115	Same as C-107	V-103 grid coupling			
C-116	Same as C-103				

Table 6 Parts List For Scott Marine Receiver

Symbol Desig.	Description	Function	Contractor's Drawing and Part Number	All Symbol Designations Involved	Total Per Equip.
CAPACITORS (Continued)					
C-117	Capacitor, variable air, 2 unit, split stator, Section "A" both units 17 plates min. cap. 12 MMF, max. cap. 262 MMF.	Sections "A" and "B" mixer tuning	5208	C-117	1
C-117A	Section "B" both units, 9 plates, min. cap. 9 MMF, max. cap. 134 MMF, air gap .015", shaft at both ends 3/8" dia., 1 3/32" long at rear, 2 3/4" long at front	Sections "C" and "D" H. F. oscillator tuning			
C-117B	Same as C-105				
C-117C	Capacitor, paper, .05/.05 MFD $\pm 10\%$, 600 V DC wkg., bathtub container, 1 13/16" long x 1" wide x 7/8" high, hermetically sealed	T-106 secondary shunt	5067	C-119, 138, 144	3
C-117D	Same as C-111	Section "A" V-106B cathode filter			
C-118		Section "B" V-111 grid filter			
C-119		Section "A" V-103 heater bypass			
C-119A		Section "B" V-103 heater bypass			
C-119B		Section "C" V-103 cathode bypass			
C-120		V-102 cathode to V-103 osc. grid coupling	8418	C-121, 122, 161	3
C-120A					
C-120B		V-102 grid coupling	5330	C-123	1
C-120C		T-109 variable pad			
C-121	Capacitor, silver mica, 51 MMF $\pm 5\%$, 500 V DC wkg., bakelite case, pigtail leads	T-109 fixed pad	5441	C-124	1
C-122	Same as C-121	T-109 trimmer	5072	C-125, 127, 129, 131	4
C-123	Capacitor, variable air trimmer, min. cap. 6.5 MMF, max. cap. 100 MMF, 28 plates 1/4" hex adj. shaft with screw-driver slot				
C-124	Capacitor, silver mica, 560 MMF $\pm 5\%$, 500 V DC wkg., bakelite case, pigtail leads				
C-125	Capacitor, variable air trimmer, min. cap. 3 MMF, max. cap. 25 MMF, 7 plates, 1/4" hex adj. shaft with screw-driver slot				

Table 6 Parts List For Scott Marine Receiver

Symbol Desig.	Description	Function	Contractor's Drawing and Part Number	All Symbol Designations Involved	Total Per Equip.
CAPACITORS (Continued)					
C-126	Capacitor, silver mica, 1000 MMF $\pm 5\%$, 500 V DC wkg., bakelite case, pigtail leads	T-110 fixed pad	5235	C-126	1
C-127	Same as C-125	T-110 trimmer			
C-128	Capacitor, silver mica, 3000 MMF $\pm 5\%$, 500 V DC wkg., bakelite case, pigtail leads	T-111 fixed pad	7137	C-128	1
C-129	Same as C-125	T-111 trimmer			
C-130	Capacitor, silver mica, 5100 MMF $\pm 5\%$, 500 V DC wkg., bakelite case, pigtail leads	T-112 fixed pad	5236	C-130	1
C-131	Same as C-125	T-112 trimmer			
C-132	Same as C-111	Section "A", V-102 plate bypass			
C-132A		Section "B", V-102 plate filter			
C-132B		Section "C", ground bus bypass at V-102 socket			
C-132C		Section "A", V-102 heater bypass			
C-133	Capacitor, paper, 0.1/0.1 MFD $\pm 10\%$, 600 V DC wkg., bathtub container, 1.13/16" long x 1" wide x 7/8" high, hermetically sealed	Section "B", V-102 heater bypass	5089	C-133,159	2
C-134	Same as C-111	Section "A", V-103 screen bypass			
C-134A		Section B, +B bus bypass			
C-134B		Section "C", V-101 plate return bypass			
C-134C		Section "A", V-103 plate return bypass			
C-135	Same as C-111	Section "B", V-104 screen bypass			
C-135A		Section "C", V-105 screen bypass			
C-135B		T-113 primary tuning			
C-135C					
C-136	Same as C-101				

Table 6 Parts List For Scott Marine Receiver

Symbol Desig.	Description	Function	Contractor's Drawing and Part Number	All Symbol Designations Involved	Total Per Equip.
CAPACITORS (Continued)					
C-137	Capacitor, silver mica, 240 MMF $\pm 5\%$, 500 V DC wkg., bakelite case, pigtail leads	T-113 Secondary tuning	5224	C-137, 140, 141	3
C-138	Same as C-119	Section "A" V-104 grid return bypass			
C-138A		Section "B", V-102 plate filter			
C-138B		Section "A", V-104 cathode bypass			
C-139	Same as C-111	Section "B", RF gain control bypass			
C-139A		Section "C", V-105 cathode bypass			
C-139B		T-114 primary tuning			
C-139C		T-114 secondary tuning			
C-140	Same as C-137	T-115 primary tuning			
C-141	Same as C-137	V-106A diode filter	7133	C-142	1
C-142	Capacitor, silver mica, 100 MMF $\pm 5\%$, 500 V DC wkg., bakelite case, pigtail leads	Section "A", V-103 grid return bypass	5318	C-143	1
C-143	Capacitor, mica, 51 MMF $\pm 10\%$, 500 V DC wkg, bakelite case, pigtail leads	Section "B", AVC bypass			
C-144	Same as C-119	S-103 to AF gain control			
C-144A		R-125 coupling			
C-144B		Phono terminal input isolating	7130	C-146, 160	2
C-145	Same as C-102	V-107A plate to V-108A grid coupling	9014	C-147, 150, 152, 153, 154, 155, 164	7
C-146	Capacitor, paper, .25 MF $\pm 10\%$, 600 V DC wkg., bathtub container, 1 13/16" long x 1" wide x 7/8" high, hermetically sealed				
C-147	Capacitor, mica, .01 MF $\pm 20\%$, 500 V DC wkg., bakelite case, pigtail leads				

Table 6 Parts List For Scott Marine Receiver

Symbol Desig.	Description	Function	Contractor's Drawing and Part Number	All Symbol Designations Involved	Total Per Equip.
CAPACITORS (Continued)					
C-148	Capacitor, electrolytic, 20 MF, 200 V DC wkg., 2 terminal type in 1" dia. x 2 1/4" long round can, hermetically sealed	V-107A plate filter bypass	5204	C-148	1
C-149	Capacitor, electrolytic, 25 MF, 25 V DC wkg., bathtub container 1 13/16" long x 1" wide x 7/8" high, hermetically sealed	V-108 A & B cathode bypass	5088	C-149,165	2
C-150	Same as C-147	V-108A plate to V-108B grid feedback			
C-151	Capacitor, mica, 1000 MMF ±10%, 500 V DC wkg., bakelite case, pigtail leads	V-109 grid to V-110 grid shunt	5206	C-151	1
C-152	Same as C-147	V-108A plate to V-109 grid coupling			
C-153	Same as C-147	V-108B plate to V-110 grid coupling			
C-154	Same as C-147	T-117 secondary to V-107A cathode feedback			
C-155	Same as C-147	T-117 secondary to V-107A cathode feedback			
C-156	Capacitor, electrolytic, 60 MF, 250 V DC wkg., 2 terminal type in 1 3/8" dia. x 2 1/4" long round can, hermetically sealed	+B bus bypass	5203	C-156	1
C-157	Capacitor, electrolytic, 60/60 MF, 200 V DC wkg., 3 terminal type in 1 3/8" dia. x 3 1/4" long round can hermetically sealed	Power supply output filter	5202	C-157,158	2
C-157A	Same as C-157	2 sections in parallel			
C-157B	Same as C-157	Section "A", power supply input filter			
C-158	Same as C-157	Section "B", power supply neg. filter			
C-158A					
C-158B					

Table 6 Parts List For Scott Marine Receiver

Symbol Desig.	Description	Function	Contractor's Drawing and Part Number	All Symbol Designations Involved	Total Per Equip.
CAPACITORS (Continued)					
C-159	Same as C-133	Section A & B power input bypass			
C-159A					
C-159B					
C-160	Same as C-146	V-107B plate bypass			
C-161	Same as C-121	V-107B grid coupling			
C-162	Same as C-101	T-116 tuning			
C-163	Capacitor, variable air trimmer, min. cap. 2.8 MMF, max. cap. 17.5 MMF, 5 plates $\frac{1}{4}$ " dia. shaft 1 $\frac{7}{8}$ " long	C.W. oscillator trimmer	5205	C-163	1
C-164	Same as C-147	V-109, V-110 cathode bypass			
C-165	Same as C-149	V-109, V-110 grid return bypass			
C-166	Same as C-102	V-106A cathode bypass			
C-167	Capacitor, silver ceramic, 18 MMF $\pm 5\%$, 500 V DC wkg., temp. coeff. Neg. 750 parts/million	T-110 compensating	5337	C-167, 168, 169	3
C-168	Same as C-167				
C-169	Same as C-167	T-111 compensating			
C-170	Capacitor, paper, .02 MFD $\pm 10\%$, 600 V DC wkg., bathtub container, 1 $\frac{13}{16}$ " long x 1" wide x $\frac{3}{4}$ " high, hermetically sealed	T-112 compensating Fidelity control series	5066	C-170	1
C-171	Capacitor, silver ceramic 5 MMF $\pm .5$ MMF, 500 V DC wkg., insulated, axial wire leads	T-104 secondary shunt	8416	C-171	1
C-172	Same as C-102	V-104 heater bypass			
C-173	Same as C-105	T-107 secondary shunt			

Table 6 Parts List For Scott Marine Receiver

Symbol Desig.	Description	Function	Contractor's Drawing and Part Number	All Symbol Designations Involved	Total Per Equip.
MISCELLANEOUS ELECTRICAL PARTS					
E-101	1/4" grid cap for octal tubes	V-101 grid cap	5045	E-101	1
E-102	Compressed powdered iron core, coil inductance trimmer	T-101 inductance trimmer	5102	E-102, 103, 104, 105, 106, 107, 108, 109, 110, 111, 112, 113	12
E-103	Same as E-102	T-102 inductance trimmer			
E-104	Same as E-102	T-103 inductance trimmer			
E-105	Same as E-102	T-104 inductance trimmer			
E-106	Same as E-102	T-105 inductance trimmer			
E-107	Same as E-102	T-106 inductance trimmer			
E-108	Same as E-102	T-107 inductance trimmer			
E-109	Same as E-102	T-108 inductance trimmer			
E-110	Same as E-102	T-109 inductance trimmer			
E-111	Same as E-102	T-110 inductance trimmer			
E-112	Same as E-102	T-111 inductance trimmer			
E-113	Same as E-102	T-112 inductance trimmer			
E-114	Compressed powdered iron core, coil inductance trimmer	L-101 inductance trimmer	5103	E-114, 115, 116, 117, 118, 119, 120	7
E-115	Same as E-114	T-113 primary inductance trimmer			
E-116	Same as E-114	T-113 secondary inductance trimmer			
E-117	Same as E-114	T-114 primary inductance trimmer			
E-118	Same as E-114	T-114 secondary inductance trimmer			
E-119	Same as E-114	T-115 primary inductance trimmer			
E-120	Same as E-114	T-116 inductance trimmer			
E-121	Two terminal connector strip marked "PHONO"- "GND" 6-32 captive screws	Phono input terminal board	6001	E-121	1

Table 6 Parts List For Scott Marine Receiver

Symbol Desig.	Description	Function	Contractor's Drawing and Part Number	All Symbol Designations Involved	Total Per Equip.
MISCELLANEOUS ELECTRICAL PARTS (Continued)					
E-122	Seven terminal connector strip marked, 600-300-200 ±0, 60 - centertap, 6-32 captive screws	Speaker terminal board	5323	E-122	1
FUSES					
F-101	Fuse, 1 amp, 250 volt, cartridge type 1 1/4" long, ferrules 1/4" dia. Same as F-101	Power input fuse	5260	F-101,102	2
F-102		Power input fuse			
HARDWARE					
H-101	Coupling, solid, for 1/4" dia. shaft, 3/4" long x 1/2" dia. Same as H-101	Band change switch shaft coupling	7573	H-101,102,103	3
H-102		Band change switch shaft coupling	5436	H-104	1
H-103	Same as H-101	Selectivity switch shaft coupling	5437	H-105	1
H-104	Coupling, insulated, for 3/8" and 1/4" dia. shafts, 1 1/8" long, 1 25/32" dia., phenolic insulator ring	Dial to main tuning capacitor coupling			
H-105	Coupling, insulated, for 3/8" dia. shaft, 1" long x 1 25/32" dia., phenolic insulating ring	Single and double unit main tuning capacitor coupling			
H-106	Shock mtg., plate type, 25 lb load, 3/8" mounting hole in center	Receiver shock mounting	8267	H-106,107,108,109	4
H-107	Same as H-106	Receiver shock mounting			
H-108	Same as H-106	Receiver shock mounting			
H-109	Same as H-106	Receiver shock mounting			
H-110	Wrench, 5/64" hex x 1 7/8" long for #8 hollow head set screws	#8 set screw wrench	8684	H-110	1
H-111	Wrench, trimmer adj. 1/4" dia. x 4 1/2" long, phenolic rod, steel screwdriver nib both ends	Trimmer adjustment wrench	8683	H-111	1
H-112	Coupling, flexible for 3/8" dia., shaft 1" long x 1 25/32" dia.	Main tuning capacitor coupling	5438	H-112	1

Table 6 Parts List For Scott Marine Receiver

Symbol Desig.	Description	Function	Contractor's Drawing and Part Number	All Symbol Designations Involved	Total Per Equip.
INDICATING DEVICES					
I-101	Lamp, 6-8 volt, 0.15 amp miniature bayonet base	Dial lamp	8225	I-101	1
JACKS AND RECEPTACLES					
J-101	Receptacle, extractor type, fuse holder, mounts in 1/2" hole Same as J-101	Fuse holder for power input fuse	5213	J-101,102	2
J-102		Fuse holder for power input fuse			
J-103	Receptacle, 3 contact polarized, female, with black steel cap, rated 15 amp, 115 volts	Power input receptacle	5328	J-103	1
J-104	Jack, headphone, single open circuit	Headphone jack	8222	J-104	1
J-105	Jack, concentric line, for R.F. connection	Antenna, ground input jack	7010	J-105	1
INDUCTORS RF AND AF					
L-101	RF inductor, 195 T 7/41 litz wire, universal wound, 0.51 MH at 1000 CPS DC resistance 5.87 ohms ±10% includes C-101	455 KC wavetrap	5319	L-101	1
L-102	RF choke, .15 MH at 1000 CPS, DC resistance 1.6 ohms ±10%, 180 T #28 DCC wire, wax impregnated	V-102 heater filter choke	5375	L-102,103	2
L-103	Same as L-102	V-102 heater filter choke			
L-104	RF choke, 2.5 MH at 1000 CPS, DC resistance 45 ohms ±10%, 125 MA DC, 4 pi wound on ceramic tube, pigtail terminals, wax impregnated	HF oscillator grid return filter	5047	L-104	1
L-105	Filter reactor, 4.5 H at 3 V 60 CPS with 150 MA DC., DC resistance 70 ohms, 2060 turns #28 E wire, hermetically sealed	Power supply filter choke	5209	L-105	1

Table 6 Parts List For Scott Marine Receiver

Symbol Desig.	Description	Function	Contractor's Drawing and Part Number	All Symbol Designations Involved	Total Per Equip.
LOUDSPEAKERS					
LS-101	Loudspeaker, 5 inch PM, 4 ohm voice coil, moisture resistant cone, 6 oz. ring magnet	Monitor speaker	5239	LS-101	1
MECHANICAL PARTS, SHAFTS					
O-101	Shaft, 1/4" dia. x 10 1/4" long, flat on 2 sides .187 thick stainless steel	Selectivity switch extension shaft	5287	O-101	1
O-102	Shaft, 1/4" dia. x 9 1/2" long, flat on 2 sides, .187 thick stainless steel	Band change switch shaft	5289	O-102	1
O-103	Shaft, 1/4" dia. x 3 1/8" long, flat on 2 sides, .187 thick PBG bakelite, wax impregnated	Band change switch shaft for antenna section	5284	O-103	1
PLUGS					
P-101	Plug, concentric line for antenna and ground connections	Antenna input plug	7009	F-101	1
P-102	Plug, 3 contact, male, polarized in drawn steel shell for below surface mounting	Power input plug	5325	F-102	1
RESISTORS					
R-101	Resistor, composition, 0.47 meg $\pm 10\%$, 1/2 watt, pigtail terminals	V-101 grid return	5145	R-101,104,105,113,137,138	6
R-102	Resistor, composition, 56 ohms $\pm 5\%$, 1/2 watt, pigtail terminals	V-101 cathode bias	8687	R-102,106,114,116	4
R-103	Resistor, composition, 2400 ohms $\pm 5\%$, 1/2 watt, pigtail terminals	V-101 screen filter	5138	R-103,108	2
R-104	Same as R-101	V-103 grid return			
R-105	Same as R-101	V-103 grid return filter			
R-106	Same as R-102	V-103 cathode bias			
R-107	Resistor, composition, 20000 ohms $\pm 10\%$, 1/2 watt, pigtail terminals	V-103 oscillator grid return	7150	R-107	1

Table 6 Parts List For Scott Marine Receiver

Symbol Desig.	Description	Function	Contractor's Drawing and Part Number	All Symbol Designations Involved	Total Per Equip.
RESISTORS (Continued)					
R-108	Same as R-103	V-103 screen filter	7220	R-109	1
R-109	Resistor, composition, 560 ohms $\pm 10\%$, $\frac{1}{2}$ watt pigtail terminals	V-101 plate filter	5141	R-110, 127, 129, 130, 133, 135, 136, 149	8
R-110	Resistor, composition, 47000 ohms $\pm 10\%$, $\frac{1}{2}$ watt, pigtail terminals	V-102 grid return	8247	R-111, 141	2
R-111	Resistor, composition, 220 ohms $\pm 10\%$, $\frac{1}{2}$ watt, pigtail terminals	V-102 plate filter	7146	R-112, 115, 117, 118	4
R-112	Resistor, composition, 680 ohms $\pm 10\%$, $\frac{1}{2}$ watt, pigtail terminals	V-103 plate filter			
R-113	Same as R-101	V-104 grid return			
R-114	Same as R-102	V-104 cathode bias			
R-115	Same as R-112	V-104 plate filter			
R-116	Same as R-102	V-102 plate filter			
R-117	Same as R-112	V-105 cathode bias			
R-118	Same as R-112	V-105 plate filter			
R-119	Resistor, composition, 0.22 meg $\pm 10\%$, $\frac{1}{2}$ watt, pigtail terminals	V-106 diode load	5144	R-119, 120, 143	3
R-120	Same as R-119	V-106 diode load	5146	R-121, 122	2
R-121	Resistor, composition, 1 meg $\pm 10\%$, $\frac{1}{2}$ watt, pigtail terminals	A.V.C. filter			
R-122	Same as R-121	Noise limiter filter	7090	R-123	1
R-123	Resistor, composition, 0.82 meg $\pm 10\%$, $\frac{1}{2}$ watt, pigtail terminals	Noise limiter bias	5142	R-124, 128, 139, 140, 153	5
R-124	Resistor, composition, 0.1 meg $\pm 10\%$, $\frac{1}{2}$ watt, pigtail terminals	Phono input shunt	5283	R-125	1
R-125	Potentiometer, composition, 0.25 meg $\pm 20\%$, 0.4 watt, clockwise logarithmic taper, cover insulated from mtg bushing and connected to left hand terminal, shaft 2" long	AF gain control			
R-126	Resistor, composition, 1500 ohms $\pm 10\%$, $\frac{1}{2}$ watt, pigtail terminals	V-107A cathode bias	5137	R-126	1

Table 6 Parts List For Scott Marine Receiver

Symbol Desig.	Description	Function	Contractor's Drawing and Part Number	All Symbol Designations Involved	Total Per Equip.
RESISTORS (Continued)					
R-127	Same as R-110	T-117 secondary to V-107A cathode feedback			
R-128	Same as R-124	V-107A plate load			
R-129	Same as R-110	V-107A plate filter			
R-130	Same as R-110	V-108A grid series			
R-131	Resistor, composition, 39000 ohms $\pm 10\%$, $\frac{1}{2}$ watt, pigtail terminals	V-108A grid return	5346	R-131	1
R-132	Resistor, composition, 1000 ohms $\pm 10\%$, $\frac{1}{2}$ watt, pigtail terminals	V-108 cathode bias	5136	R-132	1
R-133	Same as R-110	V-108B grid return			
R-134	Resistor, composition, 0.51 meg $\pm 5\%$, $\frac{1}{2}$ watt, pigtail terminals	V-108A plate to V-108B grid feedback	5212	R-134	1
R-135	Same as R-110	V-108B plate load			
R-136	Same as R-110	V-108A plate load			
R-137	Same as R-101	V-109 plate to V-108A plate feedback			
R-138	Same as R-101	V-110 plate to V-108B plate feedback			
R-139	Same as R-124	V-110 grid return			
R-140	Same as R-124	V-109 grid return			
R-141	Same as R-111	Phone jack series			
R-142	Resistor, wirewound, 3.9 ohms $\pm 10\%$, 1 watt, phenolic insulated, pigtail terminals	Monitor speaker series	5312	R-142,155	2
R-143	Same as R-119	V-107B plate load			
R-144	Resistor, wirewound, 36 ohms $\pm 5\%$, 1 watt, phenolic insulated, pigtail terminals	V-109, V-110 grid bias	5357	R-144	1
R-145	Resistor, composition, 2.2 meg $\pm 10\%$, $\frac{1}{2}$ watt, pigtail terminals	V-111 triode grid return	5147	R-145,146	2
R-146	Same as R-145	V-111 triode plate series			
R-147	Resistor, composition, 8200 ohms $\pm 10\%$, 1 watt, pigtail terminals	RF gain control bleeder	5376	R-147	1

Table 6 Parts List For Scott Marine Receiver

Symbol Desig.	Description	Function	Contractor's Drawing and Part Number	All Symbol Designations Involved	Total Per Equip.
RESISTORS (Continued)					
R-148	Potentiometer, wirewound, 1500 ohms $\pm 10\%$, 4 watts, linear taper, shaft 1/4" dia. x 2" long	RF gain control	5282	R-148	1
R-149	Same as R-110	V-107B grid leak			
R-150	Resistor, wirewound, 50 ohms $\pm 5\%$, 15 watts, Grade 1, Class 1, ferrule type	Vacuum tube heater series	5234	R-150	1
R-151	Resistor, wirewound, 310 ohms $\pm 5\%$, 20 watts, Grade 1, Class 1, ferrule type	Vacuum tube heater series	5233	R-151	1
R-152	Potentiometer, composition, 0.25 meg $\pm 20\%$, 0.4 watt, clockwise logarithmic taper, shaft 1/4" dia. x 2" long	Fidelity control	5281	R-152	1
R-153	Same as R-124	V-109, V-110 bias filter			
R-154	Resistor, composition, 3900 ohms $\pm 10\%$, 2 watt, pigtail terminals	Dial lamp shunt	5358	R-154	1
R-155	Same as R-142	Monitor speaker series			
R-156	Resistor, composition, 300 ohms $\pm 5\%$, 1 watt, pigtail terminals	T-117, 60 ohm secondary load	5440	R-156, 157	2
R-157	Same as R-156	T-117, 60 ohm secondary load			
SWITCHES					
S-101A	Switch section, 2 pole, 4 position, rotary type, ceramic wafer, silver contacts	Antenna primary circuit switch	5286-1	S-101A, 101B, 101C	3
S-101B	Same as S-101A	Antenna secondary circuit switch			
S-101C	Same as S-101A	Mixer circuit switch			
S-101D	Switch section, 2 pole, 4 position, rotary type, ceramic wafer, silver contacts	Oscillator circuit switch	5286-2	S-101D	1
S-102A	Switch section, 2 pole, 5 position, rotary type, ceramic wafer, silver contacts	First IF amp. selectivity switch	5286-1	S-102A, 102B, 102C	3
S-102B	Same as S-102A	Second IF amp. selectivity switch			

Table 6 Parts List For Scott Marine Receiver

Symbol Desig.	Description	Function	Contractor's Drawing and Part Number	All Symbol Designations Involved	Total Per Equip.
SWITCHES (Continued)					
S-102C	Same as S-102A	C.W. oscillator circuit switch	5290-1	S-103	1
S-103	Switch section, 2 pole, 3 position, rotary type, ceramic wafer, silver contacts	Noise limiter and phono-radio switch			
S-104	Toggle switch, D.P.S.T., 3 A, 125 V DC, silver plated contacts	Power switch	8333	S-104	1
S-105	Toggle switch, S.P.D.T., 3 A, 125 V DC, silver plated contacts	Monitor speaker switch	7091	S-105	1
TRANSFORMERS RF, AF & POWER					
T-101	RF Transformer Pri.-175 T #34 SCE wire on 1" dia. form, DC resistance 14 ohms, universal wound Sec.-94½ T #34 SCE wire progressive universal wound on 1" dia. form DC resistance 7.0 ohms, wax impregnated	Band 1 antenna transformer	Pri. 5240 Sec. 5241	T-101 Pri. T-101 Sec.	1 1
T-102	RF Transformer Pri.-60 T #34 SCE wire universal wound on ¾" form, DC resistance 3.55 ohms Sec.- 42½ T #29 E wire closewound on ¾" form, DC resistance 0.71 ohms, wax impregnated	Band 2 antenna transformer	Pri. 5242 Sec. 5243	T-102 Pri. T-102 Sec.	1 1
T-103	RF Transformer Pri.- 32 T #34 SCE wire universal wound on ¾" form, DC resistance 1.65 ohms Sec.- 15½ T #24 E wire closewound on ¾" form, DC resistance 0.085 ohms, wax impregnated	Band 3 antenna transformer	Pri. 5244 Sec. 5245	T-103 Pri. T-103 Sec.	1 1

Table 6 Parts List For Scott Marine Receiver

Symbol Desig.	Description	Function	Contractor's Drawing and Part Number	All Symbol Designations Involved	Total Per Equip.
TRANSFORMERS RF, AF & POWER (Continued)					
T-104	RF Transformer Pri.- 23½ T #32 E wire closewound on 3/4" form, DC resistance 0.8 ohms Sec.- 6 3/4 T #24 E wire spacewound on 3/4" form, DC resistance 0.045 ohms, wax impregnated.	Band 4 antenna transformer	Pri. 5246 Sec. 5247	T-104 Pri. T-104 Sec.	1 1
T-105	RF Transformer Pri.- 60 T #34 SCE wire, universal wound, DC resistance 5.0 ohms Sec.- 96½ T #34 SCE wire, progressive universal wound, DC resistance 7.0 ohms, 1" dia. form, wax impregnated	Band 1 mixer transformer	5248	T-105	1
T-106	RF Transformer Pri.- 20½ T #34 SCE wire, universal wound, DC resistance 1.24 ohms Sec.- 41½ T #29 E wire, closewound, DC resistance 0.66 ohms, 3/4" dia. form, wax impregnated	Band 2 mixer transformer	5249	T-106	1
T-107	RF Transformer Pri.- 9½ T #28 DCC wire closewound, DC resistance 0.143 ohms Sec.- 14½ T #24 E wire, closewound, DC resistance 0.082 ohms, 3/4" dia. form, wax impregnated	Band 3 mixer transformer	5250	T-107	1
T-108	RF Transformer Pri.- 6½ T #28 DCC wire interwound, DC resistance 0.1 ohms Sec.- 7½ T #24 E wire, spacewound, DC resistance 0.05 ohms, 3/4" form, wax impregnated	Band 4 mixer transformer	5251	T-108	1

Table 6 Parts List For Scott Marine Receiver

Symbol Desig.	Description	Function	Contractor's Drawing and Part Number	All Symbol Designations Involved	Total Per Equip.
TRANSFORMERS RF, AF & POWER (Continued)					
T-109	RF Transformer Pri.- 12 T #32 E wire, closewound, DC resistance 0.55 ohms Sec.- 61½ T #32 E wire, closewound, DC resistance 2.2 ohms, 1" dia. form, wax impregnated	Band 1 oscillator transformer	5252	T-109	1
T-110	RF Transformer Pri.- 9½ T #29 E wire, closewound, DC resistance 0.18 ohms Sec.- 24½ T #29 E wire, closewound, DC resistance 0.44 ohms, ¾" dia. form, wax impregnated	Band 2 oscillator transformer	5253	T-110	1
T-111	RF Transformer Pri.- 4½ T #24 E wire, spacewound, DC resistance 0.038 ohms Sec.- 12 T #24 E wire, spacewound, DC resistance 0.075 ohms, ¾" dia. form, wax impregnated	Band 3 oscillator transformer	5254	T-111	1
T-112	RF Transformer Pri.- 2 T #24 E wire spacewound, DC resistance 0.025 ohms Sec.- 4½ T #24 E wire, spacewound, DC resistance 0.037 ohms, ¾" dia. form, wax impregnated	Band 4 oscillator transformer	5255	T-112	1
T-113	IF Transformer, 455 KC Pri.- 155 T, 7/41 litz wire, universal wound, DC resistance 4.72 ohms Sec.- 162 T, 7/41 litz wire, universal wound, DC resistance 4.73 ohms Tertiary - 6 T, 7/41 litz wire, tapped at 3 T and wound under primary. 7/16" dia. form, iron core tuned, wax impregnated	#1 IF transformer V-103 to V-104 coupling	5256	T-113	1

Table 6 Parts List For Scott Marine Receiver

Symbol Desig.	Description	Function	Contractor's Drawing and Part Number	All Symbol Designations Involved	Total Per Equip.
TRANSFORMERS RF, AF & POWER (Continued)					
T-114	IF Transformer, 455 KC Pri.- 162 T, 7/41 litz wire, universal wound, DC resistance 4.93 ohms Sec.- 162 T, 7/41 litz wire, universal wound, DC resistance 4.73 ohms Tertiary - 6 T, 7/41 litz wire tapped at 3 T and wound under primary. 7/16" dia. form, iron core tuned, wax impregnated	#2 IF transformer V-104 to V-105 coupling	5257	T-114	1
T-115	IF Transformer, 455 KC Pri.- 210 T, #34 SCE wire universal wound, DC resistance 12.3 ohms Sec.- 2 pi winding 160 each pi, #34 SCE wire, DC resistance total 16.7 ohms, wax impregnated	#3 IF transformer V-105 to V-106 coupling	5258	T-115	1
T-116	RF Transformer Pri.- 35 T #34 SCE wire, universal wound, DC resistance 1.34 ohms Sec.- 165 T #34 SCE wire wound over primary, DC resistance 7.16 ohms, 7/16" dia. form, wax impregnated	C.W. oscillator transformer	5259	T-116	1
T-117	Output Transformer Pri.- 4400 ohms at 1000 CPS, 80 MA DC terminals 1-2-3 Sec.- 200 ohm terminal 4-5, 300 ohm terminals 4-6, 600 ohm terminals 4-7 Sec.- 4 ohm terminals 8-9 Sec.- 60 ohm terminals 10-11-12 Hermetically sealed	V-109 and V-110 to speaker terminals coupling	5214	T-117	1

Table 6 Parts List For Scott Marine Receiver

Symbol Desig.	Description	Function	Contractor's Drawing and Part Number	All Symbol Designations Involved	Total Per Equip.
VACUUM TUBES					
V-101	Vacuum tube (receiving-metal) triple grid super control amplifier. Base: small wafer octal 7 pin, miniature cap. Heater: current 0.3 amp at 6.3 volts AC or DC	RF amplifier	6017	V-101	1
V-102	Vacuum tube (receiving-glass) detector amplifier triode, Base: intermediate shell octal 6 pin. Heater: current 0.15 amp at 12.6 volts AC or DC	HF oscillator	5222	V-102	1
V-103	Vacuum tube (receiving-metal) pentagrid converter, Base: small wafer octal 8 pin. Heater: current 0.15 amp at 12.6 volts AC or DC	First detector and mixer	5219	V-103	1
V-104	Vacuum tube (receiving-metal) triple grid super control amplifier. Base: small wafer octal 8 pin. Heater: current 0.15 amp at 12.6 volts AC or DC	First IF amplifier	5215	V-104,105	2
V-105	Same as V-104	Second IF amplifier	5216	V-106	1
V-106	Vacuum tube (receiving-metal) twin diode. Base: small wafer octal 7 pin. Heater: current 0.15 amp at 12.6 volts AC or DC	Second detector AVC, N.L.	5216	V-106	1
V-107	Vacuum tube (receiving-glass) twin triode. Base: intermediate shell octal 8 pin. Heater: current 0.3 amp at 12.6 volts AC or DC	First AF amplifier, C.W. oscillator	5218	V-107,108	2
V-108	Same as V-107	Second AF amplifier, phase inverter	5220	V-109,110	2
V-109	Vacuum tube (receiving-glass) beam power amplifier. Base: intermediate shell octal 7 pin. Heater: current 0.3 amp at 25 volts AC or DC	Output audio amplifier	5220	V-109,110	2
V-110	Same as V-109	Output audio amplifier			

Table 6 Parts List For Scott Marine Receiver

Symbol Desig.	Description	Function	Contractor's Drawing and Part Number	All Symbol Designations Involved	Total Per Equip.
VACUUM TUBES (Continued)					
V-111	Vacuum tube (receiving-glass) electron ray indicator. Base: small shell octal 7 pin. Heater: current 0.15 amp at 12.6 volts AC or DC	Tuning indicator	5217	V-111	1
V-112	Vacuum tube (receiving-glass) high vacuum rectifier. Base: intermediate shell octal 7 pin. Heater: current 0.3 amp at 25 volts AC or DC	Rectifier	5221	V-112	1
SOCKET					
X-101	Vacuum tube socket, 8 prong octal, mica filled bakelite with mounting plate and retainer ring	Socket for V-101	7035	X-101,102,103,104,105,106,107,108,109,110,112	11
X-102	Same as X-101	Socket for V-102			
X-103	Same as X-101	Socket for V-103			
X-104	Same as X-101	Socket for V-104			
X-105	Same as X-101	Socket for V-105			
X-106	Same as X-101	Socket for V-106			
X-107	Same as X-101	Socket for V-107			
X-108	Same as X-101	Socket for V-108			
X-109	Same as X-101	Socket for V-109			
X-110	Same as X-101	Socket for V-110			
X-111	Vacuum tube socket, 8 prong octal, bakelite with metal shield cap 1 1/4" dia. x 1 1/4" long, 7/16" dia. hole in end	Socket for V-111 tuning indicator	5355	X-111	1
X-112	Same as X-101	Socket for V-112			
X-113	Socket, miniature bayonet lamp, insulated, 2 wire leads, white 15 3/4" long black 17 3/4" long	Dial lamp socket for I-101	5354	X-113	1