

SERVICE MANUAL

SCANNING MONITOR RECEIVER

VHF Band	30-54 MHz
	140-180 MHz
UHF Band	410-514 MHz

MODEL: SX-100

OPERATING INSTRUCTIONS

- a. Connect the power supply of 12 V DC or 120 V AC
Note: Do not forget to connect always the power supply because of clock operation.
- b. Install the antenna
- c. Turn power switch on (POWER)
 Displays R 12-00
 Increase the volume sound. Slide the squelch volume knob to the left side and you can receive weather band. (162,400 MHz)
- d. When used this unit first, charging with electrocity is required for 5~ 10 hours under the conditions that the power switch is on.

1. Frequency Selection by Keyboard

Example: Selection of 30.115 MHz

$\boxed{3} \boxed{0} \boxed{\text{ST}} \boxed{1} \boxed{1} \boxed{5} \rightarrow$ Display 30.115 MHz

\uparrow When pushed this button, the above frequency is received.

Note: 1. The last number must be 0 or 5.

Example: Selection of 470.000 MHz

$\boxed{4} \boxed{7} \boxed{0} \boxed{\text{ST}} \boxed{0} \boxed{0} \boxed{0} \rightarrow$ Display 470.000 MHz

\uparrow When pushed this button, this frequency is received.

Note: 2. This unit displays six (6) figures only. So in case of seven (7) figures' band, please adjust to push the last number to 0 or 5 as the following example;

470.3125 (MHz) \rightarrow Select for 470.315 471.4375 (MHz) \rightarrow Select for 471.440

2. To search a station by "SEEK" Key

- * When pushed this key, the frequency is increased every 5 KHz for all the band and when received, it stops. As far as $\boxed{\text{ST}}$ button is not pushed, it moves to the direction of the frequency increased and when received, it stops to display.
- * When you do not know the frequency exactly, to search more promptly, select a lower frequency than its frequency and push "SEEK" Key.
- * The speed variation of "SEEK" is available. Push "SP" button to increase the speed. Push it again to decrease the speed.
- * To stop "SEEK" operation, push $\boxed{\text{ST}}$ button.
- * The frequency will be displayed continuously.

Note: After adjusting the squelch volume to eliminate the sound, push seek button.

3. Memory Write (MW)

A. To write the frequency which is being received at present.

$\boxed{\text{MW}} \boxed{\text{M1}}$: This means it was memorized in the memory No. 1. When desired to memorize in the other memory, push other $\boxed{\text{M()}}$ respectively.

B. In case that you know the frequency beforehand, select the frequency by keyboard to memorize.

Example: To memorize 470.015 MHz and write in Memory Channel 2.

$\boxed{4} \boxed{7} \boxed{0} \boxed{\text{ST}} \boxed{0} \boxed{1} \boxed{5} \boxed{\text{MW}} \boxed{\text{M2}}$

\uparrow When pushed this button 470.015 MHz is memorized.

Note: 1. Memory operation should be made within 5 seconds after pushing key button because after 5 seconds, time displays.

2. The prior memory contents will be changed to a new memorized frequency.

4. Memory Read Key $\boxed{\text{M1}} \sim \boxed{\text{M16}}$

To select the memory by manual, when pushed $\boxed{\text{M1}}$, you can receive its frequency.

5. Operation of "SCAN A"

Memory channel $\boxed{\text{M1}} \sim \boxed{\text{M16}}$ is scanned repeatedly. When the signal comes in, the scanning is stopped. When the signal is not received, it moves automatically to the next memory channel. At the time, if operates the "SCAN DELAY" volume, the starting time of scanning will be adjusted to hold for 4 seconds in maximum. Slide this "SCAN DELAY" knob to the right side to increase delay time.

6. Operation of "SCAN WRITE" Key $\boxed{\text{SW}}$ & "SCAN B"

These keys are used to memorize the selection of memory channels (M1 ~ M16) which are desired to scan.

Note: To stop "SCAN A" or "SCAN B" operation, push $\boxed{\text{ST}}$ button by all means.

Example: In case of Scanning $\boxed{\text{M1}} \boxed{\text{M3}} \boxed{\text{M4}} \boxed{\text{M6}}$

$\boxed{\text{SW}} \boxed{\text{M1}} \boxed{\text{M3}} \boxed{\text{M4}} \boxed{\text{M6}} \boxed{\text{SCAN B}}$

Scanning will be made in order of M1 ~ M16

ALIGNMENT PROCEDURE

1. PLL Adjustment

- A. Adjustment for 5.12 MHz OSC Circuit.
Connect the counter with pin No.9 of IC105 and adjust CT201. The frequency shall be less than 2.560.000 Hz \pm 10Hz.
- B. Adjustment for 5.000 MHz OSC Circuit.
Connect the counter with Pin No.6 of IC113 and adjust the frequency on CT202 for 5.000.000 Hz \pm 10 Hz.
Note: For the above adjustment, the measurement equipment (counter) within \pm 5 Hz accuracy must be used.

2. Receiver Adjustment

- A. 10.240 MHz adjustment.
Connect the small capacity, i.e., 1pF or less, with the emitter of the transistor Q205 and then connect it with the counter. (If the counter does not operate, put the buffer amplifier in.) Adjust CT201 and adjust the frequency for 10.240.000 Hz \pm 100Hz.
- B. VHF VCO Voltage Adjustment
 - i) Connect the volt meter with TP3 and set the frequency of 30.000 MHz on the keyboard. Adjust L203 to obtain the voltage for $1.0_{+0.5}^{-0.1}$ V.
 - ii) Set the frequency for 53.995 MHz and check the voltage for 17 ± 3 V.
- C. Adjustment of VHF High VCO
 - 1) Connect the volt meter with TP4 and set the frequency of 140.000 MHz. Adjust L201 core to obtain the voltage for $1.0_{+0.5}^{-0.1}$ V.
 - ii) Set the frequency for 160.000 MHz and make sure that the voltage is 8 ± 2 V.
- D. Adjustment of UHF VCO
 - i) Set the frequency for 410.000 MHz and connect the volt meter with TP4. Adjust L301 to obtain the voltage for 1V.
 - ii) Set the frequency for 513.995 MHz and make sure that the voltage is 12.8 ± 3 V.
- E. Sensitivity Adjustment of VHF Low Band
 - i) Connect the sweep generator output with TP2 and connect the sweep generator input with TP1. Set the frequency of the sweep generator for 455 KHz and make sure of "S" curve. At the same time, adjust IFT102, 301 to obtain the maximum height of "S" curve. Then, the output of sweep generator is required to reduce gradually.
 - ii) Connect the signal generator (SG) with antenna and set the frequency for 42.000 MHz. Reducing the output of SG gradually, adjust T101, T102, IFT101 to obtain the maximum sensitivity. For this adjustment, connect the oscilloscope with EXT speaker jack. (Dummy load 8 ohm included.)
- F. Sensitivity Adjustment of VHF High Band
Connect the oscilloscope and dummy load 8 ohm with EXT speaker jack and set the frequency for 150.555 MHz. Then adjust L101, L102 to obtain the maximum sensitivity. Make sure that the sensitivity difference is within 6 db at 140.555 MHz and 179.555 MHz.
- G. Sensitivity Adjustment of UHF Band
As well as the item (F), set the each equipment and set the frequency for 470.555 MHz and adjust CT401, CT402, CT301 to obtain the maximum sensitivity. Adjust one turn coil length by high frequency and adjust the trimmer by low frequency to reduce the tracking error. Make sure that the sensitivity difference is within 6 db at 410.555 MHz and 510.555 MHz. For the above adjustment, set the squelch volume in minimum.
- H. Adjustment of Automatic Stop Accuracy
Connect the volt meter with TP6. Set the frequency for 42.000 MHz on the keyboard and set the SG for the frequency of 2.5 KHz high (42.0025 MHz) and adjust VR401 for the voltage to drop 0.1V ($8.25 \rightarrow 8.15$ V) (Under the SG level 20 db, when raising 5 KHz, the sound should be eliminated.).
- I. Position Adjustment of Squelch Volume
Adjust VR402 and when the noise is received at the 30% angle of squelch volume, noise should be eliminated. At the maximum position, 15 db input signal should be eliminated. Required to check on the following nine (9) frequencies entirely.
30.450, 40.400, 50.400 140.400, 150.400, 170.400 410.400, 450.400, 500.400

MATERIALS FOR REPAIRING INCLUDING VOLTAGE READINGS

1. VOLTAGES FOR IC BAND INDICATION IN EACH BAND

BAND	RECEIVING FREQUENCY	IC111 PIN NO.15	IC111 PIN NO.1	IC111 PIN NO.10	IC111 PIN NO.9	IC112 PIN NO.15
1	30 – 53.995 (MHz)	0	0	0	0	0
2	140 – 159.995	1	0	1	0	1
3	160 – 179.995	1	1	0	0	1
4	410 – 429.995	1	0	1	1	0
5	430 – 449.995	0	0	1	1	0
6	450 – 469.995	1	1	0	1	0
7	470 – 489.995	0	1	0	1	0
8	490 – 513.995	1	0	0	1	0

NOTE: IC111 SN74193N IC112 SN74193N 1 High (More than 2 volts) 0 Low (Less than 0.8 volts)

2. CODE TABLE AND IC TERMINAL ON PLL CODE 30 – 53.995 (MHz)

$$\text{Receiving Frequency } f_o = f_e + 0.005 \cdot 10(N_2 - N_1) - A \quad -40.65 \text{ (MHz)}$$

Note: f_e means minimum receiving frequency in each band.

Examples Band 1 30 (MHz) Band 2 140 (MHz) Band 3 160 (MHz)

EXAMPLE: Levels of Receiving Frequency f_o and each ICs' Pin. (1 = High, 0 = Low)

BAND	IC f_o / PIN NO.	A IC108 SN74162N				N ₁ IC107 SN74193N				N ₂ IC105 uPC861						
		3	4	5	6	15	1	10	9	1	2	3	4	5	6	7
1	30 (MHz)	0	0	0	0	1	1	0	0	1	1	0	0	1	1	0
	40.005	1	0	0	1	0	1	0	1	0	0	0	0	0	0	1
2	140	0	0	0	0	1	1	0	0	1	1	0	0	1	1	0
	159.995	1	0	0	0	1	1	0	0	0	0	1	1	0	0	1
4	410	0	0	0	0	1	1	0	0	1	1	0	0	1	1	0
	429.995	1	0	0	0	1	1	0	0	0	0	1	1	0	0	1
8	490	0	0	0	0	1	1	0	0	1	1	0	0	1	1	0
	500	0	0	0	0	1	1	0	1	0	0	0	0	0	0	1
	509.880	0	0	1	0	1	0	1	0	0	0	1	1	0	0	1
	513.995	1	0	0	0	1	1	0	0	1	0	0	0	1	0	1
CODE		1	2	4	8	1	2	4	8	16	32	64	128	256	512	1024

3. VARIATION BY THE FREQUENCY OF PLL LOCKED VOLTAGE

i. High VCO Voltage (TP4) (Varied by bands)

Example:	BAND	RECEIVING FREQUENCY	VOLTAGE OF TP4 (V)	BAND	RECEIVING FREQUENCY	VOLTAGE OF TP4 (V)
	1	30.000	19	4	410.000	0.8
	2	150.000	1.4	7	470.000	9.1
	3	160.000	5	8	490.000	14

ii. Low VCO Voltage (TP3) Varied by the receiving frequency within each band

Example:	RECEIVING FREQUENCY	VOLTAGE OF TP3 (V)
	30.000	0.9
	40.000	4.6
	53.995	17

4. VOLTAGES OF EACH IC & TRANSISTORS

Used by tester. 480 MHz received.

S: Pulse wave

i. PLL P.C. BOARD

IC101 (MP2039)

PIN NO.	1	2	3	4	5	6	7	8	9	10	11	12	13	14	15	16	17	18	19	20
VOLTAGE (V)	0	0	0	0	0	0	0	0	0	0	0	-20	0	0	0	0	-7.6	0	-9.2	0
PIN NO.	21	22	23	24	25	26	27	28	29	30	31	32	33	34	35	36	37	38	39	40
VOLTAGE (V)	0	0	-7.6	-13	-13	6	6	9.2	-18	-18	-18	-18	-18	-18	0	-18	-18	0	0	0

IC \ PIN NO.	1	2	3	4	5	6	7	8	9	10	11	12	13	14	15	16
IC102 (TP4016)	3.7S	0	0	0	0	0	0	7	0	0	0	0	0	9.4	-	-
IC103 (TP4518)	1.8	0	0	0	3.7S	1.8S	0	0	0	9.4	9.4	9.4	0	0	0	9.4
IC104 (TP4518)	1.8	9.4	4.7	3.8	3.8	1.8	0	0	1.8	9.4	4.7	3.8	3.8	1.8	0	9.4
IC106 (SN74LS00N)	4.7	4.7	0	0	0	4	0	0	4	4	0	4	4	4.7	-	-
IC107 (SN74193N)	4.6	2	2	1	2.5	2	2	0	0	0	4	4	4	0	4.4	4.8
IC108 (SN74162N)	1	2.5	0	0	0	0	0	0	4	1	4	0	0	4	4	4.8
IC109 (uPB551C)	4.8	2.4	0	0	1.8	0	4.8	4.8	-	-	-	-	-	-	-	-
IC110 (SP8658M)	2	4.7	0	0	0	0	0	2.2	-	-	-	-	-	-	-	-
IC111 (SN74193N)	4.4	2	1.8	1.1	0.7	2	2.3	0	4.4	0	3.9	0	3.9	0	0	4.7
IC112 (SN74193N)	4.7	3.9	2.8	1.1	3.7	3.9	3.9	0	4.7	4.7	3.9	3.6	3.9	0	0	4.7
IC113 (SN74LS00N)	1.25	1.25	1.25	1.3	1.3	1.6	0	3.9	0.7	0	0	3.9	3.6	4.7	-	-
IC114 (SN7490AN)	1.95	0	0	0	4.7	0	0	1.6	1.6	0	0.9	2	0	1.55	-	-
IC115 (uPC1008C)	0.9	3.5	3.6	3.6	1.2	3.2	0	0	0	1.25	3.5	3.5	3.6	4.7	-	-
IC116 (TP4015)	0	0	9.4	0	9	0	0	0	0	0	9	0	0	0	9	9.4
IC117 (TP4015)	0	0	0	0	0	0	0	0	0	0	9	0	9	0	0	9.4
IC118 (TP4015)	0	0	0	0	0	0	0	0	0	0	0	9.2	9.2	0	9	9.4
IC105 (uPD861C)	5.4	5.4	0	0	5.4	5.4	0	0	2.2	1.6	2.2	4.8	3.8	0	4.7	2.2
	PIN NO.		17	18	19	20	21	22	23	24						
			2.2	4.7	0	0	1.2	4.8	0	4.8						

	EMITTER (SOURCE)	COLLECTOR (DRAIN)	BASE (GATE)
Q101 (2SK49)	0	4.8	-0.75
Q102 (2SC945)	0	3.2	-0.2
Q103 (2SC945)	0	8.8	0.6
Q104 (2SC945)	0.6	8.5	1.25
Q105 (2SC1730)	0	2.7	0.6
Q304 (2SD471)	0	13.8	0.6
Q305 (2SC2001)	0	0	0
Q306 (2SC2001)	0	0	0.85
Q307 (2SC2001)	10	14	10.4
Q308 (2SC945)	0	0	0.6
Q309 (2SA539)	9.7	9.6	9.1

ii. RX P.C. BOARD

Received 480 MHz

() 170 MHz received, * : Varied by the audio signal level.

PIN NO.	1	2	3	4	5	6	7	8	9	10
IC301 (KB4406)	1.45	1.45	0	8.8	8.8	-	-	-	-	-
IC302 (KB4406)	1.45	1.4	0	8	8	-	-	-	-	-
IC501 (uPC576H)	5.9	14	14	7.2	12	0.8	1.3	0	0.4	1.3
IC502 (uPC143G05)	12	4.7	0	-	-	-	-	-	-	-

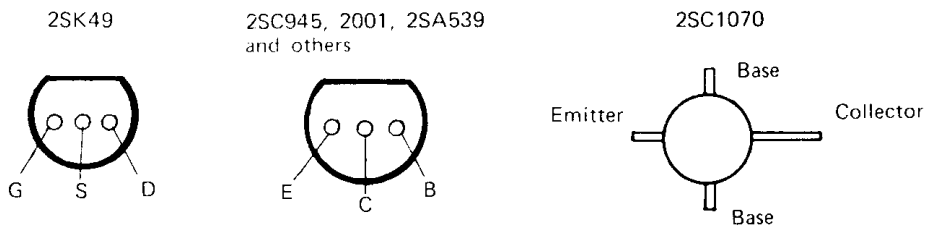

BOTTOM VIEW OF TRANSISTORS

BLOCK DIAGRAM

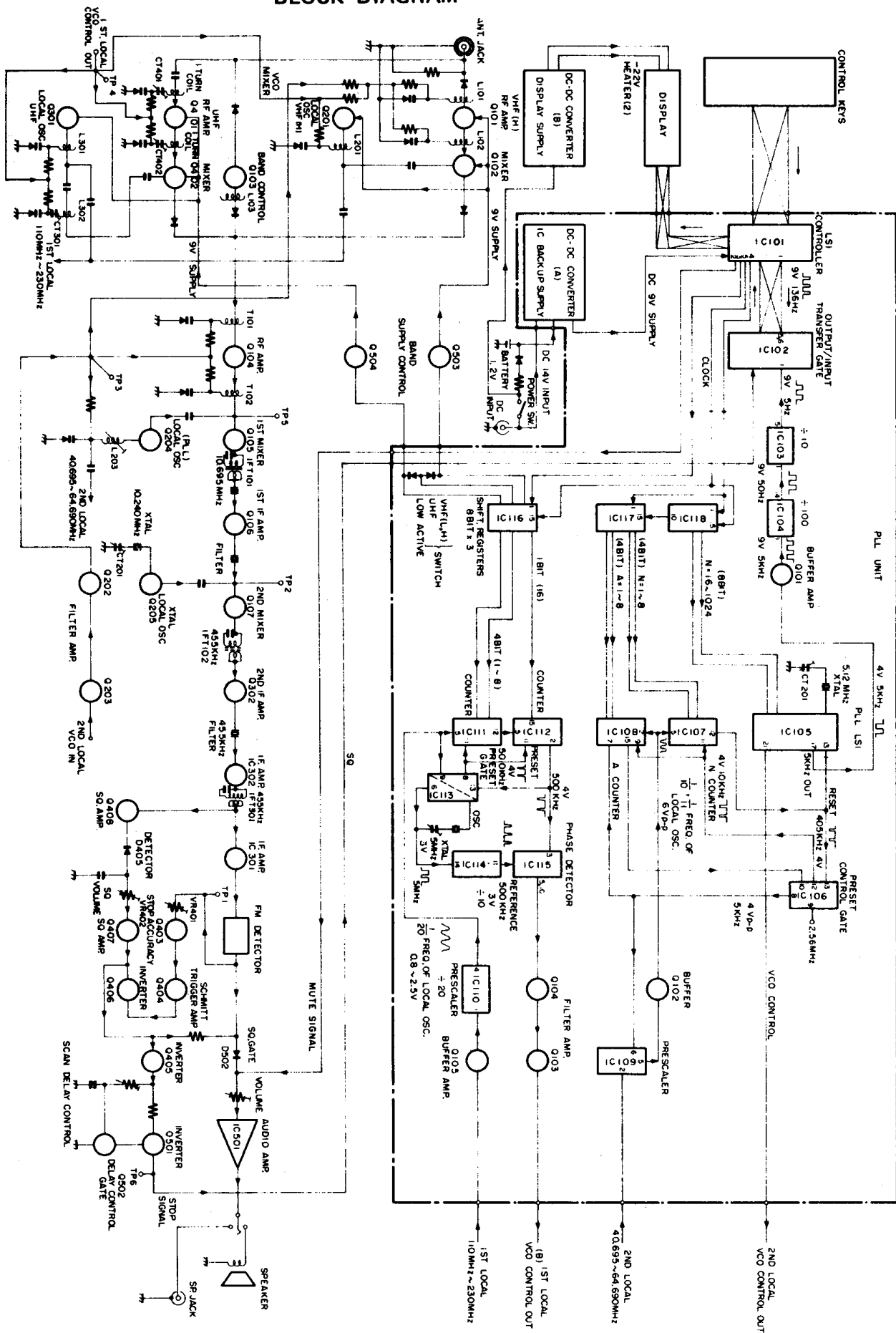

COMPONENTS LIST

Part No.	Description	Q'ty
45896	Case, Top	1
45897	Case, Bottom	1
45919	Side Plate, Left	1
45899	Side Plate, Right	1
45900	Rear Plate	1
45904	Partition Plate	1
923616	Speaker	1
923668	Antenna Jack	1
923681	Bushing, Antenna	1
	Serial No. Label	1
923628	Jack, 3.5ϕ	1
45741	Escutcheon	1
45910	Window	1
45911	Shield Plate, VR	1
45901	Knob, Push	1
45902	Bracket, VR	1
45903	Bracket, Escutcheon	2
45909	Plate, Escutcheon	1
915508	Volume 20KA, Slide (Squelch & Volume)	2
915540	Volume 20KB, Slide (Scan Delay)	1
45780	Rubber Contact	1
912113	Push Switch	1
45782	Knob, Memory, Clock	18
45783	Knob, Slide (Scan Delay, Squelch, Volume)	3
45781	Knob, Seek, Scan A x B	3
45784	Case, Front	1
45912	Dust Cover, Speaker	1
45920	Knob A (Key button 0 - 9)	10
45921	Knob B (ST, FR, SW, MW, SP)	5
45967	Knob, Weather Band	2
922163	Rubber Foot	4
42239	Cushion Foam	1
923629	External Power Jack	1
	Ground Lead	1
45942	Tap Boss	2
30958	Receiver P.C. Board Ass'y	1
30960	Keyboard P.C. Board Ass'y	1
45877	Shield Case DC/DC Converter (A)	1

Part No.	Description	Q'ty
45878	Top Cover, Shield Case	1
30961	P.C. Board, DC/DC Converter (A)	1
45879	Shield Case, DC/DC Converter (B)	1
45880	Top Cover, Shield Case	1
30962	P.C. Board, DC/DC Converter (B)	1
30965	Battery P.C. Board Ass'y	1
45907	Shield Cover, PLL	2
45898	Shield Plate A, PLL	1
45906	Shield Plate B, PLL	1
30959	PLL P.C. Board Ass'y	1
45905	Shield Plate, Receiver P.C.B.	1
922095	Pad, Lead Wire	1
30996	Terminal Board Ass'y	1
43996	Mounting Bracket	2
	AC/DC Adaptor	1
	Antenna	1
923630	Plug, 3.5ϕ	1
923631	External Power Plug	1
923669	Plug, Antenna	1
923675	Battery Lead	1
021702	Screw M1.7 x 4.6, BH black	24
022046	Screw M2 x 4, RH	8
022685	Screw M2.6 x 5, RH	1
022614	Screw M2.6 x 4, BH	2
022655	Screw M2.6 x 4, Truss	1
023055	Screw M3 x 4, BH	33
023154	Screw M3 x 4, BH black	13
023145	Screw M3 x 6, BH black	4
023108	Screw M3 x 8, BH black	4
023143	Screw M3 x 8, RH	1
024021	Screw M4 x 4, BH	1
	Washer M3, Plain	4
013003	Nut M3, Hex.	4

ELECTRICAL COMPONENT LIST

1. RECEIVER P.C. BOARD

Ref. No.	Part No.	Description	Q'ty
SEMI-CONDUCTORS			
Q101, 102	916116	Silicon Transistor 2SC1674	2
Q103	916158	Silicon Transistor 2SC945	1
Q104	916100	FET 2SK49 (H)	1
Q105, 106, 107	916144	Silicon Transistor 2SC1675	3
Q201	916116	Silicon Transistor 2SC1674	1
Q202, 203	916158	Silicon Transistor 2SC945	2
Q204	916116	Silicon Transistor 2SC1674	1
Q205	916158	Silicon Transistor 2SC945	1
Q301	916173	Silicon Transistor 2SC1730	1
Q302	916144	Silicon Transistor 2SC1675	1
Q401	916176	Silicon Transistor 2SC1070	1
Q402	916173	Silicon Transistor 2SC1730	1
Q403 thru. 407	916158	Silicon Transistor 2SC945	5
Q408	916144	Silicon Transistor 2SC1675	1
Q501, 502	916158	Silicon Transistor 2SC945	2

Ref. No.	Part No.	Description	Q'ty
Q503, 504	916107	Silicon Transistor 2SA539	2
Q505	916177	Silicon Transistor 2SC1957	1
Q506	916144	Silicon Transistor 2SC1675	1
IC301, 302	916124	IC KB4406	2
IC501	916102	IC uPC576H	1
IC502	916135	IC uPC143G05 or 78M05	1
D101	923147	Diode IS953	1
D102	923395	Diode IS2222	1
D103, 104	923211	Diode ISV50	2
D105, 106	923147	Diode IS953	2
D107, 108	923211	Diode ISV50	2
D109	923147	Diode IS953	1
D110	922604	Diode IS188	1
D201, 202	923211	Diode ISV50	2
D301, 302	923416	Diode IS2209	2
D303, 304	922604	Diode IS188	2

ELECTRICAL COMPONENT LIST (Cont'd)

J.I.L. SX-100

1. RECEIVER P.C. BOARD

Ref. No.	Part No.	Description	Q'ty
D401, 402	923416	Diode IS2209	2
D403, 404	923147	Diode IS953	2
D405	922604	Diode IS188	1
D501, 502	923147	Diode IS953	2
D503	923450	Diode RD10EB	1
D504	922860	Diode SR-1K-1	1
D505	923428	Diode RD-8.2EB	1
COILS AND OTHERS			
L101, 102	923627	Coil 2-1/2 T	2
L103	913563	Micro Inductor 18uH	1
L201	923627	Coil 2-1/2 T	1
L202		No component	
L203	923625	Coil 5-1/2 T	1
L204	913737	Micro Inductor 0.75uH	1
L301	923626	Coil 1-1/2 T	1
L302	923730	UHF Coil A	1
L303	913559	Micro Inductor 1mH	1
L304	913563	Micro Inductor 18uH	1
L401, 402	923731	UHF Coil B	2
CH501	914028	Choke Coil	1
CH502	914020	Choke Coil	1
T101, 102	922923	IFT 4911X	2
IFT101	922501	IFT 10741	1
IFT102	922838	IFT 353N	1
IFT301	922594	IFT 1899	1
IFT401	922390	IFT 1009	1
CF101	923698	Ceramic Filter SFA 10.7MF-A	1
CF102	922974	Ceramic Filter SFE 10.7MS	1
CF301	923727	Ceramic Filter SFD 455S4	1
CF302	923555	Ceramic Filter CFW 455D	1
X201	923213	Crystal Unit 10.240 MHz	1
CAPACITORS, all are in 50 working voltage unless otherwise specified.			
C101	913051	Ceramic 0.001uF	1
C102		No component	
C103	913248	Ceramic 3pF	1
C104	913078	Ceramic 4pF	1
C105	913061	Ceramic 0.01uF	1
C106	913093	Ceramic 25pF	1
C107	913121	Ceramic 0.02uF	1
C108	913248	Ceramic 3pF	1
C109, 110, 111	913121	Ceramic 0.02uF	3
C112	913051	Ceramic 0.001uF	1
C113, 114	913020	Mylar 0.01uF	2
C115	913121	Ceramic 0.02uF	1
C116	913172	Ceramic 40pF	1
C117, 118, 119	913121	Ceramic 0.02uF	3
C120, 121	913129	Ceramic 0.047uF	2
C122	913121	Ceramic 0.02uF	1
C123	913093	Ceramic 25pF	1
C201	913078	Ceramic 4pF	1
C202	913095	Ceramic 12pF	1
C203	913172	Ceramic 40pF	1
C204	913121	Ceramic 0.02uF	1
C205	913052	Ceramic 10pF	1
C206	913081	Ceramic 1pF	1

Ref. No.	Part No.	Description	Q'ty
C207	913455	Ceramic 30pF (UJ)	1
C208	913121	Ceramic 0.02uF	1
C209	913401	Tantalum 0.47uF	1
C210		No component	
C211	913174	Electrolytic 100uF 25V	1
C212	913248	Ceramic 3pF	1
C213	913427	Ceramic 18pF (CH)	1
C214	913454	Ceramic 40pF (SH)	1
C215	913567	Ceramic 56pF (UJ)	1
C216	913162	Ceramic 680pF	1
C217	913076	Ceramic 2pF	1
C218 thru. 220		No component	
C221	913121	Ceramic 0.02uF	1
C222	913073	Ceramic 330pF	1
C223	913081	Ceramic 1pF	1
C224	913568	Ceramic 50pF (UJ)	1
C225		No component	
C226	913578	Ceramic 5pF (UJ)	1
C227	913010	Mylar 0.02uF	1
C228	913021	Mylar 0.1uF	1
C229	913121	Ceramic 0.02uF	1
C301	913052	Ceramic 10pF	1
C302	913060	Ceramic 0.01uF	1
C303	913078	Ceramic 4pF	1
C304	913072	Ceramic 22pF	1
C305	913121	Ceramic 0.02uF	1
C306, 307	913081	Ceramic 1pF	2
C308	913331	Semi-Con. 0.1uF 12V (SC)	1
C309, 310, 311, 312	913129	Ceramic 0.047uF	4
C313	913044	Mylar 0.047uF	1
C314	913060	Ceramic 0.01uF	1
C315		No component	
C316	913369	Electrolytic 22uF 16V	1
C317	913578	Ceramic 5pF	1
C318	913121	Ceramic 0.02uF	1
C401	913076	Ceramic 2pF	1
C402	913081	Ceramic 1pF	1
C403	913060	Ceramic 0.01uF	1
C404	913051	Ceramic 0.001uF	1
C405	913121	Ceramic 0.02uF	1
C406	913076	Ceramic 2pF	1
C407	913060	Ceramic 0.01uF	1
C408	913094	Ceramic 8pF	1
C409, 410, 411	913121	Ceramic 0.02uF	3
C412	913148	Electrolytic 4.7uF 16V	1
C413	913051	Ceramic 0.001uF	1
C414, 415	913129	Ceramic 0.047uF	2
C416	913265	Ceramic 56pF	1
C417	913129	Ceramic 0.047uF	1
C418	913180	Electrolytic 47uF 16V	1
C419	913051	Ceramic 0.001uF	1
C420	913121	Ceramic 0.02uF	1
C501	913369	Electrolytic 22uF 16V	1
C502	913180	Electrolytic 47uF 16V	1
C503	913348	Electrolytic 0.47uF	1
C504	913401	Tantalum 0.47uF	1
C505	913020	Mylar 0.01uF	1
C506	913010	Mylar 0.02uF	1
C507	913004	Mylar 0.002uF	1
C508	913148	Electrolytic 4.7uF 16V	1
C509	913369	Electrolytic 22uF 16V	1
C510	913180	Electrolytic 47uF 16V	1

ELECTRICAL COMPONENT LIST (Cont'd)

1. RECEIVER P.C. BOARD

Ref. No.	Part No.	Description	Q'ty
C511	913069	Electrolytic 220uF 16V	1
C512	913284	Semi-Con. 0.2uF 12V (SC)	1
C513, 514	913030	Electrolytic 470uF 16V	2
C515	913121	Ceramic 0.02uF	1
C516	913129	Ceramic 0.047uF	1
C517	913069	Electrolytic 220uF 16V	1

2. PLL UNIT P.C. BOARD & OTHERS

Ref. No.	Part No.	Description	Q'ty
SEMI-CONDUCTORS			
Q101	916100	FET 2SK49	1
Q102, 103, 104	916158	Silicon Transistor 2SC945	3
Q105	916173	Silicon Transistor 2SC1730	1
Q106	916158	Silicon Transistor 2SC945	1
Q304	916126	Silicon Transistor 2SD471	1
Q305, 306, 307	916162	Silicon Transistor 2SC2001	3
Q308	916158	Silicon Transistor 2SC945	1
Q309	916107	Silicon Transistor 2SA539	1
IC101	916175	IC TMS1370 or MP2039	1
IC102	916179	IC TP4016A	1
IC103, 104	916180	IC TP4518	2
IC105	916136	IC uPD861C	1
IC106	916184	IC SN74LS00N	1
IC107	916181	IC SN74LS193N	1
IC108	916182	IC SN74162N	1
IC109	916185	IC uPB551C	1
IC110	916186	IC SP8658N	1
IC111, 112	916181	IC SN74LS193N	2
IC113	916184	IC SN74LS00N	1
IC114	916183	IC SN7490AN	1
IC115	916187	IC uPC1008C	1
IC116, 117, 118	916178	IC TP4015AN	3
D101	923147	Diode IS953	1
D201, 202	923147	Diode IS953	2
D301	923587	Diode RD24EB	1
D302, 303	923147	Diode IS953	2
D304	923588	Diode RD6.2EB	1
D305 thru. 309	923147	Diode IS953	5
D310	923586	Diode RD9.1EB	1
D311	923417	Diode RD5.1EB	1
D312	923495	Diode RD7.5EB	1
D313	923586	Diode RD9.1EB	1
D314	923147	Diode IS953	1
D1 thru. 15	923147	Diode IS953	15
COILS & OTHERS			
L301 thru. 305	913559	Micro Inductor 1mH	5
IFT301	923620	IFT L-5K7-H5 (R12-0523)	1
IFT302	923621	IFT L-5K7-H5 (R12-0519)	1
IFT303	923624	IFT L-4K7H5 (R12-0511)	1
CH301	914023	Choke Coil	1
X201	923595	Crystal Unit 5.12 MHz	1
X202	923596	Crystal Unit 5.000 MHz	1
CAPACITORS, all are in 50 working voltage unless otherwise specified.			
C101	913013	Electrolytic 100uF 10V	1

Ref. No.	Part No.	Description	Q'ty
C518	913284	Semi-Con. 0.2uF 12V (SC)	1
C519	913061	Electrolytic 1000uF 16V	1
C520	913284	Semi-Con. 0.2uF 12V (SC)	1
C521	913072	Ceramic 22pF	1
C522	913073	Ceramic 330pF	1
CT301, 401, 402	913147	Trimmer 10pF	3
CT201	913533	Trimmer 50pF	1
VR301, 302	915451	Semi-Variable resistor 20K ohm	2
VR401	915411	Solid Volume 330K ohm	1
VR402	915381	Solid Volume 10K "	1

Ref. No.	Part No.	Description	Q'ty
C102	913566	Ceramic 60pF	1
C103	913348	Electrolytic 0.47uF (NP)	1
C104	913129	Ceramic 0.047uF	1
C105, 106	913348	Electrolytic 0.47uF (NP)	2
C107 thru. 110	913268	Ceramic 47pF	4
C201	913286	Ceramic 30pF (CH)	1
C202	913482	Ceramic 30pF (SH)	1
C203	913018	Electrolytic 10uF 10V	1
C204, 205	913013	Electrolytic 100uF 10V	2
C206	913063	Ceramic 0.047uF	1
C207, 208, 209	913060	Ceramic 0.01uF	3
C210	913063	Ceramic 0.047uF	1
C211	913060	Ceramic 0.01uF	1
C212	913063	Ceramic 0.047uF	1
C213	913436	Tantalum 0.47uF 35V	1
C214, 215, 216	913063	Ceramic 0.047uF	3
C217	913051	Ceramic 0.001uF	1
C218 thru. 224	913129	Ceramic 0.0047uF	7
C225 thru. 237	913121	Ceramic 0.02uF	13
C238	913121	Ceramic 0.02uF	1
C239	913063	Ceramic 0.047uF	1
C240	913266	Ceramic 82pF	1
C241	913121	Ceramic 0.02uF	1
C242	913058	Ceramic 470pF	1
C243	913331	Semi-Con. 0.1uF 12V	1
C301, 302	913445	Tantalum 1uF	2
C303	913151	Ceramic 0.001uF	1
C304		No component	
C305	913175	Electrolytic 10uF 16V	1
C306	913071	Mylar 0.001uF	1
C307, 308	913381	Tantalum 10uF 16V	2
C309	913020	Mylar 0.01uF	1
C310	913026	Electrolytic 220uF 10V	1
C311	913018	Electrolytic 10uF 10V	1
C312	913156	Electrolytic 470uF 10V	1
C313	913061	Electrolytic 1000uF 16V	1
C314	913174	Electrolytic 100uF 25V	1
CT201, 202	913519	Trimmer 50pF	2

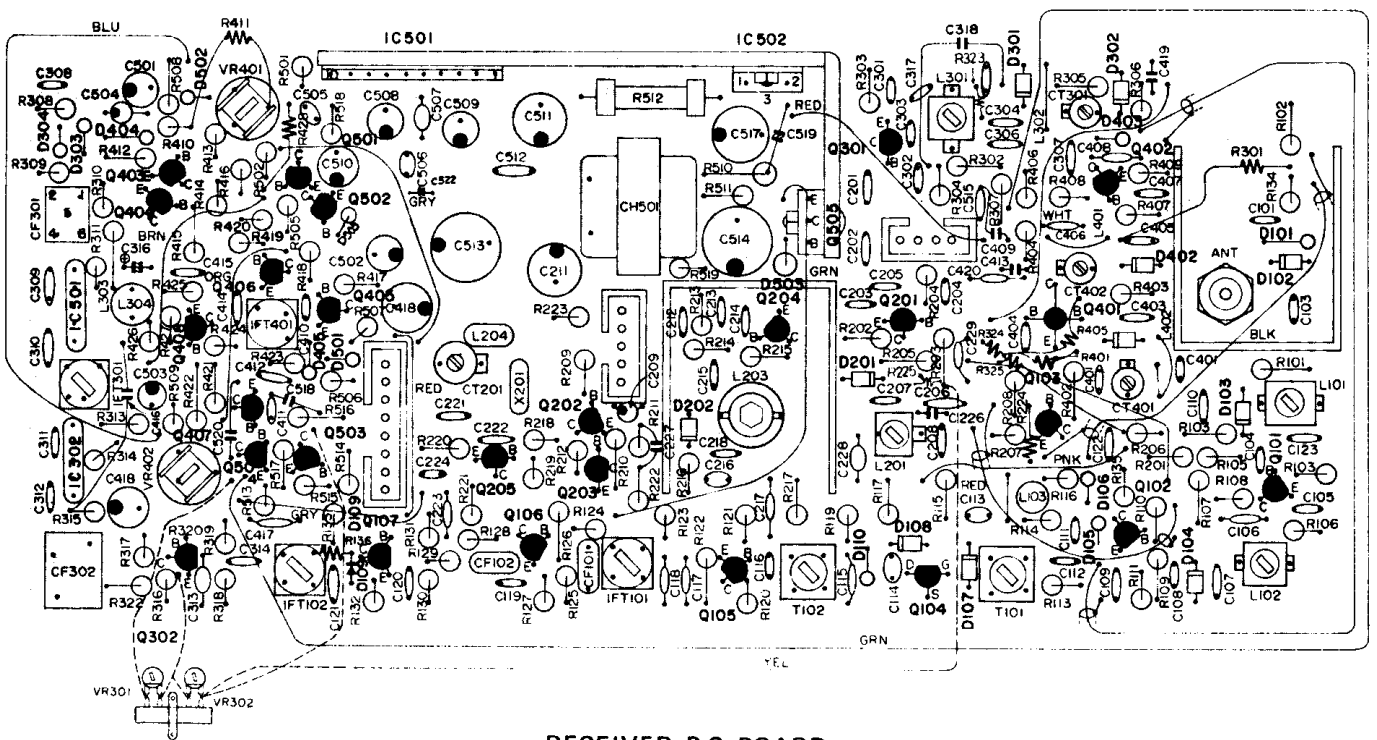
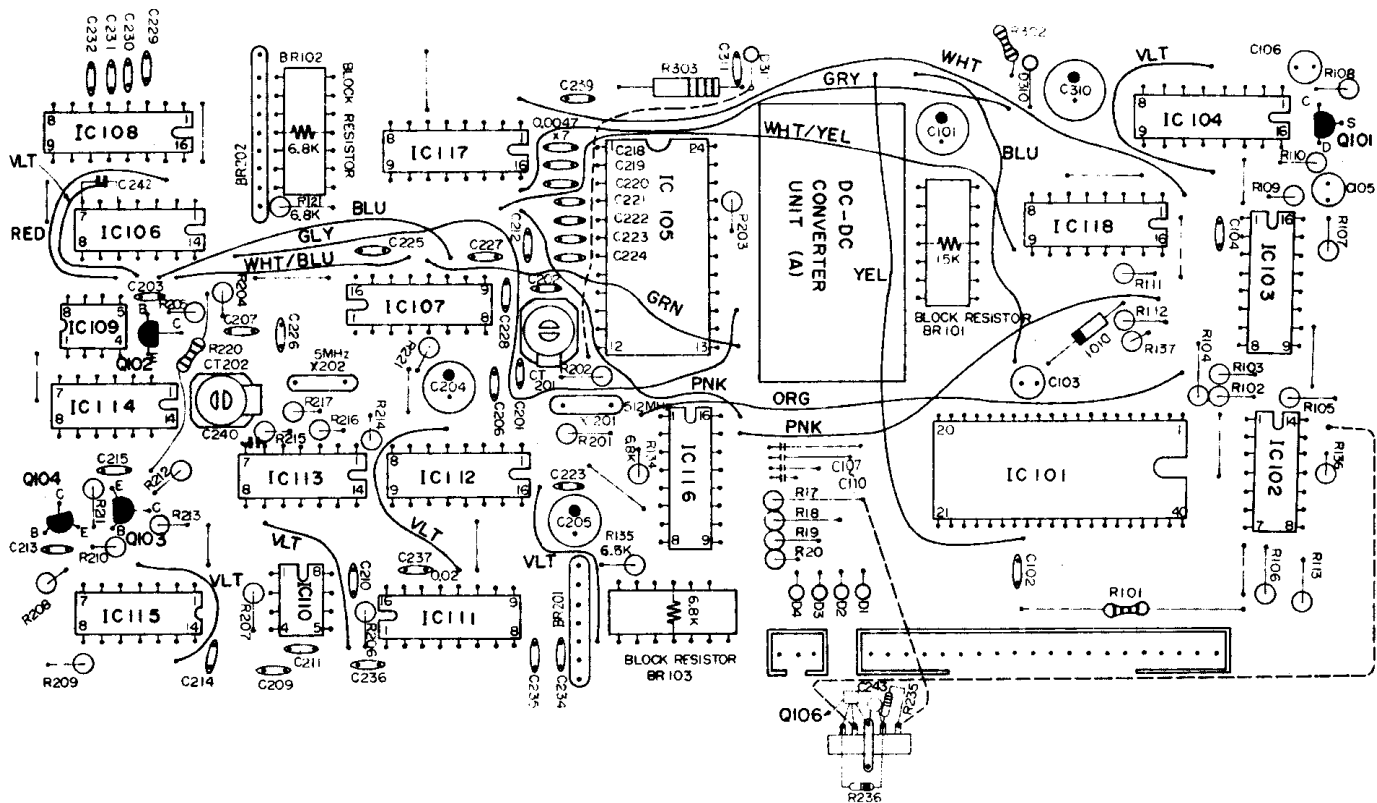

RECEIVER P.C. BOARD

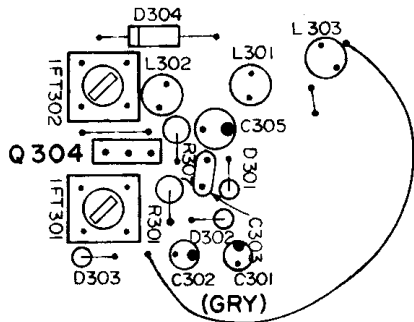

DC/DC CONVERTER (B) P.C. BOARD

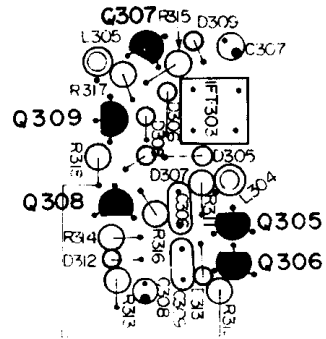

DC/DC CONVERTER (A) P.C. BOARD

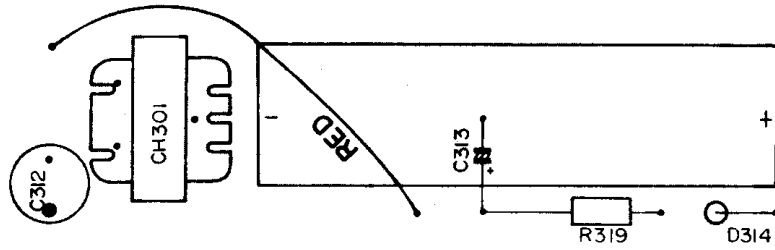

BATTERY P.C. BOARD

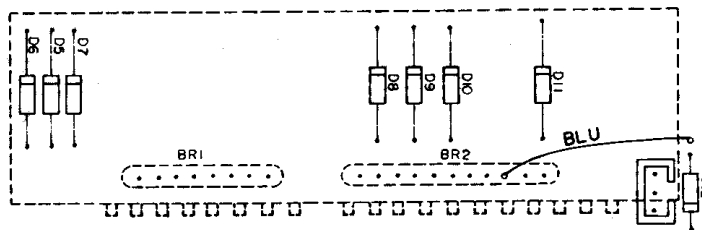
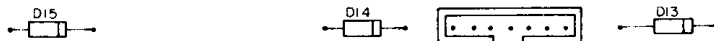

DIGITAL KEYBOARD P.C.B.

SCHEMATIC DIAGRAM (RECEIVER)

