



VV-808

车载对讲机

MOBILE TRANSCEIVERS



用户手册

User Manual

Notice

Please use the radio according to the requirement of local regulatory agencies.

To User

Thank you for using  **EIXEN** Mobile transceiver. We trust our product will give you a convenient and steady communication. Hope you would like the great functions with this radio.

Contents

Security Information	1
Accessories & Options	2
Supplied Accessories.....	2
Optional Accessories	2
Installation.....	3
Connect Power	3
Radiating of Radio	3
Install with Bracket	4
Connect Accessories.....	4
Familiarize with the radio	5
LCD Display	7
Basic Operation.....	10
Power on/off.....	10
Turn Volume.....	10
Choose Channel	10
Call.....	11
Function Menu Operation	12
Auto Power Off(APO)	12
APRO (APRO).....	12
Busy Channel Lock (BC Lock)	12

Key Beep (Beep)	13
Channel Save (CHASave)	13
DTMF Function	13
Dual Waiting (DW)	17
Decode Type and Decode Code	17
CTCSS/DCS Encoding Function: EncType and EncCode	19
FM Function (FM)	20
Font size Choose (Font)	22
Key Lock Function (Keylock)	22
Keypad Function (Keypad)	23
Backlight (Lamp)	23
Alias Set Function (Name)	24
Open Display Set (OpenDIS)	25
Custom Keys Set (P1-P3、M Key)	25
High/Low Power Set (LOW)	26
PTT ID (PTT ID)	27
ROGER (ROGER)	28
REVERSE (REVERSE)	28
Beat Frequency (RPT SET/RPT TYPE)	29
Save Battery (SaveBat)	30
Scan (SCAN)	31

Squelch Level (SQL)	33
Step (Step)	33
Tail Elimination (Tail)	34
Talk Around (Talk)	34
Time out timer (TOT)	34
TX Stop (TXStop)	35
VOX (VOX)	35
Wide and Narrow Band Set (WidNar)	36
User-defined Keys Menu	36
Close (OFF)	37
FM (FM)	37
Channel UP (UP)	37
Channel Down (DOWN)	38
Monitor Momentary (MONI)	38
Monitor Lock (MOLO)	38
SQ OFF Momentary (SQM)	39
Mute (MUTE)	39
Scan (SCAN)	39
High/Low Power (LOW)	39
Emergency (EMG)	39
V/M Mode Switch (V/M)	40
DTMF Function (DTMF)	40

Call (Call)	40
Transmit 1750Hz (1750Hz)	40
A/B Mode Switch (A/B)	41
Talk Around (Talk)	41
Reverse Frequency (Reverse)	41
Reset Menu.....	41
All Reset.....	41
Function Reset.....	42
Programming Operation.....	43
Lease Function	43
Wireless Change Frequency	43
RX Inhibit/RXTX Inhibit	45
Times of TX per Minutes Set	47
Maintenance	47
Base Knowledge.....	47
Maintain and Clean	47
Specification.....	49

Security Information

To using the radio safety and efficient, Please read the following safety information.

The machine repair work carried out only by a professional technician, don't take apart the radio yourself.

To avoid electromagnetic interference and electromagnetic compatibility problems, please turn off the radio in the posted "turn off radio" mark, such as hospitals and other health care sites. Turn off the radio according the order of the crew when you are by air.

Do not place the radio in the range of the air bag spread.

Please turn off the radio in a flammable, explosive atmosphere.

Do not use the radio with a damage antenna, it might be burn you.

When using this radio, Please make sure the antenna is connected, or it might make power tube of the radio burned.

Please keep at least a distance of 5cm away from body when you press the PTT.

Turn off the power immediately if the radio emits unusual smells or smoke, and contact the nearest authorized dealer.

Accessories & Options

Welcome to use  **EIXEN** mobile transceiver, please check the packaging, make sure the following table accessories are complete, if you find any loss or damage with the packing, please contact your dealer immediately.

Supplied Accessories

Item	Qty
Mobile transceiver	1
DC Power Cable	1
Bracket	1
Bracket Screw (Lock in two side of the radio)	2
User Manual	1

Optional Accessories

USB Programming Cable	DC/AC Adaptor
DTMF Keypad Microphone	No Keypad Microphone
Antenna Sucker	Antenna

Installation

Connect Power

This radio should be connected to 12V DC power supply. It can not be connected directly to AC outlet. Connect the radio to stabilized power supply with supplied power cable, DC power cable can not be replaced with a thin wire.

Connect DC power cable to DC power supply, red wire connects positive, black wire connects negative. Then plug the jack of the power cable into DC power outlet of car.

Note: Make sure to turn off DC power supply and radio before connect. DC power supply is connected to the vehicle platform, be sure to turn off DC power supply and drive units.

The DC power can only be connected to AC power outlet after all connections are completed.

Radiating of Radio

Heat radiation of mobile transceiver is a very important problem. Heat radiation of this radio takes advantage of the air by using a bracket to install. If the radio installed in an airtight place, it will affect the

radio cooling. Poor cooling may cause damage to the radio. Do not place books or other equipment on the radio, so as not to obstruct the air flow. The distance between the radio and the wall of car maintain a minimum interval of 10 cm space.

Install with Bracket

An adjustable angle bracket is supplied with the radio. Please fix the bracket on car, demount the two screws beside the radio and lock them again through the hole of bracket.

Note: Do not place the transceiver in the range of an airbag deployment may be involved

Do not place the radio in the front windshield of car, the heat of sun may cause damage to the radio.

Connect Accessories

Hand Microphone: Hand microphone connection jack is located in the top right of the front panel of radio.

Earphone: Earphone connection jack is located in the right of the rear panel of radio. The internal speaker will not sound when earphone is connected.

Antenna: Antenna connection is in the left of the rear panel intercom. Antenna system is composed of an antenna, feeder and ground network components.

Only careful consideration of the antenna system and its installation, can make good use of mobile transceiver. The antenna should be the selection of quality to ensure good communication results. Don't transmit without connecting antenna, transmitting without connecting antenna, may cause damage to radio.

Familiarize with the radio

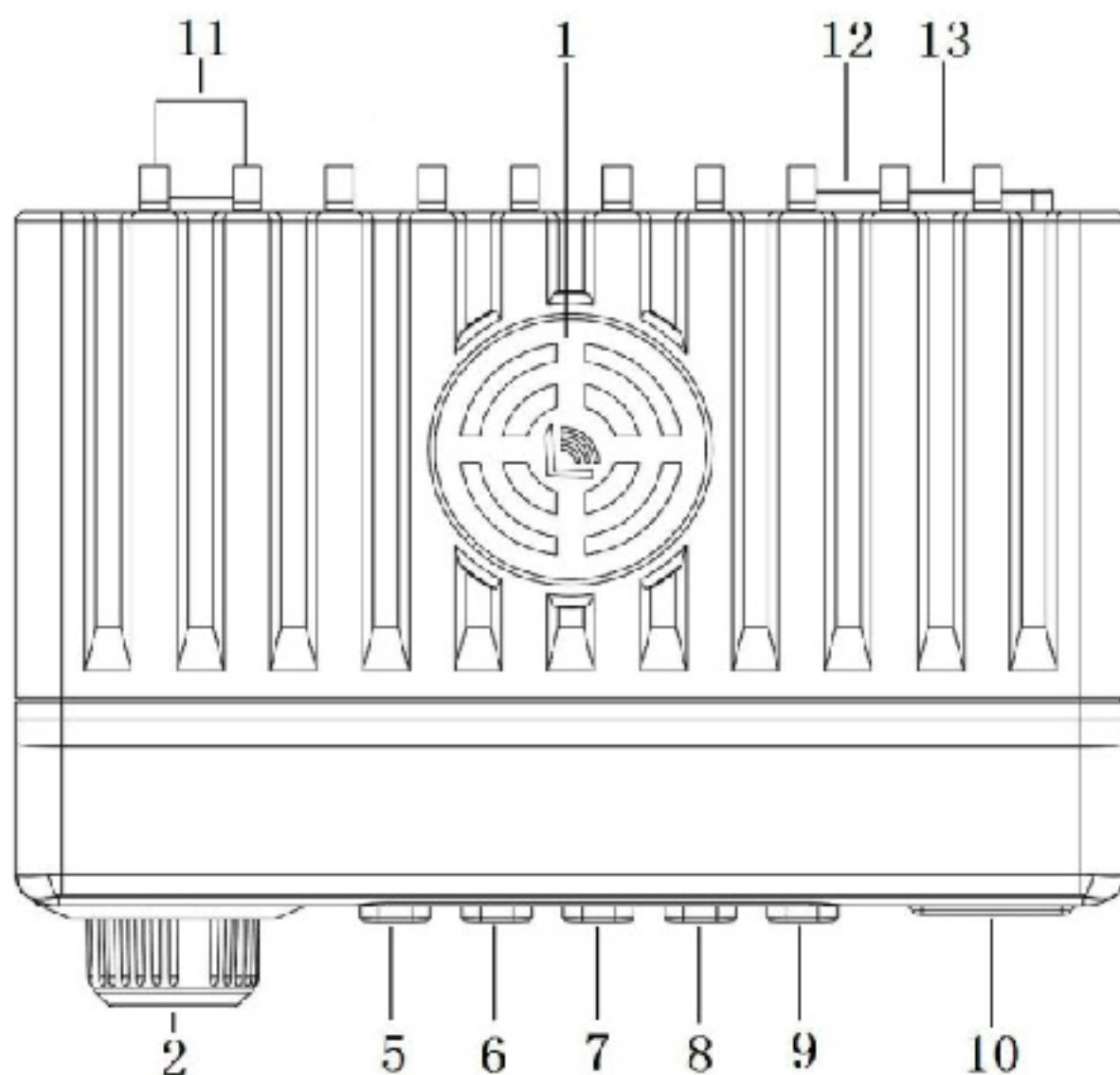

VV-808 Upper Panel

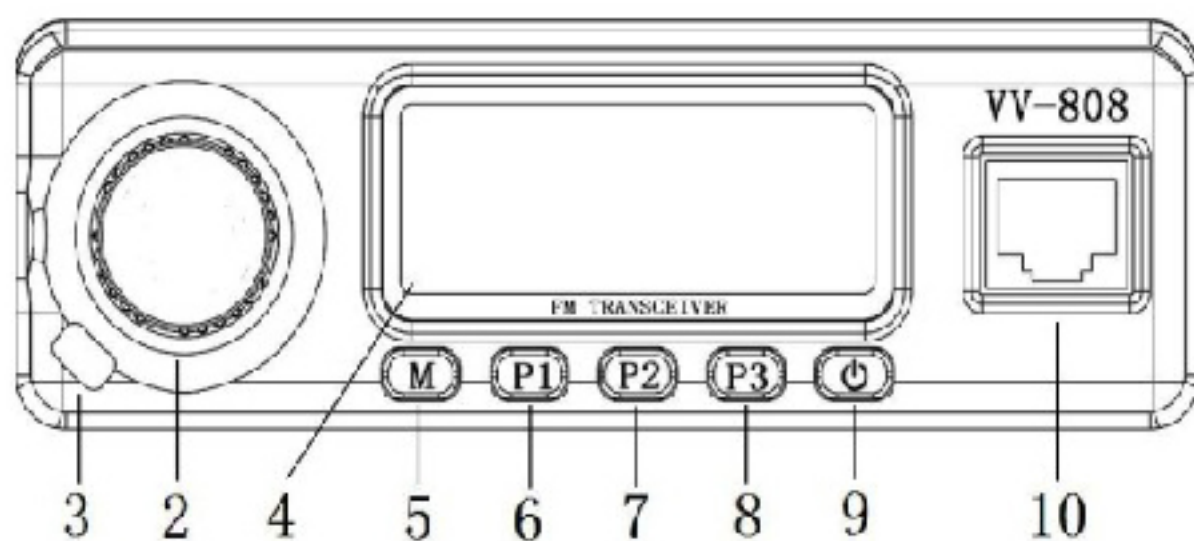

VV-808 Front Panel

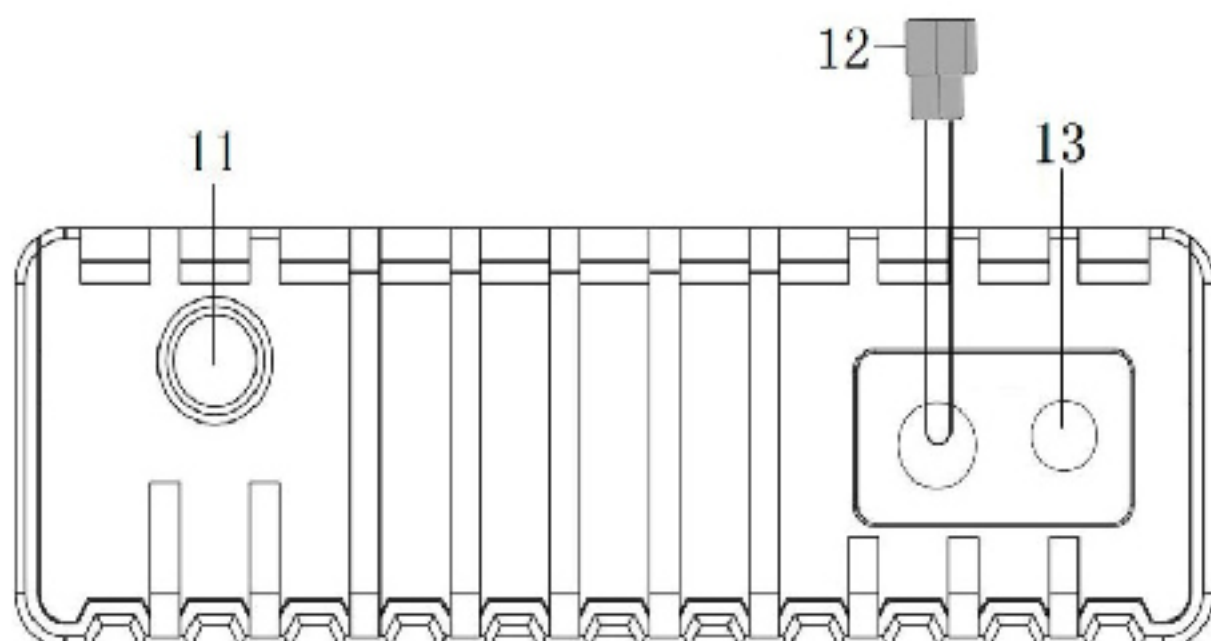





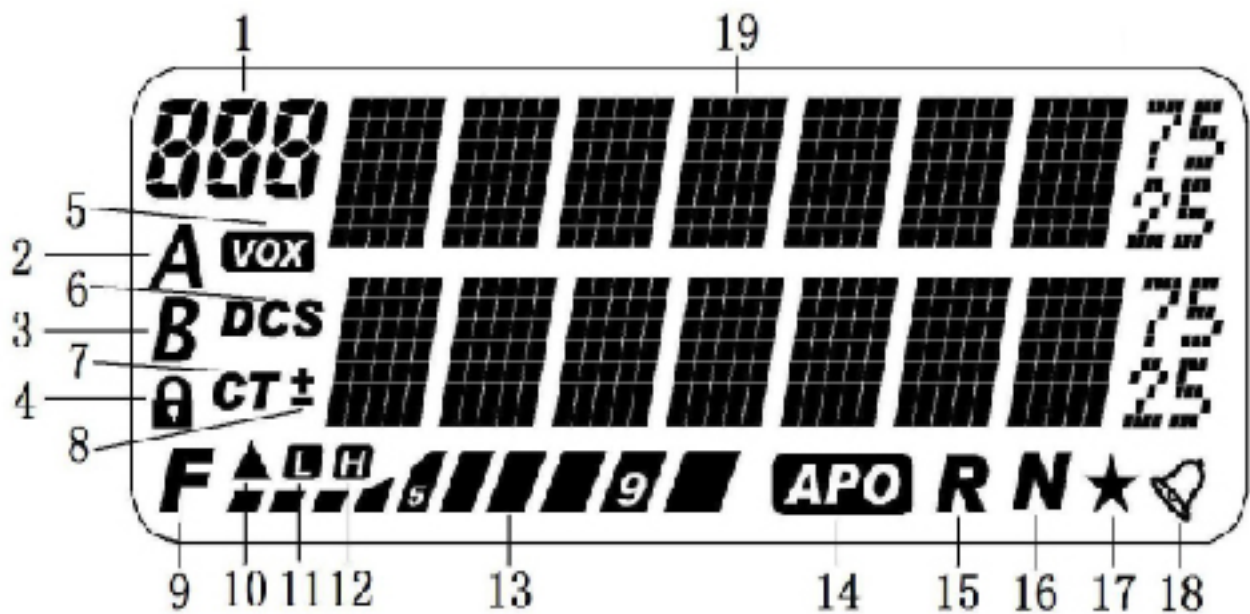

VV-808 Rear Panel

1,Loudspeaker	2,Dial Knob
3,Indicator Light (Red light、green light)	4,LCD display screen
5,Menu Key	6,P1 Key (User defined)
7,P2 Key (User defined)	8,P3 Key (User defined)
9, Power Switch	10,MIC Connector (RJ45)
11,Antenna Connector	12,Power Connector
13,Earphone Connector	

LCD Display





No	Icon	Feature Description	Operation Method
1		Memory Channel No.	----
2		Being A Channel	Switch A/B Key
3		Being B Channel	Switch A/B Key
4		Keyboard Lockout	Press M Key for 2 Seconds
5		VOX Open	Menu 45
6		DCS Open	In VFO/MR mode: Decode Type and Decode Code refer to Menu08 and 09, Encoded Type and Encoded Code refer to Menu 10 and 11
7		CT Open	The same as above (DCS)
8		Beat Frequency	Refer to Menu 34 and 35
		Wireless Frequency Open	Refer to Menu 40
10		Channel scan disabled	Refer to Menu 39
11		Low Power	Refer to Menu 30
12		High Power	Refer to Menu 30

13		Indicate Power strength when transmitting, 10 grids for high power, 5 grids for small power. Indicate signal strength when receiving.	----
14		Auto Power off	Refer to Menu 01
15		Reverse Frequency	Refer to Menu 33
16		Narrowband	Refer to Menu 50
17		Dual Reception	Refer to Menu 07
18		DTMF	Refer to Menu 06
19		Displayed frequency value, channel names, menu items, and other numbers, letters or symbols Information	----

Basic Operation

Power on/off

Connect the power and press the  button, the radio turned on, issued a "toot toot" tone. Press the  key for 2 seconds, the radio turned off.

Turn Volume

When the radio is in memory channel mode (A or B on the screen display), press  button or press the D key on DTMF microphone to enter the VOL adjustment mode (A or B on the display disappears), rotating the knob to adjust the volume, clockwise to increase volume, counterclockwise to decrease volume. Or press the UP or # key on DTMF microphone to increase volume, DN or * key to decrease volume.

The volume level range: 0-15. Default: 4.

Choose Channel

How to choose a channel? As following:

- 1, Store your favorite channels through programming software as Memory Channels in advance, you can select the channel you want to communicate in the MR mode directly.

-
- 2, Input the frequency value by using the DTMF keypad in the VFO mode.
 - 3, Rotate the knob to set the frequency in the VFO mode.

Note: This radio has a dual-waiting function, you can switch A/B channel by key C (A/B switch key) on the DTMF microphone. A-channel can only be in the MR/CH memory channel, B-channel can be in VFO frequency channel or the MR/CH memory channel. Please refer to page 36 of the user-defined key function of A/B switch and VFO/MR switch.

Call

Press and hold the PTT key of the microphone and speak to start a call. Release the PTT key to end the call.

- Please use Low Power to communicate if the communication distance is nearby, in order to reduce radiation and save electricity.
- Keep the microphone about 5 cm from mouth, with the usual volume to speak, to get the best sound quality.
- The indicator shows red when transmitting.

Function Menu Operation

Auto Power Off(APO)

Auto power off means that when the radio reaches the pre-set time on standby state (without any operation), APO would turn the radio off automatically. You can set the APO time by Menu 01. Time can be set to OFF(disable) / 10 minutes / 20 minutes / 30 minutes / 40 minutes / 50 minutes / 60 minutes / 90 minutes / 2 hours / 4 hours / 6 hours / 8 hours / 10 hours / 12 hours / 14 hours / 16 hours. The radio would display a **APO** icon when APO function is open. Default is OFF(disable).

APRO (APRO)

Voice processing features include: Disabled, voice compressor or and scrambler. Each channel can be set individually. You can set voice processing mode by Menu 02: Disabled (OFF), voice compressor (Comp), and voice scrambler (Scra). Default is OFF.

Busy Channel Lock (BC Lock)

When a Channel set the “BC LOCK” function, TX would be inhibited when this channel receiving a signal. You can set menu 03 to open(ON) or

lock(OFF) this function. Default is ON.

Key Beep (Beep)

Whether open key beep or not when there is a key operation. You can set menu 04 to open(ON) or lock(OFF) key beep. Default is ON.

Channel Save (CHASave)

Users can save custom frequency as memory channel, so that save time to re-set the frequency parameters. In VFO mode, enter the frequency you want to save, press the M key and rotating knob to menu 05 "CHASAVE", rotating again to select the channel number you want to keep after the screen displayed "CHASave TO 001", then the frequency is saved.

Note: You can save up to 199 channels, Default save the channel to number 001, choose a right channel number when save a new channel in order to avoid the previously saved channels are replaced.

DTMF Function

DTMF (Dual Tone Multi Frequency), dual tone multi-frequency, **consists of** high-frequency group and low frequency group, each group contains four frequencies. A high frequency signal and a low frequency signal superimposed to form a combined signal which representing a number. DTMF signaling

has 16 codes, can be set freely. When a radio channel setting of the DTMF enabled, you can send DTMF codes by wireless control to achieve individual call, group call or RX Inhibition, RXTX Inhibition and other functions.

✧ **Open/Close DTMF function**

1, In VFO / MR mode, choose or enter a frequency or MR channel which is with DTMF function open. Or put the DTMF function "ON" in channel information through program software.

Note:

a), If the radio is in CH mode, you can not change the DTMF function "ON" or "OFF". You can only change it by program software.

b), In MR mode, each memory channel can be set individually whether open DTMF function or not.

2, Press the M key and rotating to menu 06, open or close DTMF function. "ON" is open, "OFF" is close.

✧ **Individual call/ group call**

Individual call: Set the radio ID first: An ID is composed by the 15 digit DTMF code. Select any one of the following symbols: 0,1,2,3,4,5,6,7,8,9, A, B, C, D, *, # (default Individual call ID: 1000)

Group ID: You can use DTMF character "A", "B", "C", "D", "*" or "#" to set up a group call "universal

character." If the radio receives a valid ID code, which one to all digital is replaced by this "universal character" group call code, then the radio will decode. Group call which using Group call code is effect in "Monitor Lock" or selected call. The radio which is called by group call can't do an automatic respond. (Default group is A)

For example: Set 10 radios as follows:

Item	Individual ID	Unite ID	Group ID.
Radio1	80811	C	Group 1
Radio 2	80812	C	Group 1
Radio 3	80813	C	Group 1
Radio 4	80814	C	Group 1
Radio 5	80815	C	Group 1
Radio 6	80831	C	Group 3
Radio 7	80832	C	Group 3
Radio 8	80833	C	Group 3
Radio 9	80834	C	Group 3
Radio10	80835	C	Group 3

Send the ID code: 80814 to call "Radio 4".

Send the ID code: 80832 to call "Radio 7".

Send the ID code: 8081C to call all radios in Group 1.

Send the ID code: 8083C to call all radios in Group 3
Send the ID code: 808CC to call all radios in Group 1
and Group 3 which are both in Unite C.

❖ **DTMF code transmission mode:**

1, Automatic transmission: Fill in the DTMF call list in the software to make a fast dialed call. In VFO / MR / CH mode, keep DTMF open, press the CALL key (A key) + a serial number of list by microphone and then press PTT to send the DTMF code. (Note: No. 0-9 can be entered or press UP / DOWN keys on microphone directly or rotate knob to select, number 10-15 can only press UP / DOWN button on microphone or rotate knob to select.

2, Manual transmission: If the DTMF list in software is empty, the radio would close CALL function when operate by automatic transmission. You can press CALL key twice, enter the DTMF code and press PTT to transmit when the screen appears "send". It will issue a "toot toot toot toot" sound when individual call is successful, and issue a "jingle ring, jingle ring ring" sound when Group call is successful.

❖ **Remote RX Inhibition/ RXTX Inhibition:**

RX Inhibition: The radio can't transfer any signal when it receives a code match a RX Inhibition codes

until it receives an enable RX codes.

RXTX Inhibition: The radio can't receive or transmit any signal when it receives a code match a RXTX Inhibition codes until it receives an enable RXTX codes.

Refer to page 45 for more about RX Inhibition and RXTX Inhibition of programming function.

Dual Waiting (DW)

The radio whether stands by Dual Waiting or not. Through the menu 07 select Enable (ON) or disable (OFF). Default is ON.

Decode Type and Decode Code

Users can set up the decoding type through menu 08 "DecType" to select squelch mode.

OFF: Disable. Any the same frequency signals can be received.

CTCSS: Only receives the signal with matched CTCSS decode. 56-254.1Hz (58 groups).

NDCS: Only receives the signal with matched NDCS decoded. 107 groups.

IDCS: Only receives the signal with matched IDCS decoded. 107 groups.

Choose Decoding Code as following two tables through Menu 09 after select the Decode type by

Menu 08.

CTCSS: 56-254.1 Hz (58 groups), NDCS: 107 groups
Normal DCS code. IDCS: 107 groups Invert DCS
code.

CTCSS standard frequency table (58 groups)

56.0	74.4	107.2	156.7	189.9	241.8
57.0	77.0	110.9	159.8	192.8	250.3
58.0	79.7	114.8	162.2	196.6	254.1
59.0	82.5	118.8	165.5	199.5	
60.0	85.4	123.0	167.9	203.5	
61.0	88.5	127.3	171.3	206.5	
62.0	91.5	131.8	173.8	210.7	
63.0	94.8	136.5	177.3	218.1	
67.0	97.4	141.3	179.9	225.7	
69.3	100.0	146.2	183.5	229.1	
71.9	103.5	151.4	186.2	233.6	

DCS Standard Code Table

017	053	125	172	251	315	411	462	565	703
023	054	131	174	252	325	412	464	606	712
025	065	132	205	255	331	413	465	612	723
026	071	134	212	261	332	423	466	624	731
031	072	143	223	263	343	431	503	627	732
032	073	145	225	265	346	432	506	631	734
036	074	152	226	266	351	445	516	632	743
043	114	155	243	271	356	446	523	645	754
047	115	156	244	274	364	452	526	654	
050	116	162	245	306	365	454	532	662	
051	122	165	246	311	371	455	546	664	

CTCSS/DCS Encoding Function: EncType and EncCode

Users can set up the encoding type and encoding code through Menu 10 “EncType” and Menu 11 “Enc code” match to DecType and DecCode to open squelch.

OFF: Disable. The transmitted signal does not with Encoding function.

CTCSS: The squelch can only be open when the transmitted signal set a CTCSS code which match to the Decoding code of the receiver.

NDCS: The squelch can only be open when the transmitted signal set a NDCS code which match to the Decoding code of the receiver.

IDCS: The squelch can only be open when the transmitted signal set a IDCS code which match to the Decoding code of the receiver.

FM Function (FM)

This radio has a FM function. Users can turn on the radio to listen to FM programs in leisure time. FM frequency range: 87.5-108MHz.

Open/Close FM Function

- ✧ In VFO / MR / CH mode, press M key rotating knob to Menu 12, then press M key to turn on the radio. To turn off perform the same operation.
- ✧ You can set P1-P3 as the shortcut key for FM radio function, pressing the shortcut key on or off the radio in the VFO / MR / CH mode.

Rotating knob to select or enter by microphone keyboard to input FM frequency directly, or store your favorite radio programs frequency in the software in

advance, that you can quick select your favorite radio programs. Frequency range: 87.5-108MHz.

Note: Please install the antenna, in order to ensure good reception when listen to the Fm radio.

FM Dual Waiting (FM DW):

FM DW means FM double waiting. You can set the radio whether to allow accept a signal or not when you are listening the FM programs by Fm DW function. The radio will allow a signal to access when there is a signal decoded successfully or a PTT operation done when the FM DW is ON. And it would not allow when the FM DW is OFF. The FM will work again when the signal disappear.

You can press M key and rotating knob to Menu 13, and press M key again to enter the FM DW function. You can choose ON or OFF the FM DW. Default is ON.

FM Scan (FM Scan):

In the FM mode, users can define that the FM frequency is increase or decrease by step (OFF) or by scanning channels with signals (ON). You can choose ON or OFF in Menu 14. ON: The Fm Scan function enabled, the radio just scan channels with signals, FM Scan opened can improve the scanning speed; OFF:

Turn off the FM scan. Default is ON.

FM SQL (FM SQL):

Users can set FM scan levels to improve FM radio channel scanned clarity. Enter to Menu 15, press M key and rotating knob to the appropriate level, press M key to confirm and exit. 0-9 level; when the level is 0, squelch opens automatically. The high level set, the high radio signal clarity scanned. Default level: 5.

Font size Choose (Font)

User can set the font size of the two channels on the screen through Menu 16. Selected as BIG font, the two channels font display are large font; selected as SMAL font, The font of the current channel is big, the other one is small. Default: SMAL font.

Note: The fonts can only displayed in big font when the channel Alias set.

Key Lock Function (Keylock)

User can keep keypad lock through Menu 17. Press M key and hold for a second,  appears on the display, then keypad lock is enabled, the selected keypad is locked. Redo the operation to unlock. Default is not locked.

Locking range is optional in the Menu 17. Keypad lock range:

KEY: Numeric and function keys, keys on the microphone and the front panel of radio. (M and  key except)

K + S: KEY + DAIL. Numeric +function keys + knob. (M and  key except)

PTT: PTT Key.

ALL: KEY + DAIL + PTT (M key and  key except)

Default is: K + S.

Keypad Function (Keypad)

Set through Menu 18 based on the optional microphone with keyboard or without keyboard: With keyboard to select "ON", without keyboard, select "OFF". The keypad should be set "ON" if it is a keyboard microphone used, otherwise keys on microphone are not available except PTT. If it is a microphone without keyboard, it is recommended to set "OFF", in order to reduce the workload of radio. Default is ON.

Backlight (Lamp)

You can set backlight through Menu 19. There are three modes:

OFF: Backlight always closed.

Key: When there is a key operation, background lights. Otherwise it is closed.

CONT: Backlight always lights.

Default: CONT.

Alias Set Function (Name)

User can set the radio whether display the Alias function or not through Menu 21. ON is enable, OFF is disable. Default: OFF.

Channel Alias: User can set the current channel whether display the Alias function or not through Menu 21. ON is enable, OFF is disable. Default: OFF. Channel alias can help you identify the channel easily. You can edit alias of channel through Menu 22. An alias has seven digits or characters. Default Alias: Name ***.

Edit Alias valid characters:

A	B	C	D	E	F	G	H	I	J	K	L
M	N	O	P	Q	R	S	T	U	V	W	X
Y	Z	[¥]	^	-	`	a	b	c	d
e	f	g	h	i	j	k	l	m	n	o	p
q	r	s	t	u	v	w	x	y	z	{	
}	→	←	space	!	"	#	\$	%	&	'	(
)	*	+	,	-	.	/	0	1	2	3	4
5	6	7	8	9	:	;	<	=	>	?	@

Open Display Set (OpenDIS)

User can set the display words when the radio opened through Menu 23. Default is: User.

ALL: Boot displayed as full screen display.

SYS: Boot displayed as system welcome word.

User: Boot display as User-defined word.

User can set user-defined word through programming software.

Time: Boot display as remaining lease time.

Custom Keys Set (P1-P3、M Key)

Users can set P1, P2, P3, M key on the front panel of the radio as shortcut keys through Menu 24-29 to reduce tedious operation. Every key have two defined shortcut: press and release key at once (Called short press), press and hold more than 1.5 seconds (Called long press. The time is settable through programming software.) Please refer to Page 36 for the detail operation of the shortcut keys menu.

P1 Long Press: Long press P1 to enable the shortcut key.

P1 Short Press: Short press P1 to enable the shortcut key.

P2 Long Press: Long press P2 to enable the shortcut key.

P2 short Press: Short press P2 to enable the shortcut

key..

P3 Long Press: Long press P3 to enable the shortcut key.

P3 short Press: Short press P3 to enable the shortcut key.

M Short Press: Short press M to enable the shortcut key.

Note: M Shortcut can only be set through software. You can define the shortcut function directly through software. Default of M short press is to enter the Menu.

Default of shortcut keys:

P1 Long Press: FM (FM radio)

P1 Short Press: A / B (A / B mode switch)

P2 Long Press: MOLO (Monitor Lock)

P2 Short Press: LOW (High/Low power switch)

P3 Long Press: SCAN (scan)

P3 short Press: MUTE (mute)

M Short Press: Enter the menu function

High/Low Power Set (LOW)

User can choose High power or Low power for the communication according to the distance through Menu 30. Please choose Low power when the communication is nearby to reduce radiation and save electricity. Choose High Power when the

communication is far away to ensure the communication quality. Default: High power.

PTT ID (PTT ID)

When PTT ID opened, the recipients can be informed caller's ID via PTT ID displayed. If the caller does not want to make the recipients be informed of caller's identity, you can write through software "Display PTT ID" option tick removed, then PTT ID code is not displayed.

ON / OFF PTT ID function:

ON / OFF PTT ID function in two ways:

- 1, In VFO / MR mode, Choose the frequency or channel which need to open PTT ID function, press M and rotating knob to menu 31 to enter the PTT ID menu, select ON to open or OFF to close.

Note:

- a), In CH mode, can not switch on / off PTT ID function.
 - b), In MR mode, each memory channel can be set individually on / off PTT ID function.
- 2, Write the channel in the programming software directly whether to enable PTT ID function.

PTT ID sent by:

- 1, Set by transmitter starts, ID code is emitted when

press PTT button.

- 2, Set by transmitter end, ID code is emitted when release PTT button.
- 3, Set by both in transmitter starts or end, ID code is emitted when press and release PTT button.

Default PTT ID is: 123

PTT ID code setting:

The radio set up a PTT ID code memory, user can store PTT ID code in “the begin of TX” and “the end of TX” in programming software. This allows you to transmit PTT ID by press PTT key directly without having to press PTT ID code.

ROGER (ROGER)

User can set whether send ROGER or not when call is over. User can switch “ON” and “OFF” through Menu 32 to enable or disable ROGER. The radio would transmit a “toot toot” tone when a call is over if ROGER is enable (ON).

REVERSE (REVERSE)

User can only enable REVERSE after enable Beat Frequency (RPT SET/RPT TYPE) through Menu 34,

35. The receive frequency and the transmit frequency will be switched if Reverse enable. In VFO / MR / CH mode, press M key rotate to Menu 33, press M key to enter reverse setting, rotate knob to select ON(enable) / OFF(disable). Reverse function is enabled and a "**R**" Symbol appears on screen. Default: OFF.

Beat Frequency (RPT SET/RPT TYPE)

A channel set two frequencies is a way to using two frequencies at the same time. The receiving and transmitting frequencies are not the same. It becomes easy to operate inconsistent uplink and downlink frequencies by setting RPT frequency.

Setting mode: In VFO mode, press M key and rotating knob to menu 34, press M key again to enter beat frequency setting menu, enter value by DTMF microphone or rotating knob to choose value. The frequency value increase or decrease by

step when rotating knob. The range of value: 00.000–69.995MHz.

Enter menu 35 to set RPT Type, rotate knob to select +RPT/-RPT/SING, press M key to confirm and exit.

For example: In VFO mode, enter a frequency as 450MHz, set value of beat frequency 5MHz in RPT SET, if RPT Type is + RPT, then receiving frequency is 450MHz, and transmitting frequency is 455MHz; if RPT Type is -RPT, then receiving frequency is 450MHz, and transmitting frequency is 445MHz; if RPT Type is SING, receiving frequency and transmitting frequency both are 450MHz.

Note: Beat frequency setting is only available in VFO mode setting; in MR mode, beat frequency can only set through program software by write the receiving and transmitting frequencies directly.

Save Battery (SaveBat)

Set by Menu 36 to enable (ON) or disable (OFF)

battery saving mode. Default: ON.

Scan (SCAN)

Enable scanning feature can monitor desired channel frequency without manual operation. In familiar with the use of scanning, flexibility of obtained monitor will increase efficiency.

Scan Mode: Before using scan function, you should choose which scan mode to scan first through Menu 38. There are two modes optional:

- ✧ Time operating scan mode (TO): Scanning stops when a signal scanned, the radio keep receiving to the channel about 5 seconds, then it skip the channel, the scanning continues even if signal is still present.
- ✧ Carrier operating scan mode (CO): Scanning stops when a signal scanned, the radio keeps receiving to the channel until signal disappears, then scanning continues. There are 2 seconds delayed between signal disappears and scanning continues, so that the transfer station has time to transfer.

Default mode: TO

Note: Press any key except UP or DOWN key or rotating the knob, the radio stops scanning.

Scan range: Users can choose two scanning range:

- ✧ VFO frequency scan: All frequencies on the band would be scanned.

In VFO mode, enter Menu 37 and press M key to start scanning, the radio automatically scan from current frequency to higher frequencies in wide band. To scan direction toward low frequencies, press DOWN key or turn knob counterclockwise, then scan direction reversed. To re-scan to higher frequencies direction, just press UP key or turn knob clockwise. Press any key except UP or DOWN key or rotating knob, the radio stops scanning.

- ✧ MR / CH Frequency scan: Only scan frequencies which stored in memory channel.

In MR / CH mode, enter Menu 37 and press M key to start scanning, the radio automatically scans from current channel to higher stored number channel in wide band. To scan direction toward lower stored number channel, press DOWN key or turn knob counterclockwise, then scan direction reversed. To re-scan to higher channel direction, just press UP key or turn knob clockwise. Press any key except UP or DOWN key or rotating knob, the radio stops scanning.

Note:

1. Each memory channel can be set whether to

allow scanning add or not. If set to prohibit scanning add, then channel is not involved scanning. User can set scan add function through Menu 39. The screen would displays ▲ when current channel set scan add disable.

2. The MR/CH frequency scan can only set when there are more than 2 channels and both are allowed scan add.
3. Scan can only do when squelch closed.

Squelch Level (SQL)

The purpose of squelch is to make background noise of speaker silence when there is no signal (squelch circuit closed). User can only receive signals which he wants to if he sets an appropriate squelch level. Setting a higher squelch level, it can only receive a stronger signal. User should choose appropriate squelch level according to the ambient RF noise. Press M key and rotating knob to Menu 40, press M key again and choose appropriate squelch level. Press M button to confirm exit, then SQL have been set. Default: 2.

Step (Step)

Step is the value which frequency increases or

decreases when rotating knob or press UP / DOWN key in VFO mode. Step is set through Menu 41. The range: 2.5/5/6.25/10/12.5/25KHz. Default: 25 KHz.

Tail Elimination (Tail)

If Tail enabled, the "Cha Cha" sound ending of every call will be eliminated. Access menu 42, press M key and rotating knob to select ON / OFF to enable or disable tail elimination function. Press M key to confirm exit. Default: on.

Talk Around (Talk)

Enable talk around function, transmitting and receiving frequencies become the same; transmit and receive signaling also turn into the same signaling. Users can access menu 43 to select Open (ON) or close (OFF). Default: OFF.

Time out timer (TOT)

Users can set the maximum time which the radio is allowed to continuous transmitting. The radio would beep "toot" tone to warning and stop transmitting. Transmitting symbol would not be showed on screen. Enable TOT function would prevents the radio from damage by uncertainty transmit. Access Menu 44, press M key and rotating knob to select TOT time, and

then press M key to confirm and exit. Range: OFF(disabled)/10/20/30...120 (step 10 seconds). Default: 30 seconds.

TX Stop (TXStop)

Users can set to inhibit the radio transmitting. The radio can only receiving signal but can't transmitting signal when TX Stop enable. When TX stop enable, the radio would beep "toot" warning tone and won't do transmitting when PTT key is pressed. And the screen display "TX Stop". Access Menu 45, press M key and rotating to select enable (ON) or disable (OFF). Press M key again to confirm and exit. Default: off.

VOX (VOX)

Enable VOX function, you can do transmitting without pressing PTT key, transmission can be carried out when you speak and end when the speaking is over. Access Menu 46, select VOX enable (ON) or disable (OFF). **VOX** would be displayed on screen when VOX function is enabled. Default: OFF.

VOX S(Sensitivity): VOX sensitivity is an analog reference level used to set internal VOX threshold of the CPU in the radio. Considering the different speak

volume and tone of every person, user should test to get a best sensitivity level according to his own voice. User can select VOX sensitivity through Menu 47. Range: 1 - 8 (step: 1). Default: 3.

VOX D(Delay) : The radio recovers reception mode too fast that the last voice of VOX might not be transferred. User can set VOX Delay through Menu 48 to avoid this problem. Range: 1-4 seconds (step: 1). Default: 3 sec.

VXB (VOX inhibited when receiving) : Access Menu 49, user can set VXB enable (ON) or disable (OFF). Default: Enable.

Wide and Narrow Band Set (WidNar)

Users can set bandwidth of radio as Wide band or Narrow band according to different countries or regions. Access Menu 50 and select Wide or Narrow. Default: Wide.

User-defined Keys Menu

As mentioned above, users can set P1, P2, P3, M keys on the front panel of the radio as shortcut keys

through Menu 24-29 or program software to reduce tedious operation. M Short Shortcuts can only be set by program software.

Every key have two defined shortcut: press and release key at once (Called short press), press and hold more than 1.5 seconds (Called long press. The time is settable through programming software.)

Optional shortcut functions as follows:

Close (OFF)

When a shortcut key disable, it is not useful unless wireless change frequency enable. Please refer to page 43 for more about “Change-frequency wireless” function.

FM (FM)

When a shortcut key programmed as FM function, FM would be enable or disable when press the shortcut key.

Channel UP (UP)

When a shortcut key programmed as Channel UP, channel would be plus one more when press the shortcut key.

Note: Channel UP can only set as short press.

Channel Down (DOWN)

When a shortcut key programmed as Channel DOWN, channel would be decreased one more when press the shortcut key.

Note: Channel DOWN can only set as short press.

Monitor Momentary (MONI)

MONI is a way to accept a weak signal through press and hold a shortcut key forced to receiving the signal. Press and hold the shortcut key, squelch open, green indicator light, the radio issued a "Cha Cha Cha" sound. Release the key and squelch closed, the green light is off.

Note: MONI can only be set as Long press.

Monitor Lock (MOLO)

When a shortcut key programmed as MOLO, the radio would force to close weak signal to avoid interference.

Press the shortcut key and release at once, squelch open, green indicator light, the radio issue a "Cha Cha Cha" sound. Press the shortcut key again, squelch ends. If you do not manually close squelch, squelch off automatically 10 seconds later.

SQ OFF Momentary (SQM)

When a shortcut key programmed as SQM, the radio would forced to close CTCSS/DCS to monitor signals. Press the shortcut key and release at once, the radio issue "toot toot" sound, monitor enabled, press the key again, the radio issue a "toot" sound, monitor is off.

Note: SQM can only be set as Long press.

Mute (MUTE)

When a shortcut key programmed as Mute, mute would be enable or disable when press the shortcut key. Speaker sound off when the shortcut key pressed, and recovers sound until the key pressed again.

Scan (SCAN)

When a shortcut key programmed as scan function, the radio start or end to scan when press the key.

High/Low Power (LOW)

When a shortcut key programmed as LOW, the radio would switch high and low power when press the key.

Emergency (EMG)

When a shortcut key programmed as EMG, the radio

would start emergency. When emergency starts, the radio issues a sound of emergency, the screen displays “TX Stop”, and indicator lights alternate red and green. The above performances disappear until PTT key pressed or the radio power off.

V/M Mode Switch (V/M)

When a shortcut key programmed as V/M, channel B of radio would switch between VFO mode and MR mode when press the key.

DTMF Function (DTMF)

When a shortcut key programmed as DTMF, the radio would switch DTMF function on or off when press the key.

Call (Call)

When a shortcut key programmed as Call, the radio would switch Call function on or off when press the key.

Transmit 1750Hz (1750Hz)

When a shortcut key programmed as 1750Hz, the radio would transmit a 1750Hz signal automatically when press the key.

A/B Mode Switch (A/B)

When a shortcut key programmed as A/B, the current channel would switch between channel A and channel B when press the key.

Talk Around (Talk)

When a shortcut key programmed as Talk, the radio would switch Talk function on or off when press the key.

Reverse Frequency (Reverse)

When a shortcut key programmed as Reverse, the radio would switch reverse function on or off when press the key.

Reset Menu

All Reset

All reset would reset function and memory channel of the radio to factory default. (Note: All would be reset except DTMF list.)

Operate method: Press power key and release at once, press M key for 2 seconds when welcome words

display on screen, then screen shows "Menu 0/ALL RES". After press M key screen shows "RESET?", press M key again to confirm, the radio shows "WAITING" and then restart, that means the radio has been All reset successful. You can cancel All reset by press any key when screen shows "RESET?".

Function Reset

Function Reset would reset function of the radio to factory default. (Note: All would be reset except memory channel and DTMF list.)

Operate method: Press power key and release at once, press M key for 2 seconds when welcome words display on screen, then screen shows " Menu 0/ALL RES", rotating knob or pressing Up/Down key of microphone to go to "Menu 1/FUN RES". After press M key screen shows "RESET?", press M key again to confirm, the radio shows "WAITING" and then restart, that means the radio has been Function reset successful. You can cancel Function reset by press any key when screen shows "RESET?".

Programming Operation

Lease Function

Lease function is used to define the use time of radio. The radio would suddenly stop working when lease time out. The indicator flashing red sustained, user can do nothing except turn the radio off. The radio can just restart through programming by software. Lease function can only set by program software.

Remaining time: User can set whether to indicate remaining of lease time or not. If the optional is checked, and open display set as lease time, remaining time would be displayed on screen when the radio opened.

Lease Time: User can set radio's lease time through program software. Range: 1 minute -255 days 24 hours 59 minutes.

Wireless Change Frequency

Wireless change frequency is used to programming channels of radios which are using by wireless, which make user apart from troubles to recall radios in use. This function can only set through program software.

Example: A team bought 10 radios, one of them used by administrator, the others installed in nine cars for

use. Administrator wants to create a new channel for communicate, he can wireless change frequency without recall radios in use, or program one by one.

Refer to details as following:

1, Administrator should enable “Wireless change frequency” function of the ten radios, and set a 1-15 digit activation code in advance (Range: 0-9, AD, * or #).

2, Program one of P1, P2, P3 or M shortcut key as “OFF”, so that the shortcut is available to use when “Wireless change frequency” been set.

3, The radio which used by administrator should be programmed as “master” radio, and fitted a DTMF microphone.

4, Administrator stores frequency which wants to be used in the 1-199 channel list of “master” radio.

5, When everything ready, user can wireless change frequency manually or automatically:

a), Manually change frequency: Transfer a signal to notify the other 9 radios ready to changing frequency. The receiver presses the shortcut key of “OFF” to start “wireless change frequency”, screen appears an icon “**F**”, then administrator changing frequency following point 6. Icon “**F**” would disappear when changing successful, users can switch to the new channel for communication.

b), Automatically changing frequency: Transfer a signal to notify the other 9 radios ready to changing frequency. Administrator sends enable code to start “wireless change frequency”, screen appears an icon “**F**”, then administrator changing frequency following point 6. Icon “**F**” would disappear when changing successful, users can switch to the new channel for communication.

7, Changing operation: Administrator presses “Call” key on DTMF microphone (Key A for the supplied DTMF microphone), screen appears “Send 01”, rotating knob to the channel stored in advance such as “03”, press PTT key to transfer the first code, press “call” key again, screen appears “Send 03”, now then “03” can not be modified, press PTT key to send the second code. If icon “**F**” disappears now that means the operation is successful, other it is unsuccessful. Administrator should redo the operation.

RX Inhibit/RXTX Inhibit

RX Inhibition: The radio can’t transfer any signal when it receives a code match a RX Inhibition codes until it receives an enable RX codes. If a radio is RX inhibit, the radio would not display transmitting symbol when press PTT key, and issue a “toot” tone.

RXTX Inhibition: The radio can’t receive or transmit

any signal when it receives a code match a RXTX Inhibition codes until it receives an enable RXTX codes. If a radio is RXTX inhibit, the radio would display transmitting symbol but can't hear anything when receive a signal, and it would not display transmitting symbol when press PTT key, issue a "toot" tone.

RX inhibit and RXTX inhibit code: Optional 0-15 bit characters. Range: 0-9, A-D, * and #

RX inhibit /RXTX inhibit and activation:

RX inhibit /RXTX inhibit methods:

1, Program the radio without RX inhibit activation /RXTX inhibit activation ticked through software, the radio is RX inhibit /RXTX inhibit. If it is ticked, RX inhibit activated /RXTX inhibit activated.

2, Enter a RX inhibit /RXTX inhibit code in software, and then programming the radio with software. With DTMF function enable, press "Call" key and the code by another radio and press PTT key to transfer it, the radio received the code and issued a "toot" tone, means the radio is RX /RXTX inhibit. Press PTT key and enter RX /RXTX code and "*" key to activate RX /RXTX inhibit.

Note: If "Activation Enable" hasn't been checked, the radio can't be activated through transfer code, it can only be

activated through software.

Times of TX per Minutes Set

Per minute call (times): User can set times of TX per minutes to limiting transfer times to prevent individual user transfer frequently, occupation of channel. Range: 0-255 (0 for no limit times of calls). Default: 0. The radio would issue a “toot” tone to alarm PTT times have reached defined times. The radio would not display transmitting symbol when press PTT key.

Maintenance

Base Knowledge

The radio has been strictly calibrating test in the factory, it meets the target requirements. Non-professional maintenance staff is not allowed to take apart the radio to repair and calibration without authorized, otherwise no warranty.

Maintain and Clean

- 1, Handle with care to the radio, do not carry the radio by power cable or antenna..
- 2, Wipe dust and dirt on the radio regularly with cloth.
- 3, Do not store the radio in too hot or too cold

environment. It would reduce the life of the radio.

4, In long-term use, the keys, knob and body would become dirty, please using neutral detergent and a damp cloth to clean (Do not use strong corrosive chemicals). Using such as alcohol, oil or spray chemical agents may cause damage to the radio shell.



5, Please use supplied or approved antenna. Unauthorized antennas or modifications accessory could damage the radio and violate regulations governing radio devices.

6, Please have your radio repair before necessary data backup.

7, If the radio does not work normally, please send to customer service center or your nearest authorized service location for repair.

Specification

Band	VV-808U:UHF/VV-808V:VHF
Frequency Range	400~470MHz/136~174MHz
Channel Capacity	199
Output Power	4W/10W
Operation Mode	Simplex
Dimension (L*W*H)	120×90×40mm
Weight	275g
Modulation Limitation	$\leq \pm 5\text{KHz}$
Spurious Radiation	60dB
TX Current	1A/1.8A
Frequency Stability	$\pm 2.5\text{PPM}$
Rx Sensitivity	$< 0.18\mu\text{V}$
Modulation Type	F3E
Audio Power	$\geq 400\text{mW}$
Standby Current	78mA(Power Saving mode is 30mA)
Rated Voltage	12V

We strived to write content of the manual accurately and completely, but it might still possible has existence of errors and omissions.  **LEIXEN** company does not assume any responsibility.  **LEIXEN** Company keeps right o change product design and specifications at any time. As technology developing, design and product specifications are subject to change without notice.

Certificate

Examiner: F023