



INSTRUCTION MANUAL

HF MARINE TRANSCEIVER
IC-M710



IMPORTANT

READ THIS INSTRUCTION MANUAL CAREFULLY before attempting to operate the transceiver.

SAVE THIS INSTRUCTION MANUAL—This instruction manual contains important safety and operating instructions for the IC-M710.

PRECAUTIONS

⚠ WARNING! NEVER connect the transceiver directly to an AC outlet. This may pose a fire hazard or result in an electric shock.

⚠ WARNING! NEVER mount the transceiver overhead. The weight of the transceiver is approximately 7.8 kg. (17.4 lb), but its apparent weight will increase several fold due to wave shocks and vibration. The transceiver must be mounted on a flat hard surface only.

NEVER connect a power source of more than 16 V DC, such as a 24 volt battery. This connection will ruin the transceiver.

NEVER place the transceiver where normal operation of the ship or vehicle may be hindered or where it could cause bodily injury.

NEVER allow children to play with equipment containing a radio transmitter.

NEVER expose the transceiver to rain, snow or any liquids.

NEVER install the IC-M710 into a positive-grounding ship. Such a connection might blow fuses, and is not usable.

DO NOT use chemical agents such as benzene or alcohol when cleaning, as they can damage the transceiver's surfaces.

EXPLICIT DEFINITIONS

The explicit definitions described below apply to this instruction manual.

WORD	DEFINITION
⚠ WARNING	Personal injury, fire hazard or electric shock may occur.
CAUTION	Equipment damage may occur.
NOTE	If disregarded, inconvenience only. No risk of personal injury, fire or electric shock.

In maritime mobile operation, **KEEP** the transceiver and microphone as far away as possible (at least 1 m) from the magnetic navigation compass to prevent erroneous indications.

USE an Icom microphone and/or handset only (supplied or optional). Other brands may have different pin assignments and may damage the transceiver.

DO NOT use or place the transceiver in areas with temperatures below -20°C (-4°F) or above $+60^{\circ}\text{C}$ ($+140^{\circ}\text{F}$).

DO NOT connect the transceiver to a power source using reverse polarity. This connection will not only blow fuses but may also damage the transceiver.

DO NOT place the transceiver in excessively dusty environments, or in direct sunlight.

DO NOT place the transceiver against walls, or putting anything on top of the transceiver. This will obstruct heat dissipation.

TABLE OF CONTENTS

IMPORTANT	i
PRECAUTIONS	i
EXPLICIT DEFINITIONS	i
TABLE OF CONTENTS	ii
1 OPERATING RULES AND GUIDELINES	1
2 PANEL DESCRIPTION	2–5
■ Front panel	2
■ Display	5
3 SELECTING A CHANNEL/FREQUENCY	6–8
■ Selecting a channel	6
◇ Using the channel selector.....	6
◇ Using the keypad	7
◇ Using scan function.....	7
■ Selecting a frequency.....	8
◇ Using the channel selector.....	8
◇ Using the keypad	8
4 RECEIVE AND TRANSMIT	9–11
■ Basic voice receive and transmit.....	9
■ Functions for transmit.....	9
◇ Transmit frequency check.....	9
◇ Transmit power selection	9
■ Functions for receive.....	10
◇ Squelch function	10
◇ Noise blanker	10
◇ AGC OFF function	10
◇ RF gain setting.....	10
◇ Clarity control	10
■ CW operation (Depends on versions)	11
■ FSK operation (Depends on versions)	11
5 USER CHANNEL PROGRAMMING	12
■ Programming a frequency.....	12
◇ Receive Frequency	12
◇ Transmit frequency	12
◇ Channel name.....	12
6 SET MODE	13–15
■ Set mode operation.....	13
■ Set mode contents	13
7 CONNECTIONS AND INSTALLATION	16–22
■ Connections on the rear panel	16
■ Unpacking	16
■ Connector information.....	17
■ Ground connection.....	19
■ Power source	19
■ Antenna.....	20
◇ MN-100/MN-100L ANTENNA MATCHERS	20
◇ AT-130 AUTOMATIC ANTENNA TUNER.....	20
◇ Non-Icom tuner	20
■ Mounting	21
◇ Mounting location.....	21
◇ Mounting example.....	21
◇ Transceiver dimensions	21
■ Installing the internal options.....	22
◇ Opening the case.....	22
◇ Installing an optional filter	22
■ Fuse replacement	22
8 TROUBLESHOOTING	23
9 SPECIFICATIONS AND OPTIONS	24
■ Specifications	24
◇ GENERAL	24
◇ TRANSMITTER	24
◇ RECEIVER.....	24
■ Options.....	24

□ CALL PROCEDURES

Calls must be properly identified and time limits must be respected.

- ① Give your call sign each time you call another vessel or coast station. If you have no call sign, identify your vessel name and the name of the licensee.
- ② Give your call sign at the end of each transmission that lasts more than 3 minutes.
- ③ You must break and give your call sign at least once every 15 minutes. during long ship-to-shore calls.
- ④ Keep your unanswered calls short, less than 30 seconds.
Do not repeat a call for 2 minutes.
- ⑤ Unnecessary transmissions are not allowed.

□ PRIORITIES

- ① Read all rules and regulations pertaining to priorities and keep an up-to-date copy handy. Safety and distress calls take priority over all others.
- ② False or fraudulent distress calls are prohibited and punishable by law.

□ PRIVACY

- ① Information overheard but not intended for you cannot be lawfully used in any way.
- ② Indecent or profane language is prohibited.

□ LOGS

- ① All distress, emergency and safety calls must be recorded in complete detail. Log data activity is usually recorded in 24 hour time. Universal Time (UTC) is frequently used.
- ② Adjustments, repairs, channel frequency changes and authorized modifications affecting electrical operation of the equipment must be kept in the maintenance log; entries must be signed by the authorized licensed technician performing or supervising the work.

□ RADIO LICENSES**(1) SHIP STATION LICENSE**

You must have a current radio station license before using the transceiver. It is unlawful to operate a ship station which is not licensed.

Inquire through your dealer or the appropriate government agency for a Ship-Radiotelephone license application. This government-issued license states the call sign which is your craft's identification for radio purposes.

(2) OPERATOR'S LICENSE

A Restricted Radiotelephone Operator Permit is the license most often held by small vessel radio operators when a radio is not required for safety purposes.

The Restricted Radiotelephone Operator Permit must be posted or be kept with the operator. Only a licensed radio operator may operate a transceiver.

However, non-licensed individuals may talk over a transceiver if a licensed operator starts, supervises, and ends the call, and makes the necessary log entries.

Keep a copy of the current government rules and regulations handy.

■ Front panel

This function is not installed in the IC-M710.

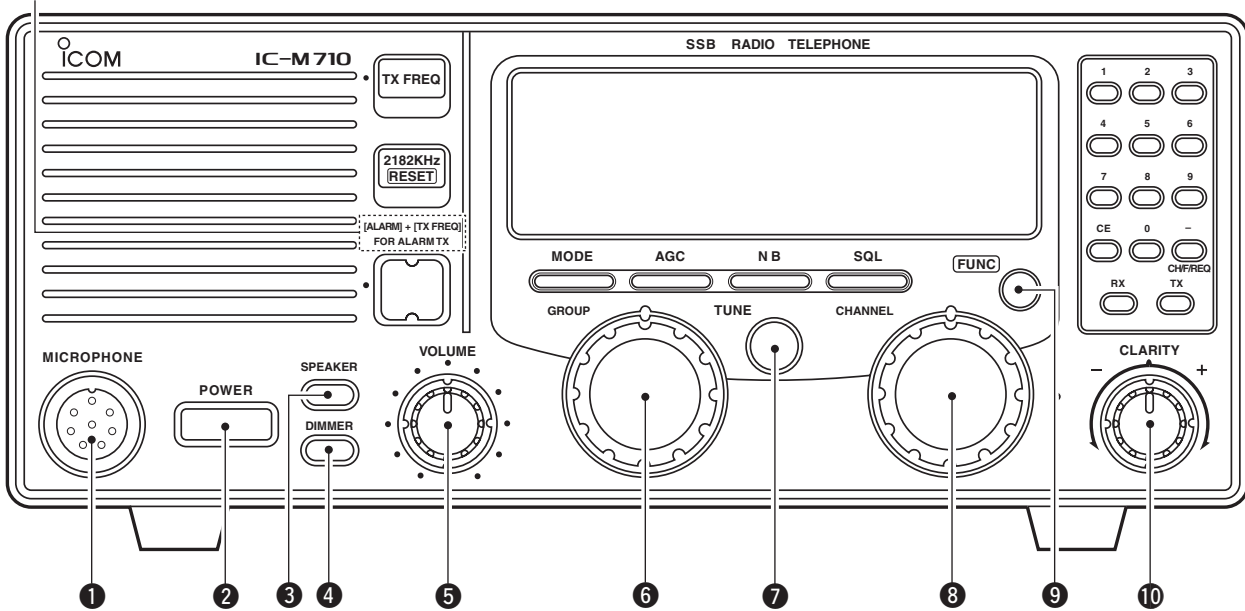

- 1 MICROPHONE CONNECTOR** (p. 17)
Accepts the supplied microphone or an optional handset.

/// **NOTE:** No audio is output to the speaker when the microphone or handset is not connected.
- 2 POWER SWITCH [POWER]**
Turns power ON or OFF.
- 3 SPEAKER SWITCH [SPEAKER]**
Turns the speaker ON or OFF.

 - “” appears in the display while the speaker is turned OFF.
 - Any external speaker connected to the rear panel is not turned OFF.
- 4 DISPLAY INTENSITY SWITCH [DIMMER]**

 - ➔ Turns the display backlighting ON or OFF.
 - ➔ Push [FUNC], and then rotate the channel selector dial to set the intensity level while pushing and holding [DIMMER].
- 5 VOLUME CONTROL [VOLUME]**
Adjusts the audio output level.

 - No sound is output to the speaker when:
 - A microphone is not connected.
 - The [SPEAKER] switch is turned ON.
 - The [SQL] switch is turned ON and no signal is being received.
- 6 GROUP CHANNEL SELECTOR [GROUP]**
Selects groups in 20 channels steps and ITU marine channel groups.

/// **NOTE:** Some versions have no ITU channels.
- 7 ANTENNA TUNE SWITCH [TUNE]** (p. 9)
Tunes the external tuner to the antenna.

 - Activates only when an optional antenna tuner such as Icom’s AT-130 is connected.

/// **NOTE:** When selecting “Automatic tuning” in the set mode, pushing this switch is not necessary to tune the antenna. (p. 13)
- 8 CHANNEL SELECTOR [CHANNEL]** (p. 6)

 - ➔ Selects an operating channel within the selected channel group.
 - User channels can be selected from 1 to 160 (max.) in sequence regardless of the channel group.
 - ➔ Changes the operating frequency after [CE] is pushed (while “” appears).
 - The changed frequency is not programmed in this way.
- 9 FUNCTION SWITCH [FUNC]**
After pushing activates the secondary functions of these switches:

 - [SQL] Starts and stops scan (p. 7).
 - [RX] Sets RF gain (p. 10).
 - [TX] Selects transmit power (p. 9).
 - [CE] Reprograms the channel name (p. 12).

/// **NOTE:** Function availability depends on versions.
- 10 CLARITY CONTROL [CLARITY]** (p. 10)
Shifts the receive frequency ± 150 Hz for clear reception of an off frequency signal.

■ Front panel (Continued)

This function is not installed in the IC-M710.

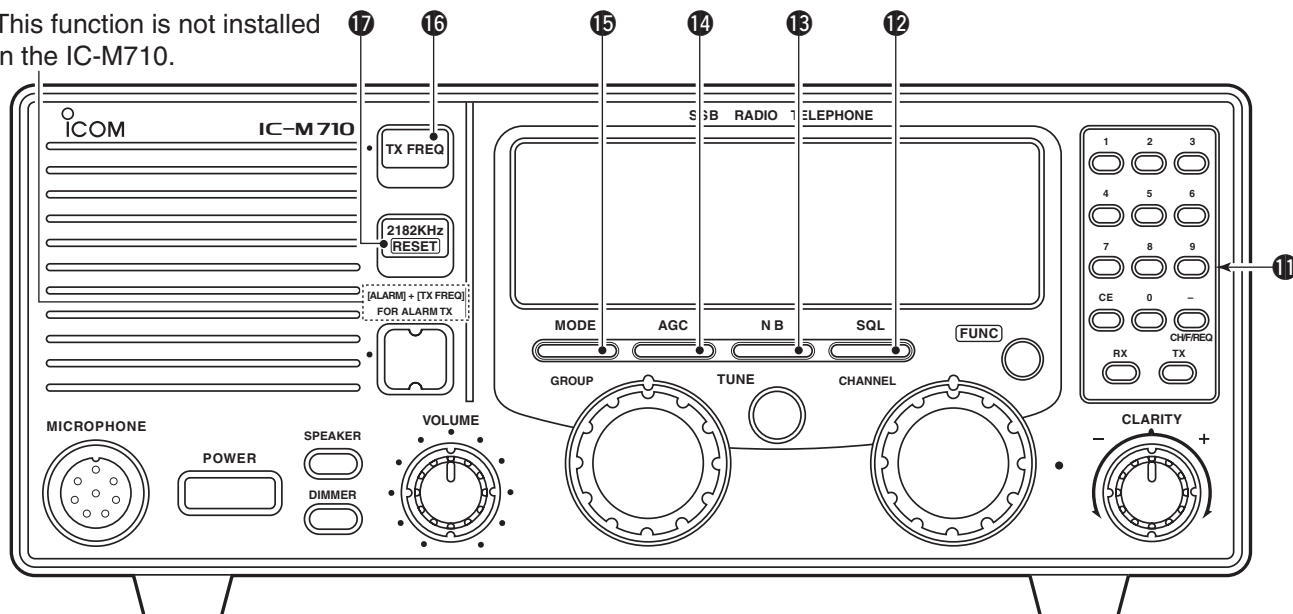

11 KEYPAD



- Enters the selected channel number (or frequency) for direct channel selection. (p. 7)
- Stores a receive frequency into a user channel or ITU simplex channel when:
 - pushing [CE] (“▶” appears)
 - entering the desired frequency via the keypad
 - pushing and holding [RX] (p. 12)
- Adjusts the RF gain after pushing [FUNC] to reduce the receiver sensitivity. (p. 10)



- Stores a transmit frequency into a user channel (except General version) when:
 - pushing [TX] (“TX” blinks)
 - pushing [CE] (“▶” appears)
 - entering the desired frequency via the keypad
 - pushing and holding [TX] (p. 12)
- Selects the transmit output power after pushing [FUNC]. (p. 9)



- Toggles the channel number input or frequency input. (p. 8)
 - “▶” appears when frequency input is selected.
 - The channel selector and keypad changes the frequency while “▶” appears.
- Clears the entered digit and retrieves the previous channel (or frequency) while entering numbers. (p. 7)
- Enters the name programming condition after pushing [FUNC] for changing the channel name. (p. 12)



- Toggles the channel or frequency indications. (p. 6)
- Enters “-” for ITU simplex channels. (p. 7)



- Enter channel number with up to 4 or 5 digits when “▶” does not appear. (p. 7)



- Enter the frequency with up to 6 digits when “▶” appears. (p. 8)

12 SQUELCH SWITCH [SQL] (p. 10)

- Activates the voice squelch function to reject undesired background noise while no signal is being received.
 - The squelch opens only when the received signal contains voice or FSK components.
- Starts and stops the scan function after pushing [FUNC]. (p. 7)

13 NOISE BLANKER SWITCH [NB] (p. 10)

- Turns the noise blanker function ON to remove pulse-type noise such as engine ignition noise.
- “NB” appears when the function is turned ON.

14 AGC OFF SWITCH [AGC] (p. 10)

- Deactivates the AGC function to receive weak signals blocked by strong adjacent signals.
- “~~AGC~~” appears when the [AGC] switch is turned ON (stands for AGC deactivated).

15 MODE SWITCH [MODE]

- Temporarily selects an operating mode. Available modes differ with the transceiver version.
- J3E (USB), H3E, J2B (AFSK), FSK, R3E, and A1A (CW) modes are available.
 - The temporary mode is cleared and the previous mode appears when changing a channel.

16 TRANSMIT FREQUENCY SWITCH [TX FREQ]

- (p. 9)
- Displays the transmit frequency and opens the squelch to check and monitor the transmit frequency.

17 2182 kHz SELECTION SWITCH

- [2182KHz • **RESET**] (p. 6)
- Selects channel 0 (2182 kHz; distress call frequency).
 - The channel selector does not function when selecting channel 0.
 - Ignores external control and gives the front panel control priority when an external controller (NMEA format) is connected.

■ Display

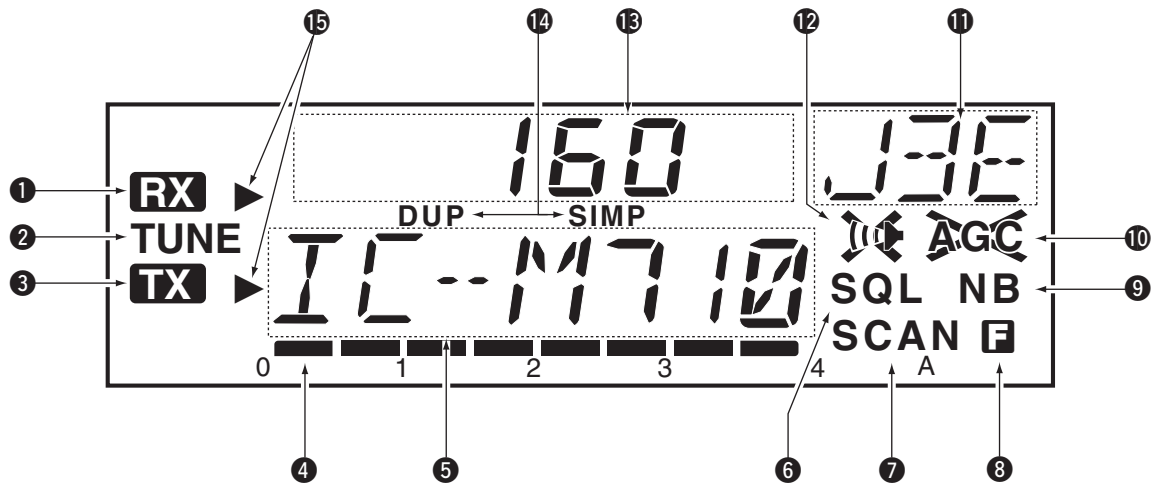

- 1 RECEIVE INDICATOR**
Appears while receiving and when the squelch is open.
- 2 TUNE INDICATOR** (p. 9)
Flashes while the connected antenna tuner, such as Icom's AT-130, is being tuned.
• Tuning starts when transmitting on a new frequency or pushing the [TUNE] switch.
- 3 TRANSMIT INDICATOR**
➔ Appears when transmitting.
➔ Blinks when the [TX] key is pushed for transmit frequency programming. (p. 12)
- 4 S/RF METER**
➔ Shows the relative received signal strength while receiving.
➔ Shows output power while transmitting.
- 5 CHANNEL NAME READOUT**
➔ Shows the pre-programmed channel name (alphanumeric) during channel indication. (p. 6)
➔ Shows the transmit frequency during frequency indication. (p. 6)
- 6 SQUELCH INDICATOR** (p. 10)
Appears when the squelch is ON.
- 7 SCAN INDICATOR** (p. 7)
Appears when the scan function is in use.
• Pushing [SCAN] starts and stops the scan.
- 8 FUNCTION INDICATOR**
Appears when the [FUNC] switch is pushed.
• Some switches activate secondary functions.
- 9 NOISE BLANKER INDICATOR** (p. 10)
Appears when the [NB] switch is turned ON.
- 10 AGC OFF INDICATOR** (p. 10)
Appears when the [AGC] switch is pushed to indicate the AGC function is deactivated.
- 11 MODE READOUT**
Shows the selected operating mode (type of emission).
- 12 SPEAKER OFF INDICATOR**
Appears when the [SPEAKER] switch is pushed to indicate the front panel speaker is deactivated.
- 13 CHANNEL READOUT**
➔ Shows the selected channel number during channel indication. (p. 6)
➔ Shows the receive frequency during frequency indication. (p. 6)
- 14 SIMPLEX/DUPLEX INDICATORS**
These appear to show whether the selected channel is simplex or duplex.
- 15 FREQUENCY INDICATORS** (p. 8)
Appears when the frequency entry condition is selected for frequency selection.
• The [CE] key toggles the indicator ON or OFF.

■ Selecting a channel

The transceiver has 160 user channels and ITU channels. However, the number of user channels can be optionally restricted and ITU channels are not available with some versions.

NOTE: When Channel 0 and/or 2182 kHz is selected with the [2182KHz] switch, channel selection is NOT possible. In such a case, push [2182KHz] in advance.

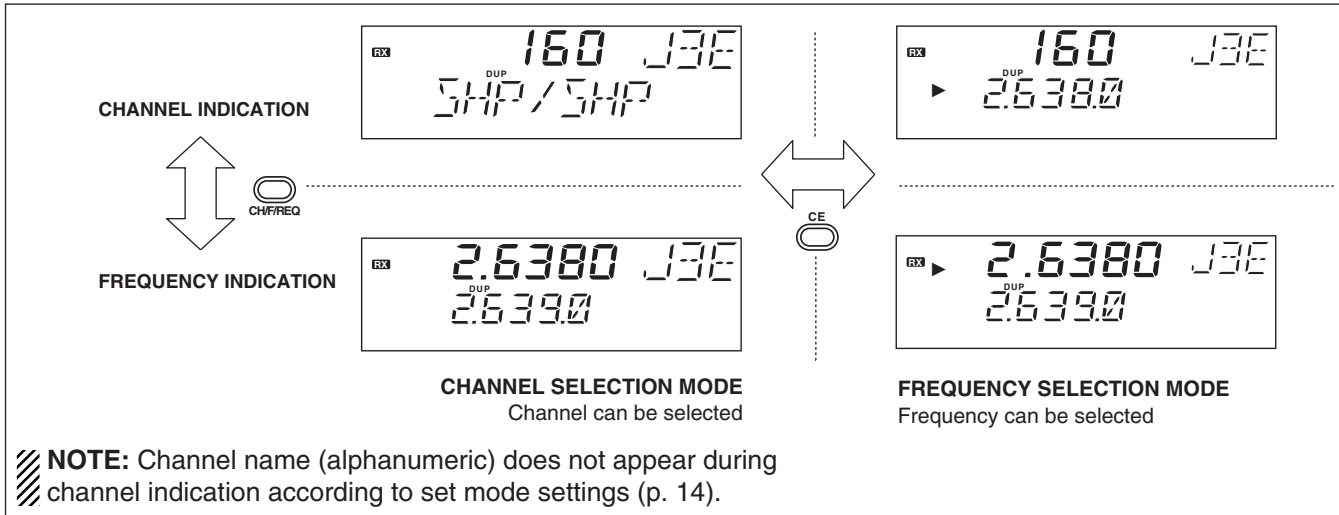

◇ Using the channel selector

The transceiver has two large controls for group selection and channel selection. The [GROUP] selector changes channels in 20 channel increments and selects ITU channel groups*; and the [CHANNEL] selector selects each channel.

① Be sure no "▶" indicator appears on the display.

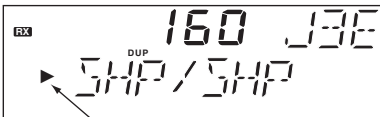

If appears, push [CE] and then it will disappear.

② Rotate the [GROUP] selector to select the desired channel group as shown at right and/or below.

③ Rotate the [CHANNEL] selector to select the desired channel.

[EXAMPLE]: Selection of the [GROUP] selector

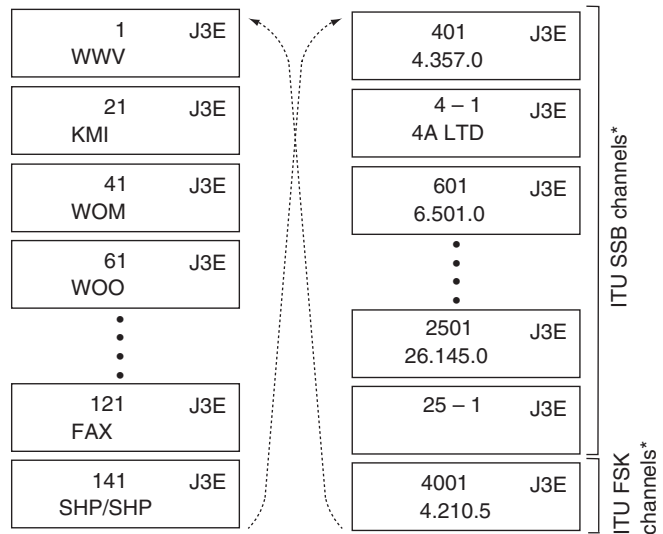

*All ITU channels are not available with some versions and ITU FSK channels can be hidden using set mode. (p. 13)

CHANNEL GROUP

CHANNEL NO.	DESCRIPTION	CHANNEL NO.	DESCRIPTION	CHANNEL NO.	DESCRIPTION
1 to 160	User channels ([GROUP] selector changes in 20 channels steps)	8 - 1 to 8 - 9	8 MHz ITU simplex channel	2201 to 2253	22 MHz ITU duplex channels
		1201 to 1241	12 MHz ITU duplex channel	22 - 1 to 22 - 9	22 MHz ITU simplex channels
401 to 427	4 MHz ITU duplex channels	12 - 1 to 12 - 9	12 MHz ITU simplex channels	2501 to 2253	25 MHz ITU duplex channels
4 - 1 to 4 - 9	4 MHz ITU simplex channels	1601 to 1656	16 MHz ITU duplex channels	25 - 1 to 25 - 9	25 MHz ITU simplex channel
601 to 608	6 MHz ITU duplex channels	16 - 1 to 16 - 9	16 MHz ITU simplex channel	4001 to 25040	ITU FSK duplex channels (SITOR use) (No group separation)
6 - 1 to 6 - 9	6 MHz ITU simplex channels	1801 to 1815	18 MHz ITU duplex channel		
801 to 832	8 MHz ITU duplex channels	18 - 1 to 19 - 1	18 MHz ITU simplex channels		

3 SELECTING A CHANNEL/FREQUENCY

◇ Using the keypad

Direct channel selection via the keypad is available for quick channel selection.

- ① Be sure no "▶" indicator appears on the display.
 - If appears, push [CE] and then it will disappear.
- ② Enter the desired channel number via the keypad.
 - A user channel is selected when channel 1-160 is input (max. number may be optionally restricted).
 - An ITU SSB channel is selected when channel numbers higher than 401 are input (not available for some versions).
 - An ITU FSK channel is selected when channel numbers higher than 4001 are input (not usable according to set mode setting).
 - The "-" key can be used 10 selecting an ITU simplex channel.
- ③ Push [RX] to select the entered channel.

[EXAMPLE]: Selecting channel 153.

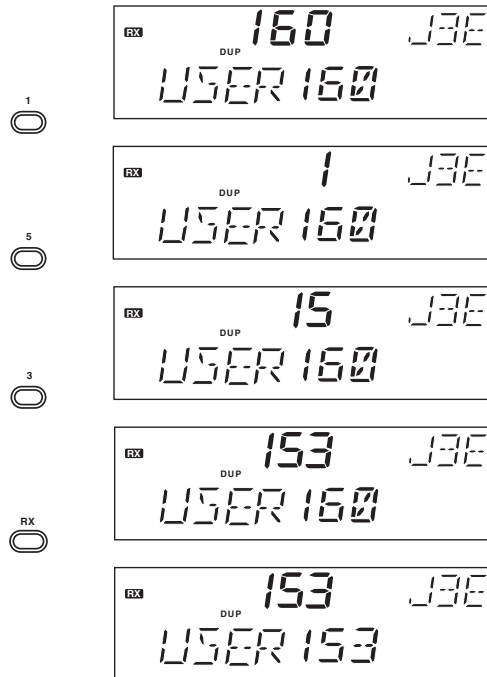

◇ Using scan function

The transceiver has automatic channel or frequency change capability (scan function). There are 3 types of scan functions available to suit your needs.

Channel scan

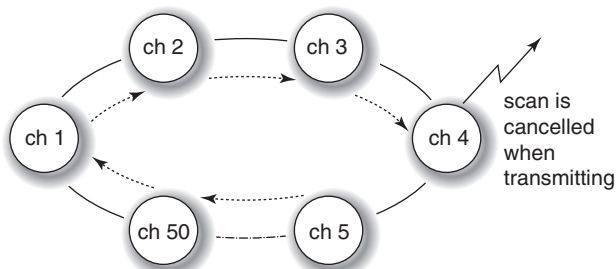

Channel resume scan

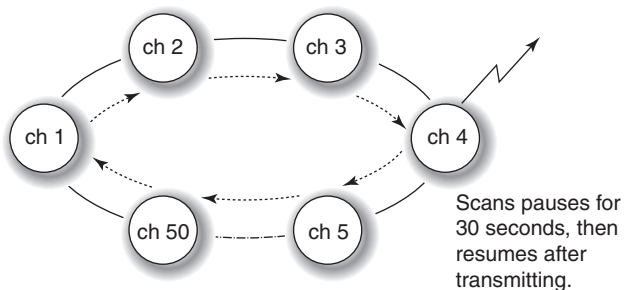

Programmed scan

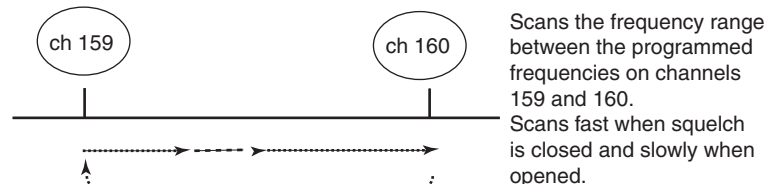

SCAN OPERATION

- ① Select your desired channel group with the [GROUP] and [CHANNEL] selector.
 - Or use the keypad and [CE] key for direct selection.
 - This operation is not necessary for programme scan.
- ② Push [SQL] to turn OFF the squelch function if the programmed scan is selected.
- ③ Push [FUNC] then [SQL] to start the scan.
- ④ To stop the scan, repeat step ③ again.
 - [CHANNEL] rotation and some other switches also stop the scan.

Scan selection is available in the set mode. See p. 14 for scan selection.

Channel scan and channel resume scan increases channels within a 5 channel range such as ch 1 to ch 5, ch 156 to ch 160, etc. in user channels; or all channels in the group of ITU channels.

Programmed scan changes frequencies within the frequency range between user channels 159 and 160.

■ Selecting a frequency

The transceiver has 0.5 to 30.0 MHz general coverage receive capability, with 100 Hz resolution. The receive frequency can be changed instantly, independent of the transmit frequency.

NOTE: The selected frequency is used for temporary receiving (transmitting is not available). This frequency is cleared once the channel is changed. If you want to program a frequency refer to p. 12, memory programming.

◇ Using the channel selector

- ① Select a channel which is programmed near the frequency you want receive.
- ② Push the [CE] key to select frequency selection mode.
 - “▶” appears on the display.
- ③ Rotate the [CHANNEL] selector to change the frequency.
- ④ To return to the previous frequency push [CE].
 - “▶” disappears and the previous frequency or channel name appears.

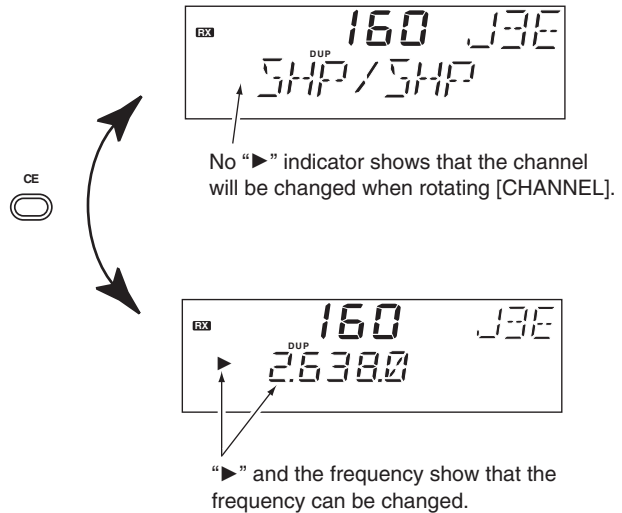

◇ Using the keypad

CAUTION: A frequency can be entered into a user channel or ITU simplex channel by pushing the [RX] key. However, when pushing and holding the [RX] key after entering a frequency. The previously programmed contents are erased and cannot be retrieved. Therefore, keypad entry should be used only on spare channels.

- ① Select the memory channel to be used for general coverage use.

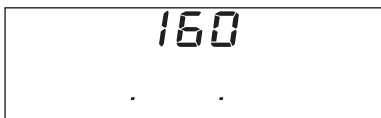

- ② Push [CE] to select frequency selection mode.
 - “▶” appears on the display.
- ③ Enter the desired frequency with 5 or 6 digits.
- ④ Push [RX] to input the frequency.
 - **Do not hold [RX]** for more than 0.5 seconds, otherwise the frequency will be programmed into the channel.

[EXAMPLE]: Setting 12.3450 MHz

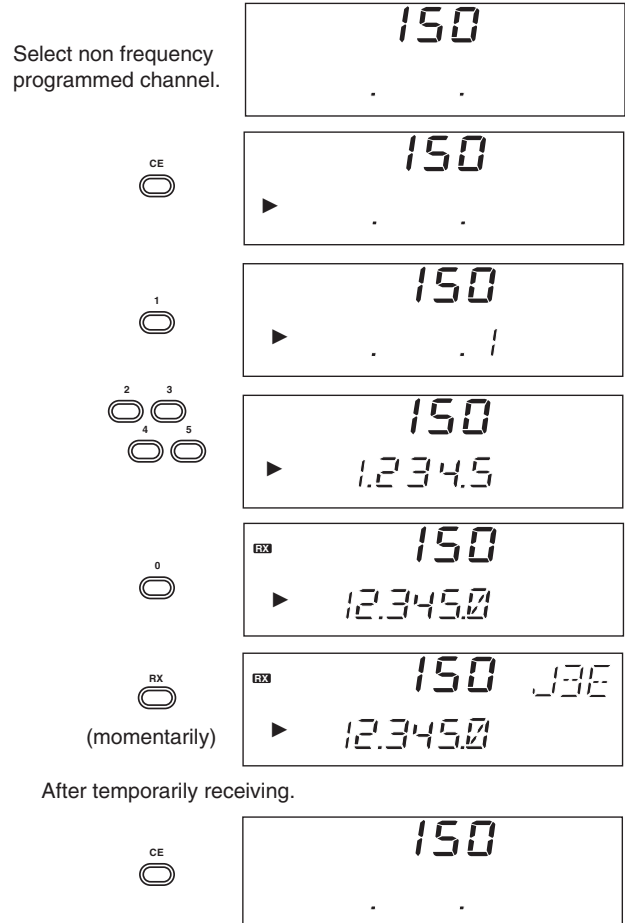

Basic voice receive and transmit

- ① Check the following in advance:
 - ➔ The microphone is connected.
 - ➔ The [SPEAKER] switch is turned OFF.
 - ➔ The [SQL] switch is turned OFF.
 - ➔ The [CLARITY] control is set to the center position.
 - ➔ The memory mode is selected.
 - If necessary, push [CH/FREQ] to select the memory mode.

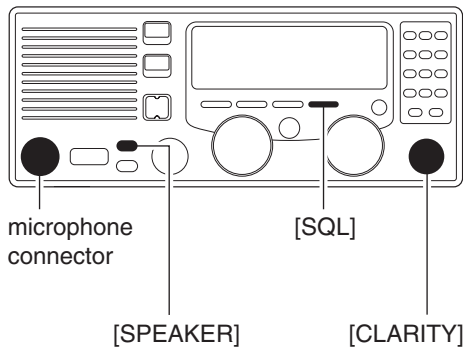

- ② Select the desired channel to be received with the [GROUP] and [CHANNEL] selectors.
 - When receiving a signal, the S-meter shows the signal strength.
- ③ Adjust [VOLUME] to the desired audio level when receiving a signal.
- ④ If the received signal is in a different mode, push [MODE] to select the desired operating mode.
- ⑤ If connected, push [TUNE] to tune the antenna tuner.
 - This operation is not necessary when “automatic tuning” is selected in the set mode (p. 13).
- ⑥ To transmit on the channel, push and hold the PTT switch on the microphone.
 - “TUNE” flashes for 1 to 2 seconds for the first transmission on a channel when an antenna tuner is connected.
- ⑦ After the flashing stops, speak into the microphone at your normal voice level.
 - The RF meter shows the output power, according to your voice level.
- ⑧ Release the PTT switch to return to receive.

Functions for transmit

◇ Transmit frequency check

When “DUP” appears on the display, such as for a ship-to-shore channel, the transmit frequency differs from the receive frequency.

In such cases, the transmit frequency should be monitored before transmitting to prevent interference to other stations.

Push and hold [TX FREQ] to monitor the transmit frequency.

- The display shows the transmit frequency.

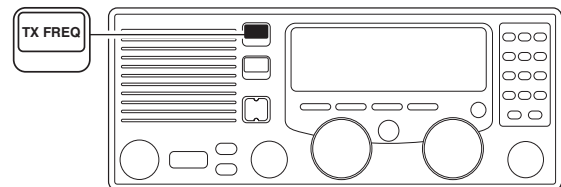

◇ Transmit power selection

The transceiver has 3 selectable output powers. High power allows longer distance communications and low power reduces power consumption.

NOTE: Low power setting affects all channels except the 2182 kHz emergency channel.

- ① Push [FUNC] then [TX] to call up the following display.

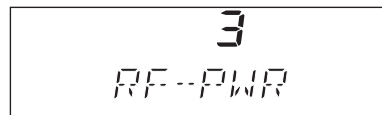

- ② Rotate the [CHANNEL] selector to select high or low output power.
 - 3 : high power (150 W PEP)
 - 2 : middle power (60 W PEP)
 - 1 : low power (20 W PEP)
- ③ Push [FUNC] or [CE] to return to the previous display.

■ Functions for receive

◇ Squelch function

The squelch function detects signals with voice components and squelches (mutes) unwanted signals, such as unmodulated beat signals. This provides quiet standby.

When you need to receive weak signals, the squelch should be turned OFF.

- Push [SQL] to toggle the function ON or OFF.

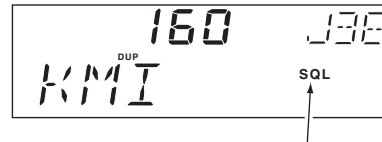

"SQL" appears when the squelch function is ON (noise is muted).

◇ Noise blanker

The noise blanker function reduces pulse type noise, such as that coming from engine ignitions.

The noise blanker may distort reception of strong signals. In such cases, the noise blanker should be turned OFF.

- Push [NB] to toggle the function ON or OFF.

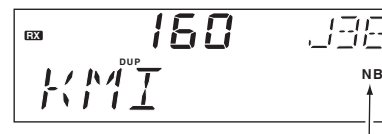

"NB" appears when the noise blanker is ON.

◇ AGC OFF function

The receiver gain is automatically adjusted according to the received signal strength with the AGC (Automatic Gain Control) function, to prevent distortion from strong signals and to obtain a constant output level.

When receiving weak signals with adjacent strong signals or noise, the AGC function may reduce the sensitivity. In this situation, the AGC function should be deactivated.

- Push [AGC] to toggle the function ON or OFF.

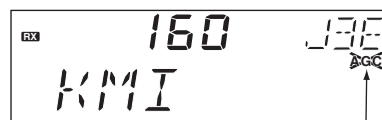

Appears when the [AGC] switch is ON (AGC function deactivates).

◇ RF gain setting

The receiver gain can be reduced with the RF gain setting. This may help to remove undesired weak signals while monitoring strong signals.

Usually the AGC function reduces the RF gain according to the receive signal strength and these weak signals are removed. However, during periods of no signals, these weak signals may not be heard.

In such cases, the RF gain may be useful for setting a minimum level at which to hear signals.

- ① Push [FUNC] then [RX] to call up the following display.

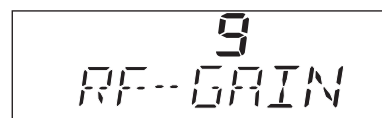

- ② Rotate the [CHANNEL] selector to set the desired minimum cutting level.
 - "0" to "9" are available.
 - S-meter shows the minimum permitted level.
- ③ Push [FUNC] or [CE] to exit the RF gain display.

◇ Clarity control

Voice signals received from other stations may be difficult to receive. This may sometimes happen if a station is transmitting slightly off frequency. In such cases, vary the receive frequency only, using the [CLARITY] control.

- Adjust [CLARITY] to improve the audio signal.

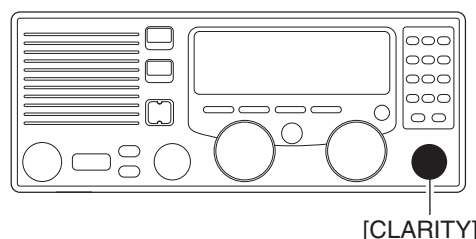

■ CW operation (Depends on versions)

The transceiver has the following CW keying features selectable in the set mode, as described on page 15.

- Full break-in (receiving is possible while transmitting)
- Semi break-in (automatic transmission with keying)
- OFF (manual transmission is necessary before keying)

- ① Connect a CW keyer or an external electronic keyer to the ACC(1) socket, as shown at right.
- ② Select the desired channel to operate in the A1A (CW) mode.
- ③ When the selected channel is not in the A1A (CW) mode, push [MODE] one or more times to select "A1A."
- ④ Operate the CW keyer to transmit a A1A (CW) signal.

NOTE:

- A1A mode is not available in some versions.
- CW narrow can be selected in the set mode when an optional filter is installed. (p. 14)

CW key connection

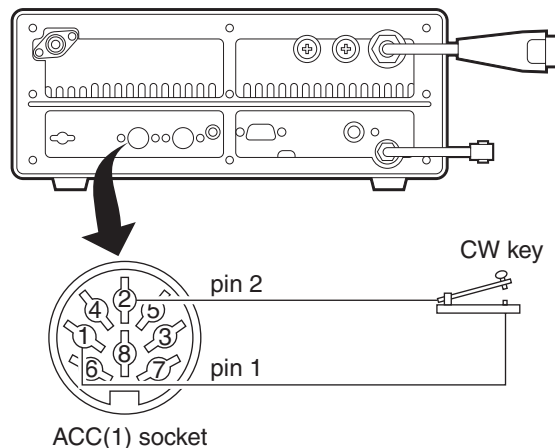

■ FSK operation (Depends on versions)

The transceiver has FSK and J2B modes for FSK operation—use FSK when using the built-in oscillator; use J2B when using an AFSK terminal unit.

- ① Connect an FSK terminal unit as shown at right.
- ② Select the desired channel.
 - FSK ITU channel group, ch 4001 to ch 25040, are available, depending on the version.
- ③ Push [MODE] one or more times to select either "FSK" or "J2B."
- ④ Operate the FSK terminal unit.

NOTE:

- FSK shift frequency and FSK polarity can be adjusted in the set mode (pgs. 14 and 15).
- Some transceivers may operate 1.7 kHz higher than the IC-M710's J2B mode, even when the same displayed frequencies are in use.

FSK terminal unit connection

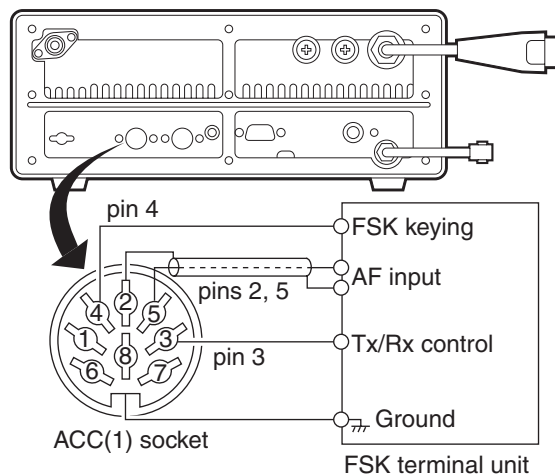

■ Programming a frequency

The IC-M710 has up to 160 user-programmable channels each with channel name capability of up to 7 alphanumeric characters.

NOTE: ITU simplex channels can be programmed as well as user channels. However, transmit frequencies cannot be programmed (not necessary to program).

◇ Receive Frequency

- ① Select the desired user channel to be programmed.
 - Channel 1 to 160 (maximum) are programmable.
- ② Push the [CE] key to select frequency selection mode.
 - “▶” and a frequency appear on the display.
- ③ Enter the desired frequency via the keypad with 5 or 6 digits.
 - Or rotate the [CHANNEL] selector to change the frequency.
- ④ To change the operating mode (type of emission), push [MODE] one or more times.
- ⑤ Push and hold [RX] for 1 second to program the user channel.

Push [CE]

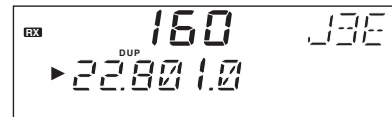

“▶” and frequency appear.

Set the frequency

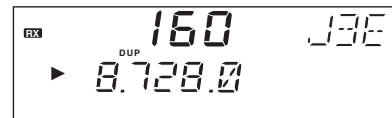

Use keypad or channel selector.

Push and hold [RX]

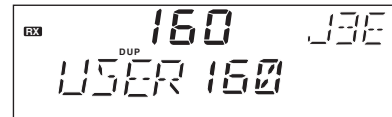

Programming is completed.

◇ Transmit frequency

- ① Select the desired user channel to be programmed.
- ② Push [TX].
 - “TX” blinks.
- ③ Push [CE] to select frequency selection mode.
 - “▶” and frequency appear on the display.
- ④ Enter the desired frequency via the keypad with 5 or 6 digits.
 - The [CHANNEL] selector cannot be used.
 - Refer to p. 24 for programmable frequency range (frequency coverage transmit).
- ⑤ Push and hold [TX] for 1 second to program.
- ⑥ Push [TX] to clear the “TX” blinking.

Push [TX]

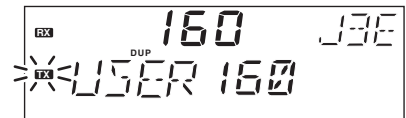

“TX” blinks.

Push [CE]



Push and hold [RX] after entering a frequency.

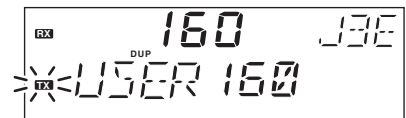

◇ Channel name

- ① Select the desired user channel to be programmed.
- ② Push [CH/FREQ] to select channel indication.
- ③ Push [FUNC] and then [CE].
 - The channel name (alphanumeric) readout blinks.
- ④ Rotate the [GROUP] selector to cursor position and the [CHANNEL] selector for the message contents.
 - To return to the previous message, push [CE].
- ⑤ Push and hold [RX] to program the message.
 - Blinking stops.

Push [FUNC] then [CE]

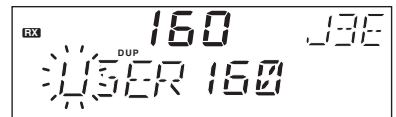

Rotate [GROUP] and [CHANNEL] to select cursor and character

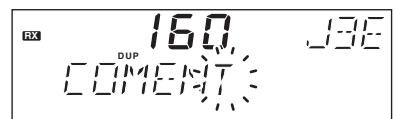

Push [RX]



• Available characters 0 to 9 A to Z _ (space) ' () * + / - = > ?

6

SET MODE

■ Set mode operation

Set mode operation is used for programming infrequently changed values or functions. The IC-M710 has up to 13 items.

NOTE: Some of the set mode items described in this section are not available on some transceiver versions.

- ① Push [POWER] to turn power OFF.
- ② While pushing and holding [FUNC] and [1], turn power ON and enter the set mode.
 - The set mode is selected and one of its items appears.
- ③ Rotate the [GROUP] selector to select the desired item.
- ④ Rotate the [CHANNEL] selector to set the values or options for the selected item.
- ⑤ Turn power OFF and then ON again to exit the set mode.

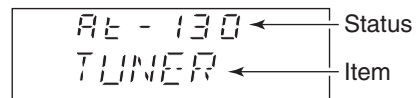
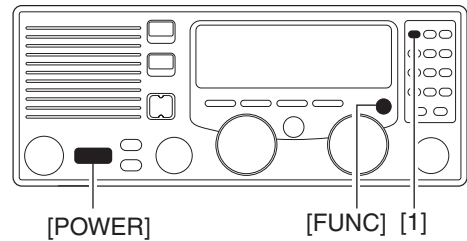

■ Set mode contents

(1) FSK ITU channels

FSK ITU channels appear as a group between the ITU 25 MHz band and user channels. This FSK channel group can be hidden for voice communication use only.

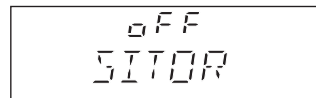

FSK channels do not appear (no SITOR operation). (default)

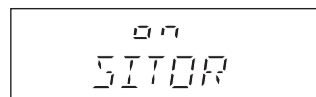

FSK channels appear (SITOR operation).

(2) Connected antenna tuner

The transceiver has several tuner control systems for use with an optional Icom antenna tuner. Select the condition depending on the connected antenna tuner.

Note that internal switch selection may be required when using a non-Icom tuner (p. 20).

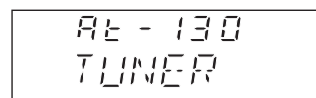

AT-130 (default)

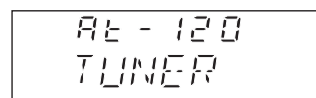

AT-120

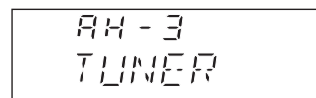

AH-3

(3) Automatic tuning operation

When the optional AT-130 AUTOMATIC ANTENNA TUNER is connected, tuning can be started automatically without the [TUNE] switch for instant operation.

If manual tuning is required, this automatic operation can be deactivated.

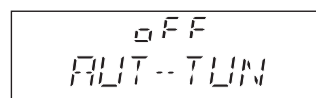

Tuning starts only when [TUNER] is pushed. (default)

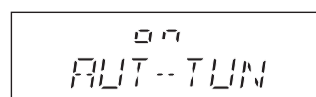

Tuning starts when pushing [PTT] on a new frequency.

(4) Scan type selection

This item selects one of the following scan functions.

Channel scan and channel resume scan search 5 channels around a user selected channel or search all ITU channels in the band when an ITU channel is selected.

Programmed scan searches signals within the frequency range and activates slowly while squelch is open and fast while squelch is closed.

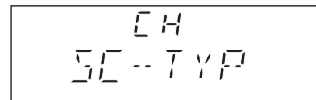

Channel scan
Scan is canceled when transmitting. (default)

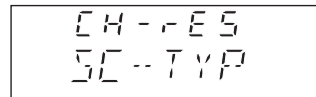

Channel resume scan
Scan pauses when squelch opens, then resumes after 30 seconds.

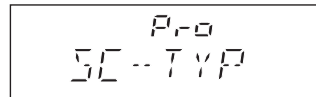

Programmed scan
Scan operates over the frequency range.

(5) Scan speed

Selects scan speed as follows:

Selection	1	2	3	4	5	6	7	8	9	10
Channel Scan	130	260	520	1040	2080	4160	8320	16360	33280	66560
Channel resume scan (sec./ch)	1	2	3	4	5	6	7	8	9	10
Programmed scan (squelch open*)	10	20	40	60	90	140	210	320	480	720

(unit: msec./ch)

Faster

Slower

*squelch closed: 10 ms/ch

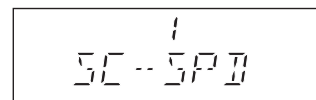

Fastest scan speed

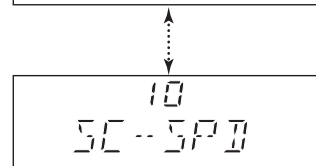

(default: 4)

Slowest scan speed

(6) Channel name and frequency

The lower half of the display can be set to display a programmable channel name or a receive frequency according to an operator's needs.

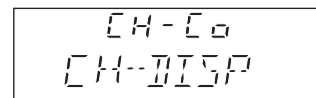

Channel number and channel name (alphanumeric) (default)

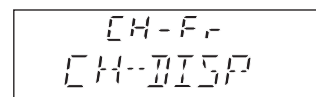

Channel number and frequency

(7) CW/FSK narrow filter

This selects the passband width for A1A (CW), FSK or J2B mode.

NOTE: When "on" is selected without the optional filter installed, general version does not function on these modes.

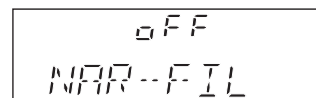

Passband: 2.3 kHz/-6 dB (default)

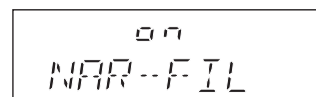

Passband: 500 Hz/-6 dB

(8) FSK frequency shift

Several shift settings (the difference between the mark and space frequency) are used for FSK operation. This item allows you to select a shift setting for almost any FSK system.

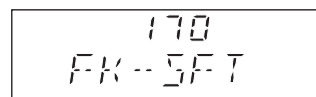

Frequency shift: 170 Hz (default)

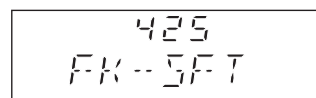

Frequency shift: 425 Hz

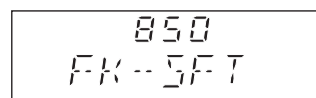

Frequency shift: 850 Hz

6 SET MODE

(9) FSK polarity

Normal and reverse polarities are available for FSK operation. This item allows you to select one of these polarities.

“FSK-REV off” (normal):
key open (mark); key close (space)

“FSK-REV on” (reverse):
key open (space); key close (mark)

off
FSK-REV

FSK normal
(default)

on
FSK-REV

FSK reverse

(10) CW break-in

CW break-in function (in A1A (CW) mode) toggles transmit and receive with CW keying. Full break-in allows you to receive signals between transmitted keying pulses during CW transmission. Semi break-in allows you to mute receiving until keying stops with some delay time.

full
CW-BKIN

Full break-in
Automatic keying without
delay time (default)

delay
CW-BKIN

Semi break-in
Automatic keying with delay
time

off
CW-BKIN

OFF
Manual transmission
necessary for keying

(11) LCD contrast

The LCD contrast can be adjusted through 10 levels, to suit transceiver mounting angle, location and ambient lighting.

01
LCD-CONTR

Lowest contrast

(default: 7)

10
LCD-CONTR

Highest contrast

(12) ID number setting for remote control

When connecting an external controller, such as a personal computer, 2-digit ID codes are required to access the transceiver. The IC-M710 adopts the NMEA0183 format, and uses a “proprietary sentence” for remote control.

01
REMT-ID

NMEA ID: 1
(default)

99
REMT-ID

NMEA ID: 99

(13) Remote control input terminal

Remote control signals can be input via the [DSC] (or REMOTE) socket or [CLONE] jack.

d-Sub
REMT-IF

[DSC] (or REMOTE
according to the version)
socket (default)

Pin
REMT-IF

The [CLONE] jack

■ Connections on the rear panel

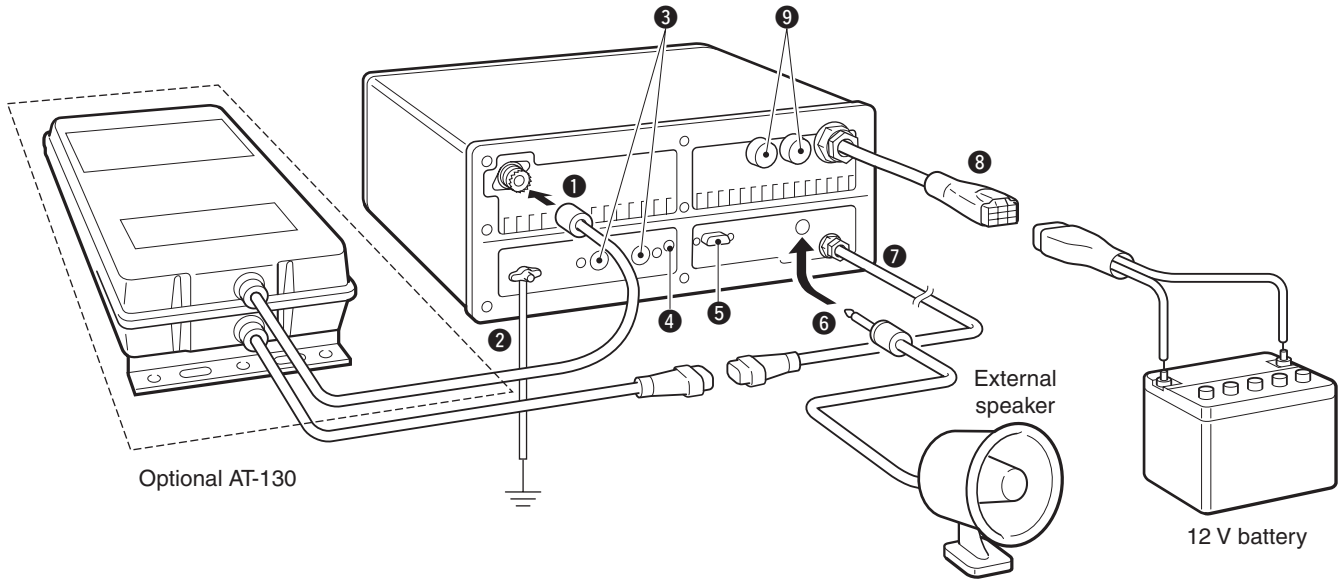

- 1 ANTENNA CONNECTOR** (p. 20)
Connects a 50 Ω HF band antenna with a 50 Ω matched coaxial cable and a PL-259 plug.
- 2 GROUND TERMINAL**
IMPORTANT! Connects to a ship's (or vehicle's) ground. See p. 19 for details.
- 3 ACC(1) and ACC(2) SOCKETS**
See p. 17 for details.
- 4 CLONE JACK**
For Dealer use only.
- 5 REMOTE SOCKET** (p. 18)
REMOTE socket for General version.
- 6 EXTERNAL SPEAKER JACK**
Connects a 4 to 8 Ω external speaker using a 1/4" monaural plug. This external audio is not muted by the [SPEAKER] switch on the front panel.

- 7 TUNER RECEPTACLE**
Connects a control cable to an optional AT-130 ANTENNA TUNER. A female connector is supplied for connection.
- 8 DC POWER RECEPTACLE**
Connects to a regulated 12–16 V DC power source such as a 12 V battery or DC power supply using the supplied DC power cable.
- CAUTION: DO NOT** connect to a 24 V battery. This will damage the transceiver.
- 9 FUSE HOLDERS**
Hold two 30 A fuses for ⊕ and ⊖ terminals. Replace both fuses when one fuse is blown.

■ Unpacking

Microphone (HM-180)	1
Microphone hanger	1
DC power cable (OPC-568)	1
Mounting bracket	1
Bracket knobs	4
Flat washers (M5)	4
CONNECTORS	
DIN connector (8-pin for ACC1)	1
DIN connector (7-pin for ACC2)	1
Speaker plug	1
Tuner connector	1
Pins for tuner connector	4
Plates for tuner connector	4

NUTS AND BOLTS	
Allen bolt (M6 × 50)	4
Self-tapping screws (M6 × 30)	4
Nuts (M6; use 2 pcs. for each bolt)	8
Flat washers (M6)	8
Spring washers (M6)	4
Self-tapping screws (M3 × 16 for mic. hanger)	2
FUSES	
FGB 30 A (rear panel)	2
1205 (internal)	2

■ Connector information

ACC(1)	PIN	PIN NAME	DESCRIPTION	SPECIFICATIONS
 <p>Rear panel view</p>	1	CWK	CW and FSK keying input.	Input level: Less than 0.6 V for transmit.
	2	GND	Connects to ground.	Connected in parallel with ACC(2) pin 2.
	3	SEND	Input/output pin. Goes to ground when transmitting. When grounded, transmits.	Ground level: -0.5 to 0.8 V Input current: Less than 20 mA Connected in parallel with ACC(2) pin 3.
	4	MOD	Modulator input. Usable when pin 3 is grounded.	Input impedance: 10 kΩ Input level: Approx. 100 mV rms
	5	AF	AF detector output. Fixed, regardless of the [AF] position.	Output impedance: 4.7 kΩ Output level: 100–300 mV rms
	6	SCAN	Starts scan when grounded.	Scan operation: Less than 0.6 V
	7	13.6 V	13.6 V output when power is ON.	Output current: Max. 1 A Connected in parallel with ACC(2) pin 7.
	8	ALC	ALC voltage input.	Control voltage: -3 to 0 V Input impedance: More than 10 kΩ Connected in parallel with ACC(2) pin 5.

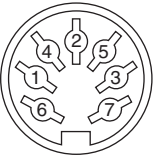
ACC(2)	PIN	PIN NAME	DESCRIPTION	SPECIFICATIONS
 <p>Rear panel view</p>	1	8 V	Regulated 8 V output.	Output voltage: 8 V ±0.3 V Output current: Less than 10 mA
	2	GND	Same as ACC(1) pin 2.	
	3	SEND	Same as ACC(1) pin 3.	
	4	NC	No connection.	
	5	ALC	Same as ACC(1) pin 8.	
	6	RLC	T/R relay control output.	When transmitting: 0 V (less than 0.5 A)
	7	13.6 V	Same as ACC(1) pin 7.	

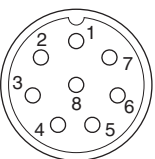
MICROPHONE	PIN	PIN NAME	DESCRIPTION	SPECIFICATIONS
	1	MIC+	Audio input from the microphone element.	Input impedance: 600 Ω
	2	NC	No connection.	
	3	AF1	AF output controlled with [VOLUME]. Connected to pin 4 in the microphone.	Output impedance: 4 Ω
	4	AF2	AF input. Connected to pin 3 in the microphone.	
	5	PTT	PTT switch input.	When grounded, transmits.
	6	GND	Connected to ground.	
	7	MIC-	Coaxial ground for MIC+.	
	8	AF-	Coaxial ground for AF1 and AF2.	

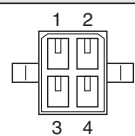
TUNER	PIN	PIN NAME	DESCRIPTION	SPECIFICATIONS
	1	KEY	Key signal input.	-0.5 to 0.8 V during tuning
	2	START	Start signal output.	Pulled up 8 V, 0 V (100 msec.) as start signal.
	3	13.6V	13.6 V output	Max. current : 2 A
	4	E	⊖ terminal	Ground

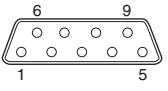
REMOTE	PIN	PIN NAME	DESCRIPTION	SPECIFICATIONS
	1	MOD+	Modulation input from an external terminal unit.	Input impedance: 600 Ω Input level: Approx. 100 mV rms
	2	MOD-	Coaxial ground for MOD+.	
	3	AF+	AF detector output for an external terminal unit.	Output impedance: 600 Ω Output level: 0.25–2.5 V rms
	4	AF-	Coaxial ground for AF+.	
	5	NMI+	NMEA data input.	NMEA standard format/level
	6	NMI-	Coaxial ground for NMI+.	
	7	NMO+	NMEA data output.	NMEA standard format/level
	8	NMO-	Coaxial ground for NMO+.	
	9	GND	Ground for digital equipment.	

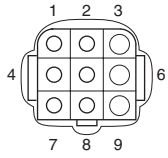
DC 13.6V	PIN	PIN NAME	DESCRIPTION	SPECIFICATIONS
	1,4,7	+	⊕ DC input	Max. power consumption: 30 A
	2, 5, 8	-	⊖ DC input	

Ground connection

The transceiver and antenna tuner **MUST** have an adequate ground connection. Otherwise, the overall efficiency of the transceiver and antenna tuner installation will be reduced. Electrolysis, electrical shocks and interference from other equipment could also occur.

For best results, use the heaviest gauge wire or strap available and make the connection as short as possible. Ground the transceiver and antenna tuner to one ground point, otherwise voltage differences between 2 ground points may cause electrolysis.

CAUTION: The IC-M710 has a negative ground. **NEVER** connect the IC-M710 to a “positive ground ship,” otherwise the transceiver will not function.

Good ground points

- Ship’s ground terminal
- External ground plate
- External copper screen

Acceptable ground points

- Stainless steel tuna tower
- Stainless steel stanchion
- Through mast
- Through hull
- Metal water tank

Undesirable ground points

- (these points may cause electrolysis)
- Engine block
 - Keel bolt

Unusable ground points

- (these connections may cause an explosion or electrical shock)
- Gas or electrical pipe
 - Fuel tank
 - Oil-catch pan

Ground system example

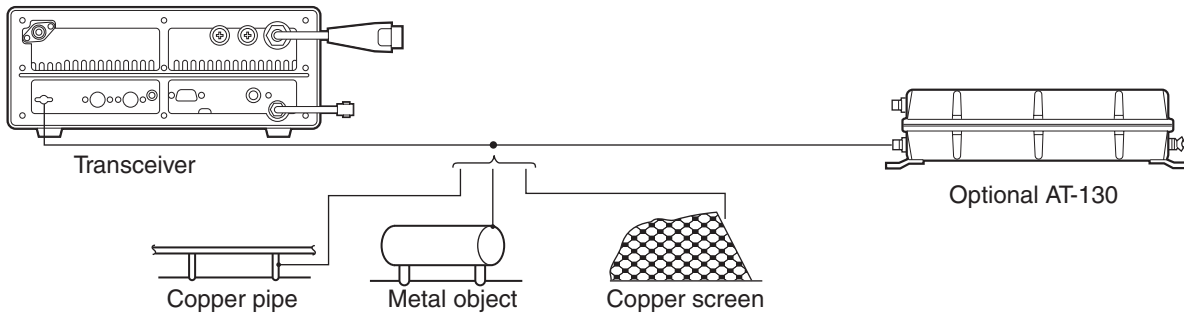

Power source

The transceiver requires regulated DC power of 13.6 V and at least 30 A. There are 3 ways to supply power:

- A direct connection to a 12 V battery in your ship, through the supplied DC power cable.

CAUTION: The supplied DC power cable **MUST** be used to provide power to the transceiver. **AVOID** exceeding the 3 m (10 ft) length of the DC power cable. If it is necessary to make a run of over 3 m (10 ft), use a #6 or similar gauge wire instead of the supplied DC power cable, for a maximum run of 6 m (20 ft).

DC power cable connection

NOTE: Use terminals for the cable connection.

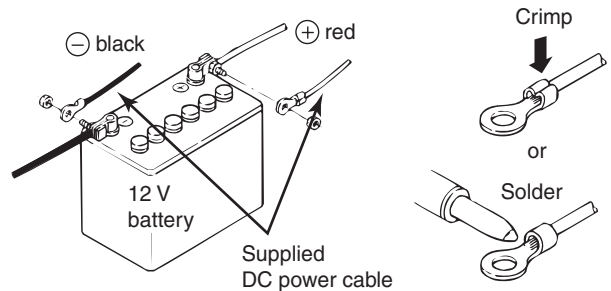

■ Antenna

Most stations operate with a whip or long wire (insulated backstay) antenna. However, these antennas cannot be connected directly to the transceiver, since their impedance may not be matched with the transceiver antenna connector.

Even with a 50 Ω matched antenna, all marine bands may not be fully usable. The following antenna matcher, or antenna tuner may be helpful for proper antenna installation.

◇ MN-100/MN-100L ANTENNA MATCHERS

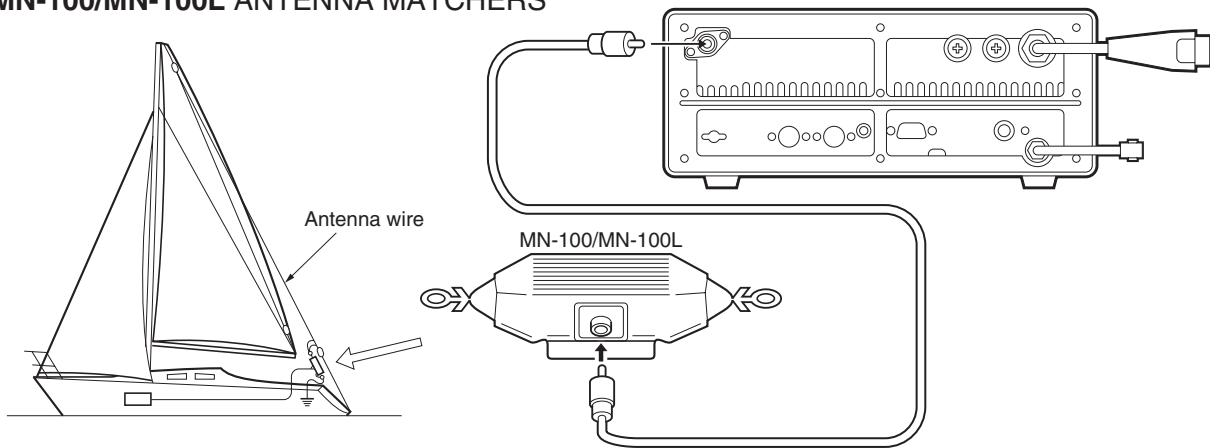

◇ AT-130 AUTOMATIC ANTENNA TUNER

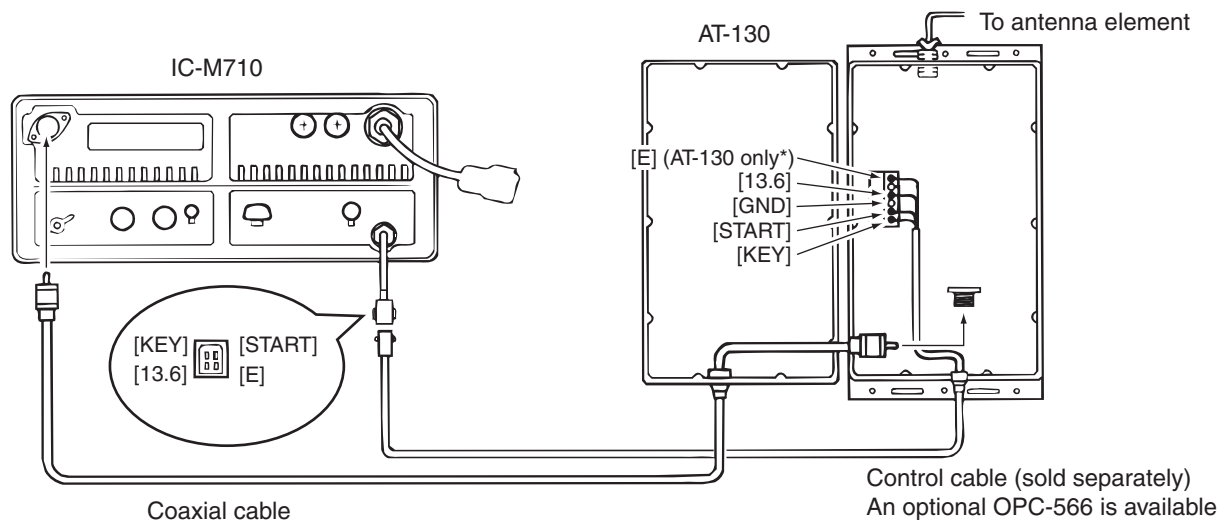

*For the AT-130, the [GND] terminal can be used inside of the [E] terminal.

◇ Non-Icom tuner

Some non-Icom tuners may be used with the IC-M710. Please consult your dealer or marina if you wish to use one. The following internal settings may be required for connection.

Supplies 8 V when pushing [TUNE].

↔ Grounded when pushing [TUNE].
(used for AT-130—default)

S9
(Start port level)

Accepts "LOW" as an answer back signal.

↔ Accepts "HIGH" as an answer back signal.
(used for AT-130—default)

S11
(Key port input)

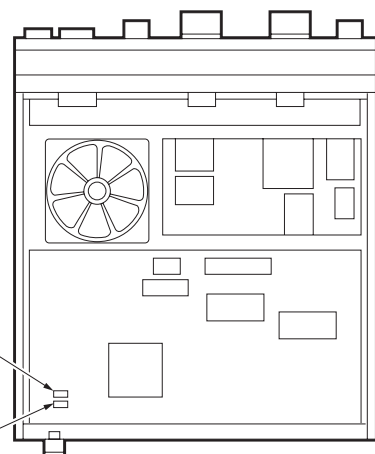

■ Mounting

⚠ WARNING: NEVER mount the transceiver overhead. The weight of the transceiver is approximately 7.8 kg (17.4 lb), but its apparent weight will increase several fold due to wave shocks or vibration. The transceiver must be mounted on a flat, hard surface.

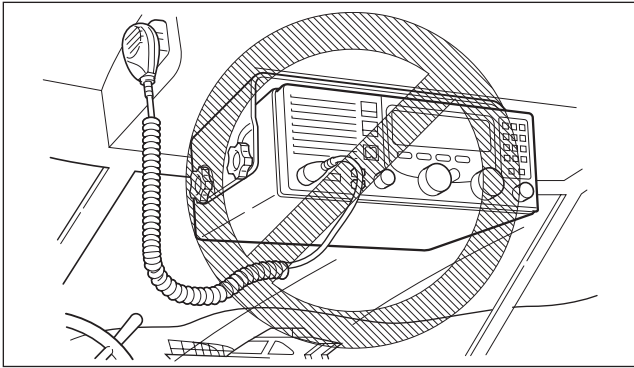

◇ Mounting location

Select a location that provides easy access to the front panel for navigation safety, has good ventilation and is not subject to sea spray. The face of the transceiver should be at 90 degrees to your line of sight when operating it.

⚠ CAUTION: KEEP the transceiver and microphone at least 1 meter away from your vessel's magnetic navigation compass.

Check the installation angle; the display may not be easy to read at some angles.

◇ Mounting example

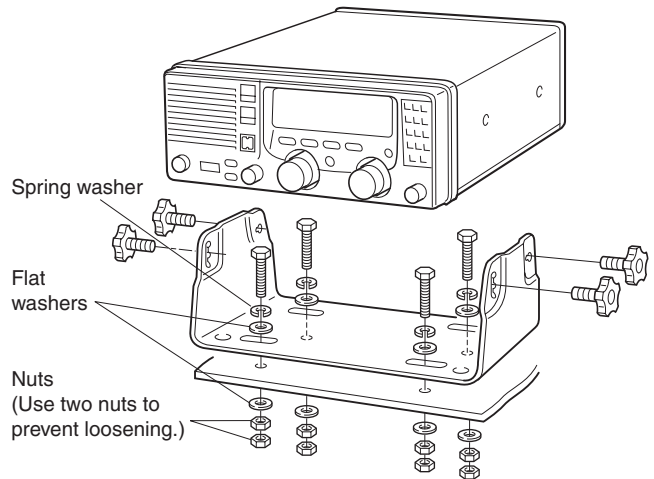
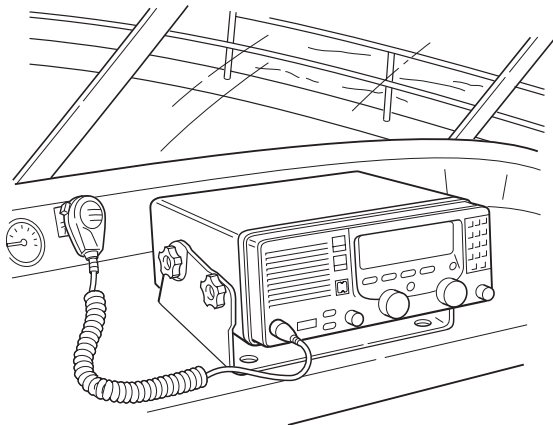

◇ Transceiver dimensions

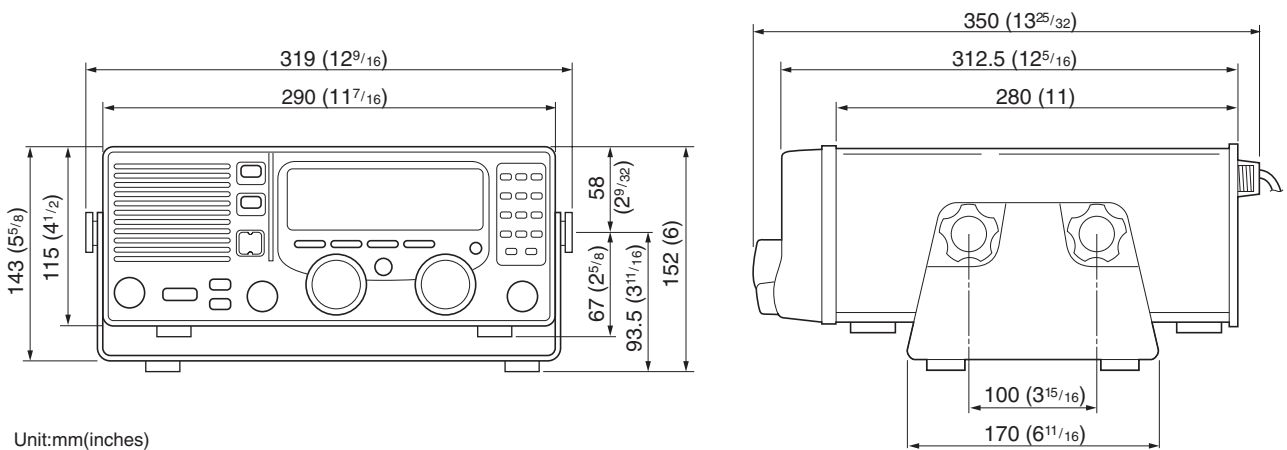

■ Installing the internal options

◇ Opening the case

Follow the case and cover opening procedures shown here when you want to install an option or adjust a setting for non-Icom tuner control.

- ① Remove the 9 screws from the rear panel, then remove the rear frame and rear sealing.
- ② Remove the transceiver case.
- ③ When reassembling the transceiver, check the following points:
 - Internal fan and slits in the case are on the same side.
 - Front sealing is mated correctly.
 - Rear sealing is attached in the proper orientation.
 - Screws are tightened securely.

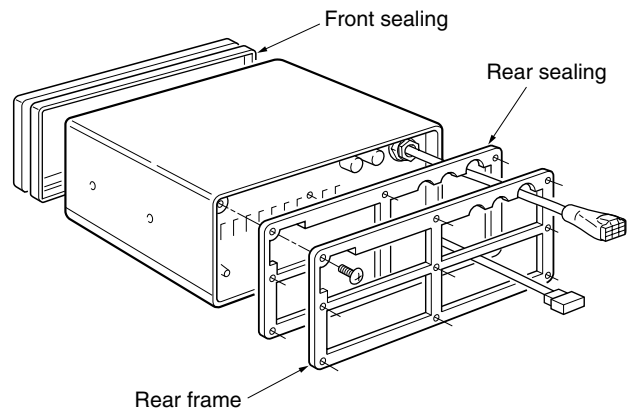

◇ Installing an optional filter

After opening the case as shown above, install the FL-100 CW/FSK NARROW FILTER to the position as shown at right.

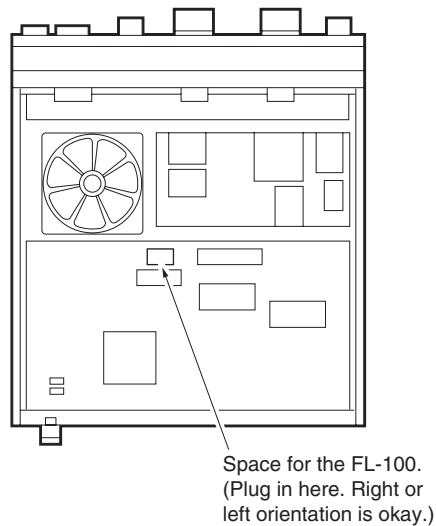

■ Fuse replacement

The transceiver has 3 fuses to protect internal circuitry; 2 fuses for the fuse holder on the rear panel and 1 for inside. If the transceiver stops functioning, check the fuses below.

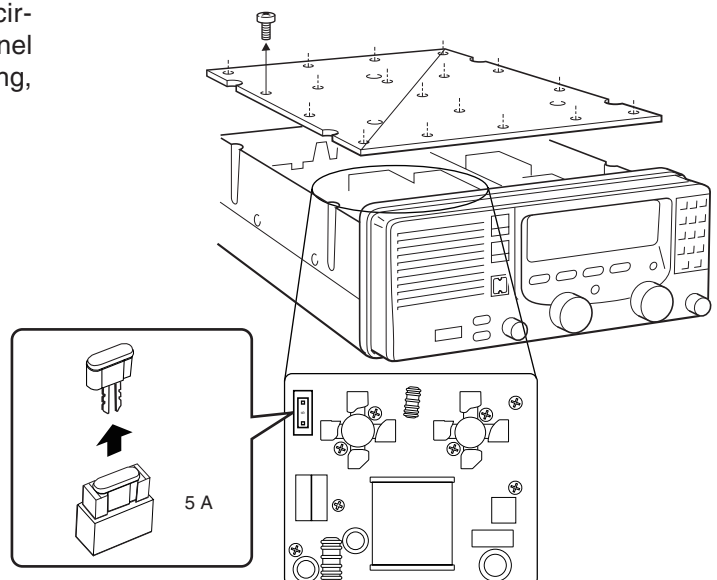
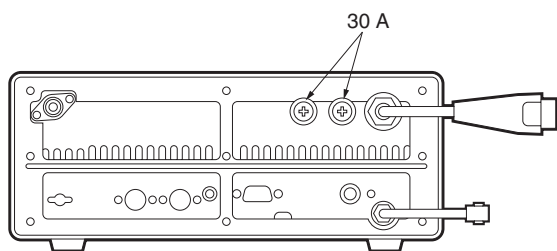

What appears to be equipment malfunction may not be damaging or difficult to solve. Check the following chart before making any adjustments or sending the transceiver to an Icom Service Center.

	PROBLEM	POSSIBLE CAUSE	SOLUTION	REF.
POWER	Power does not come ON when [POWER] is pushed.	<ul style="list-style-type: none"> Power cable is improperly connected. Blown fuse. 	<ul style="list-style-type: none"> Reconnect the cable securely. Check for cause, then repair the fuse with a proper spare one. 	p. 16 p. 22
	RECEIVE	No sound comes from the speaker.	<ul style="list-style-type: none"> The [SPEAKER] switch is turned OFF. Microphone is not connected. RF gain is set too deeply and several segments of the S-meter appear. The squelch is closed. 	<ul style="list-style-type: none"> Turn ON the [SPEAKER] switch. Connect the microphone to the [MICROPHONE] connector. Push [FUNC], then [RX] to reset the RF gain. (RF GAIN 9 applies audio.) Adjust the squelch to proper level or push [SQL] to turn it OFF to receive weak signals.
Sensitivity is too low and only strong signals are audible.		<ul style="list-style-type: none"> Antenna is not properly matched to the operating frequency. RF gain is set too deeply. Wrong tuner condition is selected in the set mode. 	<ul style="list-style-type: none"> Push [TUNE] to tune the using antenna tuner or select "automatic tuning" in the set mode when using an optional AT-130. Push [FUNC], then [RX] to reset the RF gain. Set the proper tuner for the connected tuner. 	p. 13 p. 10 p. 13
The received audio is unclear or distorted.		<ul style="list-style-type: none"> Wrong operating mode is selected. AGC is deactivated while receiving a strong signal. Noise blanker is turned ON when receiving a strong signal. The [CLARITY] control is rotated too far clockwise or counterclockwise. 	<ul style="list-style-type: none"> Push [MODE] to select the proper operating mode. Push [AGC] to activate the AGC function. Push [NB] to turn the noise blanker OFF. Adjust the [CLARITY] control to receive proper audio output. 	p. 9 p. 10 p. 10
TRANSMIT	Your signal does not reach as far away as usual.	<ul style="list-style-type: none"> The transmit power is set low. The antenna tuner is improperly matched to the operating frequency when manual tuning is selected. CW or FSK mode is selected for voice transmission. 	<ul style="list-style-type: none"> Push [FUNC], then [TX] to reset the transmit power. (RF-PWR 3 is maximum power.) Push [TUNE] to tune the using antenna tuner, or select "automatic tuning" in the set mode. Push [MODE] to select USB mode (or AM, R3E, etc.). 	p. 9 p. 9 or p. 13 p. 9
	Transmit signal is unclear or distorted.	<ul style="list-style-type: none"> The wrong operation mode is selected. Microphone is too close to your mouth. 	<ul style="list-style-type: none"> Push [MODE] to select the proper operating mode. Speak into the microphone naturally and do not hold the microphone too close to your mouth. 	p. 9 –
	No contact is possible with another station.	<ul style="list-style-type: none"> Wrong transmit frequency is set. 	<ul style="list-style-type: none"> Push [TX FREQ] to check and store the correct transmit frequency. 	p. 9
DISPLAY	Frequency cannot be set via the keypad.	<ul style="list-style-type: none"> The [CE] key is not pushed ("▶" does not appear) before digit entry. 2182 kHz is selected with the [2182KHz] switch. 	<ul style="list-style-type: none"> Push [CE] ("▶" appears), then enter the desired frequency. Push [2182KHz], then set the frequency. 	p. 8 p. 6
	All indicators appear and the channel number cannot be read.	<ul style="list-style-type: none"> The highest contrast is selected in the set mode. 	<ul style="list-style-type: none"> Set to the proper display contrast. 	p. 15
	FSK ITU channels cannot be selected.	<ul style="list-style-type: none"> SITOR operation is set to OFF in the set mode. 	<ul style="list-style-type: none"> Set "SITOR" to ON in the set mode. 	p. 13

■ Specifications

◇ GENERAL

- Frequency coverage:

Receive	500 kHz–29.999 MHz	
Transmit	1.6– 2.9999 MHz	4.0– 4.9999 MHz
	6.0– 6.9999 MHz	8.0– 8.9000 MHz
	12.0– 13.9999 MHz	16.0– 17.9999 MHz
	18.0– 19.9999 MHz	22.0– 22.9999 MHz
	25.0– 27.5000 MHz	
- Mode : J3E(USB), H3E, J2B(AFSK), F1B(FSK), R3E, A1A(CW)
(available modes differ with the version)
- Number of channels : 1136 (max.)
160 (user programmable)
242 (ITU SSB duplex), 72 (ITU SSB simplex)
662 (ITU FSK duplex)
- Antenna impedance : 50 Ω nominal
- Usable temp. range : –30°C to +60°C (–22°F to +140°F)
- Frequency stability : ±10 Hz
(–30°C to +60°C; –22°F to +140°F)
(±20 Hz above 15 MHz for General version)
- Power supply requirement : 13.6 V DC±15%
- Current drain : Transmit (max. output power) 30 A
: Receive (max. audio output) 2.5 A
- Dimensions : 291.4(W)×116.4(H)×315(D) mm
(projections not included) : 11.3(W)×4.4(H)×12.8(D) in
- Weight (approx.) : 7.8 kg; 17.4 lb

◇ TRANSMITTER

- Output power : 150, 60, 20 W PEP (selectable)
(60, 20 W only for 25 MHz band)
- Spurious emissions : –65 dB typical
- Carrier suppression : 40 dB typical
- Unwanted sideband suppression: 55 dB typical
- Microphone impedance : 600 Ω

◇ RECEIVER

- Sensitivity

J3E, R3E, J2B, F1B, A1A (for 12 dB SINAD)	: 0.5 μV (1.8–29.9999 MHz)
	1.0 μV (1.6–1.7999 MHz)
	6.3 μV (0.5–1.5999 MHz)
H3E (for 10 dB S/N)	: 3.2 μV (1.8–29.9999 MHz)
	6.3 μV (1.6–1.7999 MHz)
	32 μV (0.5–1.5999 MHz)
- Spurious response rejection : 70 dB typical
(1.6–29.9999 MHz)
- Audio output power : 4.5 W
(at 10% distortion with a 4 Ω load)
- Audio impedance : 4 Ω
(4 to 8 Ω acceptable)
- Clarity variable range : ±150 Hz

All stated specifications are subject to change without notice or obligation.

■ Options

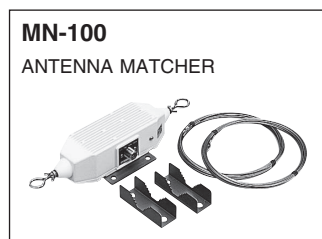

Matches the transceiver to a dipole antenna. Covers all HF bands from 1.5 to 30 MHz. 8 m (26 ft.) × 2 antenna wires are included.

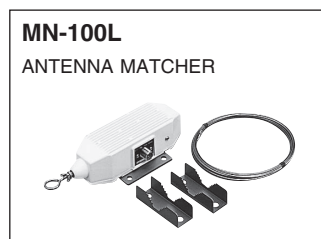

Matches the transceiver to a long wire antenna. Covers all HF bands from 1.5 to 30 MHz. 15 m (49 ft.) × 1 antenna wire are included.



Allows better receiver selectivity for CW and FSK. Bandwidth: 500 Hz/–6 dB

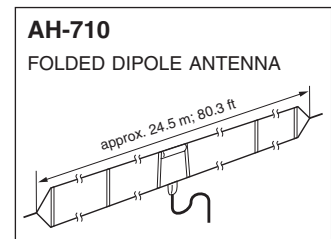

Covers from 1.9 to 30 MHz band. Has an SO-239 connector. Easy to assemble (non-kink construction).

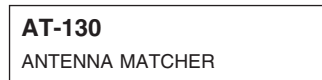

Matches the transceiver to a long wire antenna with a minimum of insertion loss.

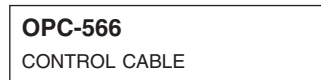

The optional control cable for AT-130.

Approved Icom optional equipment is designed for optimal performance when used with an Icom transceiver.

Icom is not responsible for the destruction or damage to an Icom transceiver in the event the Icom transceiver is used with equipment that is not manufactured or approved by Icom.

Count on us!

