

## **CONTENTS**

INTRODUCTION.....	1
FEATURES.....	1
SPECIFICATIONS.....	1-2
EXPLANATION OF FEATURES.....	3-5
INSTALLATION.....	6
BD-25 OPTIONAL ADAPTORS.....	7-8
PRECAUTIONS.....	9-10
CONNECTION DIAGRAMS.....	11-12
OPERATION.....	13
BD-25 BOOSTER AMP. BLOCK CIRCUIT.....	14
WARRANTY.....	15

## **INTRODUCTION**

The BD-25 is a dual band power linear amplifier designed for the 144/430 MHz band. It has a maximum output power of 30W.

The BD-25 incorporates a cross-band full duplex function that is the first of its kind in the industry. This compactly designed amplifier employs the new “two band/ one RF power transistor” technique.

The BD-25 is a remarkable and useful VHF/UHF dual band power amplifier.

## **FEATURES**

The transmitter amp section with a single RF power transistor which enables to cover both VHF and UHF bands.

## **SPECIFICATION**

FREQUENCY	: 144 MHz
MODE	: F3 (FM)
INPUT POWER	: 1-5W
OUTPUT POWER	: 50W
DC POWER SUPPLY	: DC 13.8V
CURRENT CONSUMPTION	: 8A (MAX.)
INPUT/OUTPUT IMPEDANCE	: 50 Ohm
INPUT/OUTPUT CONNECTOR	: M TYPE X 2

Accessory Circuits:

1. Automatic frequency selection controlled circuit.
2. Reverse DC power polarity protection circuit.
3. VHF/UHF 'On Air' indicator.

Semiconductor Components:

RF Power Transistor X 1, Transistors X 2, IC X1,  
Diodes X 8, LED X 5

Accessories:

1. Mobile mounting bracket
2. Spare FUSE (8A),
3. Instruction Manual
4. Docking adaptor.
5. Coaxial jumper cable (M-M).

Dimensions:

3.4(W)\*6.0(H)\*3.4(D)in

Weight:

Approx. 1.5 lbs.

**EXPLANATION OF FEATURES**

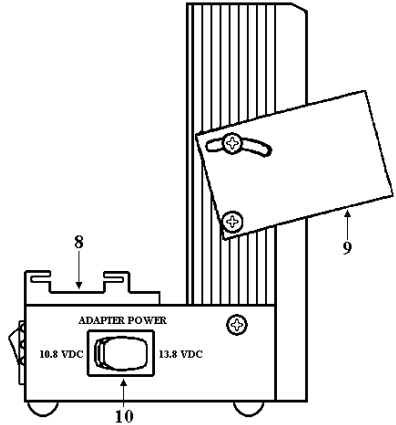
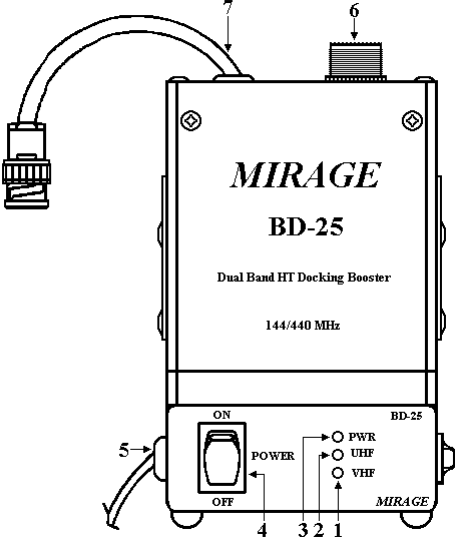

1. **VHF INDICATOR**  
The VHF Indicator LED indicates the amplifier is transmitting on the VHF Band.
2. **UHF INDICATOR**  
The UHF Indicator LED indicates the amplifier is transmitting on the UHF Band.
3. **PWR INDICATOR**  
The Power Indicator LED indicates the amplifier is ON and standing by to transmit.
4. **POWER SWITCH**  
ON (upper position): The amplifier is ready to transmit. (Max. 30W)  
OFF (lower position): The amplifier is on receive mode only.
5. **DC INPUT (13.8V)**  
This port has two wires. Connect it to a stable DC power supply (13.8V) or battery. The red wire has a fuse holder and is the positive lead. The black wire is the negative lead. (FUSE holder is on the positive DC lead.)

6.     **ANT**  
The antenna can be connected directly here. For duplex operation, use a dual band antenna (144/440 MHz) which is fine tuned on both bands. Two mono-band antennas can also be used by connecting them through a duplexer unit.
7.     **TX (RF INPUT)**  
This is a BNC connector that should be connected directly to the handy-transceiver.
8.     **DOCKING ADAPTOR**  
There are various adaptors suitable for different models of handy-transceivers.
9.     **MOUNTING BRACKET**  
The mounting bracket allows easy attachment of your BD-25 to your car.
10.    **ADAPTER POWER SWITCH**  
The adaptor power can be turned OFF (middle position) when the amplifier is not in use. You can select the adaptor to be 10.8V (left position) for new HT models or 13.8V (right position) for older models depending on your HT.

**INSTALLATION**

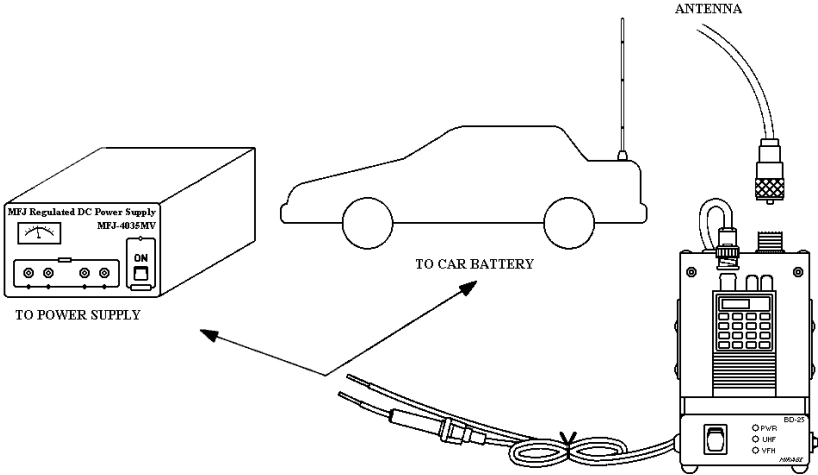

## BD-25 OPTIONAL ADAPTORS

HAM RADIO MAKER	ADAPTOR MODEL	COMPATIBLE TRANSCEIVER MODEL NO.
ICOM	MI-1	IC-2N, 02N, 3N, 03N, 12N, 2G, 3G, 12G, 23, etc.
ICOM	MI-2	IC-2S, 2SAT, 2SR, 3S, 3SAT, 3SR, 24, W2, X2, etc.
ICOM	MI-3	IC-W21, X21, W21T, X21T etc.
ICOM	MI-4	IC-T22, T42
YAESU	MY-1	FT-23, 204, 73, 704, 104, 728, etc.
YAESU	MY-2	FT-24, 74, 205, 705, 305, 805, 729, etc.
YAESU	MY-3	FT-11
YAESU	MY-4	FT-50
KENWOOD	MK-1	TH-25, 25G, 45, 45G, 55, 75, 77, etc.
KENWOOD	MK-2	TH-22A, 22AT, 42A, 42AT, 59, 79, 79E, etc.
STANDARD	MS-1	C150, C450, C520, C550, 620, etc.

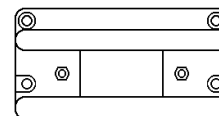

**B-24-G**

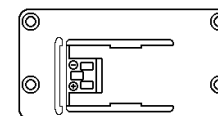

**MY-2**

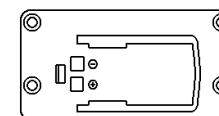

**MI-3**

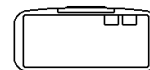

**MK-2**

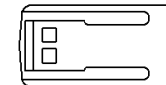

**MY-1**

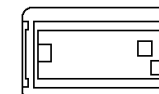

**MS-1**

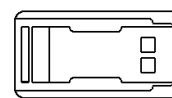

**MK-1**

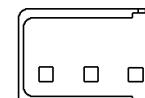

**MI-2**

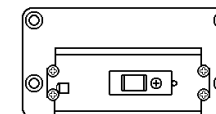

**MI-1**



### ADAPTORS and ADAPTOR POWER SETTING

HAM RADIO MAKER	ADAPTOR MODEL	ADAPTOR POWER SETTING
ICOM	MI-1	13.8
ICOM	MI-2	13.8
ICOM	MI-3	13.8
ICOM	MI-4	10.8
YAESU	MY-1	10.8
YAESU	MY-2	13.8
YAESU	MY-3	10.8
YAESU	MY-4	10.8
KENWOOD	MK-1	10.8
KENWOOD	MK-2	10.8
STANDARD	MS-1	13.8

## **PRECAUTIONS**

To avoid malfunctions and damages, and to achieve full performance, please pay careful attention to the following matters:

1. During transmission, the heat sink may reach a high temperature (approx. 50°C-80°C). Set the amplifier in a well-ventilated place. Do not place objects on top of the amplifier. Do not operate the amp in places exposed to direct sunlight or close to a heater, etc.
2. If the antenna matching condition is poor (or the SWR is high), please try to lower the SWR. This is also important to ensure the efficient transmitting of output power from the antenna. Also, check make sure the antenna is properly connected and there is no short or open before operation.
3. Keep the input power at 5W or less.
4. Be careful that the DC voltage is kept below 13.8V (12-14V). The amplifier could be damaged if connected to a DC 24V battery (for truck use) or AC power source.
5. Never connect the whip antenna of a handy-transceiver directly to the antenna connector of the amplifier unit using M-BNC converting connector etc. It may cause damage to the antenna due to insufficient power capacity. It may also damage the transceiver or the amplifier when strong RF signal intrusions occur.

6. When utilizing a mono band antenna, check before operation that the antenna is identical with the transceiver operating frequency. When inserting the coaxial switch to either or both of the input and output sides of the amplifier unit in order to operate two sets of transceivers and antennas which have different frequencies, carefully check the position of the coaxial switch.
7. Be sure to use a  $50\Omega$  coaxial cable for the various connections. When the impedance differs as with a  $75\Omega$  cable, reflected waves will cause a mis-match. This condition makes it difficult to achieve full power from the amplifier and it may cause the RF power transistor to be damaged.
8. When using a stabilized DC power supply, the output voltage may rise to an abnormal level due to RF signal intrusions. Therefore, use a power supply with sufficient current capacity (7A or more) as well as a good protective device for RF intrusions. If the power supply malfunctions, discontinue operation by turning off the power switch and make sure the connection of the amplifier to the power supply is correct (a diagram is shown on the following page).
9. The cord may be burned if the power supply is connected in reverse polarity, especially if the power source is a battery. Check the polarity well before connection. The interior of this amplifier is protected from a reverse polarity connection by a protection circuit.

## CONNECTION DIAGRAM

### Diagram 1

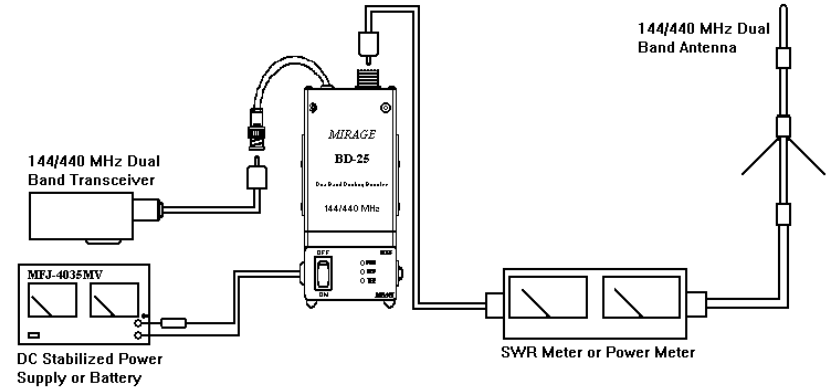

### Diagram 2

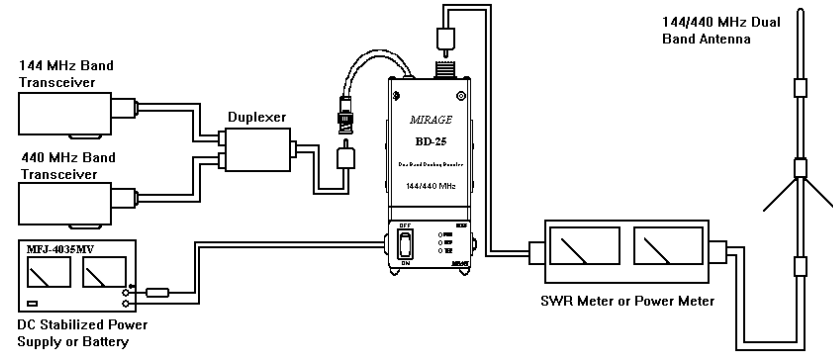

**Diagram 3**

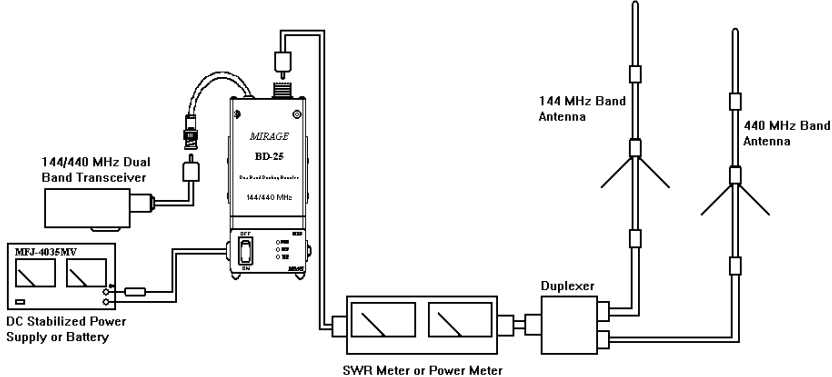

## **OPERATION**

1. Turn the power switch on.
2. When switching to 144 MHz band (or 440 MHz band) transmitting mode, the power amplifier of this unit will operate and a high power signal is sent out through the antenna. Re-confirm the SWR and power at this time by checking a SWR or power meter. Also, the band switching of the transmission amp is automatically operated by detecting the transmitting signal frequency of the transceiver.
3. During 144 MHz band/440 MHz band crossband full duplex operation, there may be some minor interference such as noise trouble in some reception frequency spots depending on the combination of TX/RX frequencies. Select TX/RX frequencies that show no interference or trouble. Especially in the 144 MHz band transmission and 440 MHz band reception, select frequencies that are not mutually harmonic.

# BD-25 BOOSTER AMP. BLOCK CIRCUIT

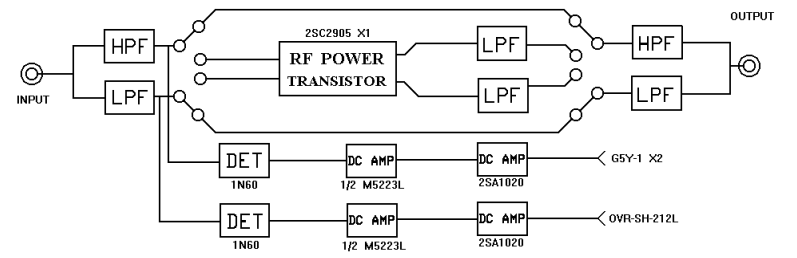

# MIRAGE

## COMMUNICATION EQUIPMENT

300 Industrial Park Road  
Starkville, MS 39759 USA  
Tel: (601) 323-8287  
FAX: (601) 323-6551

### ONE YEAR LIMITED WARRANTY

Any Mirage Communications product found to be defective in materials or workmanship will be repaired or replaced (at Mirage's option) for a period of one year from the date of original purchase.

During the warranty period Mirage Communications will provide, free of charge, both parts and labor necessary to correct defects in material or workmanship.

- To obtain such warranty service, the original purchaser must:
  - (1) Provide "proof of purchase"
  - (2) Ship the product in its original container or equivalent, fully insured and shipping charges prepaid, to Mirage, as addressed below.
- All internal adjustments are factory set for best performance consistent with reliable operation. Changing internal adjustments may void this warranty.
- Improper maintenance or repair may also void this one year warranty. We recommend that units requiring repair during the warranty period be returned to the factory.
- This unit was not designed for repeater operation, and its use in such service is at your own risk.
- Mirage assumes no responsibility for any item connected to or used in conjunction with this product.
- The foregoing constitutes Mirage's entire obligation with respect to this product and the original purchaser and any user or owner shall have no remedy and no claim for incidental or consequential damages.
- All Mirage products to be serviced, in-warranty or out-of-warranty, should be shipped, freight paid to: **Mirage, 921 Louisville Road, Starkville, MS 39759, USA.** Product must be accompanied by a letter describing the problem in detail. Be sure to include **YOUR NAME, ADDRESS, AND TELEPHONE NUMBER!**
- This warranty gives specific legal rights and you may also have other rights which vary from state to state.

**WARNING:** This unit should not be operated with the cover removed. The cover confines RF radiation. The harmonic filters contained in the circuit will not suppress direct radiation that may result if the cover is removed.