

KENWOOD

Operating Manual

Model TS-700S



CONTENTS

	SPECIFICATIONS	3
SECTION 1.	FEATURES	4
SECTION 2.	INSTALLATION	5
	2-1. Accessories	
	2-2. Operating Location	
	2-3. Power Supply Connection	
	2-4. Antenna Connection	
	2-5. Microphone	
	2-6. Sending Key	
	2-7. External Speaker	
	2-8. MIC Hook	
SECTION 3.	OPERATING CONTROLS	7
	3-1. Front Panel Controls	
	3-2. Inside Knob	
	3-3. Rear Panel Controls	
SECTION 4.	OPERATING INSTRUCTIONS	11
	4-1. Reception	
	4-2. Transmission	
	4-3. How to Use R-DX (Receive Booster) Switch	
	4-4. How to Use RIT Switch	
	4-5. How to Use NB Switch	
	4-6. How to Use RF Gain Knob	
	4-7. How to Use Low Power Switch	
	4-8. How to Read Operating Frequencies	
	4-9. How to Use Sub-Dial	
	4-10. How to Use Display Pull/7-Digit (FM) Switch	
	4-11. VOX Operation	
	4-12. Semi-Break-In Operation	
	4-13. Operation With Fixed Channel	
	4-14. Mobile Operation With External DC Power Supply	
	4-15. Repeater Operation	
	4-16. OSCAR (Artificial Satellite) Operation	
SECTION 5.	BLOCK DIAGRAM	19
SECTION 6.	ACCESSORIES	21
	6-1. Accessories	
	6-2. How to Connect VFO-700S	
SECTION 7.	ALIGNMENT	22
SECTION 8.	TROUBLESHOOTING	23
	TOP & BOTTOM VIEW	25

SPECIFICATIONS

GENERAL

Frequency Range:	144.0 to 146.0 MHz
Mode	SSB (USB, LSB), CW, AM, FM
Antenna Impedance	50 Ohms
Frequency Stability	Within ± 2 kHz during one hour after one minute of Warm-up, and within 150 kHz during any 30 minute period thereafter.
Semiconductors	Transistors: 102 FETs: 18 ICs: 21 Diodes: 162
Power Requirement	120/220V AC, 50/60 Hz: 12.0 to 16.0V DC (nominal 13.8V DC)
Power Consumption	Transmit: 98 Watts (120/220V AC), 4.0A (13.8V DC) Receive (no signal): 48 Watts (120/220V AC), 1.2A (13.8V DC)
Dimension	278 wide x 124 high x 320 deep mm
Weight	11.0 kg

TRANSMITTER

RF Output Power	SSB, FM, CW: 10 Watts AM: 3 Watts FM (Low): Approx. 1 Watt
Modulation	SSB: Balanced modulation FM: Variable reactance frequency shift AM: Low power modulation
Maximum Frequency Deviation (FM)	± 5 kHz
Carrier Suppression	Better than 40 dB
Sideband Suppression	Better than 40 dB
Spurious Radiation	Better than -60 dB
Microphone	Low impedance microphone (500 Ohms)
AF Response	400 to 2,600 Hz
Repeater Frequency Shift	600 kHz
RPT Tone Frequency	1,750 Hz

RECEIVER

Sensitivity	SSB and CW: 0.25 μ V for 10 dB (S+N)/N AM: 1.0 μ V for 10 dB (S+N)/N FM: 0.4 μ V for 20 dB noise quieting 1.0 μ V for 30 dB (S+N)/N
Intermediate Frequency	SSB, CW and AM: 10.7 MHz FM: 1st 10.7 MHz, 2nd 455 kHz
Selectivity	SSB, CW and AM: 2.4 kHz/-6 dB, 4.8 kHz/-60 dB FM: 12 kHz/-6 dB, 24 kHz/-60 dB
Image Ratio	Better than 70 dB
IF Rejection	Better than 70 dB
Squelch Sensitivity	0.25 μ V
AF Output Power	2 Watts/8 Ohms load, with less than 10% distortion
AF Output Impedance	8 Ohms

The above specifications are subject to change without notice for improvement.

SECTION 1. FEATURES

1. The Model TS-700S is a fully solid-state, all-mode amateur band transceiver designed to provide high quality communications on SSB, FM, AM and CW bands.
2. A built-in digital frequency display for all modes of operation provides features:
 - Direct frequency reading as precise as an order of 100 Hz in seven digits.
 - Green fluorescent digital display tubes.
 - Readable of change of the carrier when the operating mode is switched.
 - A display select circuit that automatically clears the 100 Hz digit in the FM mode of operation.
 - Displaying a remote VFO frequency as well as fixed channel frequency.
3. Basically engineered for fixed station operation but is also used for mobile station operation because of the employment of AC/DC two-way power system.
4. The single and doubleconversion type transceiver incorporates its own built-in VFO that continuously covers the frequency range of 144.00 to 146.00 MHz in 2 bands. Repeater operation is also possible in the 145 MHz band. The repeater frequency is shifted at both NORMAL and REVERSE positions of the repeater knob.
5. A newly developed two-speed dial mechanism facilitates tuning: MAIN TUNING knob (inner) for closer tuning covers a change of 25 kHz by one complete rotation, and QUICK TUNING knob (outer) covers a change of 100 kHz similarly. You can tune in quickly with pin-point accuracy. This feature is very useful in receiving SSB signals.
6. A total of 44 fixed channels (11 channels for each band) for all-mode operation including repeater operation. All the necessary crystal oscillator elements are available as optional accessories.
7. A noise blanker (NB) circuit of the type normally found in many other HF products of our make is included to eliminate pulse noise such as ignition noise.
8. For improved FM-mode operation, a squelch circuit combined with a noise detector circuit and Schmidt circuit is added to the FM unit.
9. A tuner which uses a voltage variable capacitor is built in the receiver RE stage to minimize cross-talk and spurious interference, and a high "Q" tuning circuit in the antenna input stage for excellent selectivity.
10. A balanced-type mixer circuit based on the use of field effect transistors (FET) is adopted for the pre-mixer and heterodyne mixer to assure improved rejection of spurious signals during transmission.
11. The repeater frequency for transmission or reception can be inverted (NORMAL — REVERSE) with one finger action. Turning the TONE switch to ON operates a tone oscillator at 1750 Hz, and at the same time, a repeater call signal is automatically transmitted.
12. The IF stage includes a 6-element crystal filter. The built-in narrow band ceramic filters provide outstanding selectivity during FM reception.
13. The employment of threshold type RF gain control assures excellent S/N ratio at all times during reception of SSB signals.
14. Speaker output is free from distortion because of the use of amplification type AGC circuit. Signals transmitted are accompanied by little or no splutter and free from distortion thanks to the adoption of ALC circuit. The AGC circuit comprises such time-constant element that this constant is "slow" in SSB mode but "fast" in FM, AM or CW mode.
15. The unique "S" meter (patent pending) provides accurate without causing "scale-out" even when unusually strong FM signal comes in. By manipulating the center meter switch, this meter functions as a center meter for pin-point tuning of FM stations.
16. A low power selector that is convenient for local communications and adjustments.
17. A built-in side tone allows you to operate in a semi-break-in mode with CW.
18. The transceiver operates on AC 120/220V or on DC 13.8V. It includes DC voltage multiplier of our own development, contributing much to the space-saving design of the model.
19. A built-in VOX. VOX operation is also available.
20. For assuring easier access to the internals, the transceiver enclosure or case is in two parts, complete with special mechanical details to allow the front control panel to be detached. The final unit is also arranged so that it can be removed from the rear panel.
21. A highly advanced and comprehensive operation is possible with use of the remote VFO-700S (optional).

SECTION 2. INSTALLATION

2-1. ACCESSORIES

The Model TS-700S transceiver is supplied with the following accessories. After unpacking, check the accessories against the list:

Operating manual	1
RCA plug connector.....	2
Feet with screws	2
Fuse: 1A (AC 220V).....	1
2A (AC 120V).....	1
2A (DC 20V).....	1
5A (DC cord).....	1
Microphone with hook, 500 ohm	1
AC power cord with connector.....	1
DC power cord with connector.....	1
VFO plug (installed).....	1
Speaker plug	1

2-2. OPERATING LOCATION

As with any solid-state electronic equipment, the place of use must be discriminated with the TS-700S, in order to avoid subjecting to extremes of ambient conditions.

A well-ventilated, dry place, where the transceiver will not be exposed to direct sunlight, should be selected. The TS-700S has a heat sink in its rear panel; be sure to install the transceiver so that there is a proper clearance at the rear and bottom. For better heat dissipation, keep it away from a wall. This precaution also applies when the transceiver is operated on the companion's seat in a car.

When you wish to use the transceiver in a car, you may put it on the seat but sure to secure some heat dissipating clearance under and behind it and to make proper provisions for protecting it against shocks.

2-3. POWER SUPPLY CONNECTION

The TS-700S is designed to operate on AC 120/220 V or DC 13.8 V. Switching between AC and DC is accomplished by replacing the power cord. The DC power cord is color coded (red for "+" and black for "-"). When connecting power cord, be sure to observe the following points:

1. Turn off the power switch and set the standby switch to REC position.
2. When replacing power cord, disconnect it from the AC socket (or battery). Care should be used to prevent electrical shocks when connecting the AC power cord. Each power cord is equipped with a 4-P plug complete with a stopper. When inserting the plug to the transceiver, be sure to press down the stopper with your finger and engage it into the latch on the transceiver side.

To pull the cord off the transceiver, push down the stopper to disengage it from the latch and then give a pull to the cord end. (See Fig. 1)

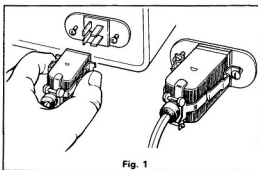

Fig. 1

2-4. ANTENNA CONNECTION

To ensure maximum enjoyment of QSO, the use of a good antenna is important. A standard ground-plane antenna or a Yagi antenna will give you best results. This antenna should be set up about 10 to 20 meters high and a coaxial cable connected to the antenna terminal of your transceiver.

When communicating with a far-away station or with a particular station, the use of a high gain, directional Yagi antenna is recommended. For local communications, use a non-directional antenna.

2-5. MICROPHONE

The microphone supplied with this transceiver is a 500-ohm impedance one designed specially for radio equipment of this class. Any other microphone may be used provided that its type and characteristic are suited to the transceiver. The optimum impedance of a microphone is anywhere between 500 and 600 ohms. For connection of microphone, refer to Fig. 2 and Fig. 3.

2-6. SENDING KEY

For CW operation, connect a sending key device to the KEY jack at the rear of the transceiver. CW mode is defeated by manipulating the mode switch, allowing you to operate in SSB, AM or FM mode. (When using an electric keyer, make sure its polarities.)

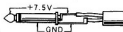

When using an electric keyer, make sure its polarities.

2-7. EXTERNAL SPEAKER

A small sized speaker is built in TS-700S. If you wish to use an external speaker, connect it to the EXT SP jack at the rear of the transceiver by using the supplied speaker plug.

It is recommended that a speaker rated at 8 ohms of impedance and whose low and high ranges are sharply cut off be used for this purpose. Plugging in an external speaker cord will automatically cut the built-in speaker out of service.

When connecting an external speaker, be careful not to short the AF output and try to minimize the length of the cord, which should preferably be of shielded type, so as to prevent radio-frequency energy from reaching the speaker through the ground.

2-8. MIC HOOK

Attach a microphone hook to the case following the instructions give in fig. 4. The hook is furnished with the equipment.

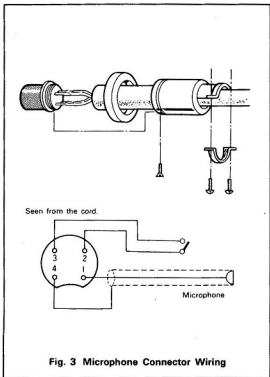
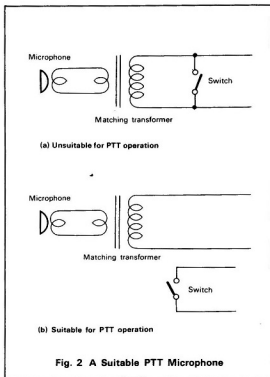
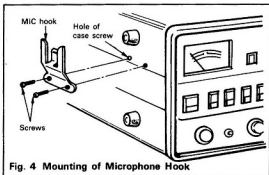

SECTION 3. OPERATING CONTROLS

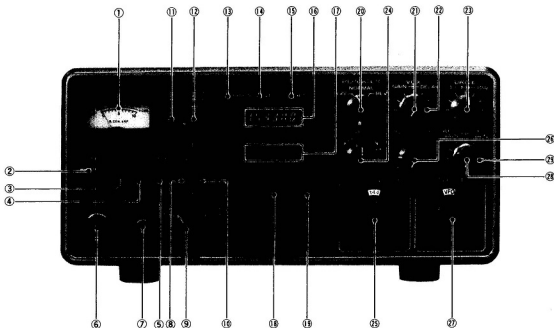

3-1. FRONT PANEL CONTROLS

① METER

This meter has three functions. During reception, it serves as an "S" meter indicating the strength of received signal on a scale graduated from 1 to 9, $9 + 20\text{dB}$ and $9 + 40\text{dB}$. During transmission, the meter indicates the strength of RF output signal.

The meter also functions as a center meter during FM reception when the METER switch is set to the CEN position.

② POWER SWITCH

The power to the transceiver is turned on by flipping the power switch to the up position, and turned off at the down position.

③ STANDBY SWITCH

This is a 2-position switch the SEND position is for transmission and the REC position for reception. With the switch in the REC position, the transceiver automatically shifts from receiving mode to transmitting mode if the microphone PTT switch is set to ON. Do not leave the transceiver in transmitting mode when the transmitting circuit is out of adjustment.

④ METER SWITCH

By manipulating this switch during FM reception, the meter functions as an "S" meter or a center meter. In other receiving modes, the meter functions as "S" meter regardless of the position of the switch.

⑤ NB (noise blanker) Switch

Turning on this switch will suppress pulse type noises due to ignition systems of nearby cars. Noiseless audio output can be obtained even when receiving signals are weak.

In case of FM operation, this switch is sometimes used together with the R-DX SWITCH (18) to lighten the booster's effect.

⑥ MICROPHONE JACK

For connection of microphone. This jack has terminals for both microphone input and PTT circuit.

⑦ PHONES JACK

For connection of headphone with impedance of 8 to 16 ohms. Plugging the headphone will shut off the speaker.

⑧ RIT SWITCH

For on-off control of the RIT (receiver incremental tuning) circuit.

⑨ MODE SWITCH

By using this switch, any of the following five modes can be selected:

CW (sending key):

Morse-code telegraphic communications (A1)

FM (frequency modulation):

Communications with FM waves (F3)

USB (upper side band):

Communications with "upper side band" waves. For operation in 144 MHz 2-meter band, the international practice calls for the use of USB (A3J).

LSB (lower side band):

Communications with "lower side band" waves (A3J).

AM (amplitude modulation):

Communications with AM waves (A3). Reception of LSB or USB signals in AM mode results in unintelligible wow-like audio output.

⑬ R-DX SWITCH

This switch turns the receive booster on or off.

⑭ LOW POWER SWITCH

This switch, when pressed in, reduces the FM transmit power to around 1W.

⑮ TONE SWITCH

Tone oscillator switch which makes 1750 Hz FM wave when pressed in FM mode only.

⑯ ON AIR INDICATOR

This indicator keeps lighting while the transceiver is in transmitting mode.

⑰ VFO INDICATOR

This indicator lights while the VFO is in operation.

⑱ RIT INDICATOR

This indicator remains on to indicate that the RIT circuit is operating.

⑲ DIGITAL DISPLAY

This display shows the transmit and receive frequencies. It will not light if there are no crystals inserted in position. Accordingly, this is available as an indicator of the presence of the crystals.

⑳ SUB-DIAL

The dial scale is graduated from 0 to 1000, covering a width of 1 MHz. Each graduated interval is 100 kHz. The rotation ratio of two knobs is such that the whole 0-1000 range is covered when the MAIN knob is rotated 40 times or when the COARSE knob is rotated 10 times.

㉑ MAIN TUNING KNOB (inner)

For setting the transceiver to the desired operating frequency. One rotation of this knob changes the frequency by 25 kHz.

㉒ COARSE TUNING KNOB

Another name of this knob is the "fast-change" tuning knob. The gear ratio in the mechanical link between this knob and VFO is so small that you can quickly locate your desired frequency. One rotation of the knob corresponds to a change of 100 kHz.

㉓ REPEATER KNOB

Repeater operation is effected simply by manipulating the repeater knob. Since frequency shifts for proper transmission and reception can be achieved according to the positions of the knob, it is possible to communicate through any type of repeater station (refer to paragraph "Repeater Operation").

Note: When the repeater knob is in the NORMAL or REV position, be sure to set the TONE switch to ON and the MODE switch to FM- otherwise, tone signal will not be generated.

㉔ VOX GAIN/OFF KNOB

This knob switches for VOX operation on and controls the VOX gain. To switch the operation off, turn the knob fully counterclockwise.

㉕ VOX DELAY KNOB

In VOX operation, this knob adjusts the time constant in which the transmit mode is returned to the receive mode.

㉖ DRIVE KNOB

This knob adjusts the electronic tuning circuit for tuning the output of the HET mixer during transmission.

㉗ RIT KNOB

This knob is used to fine adjust the receiving frequency when the RIT circuit is ON.

It adjusts the receive frequency without changing the transmit frequency. Here's how to use this control: index the pointer of this control to RIT "O" on the panel face. This will introduce coincidence between transmit frequency and receive frequency. Check the frequency of the other party if the checked frequency is deviated from yours, shift the receive frequency (without regard to transmit frequency) by about ± 2 kHz to match it to that of the other party. The RIT circuit is operative even when VFO or any of the fixed oscillator channels is in service.

㉘ BAND SWITCH

For selecting the frequency band at which the transceiver is to be operated. Two selective bands, 1 MHz wide, are provided for all amateur bands in the range from 144 MHz to 146 MHz.

25 SQUELCH Knob

Turning this knob clockwise during FM mode of operation will set SQUELCH to ON. This knob is normally turned clockwise so that the internally induced noise can be eliminated.

26 FIX CH SWITCH

For selecting VFO and fixed channels. There are 11 fixed channels in each band (a total of 22 channels in 2 bands). The fractions of oscillating frequencies of the crystal elements in these 2 bands remain the same: for instance, the operating frequency of 144.48 MHz in the 144 MHz band changes to 145.48 MHz in the 145 MHz bands respectively. The fixed channels can also be used for repeater operation.

28 AF GAIN KNOB (INNER)

This adjusts the gain of the receiving audio amplifier. A clockwise turn of the knob will increase the audio output.

29 RF GAIN KNOB (OUTER)

For adjusting the gain of the RF amplifier in the receiver section. With this control turned to extreme clockwise position, the gain is maximized, and vice versa. The "S" meter indicates the gain set by this control. If the pointer of the "S" Meter is at "9", then radio waves of lower than "9" level will be attenuated. This feature emphasizes the wanted signal and suppresses the unwanted signal to produce a clear output. The RF gain can be directly read on the "S" meter.

3-2. INSIDE KNOB

① SPEAKER TERMINAL

For connection of the internal speaker.

② SSB MIC GAIN KNOB/PULL 7 DIGIT (FM)

This knob is used to adjust the microphone gain in SSB modes. In general, set it to the mid position. The knob, when pulled out, turns off the digit 7 of 100 Hz order at the digital display on the front panel in the FM mode only. In other than the FM mode, the digit 7 will not go off even with pulling the knob out. The knob was preset "in" at the factory so that the display may be in six digits for the FM mode.

③ AM CAR KNOB

This knob adjusts the AM transmit carrier level.

④ FM MIC GAIN KNOB

This knob adjusts the FM transmit microphone gain.

⑤ ANTI VOX KNOB

In use of the VOX, this knob adjusts the anti-VOX gain.

⑥ SIDE TONE KNOB

In the CW mode, this knob adjusts the side tone volume for monitoring.

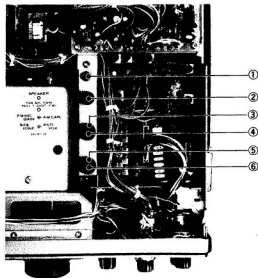

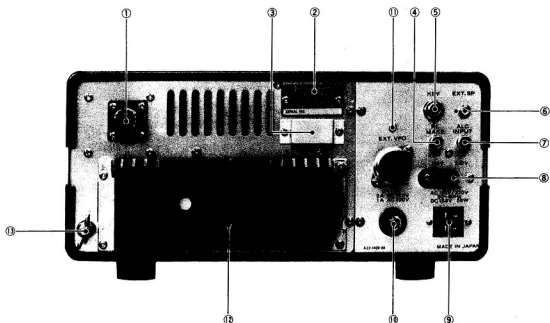

3-3. REAR PANEL CONTROLS

① ANT TERMINAL

For connection of antenna.

② NAME PLATE

TS-700S serial number is marked on this plate.

③ TRANSISTOR PROTECTIVE COVER

The transistors in the AVR circuit for 11V and 20V lines are protected by this cover. The cover also functions as a heat sink for the transistors.

④ RL-MAKE TERMINAL (RELAY TERMINAL)

This terminal should be OFF during reception, and should be grounded during transmission.

⑤ KEY JACK

This jack is used for operating the transceiver in CW mode. Connect an external telegraphic key device.

⑥ EXT SP TERMINAL

For connection of an external speaker.

⑦ ALC-INPUT TERMINAL

External ALC terminal.

⑧ AC POWER SELECT SWITCH

Set this switch to your local AC voltage, 120V or 220V. When the setting position of the switch is to be changed, make sure to replace the fuse with a proper type fuse. (120V → 2A, 220V → 1A)

⑨ POWER CORD JACK

For connection of the supplied AC power cord (or DC power cord).

⑩ AC FUSE HOLDER

For AC power fuse (primary), 120V/2A or 220V/1A.

⑪ EXT VFO CONNECTOR

For connection of a remote VFO, for example, the VFO-700S (optional). When the VFO is not in use, be sure to keep the 9-pin MT plug inserted in the connector. **If not, the TS-700S will not work both for the transmit and receive operations.**

⑫ HEAT SINK (FOR TRANSMITTER FINAL STAGE)

For protection of transistors from overheating.

⑬ GROUNDING

To prevent electric shocks, TVI and BCI, be sure to wire the TS-700S to a good earth for effective grounding. Use a grounding wire as thick and short as possible. Bury a grounding electrode such as copper rod or plate available on the market into the ground as deep as possible. Long grounding wire could transmit undesired waves. Be careful!

SECTION 4. OPERATING INSTRUCTIONS

4-1. RECEPTION

After connecting the power cord, antenna, microphone, key device, etc., set controls and knobs by following Table 1.

First, turn the POWER switch to ON. The pilot lamps in the meter, sub-dial pointer, band switch and FIX CH switch will all light up, indicating that the transceiver is ready for operation. Because of solid-state design, the transceiver can be put into operation immediately after the POWER switch is ON.

Next, adjust the controls and knobs according to Table 2.

Table 1. Front Panel

POWER Switch	OFF
Standby Switch	REC
METER Switch	S
NB Switch	OFF
RIT Switch	OFF
R-DX Switch	OFF
MODE Switch	CW, FM, USB, LSB, or AM
REPEATER Knob	OFF
RIT Knob	O
VOX Knob	Fully counterclockwise
SQUELCH Knob	Fully counterclockwise
DRIVE Knob	Center position
RF GAIN Knob	Fully clockwise
AF GAIN Knob	Fully counterclockwise
BAND Switch	Desired receiving band
FIX CH Switch	VFO
TONE Switch	OFF

The foregoing techniques are common to all modes of operation. Each mode, however, calls for special techniques of its own. Such special techniques will be discussed for each of the five modes.

CW Mode (How to use RIT)

With RIT switch turned off, position MAIN DIAL in such a way that the incoming CW signal will beat at 900 Hz. Under this condition, you can "zero in" your operating frequency to the frequency of incoming CW signal (see Note).

Similarly, if the other party calls back with 900 Hz beat tone, in response to your call signal, it means that the transceiver of the other party is in "zero in" status. Should the other party call back with a beat tone off 900 Hz or should you want to communicate with a beat frequency of your choice, turn on RIT switch and adjust RIT knob to obtain the desired beat.

Table 2

Controls and Knobs	Adjustment and Setting
AF GAIN	* Turn clockwise for suitable volume.
MODE (CW, FM, USB, LSB, AM)	* Set at the desired mode.
MAIN TUNING Knob	* Turn slowly and set for clearest signal.
DRIVE (Use band marks as easy guide.)	* Adjust for maximum deflection of meter.
RF GAIN	* Normally, this knob is set at the extreme clockwise position. When the signal is very strong, turn it counterclockwise for suitable gain.
SQUELCH	* This is used for FM mode of operation. Turn the knob clockwise so that noise at no-signal time disappears. This knob is normally set at a position where noise just disappears.
RIT	* With the RIT switch ON, turn the knob in either direction and only the receive frequency will be varied. Refer to paragraph "How to Use RIT".

Note: The term "zero in" means that your transmit frequency perfectly coincides with the transmit frequency of the other party.

FM Mode

Set the MAIN dial for optimum reception. By setting the METER switch to the CEN position, the meter functions as a center meter (center frequency indicated). Turn the MAIN dial until the center meter pointer may deflect up to the center spaced on the scale line, while receiving the other party's signal. In this way, the transmit frequency will coincide with the receive frequency.

Next, set the METER switch to the S position and the meter will indicate the strength of the incoming signal. If, in this case, the meter pointer fluctuates in response to the sound in the speaker, turn the MAIN dial a little (a few kHz) in either direction until the meter indication is stabilized (meter is stabilized if no fading exists).

Since the TS-700S is so designed that the IF circuit for SSB forms a part of the "S" meter indication circuit for FM, the "S" provides logarithmic indications for FM waves and is free from saturation even when the input signal strength is very high, thus eliminating the need for calibration for each mode of operation.

Since the IF band is wide in FM mode, a slight deviation of frequency does not affect the reception. In transmitting operation, however, the other party could be using a fixed channel. Because of this possibility, it is advisable that you "zero in" your frequency to that of the other party by properly adjusting the MAIN dial in the manner that the center meter pointer may deflect up to the center space.

If the "S" meter continues to fluctuate or if satisfactory audio output is not available, it is very likely that the other party is sending the message on SSB. You can easily check this by turning the MODE switch to USB or LSB position.

SSB Mode

Of the single sideband mode, USB is traditionally more often used than LSB. As far as the operating technique is concerned, there is no difference between two.

Generally, the "zero in" technique in SSB mode requires a little experience.

A. Discrimination between SSB and FM

(1) Use of "S" Meter

If the "S" meter indication is steady (meter pointer almost stops), the incoming signal is FM; otherwise, it is SSB.

(2) Use of MODE Switch

If a clear signal is heard at the FM position of the MODE switch, the signal is FM. The sound in SSB mode is not heard at this position of the switch

(3) Use of Beat Noise

In FM mode, a beat noise will be heard between the words of signals being received. In SSB mode, no beat noise is heard.

Note: In the case of AM waves, a beat noise will be heard during non-modulation time even in SSB mode.

B. Dial Setting

When the receiving signal is found to be SSB by the above method A, in USB first set the MAIN dial a few kHz below the receiving frequency (turn the dial counterclockwise). You will hear a high pitch sound such as is heard from a magnetic recording tape set in the fast-forward mode. Turn the dial clockwise for higher frequency and the sound will become clearer. Set the dial at the position where the sound is heard most clearly (this is the "zero in" point).

Note: 1 The "zero in" point can be easily located because the sound loses its clarity suddenly when the dial passes away from the "zero in" point.

If a clear sound cannot be heard even by following the above procedure, it may be an indication that the signal is LSB. Set the MODE switch to LSB position. In this case, the method of setting the MAIN dial should be performed in reverse order.

Note: 1. If the frequency of the other party is deviated after the "zero in" point has been obtained, set the RIT switch to ON and adjust the RIT knob.

2. When the RIT feature is used, the receiving frequency will be deviated from the transmitting frequency. Therefore, the RIT knob must be set to "0" or the RIT switch to OFF before you start to transmit again.

AM Mode

AM waves cannot be demodulated in FM mode; also, they will be heard as a continuous beat noise in SSB mode. Optimum reception of AM signal is secured by tuning the transceiver in such a way as to maximize the deflection of the "S" meter pointer. Since the bandwidth of the receiver crystal filter is somewhat narrow because this filter is primarily for SSB reception, the sound output of the speaker may have its high pitch components suppressed and hence lack clarity. This can be remedied by shifting the receive frequency a little by using the RIT knob. The same effect can be produced by means of the MAIN dial but the use of this dial for that purpose is not recommendable because, should you do so, you will not be able to "zero in" your transmit frequency to the frequency of the other party.

Where your transceiver and that of the other party are both TS-700S, it should be noted that, in AM mode, the transmit carrier frequency is 10.7006 MHz which is higher than the receive carrier frequency by 600 Hz.

Accordingly, you first "zero in" your frequency to that of the other party by adjusting your MAIN dial and send out the signal, to which the other party will respond after possibly changing his frequency. If he should do so, the pointer of your "S" meter then would deflect down from the initial maximum level indication; this drop must not be interpreted as a sign of trouble. In such a case, you are expected to re-match your frequency to the new incoming frequency by using your RIT knob with the RIT switch set to ON (refer to Fig 5 on page 13.)

4-2. TRANSMISSION

Before transmitting, perform all the necessary procedures for optimum reception. Make sure that the radio waves you have selected does not interfere with other radio stations.

Adjust the controls and knobs (DRIVE knob, MIC GAIN knob, etc.) for transmission of good quality signals. Connect a 50-ohm dummy load or antenna to the transceiver before starting to adjust the various controls. The use of dummy load is recommended because this prevents the emission of disturbing signals. Use the dummy load, which is sized to dissipate about 20 watts of transmitter power. The tuning procedure should be completed within the least time possible from the viewpoint of the life of the transceiver. Set the controls and knobs as shown in Table 3 below.

Table 3. Initial settings of control on front panel

Standby Switch	REC
RIT Switch	OFF
MODE Switch	CW
REPEATER Knob	OFF
VOX Knob	Fully counterclockwise
DRIVE Knob	Set for proper position on reception
RIT Knob	0
SQUELCH Knob	Set for optimum squelch effect
AF GAIN Knob	Set for proper volume on reception
RF GAIN Knob	Fully clockwise
BAND Switch	144
FIX CH Switch	VFO
SUB DIAL	500

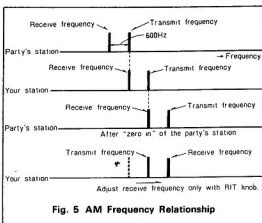

Fig. 5 AM Frequency Relationship

CW Mode

Turn BAND switch to your desired frequency (144 — 146 MHz). After turning MODE switch to CW position, shift STANDBY switch from REC to SEND position just to make sure that the meter pointer deflects and ON AIR indicator lights up, and then move back this switch to REC position.

Under this condition, move STANDBY switch to SEND side and adjustment (meter deflection) with the drive knob during transmission is broad and, therefore, it is advisable to adjust it at the time of reception so that the S meter indicates a maximum deflection. This eliminates the need for readjustment during transmission.

The foregoing procedure should be carried out rapidly, without unnecessary long delay at each step. If the telegraphic key device has already been connected to the transceiver during adjustments, the device should be set in the "key-down" condition. Having adjusted the transceiver as above, you are now ready to use the key for CW communication.

Adjusting Side Tone

The side tone monitor circuit built in your TS-700S enables monitoring the CW signal of your station. To adjust the side tone volume, open the top cover and turn the SIDE TONE knob for proper level. This adjustment should be made in the receive state, or the STANDBY switch being at REC with the key pressed down as the monitor circuit is activated even in the state.

Other Modes

When the transceiver is properly adjusted for operation in CW mode, it is ready for use in other modes (FM, LSB, USB and AM). Connect the microphone and speak after shifting the STANDBY switch to SEND position. Your voice will now be transmitted.

Microphone gain adjustment for FM and SSB (USB, LSB) can be made by the gain adjusters which become accessible when the top lid of the transceiver case is opened. The optimum setting position of these adjusters is about the midway position of their turning range (see page 9). The microphone gain should preferably be reduced as small as possible to assure good quality of transmission. In AM mode, optimum output can be obtained by adjusting the AM CAR knob (see page 9) inside the transceiver until the meter indicates anywhere between "3" and "5".

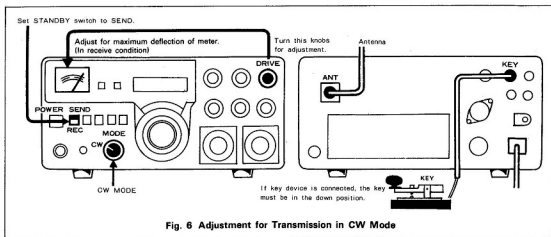

PTT (push-to-talk) Operation

By connecting the supplied microphone or any other microphone equipped with PTT switch (KENWOOD's MC-50, etc.), the transceiver is readily used for PTT operation. For communication, depress PTT switch with STANDBY switch left in the REC position.

4-3. HOW TO USE R-DX (RECEIVE BOOSTER) SWITCH

In normal receive condition, your TS-700S has high sensitivity enough to receive any incoming signal of normal strength even with the R-DX switch leaving in the "off" position. It is advisable to use the receive booster for DX communication, particularly in receiving very weak FM waves. Turn the R-DX switch on. The RF stage gain will rise up several decibels that is the receive booster gain, increasing the sensitivity.

If there is a strong wave of a local station and the like in the vicinity of the receive frequency, reception is liable to be interfered with an intermodulation, decreasing in the articulation. Be careful that such an interference causes the "S" meter to deflect more than usual. Note that the receive booster also amplifies external noises. Then, it is sometime effective to set the NB (noise blanker) switch in.

4-4. HOW TO USE RIT SWITCH

The term "RIT" is an abbreviation for the "receiver incremental tuning". The RIT feature enables you to shift only the receive frequency around ± 2 kHz in maximum without changing the transmit frequency.

Note: The digital display frequency does not change.

To tune your TS-700S to the other party transmit frequency deviating during communication, proceed as follows.

1. Turn the RIT switch "on". The RIT indicator will light.
2. Adjust the RIT knob until the TS-700S tunes to the other party transmit frequency.

Note that in RIT operation, your receive frequency deviates from the transmit frequency as changing the receive tuning, leaving the transmit frequency unchanged. After each QSO, therefore, be sure to turn the RIT switch "off".

4-5. HOW TO USE NB SWITCH

The NB (noise blanker) switch is used to suppress pulse noises such as the ignition noises generated by cars. With the switch turned "on", a very weak signal will be made so clear that you may enjoy comfortable operation.

In FM mode, it is sometimes effective to use the NB switch with the R-DX switch turned on.

4-6. HOW TO USE RF GAIN KNOB

This knob is used to adjust the receiver RF stage gain. In usual, leave it at the fully clockwise position. For a very strong incoming wave, turn it counterclockwise properly. If there is a strong signal of the other station in the vicinity of your operating frequency, also, lower the RF gain to reduce the intermodulation interference.

If the RF GAIN knob is turned too much left, the "S" meter deflection will increase gradually irrespective of the signal strength of the other party. This does not mean any trouble, but is due to the circuit characteristic in itself.

The RF gain circuit in your TS-700S is of threshold type by which the "S" meter will read correct signal strengths at all times. Therefore, close the RF GAIN knob counterclockwise for slightly lower "S" meter deflection than that of the fully clockwise end. This is a knowhow to read correct signal strength on the "S" meter at any time irrespective of the RF GAIN knob position.

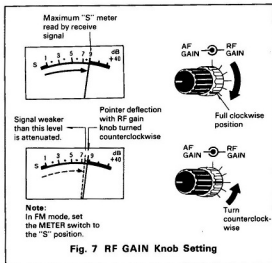

4-7. HOW TO USE LOW POWER SWITCH

There is the law of the jungle characterizing the FM waves. If a stronger and weaker waves exist together at the same frequency, that is, the former prey upon the latter so that the latter cannot be received at all. Accordingly each FM wave is not easily interfered with by the other waves. On the contrary, the FM waves has such a deficiency that weaker DX signals cannot be received at a frequency at

which a stronger signal exists. To enable more number of amateur stations to use the limited FM band, you should lower the power down for local communications. This is helpful to decrease interference with the other stations and saves power consumption. For the purpose, depress the LOW power switch. The transmit power will reduce from the rated output to the low (around 1W) output.

Note: The RF meter reads the transmit power, but it cannot correctly indicate the power as deviated by the antenna condition. However, you can roughly know of the transmit power in the way that assuming the RF meter deflect to division "8" for the rated output in the normal operating condition, it decreases to division "1" to "2" with the LOW power switch pressed in.

Caution: If leaving the LOW power switch pressed in the SSB mode, this causes low ALC voltage, which could result in wave distortion. Therefore, do not press the LOW power switch in the modes other than the FM mode, releasing it out for the rated output.

4-8. HOW TO READ OPERATING FREQUENCIES

The dial on your TS-700S indicates the carrier frequency in any mode of operation. The read frequencies refer directly to the transmit and receive frequencies as the carrier frequency is automatically corrected for each mode of operation even with the MODE switch turned.

Note: In CW receive mode, the receive frequency indicated on the dial is the beat frequency (900 Hz) higher than the transmit frequency.

Caution: The digital display on your TS-700S does not indicate the receive frequency changed by turning the RIT knob because of the counter circuit construction.

Note: In CW mode, the receive frequency is displayed 900 Hz higher than the transmit frequency.

Mode switch	Stand-by switch	SEND	Operating frequency
USB	REC		144.9985 MHz
FM			145.000 MHz
AM			145.0006 MHz
LSB			145.0015 MHz
CW			145.0015 MHz

EX.) The digital indicator represent as follows when the MAIN TUNING KNOB is fixed and the MODE SWITCH is turned.

4-9. HOW TO USE SUB-DIAL

Your TS-700S has the sub-dial which reads the operating frequencies in divisions of 100 kHz in addition to the digital display. The sub-dial is usually used to move or roughly read the operating frequency, while the digital display is to show the accurate frequency.

4-10. HOW TO USE DISPLAY PULL/7-DIGIT (FM) SWITCH

There is no troubles in the FM operation practices without reading operating frequencies of 100 Hz order. This pull switch is also used as the SSB MIC GAIN knob. The switch was held in at the factory. Leaving the switch pressed in, the digit of 100 Hz order does not light in the FM mode only. This is convenient for reading the frequency in the FM mode as the display changes from 7 to 6 digits. By pulling the switch out, the FM operating frequency is displayed in the 7 digits as with those of the other modes. Note that the digit of 100 Hz order will not go off for the modes other than the FM mode.

Example (Operating frequency display with DISPLAY PULL 7-DIGIT (FM) switch pressed in):

144.320.0 ← 7-digit display for other than FM mode.
144.320 ← 6-digit display for FM mode.

4-11. VOX OPERATION

The VOX (voice control unit) automatically switches transmission over reception by your voice. You therefore can automatically switch your TS-700S for transmission by speaking to the microphone, with the VOX switch at "on". This is possible even if the STANDBY switch is at REC. If you stop speaking, the TS-700S returns for reception automatically.

KNOB SET-UP

(1) ADJUSTING VOX GAIN knob

First, turn the VOX GAIN knob clockwise to switch it on, leaving the STANDBY switch at REC. Further, turn and set the knob clockwise until the TS-700S changes for transmission when you speaks to the microphone with usual sound volume. Moreover clockwise turning makes switching sensitivity so high that a low voice can switch the TS-700S for transmission.

However, be careful that excessive clockwise turning, or too high VOX gain, results in misoperation by surrounding sounds. The VOX operation can be assured only by hearing speaker sounds (signals and noises). The sounds shows that the TS-700S is in the receive state. No sound means the transmit state. Also, note that the ON AIR indicator lights in the transmit state and goes off in the receive state.

(2) Adjusting the ANTI VOX knob

This knob, located inside the cabinet (see page 9), is used to adjust for preventing the speaker sound from misoperating the VOX. For adjustment, set up the VOX GAIN knob and directed in item (1) above. Adjust the AF GAIN knob for proper speaker sound volume, with receiving a signal of moderate strength. Bring the microphone near the speaker as close as 20 to 30 cm. Adjust the ANTI VOX knob until the speaker sound may not activate the VOX. However, be careful that turning too clockwise is liable to activate the ANTI VOX circuit so that transmit switching could not be done easily.

(3) Adjusting the VOX DELAY knob

This knob is used to hold the transmit state for certain period of time after activation of the VOX. In usual, our speaking has frequent pauses. If the hold time is too short, the TS-700S returns to the receive state whenever your voice interrupts. It too long, on the contrary, the transceiver will not return for reception even after rather long halt of speaking, assuring no fluent communications. For natural operation, adjust the knob until the transmission is kept when speaking to the microphone at your normal speed.

Also, the knob is available for semi-break-in operation, with the MODE switch try at CW.

Caution: If leaving the VOX GAIN in "on", the TS-700S is momentarily set into the transmit state when the POWER switch is turned from "off" to "on". After VOX operation, therefore, you should turn the VOX GAIN knob to OFF.

4-12. SEMI-BREAK-IN OPERATION

Your TS-700S is capable of semi-break-in CW operation in addition to the usual break-in with STANDBY switch. The semi-break-in operation is a way of operation that the side tone is used to activate the VOX, which switches for transmit when the key up. For such a VOX operation, therefore, turn the VOX switch to ON and set the MODE switch to CW.

4-13. OPERATION WITH FIXED CHANNEL

The Model TS-700S has built-in semi-synthesizer crystal oscillator circuit for use in fixed channel operation, which is of great advantage where the transceiver has to be operated frequently on certain frequencies. Examples of such a situation are: operation in frequently used FM mode, mobile operation in SSB, communications based on schedules of the other party, mobile operation in a vehicle, etc.

The FIX CH knob has a total of 11 fixed channel position; 1, 2, 3 ... 11.

The oscillation frequency of fixed channel crystal can be obtained from the following formula:

Crystal Oscillator Frequency for FM, AM and CW

Crystal oscillator frequency (MHz) = $X - (125.10 + 10.70)$

X = Desired operating frequency (MHz)

125.10 (MHz) = Heterodyne frequency for 144 MHz band

10.70 (MHz) = Transmitter IF frequency

The TS-700S employs a MIX (synthesis) system. If crystals are arranged for 144 MHz band (144 - 145 MHz), they are also used for 145 MHz (145 - 146 MHz) bands by switching the BAND switch, where the three places of decimals of the "MHz" figure remains the same.

When crystals are arranged for 144.48 MHz, the frequencies obtained for each band are as follows:

144 MHz band

$144.48 - (125.10 + 10.70) = 8.68$ MHz (crystal oscillator frequency)

145 MHz band

$8.68 + (126.10 + 10.70) = 145.48$ MHz

126.10 MHz = HET (heterodyne) frequency for 145 MHz band

Note: The transmitter carrier oscillator gives an IF frequency of 10.7006 MHz in CW or AM mode. For practical purposes, the fractional 600 Hz is too small to require a correction by means of the crystals to be put in the fixed oscillator circuit, and should be no cause for correction.

Crystal Oscillator Frequency for SSB

In SSB mode, your operating frequency will deviate by 1.5 kHz from the center frequency of the filter if the frequency of the crystal in a fixed oscillator circuit happens to be equal to that of FM.

If you use the USB wave (which is dictated by the international amateur practice in 144 MHz band), select a crystal whose frequency is 1.5 kHz above that of FM. For LSB, however, the crystal frequency must be 1.5 kHz below that of FM.

When crystals are arranged for 144.050 MHz of USB, the crystal oscillator frequency is as follows:

$144.050 - (125.100 + 10.700) + 0.0015 = 8.2515$ MHz (crystal oscillator frequency)

0.0015 stands for 1.5 kHz.

Note: When the crystal oscillator frequency is 9.200 MHz, the operating frequencies at 144 band are 145.000 MHz respectively and, therefore, cause no problems. However, if the same crystals are used for 145 MHz band, the operating frequency is 146.000 MHz; care should be used not to transmit with this 146 MHz frequency. Similarly, if the oscillator frequency is 8.200 MHz the operating frequency is 144.00 MHz at 144 MHz band; do not transmit with this 144 MHz frequency.

4-14. MOBILE OPERATION WITH EXTERNAL DC POWER SUPPLY

The TS-700S operates also with DC 13.8V supplied from an external DC source, and is therefore adapted to duty on a vehicle.

Whether the TS-700S is used as a fixed station or as a mobile station, the techniques of operating it remain the same. A more enjoyable use is possible in mobile application provided that you device one or two provisions as to the place or manner of installation. The place of use depends on where the operator is seated.

If you are to operate your transceiver while driving the vehicle, then you should set up a proper mounting bracket right beside the driver's seat. You may locate the transceiver at the companion's seat provided that is secured firmly by means of seat belt or the like so that it is prevented from falling down.

Mobile Antenna

There are many types of mobile antenna for 144 MHz band use. Most of them will do but a 1/4 wavelength whip or ground-plane antenna, or a 5/8 wavelength antenna is preferred.

Power Capacity

The TS-700S draws about 4 amperes maximum when it is working with full power. This much current is easily supplied by any automobile battery. When the power is supplied from such a battery, it is recommended that the transceiver be operated while the automobile engine is in operation, in order to prevent over-discharge of the battery.

Note: For safe driving of automobile, it is preferable that the transceiver be operated on fixed channels (prepare necessary crystal oscillators).

4-15. REPEATER OPERATION

Operating Frequency

In the 145 MHz band, the REPEATER switch can shift both transmit and receive frequencies 600 kHz up or down. The digital display frequency changes according to the REPEATER switch position:

Position

- OFF..... Digital display reads both transmit and receive frequency.
- NORMAL..... Digital display reads receive frequency. Transmit frequency is 600 kHz lower than it.
- REV..... Digital display reads transmit frequency. Receive frequency is 600 kHz lower than it.

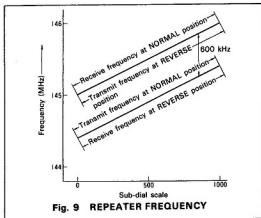

Fig. 9 REPEATER FREQUENCY

Repeater Operation

The TS-700S is designed to operate with the repeater system of the following specifications:

Frequency shift: ± 600 kHz

Starting system: Carrier controlled type. Acture by tone controlled (tone frequency 1750 Hz).

The built-in tone oscillator operates at 1750 Hz when the TONE SWITCH is pressed, and at the same time, a repeater call signal is automatically transmitted. Releasing the hand from the switch automatically stops the oscillator.

When the REPEATER knob is set to REVERSE, the receive frequency is 600 kHz below the transmit frequency (dial frequency). At this position of the knob, the signal from the other station can be directly received if it is occupied by anyone, thus allowing you to check the band condition. If, at this time, the transceiver is set in transmitting mode and then the party using the repeater station responds to your signal, you can communicate directly with the party without having to use the repeater station. Thereafter change to simplex operation, the repeater station is released.

4-16. OSCAR (Artificial Satellite) OPERATION

At present, two amateur radio communication artificial satellites (No. 6 and No. 7) are travelling along the orbit of

the earth. These satellites can also be used as your repeater stations. In repeater operation using such satellites, your TS-700S functions as a transmitter of 2m-10m "up-link" repeater frequency or as a receiver of 70 cm-2m "down-link" repeater frequency. The link frequencies in this operation are given in Table 4.

An example of 2m-10m repeater operation using TS-700S and R-599 of our make is shown in Fig. 10 for your reference.

Besides being used as shown in Fig. 10, the OSCAR satellites also provide you with various applications such as tracking of satellite orbit, use of beacon waves, etc., though you need special knowledge on the manner of operation, antenna installation and others which are somewhat different from those on the general amateur radio communication. With basic knowledge, you will be able to enjoy repeater communication through the amateur artificial satellites without difficulty. We suggest that you proceed with "on the air" by referring to guide books available.

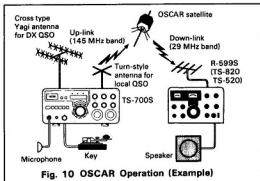

Fig. 10 OSCAR Operation (Example)

(Use Oscar 7 far more often than Oscar 6 since the battery of the latter is almost used up.)

Note(*): Do not use it if possible as its battery is almost used up.

Table 4

REPEATER		
OSCAR NO. 6	OSCAR NO. 7	OSCAR NO. 7
2 m \rightarrow 10 m	70 cm \rightarrow 2 m	2 m \rightarrow 10 m
145.900 ~ 146.000 MHz ◇	432.125 ~ 432.175 MHz ◇	145.85 ~ 145.95 MHz ◇
29.450 ~ 29.550 MHz	145.975 ~ 145.925 MHz	29.40 ~ 29.50 MHz
BEACON		
435.100 MHz (300 mW)	29.502 MHz (200 mW)	
29.450 MHz (200 mW)	145.975 MHz (200 mW)	
	435.10 MHz (300 ~ 400 mW)	

SECTION 5. BLOCK DIAGRAM

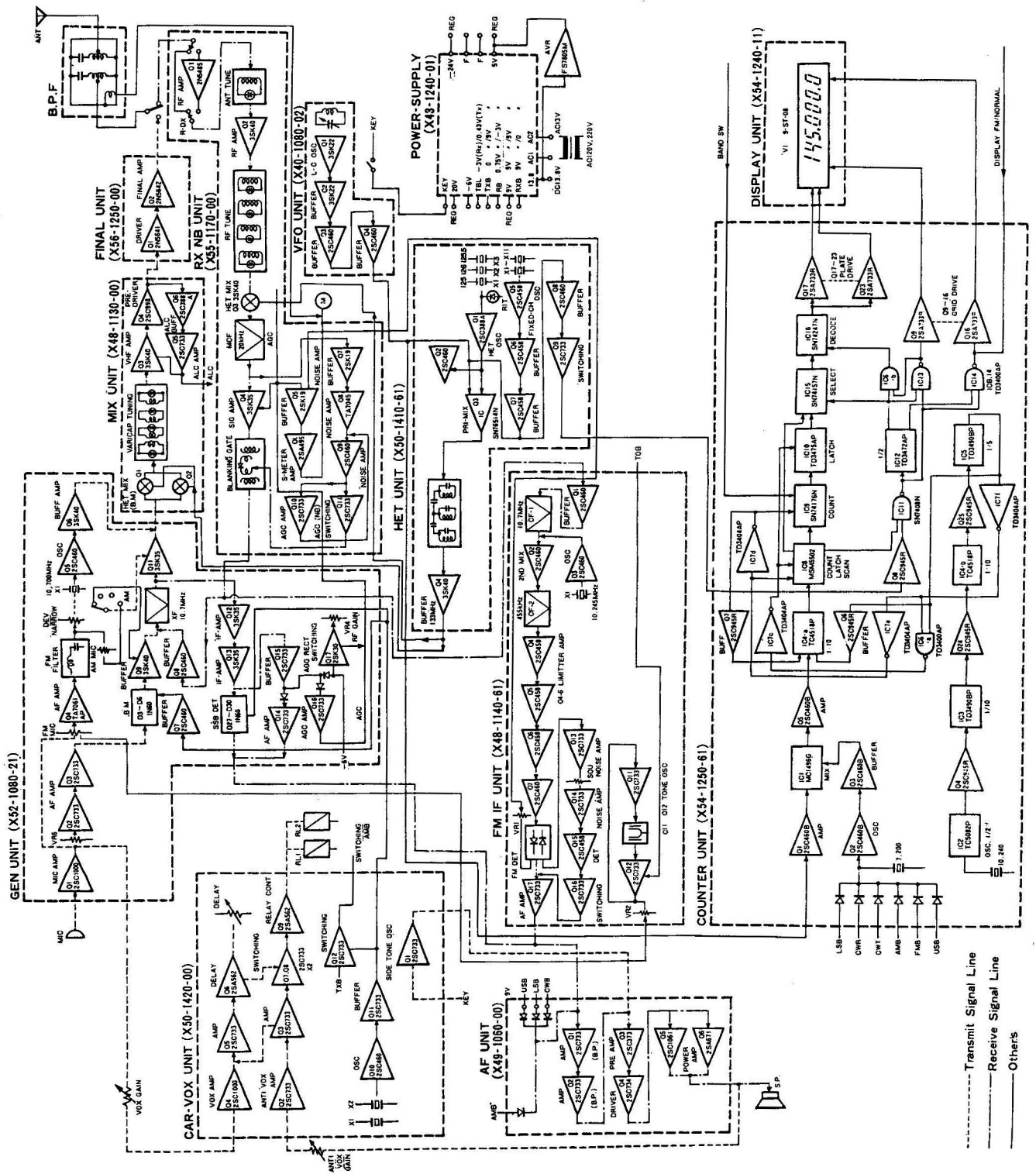

Fig. 11

BLOCK DIAGRAM

The circuit block diagram of TS-700S is shown in Fig. 11. Solid-state parts used in this model are: 102 transistors, 18 FET's, 21 IC's and 162 diodes. Circuits are divided into individual units according to the operating systems and all units, with the exception of band pass filters (BPF), are wired and built on printed-circuit boards.

The receiver section operates as a single superheterodyne receiver in SSB mode and a double superheterodyne receiver in FM mode. The transmitter section is more versatile, it is a single conversion type and operates as a filter type unit in SSB mode, a unit with direct modulator using a variable reactance frequency shift element in FM mode, a unit of low power modulation system in AM, and as a unit of block bias keying system in CW mode.

Crystal Oscillator Frequencies

Carrier unit.....	USB	10.6985 MHz
	LSB	10.7015 MHz
	AM, CW	10.7006 MHz
Generator unit.....	FM	10.700 MHz
HET unit	144	125.100 MHz
	145	126.100 MHz

Table 5

Marking	Description
13.8V.....	13.8V
9V.....	9V
-6V.....	-6V
GND.....	Earth
TXX.....	Transmitter section
RXX.....	Receiver section
VRX.....	Variable resistor
IN.....	Input
OUT.....	Output
RL.....	Relay
SX.....	Switch
PLX.....	Pilot lamp

SECTION 6. ACCESSORIES

6-1. Accessories

For more enjoyable operation of your TS-700S, the following accessories are available from your dealer on optional basis:

• Communication type microphone MC-50

A uni-directional dynamic microphone exclusively designed for amateur radio band equipment, featuring excellent performance when used in noisy locations or used in VOX mode. Provided with a lock-in type PTT switch, the output impedance is switchable between 50 k Ω and 600 k Ω .

• Ham clock HC-2

A clock graduated in 24-hour system on the time dial with main prefixes for convenience of use for ham fans. Operates continuously for more than 1 year with one UM-1 dry battery.

REMOTE VFO — VFO-700S

This is a highly stable, solid-state VFO that matches your TS-700S well in the characteristics and design. With connection of the VFO-700S, you can enjoy highly advanced and comprehensive communication techniques as if you use two units of TS-700S.

EXTERNAL SPEAKER — SP-70

This external speaker was designed and tailored so specifically as to match your TS-700S well. It sounds the best tone of high articulation as using a high-cut cone ideal for communication equipment.

HIGH-CLASS HEADPHONE — HS-5

This headphone was designed and tailored so ideal as the best headphone for use with your top-quality transceiver. You will be free of any oppressive feeling on your ears and head even in extended period of use. It is of open air type which provides more natural hearing performance. Also, it can replace the supplied pressure ear pads with single touch.

6-2. HOW TO CONNECT VFO-700S

The remote VFO-700S was developed for further enhancing the capabilities of your TS-700S. To connect the VFO-700S, proceed as directed below. First, remove the 9-pin MT plug located at the rear of the TS-700S. Connect the supplied VFO and grounding cables as shown in Fig. 12.

Only by controlling the FUNCTION switch on the VFO-700S, you can enjoy highly advanced and comprehensive operations, for example, quick receiving a desired signal of another frequency and tuning other frequency different from your transmit frequency, as if you use two units of transmitter and receiver each. The FUNCTION switch on the VFO-700S, also, can automatically switch the VFO frequency, which its digital display can indicate. For more detailed information of the VFO, read the "OPERATING MANUAL for VFO-700S".

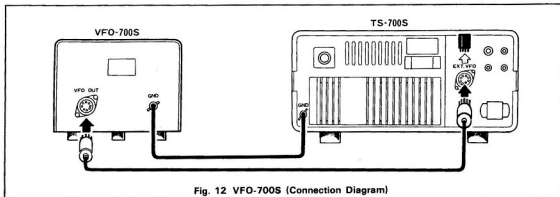

Fig. 12 VFO-700S (Connection Diagram)

SECTION 7. ALIGNMENT

Your Model TS-700S is factory adjusted prior to shipment and no further adjustments are required. However, if any trouble is encountered, please send it to your dealer.

Frequency Adjustment

When fixed channel crystal oscillators are added in the transceiver, adjust their frequencies as outlined below (the relationship between the markings on the FIX CH knob and the crystal oscillator sockets are shown in Fig. 14):

1. Pull up the two grommets and open the top lid. (See Fig. 13)
2. Adjust the trimmers (TC1 ~ TC11) corresponding to the newly used crystal oscillator sockets to produce the desired oscillator frequencies (refer to Paragraph 4-13 "Operation with Fixed Channels").

Table 6

f_o (MHz).....	crystal oscillator frequency for FM, AM, and CW.
f_{USB} (MHz).....	crystal oscillator frequency for USB.
f_{LSB} (MHz).....	crystal oscillator frequency for LSB.
X (MHz).....	desired operating frequency

BAND 1:

$$f_o = X - (125.10 + 10.70) \text{ (MHz)}$$

BAND 2:

$$f_o = X - (126.10 + 10.70) \text{ (MHz)}$$

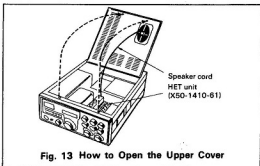

Fig. 13 How to Open the Upper Cover

BAND 1:

$$f_{USB} = X - (125.100 + 10.700 - 0.0015) \text{ (MHz)}$$

BAND 2:

$$f_{USB} = X - (126.100 + 10.700 - 0.0015) \text{ (MHz)}$$

BAND 1:

$$f_{LSB} = X - (125.100 + 10.700 + 0.0015) \text{ (MHz)}$$

BAND 2:

$$f_{LSB} = X - (126.100 + 10.700 + 0.0015) \text{ (MHz)}$$

- Specifications for Crystal Oscillator Unit (option)

Type: HC-25/U

Order of oscillation wave: Fundamental wave

Frequency: 8.200 ~ 9.200 MHz

Oscillation circuit: CI meter

Oscillating condition: 32 pf (parallel capacity)/25Ω or less (effective resistance)

Electrical characteristics:

- Operating temperature
-20°C ~ +60°C
- Allowable frequency deviation
Within $\pm 3 \times 10^{-5}$ (25°C)
- Frequency vs. temperature characteristic:
Within $\pm 3 \times 10^{-5} + (0 \sim 50^\circ\text{C})$

Frequency calibration

1. Plug the power cord into a wall outlet.
2. Turn the POWER switch "on", keeping the STANDBY switch at REC.
3. Pull out the DISPLAY PULL 7-DIGIT (FM) switch inside the TS-700S.

Note: After calibration, press the switch in.

4. Set the FIX.CH switch to the channel number corresponding to a crystal-inserted socket.
5. Set the MODE switch to a given position of the FM, CW, AM, USB and LSB.
6. While observing the digital display, adjust the trimmer corresponding to the crystal-inserted socket using an insulated screw driver until the digital display reads the specified frequency (see Fig. 14).

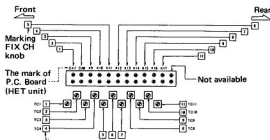

Fig. 14 HET Unit (X50-1410-61)

SECTION 8. TROUBLESHOOTING

The symptoms listed below are in no way indications that the transceiver is defective. If trouble with the transceiver cannot be remedied even after the following checks have been performed, consult your dealer or your nearest service station.

SYMPTOM	POSSIBLE CAUSES	REMEDY
• Turning on POWER switch will not light up pilot lamp.	<ol style="list-style-type: none"> 1. AC power cord is not fully inserted into the connector. 2. Improper connection of power cord. 3. Fuse is blown out. 	<ol style="list-style-type: none"> 1. Firmly insert the plug of the cord into the connector. 2. Plug in the cord fully. 3. Replace the fuse (if new fuse blows, the transceiver needs repair).
• Antenna is properly installed but the transceiver will not receive signals.	<ol style="list-style-type: none"> 1. PTT switch on the microphone is in "talk" position. 2. FIX CH switch is set in empty channel position. 	<ol style="list-style-type: none"> 1. Turn PTT switch to "receive" position. 2. Rotate the switch to VFO position or to a channel position where the channel indicator lamp lights.
• No background noise from the speaker in FM mode.	<ol style="list-style-type: none"> 1. Squelch circuit is in service. 	<ol style="list-style-type: none"> 1. Turn SQUELCH knob fully counterclockwise.
• Transceiver is connected to antenna, but no signal is received while "S" meter pointer remains deflected.	<ol style="list-style-type: none"> 1. RF GAIN control is set too low. 	<ol style="list-style-type: none"> 1. Turn RF GAIN control fully clockwise.
• Even in the absence of signal, "S" meter pointer remains deflected.	<ol style="list-style-type: none"> 1. RF GAIN control is set too low. 2. METER switch is set to CEN position in FM mode. 	<ol style="list-style-type: none"> 1. Turn RF GAIN control fully clockwise (if meter indication remains the same, the transceiver is defective). 2. Set METER switch to "S" position.
• SSB signal is being received but speaker output remains unintelligible.	<ol style="list-style-type: none"> 1. Transceiver is set for a wrong sideband. 	<ol style="list-style-type: none"> 1. Shift MODE switch to USB or to LSB.
• RIT knob is ineffective in fine turning.	<ol style="list-style-type: none"> 1. RIT switch is in OFF position. 	<ol style="list-style-type: none"> 1. Set the switch to ON position.
• There is a frequency lag between transmission and reception.	<ol style="list-style-type: none"> 1. RIT knob is not in the "0" position while RIT switch is ON. 	<ol style="list-style-type: none"> 1. Set RIT switch to OFF, or set RIT knob to "0" position.
• Noise blanker circuit is not fully effective in suppressing noise.	<ol style="list-style-type: none"> 1. Strong signal exists close to the operating frequency. 2. Some interfering noise similar to SSB signal in waveform is coming in from a nearby source (such as high-frequency welder or corona discharging device). 	
• No RF power.	<ol style="list-style-type: none"> 1. Absence of 9-pin MT plug in VFO socket 	<ol style="list-style-type: none"> 1. Firmly connect the MT plug.

SYMPTOM	POSSIBLE CAUSES	REMEDY
<ul style="list-style-type: none"> • Digital display will not illuminate. 	<ol style="list-style-type: none"> 1. EXT VFO connector has no 9-pin MT plug. 2. FIX CH switch is positioned at a vacant channel. 	<ol style="list-style-type: none"> 1. Insert 9-pin MT plug into the EXT VFO connector. 2. Set FIX CH switch to VFO position.
<ul style="list-style-type: none"> • VOX will not work. 	<ol style="list-style-type: none"> 1. VOX GAIN knob is at OFF. 2. VOX GAIN knob is closed (counterclockwise). 	<ol style="list-style-type: none"> 1. Turn VOX GAIN knob clockwise to turn on. 2. Further turn VOX GAIN knob clockwise for proper action.
<ul style="list-style-type: none"> • VOX works, but is activated by speaker sound. 	<ol style="list-style-type: none"> 1. Improper ANTI VOX knob setting. 	<ol style="list-style-type: none"> 1. Turn ANTI VOX knob inside cabinet clockwise for proper action.
<ul style="list-style-type: none"> • Turning VFO will not change digital display frequency. 	<ol style="list-style-type: none"> 1. FIX CH switch is at fixed channel position. 	<ol style="list-style-type: none"> 1. Set FIX CH switch to VFO.
<ul style="list-style-type: none"> • No or little AM output. 	<ol style="list-style-type: none"> 1. AM carrier VR is in the minimum position. 	<ol style="list-style-type: none"> 1. Adjust AM carrier VR for suitable output by turning it clockwise (about "5" position on the RF meter).
<ul style="list-style-type: none"> • No output in SSB mode. 	<ol style="list-style-type: none"> 1. Microphone plug is improperly connected into the microphone jack. 2. SSB mic volume is set too low. 	<ol style="list-style-type: none"> 1. Firmly connect the microphone plug. 2. Turn clockwise SSB MIC GAIN volume in transceiver.
<ul style="list-style-type: none"> • Too small a modulation factor in FM mode. 	<ol style="list-style-type: none"> 1. FM mic volume is set too low. 	<ol style="list-style-type: none"> 1. Turn clockwise FM MIC GAIN volume in transceiver.

TOP & BOTTOM VIEW

TOP VIEW

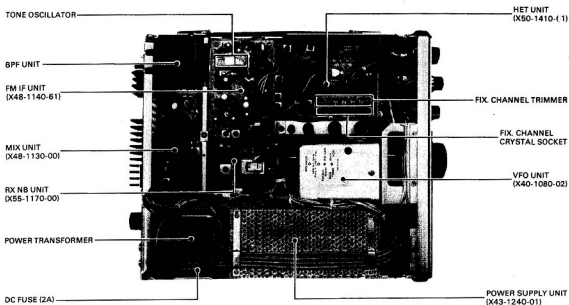

BOTTOM VIEW

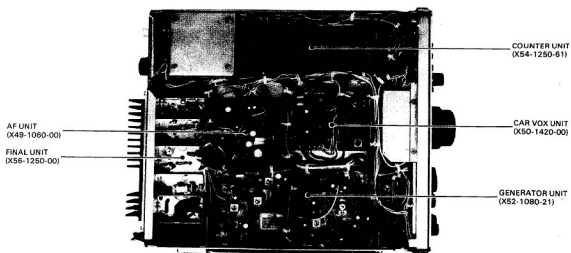

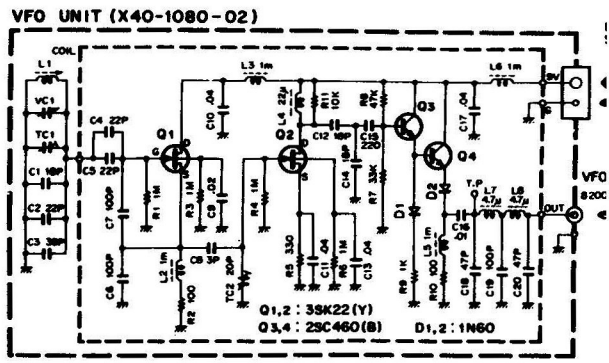
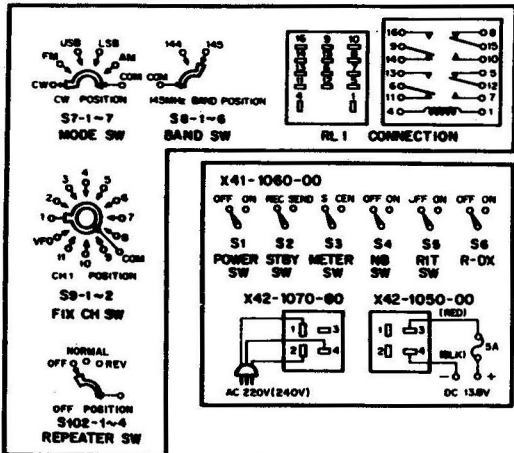

HET UNIT (X50-1410-61)

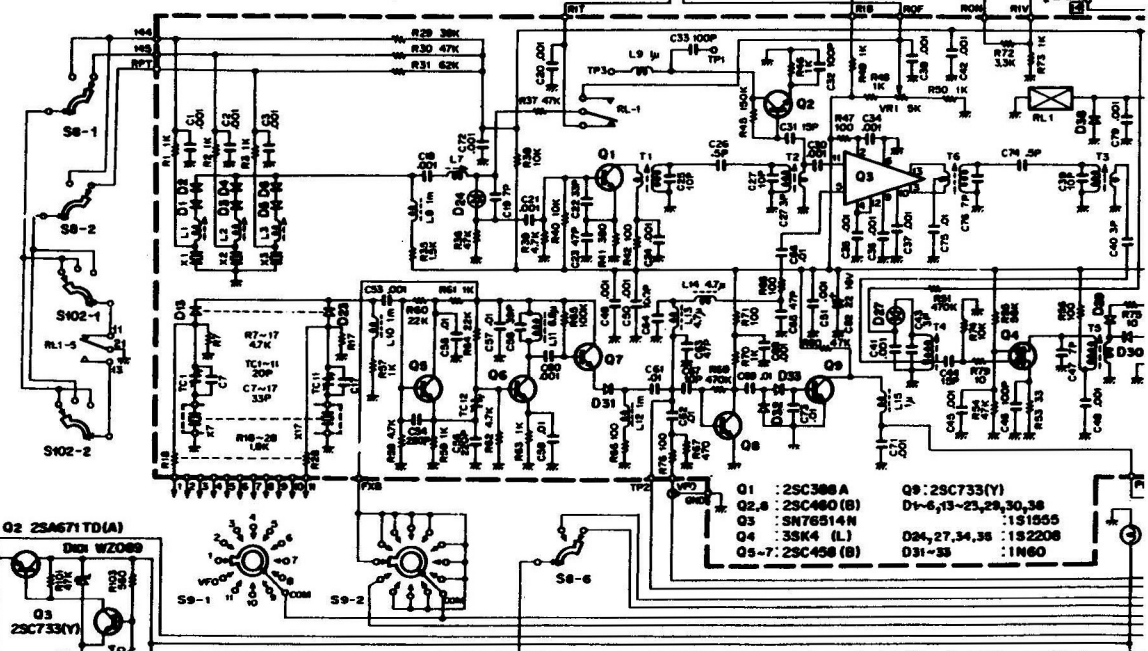

POWER SUPPLY UNIT (X43-1240-01)

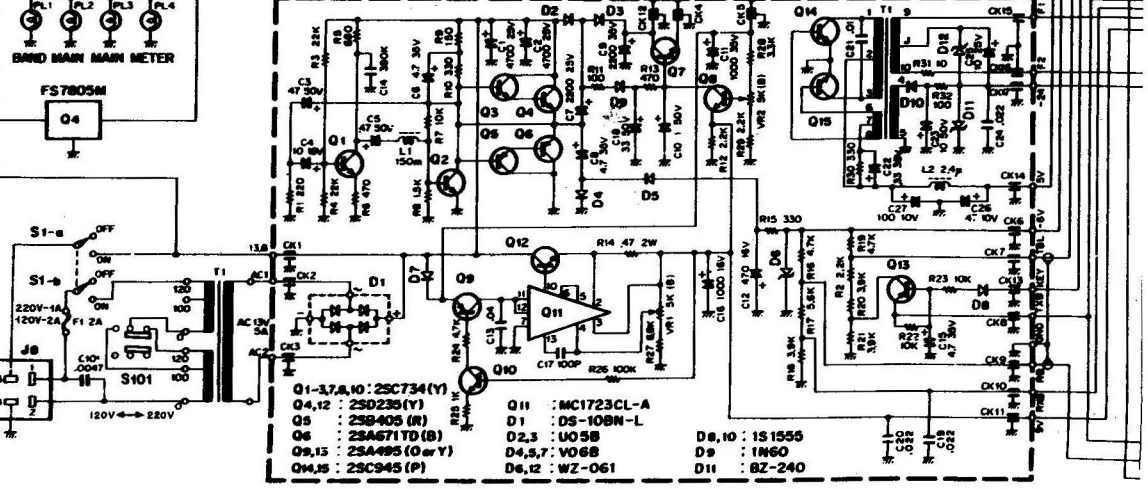

TS-700S SCHE

MIX UNIT (X48-1130-00)

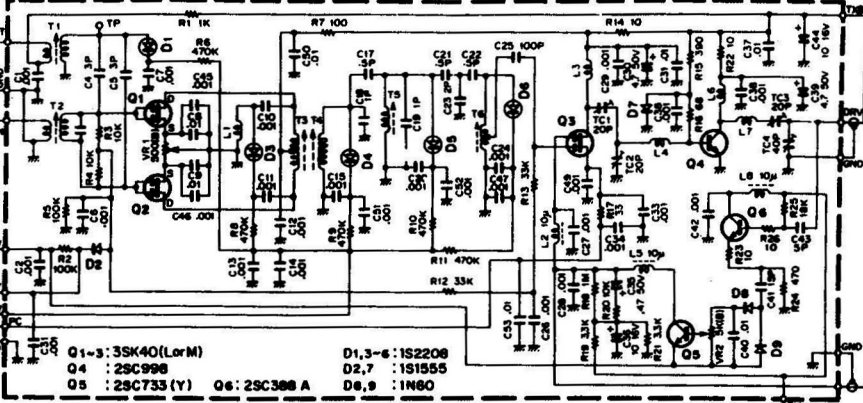

- Q1-3: 3SK40(LorM)
- Q4 : 29C998
- Q5 : 29C733 (Y)
- Q6: 29C388 A
- D1,3-6: 1S2208
- D2,7 : 1S1555
- D8,9 : 1N60

COUNTER UNIT (X54-1250-61)

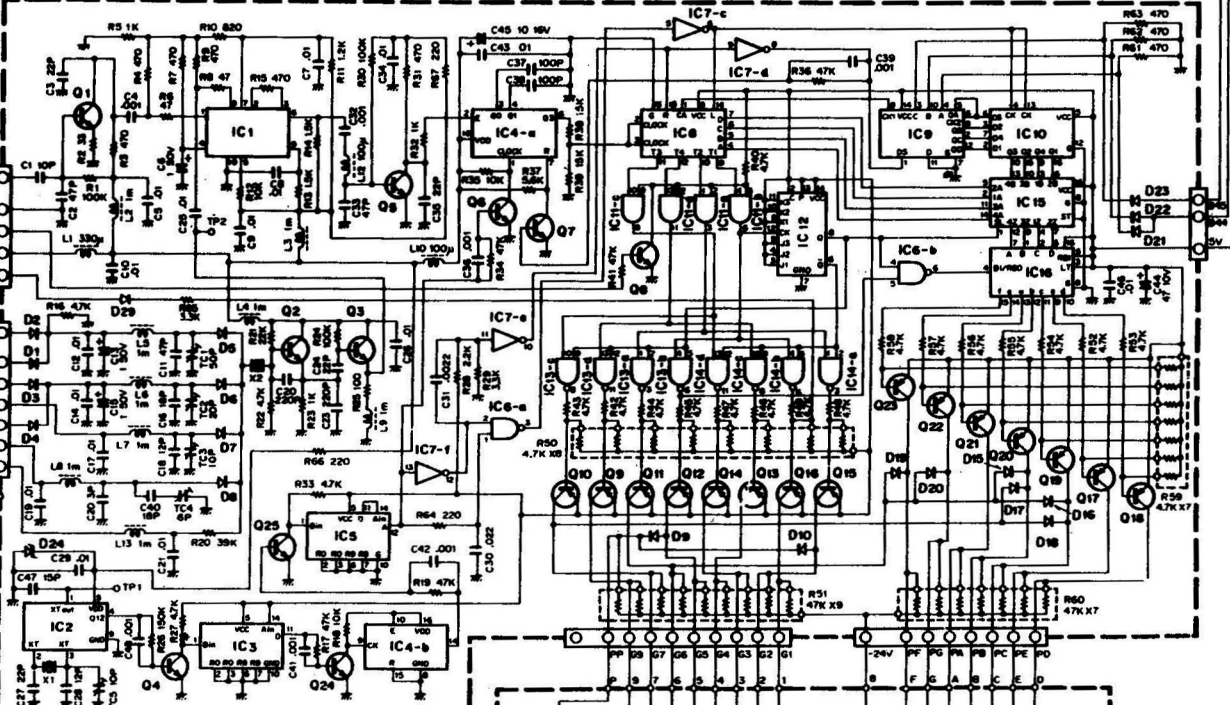

- Q1-3,5 : 2SC460(B)
- Q4,6-8,24,25: 2SC945(R)
- Q9-23 : 2SA733(R)
- D1-4,3,10,15-23,29: 1S1555
- D5-8 : 1S1587
- D24 : WZ-071
- IC1 : MC1496(G)
- IC2 : TC5082P
- IC3,5 : TD34908P
- IC4 : TC4518P
- IC6,13,14: TD3400AP
- IC7 : TD3404AP
- IC8 : MSM5502
- IC9 : SN74176N
- IC10: TD3475AP
- IC11: SN7408N
- IC12: TD3472AP
- IC15: SN74157N
- IC16: SN74247N

DISPLAY UNIT (X54-1240-11)

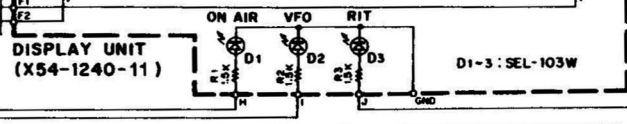

- D1-3: SEL-103W

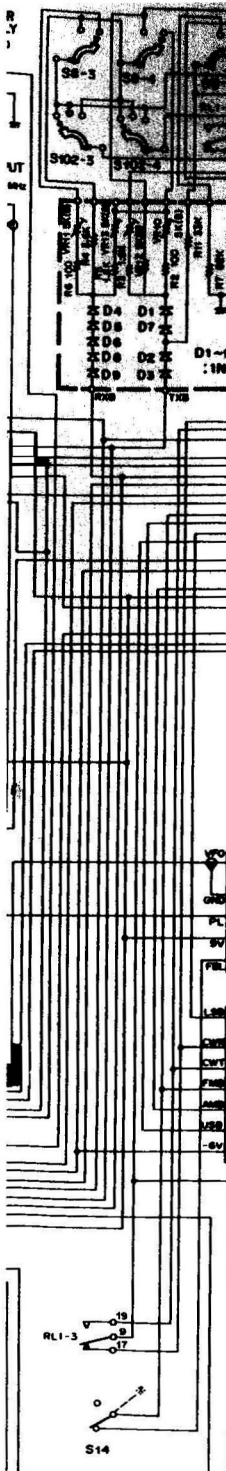

ATIC DIAGRAM

