



## SSB TRANSCEIVER

# Model TS-515S



**OPERATING MANUAL**

# KENWOOD TS-515S OPERATING MANUAL

The Kenwood TS-515S is a powerful, five band transceiver for operation on SSB and CW. It features built-in VOX, crystal calibrator, noise blanker, incremental tuning and 1 kHz frequency readout. High stability is obtained by the use of a well designed heterodyne VFO.

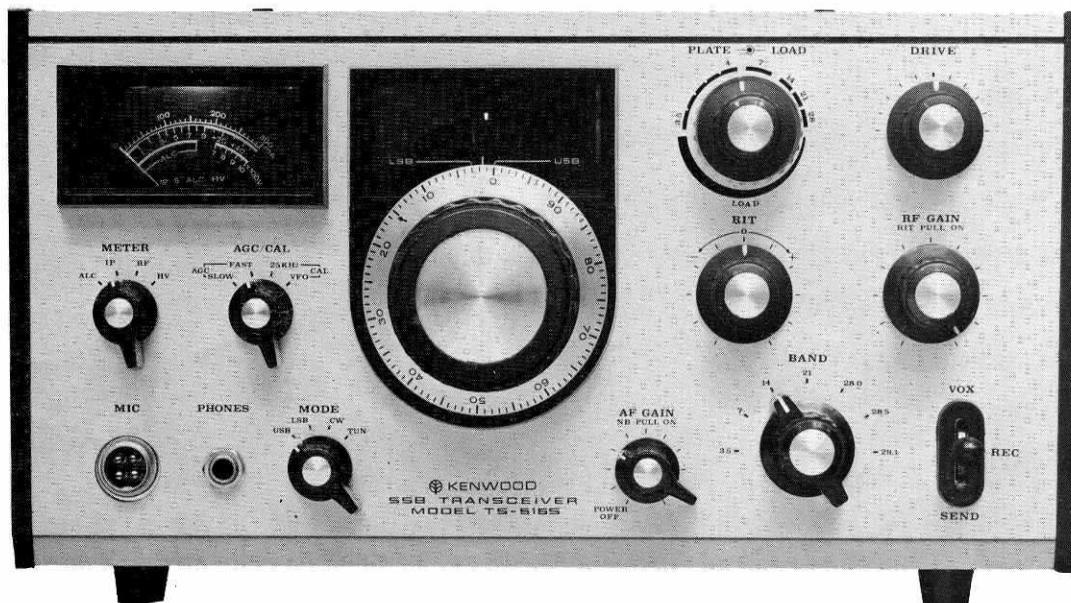

## CONTENTS

SPECIFICATIONS .....	3
SECTION 1. INSTALLATION .....	4
SECTION 2. CONTROLS .....	5
SECTION 3. OPERATING INSTRUCTIONS .....	8
SECTION 4. CIRCUIT DESCRIPTION .....	11
SECTION 5. ALIGNMENT .....	13
SECTION 6. TROUBLE SHOOTING .....	16
CHASSIS TOP VIEW .....	18
SCHEMATIC DIAGRAM .....	19
CHASSIS BOTTOM VIEW .....	20

## KENWOOD TS-515S SPECIFICATIONS

<b>FREQUENCY RANGE:</b>	80 meter band — 3.5 ~ 4.0 MHz 40 meter band — 7.0 ~ 7.3 MHz 20 meter band — 14.0 ~ 14.6 MHz 15 meter band — 21.0 ~ 21.6 MHz 10 meter band — 28.0 ~ 28.6 MHz 28.5 ~ 29.1 MHz 29.1 ~ 29.7 MHz
<b>MODES:</b>	LSB, USB, CW
<b>INPUT POWER :</b>	500 watts PEP, 300 watts CW
<b>ANTENNA IMPEDANCE:</b>	50 ~ 75 $\Omega$
<b>SIDEBAND SUPPRESSION:</b>	Better than 40 dB
<b>CARRIER SUPPRESSION:</b>	Better than 40 dB
<b>HARMONIC RADIATION:</b>	-40 dB
<b>IMAGE RATIO:</b>	More than 50 dB
<b>IF INTERFERENCE:</b>	More than 50 dB
<b>TRANSMIT AUDIO FREQUENCY BANDWIDTH:</b>	400 ~ 2600 Hz (-6 dB)
<b>SENSITIVITY:</b>	3.5 ~ 21.6 MHz band — 0.5 $\mu$ v S/N 10 dB 28.0 ~ 29.7 MHz band — 1.5 $\mu$ v S/N 10 dB
<b>FREQUENCY STABILITY:</b>	Less than 100 Hz frequency drift per 30 minutes after warmup.
<b>SELECTIVITY:</b>	SSB More than 2.4 kHz (at -6 dB) More than 4.8 kHz (at -60 dB) CW More than 0.5 kHz (at -6 dB) * More than 1.5 kHz (at -60 dB) * * With optional CW filter.
<b>AF OUTPUT:</b>	More than 1 watt (10% distortion)
<b>RECEIVER OUTPUT IMPEDANCE:</b>	8 $\Omega$ (speaker and headphones)
<b>POWER CONSUMPTION:</b>	Maximum consumption with PS-511S AC power supply is 550 watts for transmit and 150 watts for receive.
<b>TUBES AND SOLID STATE COMPONENTS:</b>	10 tubes 1 IC 4 FETs 37 transistors 57 diodes
<b>SIZE:</b>	13" wide x 7-9/32" high x 13-5/8" deep
<b>WEIGHT:</b>	22 lbs.

# SECTION 1. INSTALLATION

## 1.1 UNPACKING

Carefully unpack the TS-515S and check that the following accessories are included.

Microphone plug	Interconnecting power cable*
Fan cable	US plug
Plastic feet	10 amp. fuses*
Test rod	* Included in the PS-515

## 1.2 LOCATION

Select a proper operating location. It should be dry and free from direct sunlight. There should be at least 3 inches clearance between any objects and the rear of the transceiver to allow adequate air flow for cooling.

## 1.3 CONNECTIONS

Connect the ground lug of the TS-515S to a suitable ground. (See Fig. 1)

Connect the interconnecting fan and power cable between the transceiver and the AC power supply. (See Fig. 1)

### CAUTION:

*Before operating the transceiver, make sure the AF GAIN knob is set to POWER OFF and that the stand-by switch is set to REC. If this is not done, damage may occur when the power is applied. (See Fig. 2)*

*(Please make the fuse furnished with the PS-515 power supply replaced with a 10A fuse.)*

Connect a suitable antenna to the ANT jack on the transceiver (See Fig. 3). An antenna is considered suitable when it presents a 50 ~ 75 ohm load to the transceiver. The performance and efficiency of the TS-515S is directly related to the type of antenna that is chosen. For further information on antennas, the ARRL Antenna Handbook is recommended.

Connect a high impedance microphone to the transceiver with the microphone plug that is supplied. (See Fig. 4) Insert the AC plug into a 220 V AC receptacle.

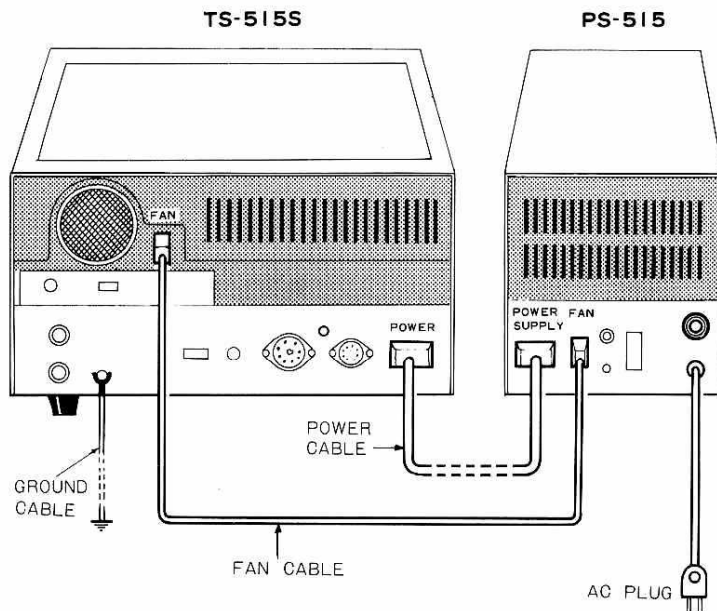

Fig. 1 TS-511S-Power Supply Connections

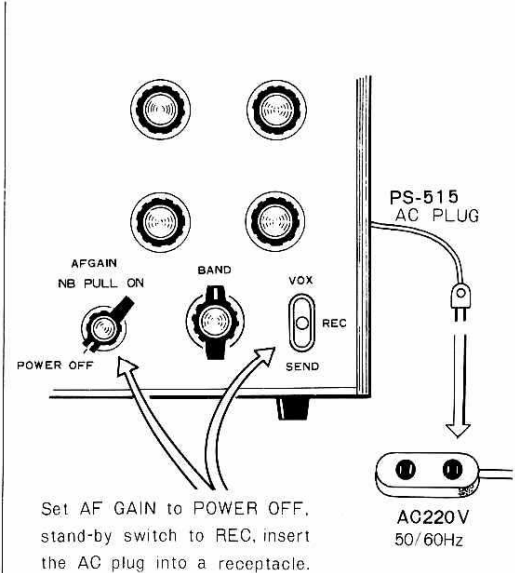

Fig. 2 Initial Switch Settings



## SECTION 2. CONTROLS

### 2.1 FRONT PANEL CONTROLS

#### Meter (1 on Fig. 5)

The meter monitors five different functions. In the receive mode it acts as an S-meter. In the transmit mode it monitors ALC (Automatic Level Control), IP (plate current), RF (relative power output), or HV (high voltage).

#### METER Switch (2 on Fig. 5)

The meter switch determines what the meter will read in the transmit mode. It switches to either the ALC, IP, RF, or HV.

#### AGC/CAL Switch (3 on Fig. 5)

**AGC:** Two different AGC time constants may be selected. Slow AGC is a long time constant and fast AGC is a short time constant.

**CAL:** These positions select a 25 kHz crystal calibrator marker. The VFO position is used for calibrating the matching remote VFO.

#### MIC Microphone Connector (4 on Fig. 5)

A four prong connector is used so that PTT operation is possible with a suitable microphone.

#### PHONES Headphone Jack (5 on Fig. 5)

This jack allows operation with 8 ohm headphones. When the headphones are plugged in the speaker is disconnected.

#### Main Tuning Knob (6 on Fig. 5)

The main tuning knob operates the main tuning dial.

#### Vernier Scale (7 on Fig. 5)

The vernier scale is calibrated in 25 kHz divisions and its range is 0 ~ 600 kHz.

#### Dial Reference Lines (8 on Fig. 5)

These reference lines make accurate frequency readout possible in all three modes of operation.

#### MODE Switch (9 on Fig. 5)

This switch selects either USB, LSB, CW or TUN.

#### AF GAIN, NB PULL ON, POWER OFF Switch (10 on Fig. 5)

**POWER OFF** – With the switch in this position the transceiver is turned off. Turn the set on by turning the switch clockwise.

**AF GAIN** – The volume of the received signal increases

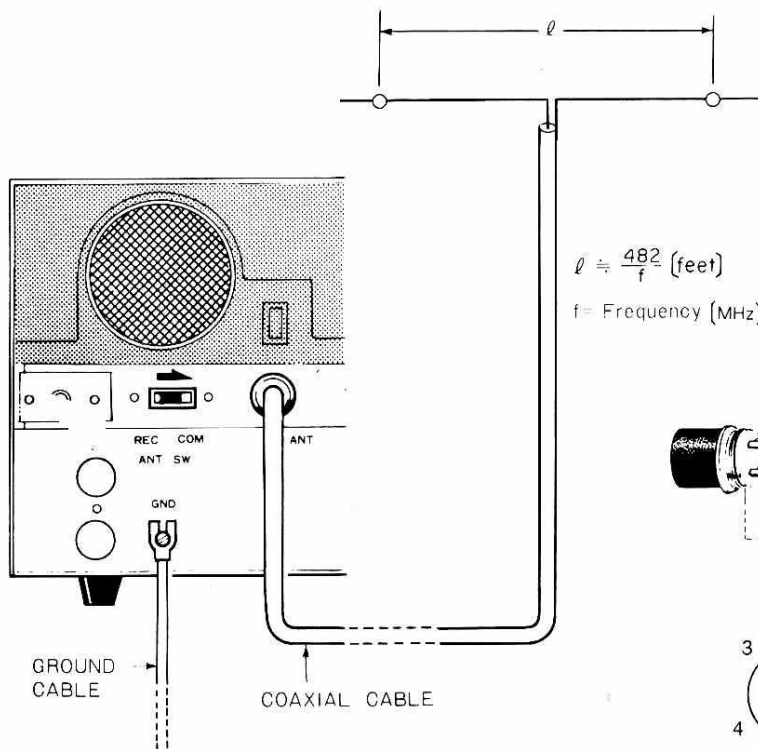

Fig. 3 Antenna Connections

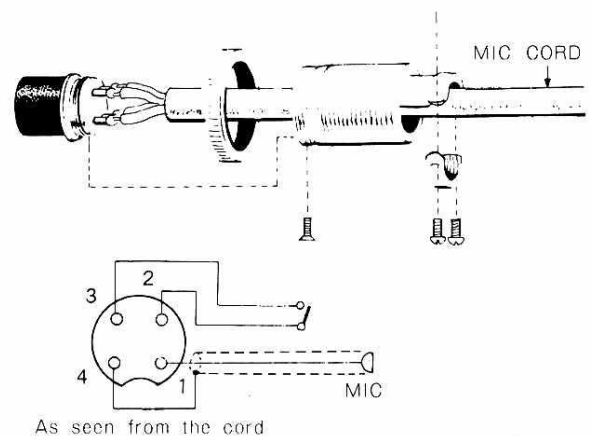

Fig. 4 Microphone Cord Connections

when the knob is turned in a clockwise direction.  
**NB PULL ON** – The noise blanker is activated by pulling the knob out.

**RIT Receiver Incremental Tuning Control** (11 on Fig. 5)  
 This control allows the operator to move the receive frequency  $\pm 2$  kHz. This control does not move the transmit frequency.

**Main Dial Skirt** (12 on Fig. 5)  
 The dial skirt is calibrated in 1 kHz divisions, and one revolution of the dial skirt covers 100 kHz.

**PLATE/LOAD Plate Tuning/Load Adjustment** (13 on Fig. 5)  
 The dark knob controls the plate tuning. The larger silver ring is used to adjust the loading.

**DRIVE Driver Tuning Control** (14 on Fig. 5)  
 This controls the driver stage tuning.

**BAND Switch** (15 on Fig. 5)  
 This switch selects the desired frequency range.

**VOX/REC/SEND Stand-By Switch** (16 on Fig. 5)  
 When this switch is set to VOX, the TS-515S will respond either to VOX or PTT operation. With the switch in the REC position the transceiver will only receive and with the

switch in the SEND position the transceiver is locked into transmit.

**RF GAIN/RIT PULL ON** (17 on Fig. 5)  
 When the knob is advanced in a clockwise direction the RF gain increases. When the knob is pushed in, the RIT control is disabled. When this occurs, the transmit and receive frequencies are the same.

## 2.2 REAR PANEL CONTROLS

**REC ANT Receive Antenna Jack** (18 on Fig. 6)  
 This jack is used when the receive and transmit antennas are separate. If this is the case, the receive antenna should be connected to the REC ANT jack.

**Cooling Fan** (19 on Fig. 6)  
 This fan provides an air flow to cool the RF amplifier section.

**GND Ground Lug** (20 on Fig. 6)  
 The ground lug should be connected to an adequate ground.

**RF VOLT RF Voltmeter Sensitivity Control** (21 on Fig. 6)  
 This control adjusts the sensitivity of the RF output meter.

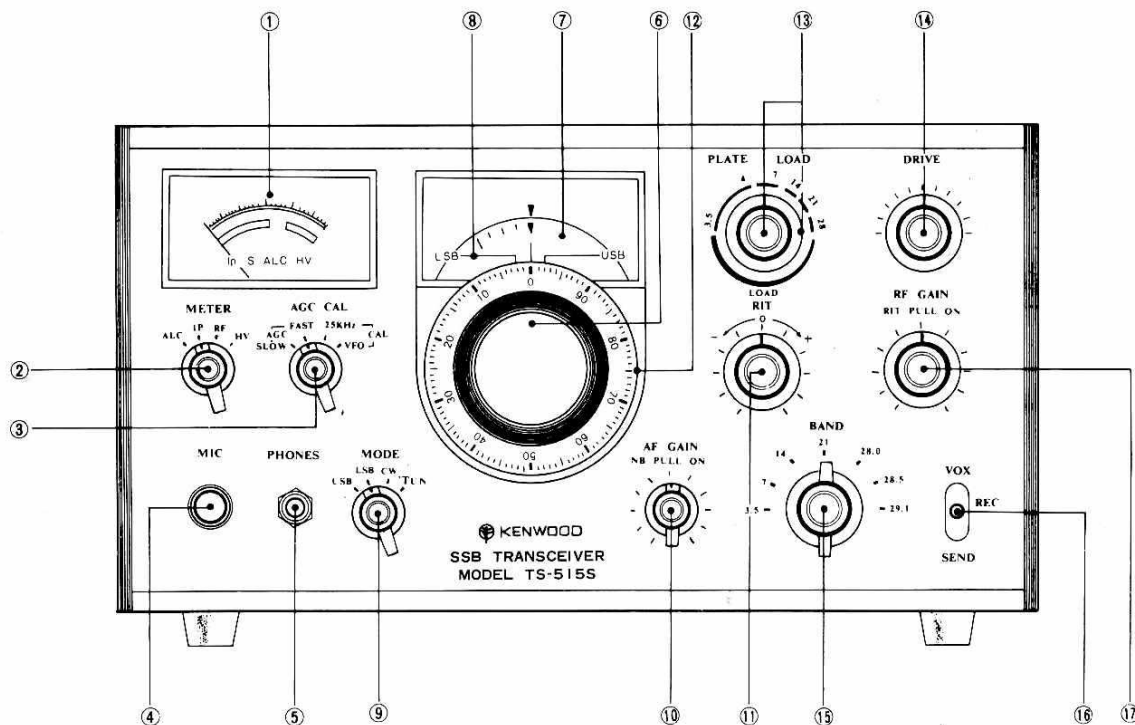

Fig. 5 TS-515S Front Panel Controls

**BIAS Adjustment (22 on Fig. 6)**

This controls the bias voltage of the 6LQ6 amplifier tubes. When the control is turned clockwise, the idling plate current will increase.

**FAN Socket (23 on Fig. 6)**

This socket should be connected to the PS-511S with the interconnecting cable. It provides the necessary voltage 117V needed to power the fan.

**ANT Antenna Jack (24 on Fig. 6)**

This socket should be connected to an antenna that presents a 50 ~ 75 ohm load. The jack is for the transmitting antenna if two antennas are used.

**ANT SW Antenna Switch (25 on Fig. 6)**

Set this switch to COMMON when a single antenna is used for both transmitting and receiving. Set this switch to REC (receive) when two separate antennas are used (one for transmitting and one for receiving).

**REMOTE Remote Control Socket (26 on Fig. 6)**

This socket permits various connections to a linear amplifier. The relay circuits are accessible through this socket. (See Section 3)

**KEY Jack (27 on Fig. 6)**

This is a two connector jack used to control CW operation.

**SG SW Screen Grid On-Off Switch (28 on Fig. 6)**

This switch is set to the OFF position when the operator wishes to remove screen grid voltage from the 6LQ6 tubes

for tuning and neutralization purposes. It is set to the ON position for normal operation.

**POWER Connector (29 on Fig. 6)**

Use the interconnecting power cable to connect the PS-511S AC power supply to the connector on the TS-511S.

**VFO OUT VFO Power Outlet (30 on Fig. 6)**

This socket powers the matching remote VFO. If the remote VFO is not used there is a jumpered plug in the socket at all times.

**2.3 INTERNAL CONTROLS**

**DELAY (31 on Fig. 7)**

This controls the VOX relay hold-in time.

**ANTI-VOX (32 on Fig. 7)**

This control allows the operator to adjust the anti-trip level of the VOX.

**VOX SENSITIVITY (33 on Fig. 7)**

This control varies the sensitivity of the VOX unit. These settings will vary with each individual operator and microphone.

**MICROPHONE GAIN (34 on Fig. 7)**

This controls the amount of microphone gain.

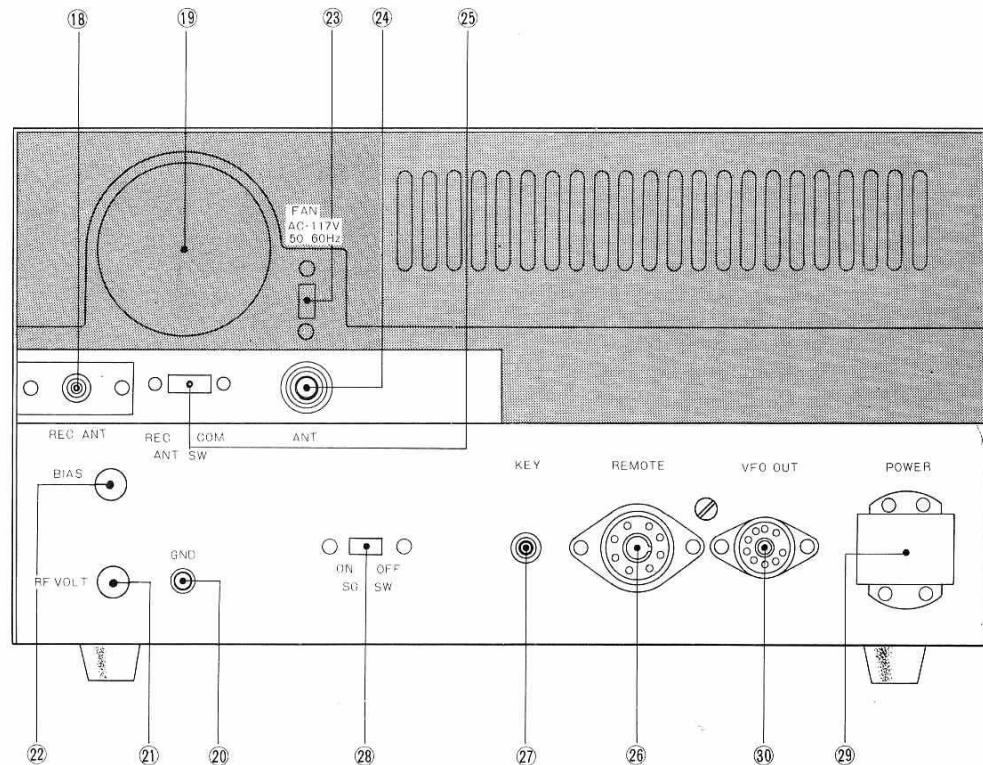

Fig. 6 TS-511S Rear Panel Controls

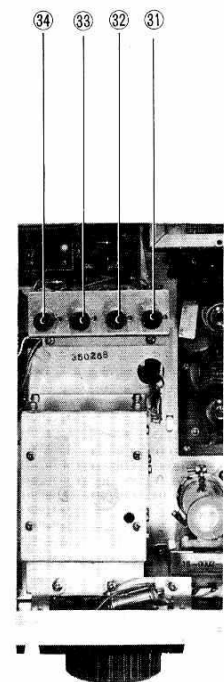

Fig. 7 TS-511S Internal Controls

## SECTION 3. OPERATING INSTRUCTIONS

### 3.1 RECEIVING

Place the transceiver's control in the following typical settings for receive operation. The 7 MHz band is used here as an example.

AF GAIN	Power OFF, noise blanker OFF
Stand-By Switch	REC
BAND	7 MHz
PLATE	7
LOAD	Fully counterclockwise
DRIVE	Centered
RIT	Centered
RF GAIN	Fully clockwise
RIT Switch	Push in
METER SWITCH	IP
AGC/CAL	SLOW
MODE	LSB
ANT SW	(rear panel) COM
SG SW	(rear panel) ON

Check the rear panel and make sure the VFO plug (See Fig. 8) is inserted. If the plug is not inserted, the internal VFO will not function on receive or transmit.

Turn the power on by advancing the AF GAIN knob in a clockwise direction. The meter and dial pilot lights are activated when power is applied. Allow about 40 seconds for initial warm-up. Advance the AF GAIN knob for a suitable audio level.

Adjust the DRIVE knob for maximum receiver sensitivity.

### 3.2 CALIBRATION

#### LSB

Turn the MODE switch to LSB. Set the AGC/CAL switch to 25 kHz. A calibrator marker tone will now be heard every 25 kHz. Turn the main tuning knob until the calibrator marker is heard. Tune the calibrator note until it is perfectly zero-beat (almost inaudible). Hold the main knob and slide the zero mark of the dial skirt to the LSB reference line on the plastic window.

#### USB

Turn the MODE switch to USB. Set the AGC/CAL switch to 25 kHz. A calibrator marker tone will now be heard every 25 kHz. Turn the main tuning knob until the calibrator marker is heard. Tune the calibrator note until it is perfectly zero-beat (almost inaudible). Hold the main knob and slide the zero mark of the dial skirt to the USB reference line on the plastic window.

#### CW

In case of operating with CW filter, turn the MODE switch to CW. Set the AGC/CAL switch to 25 kHz. A calibrator marker tone will now be heard every 25 kHz. Tune the calibrator note for maximum S-meter reading. When this is accomplished the calibrator tone will be approximately 700 Hz. Next, slide the zero mark of the dial skirt to the center CW reference line on the plastic window. When using without CW filter, the operations the same as LSB. And then, turn the main dial skirt clockwise by 700 Hz while holding the main tuning knob.

#### FREQUENCY READOUT

The frequency is easily read by adding 1 + 2 + 3.

1. Bandswitch Frequency (3.5 ~ 29.1 MHz)
2. Vernier Scale Frequency (0 ~ 600 kHz)
3. Dial Skirt Frequency (0 ~ 100 kHz)

This frequency readout method is only accurate when the RIT control is OFF or exactly centered on 0 kHz.

#### NOISE BLANKER

The noise blanker is especially useful and effective for impulse type noise.

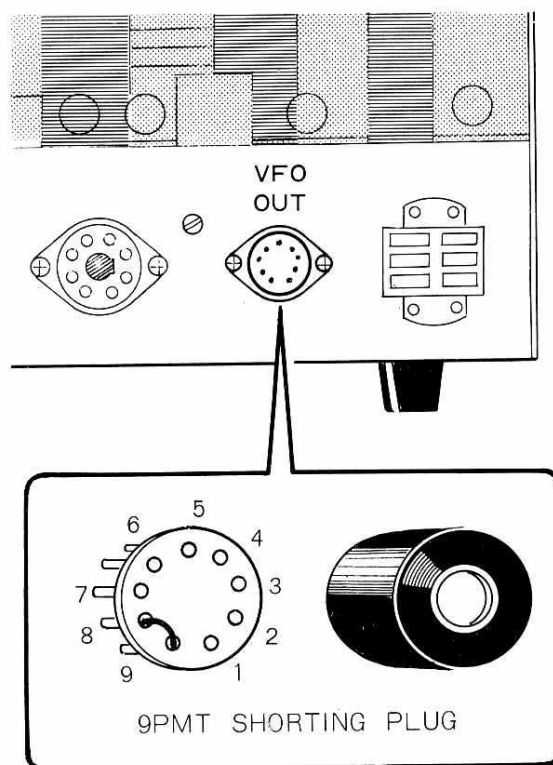

Fig. 8 VFO Plug Connections



### 3.3 TRANSMITTER TUNING

**CAUTION:**

*Do not exceed 450 ma. IP during CW transmission. Keep tune-up periods as short as possible. The SWR of the antenna used must be better than 1.5 : 1. Tube life is directly related to the SWR of the antenna as well as the duration of tune-up periods.*

*Make sure the fan is operating at all times or the life of the 6LQ6 output tubes will be noticeably shortened.*

**CAUTION:**

*The 150 volt output from pin 4 of the PS-515 is a critical parameter. If the voltage is too high the final tubes will be damaged. See the PS-515 manual for voltage adjustment.*

Place the transceiver's controls in the following typical settings for transmit operation. The 7 MHz band is used here as an example.

Stand-By Switch	REC
AF GAIN	Power ON
BAND	7 MHz
PLATE	7
LOAD	Fully counterclockwise
DRIVE	Centered
RIT	Centered
RIT Switch	Push in
RF GAIN	Fully clockwise
METER Switch	IP
AGC/CAL	SLOW
MODE	LSB
ANT SW	(rear panel) COM
SG SW	(rear panel) ON

Before initial tune-up it is suggested that the operator familiarize himself with the controls and their functions. The use of a 50 ohm dummy load antenna is also suggested to minimize interference to other amateur stations.

Turn the main tuning knob to the desired operating frequency. Set the stand-by switch to SEND. The meter should read 40 ma. idling current. If the meter does not read 40 ma., adjust the rear panel BIAS control (See Fig. 9) for a meter reading of 40 ma. Return the stand-by switch to REC.

Set the MODE switch to TUN, the meter switch to IP and the LOAD control to the mid-point of the load range (as marked on the front panel) for the selected band.

Set the stand-by switch to SEND, and adjust the DRIVE control to peak the meter (a maximum reading). Adjust the PLATE control for a dip ( a minimum meter reading). Turn the MODE switch to CW, the METER switch to RF, and carefully adjust the PLATE and LOAD controls alternately to peak the meter reading.

**NOTE:**

*The TUN position permits tuning of the final tank circuit at reduced power, without danger to the tubes. With the MODE switch in the TUN position, the screen grid voltage of the finals is reduced to approximately 33 volts and the keying circuit is shorted. Therefore the key need not be depressed for tune-up, even if it is connected to the KEY jack. The TUN position keys the transceiver to operate at the same transmit frequency at which it would operate in the CW position.*

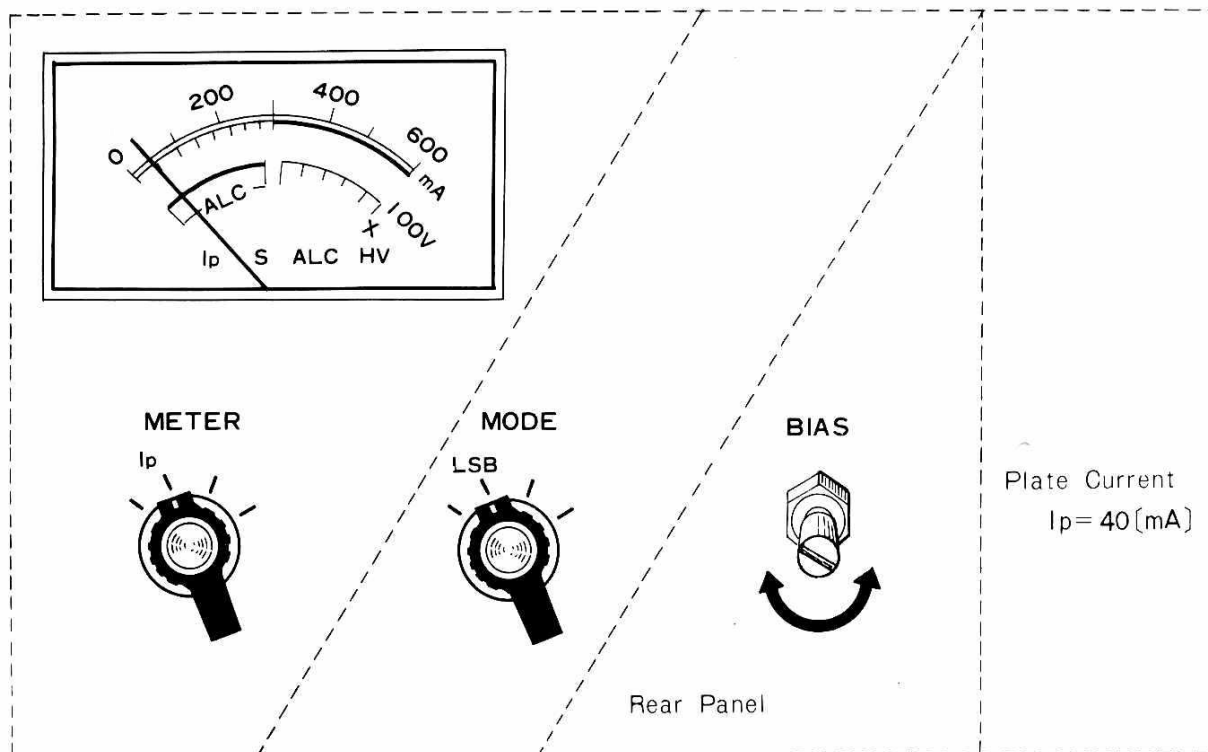

Fig. 9 Bias Voltage Adjustment Diagram

Set the stand-by switch back to REC. If there is not sufficient meter reading when tuning for maximum output, adjust the RF meter adjustment (See Fig. 10) for a 2/3 scale reading at maximum output.

Turn the MODE switch to LSB. Turn the METER switch to ALC. Connect a suitable microphone to the MIC connector. Set the stand-by switch to SEND. While talking in a normal voice adjust the microphone gain so that the meter reads within the ALC range.

### 3.4 VOX OPERATION

Set the stand-by switch to VOX. While talking in a normal voice slowly adjust the VOX SENSITIVITY control until the transmitter is voice actuated. Next, adjust the DELAY control for the desired hold-in time. Normally one second is considered to be a comfortable hold-in time. Next, turn the receive audio up to a suitable level and adjust the ANTI-VOX control until the receive audio does not activate the transmitter. The VOX unit is now properly adjusted.

### 3.5 PTT OPERATION

Set the stand-by switch to REC. Connect a suitable PTT microphone to the MIC connector. Simply press the PTT switch to transmit and release to receive.

### 3.6 CW OPERATION

For manual CW operation follow the instructions in the first six paragraphs of Section 3.3. Insert a key into the KEY jack on the rear panel. Turn the MODE switch to CW. For manual CW operation, set the stand-by switch to SEND. Do not hold the key down for more than 10 seconds at maximum output. To receive, set the stand-by switch to REC.

### 3.7 SEMI BREAK-IN CW OPERATION

For semi break-in CW operation follow the instructions in the first six paragraphs of Section 3.3. Insert a key into the KEY jack on the rear panel. Turn the MODE switch to CW. Set the stand-by switch to VOX. Send a string of dots and adjust the VOX SENSITIVITY control until the transmitter is activated by the key. Next, adjust the DELAY control for the desired hold-in time. The VOX should drop out between words for proficient operation. For CW operation it is not necessary to adjust the ANTI-VOX control.

## 3.8 OPERATION WITH A LINEAR AMPLIFIER

The TS-515S transceiver is readily compatible with most linear amplifiers. It has extra relay contacts for amplifiers which require external switching control. These accessory contacts are accessible through the REMOTE socket on the rear panel. The following relay contacts may be used in accord with the individual requirements of the chosen amplifier.

#### NOTE:

*Since most linear amplifiers normally require about 100 watts of drive for CW operation, the output of the TS-515S may be reduced accordingly by the following steps.*

*Follow the previous tune-up procedures for CW operation using a dummy load.*

*When the transceiver is tuned, the output may be reduced by slowly turning the DRIVE knob in a counterclockwise direction until the correct amount of drive is obtained. Normally the DRIVE knob will have to be moved only 1 or 2 increments on the DRIVE scale to reduce the output by 100 to 200 watts.*

*When SSB operation is desired, the DRIVE knob must be returned to its original position for maximum drive.*

#### REMOTE

Pin 5 is normally open in respect to ground. In the receive condition the relay contacts are open. In the transmit state the relay contacts are closed and shorted to ground. Pin 4 is connected to ground. Pin 3 is normally closed in respect to ground. In the receive condition the relay contacts are closed. In the transmit state the relay contacts are open.

#### NOTE:

*The use of LSB or USB is dependent upon the chosen band. The following combinations are customary:*

3.5 ~ 4.0	MHZ	LSB
7.0 ~ 7.3	MHZ	LSB
14.0 ~ 14.350	MHZ	USB
21.0 ~ 21.450	MHZ	USB
28.0 ~ 29.7	MHZ	USB

## SECTION 4. CIRCUIT DESCRIPTION

### 4.1 BLOCK DIAGRAM

The block diagram of the TS-515S transceiver is shown in Fig. 11. The transceiver is a hybrid type using 10 tubes, 1 IC, 41 transistors, and 57 diodes. Construction techniques feature fabricated printed circuit boards to simplify repair work and trouble shooting. The receiver employs a crystal controlled double superheterodyne configuration. The transmitter employs a dual conversion configuration using a filter type SSB generator.

### 4.2 CARRIER OSCILLATOR

The carrier oscillator is a 2 transistor solid state circuit. In transmit it acts as a carrier oscillator and in receive it acts as the BFO.

### 4.3 SSB GENERATOR

This circuit consists of a single stage FET amplifier and a 2 transistor audio amplifier. It uses a diode modulator and a single stage buffer. The DSB signal generated by this circuit is fed to the crystal filter where an SSB signal is obtained.

During CW operation, carrier is produced by unbalancing the diode modulator with a DC voltage.

### 4.4 IF SECTION

In transmit, the SSB signal is obtained by feeding the DSB signal through a crystal filter. It is then amplified and fed to the VFO mixer. The output of the VFO mixer is fed through a bandpass filter and then coupled to the driver.

### 4.5 DRIVER

During transmit, the IF signal is converted by the heterodyne mixer. The converted signal is amplified by a single stage amplifier and is fed to the final amplifier. During receive, the driver coils operate as antenna coils.

### 4.6 FINAL AMPLIFIER

This is the power amplifier. The signal from the driver is fed to the 6LQ6 power output tubes where the final RF output is obtained.

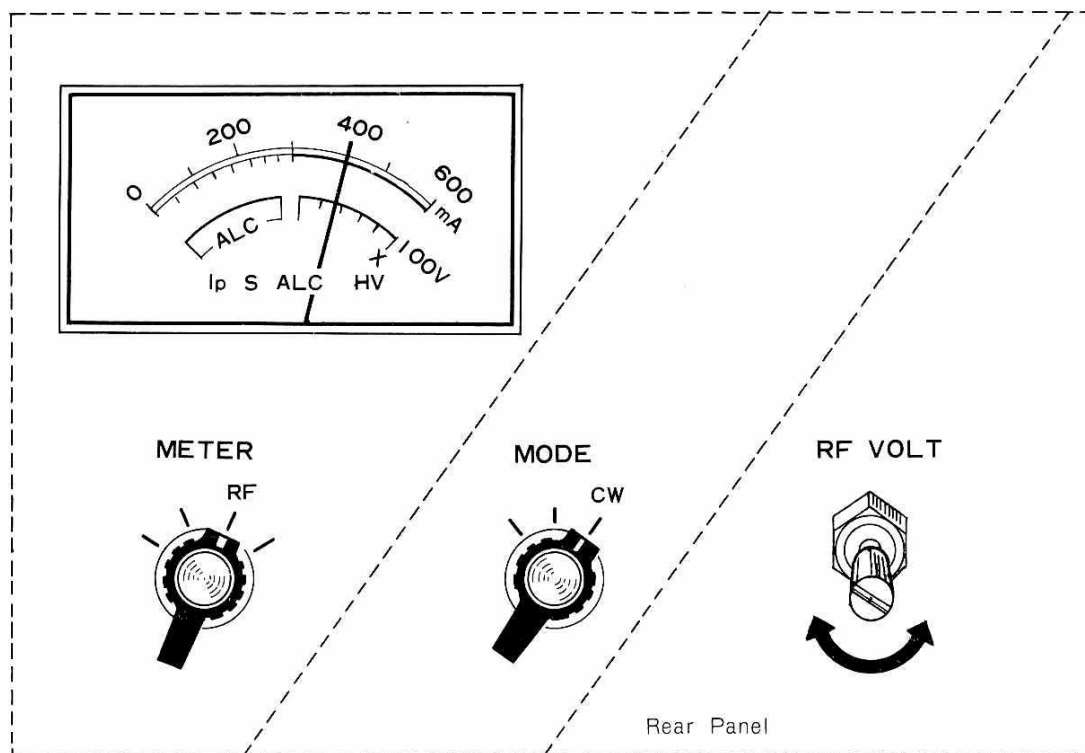

Fig. 10 RF meter Adjustment Diagram

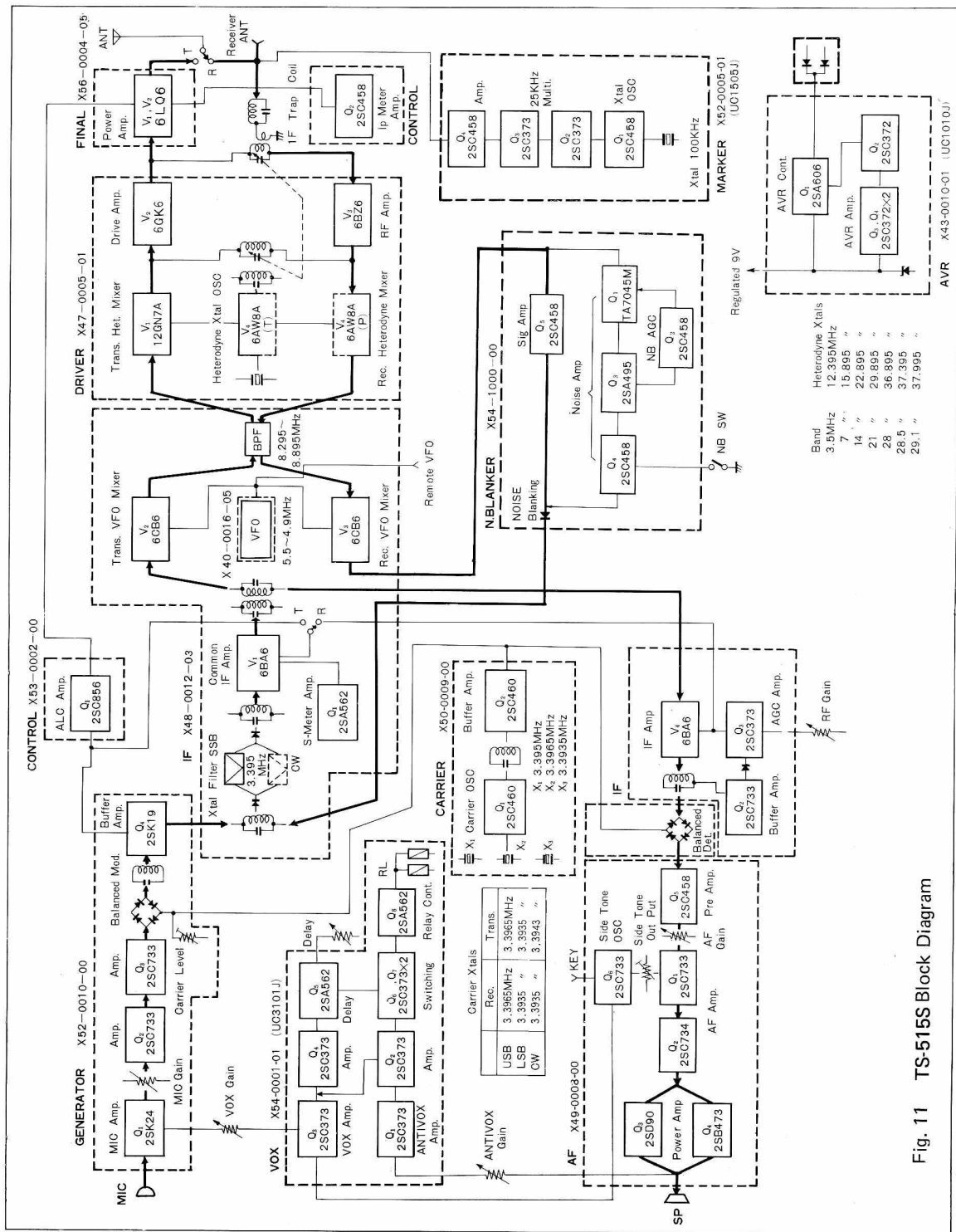

Fig. 11 TS-515S Block Diagram



## SECTION 5. ALIGNMENT

### CAUTION:

*Some circuits in the TS-515S carry high voltage and extreme care must be exercised to avoid electrical shock.*

### 5.1 REMOVING THE CASE

#### TOP COVER

Remove the single phillips screw between the two black plungers. Next, pull the black plungers upward. The cover can be removed by raising it slightly and pulling forward.

#### BOTTOM PLATE

Remove the nine phillips screws in the bottom plate. The four hyzex legs need not be removed.

### 5.2 ALIGNMENT POSITION

During alignment the transceiver should rest on its side (See Fig. 12). This position provides adequate ventilation and convenient access to most parts of the transceiver.

### 5.3 RECEIVER SECTION

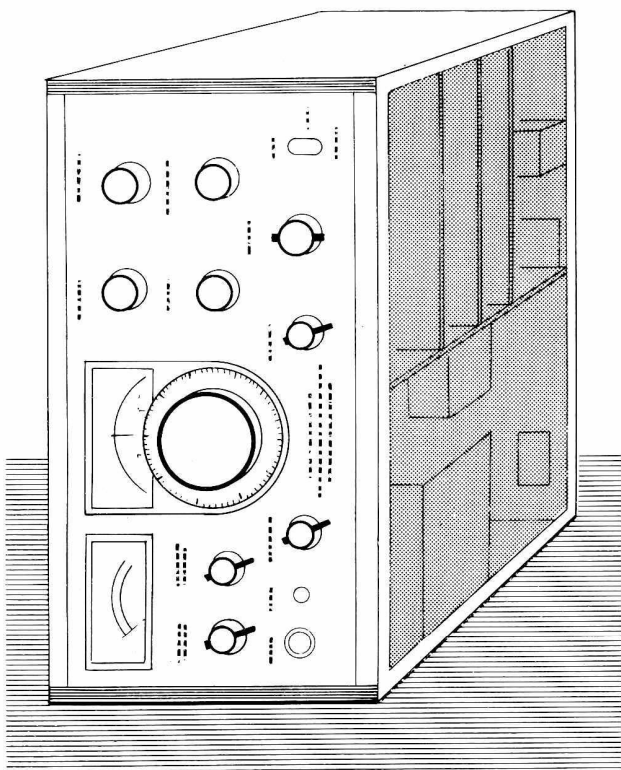

13 Fig. 12 Transceiver Position During Adjustment

### RF COIL ALIGNMENT

Set the AGC/CAL switch to 25 kHz and use the calibrator marker as the test signal. Set the DRIVE knob to the 12 o'clock position. Set the other knobs to their normal receive positions. Adjust the MIX and DRIVE coils (See Fig. 13) with the accessory tool for maximum S-meter reading at the receive frequencies given below.

Adjustment Order	Band	Frequency
1	3.5	3.75 MHz
2	28.5	28.8 MHz
3	21	21.225 MHz
4	14	14.175 MHz
5	7	7.15 MHz

### HETERODYNE CRYSTAL OSCILLATOR

Adjust the OSC coil (See Fig. 13) in a clockwise direction until the internal background noise disappears. Now turn the core one turn in the reverse direction. Oscillation will be unstable if the core is set too close to the critical point of oscillation. Adjust all bands in the following order.

Adjustment Order	Band	Frequency
1	3.5	12.395 MHz
2	7	15.895 MHz
3	14	22.895 MHz
4	21	29.895 MHz
5	28.5	37.395 MHz

The 28 MHz band requires only adjustment of the 28.5 MHz frequency range to obtain satisfactory oscillator outputs for all three 10 meter sub-bands.

### IF SECTION (See Fig. 14)

The large IF transformers (T1 and T2), the SSB crystal filter, and the small IF transformers require no adjustment. Turn the AGC/CAL switch to 25 kHz on any desired band. Set the other knobs to their normal receive positions. Tune the calibrator marker signal for maximum S-meter reading. Slowly turn the cores of T3 and T4 with the accessory tool and adjust for maximum S-meter reading. T4 is a dual-tuned IF transformer and is adjusted at the top and bottom of the chassis.

### CARRIER OSCILLATOR (See Fig. 15)

Disconnect the antenna and set the other knobs to their normal receive positions. Set the MODE switch to USB and set the AGC/CAL switch to 25 kHz. Tune in the crystal calibrator marker signal. Adjust the DRIVE knob for an S-meter reading of 9. Next, turn the main tuning knob clockwise for the S-meter reading of 2. At that point, adjust trimmer TC2 to obtain a zero beat.

Set the MODE switch to LSB and adjust TC3 as above.

Set the MODE switch to CW. Then set the SG SW switch on the rear panel to OFF. Set the stand-by switch to SEND. Set the METER switch to ALC and adjust the

DRIVE knob for maximum meter reading. Next, adjust TC1 for maximum meter reading.

MODE	Receive	Transmit
USB	3.3965 MHz	3.3965 MHz
LSB	3.3935 MHz	3.3935 MHz
CW (without CW filter)	3.3935 MHz	3.3943 MHz
CW (with CW filter)	3.3943 MHz	3.3950 MHz

#### AUTOMATIC VOLTAGE REGULATOR (See Fig. 16)

Set all knobs to their normal receive positions. An accurate DC voltmeter with a full scale of at least 10 volts is required. Connect the + lead of the voltmeter to the terminal located directly below VR2 at the top of the automatic voltage regulator board. Connect the - lead to the chassis and adjust VR1 for a voltmeter reading of 9 volts.

#### S-METER CALIBRATION

If the S-meter requires recalibration, set the BAND switch to 14, turn the noise blanker off, and set the RF GAIN control fully clockwise. With no antenna connected, set the zero adjust potentiometer, VR1 on the IF board (See Fig. 14) for a reading of zero on the S-meter.

Apply a 14.3 MHz signal from an RF generator, accurately calibrated to produce a  $32\mu\text{V}$  signal at the antenna jack of the TS-515S. Peak the S-meter for a maximum reading by tuning in the signal with the VFO and adjusting the DRIVE control. Then set the sensitivity potentiometer, VR2 (adjacent to VR1), for a meter reading of S-9.

### 5.4 TRANSMITTER SECTION

#### CAUTION:

*The 150 volt output from pin 4 of the PS-511S is a critical parameter. If the voltage is too high the final*

*tubes will be damaged. See the PS-515 manual for voltage adjustment.*

#### CARRIER LEVEL AND CARRIER BALANCE

(See Fig. 17)

Set the rear panel SG SW switch to OFF. Turn the MODE switch to CW. Turn the BAND switch to 14 and then set the main tuning dial at 14.175 MHz. Set the METER switch at ALC and set the stand-by switch to SEND.

Adjust the carrier level control until the voltage reads 460 ma. using the IP scale for reference. Now connect a dummy load to the ANT terminal. Set the SG SW switch to ON and quickly adjust the PLATE and LOAD controls for maximum output. Set the MODE switch to LSB and adjust the RF VOLT control on the rear panel for full sensitivity. Set the MIC GAIN to zero. If there is any meter reading, the circuit is not properly balanced. To balance the carrier, alternately adjust CT1 and VR2 on the SSB generator board (See Fig. 17) for minimum meter reading. Then turn the MODE switch to USB and repeat this adjustment so that the same amount of carrier suppression is obtained on both LSB and USB.

#### NEUTRALIZATION OF THE FINAL POWER AMPLIFIER

Connect a dummy load to the ANT terminal. Set the BAND switch to 28.5 and set the main tuning dial to 28.8 MHz. Next tune the transceiver for maximum output. Now set the SG SW switch to OFF and measure the output at the antenna terminals with a sensitive high frequency voltmeter. Adjust the neutralizing capacitor TC1 (mounted on the side panel of the final amplifier shielding box) for minimum output. Normally the shielding box does not have to be removed for neutralization.

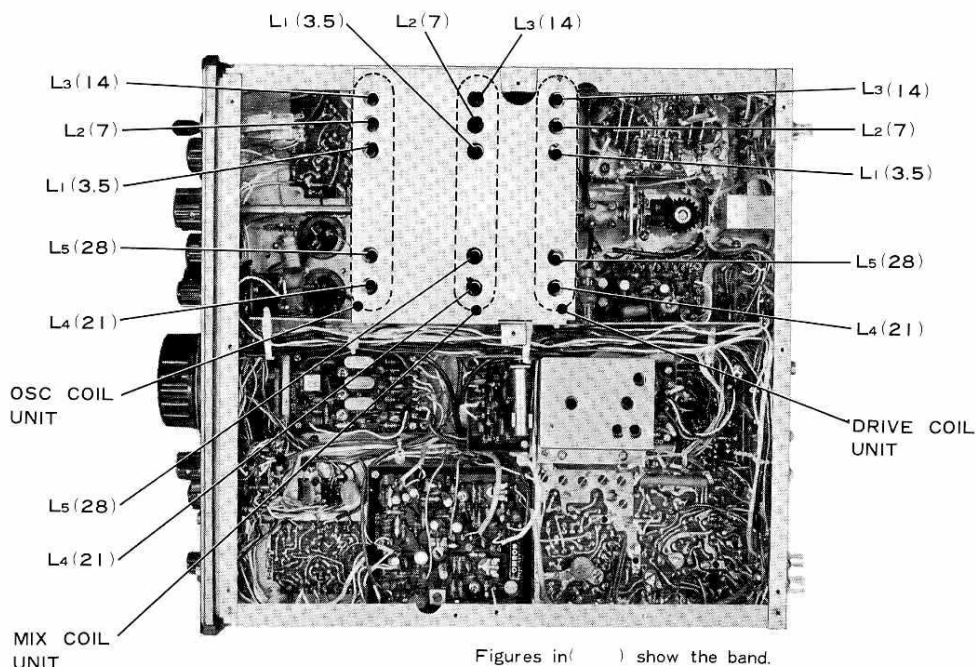
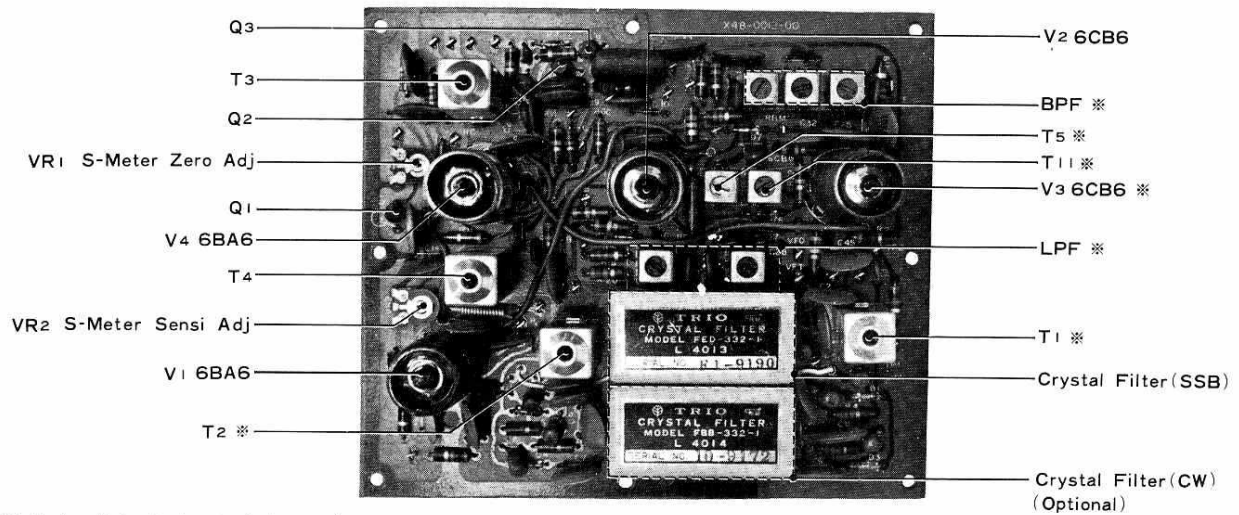

Fig. 13 Coil Location Diagram



\* Indicates that adjustment of these coils demands a high degree of skill and the coils should not be touched.

Fig. 14 IF Unit

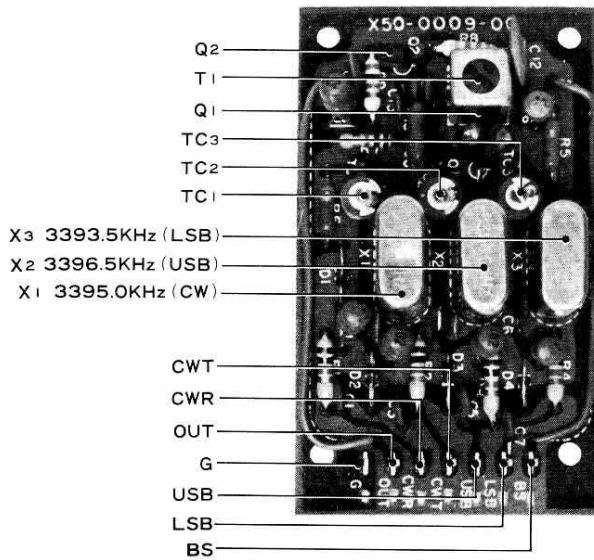

Fig. 15 Carrier Oscillator Unit

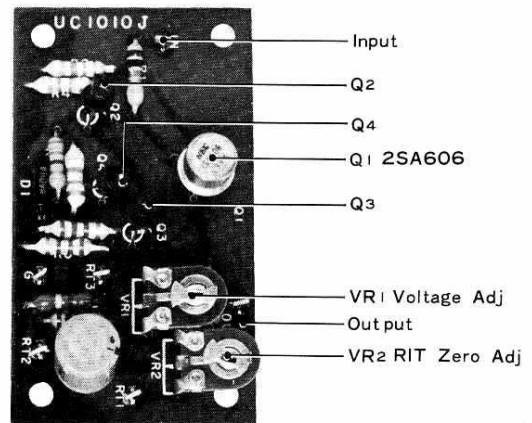

Fig. 16 AVR Unit

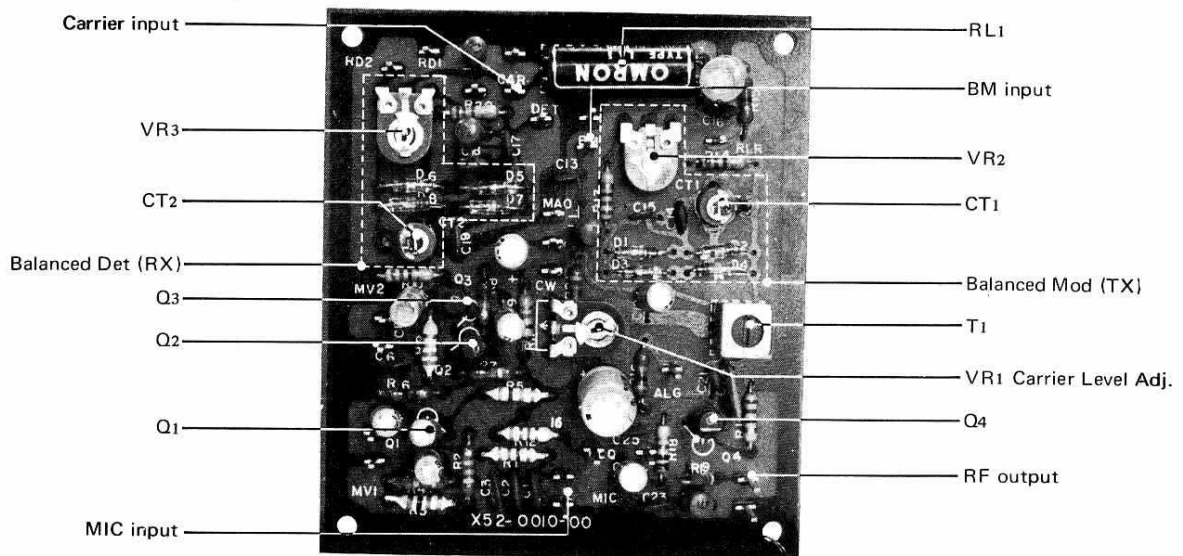

Fig. 17 Generator Unit

---

## SECTION 6. TROUBLE SHOOTING

---

### 6.1 TRANSMIT

Symptom	Cause	Corrective Action
No output in any mode.	Voltage is not applied to the screen grid of the final stage.	Set the rear panel SG SW switch to on.
	The external VFO plug is not inserted.	Insert the plug.
No indication of any modulation.	The microphone plug is wired incorrectly or improperly seated in the MIC jack.	Check the MIC plug wiring and make sure the MIC plug is firmly seated in the jack.
	The MIC GAIN is set too low.	Turn the MIC GAIN control in a clockwise direction.
RF output present but no meter reading in the RF position.	The RF meter adjustment is set too low.	Turn the RF control on the rear panel in a clockwise direction.
VOX does not function	VOX SENSITIVITY control is set too low.	Turn the VOX SENSITIVITY control in a clockwise direction.
	The stand-by switch is set to REC or SEND.	Set the stand-by switch to VOX.
VOX is tripped by receive audio from the speaker.	The ANTI-VOX control is improperly set.	Turn the ANTI-VOX control in a clockwise direction.
Fuse blows after about 10 seconds of transmission.	Final amplifier is detuned.	Retune to obtain proper resonance.
		Adjust the rear panel BIAS control for 40 ma. of idling current.

### 6.2 RECEIVE

Pilot lights do not light and no receive audio is heard when power is turned on.	AC plug is not seated in the AC receptacle.	Insert securely.
	Power cable is not properly.	Insert securely.
	Fuse is blown.	Replace the fuse.
No signals can be heard even through the antenna is connected.	ANT switch on the rear panel is set to REC.	Set the ANT switch to COM.
Frequency can not be changed with the RIT control.	RIT circuit is off.	Turn the RIT circuit on by pulling the RF GAIN knob.
No signals can be heard and the S-meter reads full scale.	RF GAIN has been lowered.	Turn the RF GAIN fully clockwise.
SSB signals sound garbled and unintelligible.	The MODE switch is set to the wrong sideband.	Turn the MODE switch to the opposite sideband.



### Voltage Measurements of Tubes and IC's

(In Volts)

Unit	Pin No.		1	2	3	4	5	6	7	8	9	P
FINAL	V1 6LQ6	T R	150	-55 -75	0.22 0	0	(6.3)	-55 -75	150	0		840 970
	V2 6LQ6	T R	150	-55 -75	0.22 0	(6.3)	(12.6)	-55 -75	150	0		840 970
DRIVE	V1 12GN7A	T R	2.3 0	-38.5	0	(12.6)	(12.6)	(6.3)	285 290	.70 133	0	
	V2 6GK6	T R	6 0	0 -38.5	0	(12.6)	(6.3)	0	285 310	195 200	0	
	V3 6BZ6	T R	0 -0.06	.96 0.95	(6.3)	0	285 290	.95 66	0			
	V4 6AW8A	T R	0	-7.5 -7.5	150 150	0	(6.3)	0 4.2	-47 0	150 144	150 138	
IF	V1 6BA6	T R	-7.0 -0.1	0	(6.3)	(12.6)	145 130	145 130	0.4 1.9			
	V2 6CB6	T R	0 -37	1.7 -17	0	(6.3)	150 150	65 148	0			
	V3 6CB6	T R	-47 0	-23 2.0	0	(6.3)	150 148	150 80	0			
	V4 6BA6	T R	0 -0.1	0	(6.3)	(12.6)	150 130	150 130	70 2			
NB	Q1 TA7045M	R	11.6	2.3	0	1.5	3.4	3.4	6.7	18.5		

**NOTE:**

1. Voltage values obtained with the VTVM having 11 MΩ of input impedance.
2. T: Maximum transmitting condition (CW) R: Reception with no input
3. The value in ( ) denotes the AC voltage and others are DC voltages.
4. VOX voltage values measured with the stand-by switch at VOX position in CW mode.
5. Final power tubes V1 and V2 receive approximately 33 volts at pins 1 and 7 when the MODE switch is in the TUN position.

### Voltage Measurements of Transistors

Unit	Transistor		Transistor's Emitter or Source	Transistor's Collector or Drain	Transistor's Base or 1st Gate	2nd Gate	Unit	Transistor		Transistor's Emitter or Source	Transistor's Collector or Drain	Transistor's Base or 1st Gate	2nd Gate
VFO	Q1 3SK22	R	0.2	8.8	0	0	GENE- RATOR	Q3 2SC733	T R	1.4	5	2	
	Q2 2SK19	R	0.6	8.8	0			Q4 2SK19	T R	0.72 0	12 0	-0.33 0	
	Q3 2SC460	R	2.3	8.8	3		CON- TROL	Q1 2SC856	T R	-48 -68	-2.9 0	-48 -68	
	Q4 2SC460	R	1.0	8.8	2.3			Q2 2SC458	T R	0.35	9	0.95	
AVR	Q1 2SA606	T R	13.5 15.2	9	13 14.6		VOX	Q1 2SC373	T R		0.15	0.67	
	Q2 2SC372	T R	5.2	9	5.8			Q2 2SC373	T R		0.35 0	0.04	
	Q3 2SC372	T R	5.2	5.8	5.8			Q3 2SC373	R	0.6	6	1.2	
	Q4 2SC372	T R	5.2	9.0	5.8			Q4 2SC373	T R		0.31 8.4	0.35 0	
IF	Q1 2SA562	T R	2	0	1.6			Q5 2SA562	T R	0.58 8.4		0.31 8.4	
	Q2 2SC733	T R	8.5 9.4	16.4 18	8.5 9.5			Q6 2SC373	T R	4.5 5.4	8.5 6	0.3 6	
	Q3 2SC373	T R	-28.5 -29	0 -0.04	-28.1 -28.6			Q7 2SC373	T R	4.5 5.4	14.6 18.5	5.1 3.7	
AF	Q1 2SC733	R	2.8	5.9	3.4			Q8 2SA562	T R	16 18.5	16 0	15.5 18.5	
	Q2 2SC734	R	0.4	8.7	1.0		MARK- ER	Q1 2SC458	R	0.05	9	0.7	
	Q3 2SD90	R	8.7	17.8	9.2			Q2 2SC373	R		1.9	-0.2	
	Q4 2SB473	R	8.6	0	8.5			Q3 2SC373	R		6.9	-2	
	Q5 2SC458	T R	0.92 0.3	8.7 7	0.93 0.9			Q4 2SC458	R	0	8.1	0	
	Q6 2SC733	T R	1.7	11 13	2.3		NB	Q2 2SC458	R	0	6.4	0.4	
CAR- RIER	Q1 2SC460	R	0.9	9	1.5			Q3 2SA495	R	18.5	0.4	18.5	
	Q2 2SC460	R	1.3	9	2			Q4 2SC458	R	0	3.7	0	
GENE- RATOR	Q1 2SK24	T R	0.6	8	0		Q5 2SC458	R	3.1	18.5	3.8		
	Q2 2SC733	T R	0.4	2	1								

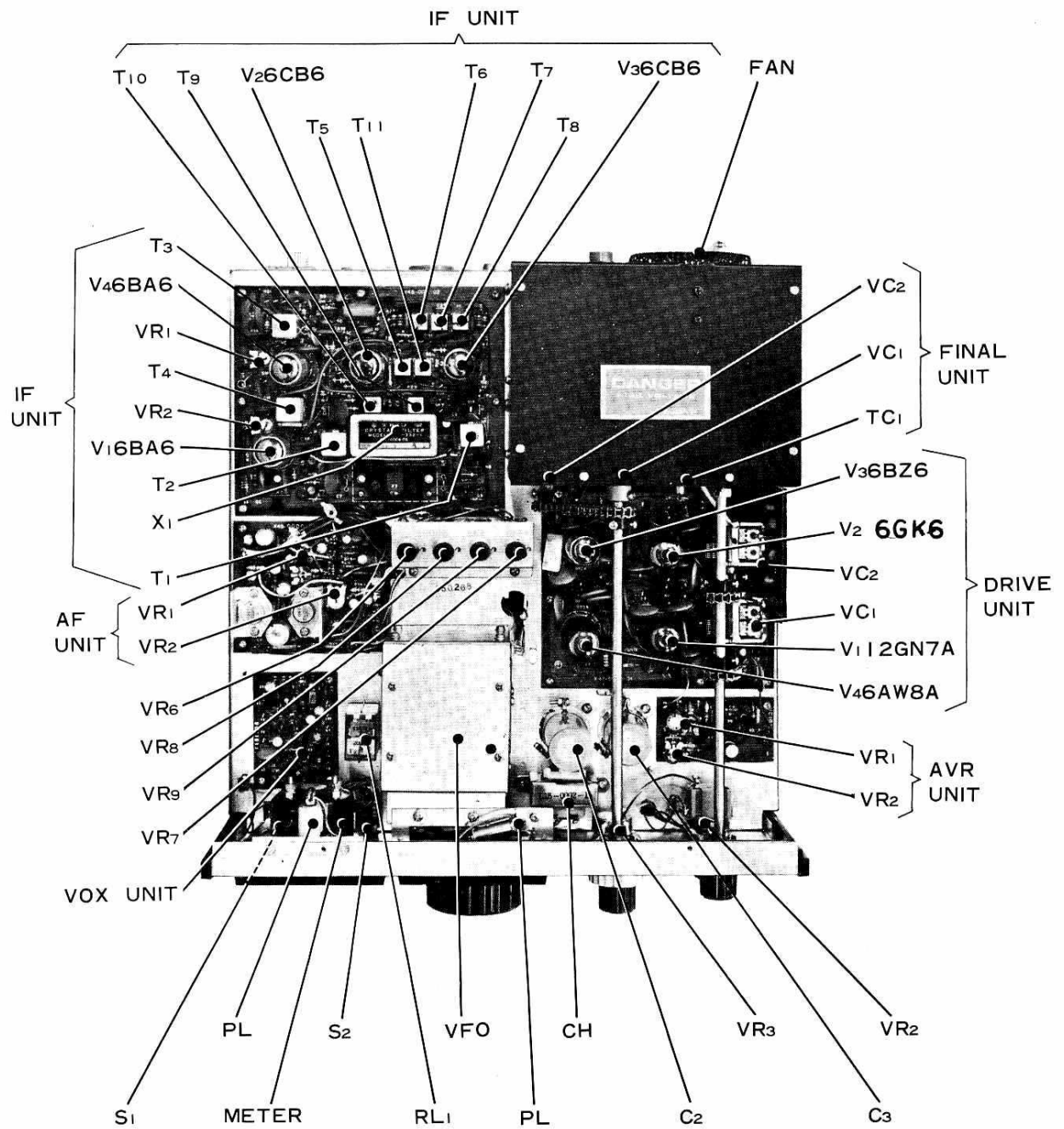

Fig. 18 Chassis Top View







# SCHEMATIC DIAGRAM

Q<sub>1</sub> 25A562(Y), Q<sub>2</sub> 25C733(Y), Q<sub>3</sub> 25C373.

60, D<sub>8,9</sub> 0F90, D<sub>10</sub> 1S1555

3A, D<sub>11</sub> M-13,

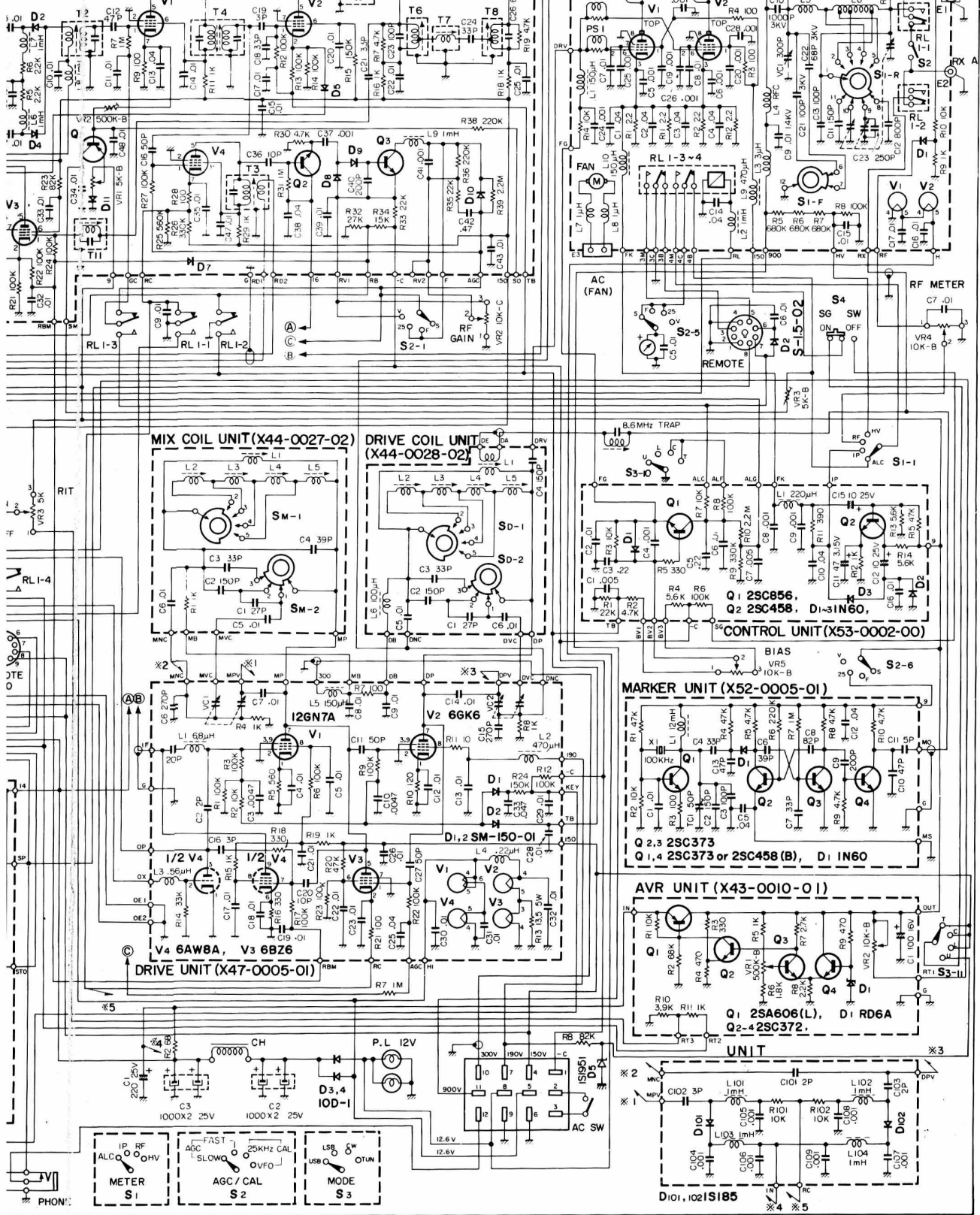

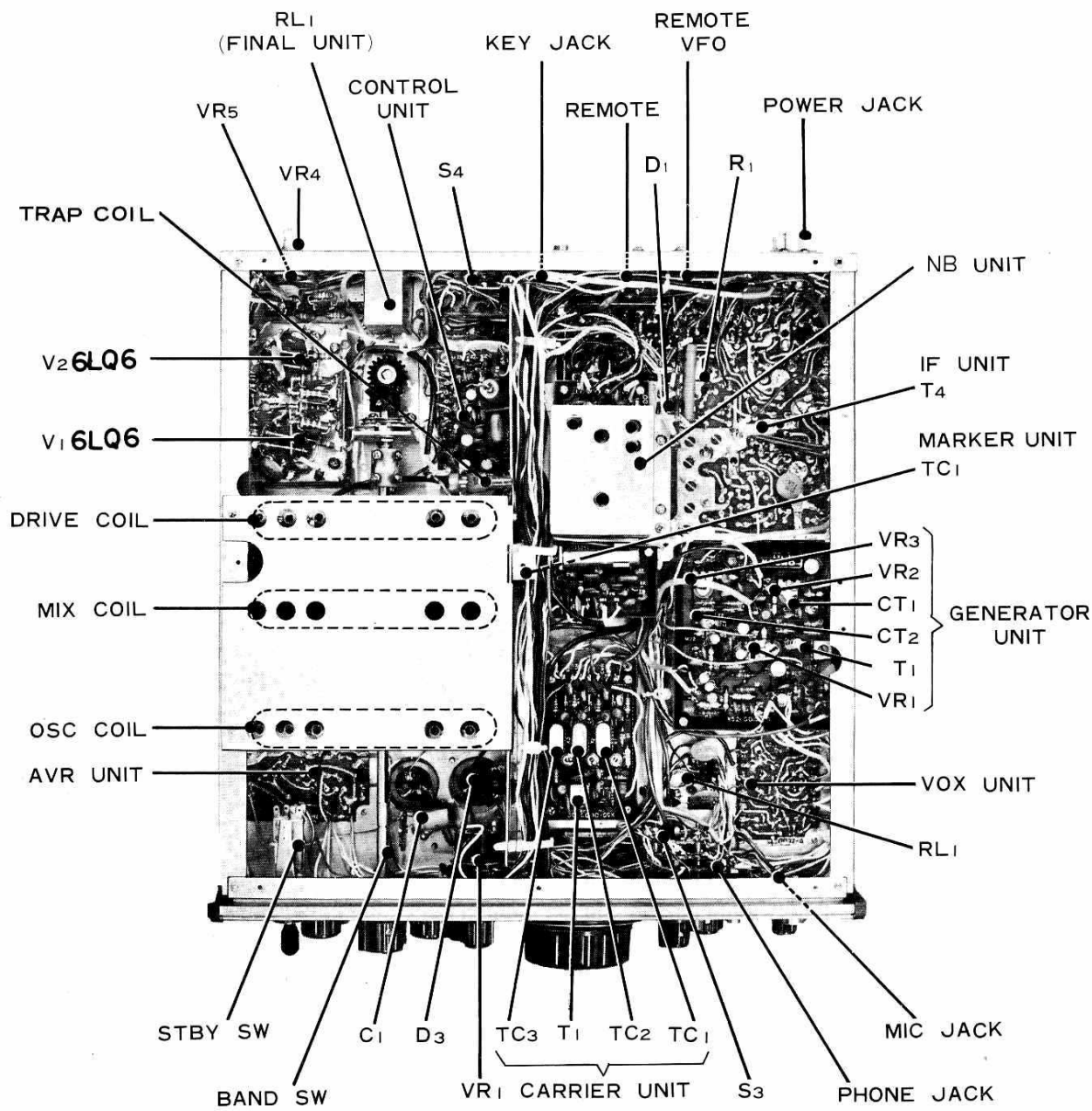

Fig. 19 Chassis Bottom View



Manufactured by TRIO ELECTRONICS, INC., Tokyo, Japan