

# TR-7200G

2METER FM CAR TRANSCEIVER

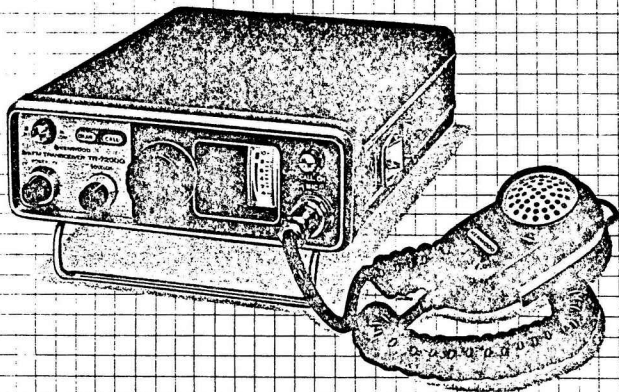

OPERATING MANUAL

TR-7200G FM Car Transceiver is designed for use in the 144 MHz amateur band. The unique design of the TR-7200G also permits utilization as fixed-station equipment. The TR-7200G is high quality and performance through our elaborate VHF techniques. The transceiver employs F3 type emission with 22 channels in addition to crystal control and external VFO terminal for both transmit and receive. Maximum transmit output is 10 watts.



## TR-7200G OPERATING MANUAL

### CONTENTS

SPECIFICATIONS .....	3
SECTION 1. PRIOR TO OPERATION .....	4
SECTION 2. CONTROLS .....	5
SECTION 3. INSTALLATION .....	6
SECTION 4. OPERATION .....	9
SECTION 5. PRECAUTION .....	13
BLOCK DIAGRAM .....	14
CHASSIS VIEW (1) .....	15
CHASSIS VIEW (2) .....	16
SCHEMATIC DIAGRAM .....	17

Page 3 is missing. Sorry!

# SECTION 1. PRIOR TO OPERATION

## 1-1 UNPACKING

Carefully unpack the TR-7200G transceiver and check that the following accessories are included.

Microphone (dynamic) .....	1
Mounting bracket (for mobile use) .....	1
Stand-off leg .....	1
Spare fuse (4 A) .....	1
DC power cord (with fuse and plug) .....	1
Small single-tip plug .....	1
Mounting parts	
Bolt (6φ) .....	4
Washer (6φ) .....	4
Spring washer (6φ) .....	4
Nut (6φ) .....	4
Crystal unit (pre-installed in the set)	

Table 1

Channel	Transmit	Receive
R6	145.150 MHz	145.750 MHz
R7	145.175 MHz	145.775 MHz
R8	145.200 MHz	145.800 MHz
20	145.500 MHz	145.500 MHz
22	145.550 MHz	145.550 MHz

## 1-2 INSTALLATION

The TR-7200G transceiver employed as a mobile station must be securely attached to the bottom of the dashboard using the accessory mounting bracket and bolts. Improper installation will result in damage to the set and dashboard of the vehicle due to vibration encountered during vehicle operation. Consideration must be given to the dashboard material prior to installation. More detailed information on installation is found in par. "3-1 mobile use".

## 1-3 ANTENNA

The output impedance is  $50\Omega$ , therefore mount a  $50\Omega$  antenna on the vehicle with a  $50\Omega$  coaxial cable. The length of cable should be as short as possible. The antenna employs the M-type connector. Any antenna for mobile use available on the market may be employed: 1/4 wavelength whip antenna, ground plane, 5/8 wavelength antenna, etc.

The  $50\Omega$  impedance, for both antenna and feeder, also applies to fixed-station installation. The most popular antenna is a Yagi array with a rotating mechanism. This antenna is very effective in both transmit gain and directional radiation of the signal. It is recommended that the Yagi antenna be vertically erected, since the vertically polarized wave is typical of the 144 MHz band.

Page 5 is missing. Sorry!

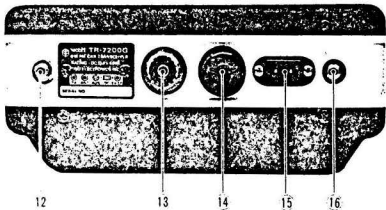

Fig. 2 Rear Panel

- 12 **P A Terminal**  
This is an external speaker connector for P A.
- 13 **ANT Connector**  
Output impedance is 50Ω.
- 14 **External VFO and AUX Connector**  
This is an input connector when used with ar and used for voltage check.
- 15 **DC Connector**  
Accommodates accessory power cord plug to
- 16 **EXT. SP Connector**  
Connects accessory plug in operation of set speaker.
- 17 **Stand-off Leg**  
When the transceiver is used as a fixed stati accessory stand-off leg as shown in Fig. 3.
- 18 **Lock**  
Used to mount the set to the accessory moi by simply flipping onto bracket. Prevents t locked.
- 19 **Mounting Rail**  
Used as a guide in installation on the bracket

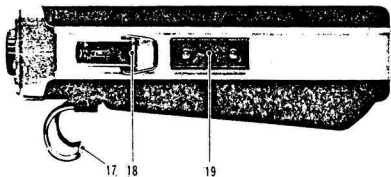

Fig. 3 Side Panel

### 3. Installation in Positive Grounded Vehicle

All positive grounded vehicles require electrical insulation of the set from the vehicle chassis, since the set is negatively grounded. Insulation can be accomplished by grounding the outer conductor of the coaxial cable via a 0.001 $\mu$ F capacitor (mica capacitor) as illustrated in Fig. 5.

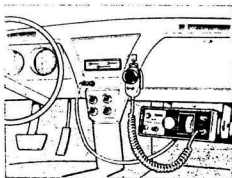

Fig. 4 Installation on the Car

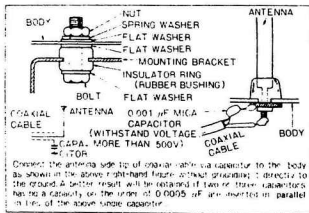

Fig. 5 Installation on the Positive Grounded Car

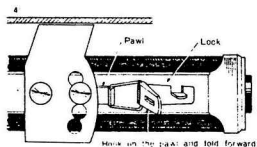
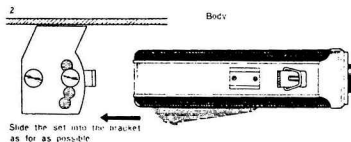
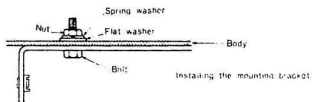

Fig. 6 Installing the Set on the Car

#### 4. Mobile Antenna

A variety of 2 meter antennas is available on the market for mobile operations. For example, a magnet-mounted whip antenna and clamp-mounted whip antenna.

The installation types are classified as the vacuumdisc mount, magnet-mount, gutter-mount, etc. The type of antenna employed depends on the type of vehicle. With either type, the antenna must be sufficiently secured to resist wind pressure when installed.

Connection of the antenna to the transceiver should be with a 50Ω coaxial cable, run in the gutter, into the vehicle interior through the fender seam. The cable should be secured to the vehicle body at certain intervals required to prevent the cable from dangling.

A coaxial cable passed through the door will eventually be damaged by the repeated closing and opening of the door. The outer sheath may remain stout but the core conductor or connection at the root of the antenna will become open.

#### 5. Connecting the Power Supply

Connect the transceiver to the battery posts using the accessory power cord. Place the red lead on the positive post and the black lead on the negative post. Insure that the connections to the battery posts are secure. Loose connections will not only affect the performance of the transceiver but the vehicle as well.

The cable should be secured to the vehicle body at appropriate points to avoid dangling. Surplus lengths of cable should be cut off. An alternate method of obtaining power is via the cigar lighter provided in most vehicles, utilizing the plug shown in Fig. 7. This plug is available at auto accessory shops or the car corner of department stores.

### 3-2 FIXED-STATION USE

When the transceiver is to be employed as a fixed-station, attach the accessory stand-off leg to the transceiver as shown in Fig. 3. The TR-7200G is designed as a DC-powered instrument, therefore a DC power supply must be provided. The required current is approximately 3A.

Recommended power supply units include the PS-5, rated for employment with the TR-7200G. The power supply voltage should be correctly adjusted to the rated value (13.8V standard) of the transceiver.

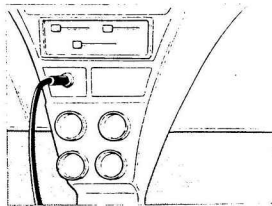

Fig. 7 Use of Cigar Lighter



# SECTION 4. OPERATION

## 4-1 OPERATION

TR-7200G Car Transceiver is operated utilizing the following procedures:

1. Connect power, antenna and microphone to the set. Since the power cord has (+) and (-) polarity, confirm proper polarity when connecting the cord to the battery posts and set. (Refer to Fig. 8.)
2. Depress the POWER/VOL knob on the front panel. The channel indicator window will then indicate the number of the selected channel. Then turn the knob clockwise to obtain operating noise. Position the knob to the point at which any appropriate sound volume is obtained. No sound comes out of the SQUELCH/PA knob is set in the PA position.
3. Set the main knob to "20". This is the 145.50 MHz channel.
4. Slowly turn clockwise to effect the squelch until the internal noise disappears from the speaker. This adjustment should be made on the Xtal contained channel with no input signal.
5. The speaker will produce the sounds with the input signal. With no input signal, sound will not be heard from the speaker because of the squelch activated. The signal strength meter will deflect with changes in the strength of the input signal.
6. Depress the PTT switch on the microphone to transmit, and the ON AIR lamp will light. Hold the microphone close to the mouth (approximately 3 inches to the microphone) when speaking.

NOTE: The operational condition of the antenna system is observed from the SWR meter. A good antenna system should be produced an SWR reading of less than 1.5. Transmission output will be lowered if the SWR level is extremely bad. (due to the protective circuit included). TR-7200G FM Car Transceiver is designed to indicate 8 on the meter when 10 watts of RF output appears across the power meter with an impedance of 50Ω. An acceptable SWR for the antenna system should therefore be an indication near this value. In this sense, the meter deflection may be utilized as an SWR meter.

7. In addition to "20", this transceiver contains crystals permitting selection on "R6", "R7", "R8" and "22". As to channel numbers and their frequencies refer to Table 2 on page 10.
8. CALL channel  
Use this channel to contact a relay station. Keep the CALL channel switch pushed for some seconds before transmission to transmit the signal modulated by 1,750 Hz with which the relay station is activated.

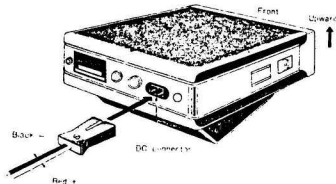

Fig. 8 Power Cord Connection

#### 9. HI/LOW

QSO between locals can be enjoyed with less interference and power consumption by reducing the output power to only the required value. This is accomplished by depressing the HI/LOW pushbutton switch, which reduces power from the normal 10 watts to approx. 1 watt, with the meter lighting turning to green. The ON AIR lamp will remain unchanged in luminous intensity, whereas the meter indication will drop to 2. In the LOW position, the protection circuit does not work, but no trouble occurs.

#### 10. P A (Public Address)

The TR-7200G car transceiver can also be used as a loud speaker. Connect the speaker plug to the PA connector on the rear panel and set the SQUELCH/PA knob to the PA position. While speaking, do not press the push-switch on the microphone. The sound level of the PA speaker can be adjusted with the POWER/VOL knob.

### 4-2 EXTERNAL VFO AND AUX CONNECTOR

As external VFO connector

An external VFO can be connected to this connector. In this case the channel should be set to "VFO" position.



Fig. 9 AUX Connector Configuration

### PRECAUTIONS

1. Do not set the transceiver to the transmit mode with the ANT connector terminals shorted or the antenna disconnected to prevent damage to the RF power transistor.
2. Do not place the transceiver near the vehicle heater vent.
3. Although the transceiver is designed to withstand long continuous transmission, it is recommended that an occasional cooling off period be permitted.
4. Power supply voltage for fixed-station operation of the transceiver should not be exceeded 13.8V.
5. When the transceiver fails, contact the nearest our service station for repair. Ferrite cores and trimmer capacitors are factory-adjusted and do not require adjustment.

### 4-3 CHANNELS & DIAL INDICATION

Channel Table 2

FM repeater channels			FM simplex channels	
Channel	Transmit	Receive	Channel	T & R
R0	145.000 MHz	145.600 MHz	◊ 20	145.500 MHz
R1	145.025 MHz	145.625 MHz	21	145.525 MHz
R2	145.050 MHz	145.650 MHz	◊ 22	145.550 MHz
R3	145.075 MHz	145.675 MHz	23	145.575 MHz
R4	145.100 MHz	145.700 MHz	24	145.600 MHz
R5	145.125 MHz	145.725 MHz		
◊ R6	145.150 MHz	145.750 MHz		
◊ R7	145.175 MHz	145.775 MHz		
◊ R8	145.200 MHz	145.800 MHz		
R9	145.225 MHz	145.825 MHz		

◊ : Crystals are provided.

The dial indication of channel numbers are shown on Table 2. Frequencies of the built-in crystals may change according to this Table.

In addition to these channels, there are A, B, C, D, E, F, G and VFO. These channel numbers are visible through the channel indicator window. The channel marked with □ is not classified a channel due to the structural limitation of the selector switch.

## 4-4 CHANNEL EXPANSION

### 1. Crystal Installation

Utilize the following procedures to provide additional channel crystals. First, remove the two upper and lower screws, then the top cover. Disconnect the speaker cord and extract the set from the casing.

The transmit crystals are installed on the upper row. Channel arrangement and the corresponding adjustment trimmers are as illustrated on the back of the top cover.

Sockets marked with ※ are not for crystal installation. The receive crystals are installed on the lower row in the same manner.

### 2. Frequency Adjustment

When a new channel is added, it must be frequency-adjusted with a frequency counter as follows.

#### a) Adjustment with a Frequency Counter

##### RX (Reception)

Connect the counter as shown in Fig. 10.

$$\text{Counter frequency} = \text{Channel frequency} - 10.7$$

##### TX (Transmission)

Connect the counter as shown in Fig. 11 on page 12, and adjust the trimmer corresponding to the channel until the counter reads the proper channel frequency.

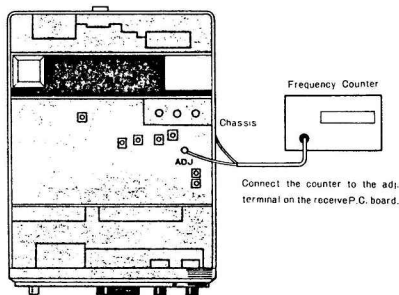

Fig. 10 Adjusting RX Section

b) **Adjustment without a Frequency Counter**

The TR-7200G car transceiver is provided with a center-meter connector, through which the set can be adjusted to the desired frequency. Connect a center-meter of  $\pm 50 \mu\text{A} \sim \pm 100 \mu\text{A}$  to the center-meter connector (pin 9) as shown in Fig. 12.

**(Receiving Frequency Tuning)**

If another station has precisely tuned in its transmitting frequency, utilize the signal of another station and adjust the trimmer capacitor until the center-meter does not deflect.

**(Transmitting Frequency Tuning)**

In case the partner station is exactly tuned in the receiving frequency and the station of this side is connected with the center-meter, the trimmer capacitor should be adjusted on the transmitting side to a point where the partner station can receive a clear signal.

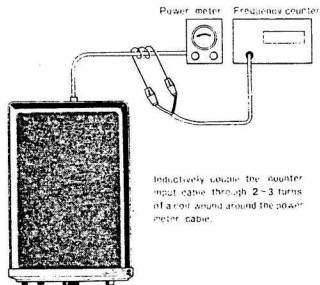

Fig. 11 Adjusting TX Section

## 4-5 TROUBLESHOOTING

When the TR-7200G fails, contact our service station for repair. All trimmers and coils are factory-adjusted and should be repaired by a qualified engineer.

## 4-6 PROTECTION OF FINAL TRANSISTOR

The power transistor in the final stage is protected by AVR and SWR controls. Unlike conventional systems which may stop emission of waves when the protection circuit is actuated, this circuit will reduce transmission output according to the SWR value. If efficiency of emission is not good, the antenna system should be checked carefully. For example, if the antenna circuit is open (SWR infinity) in the transmission mode, the RF meter indication will be lowered and final collector voltage will be about 4 volts. Since the burden is reduced in this way, the transistor can be protected against damage.

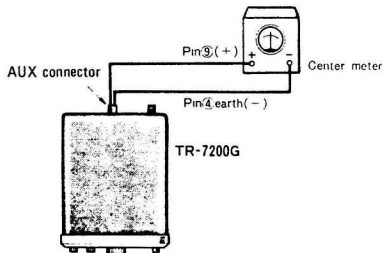

Fig. 12 Adjustment of the Frequency by Use of Center Meter

## SECTION 5. PRECAUTION

In concluding the operating instructions of the TR-7200G FM Car Transceiver, reference is made to certain rules that should be followed for more enjoyable mobile operation:

1. The mobile operator always exercises utmost caution in the safe operation of the vehicle; he interrupts mobile communication whenever the danger of an accident exists.
2. The mobile operator is always aware of the crowded conditions of roads, express ways, sections of roadways where a decrease in vehicle speed is specified, and points where stopping of the vehicle for traffic safety is designated, when conducting mobile operations.
3. The mobile operator is always in control of his vehicle regardless of a peak in an interesting mobile communication.
4. The mobile operator always communicates in a brief and concise manner stating only necessary information.

# BLOCK DIAGRAM

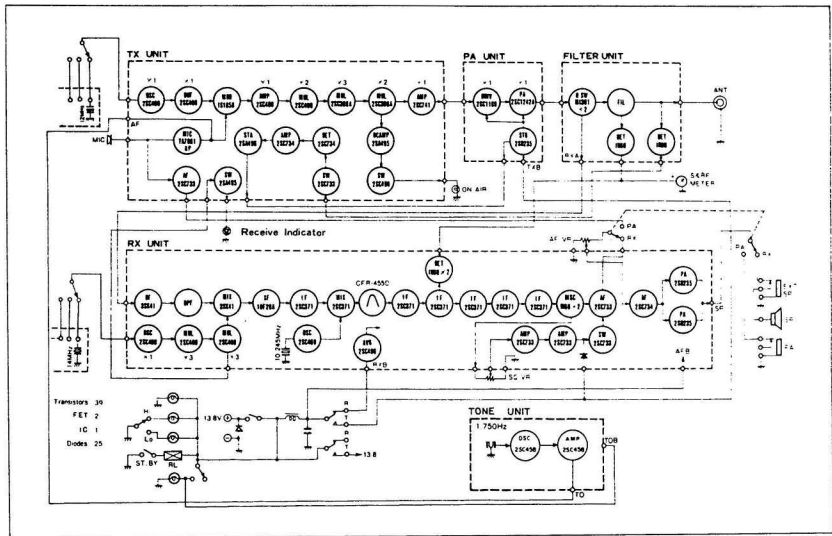

# CHASSIS VIEW(1)

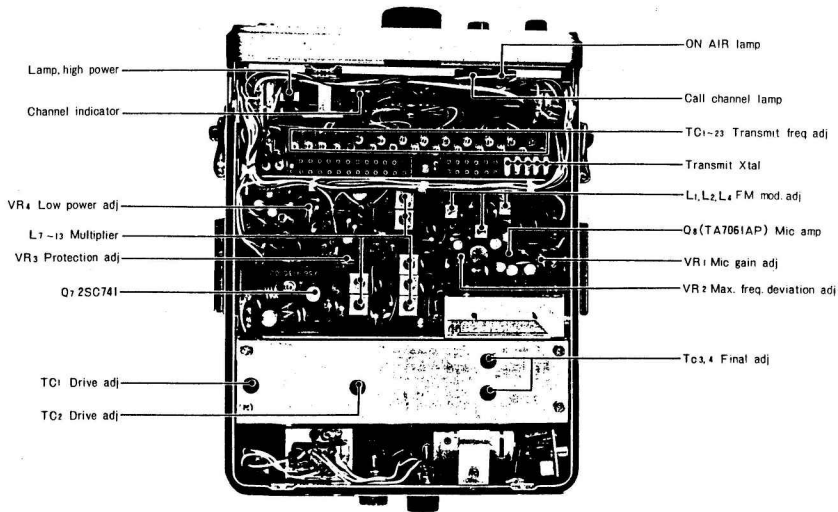

# CHASSIS VIEW(2)

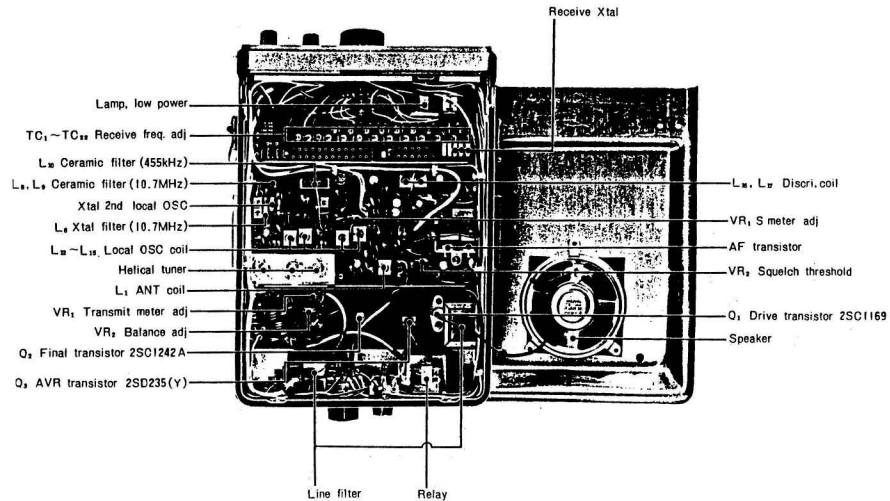



# SCHEMATIC DIAGRAM

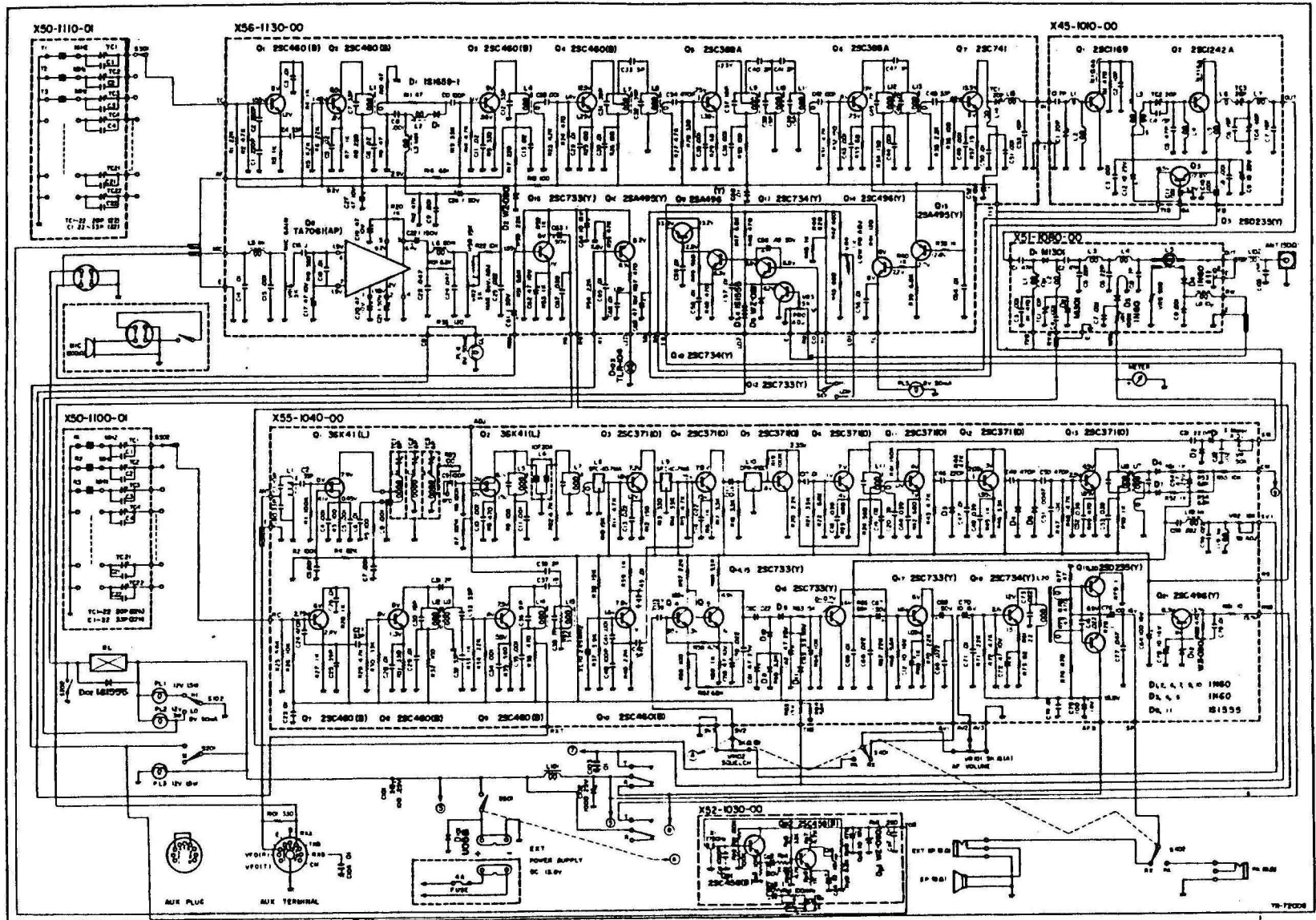

### POWER TRANSISTOR MAXIMUM RATINGS

(2SC1242A)

V <sub>CB0</sub> .....	35V
V <sub>CE0</sub> .....	18V
V <sub>EB0</sub> .....	3.5V
I <sub>C</sub> .....	4.5A
P <sub>C</sub> .....	30W (T <sub>c</sub> = 25°C)
T <sub>j</sub> .....	175°C
T <sub>stg</sub> .....	-65 ~ 175°C