

TR-7200

2METER FM CAR TRANSCEIVER



OPERATING MANUAL

TR-7200 FM Car Transceiver is designed for use in the 144 MHz amateur band. The unique design of the TR-7200 also permits utilization as fixed-station equipment. The TR-7200 is high quality and performance through our elaborate VHF techniques. The transceiver employs F3 type emission with 23 channels in addition to crystal control for both transmit and receive. Maximum transmit output is 10 watts.



TR-7200 OPERATING MANUAL

CONTENTS

SPECIFICATIONS	3
SECTION 1. PRIOR TO OPERATION	4
SECTION 2. CONTROLS	5
SECTION 3. INSTALLATION	6
SECTION 4. OPERATION	9
SECTION 5. PRECAUTION	13
BLOCK DIAGRAM	14
CHASSIS VIEW (1)	15
CHASSIS VIEW (2)	16
SCHEMATIC DIAGRAM	17

SPECIFICATIONS

GENERAL

Solid-State Components	Transistors	29
	FETs	3
	ICs	3
	Diodes	22
	Piezo-tuning fork	1
Frequency Range	144.0 to 146.0 MHz	
Built-in Transceive Channels	5 channels	
	Transmit	Receive
	① 144.15 MHz	145.75 MHz
	② 144.20	145.80
	③ 144.25	145.85
	④ 145.00	145.00
⑤ 145.15	145.15	
Operating Temperatures	-20 to +60°C	
Power Voltage	11.5 VDC to 16.0 VDC (13.8 VDC as reference)	
Grounding	Negative grounding	
Antennal Impedance	50Ω	
Power Consumption	40 VA at 13.8 VDC	
DC Current	Approx. 400 mA in receive with no input signal.	
	Approx. 2.7 A in transmit (HI)	
	Approx. 1.2 A in transmit (LOW)	
Dimensions	7-1/16" (180mm) wide x 2-3/8" (60mm) high x 9-7/16" (240mm) deep	
	Approx. 5.5 lbs. (2.5kg)	

TRANSMIT SECTION

Frequency	23 channels in 144 to 146 MHz
Type of Emission	F3
RF Output Power	10 watts and approx. 1 watt.
Modulation	Variable reactance phase shift
Max. Frequency Deviation	±15 kHz
Multiplication	12 times
Fundamental Frequency	12 MHz band
Spurious Radiation	Less than -60 dB
Microphone	Dynamic microphone with PTT switch, 500Ω

RECEIVE SECTION

Frequency	23 channels in 144 to 146 MHz.
Type of Emission	F3
Circuitry	Double superheterodyne
Intermediate Frequency	1st IF (10.7 MHz), 2nd IF (455 kHz)
Sensitivity	Better than 1μV for 26 dB S/N
Squelch Sensitivity	Better than 0.5μV
Selectivity	20 kHz at 6 dB down
	40 kHz at 60 dB down
Image Rejection	More than 60 dB
Spurious Interference	More than 60 dB
Multiplication of 1st	
Local OSC	9 times
Audio Output	More than 1 watt across 8Ω load (10% distortion)

NOTE: The circuit and ratings may change without notice due to developments in technology.

SECTION 1. PRIOR TO OPERATION

1-1 UNPACKING

Carefully unpack the TR-7200 transceiver and check that the following accessories are included.

Microphone (dynamic)	1
Mounting bracket (for mobile use)	1
Stand-off leg	1
Spare fuse (4 A)	1
DC power cord (with fuse and plug)	1
Small single-tip plug	1
Microphone hanger	1
Mounting parts	
Bolt (6φ)	4
Washer (6φ)	4
Spring washer (6φ)	4
Nut (6φ)	4
Crystal unit (pre-installed in the set)	

Channel	Transmit	Receive
CH 1	144.15 MHz	145.75 MHz
CH 2	144.20 MHz	145.80 MHz
CH 3	144.25 MHz	145.85 MHz
CH 4	145.00 MHz	145.00 MHz
CH 5	145.15 MHz	145.15 MHz

1-2 INSTALLATION

The TR-7200 transceiver employed as a mobile station must be securely attached to the bottom of the dashboard using the accessory mounting bracket. Improper installation will result in damage to the set and dashboard of the vehicle due to vibration encountered during vehicle operation. Consideration must be given to the dashboard material prior to installation. More detailed information on installation is found in par 3-1 mobile use.

1-3 ANTENNA

The output impedance is 50Ω, therefore mount a 50Ω antenna on the vehicle with a 50Ω coaxial cable. The length of cable should be as short as possible. The antenna employs the M-type connector. Any antenna available on the market may be employed: 1/4 wavelength whip antenna, ground plane, 5/8 wavelength antenna, etc.

The 50Ω impedance, for both antenna and feeder, also applies to fixed-station installation. The most popular antenna is a Yagi array with a rotating mechanism. This antenna is very effective in both transmit gain and directional radiation of the signal.

It is recommended that the Yagi antenna be vertically erected, since the vertically polarized wave is typical of the 144 MHz band.

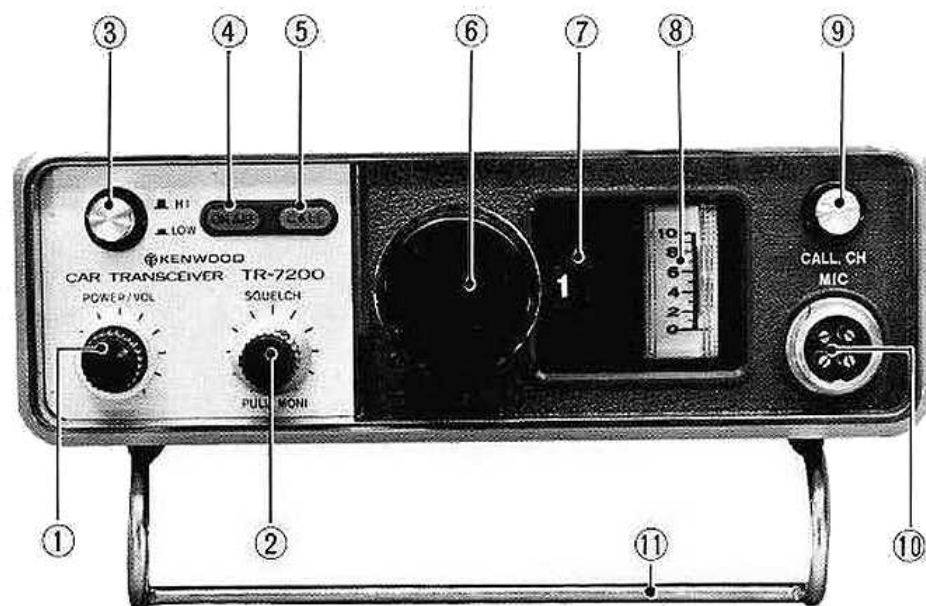

Fig. 1. Front Panel

SECTION 2. CONTROLS

2-1 CONTROLS & THEIR FUNCTION

(Refer to Fig. 1. ~ 3.)

① POWER/VOL Knob

Volume control combined with pushbutton power switch. A single push of the button turns the power on and another off or vice versa. Volume is increased by turning the knob clockwise.

② SQUELCH/PULL MONI. Knob

Squelch control with monitor switch. Turn the knob clockwise to the point where internal noise disappears. The monitor circuit is actuated by pulling the knob out.

③ HI/LOW Switch

HIGH or LOW transmit output is selected, by setting the knob in the normal position or pushing the knob in. The reduced power state (LOW) is indicated by the green light in the meter.

④ ON AIR Lamp

Lights in the transmit state. The lamp will not light when turned to a vacant channel or if the antenna is defective. In the LOW position, it is not a trouble that lighting of the lamp occurs even under the abnormal antenna condition.

⑤ CALL Lamp

This lamp lights when the CALL channel switch depressed,

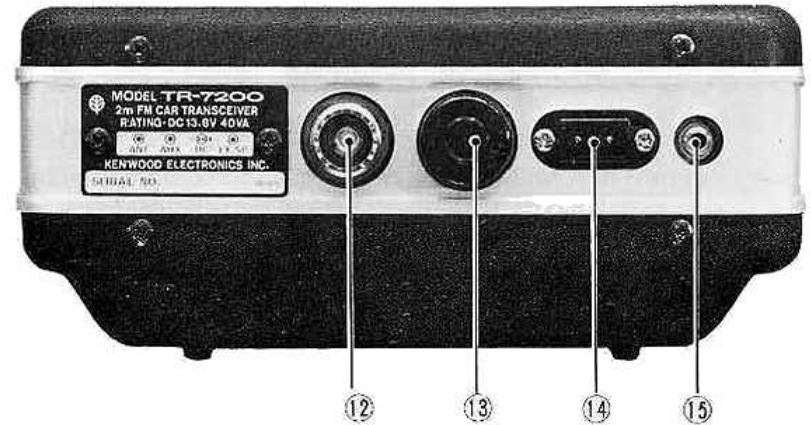

Fig. 2. Rear Panel

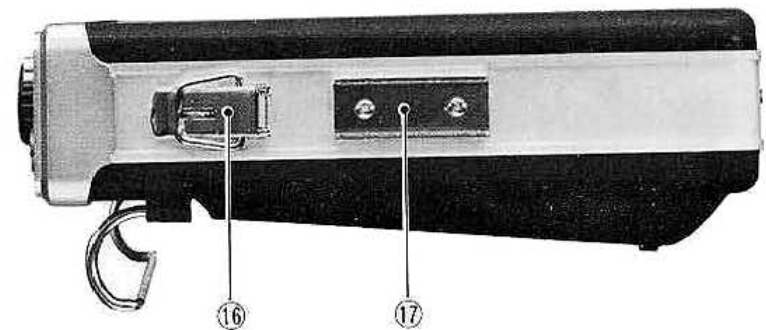

Fig. 3. Side Panel

SECTION 3. INSTALLATION

- ⑫ **ANT Connector**
Output impedance is 50Ω .
- ⑬ **AUX Connector**
Utilized for voltage checks and remote control.
- ⑭ **DC Connector**
Accommodates accessory power cord plug to receive power.
- ⑮ **EXT. SP Connector**
Connects accessory plug in operation of set with external speaker.
- ⑯ **Lock**
Used to mount the set to the accessory mounting bracket, by simply flipping onto bracket. Prevents tampering when locked.
- ⑰ **Mounting Rail**
Used as a guide in installation on the bracket.

3-1 MOBILE USE

1. Installation Position

Although the transceiver position in the vehicle differs from one type of vehicle to another, the set is most generally attached to the bottom of the dashboard for reasons of accessibility to the transceiver and freedom in driving. The particular installation position on the bottom of the dashboard should however be modified to avoid contact with the knees and legs of person especially when braking the vehicle. (Refer to Fig. 4)

2. How to Install the Set

Most vehicles are negatively grounded. If the vehicle positively grounded used, additional means should be provided in installation. (Refer to Item 3 and Fig. 6)

First, securely attach the mounting bracket to the dashboard with the bolts and nuts provided. Second, insert the set into the bracket guided by the mounting rails. With the rails fitted to the bracket, position the transceiver to the desired vertical angle (there are four angles to be selected) that assures operational convenience and safety in the vehicle. Third, unfold the locks, hook on the bracket pawl, then return the locks forward. The locks should be fully folded to obtain full use of the spring action. During angular adjustment, note that the lock cannot be folded unless the pin is fully seated in the notch. (Refer to Fig. 6)

3. Installation in Positive Grounded Vehicle

All positive grounded vehicles require electrical insulation of the set from the vehicle chassis, since the set is negatively grounded. Insulation can be accomplished by grounding the outer conductor of the coaxial cable via a $0.001\mu\text{F}$ capacitor (mica capacitor) as illustrated in Fig. 5.

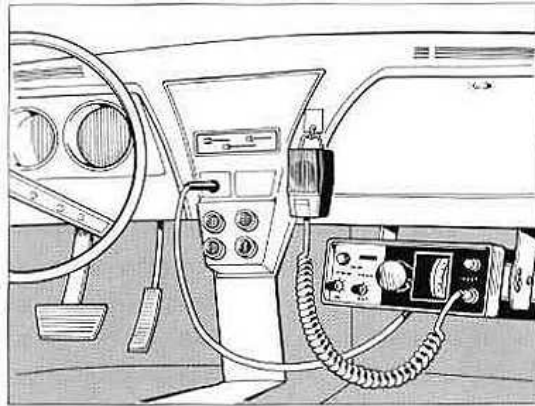

Fig. 4. Installation on the Car

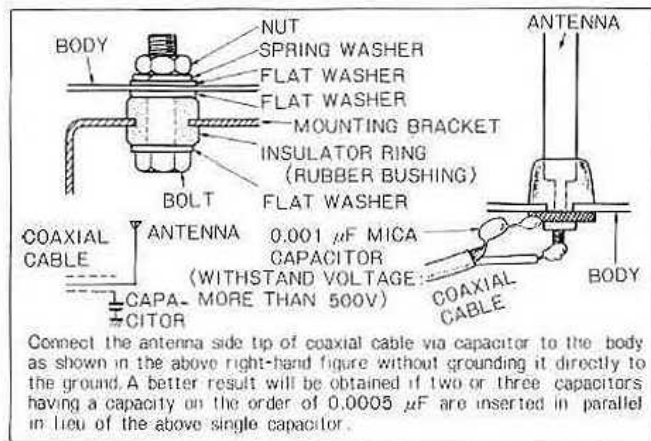

Fig. 5. Installation on the Positive Grounded Car

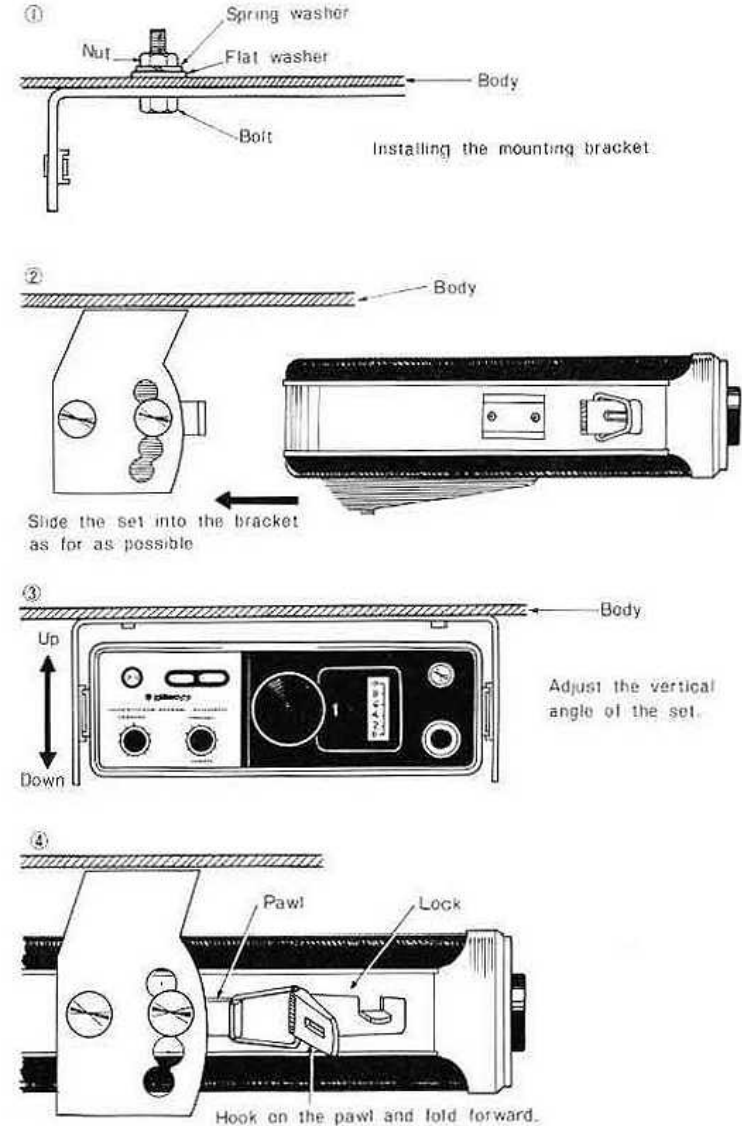

Fig. 6. Installing the Set on the Car

4. Mobile Antenna

A variety of 2 meter antennas are available on the market for mobile operations. For example, a magnet-mounted whip antenna and clamp-mounted whip antenna.

The installation types are classified as the vacuumdisc mount, magnet-mount, gutter-mount, etc. The type of antenna employed depends on the type of vehicle. With either type, the antenna must be sufficiently secured to resist wind pressure when installed.

Connection of the antenna to the transceiver should be with a 50Ω coaxial cable, run in the gutter, into the vehicle interior through the fender seam. The cable should be secured to the vehicle body at certain intervals required to prevent the cable from dangling.

A coaxial cable passed through the door will eventually be damaged by the repeated closing and opening of the door. The outer sheath may remain stout but the core conductor or connection at the root of the antenna will become open.

5. Connecting the Power Supply

Connect the transceiver to the battery posts using the accessory power cord. Place the red lead on the positive post and the black lead on the negative post. Insure that the connections to the battery posts are secure. Loose connections will not only affect the performance of the transceiver but the vehicle as well.

The cable should be secured to the vehicle body at appropriate points to avoid dangling. Surplus lengths of cable should be cut off. An alternate method of obtaining power is via the cigar lighter provided in most vehicles, utilizing the plug shown in Fig. 7 (b).

6. Microphone Hanger

Utilize the accessory microphone hanger. After determining the hanger position, peel off the silicon backing and attach the hanger securely in position. Do not touch the adhesive section with the fingers. The adhesive will adhere to the leather or metallic surfaces of the vehicle. The surface to be bonded must however be cleaned off all dirt and moisture. (Refer to Fig. 7 (a).)

3-2 FIXED-STATION USE

When the transceiver is to be employed as a fixed-station, attach the accessory stand-off leg to the transceiver as shown in Fig. 3. The TR-7200 is designed as a DC-powered instrument, therefore a DC power supply must be provided. The required current is approximately 2.7A. The power supply voltage should be correctly adjusted to the rated value (13.8V standard) of the transceiver.

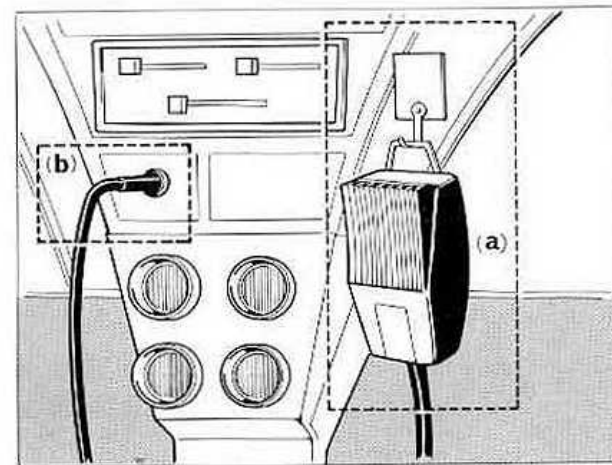

Fig. 7. Mic Hanger & Use of Cigar Lighter

SECTION 4. OPERATION

4-1 OPERATION

TR-7200 Car Transceiver is operated utilizing the following procedures:

1. Connect power, antenna and microphone to the set. Since the power cord has (+) and (-) polarity, confirm proper polarity when connecting the cord to the battery posts and set. (Refer to Fig. 8.)
2. Depress the POWER/VOL knob on the front panel. The channel indicator window will then indicate the number of the selected channel. Then turn the knob clockwise to obtain operating noise. Position the knob to the point at which any appropriate sound volume is obtained.
3. Set the main knob to CH4. This is the 145.00 MHz channel.
4. Pull the SQUELCH/PULL MONI knob out. The monitor circuit is then actuated and the signal meter will deflect. The monitor circuit produces sound from the speaker when speaking into the microphone without depressing the PTT switch on the microphone. This indicates that the microphone system is normal. At this time, it needs that frequencies of transmit and receive are identical, such as CH4 and CH5. The monitor circuit is inactivated by depressing the PTT switch. No radio signals are transmitted with the SQUELCH/PULL MONI knob pulled out.
5. Return the SQUELCH/PULL MONI knob to the normal position, then turn slowly clockwise to effect the squelch until the internal noise disappears from the speaker. This adjustment should be made on the Xtal contained channel with no input signal.

6. Return the set to CH4. The speaker will produce the sounds with the input signal. With no input signal, sound will not be heard from the speaker because of the squelch activated. The signal strength meter will deflect with changes in the strength of the input signal.
7. Depress the PTT switch on the microphone to transmit, and the ON AIR lamp will light. Hold the microphone close to the mouth (approximately 3 inches to the microphone) when speaking.

NOTE: The operational condition of the antenna system is observed from the SWR meter. A good antenna system should be produced an SWR reading of less than 1.5. Higher values hinder the transceiver in switching to the transmit mode, (due to the protective circuit included). TR-7200 FM Car Transceiver is

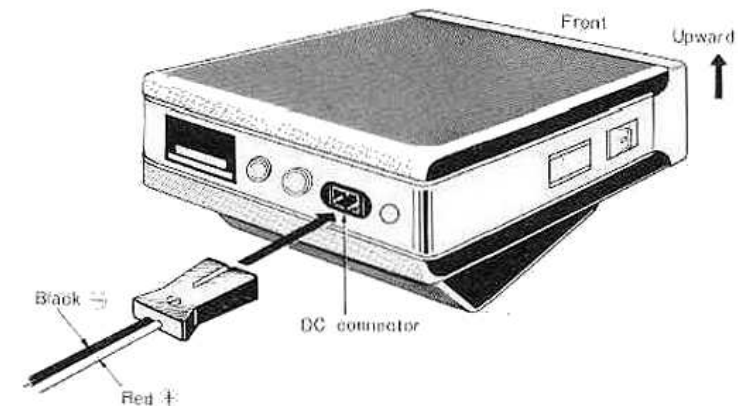

Fig. 8. Power Cord Connection

designed to indicate 8 on the meter when 10 watts of RF output appears across the power meter with an impedance of 50Ω . An acceptable SWR for the antenna system should therefore be an indication near this value. In this sense, the meter deflection may be utilized as an SWR meter.

8. In addition to CH1, this transceiver contains crystals permitting selection on CH2 to CH5. As to channel numbers and their frequencies refer to Table 1.
9. **CALL channel**
Use this channel to contact a relay station. Keep the CALL channel switch pushed for some seconds before transmission to transmit the signal modulated by 1,750 Hz with which the relay station is activated.
10. **HI/LOW**
QSO between locals can be enjoyed with less interference and power consumption by reducing the output power to only the required value. This is accomplished by depressing the HI/LOW pushbutton switch, which reduces power from the normal 10 watts to approx. 1 watt, with the meter lighting turning to green. The ON AIR lamp will remain unchanged in luminous intensity, whereas the meter indication will drop to 2. In the LOW position, the protection circuit does not work, but no trouble occurs.

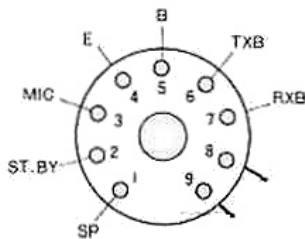

Fig. 9. AUX Connector Configuration

4-2 AUX CONNECTOR

The auxiliary connector wiring is as shown in Fig. 9. The auxiliary connector is employed in various ways, for example, remote control booster connection, built-in variable frequency oscillator, etc. The auxiliary connector may be capped if not used.

PRECAUTIONS

1. Do not set the transceiver to the transmit mode with the ANT connector terminals shorted or the antenna disconnected to prevent damage to the RF power transistor.
2. Do not place the transceiver near the vehicle heater vent.
3. Although the transceiver is designed to withstand long continuous transmission, it is recommended that an occasional cooling off period be permitted.
4. Power supply voltage for fixed-station operation of the transceiver should not be exceeded 13.8V.
5. When the transceiver fails, contact the nearest our service station for repair. Ferrite cores and trimmer capacitors are factory-adjusted and do not require adjustment.

4-3 CHANNELS & THEIR FREQUENCIES

Table 1.

Channel	Transmit	Receive
CH 1	144.15 MHz	145.75 MHz
CH 2	144.20 MHz	145.80 MHz
CH 3	144.25 MHz	145.85 MHz
CH 4	145.00 MHz	145.00 MHz
CH 5	145.15 MHz	145.15 MHz

4-4 DIAL INDICATION

There are numbers of 1 to 23 on the dial plate. These channel numbers are visible through the channel indicator window. The channel marked with ※ is not classified a channel due to the structural limitation of the selector switch. On the channel 1 to 5, crystals are provided. (Refer to Table 1)

4-5 CHANNEL EXPANSION

1. Xtal Installation

Utilize the following procedures to provide additional channel crystals. First, remove the two upper and lower screws, then the top cover. Disconnect the speaker cord and extract the set from the casing.

The transmit crystals are installed on the upper row. Channel arrangement and the corresponding adjustment trimmers are as illustrated on the back of the top cover.

Sockets marked with ※ are not for crystal installation. The receive crystals are installed on the lower row in the same manner.

2. Frequency Adjustment

When a new channel is added, it must be frequency-adjusted with a frequency counter as follows.

a) Adjustment with a Frequency Counter RX (Reception)

Connect the counter as shown in Fig. 10.

$$\text{Counter frequency} = \text{Channel frequency} - 10.7$$

TX (Transmission)

Connect the counter as shown in Fig. 11, and adjust the trimmer corresponding to the channel until the counter reads the proper channel frequency.

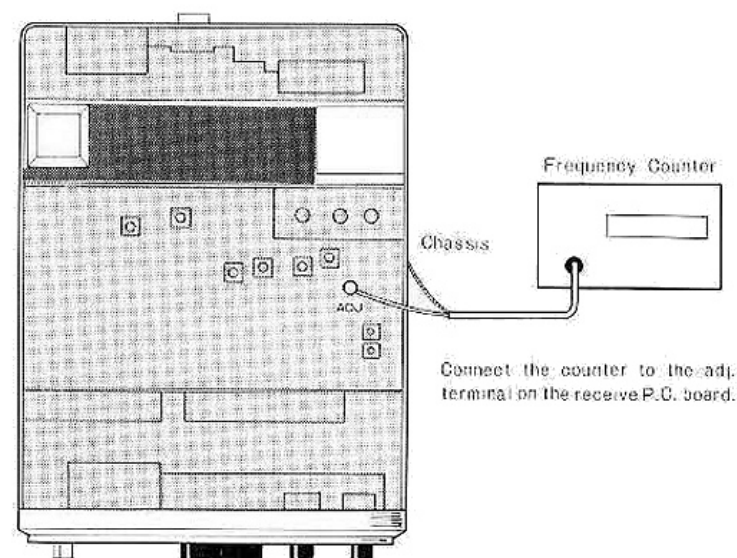

Fig. 10. Adjusting RX Section

b) Adjustment without a Frequency Counter

A crystal unit manufactured for use with TR-7200 will oscillate the correct frequency when the trimmer is set to approximately the midpoint of the variable range.

Another method of approximate adjustment is to utilize the signal of an other station: For reception, adjust the trimmer to the point producing the best possible reception of the partner station, and for transmission, to a point where the partner receives a similarly clear signal from the TR-7200 under adjustment.

4-6 TROUBLE SHOOTING

When the TR-7200 fails, contact our service station for repair. All trimmers and coils are factory-adjusted and should be repaired by a qualified engineer.

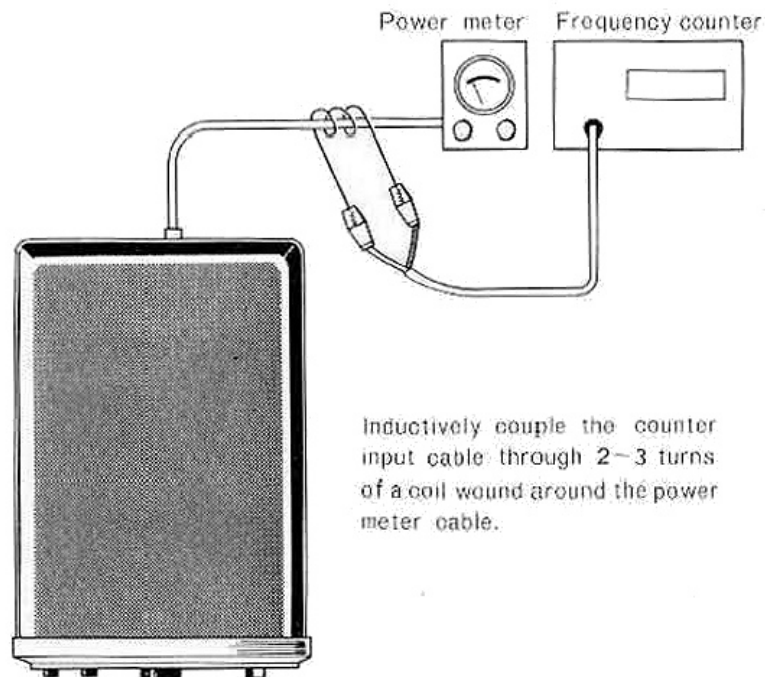

Inductively couple the counter input cable through 2-3 turns of a coil wound around the power meter cable.

Fig. 11. Adjusting TX Section

SECTION 5. PRECAUTION

In concluding the operating instructions of the TR-7200 FM Car Transceiver, reference is made to certain rules that should be followed for more enjoyable mobile operation:

1. The mobile operator always exercises utmost caution in the safe operation of the vehicle; he interrupts mobile communication whenever the danger of an accident exists.
2. The mobile operator is always aware of the crowded conditions of roads, express ways, sections of roadways where a decrease in vehicle speed is specified, and points where stopping of the vehicle for traffic safety is designated, when conducting mobile operations.
3. The mobile operator is always in control of his vehicle regardless of a peak in an interesting mobile communication.
4. The mobile operator always communicates in a brief and concise manner stating only necessary information.

BLOCK DIAGRAM

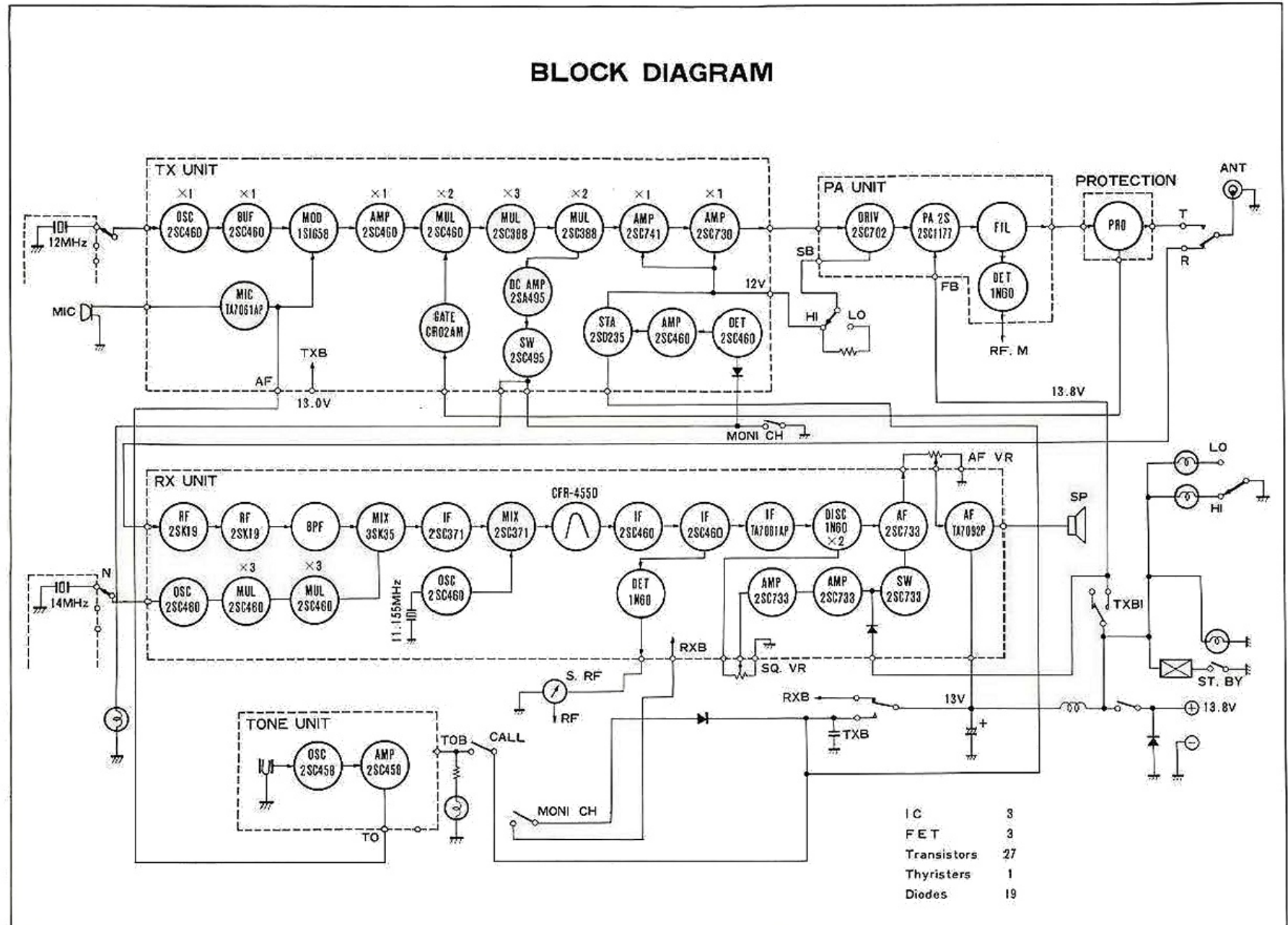

CHASSIS VIEW(1)

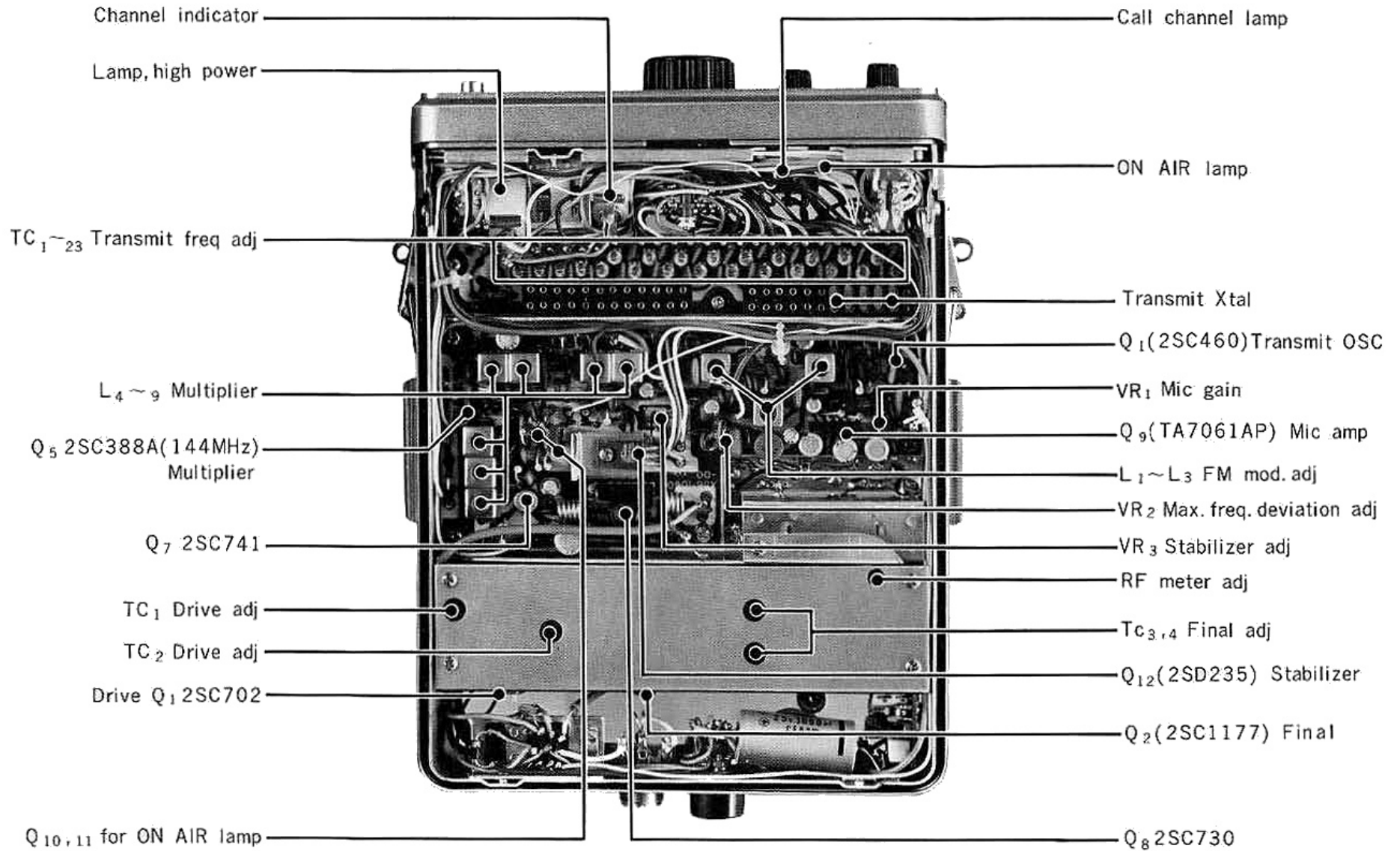

CHASSIS VIEW(2)

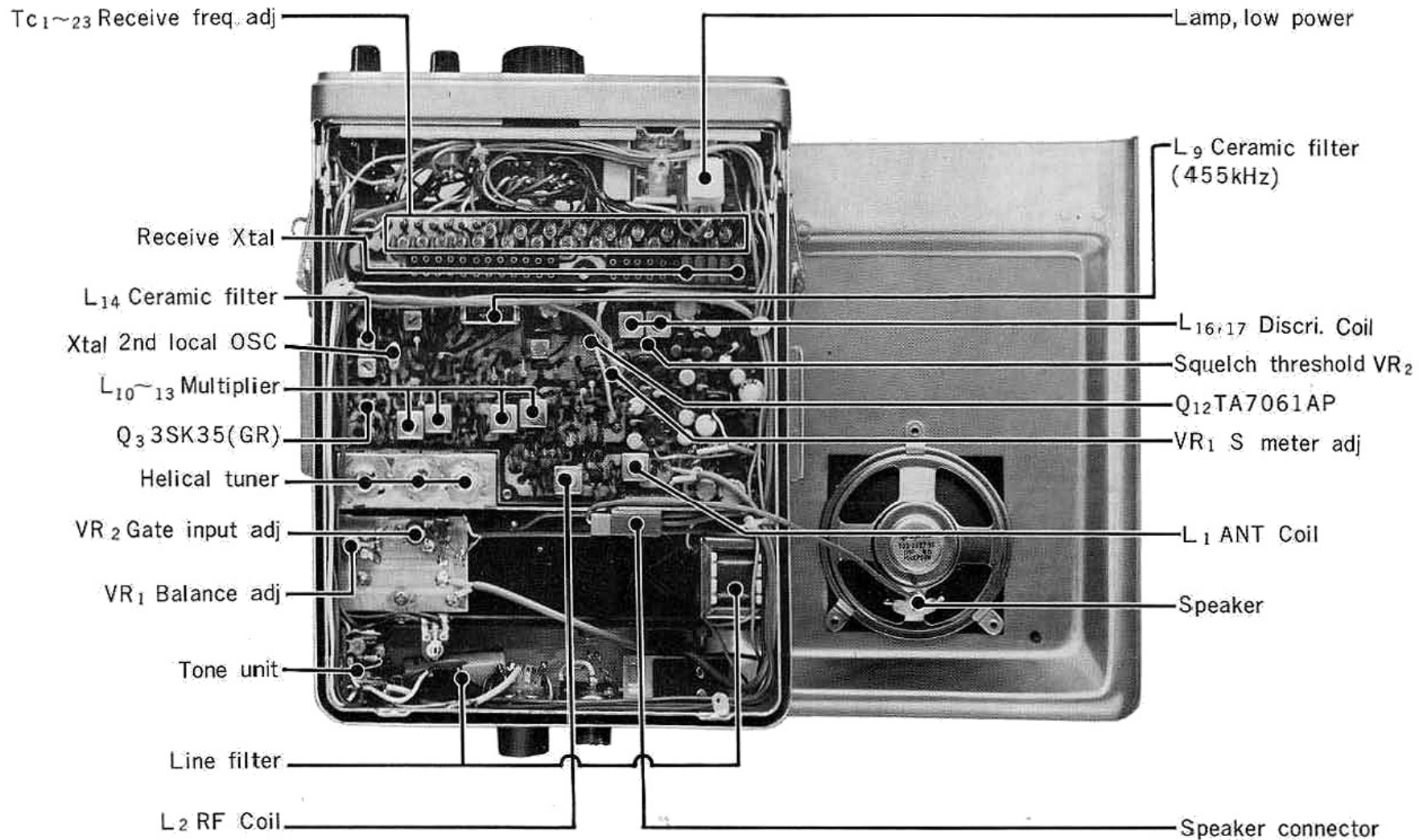

SCHEMATIC DIAGRAM

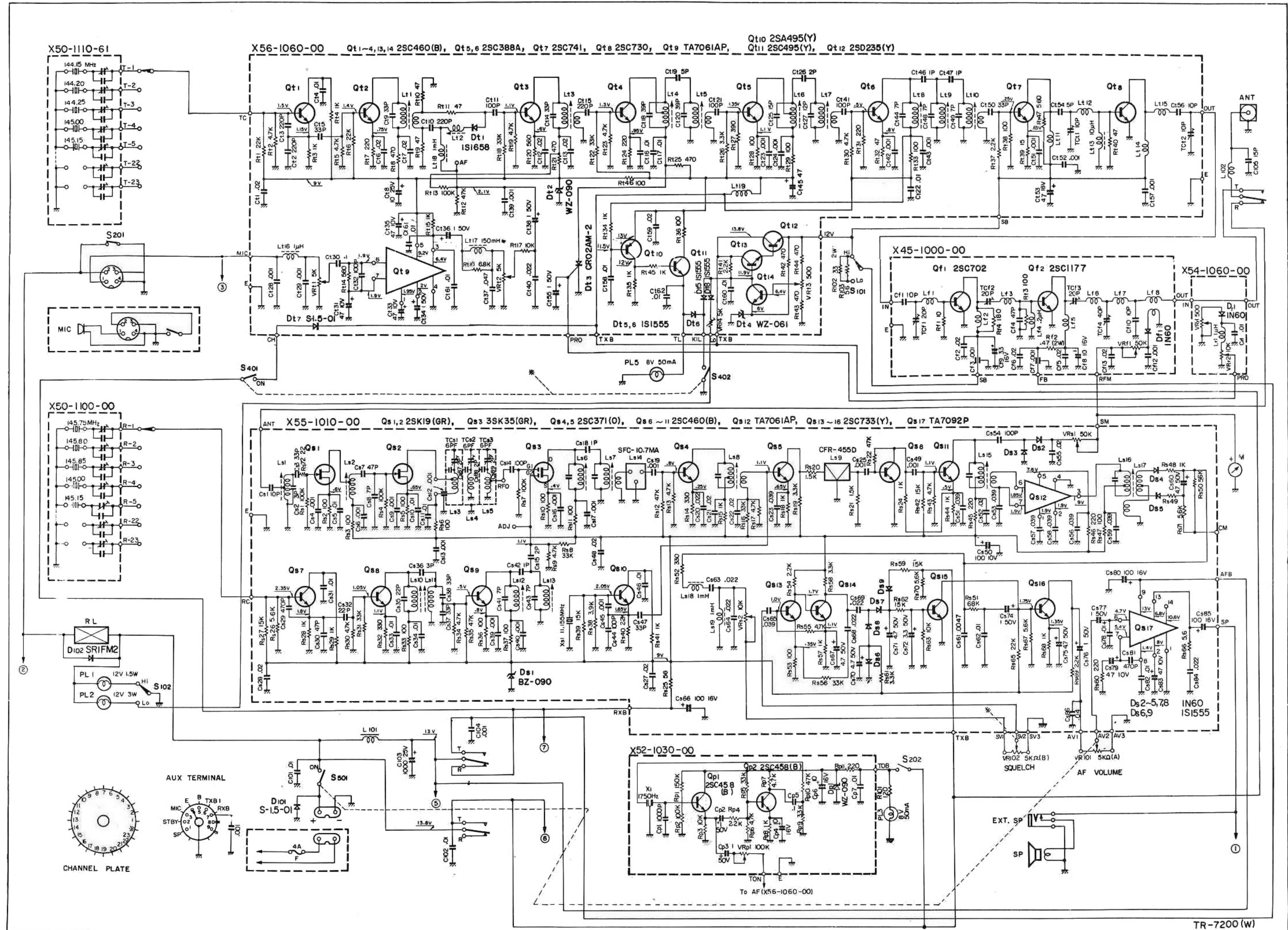



KENWOOD

Manufactured by TRIO ELECTRONICS, INC., Tokyo, Japan