

**KENWOOD**

144 MHz FM TRANSCEIVER

**TH-27A/27E**

430/440MHz FM TRANSCEIVER

**TH-47A/47E**

---

**INSTRUCTION MANUAL**

**KENWOOD CORPORATION**

© PRINTED IN JAPAN B62-0046-20(A,T)(K,X,T)  
92/12 11 10 9 8 7 6 5 4 3 2 1 91/12 11 10 9 8

**CAUTION**

THE MEMORY IS MAINTAINED BY A RECHARGEABLE SECONDARY LITHIUM BATTERY. WITH THE BATTERY CASE REMOVED, THE MEMORY IS RESET TO ITS INITIAL STATE AFTER ABOUT 20 DAYS. A FULLY DISCHARGED BATTERY WILL REQUIRE APPROX. 10 HOURS TO REACH FULL CHARGE AFTER INSTALLING A NiCd BATTERY PACK OR AN EXTERNAL POWER SUPPLY.

Press the power switch **for longer than 0.3 second** to turn the transceiver on or off.

**FCC WARNING**

This equipment may generate or use radio frequency energy. Changes or modifications to this equipment may cause harmful interference unless the modifications are expressly approved in the instruction manual. The user could lose the authority to operate this equipment if an unauthorized change or modification is made.

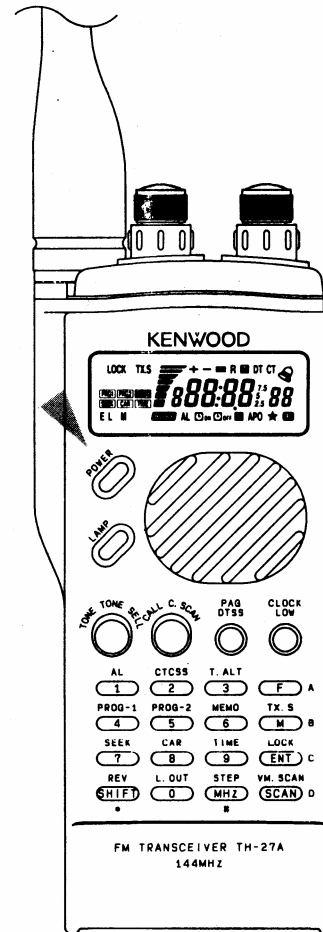

# CONTENTS

1. BEFORE OPERATION .....	4
2. SPECIFICATIONS and ACCESSORIES .....	4
3. BATTERY PACK .....	6
4. OPERATION .....	8
4-1 OPERATING CONTROLS .....	8
4-2 RECEIVER OPERATION .....	15
Receiver Operation	
Frequency Selection	
Step Size selection	
Programmable VFO Tuning Limits	
4-3 TRANSMITTER OPERATION .....	18
4-4 MEMORY .....	19
Microprocessor Memory Back-up	
Microprocessor Initialization	
Memory Channel	
Memory Contents	
Memory Entry	
Memory Channel Recall	
Memory Shift	
4-5 SCAN .....	23
Scan Options	
Hold/Resume Programming	
Band Scan	
Programmable Band Scan	
MHz Scan	
Memory Channel Scan	
VFO/Memory Channel Scan	
CALL Scan	
Memory Channel Lockout	
Priority Alert Function	
4-6 REPEATER OPERATION .....	28
Transmitter Offset	
Reverse Function	
Tone and CTCSS Operation	
Autopatch Operations	
4-7 DTMF MEMORY .....	31
4-8 DTSS .....	33
DTSS Code	
DTSS Code Selection	
Using the DTSS function	
Using DTSS with a Repeater	
4-9 PAGING .....	35
Paging Code Memories	
Setting the Paging Codes	
Paging Transmission (Calling)	
Paging Reception (Wait)	
Code Lockout	
4-10 TONE ALERT SYSTEM .....	41
4-11 BATTERY SAVER .....	42
4-12 AUTOMATIC POWER OFF .....	42
4-13 CLOCK .....	43
5. BLOCK DIAGRAM and SCHEMATIC DIAGRAM	
.....	another sheet
6. MAINTENANCE .....	46
In Case of Difficulty	
7. OPTIONAL ACCESSORIES .....	48

## 1. BEFORE OPERATION

Thank you for purchasing this new transceiver.

### IMPORTANT

Please read this instruction manual carefully before placing your transceiver in service.

### CAUTION

Long transmission or extended operation in the HI power mode might cause the rear of this transceiver to get warm. Do not place the transceiver where the heat sink (rear panel) might come in contact with plastic or vinyl surfaces.

**SAVE THIS INSTRUCTION MANUAL.**

This Instruction Manual covers the following models:

TH-27A: 144MHz FM transceiver

TH-27E: 144MHz FM transceiver  
(U.K.and European version)

TH-47A: 440MHz FM transceiver  
( U.S.A. and Canadian version)

TH-47A: 430MHz FM transceiver (Other market)

TH-47E: 430MHz FM transceiver  
(U.K.and European version)

The following explicit definitions apply in this manual:

NOTE If disregarded, inconvenience only, no risk of equipment damage or personal injury.

CAUTION Equipment damage may occur, but not personal injury.

## 2. SPECIFICATIONS and ACCESSORIES

### 2-1. SPECIFICATIONS

GENERAL		TH-27A/E	TH-47A/E
FREQUENCY RANGE (MHz)	U.S.A. Version	144 to 148	438 to 450
	U.K.and Europe	144 to 146	430 to 440
	Other market	144 to 148	430 to 440 or 438 to 450
MODE		F3E (FM)	
ANTENNA IMPEDANCE		50 Ω	
OPERATING TEMPERATURE		-20°C ~ +60°C (-4°F~140°F)	
POWER REQUIREMENTS	DC IN(nominal)	7.2 V ~ 16 VDC (13.8 VDC)	
	BATTERY PACK	6.3 V ~ 16 VDC (7.2VDC)	
CURRENT DRAIN			
13.8VDC (Ext.Power Supply)	H	Approx. 1.5A	Approx. 1.5A
7.2VDC (Battery)	H	Approx. 1A	Approx. 1A
Transmit mode	L	Approx. 0.5A	Approx. 0.8A
Transmit mode	EL	Approx. 0.12A	Approx. 0.15A
Receive mode with no signal		Approx. 60mA	Approx. 65mA
Battery Save mode		Approx. 17mA	Approx. 17mA
GROUND		Negative	
DIMENSION(W×H×D)		49.5×124.7×38.0mm	
DIMENSION( Projection Included )		57×138.7×39.7mm	
WEIGHT		360g	
MICROPHONE INPEDANCE		2kΩ	
TRANSMITTER			
OUTPUT POWER	H (13.8VDC)	more than 5W	
	H (7.2VDC)	Approx. 2.5W	Approx. 1.5W
	L	Approx. 0.5W	
	EL	Approx. 20mW	

	TH-27A/E	TH-47A/E
MODULATION	Reactance	
MAXIMUM FREQUENCY DEVIATION	± 5kHz	
SPURIOUS RADIATION	less than - 60dB	
RECEIVER		
CIRCUITRY	double conversion super-heterodyne	
INTERMEDIATE FREQUENCY 1 st IF	45.05 MHz	58.525 MHz
INTERMEDIATE FREQUENCY 2 nd IF	455 kHz	
SENSITIVITY (12dB SINAD)	less than - 16dBμ (0.16μV)	less than - 15dBμ (0.18μV)
SQUELCH SENSITIVITY	less than - 20dBμ(0.1μV)	
SELECTIVITY - 6dB	more than 12kHz	
SELECTIVITY - 60dB	less than 28kHz	
AUDIO OUTPUT POWER (10% distortion)	more than 200 mW (across 8Ω load)	

**NOTES:**

1. Circuits and rating are subject to change without notice, due to development in technology.
2. Recommended duty cycle: 1 minute Transmission, 3 minutes Reception.

**CAUTION**

During fixed station operation, the supplied antenna may cause interference to nearby electronic equipment. It can also increase the supply voltage from an external D.C.power supply. To avoid these conditions, a low gain external antenna can be used. A gain type antenna can lead to intermodulation distortion.

## 2-2. ACCESSORIES

Unpack your transceiver carefully and confirm that the accessories listed below are included in the box.

- |   |             |         |
|---|-------------|---------|
| Antenna (TH-27A/27E)                      | T90-0420-×× | ..... 1 |
| (TH-47A/47E)                              | T90-0421-×× | ..... 1 |
| Belt Hook                                 | J29-0459-04 | ..... 1 |
| Hand Strap                                | J69-0312-04 | ..... 1 |
| Rubber Cap                                | B09-0324-03 | ..... 1 |
| NiCd Battery Pack(PB-13)                  | W09-0563-05 | ..... 1 |
| Battery Charger(BC-14)                    |             | ..... 1 |
| for U.S.A. and Canadian version (120V)    |             |         |
|   | W09-0565-×× |         |
| for European version (220V)               |             |         |
|   | W09-0569-×× |         |
| for U.K.version (240V)                    |             |         |
|   | W09-0568-×× |         |
| for Oceania.version (240V)                |             |         |
|   | W09-0567-×× |         |
| for other market (120/240V)               |             |         |
|   | W09-0566-×× |         |
| Instruction Manual                        | B62-0046-XX | 1 copy  |
| Warranty Card                             |             | ..... 1 |
| (U.S.A.,Canada,and European version only) |             |         |

After unpacking  
Shipping container:  
Save the boxes and packing in the event your unit needs to be transported for remote operation, maintenance, or service.

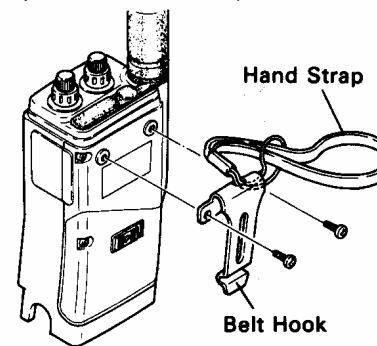

### 3. BATTERY PACK

#### ■ Ni-Cd BATTERY PACK (PB-13)

This battery pack has not been charged at the factory in order to provide you with the greatest number of charge/discharge cycles. You must charge the battery before use. The battery pack will require several charge/discharge cycles before you can expect to see the maximum operating period between charges. If the battery will be stored for greater than 2 months it should be recharged before use.

#### ■ RECHARGING

Insert the charge plug from the charger (BC-14) into the receptacle on the top of the transceiver. Then plug the charger into the AC line. Do not allow the battery to charge for greater than 15 hours. The use for life and battery performance will be reduced if you exceed the recommended charge period.

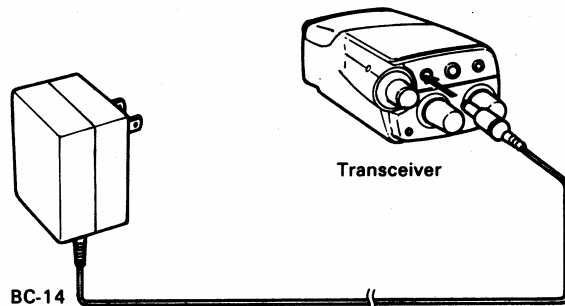

(Illustrations show the U.S.A. version.)

#### NOTE

Recharging should be done within an ambient temperature between 5°C ~ 40°C (41°F ~ 104°F). Recharging performed out of this range may not fully charge the battery.

#### ■ INSTALLING THE BATTERY PACK

Insert the battery pack into the transceiver until it locks in place.

To remove the battery pack slide the Release button and pull the pack.

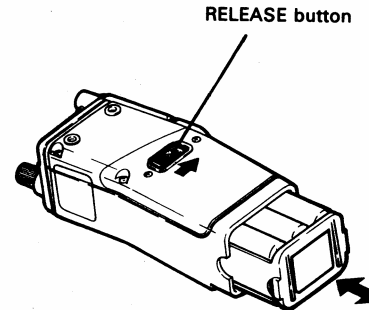

**■ BATTERY VOLTAGE LEVEL METER**

The meter indicates the relative battery voltage during transmit.

Recharge or replace the batteries when the level reaches the low indicator.

NiCd Battery pack

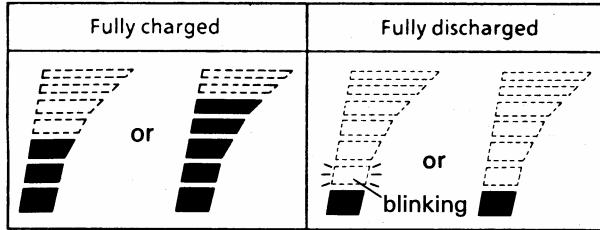

Approximate battery condition

**■ OPERATING TIME**

		H	M	L	EL
TH-27A TH-27E	PB-13	2	2.5	4	15
	Alkaline B.	-	-	0.8	5.5
	Manganese B.	2	2	3	6.5
TH-47A TH-47E	PB-13	2	2.5	4	13.5
	Alkaline B.	-	-	0.8	4.5
	Manganese B.	2	2.5	3	6

- 1 minute transmission, 3 minutes reception, AF output 0.2 W/8 Ω.
- Battery saver function on.

**CAUTION**

The display indicator flashes and the POWER switch will not work when the battery starts to go flat. When this happens, recharge or replace the battery.

We recommend use of the NiCd battery pack for long transmission or extended operation.

Manganese batteries (except Alkaline manganese batteries) are available for Low or EL position.

**■ MANGANESE or ALKALINE BATTERIES**

Load 6 × R6 (AA) manganese or alkaline batteries in series in the optional battery case (BT-8). Be sure to observe polarity.

We recommend use of high performance manganese batteries.

Be sure the pack and transceiver are locked together.

Manganese or Alkaline batteries

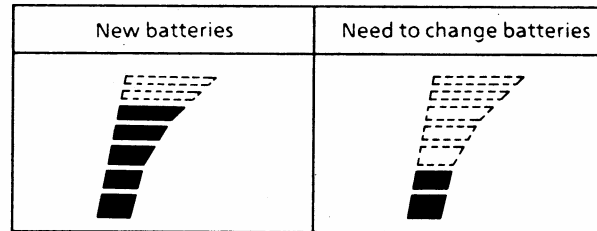

Approximate battery condition

## 4. OPERATION

### 4-1. OPERATING CONTROLS

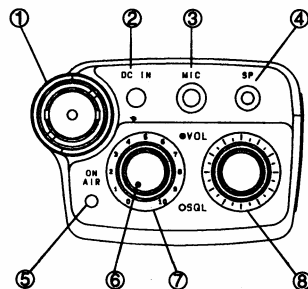

① Antenna connector

Connect the antenna that is supplied to this connector. Twist to lock.

② DC IN terminal

This terminal is used for an external power supply. Input voltage is 13.8 VDC nominal. The center is the + side and the sleeve is the - side.

**NOTE**

You should turn the power switch OFF when connecting a power source to this terminal. Pay close attention to polarity. Use the KENWOOD PG-2W or PG-3F optional cable for connection.

③ MIC jack

This jack is used for connection of an external microphone. The use of an electret type microphone is recommended. Input impedance is  $2k\Omega$  and the DC voltage on this terminal is Approx. 4 V (MAX 3.5 mA).

**NOTE**

The use of a dynamic microphone is not recommended.

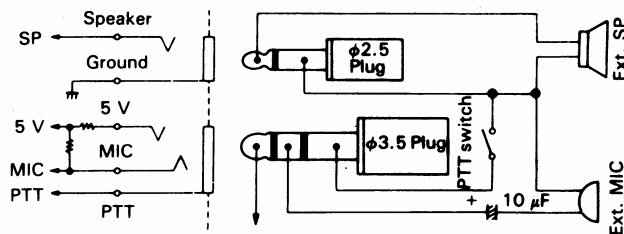

④ SP jack

This jack is used to connect an external speaker or earphone. The recommended impedance is  $8\Omega$ .

⑤ ON AIR indicator

On whenever the transceiver is in the transmit mode.

⑥ VOL control

Rotating the control further clockwise will increase the volume.

⑦ SQL(Squelch) control

This control is used to select the desired Squelch threshold level.

⑧ Tuning control

This control is used to select the desired transmitter /receiver frequency, MHz step, Memory Channel, Frequency Step, Tone Frequency, Scan Direction, etc.



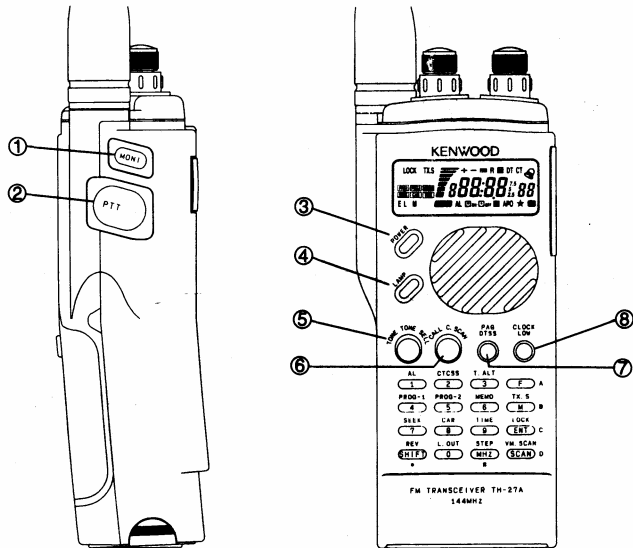

**① MONI switch**

When operating in the CTCSS (Tone Squelch) mode you can use this key to determine if the frequency is in use before transmitting. Pressing this key will disable the CTCSS function as long as the key is held depressed.

**② PTT (Push To Talk) switch**

Press this switch whenever you wish to transmit.

**③ POWER switch**

Press for longer than 0.3 second to turn the transceiver ON or OFF.

**④ LAMPkey**

This switch is used to control the night lamp on the LCD display. The lamp will turn itself OFF automatically 5 seconds after the last key operation.

Pressing the key within 10 seconds of pressing the F key will light the lamp on the LCD display permanently until pressing this key again.

**⑤ TONE/TONE SEL key**

Except European version; This key is used to activate the subaudible tone encoder.

European version; This key is used to transmit the 1750Hz repeater access tone whenever this key is depressed.

U.S.A., Canada, or with optional TSU-7; Pressing the key within 10 seconds of pressing the F key will switch to the tone frequency selection mode. The Tuning control can then be used to select the desired tone frequency.

**⑥ CALL/C. SCAN key**

Press this key to activate the call channel function.

Pressing the key within 10 seconds of pressing the F key will start or stop CALL channel scanning.

**⑦ DTSS/PAG key**

This key is used to activate the DTSS function.

Pressing the key within 10 seconds of pressing the F key will turn the PAGING function on or off.

**⑧ LOW/CLOCK key**

This key is used to switch the transmit output power; Medium(M)/Low(L)/Economic-Low(EL)/High (no indicator).

Pressing the key within 10 seconds of pressing the F key will switch alternately between the frequency display and CLOCK display.

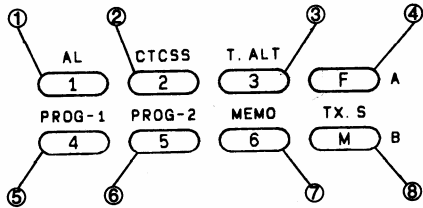

① 1/AL key

This key is used to turn memory channel 1 on or off. Pressing the key within 10 seconds of pressing the F key will check Memory Channel 1 at approx. 5 second intervals. If the channel is busy, a beep will sound (ALERT).

② 2/CTCSS key

This key is used to turn memory channel 2 on or off. Pressing the key within 10 seconds of pressing the F key will turn the CTCSS function on or off.

③ 3/T.ALK key

This key is used to turn memory channel 3 on or off. Pressing the key within 10 seconds of pressing the F key will turn the TONE ALERT function on or off.

④ F key

This key is used to activate control of the functions. The "F" indicator will turn ON or flash for approximately 10 seconds. You must press the desired function key before the indicator turns off.

⑤ 4/PROG-1 key

This key is used to turn memory channel 4 on or off. Pressing the key within 10 seconds of pressing the F key will select the programmable scan 1 MODE.

⑥ 5/PROG-2 key

This key is used to turn memory channel 5 on or off. Pressing the key within 10 seconds of pressing the F key will select the programmable scan 2 MODE.

⑦ 6/MEMO key

This key is used to turn memory channel 6 on or off. Pressing the key within 10 seconds of pressing the F key will select the memory scan MODE.

⑧ M/TX.S key

This key is used to store the displayed data into memory. Pressing the key within 10 seconds of pressing the F key will turn the TX.STOP function on or off.

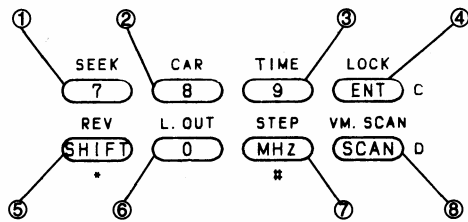

① 7/SEEK key

This key is used to turn memory channel 7 on or off. Pressing the key within 10 seconds of pressing the F key will select SEEK operated scan.

② 8/CAR key

This key is used to turn memory channel 8 on or off. Pressing the key within 10 seconds of pressing the F key will select CARRIER operated scan.

③ 9/TIME key

This key is used to turn memory channel 9 on or off. Pressing the key within 10 seconds of pressing the F key will select TIME operated scan.

④ ENT / LOCK key

This key is used to switch to the direct keyboard frequency entry mode.

Pressing the key within 10 seconds of pressing the F key will deactivate all functions except the PTT, POWER, MONI, LAMP, F then ENTER (LOCK) keys.

If you press the F key for longer than 1 second, then press the ENT key the Tuning control lock function will turn on or off.

⑤ SHIFT / REV / \* key

Pressing the key will cause the radio to shift from one offset direction to the other, i.e. + to - to simplex where no indicator shows. [ - to - - for European version ( TH-47E ) ].

Pressing the key within 10 seconds of pressing the F key will reverse the transmit/receive frequencies during repeater operations. If you have selected simplex this key will not function.

⑥ 0/L.OUT key

This key is used to turn memory channel 0 on or off. Pressing the key within 10 seconds of pressing the F key will turn the memory channel lock out function on or off.

⑦ MHz/STEP/# key

This key is used to select the tuning rate of the Tuning control. When the MHz indicator is lit, the Tuning control will cause the transceiver to increase or decrease in 1 MHz steps.

During VFO operation pressing the key within 10 seconds of pressing the F key will select the desired frequency step.

⑧ SCAN/VM.SCAN key

This key is used to start or stop scanning.

Pressing the key within 10 seconds of pressing the F key will start or stop VFO/Memory scan.

■ **NOT DISPLAYED FUNCTION**

- Press the M key , then the key below.

Key	Function	Refer to
M, CALL	Displayed data in call channel.	P.21 4-4-5
M, MONI	DTMF memory entry mode.	P.31 4-7
M, ENT	Clear the displayed memory channel data.	P.21 4-4-5

- Press the M key for longer than 1 second, then the key below.

Key	Function	Refer to
M1Sec, 4	Enter the upper limit frequency of programmable scan 1	P.24 4-5-4
M1Sec, 5	Enter the upper limit frequency of programmable scan 2	P.24 4-5-4
M1Sec, 7	Enter the lower limit frequency of programmable scan 1	P.24 4-5-4
M1Sec, 8	Enter the lower limit frequency of programmable scan 2	P.24 4-5-4

- Press the F key for longer than 1 second, then the key below.

Key	Function	Refer to
F1Sec, MONI	Recall the DTMF memory	P.32 4-7
F1Sec, DTSS	DTSS Code Selection	P.33 4-8-2
F1Sec, LOW	Battery Saver function on or off	P.42 4-11
F1Sec, 1	Audio confirmation BEEP on or off	P.15 4-2
F1Sec, 3	Tone Alert sound ( Pi Pi Pi or Pul Pul Pul)	P.41 4-10
F1Sec, 4	Displays the upper limit frequency of the programmable scan 1	P.24 4-5-4
F1Sec, 5	Displays the upper limit frequency of the programmable scan 2	P.24 4-5-4
F1Sec, 7	Displays the lower limit frequency of the programmable scan 1	P.24 4-5-4

- Press the F key for longer than 1 second and then the key below.

Key	Function	Refer to
F 1Sec, 8	Displays the lower limit frequency of the programmable scan 2	P.24 4-5-4
F 1Sec, ENT	Tuning control lock	P.11 ENT key
F 1Sec + 0	Automatic Power Off function on or off	P.42 4-12

- Press and hold the key below and turn on the power switch.

Key	Function	Refer to
DTSS and power ON	DTSS delay time selection ( 450/750mS)	P.34 4-8-4
5 and power ON	DTMF delay time ( 2 sec) on or off	P.30 4-6-4
6 and power ON	Memory recall mode selection ( 1 or 2 digits)	P.22 4-4-6

- Press and hold the key below and turn on the power switch.

Key	Function	Refer to
8 and power ON	Enter the lower limit of the programmable VFO tuning limit.	P.17 4-2-4
9 and power ON	Enter the upper limit of the programmable VFO tuning limit.	P.17 4-2-4
M and power ON	MEMORY RESET	P.19 4-4-2
ENT and power ON	VFO RESET	P.19 4-4-2
SHIFT and power ON	Switching the Alert methods	P.27 4-5-10

Display panel

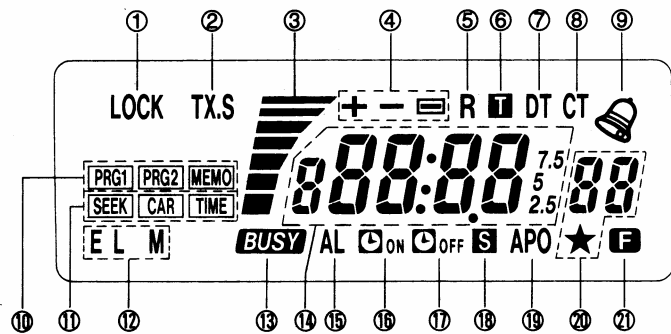

- ① LOCK LOCK ON when LOCK function is active.
- ② TX.S ON when TX.STOP function is active.
- ③ This level meter indicates the relative receive input strength or battery voltage level during transmit.
- ④ + - Displays the selected transmitter offset direction.  
+ - (European version)  
During split channel operation both + and - indicator light.
- ⑤ ON when Reverse function is active.
- ⑥ ON when Tone function is active.
- ⑦ DT ON when DTSS function is active.
- ⑧ CT ON when CTCSS function is active.
- ⑨ On when Tone Alert System is active. The indicator will flash when a signal is received.

- ⑩ Displays the selected scan mode. Flashes when scanning.
- ⑪ Displays the selected scan hold/resume condition.
- ⑫ E L M Displays the selected output power, i.e. Economic-low, Low, Medium, and no indicator Hi.
- ⑬ ON when squelch is open.
- ⑭ Displays the operating frequency to the nearest kHz, the frequency step size, or the tone frequency. Flashes during VM SCANNING and MHz scanning.  
 ON in paging mode.  
ON in CLOCK mode.
- ⑮ AL ON when Priority Alert system is active.
- ⑯ ON when the ON TIMER function is active.
- ⑰ ON when the OFF TIMER function is active.
- ⑱ ON when BATTERY SAVER function is active.
- ⑲ APO ON when AUTOMATIC POWER OFF function is active.
- ⑳ Displays the current Memory Channel number. The star indicator is on when the Memory channel will be skipped during Memory Channel Scan.
- ㉑ ON whenever the F key is depressed.

## 4-2. RECEIVER OPERATION

Audio confirmation is provided whenever a front panel key is depressed. You can disable this function by pressing the F key for longer than 1 second, then pressing the 1 key.

### 4-2-1. Receiver Operation

Connect the battery pack and the supplied antenna. Set the controls as follows:

1. Press the power switch for longer than 0.3 second.

TH-27  
series

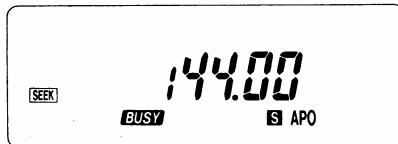

TH-47  
series

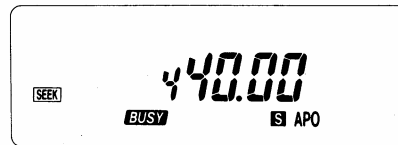

The frequencies shown above are the default frequencies after a microprocessor reset. If the display shows incomplete data or you think the displayed frequency is in error, reset the microprocessor Memory Initialization on page 19.

2. Rotate the VOL control clockwise until a signal or noise is heard coming from the speaker.
3. Rotate the tuning control to selected an open channel.
4. Rotate the SQL control clockwise until the noise just disappears and the BUSY indicator turns off. This point is known as the Squelch Threshold point.

5. Select the desired operating frequency using the tuning control. When a signal is received the S-meter will deflect and the BUSY indicator will turn On.

### 4-2-2. Frequency Selection

- Direct Keyboard Frequency Entry
1. Press the ENT key to select the ENTER mode.

ENT

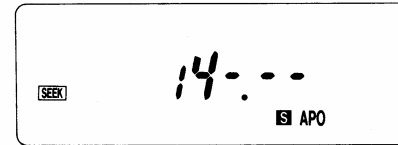

2. Within 10 seconds of pressing the ENT key enter the frequency from most significant digit to the least significant digit.

4

5

6

5

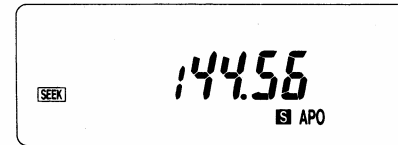

Before entering 1 kHz digit this indicator may flash.

The transceiver changes frequency after 1 kHz digits have been entered (1 kHz digit is not displayed). If 1 kHz digit indicator flashes, enter the 1 kHz digit frequency. If you should make an error before entering all digits, press the ENT key twice, and reenter all digits.

In 12.5 kHz or 25kHz step size, direct frequency selection will be completed in the 10 kHz digit. When you enter the following keys for the 10 kHz digit, 1 kHz and 100 Hz digit frequencies are automatically selected the list below.

(10 kHz digit) key.	Frequency [kHz]	(10 kHz digit) key.	Frequency [kHz]
0	00	5	50
1	12.5	6	62.5
2	25	7	75
3	37.5	8	87.5
4	37.5	9	87.5

### 4-2-3. Step Size Selection

To select the desired tuning or scan step size use the following procedure:

1. Press the F key momentarily, then press the MHz/STEP key. The current frequency step size will be displayed.



2. Rotate the Tuning control until the desired tuning step size appears in the display. The frequency step is indicated in the chart below.

5↔10↔15↔20↔12.5↔25↔5

3. To complete the programming of the step size you can press the MHz/STEP key.

The chart below illustrates the way the displayed frequency will change when you change from one step size to another.

5,10,15,20 to 12.5,25

0,5,10,15	0
20,25,30,35	25
40,45,50,55	50
60,65,70,75	75
80,85,90,95	75

12.5,25 to 5,10,15,20

0	0
12.5	10
25	20
37.5	30
50	50
62.5	60
75	70
87.5	80

For example:

Assume you are presently displaying a frequency of 439.920 MHz and had previously selected a 20 kHz step size. If you were to change the step size to 12.5 kHz the display would then read 439.925 MHz.

### 4-2-4. Programmable VFO Tuning Limits

The radio provides the capability of programming the VFO tuning range, in 1 MHz band segments, as well as providing a separate programmable band scan function. (See section 4-5.) For example you could tell the transceiver that you only wish to tune the 144.000



145.000 MHz band segment by specifying any frequency with these two segments. The Tuning controls would then only tune within these specific bands. The procedure for specifying the bands is described below.

1. Rotate the Tuning control until the desired lower tuning range appears on the frequency display. For example you might want to select the 144 MHz band and dial up 144.100 MHz.
2. Turn off the transceiver POWER switch. Now press and hold the 8/CAR key while you turn on the POWER switch.
3. Rotate the Tuning control until the desired upper tuning range appears in the frequency display.
4. Turn off the transceiver POWER switch. Now press and hold the 9/TIME key while you turn on the POWER switch.
5. To confirm that the programming was properly performed rotate the Tuning control. The transceiver should not go above or below the programmed band limits.
6. To clear both programmed limits simultaneously initialize the VFO memory reset using the procedures discussed on page 19.

You can reprogram either limit independently by following the appropriate instructions above.

### 4-3. TRANSMITTER OPERATION

**NOTE**

1. Ensure that an antenna with a low standing wave ratio (less than 1.5 SWR) is attached to the antenna connector before attempting to transmit. Failure to provide proper termination may result in damage to the final amplifier section.
2. Always check that the frequency is clear before transmitting.

1. Select the desired operating frequency using any of the methods previously discussed.
2. Check the frequency to see if it is occupied before you transmit.
3. Press the PTT switch. The ON AIR indicator will light, and the battery level meter will light.
4. Speak into the microphone. The recommended distance to the microphone is 5 cm (2 inches).

**NOTE**

Talking closer may result in overdeviation of your transmit signal, which might be reported as a loss of clarity or an excessively wide transmit signal. Talking too far away may result in reports of weak audio.

5. Release the PTT switch to return to the receive mode. The ON AIR indicator should go out, and the battery level meter will return to zero.

**■ Time Out Timer**

The transceiver has a time-out timer function to prevent possible problems caused by continuous transmission. This function forcibly stops continuous transmission after 10 minutes. When the timer times out, the transceiver beeps and automatically returns to the RX mode. Press the PTT switch to transmit again.

**■ TX. STOP**

Pressing the M/TX.S key within 10 seconds of pressing the F key will set the TX. STOP function on or off.

**■ Changing Transmitter Output Power**

Pressing the LOW key will allow you to select 4 different transmitter output power levels. The actual transmitter output power for this unit depends on the power supply being used.

- H (High power): For maximum output power.
- M (Medium power)
- L (Low power): For short-distance communication.
- EL (Economic Low power): For line-of-sight short-distance communication.

Output Power

	TH-27A/27E		TH-47A/47E		L	EL
	H	M	H	M		
PB-13	2.5	2	2	1.5	0.5	20
Manganese Battery	5	2.5	5	2.5	0.5	20
Alkaline Battery	2.5	2	2	1.5	0.5	20

## 4-4. MEMORY

### 4-4-1. Microprocessor Memory Back-up

#### CAUTION

THE MEMORY IS MAINTAINED BY A RECHARGEABLE SECONDARY LITHIUM BATTERY. WITH THE BATTERY CASE REMOVED, THE MEMORY IS RESET TO ITS INITIAL STATE AFTER ABOUT 20 DAYS. A FULLY DISCHARGED BATTERY WILL REQUIRE APPROX. 10 HOURS TO REACH FULL CHARGE AFTER INSTALLING A NiCd BATTERY PACK OR AN EXTERNAL POWER SUPPLY.

### 4-4-2. Microprocessor Initialization

The initial state of the microprocessor, as delivered from the factory is shown in the chart below.

	TH-27A	TH-27E	TH-47A	TH-47E
VFO f. Call CH	144 MHz	144 MHz	440MHz	430 MHz
f. step	5 kHz	12.5 kHz	25 kHz	25 kHz
Tone frequency	88.5 Hz(※)	1750 Hz	88.5 Hz(※)	1750 Hz

(※) Only when the CTCSS unit TSU-7 is installed.

#### • Memory Reset

##### MEMORY RESET

Press and hold the M key and turn on the POWER switch. All the LCD indicator will light. Release the M key. All user programmed data will be initialized.

##### VFO RESET

Press and hold the ENTER key and turn on the POWER switch to reset the microprocessor's VFO memory, without destroying the memory channel, automatic dialer DTMF memory channel, Programmable VFO tuning range, or call channel data.

### 4-4-3. Memory Channel

This transceiver provides 40 memory channels. In addition to serving as a normal memory channel Memory Channel 1 is used to store the frequency for the Priority Alert function.

### 4-4-4. Memory Contents

Each memory channel is capable of storing the following information;

Channel	Normal channel	Split channel
RX frequency	○	○
TX frequency	NA	○
Tone(CTCSS) frequency / Tone (CTCSS) status	○	○
Frequency step	○	○
Shift status, REV on/off	○	NA
DTSS code, DTSS status	○	○

#### 4-4-5. Memory Entry

- Normal channel entry or Odd split channel RX frequency entry
1. Select the desired receiver frequency, tone information etc.
  2. Press the M key momentarily. The -- indicator will light in the memory channel display.

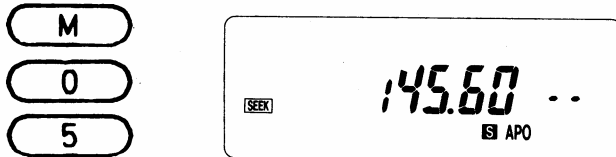

3. Select any memory channel (00 ~ 39) using the numeric keys.  
To enter data in memory, a 2-digit number is used.

Memory channel number will turn off. This indicates that the receiver data has been properly stored in memory.

- TX frequency entry (Split memory channel only)
1. Press the ENT key and numeric keys to select the desired transmitter frequency.
  2. Press the M key momentarily. The -- indicator will light on the memory channel display.
  3. Press and hold the PTT switch and select the memory channel (00 ~ 39) using the numeric keys.

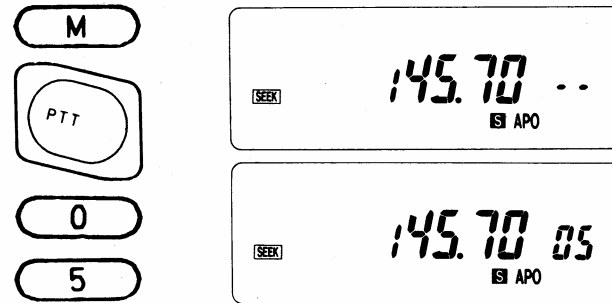

**NOTE**  
When recall the nothing is stored memory a error sound will be heard .

4. The radio return to the previous mode.

**NOTE**

When the RX frequency is rewritten in the odd split channel, the TX frequency of the channel will be automatically erased.

- To Confirm the Contents of the Split Channel

1. Press the memory channel number key. The programmed receiver frequency appears on the display with “+” and “-” offset direction indicator. This indicates that this channel has an odd split entered.

5

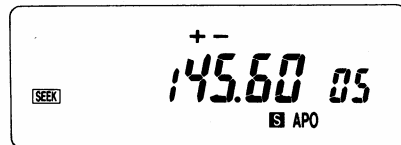

2. To check the transmit frequency press the F key, then SHIFT/REV key. The transmit frequency will appear in the display.

- Call Channel entry

1. Select the desired CALL channel frequency, tone data etc.
2. Press the M key momentarily then press the CALL key within 10 seconds of pressing the M key.

- Odd split Call Channel

1. Select the desired CALL channel TX frequency.
2. Press the M key momentarily.
3. Press and hold the PTT switch and press the CALL key.
4. Release the PTT switch.

- Clearing a Memory Channel

If you want to clear the contents of an individual memory channel use the following procedure.

1. Select the memory channel you wish to clear.
2. Press the M key, then ENT key.
3. The selected memory channel number will disappear.

#### 4-4-6. Memory Channel Recall

**NOTE**

If nothing is stored in the channel, the memory cannot be recalled and an error tone sounds.

**One-digit Recall**

The one-digit input mode is useful mainly to use only channels 0 to 9. Any of channels 0 to 9 can be directly recalled simply by pressing its number key. Then rotate the Tuning control to select 10 to 39. To return to the VFO mode, press that key again.

### Two-digit Recall

In this mode, numbers 00 to 09 are entered to recall channels 0 to 9 respectively. All channels 00 to 39 can be directly recalled using the numeric keys. To return to the VFO mode, press those keys.

- ONE-Digit Recall, or TWO-digit Recall Selection

1. Turn the power switch off.
2. Press and hold the 6/MEMO key and turn on the power switch.

### 4-4-7. Memory Shift

Using this function you can copy the contents of a memory channel or call channel to the VFO without changing the data in memory. This will allow you to begin tuning at the point specified by the memory channel data.

- If you do not need to change the frequency after shifting;
  1. Select the desired Memory Channel.
  2. Press the ENT key twice. If an Odd Split Memory channel is selected, only the receive data is copied.

- If you need to change the frequency after shifting;
  1. Select the desired Memory Channel. (For example Ch. 5)
  2. Press the ENT key. The display will indicate the ENTER mode frequency status.

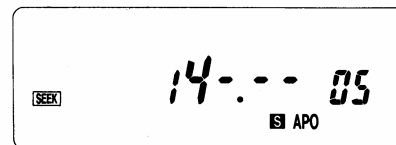

3. Within 10 seconds of pressing the ENT key rotate the tuning control to the desired frequency. The memory channel or Call channel indicator will turn OFF to signal the data has been successfully transferred to the VFO.

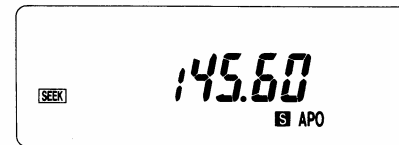

## **4-5. SCAN**

For proper scan operation the squelch must be adjusted to the threshold point.

Scan cannot be used in conjunction with the Tone Alert System.

### **4-5-1. Scan Options**

The following scan options are available:

#### **Band Scan**

Scan proceeds over the entire band.

#### **Programmable Band Scan1 or 2**

The scan range in this mode is specified in memory.

#### **MHz Scan**

Scans over a 1 MHz range. This function operates during the Band Scan or Programmable Band Scan only.

#### **Memory Scan**

Scan proceed thru those memory channels that have data stored and have not been locked out.

#### **VFO/Memory Scan**

Alternate scanning of the VFO and the memory channel last used.

#### **CALL/VFO Scan**

Alternate scanning of the call channel and VFO.

#### **CALL/Memory Scan**

Alternate scanning of the call channel and the memory channel last used.

### **4-5-2. Hold/Resume Programming**

Three type of scan hold/resume are provided in this transceiver.

#### **SEEK Operated Scan**

In this mode the radio will stop scanning on a busy channel.

#### **CARRIER Operated Scan**

In this mode the radio will stop scanning on a busy channel and remain there until the signal drops out. The radio allows a 2-second delay before it resumes scanning so that you don't loose the station when operators change.

#### **TIME Operated Scan**

In this mode, the radio stops on a busy channel, remains there approximately 5 seconds, then continues to scan even if the signal is still present.

The radio is delivered from the factory in the SEEK Operated Scan mode.

During scanning selected scan hold/resume condition indicator will flash.

**NOTE**

When the CTCSS is operating, scan will stop only on a signal which contains the proper CTCSS tone.  
With the DTSS in operation, scan will stop (with squelch turned off) whenever it receives a signal. Squelch will not open, however, until the proper DTSS signal is received.  
With both the CTCSS and the DTSS on scanning will stop when the proper CTCSS tone is received. Squelch will open only if the DTSS signal matches when scan stops.

**4-5-3. Band Scan**

1. Adjust the SQL control to the threshold point.
2. When any of the PRG-1, the PRG-2, or the MEMO indicator has not been lit, press the SCAN key. The MHz indicator begins flashing to indicate that the radio is scanning.
3. Scan will begin in an upwards direction. You can reverse the direction of scan by turning the Tuning control. The tuning step size depends on the current Frequency Step selection.
4. Scan stops on a busy channel, i.e. a station strong enough to open squelch and turn on the BUSY indicator.
5. Press the PTT switch or SCAN key to stop scan.

**4-5-4. Programmable Band Scan**

- The Lower and the Upper Scan Limits Entry  
Select a frequency to be the lower or the upper scan limit. Press the M key for longer than 1 second, and then press the below key.

Limit	Programmable band scan 1	Programmable band scan 2
Upper	4 / PROG-1 key	5 / PROG-2 key
Lower	7 / SEEK key	8 / CAR key

- Confirmation of the lower and upper frequency limits  
Hold the F key down for longer than 1 second, then press one of the keys listed above. The upper or lower frequency limits will be displayed as VFO frequency.

**NOTES**

1. If the step size of the lower limit frequency is different from that of the upper limit frequency, Programmable band scan will not start.
2. If the lower limit frequency is equal to or higher than the upper limit frequency, Programmable band scan will not start.



- Selecting programmable band scan 1 or 2

When you press the F key, then the 4/PROG-1 key, the PROG1 indicator lights and programmable band scan 1 is selected.

When you press the F key, then the 5/PROG-2 key, the PROG2 indicator lights and programmable band scan 2 is selected.

- Programmable Band Scan

1. Adjust the SQL control to the threshold point.
2. Press the SCAN key. The PROG1/PROG2 indicator will begin flashing as a visual reminder the transceiver is scanning.

Continue to 4-5-3 step 3.

#### **4-5-5. MHz Scan**

1. Adjust the SQL control to the threshold point.
2. Press the MHz key during band scan or programmable band scan. The MHz indicator will begin flashing as a visual reminder the transceiver is scanning.
3. Scanning will start in an upwards direction over a 1 MHz range. You can change the direction of scan by turning the Tuning control.

Continue to 4-5-3 step 4.

#### **4-5-6. Memory Channel Scan**

##### **NOTE**

Only those memory channels that have data entered, and that have not been locked out will be scanned.

Scan does not start more than 2 channels have data entered.

Press the F key and then the 6/MEMO key.

The MEMO indicator will light to prepare memory scan.

1. Adjust the SQL control to the threshold point.
2. In the memory channel mode press the SCAN key to initiate scan.

The MEMO indicator begins flashing as a visual reminder that the transceiver is scanning.

Continue to 4-5-3 step 4.

#### **4-5-7. VFO/Memory Channel Scan**

1. Adjust the SQL control to the threshold point.
2. Press the F key, then the SCAN/VM. SCAN key initiate VFO/Memory scan.
3. Alternate scanning of the VFO frequency shown on the display and the memory channel last used.

Continue to 4-5-3 step 4.

### 4-5-8. CALL Scan

#### CALL/VFO Scan

Press the F key, then the CALL/C.SCAN key in the VFO mode to start alternate scanning of the VFO frequency shown on the display and the call channel.

#### CALL/Memory Channel Scan

Press the F key, then the CALL/C.SCAN key in the memory channel mode to start alternate scanning of the CALL channel and the Memory channel that was last used.

### 4-5-9. Memory Channel Lockout

This function allows you to specify which memory channels you wish to skip during memory channel scan.

1. Select the memory channel that you wish to skip by pressing the numeric keys.
2. Press the F key. The F indicator lights. Within 10 seconds of pressing the F key, press the 0/L.OUT key. A ★ indicator appears under the memory channel number. This indicates that the memory channel will be skipped in the memory channel scan mode.

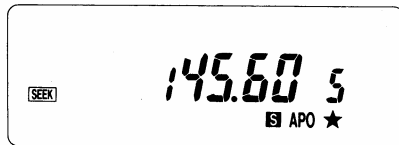
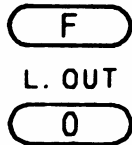

3. Repeat steps 1 and 2 to lock out any other channels you wish to skip.
4. To cancel the lockout, select the desired memory channel as described in steps 1, and 2 above. Press the F key, then the 0/L.OUT key. The ★ indicator goes off.

### 4-5-10. Priority Alert Function

The priority Alert function allows you to monitor memory channel 1 once every 5 seconds for activity even when you are tuned to a different channel number.

#### • Alert by Warning Tone

If a signal is present beep will sound from the speaker to indicate that the channel is busy.

To activate the priority alert function:

1. Ensure the frequency you wish to monitor has been entered in memory channel 1.
2. Adjust the SQL control to the threshold point.
3. Press the F key momentarily, then press the 1/AL key. The AL indicator will turn on the display to indicate that this function has been activated.

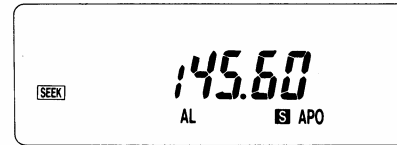
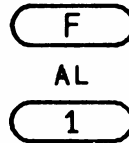

4. If a signal is present a beep is heard from the speaker.
5. To turn this function off repeat step 3. The AL indicator goes off.

- Alert Channel Display

Press the SHIFT key while turning on the Power to switch the Alert methods to "Alert Channel Display".

In this method if a signal is present beep will sound and the transceiver will switch to the frequency stored in memory channel 1. (Press the 1/AL key to return to the previous channel.)

To turn this method off press the SHIFT key again while turning on the power.

**NOTE**

1. Even if CTCSS function is activated in the memory channel 1, CTCSS is not checked.
2. While memory channel 1 is being scanned you will not hear voice communications, only a beep is heard if a signal is present.
3. There is no Alert when the DTSS, or Paging function are on.

## 4-6. REPEATER OPERATION

### 4-6-1. Transmitter Offsets

All amateur radio repeaters utilize a separate receiver and transmit frequency. The receiver frequency may be either above or below that of the transmit frequency. The configuration of most repeaters will fall into one of the categories listed below:

	TH-27A/E	TH-47A	TH-47E
+	+ 600 kHz	+ 5 MHz	+ 1.6 MHz
-	- 600 kHz	- 5 MHz	- 1.6 MHz
- -			- 7.6 MHz

- Offset Direction

To select the desired transmitter offset direction press the SHIFT key. Each time you press the key the transceiver will advance from one direction to the other, i.e. "+" to "-" ("-" to "- -" with European versions) to no offset (simplex).

- Automatic Offset Selection (U.S.A., Canada and Oceania version)

The TH-27A has been programmed according to the standard ARRL (Amateur Radio Relay League) Band Plan with regard to transmitter offset direction. Please see the accompanying chart for addition information on this

programming. You can, of course, override this by using the SHIFT key if desired.

145.1	145.5	146.0	146.4	146.6	147.0	147.4	147.6	148.0	
S	-	S	+	S	-	+	S	-	S

S : simplex

### 4-6-2. Reverse Function

Some repeaters utilize a "Reverse Pair", i.e. the transmit/receive frequencies are exactly the reverse of another repeater. For example repeater A uses 146.000 for a transmit frequency (INPUT) and 146.600 for a receiver frequency (OUTPUT). Repeater B might use 146.600 for a transmit frequency and 146.000 for a receiver frequency. It would be inconvenient to have to reprogram the transceiver each time you wanted to use these repeaters.

The SHIFT/REV key allows you to easily reverse the transmit and receiver frequencies. To use the REV function press the F key, then the SHIFT/REV key. The R indicator will turn on in the display to remind you that you are working a reverse pair.

To return to normal press the F key, then SHIFT/REV key again. The R indicator will turn off.

This function is also useful to check the input frequency of the repeater so that you can determine if you are within range for simplex communications.

### 4-6-3. Tone and CTCSS Operation

Some repeaters require the use of a control signal to activate the repeater. Several different methods are currently in use.

In the United States sub-audible tones are sometimes used. 38 different Sub-audible frequencies are possible. With the use of the optional CTCSS unit (TSU-7 ※) you will be able to operate in a Tone Operated Squelch Mode. When this option is installed and the CTCSS function has been activated the radio will not open squelch until the proper tone is received.

(※) The CTCSS unit (TSU-7) is included with models U.S.A and Canadian version.

In Europe and United Kingdom a 1750 Hz tone is used in transmit. Press and hold the TONE key to transmit with the access tone, you need not press the PTT switch. Since this tone is required in Europe and the United Kingdom a 1750 Hz tone encoder is included with models delivered to these countries.

- Tone Frequency Selection

1. Press the F key. The F indicator will light. Press the TONE/TONE SEL key within 10 seconds of pressing the F key. The current tone frequency will show in the display.
2. Rotate the Tuning control to select the desired tone frequency.

3. When the desired tone frequency is selected, the previous mode is resumed 10 seconds after selection or when the TONE/TONE SEL key is pressed.

Tone Frequency (Hz)

67.0	82.5	97.4	114.8	136.5	162.2	192.8	233.6
71.9	85.4	100.0	118.8	141.3	167.9	203.5	241.8
74.4	88.5	103.5	123.0	146.2	173.8	210.7	250.3
77.0	91.5	107.2	127.3	151.4	179.9	218.1	
79.7	94.8	110.9	131.8	156.7	186.2	225.7	

- Tone/CTCSS Operation

With the use of the CTCSS unit (TSU-7) the transceiver will transmit the desired tone.

TONE:

Press the TONE key. The T indicator appears in the display the transmitter will transmit the desired tone.

CTCSS:

Press the F key and then the 2/CTCSS key. The CT indicator appears in the display the transceiver will transmit the desired tone and will also operate in the Tone Squelch mode, i.e. squelch will not open until the proper tone is received as a portion of the incoming receive signal.

#### 4-6-4. Autopatch Operations (U.S.A. versions only)

Some repeaters offer a service known as autopatch. This feature allows you to dial a telephone number from your transceiver and carry out a telephone conversation, much like a car telephone, or cellular telephone. This function requires the use of a DTMF (Dual Tone Multi Frequency) pad. In addition to the normal 12 keys that are found on your telephone the transceiver also provides 4 additional keys, A, B, C and D. These keys are required by some repeater systems for various control operator of your repeater to determine if their use is required. A chart is provided that lists the various tone frequencies that are generated by the keypad.

To activate the keypad:

1. Press and hold the PTT switch.
2. Press the keys just like you would dial your telephone at home.

(Hz)	1209	1336	1477	1633
697	1	2	3	A(F)
770	4	5	6	B(M)
852	7	8	9	C(ENTER)
941	*	0	#	D(SCAN)

#### Note

Some repeaters will require the use of a special key sequence to activate the autopatch function. You should check with your control operator for this sequence.

If one of the keys is pressed after the DTSS key has been pressed during transmission, a single tone will be heard.

key	(Hz)	key	(Hz)
1	697	5	1209
2	770	6	1336
3	852	7	1473
4	941	8	1633

- Delay time selection (Direct keyboard entry only)  
You can select the transceiver remaining keyed for 2 seconds after pressing each number.
  1. Turn the power switch off.
  2. Press and hold the 5 key.
  3. Turn on the power switch.
  4. Release the 5 key .
  5. Repeat step 1 to 4 to cancel the delay time.

## 4-7. DTMF MEMORY

DTMF telephone numbers, of up to a maximum of 15 digits, can be memorized.

- Storing the DTMF codes

1. Press the M key, then the MONI switch to select the DTMF code entry mode.

M

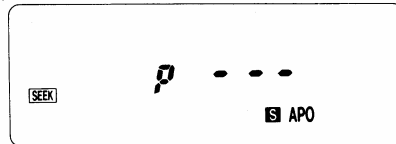

2. Enter the DTMF code on the DTMF code key (up to a maximum of 15 digits)

The DTMF code key

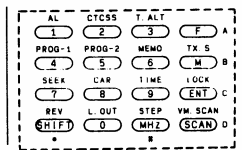

U.S.A. and Canadian version

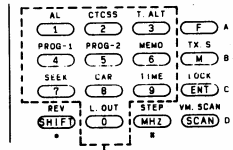

Except U.S.A. and Canadian version

5

4

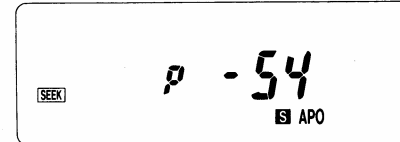

3. After the DTMF code is entered, press the DTSS key (U.S.A. and Canadian version), or ENT key. (other version)



U.S.A. and Canadian version

ENT

Except U.S.A. and Canadian version

4. Select the channel (0 ~ 9) where you want to store the DTMF code and press the key for that channel. When the DTMF code is stored to that channel, the previously shown frequency reappear on the display.

### NOTES

If you enter the wrong number, press the CALL key (U.S.A. and Canadian version) or the \* key (other version) to start again before pressing the ENT key.



U.S.A. and Canadian version

SHIFT

\*

Except U.S.A. and Canadian version

- Recalling stored DTMF code in receive mode

1. Press the F key for longer than 1 second and press the MONI switch after flashing the F indicator.



More than 1 second

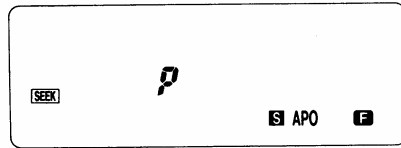

2. Press the numeric (0~9) key. The DTMF code stored in the key will be output to the display.
3. The code is displayed from right to left as illustrated.

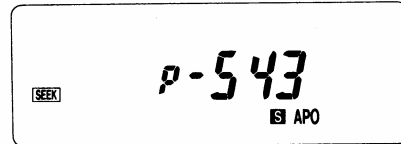

- Making a DTMF Call

1. Press the PTT switch.
2. Press the MONI switch (or CALL key) and then press the numeric key for the channel where you stored the DTMF code in receive mode.  
The DTMF code will be output. The display will show the code.

3. After transmitting the code the previously shown frequency will reappear on the display.

**NOTES**

1. While the stored DTMF code is recalled, transmission continues until the whole code string is recalled even if the PTT switch is released.
2. You cannot stop output of the stored DTMF code midway.



## 4-8. DTSS (Dual Tone Squelch System)

This function allows squelch to be turned on in receive mode on reception of a three-digit code matching the DTSS code selected in your radio.

Once squelch is turned on by reception of a matching code, squelch operates normally from then on. If no signal is received for longer than 2 seconds, squelch is turned off until a matching code is received.

### NOTE

This function is not available in some areas.

### 4-8-1. DTSS Code

DTSS codes from 000 through 999 can be stored in memory channels, and CALL channel.

### 4-8-2. DTSS Code Selection

Press the F key for longer than 1 second. Press the DTSS key while the F indicator is flashing (for 10 seconds). This enters code selection mode. Then enter a three-digit number on the key pad.

### NOTES

1. If a key other than the numeric key is pressed during operation, code selection mode is canceled.
2. If no action is taken for longer than 10 seconds, code selection mode is automatically cancelled.

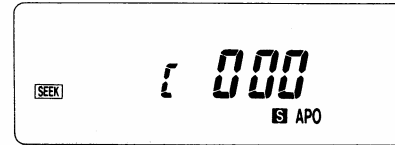

### 4-8-3. Using the DTSS function

1. Adjust the SQL control to the threshold point.
2. Press the DTSS key. The DT indicator will light.
3. RECEIVE;  
Squelch will open when the proper code is received.  
TRANSMISSION;  
When the PTT switch is pressed, the code is sent out for about 0.5 second.

### NOTES

1. Voice output is muted during code output.
2. We recommend that you turn off the Battery Saver function when you use the DTSS function.

4. To cancel the DTSS function press the DTSS key again.

### NOTES

The DTSS code may not be accepted if the repeater is "identifying". If this should occur you should press the PTT switch again, and retransmit the DTSS code.

If the distant (receiving) station has activated a battery saver circuit it might not receive the DTSS code. There are two recommended methods of compensating for this situation.

1. Press the PTT switch for a few seconds, send the DTSS code, release the PTT switch, then press the PTT switch again and resend the appropriate code.
2. Proper DTSS operation will occur if you ensure the battery saver circuit is disabled whenever you intend to operate using either the DTSS modes.

#### **4-8.4. Using DTSS with a Repeater**

The DTSS signal is transmitted after a short delay if the PTT switch is pressed. This is to avoid any malfunction due to the DTSS signal being interrupted by repeaters with long response times.

- Delay during DTSS Output

A delay is built in when the DTSS is sent out.

Normal	250 mS
SHIFT, split channel operation	450 mS, or 750 mS

- To change delay time

1. Turn the power switch off.
2. Press and hold the DTSS key.
3. Turn on the power switch.
4. Release the DTSS key.

## 4-9. PAGING

The paging function is useful to call all members of a group, a specific station, or wait for a call from another station by using a DTMF (Dual Tone Multi Frequency) signal.

Example: When member 2 is called

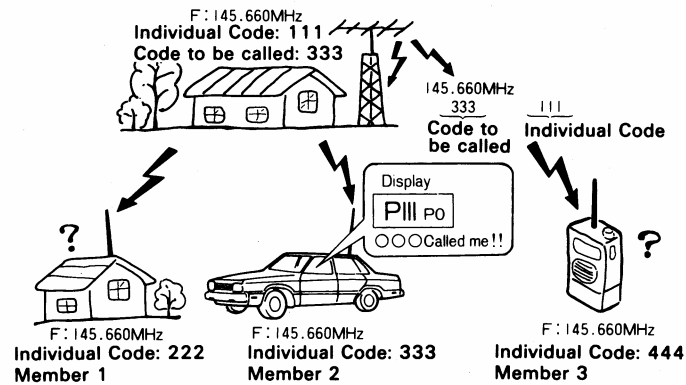

The common group code and individual codes should be determined in advance. These codes should be from 000 to 999 (3 digits). Unlike DTSS, the code of the calling station is displayed on the receiver, so the receiver can identify the calling station.

When called by a local station, the individual code the individual code of the calling station is displayed. When called with a group code, that group code is displayed.

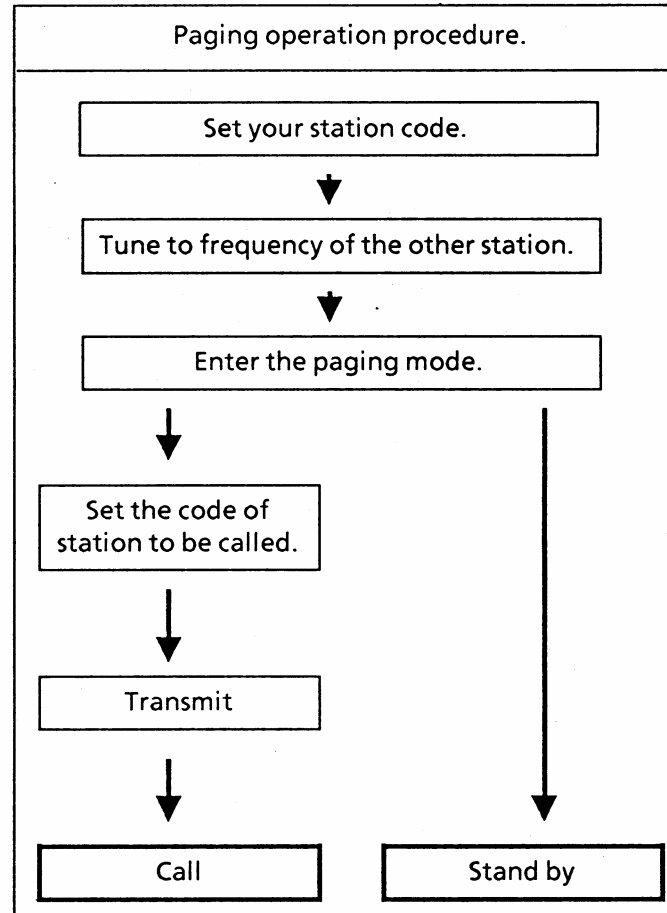

### 4-9-1. Paging Code Memories

There are 11 paging code memories.

	Use
A	Stores your station ID code in memory.
0	Automatically stores the calling station's code during reception. Can temporarily set the code for the station to be called.
1~9	Stores group codes and local station codes in memory.

### 4-9-2. Setting the Paging Codes

1. Press the F key, then press the DTSS/PAG key.  
The P indicator will light. (PAGING MODE)
2. Press the ENT key to enter the CODE SETTING MODE.
3. Select memories (A, 0 to 9) using the tuning control.
4. Enter the code (000 to 999) using the numeric keys.
5. Press the ENT key again to exit the code setting mode.

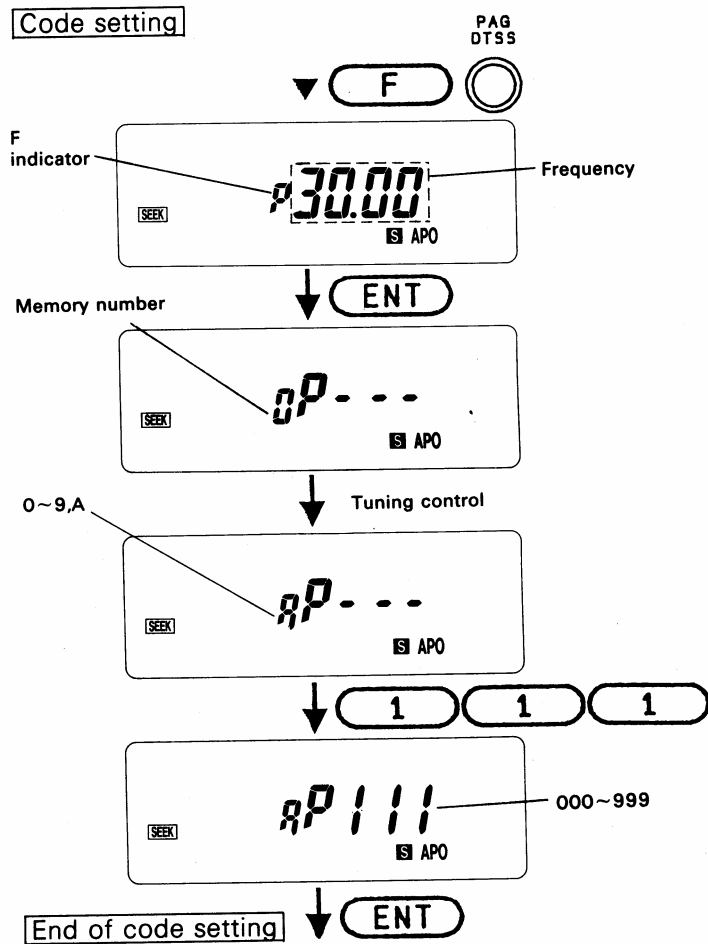

For example, the following groups communicate with each other.

Predetermined frequency 145.660MHz  
 Group code 789  
 Member 1 Individual Code 111  
 Member 2 Individual Code 222  
 Member 3 Individual Code 333  
 Member 4 Individual Code 444

Member 1 A 111 0 1 2 3 789 4 444 ★ 5 6 7 8 9	Member 2 A 222 2 789 0	Member 4 A 444 4 789 0
	Member 3 A 333 3 789 0	

### 4-9-3. Paging Transmission (Calling)

Your station ID code is preset in memory A. (The local station ID code is always stored in memory A.)

1. Tune to the predetermined frequency.
2. Press the F key, then press the DTSS/PAG key to enter the PAGING MODE.

The paging function of the other transceiver must be ON, too.

3. Press the ENT key to enter the CODE SETTING MODE.
4. Use the tuning control to select the memory channel in which the local station code is stored.

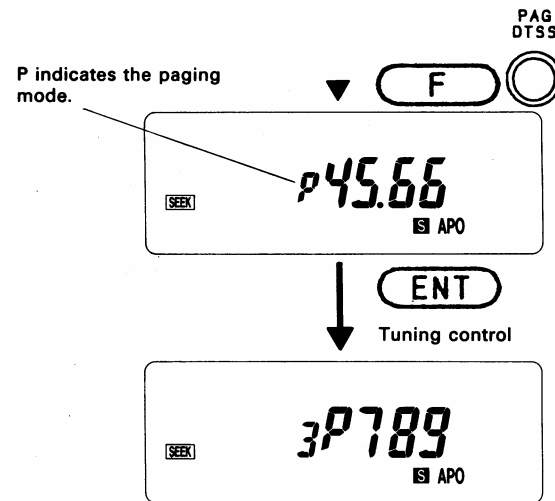

### Calling all members of the group.

To call all members of the group, select the memory channel in which the group code is stored. In this example, the group code is stored in number 3.

Press the PTT switch.

Communication is possible in both THE PAGING MODE and THE CODE SETTING MODE.

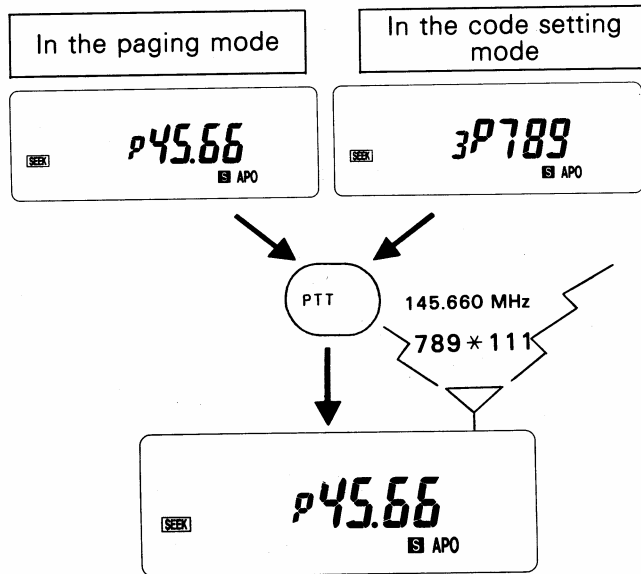

Group code 789 and your station ID code 111 are transmitted. After the codes are successfully transmitted, a DTMF tone sounds.

**38**

### Calling a specific member.

To call a specific member (for example, member 4), use the following procedure:

Select the memory in which the remote station code is stored (in this example, select memory 4.),

or Enter the individual code of the remote station in memory 0.

Then press the PTT switch.

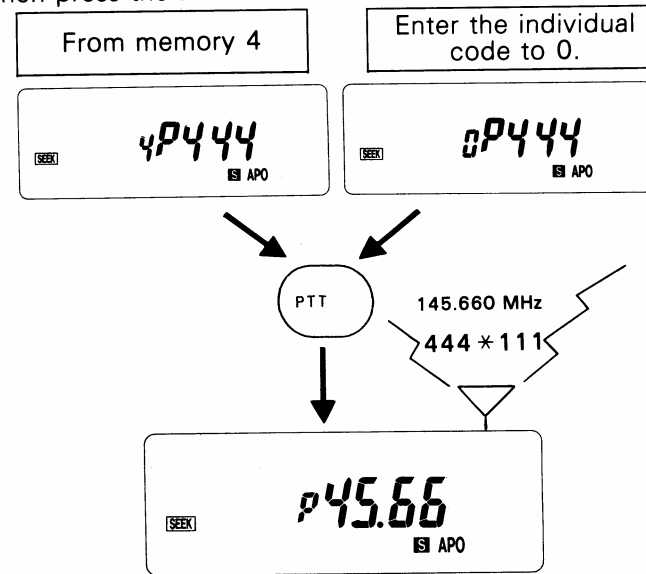

Remote station code 444 and local station ID code 111 are transmitted. After the codes are successfully transmitted, a DTMF tone sounds.

#### 4-9-4. Paging Reception (Wait)

1. Tune to the predetermined frequency.
2. Press the F key, then press the DTSS/PAG key to enter THE PAGING MODE.

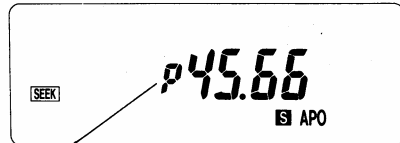

P indicates the paging mode.

Waiting with individual code.

3. When called with your station ID code, the memory number automatically change to 0. The ID code of the calling station is displayed. (For KENWOOD's transceivers. This also applies to the following descriptions.) (Example: Frequency: 145.660 MHz, calling station code: 444)

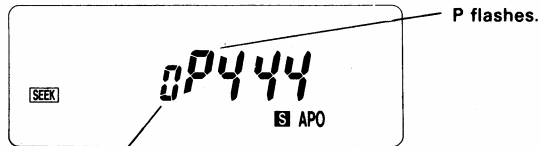

Zero is displayed to indicate that the station is being called.

4. The squelch is opened and the calling other party is heard. (The individual code of the calling station is stored in memory 0.)
5. Press the PTT switch to respond to the calling station.

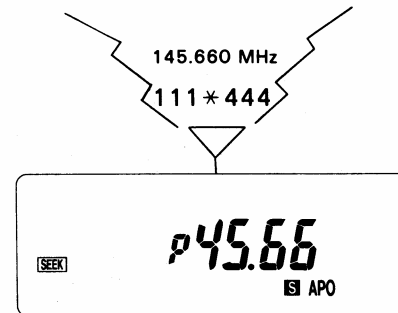

After the local station has been called, cancel paging. Communication can be performed more efficiently.

(※: If the remote station code can not be recognized, E appears on the display panel.)

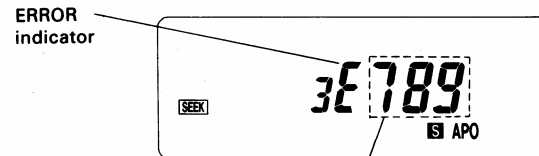

These codes are the previous ones.

## Waiting with group code.

3. When you are called with the group code, the common group code and its memory channel number are displayed.

(Example: For member 2, group code 789 is stored in memory for CH 2.)

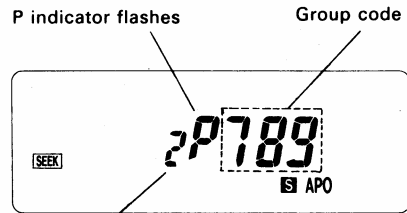

This code becomes a number other than 0 to indicate group calling.

4. When the PTT switch is pressed, group code 789 (as displayed) and your station ID code are transmitted. You can participate in the group roundtable.

After the remote station has been called, cancel paging. Communication can be performed more efficiently.

### NOTES

The PAGING code may not be accepted if the repeater is "identifying". If this should occur you should press the PTT switch again, and retransmit the PAGING code.

If the distant (receiving) station has activated a battery saver circuit it might not receive the PAGING code. There are two recommended methods of compensating for this situation.

1. Press the PTT switch for a few seconds, send the PAGING code, release the PTT switch, then press the PTT switch again and resend the appropriate code.
2. Proper PAGING operation will occur if you ensure the battery saver circuit is disabled whenever you intend to operate using either the PAGING modes.

## 4-9-5. Code Lockout

(A code is locked out only during reception with the paging function.)

If an individual code is stored in each of memories 1 to 9, reception is enabled when the codes match, even if one remote station communicates with another. To use memories 1 to 9 for transmission only, lock out the memories.

When the local station is communicating with two or more groups having the same frequency, lock out the group code with which stand by is temporarily stopped. (Group calling is possible.)

### • Paging Memory Lockout

1. Enter THE CODE SETTING MODE and display the memory channel number (except memory 0) to be locked out using the tuning control.
2. Press the M key. The ★ mark lights and the memory is locked out.
3. To cancel, repeat steps 1 and 2.



## 4-10. TONE ALERT SYSTEM

The Tone Alert function will provide an audible “alarm” to signal when someone is transmitting on the frequency you are monitoring. During T.ALT function you will not hear voice communication. When used in conjunction with the CTCSS, DTSS, or Paging function this would allow the transceiver to act similar to a private paging system!

1. Adjust SQL control to the threshold point.
2. If you will be using the CTCSS function you should select the proper tone frequency and ensure the CT indicator is on in the display.
3. Press the F key and then the 3/T.ALT key. The T.ALT indicator will light .
4. When a signal is present:  
The T.ALT indicator will flash.  
The busy indicator will light.  
The transceiver will beep ON and OFF for approximately 5 seconds.  
The time when the signal was received will be displayed.

### NOTES

1. When using CTCSS or DTSS the incoming signal must be present for approximately 1 second in order for the T.ALT to function properly.
2. If DTSS function is used in conjunction with Tone Alert function, Tone alert will activate only when the same DTSS signal receives.

5. The time is changed to new one when a new signal is received.

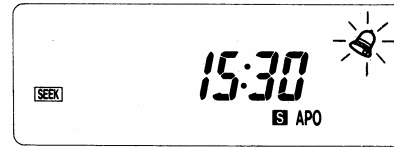

6. The T.ALT function can be released by pressing the PTT switch while the T.ALT indicator is flashing.
7. Before receiving a signal the T.ALT function can be released by pressing the F key, then the 3/T.ALT key again.

### • Beep Sound Selection

Pressing the F key for longer than 1 second and then pressing the 3/T.ALT key will switch the BEEP sound alternately between the Pi Pi Pi and Pul Pul Pul.

### NOTES

1. The Tuning control, PTT switch and all the keys except MONI, LAMP, and F are not effective during the T.ALT operations.
2. During the T.ALT operations Automatic Power Off function are disabled.

#### 4-11. BATTERY SAVER

The transceiver provides a battery saver mode to conserve on battery power. The transceiver will activate the battery saver circuit 10 seconds after the last key operation with the squelch closed. The function will be released by key operation or when squelch opens. The function cannot operate during scan, or T.ALT operations.

1. Press the F key for longer than 1 second and then press the LOW key. S indicator will light (Initial state is ON.)

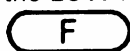

more than 1  
second  
CLOCK  
LOW

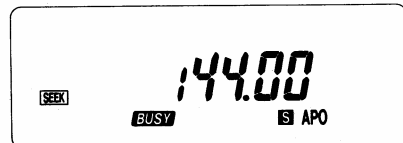
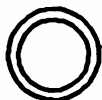

2. The function will be released by any key operation or when squelch opens.
3. The function can be turned off by pressing the F key for longer than 1 second and LOW key again.

#### 4-12. AUTOMATIC POWER OFF

This transceiver also provides an Automatic Power OFF circuit. The circuit action is described below. (Initial state is ON.)

1. A 5 second audio confirmation alert will sound after 59 minutes if no signal has been received and if you have not performed any operation. 1 minute after this alert signal the transceiver will turn the power switch off.
2. To turn the APO function OFF/ON, press the F key for longer than 1 second and then press the 0/L.OUT key.



more than 1  
second

L. OUT

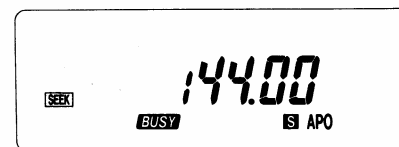
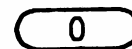

#### NOTE

APO function does not activate during scan or the TONE ALERT function in spite of lighting the APO indicator.

## 4-13. CLOCK

### ■ Digital Clock

The transceiver has a digital clock display.

- Clock Display

1. Press the F key, then the LOW/CLOCK key. The transceiver will display a 24-hour digital clock.

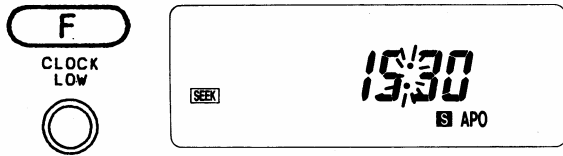

2. To return to the frequency display press the LOW/CLOCK key again.

- Set the Clock (Hour and Minute)

1. In clock mode press the 9 key, the hour will flash.
2. Rotate the tuning control to set the hour.
3. Press the ENT key. The minute will flash.
4. Rotate the tuning control to set the minute, then press the ENT key.

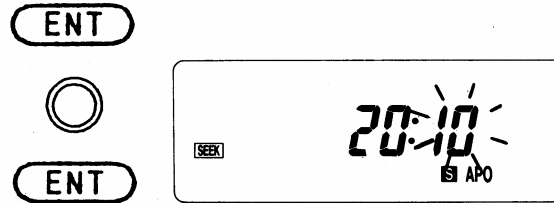
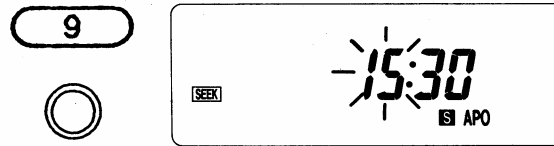

- Set the Clock (Second)

1. In clock mode press the 0 key. The second will reset to 0 (no indicator).

### ■ Time Switch ON

- Set the Switch-on Time

1. In clock mode press the 1 key. The T.ON indicator and hour will flash.

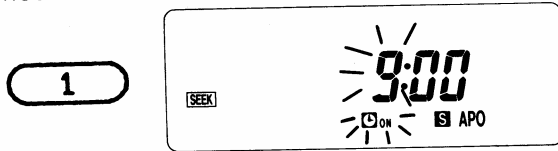

2. Rotate the tuning control to select the hour, then press the ENT key. The minute will flash.
3. Rotate the tuning control to select the minute, then press the ENT key.

- Activate the Time on Switch

1. In clock mode press the 2 key. The T.ON indicator will indicate the time on switch is active. The transceiver will turn the power on at the displayed time.

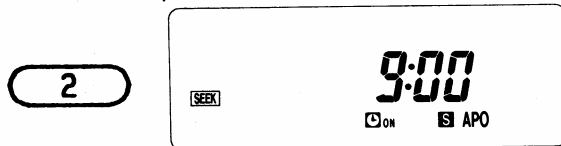

2. To release the function repeat step 1.

### ■ Time Switch OFF

- Set the Switch-off Time

1. In clock mode press the 4 key. The T.OFF indicator and hour indicator will flash.

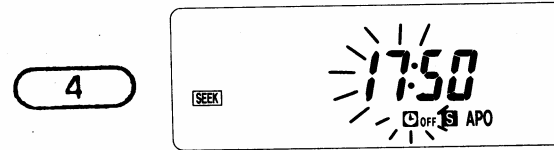

2. Follow steps 2 and 3 of SET THE SWITCH-ON TIME.

- Activate the Time off Switch

1. In clock mode press the 5 key. The T.OFF indicator will indicate the time off switch is active. The transceiver will turn the power off at the displayed time.

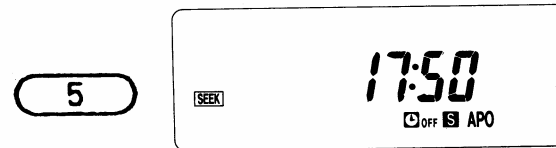

2. To release the function repeat step 1.

## 5. BLOCK DIAGRAM and SCHEMATIC DIAGRAM

another sheet

## 6. MAINTENANCE

### 6-1. GENERAL INFORMATION

Your transceiver has been factory aligned and tested to specification before shipment. Under normal circumstances the transceiver will operate in accordance with these instruction manuals. All adjustable trimmers and coils in your transceiver has been adjusted at the factory and should only be readjusted by a qualified technician with proper test equipment. Attempting service or alignment without factory authorization can void the transceiver's warranty. When operated properly, the transceiver will provide many years of service without requiring realignment. The information in this section gives some general service procedures which can be accomplished without sophisticated test equipment.

### 6-2. SERVICE

Should it ever become necessary to return the equipment to your dealer or service center for repair, pack it in its original box and packing, and include a full description of the problems involved. Also include your telephone number. You need not return accessory items unless directly related to the service problem.

#### Service note

Dear OM, if you desire to correspond on a technical or operational problem, please make your note short, complete, and to the point, and PLEASE make it readable.

Please list: Model and serial number.

The problem you are having.

Please give sufficient detail to diagnose. Information such as other equipment in the station, meter readings and anything else you feel might be useful in attempting diagnosis.

#### Caution

Do not pack the equipment in crushed newspapers for shipment. Extensive damage may result during shipment.

#### Notes

1. Record the date of purchase, serial number and dealer from whom purchased.
2. For your own information, retain a written record of any maintenance performed on the unit.
3. When claiming warranty service, please include a photocopy of the bill of sale, or other proof of purchase showing the date of sale must accompany the transceiver.

### 6-3. IN CASE OF DIFFICULTY

The problems described in this table are failures caused, in general, by improper operation or connection of the transceiver, not by defective components. Examine and check according to the following table.

Symptom	Probable cause	Corrective action
Indicators do not light and no receiver noise is heard when the POWER switch is turned on. All the indicators flash.	<ol style="list-style-type: none"> <li>1. Low voltage.</li> <li>2. With optional DC cable:               <ol style="list-style-type: none"> <li>1) Bad power cable or connections.</li> <li>2) Blown power supply fuse.</li> </ol> </li> </ol>	<ol style="list-style-type: none"> <li>1. Recharge/ replace the battery.</li> <li>2.               <ol style="list-style-type: none"> <li>1) Check cables and connections.</li> <li>2) Check for the cause of the blown fuse and replace the fuse.</li> </ol> </li> </ol>
No sound from the speaker. No signal can be received.	<ol style="list-style-type: none"> <li>1. Squelch is closed.</li> <li>2. With the TSU-7: CTCSS is operating.</li> <li>3. DTSS is operating.</li> <li>4. Paging is operating.</li> </ol>	<ol style="list-style-type: none"> <li>1. Turn the SQL control counter-clockwise.</li> <li>2. Press the F key, then the 2/CTCSS key to turn off the CTCSS.</li> <li>3. Press the DTSS key to turn off the DTSS.</li> <li>4. Press the F key, then the DTSS/PAG key to turn off the Paging.</li> </ol>
No control works.	<ol style="list-style-type: none"> <li>1. LOCK is ON.</li> <li>2. T.ALT is ON.</li> </ol>	<ol style="list-style-type: none"> <li>1. Press the F key, then the ENT/LOCK key to turn off the LOCK.</li> <li>2. Press the F key, then the 3/T.ALT key.</li> </ol>
Memory channel cannot be recalled.	Nothing is stored in the memory channel.	See section 4-4-5 : Memory Entry
Memory cannot be backed up.	<ol style="list-style-type: none"> <li>1. Battery voltage is low.</li> <li>2. Battery case removed.</li> </ol>	<ol style="list-style-type: none"> <li>1. Recharge the battery.</li> <li>2. Install the Battery case.</li> </ol>

## 7. ACCESSORIES

SPEAKER  
MICROPHONE  
SMC-31



HEADSET with  
VOX/PTT  
HMC-2



CTCSS UNIT  
TSU-7

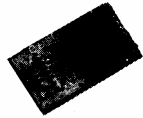

BATTERY CASE  
AA×6  
BT-8



NiCd BATTERY PACK  
7.2V 700mAh  
PB-13



NiCd BATTERY PACK  
12V 300mAh  
PB-14



SPEAKER  
MICROPHONE  
SMC-32



REMOTE CONTROL  
SPEAKER MICROPHONE  
SMC-33



WALL CHARGER  
BC-14



RAPID CHARGER  
Recharging Approx. 1 hour  
BC-15



WATER  
RESISTANT BAG  
WR-2



SOFTCASE  
SC-30  
for PB-13  
BT-8



SOFT CASE  
SC-32  
for PB-14



SWIVEL MOUNT  
BH-6



FILTERED CIGARETTE  
LIGHTER CODE  
PG-3F



PLUG CODE  
PG-2W



NOTE: Some optional accessories may not be available in your area.



• Installing the CTCSS unit (TSU-7)

1. Slide the release button to unlock, then pull out the battery case.
2. Unscrew the four screws on the rear (Fig. 1). The screw near the antenna connector is a short one.
3. Pull part A shown in Figure 2 with your thumb, put your finger into the battery case, and release the claw of the rear case.
4. Position the set with its front facing forward.
5. Open the front panel from the PTT switch side, being careful of the internal wiring. The PC board mounted on the front panel projects into the top panel by about 3 mm. Pull the front panel down to open it (Fig. 3).

6. Attach the pad supplied with the TSU-7 to the rear of the unit (the side with no connectors).
7. Remove the resistor using a pair of nippers, Plug the connector into the TSU-7, and attach the TSU-7 to the transceiver, as shown in fig.4, fig.5.
8. Replace the case in its original position, taking care not to catch the cord under the case.
9. Install the four screws.
10. Insert the battery case.

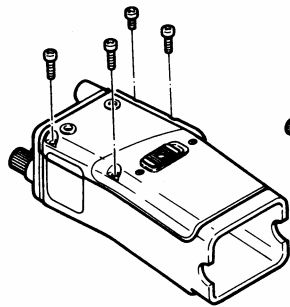

Fig. 1

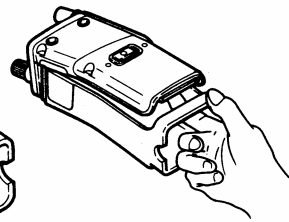

Fig. 2

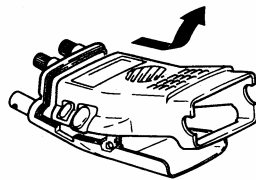

Fig. 3

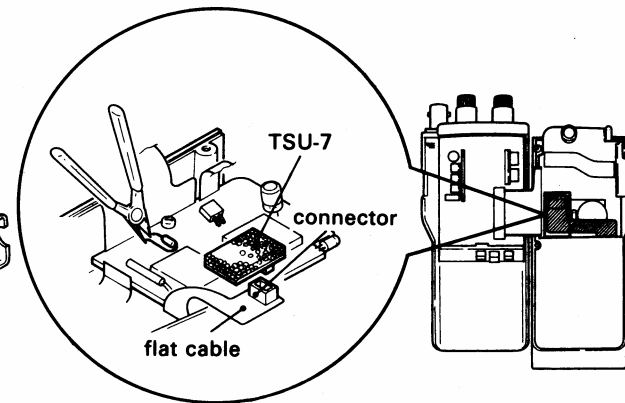

Fig. 4

Fig. 5

- Operation with Remote Control Speaker Microphone SMC-33

**Notes**

1. UP/DOWN will increment continuously if pressed for longer than 1 second.
2. The microphone switch is operational even when the F.LOCK switch on the main unit is turned ON.
3. Be sure to turn the POWER switch OFF when you plug in or remove the microphone.

Keys 1, 2, and 3 on the SMC-33 are initially assigned to memory channels 1, 2, and 3, respectively. The functions of the keys on the transceiver can be set as follows:

1. Hold down microphone key 1 (or 2 or 3) and turn the power on. The programmable function 1 (or 2 or 3) indicator appears for 10 seconds.

1

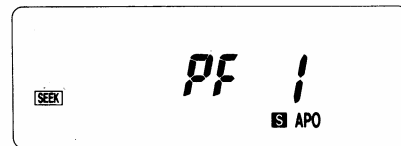

2. When you press a key on the transceiver, the function of that key is assigned to key 1 (or 2 or 3) on the SMC-33.

Example: When you press the CALL key, key 1 on the SMC-33 becomes the CALL key. When you press the F key, then the CALL key, key 1 becomes the CALL SCAN key.

The keys that you can set for keys 1, 2, and 3 on the SMC-33 and their functions are listed on the next page.

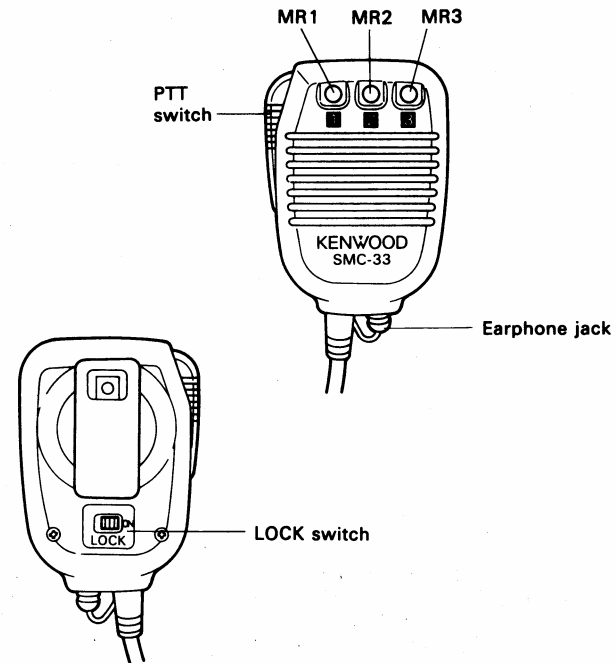

When the LOCK switch is turned ON the MR1, MR2, and MR3 keys on the front of the microphone are disabled.

Press the key below.	Press the F key, then key below.
Tuning control ※ 1	—
LAMP (Turns off 5 seconds after the last key operation)	LAMP (Does not turn off auto matically)
MONI	—
CALL	CALL SCAN
BELL	STEP
DTSS	PAG
LOW	CLOCK
M	TX.STOP
ENT	LOCK
SCAN	VM SCAN
REV	SHIFT
MHz	—

※1. Clockwise rotation sets the UP function, counterclockwise rotation sets the DWON function.

Press the key below. ※2	Press the F key, then key below.
1	AL
2	CTCSS
3	TONE
4	PROG 1
5	PROG 2
6	MEMO
7	SEEK
8	CAR
9	TIME
0	L.OUT

※2. Memory channel recall by microphone key is limited to 1-digit recall only.

The SMC-33 can be used with models that have no remote function. For these radios make sure that the LOCK switch on the back of the microphone is ON before use.

KENWOOD