



**ALL BAND
COMMUNICATIONS
RECEIVER**

Model R-599D



OPERATING MANUAL

R-599D OPERATING MANUAL



CONTENTS

R-599D SPECIFICATIONS	3
R-599D FEATURES	5
SECTION 1. CIRCUIT DESCRIPTION	6
SECTION 2. OPERATING CONTROLS	11
SECTION 3. OPERATING INSTRUCTIONS	15
SECTION 4. ACCESSORY CIRCUITRY	20
SECTION 5. ALIGNMENT	21
SECTION 6. MAINTENANCE	23
TOP VIEW OF THE R-599D	24
BOTTOM VIEW OF THE R-599D	25
R-599D SCHEMATIC DIAGRAM	27

R-599D SPECIFICATIONS

RECEIVING FREQUENCY RANGE	1.8 MHz BAND	1.80 ~ 2.30 MHz
	3.5 MHz BAND	3.50 ~ 4.00 MHz
	7.0 MHz BAND	7.00 ~ 7.50 MHz
	14.0 MHz BAND	14.00 ~ 14.50 MHz
	21.0 MHz BAND	21.00 ~ 21.50 MHz
	28.0 MHz BAND	28.00 ~ 28.50 MHz
	28.5 MHz BAND	28.50 ~ 29.10 MHz
	29.1 MHz BAND	29.10 ~ 29.70 MHz
	50.0 MHz BAND	50.0 ~ 53.4 MHz (with accessory converter)
	144.0 MHz BAND	144.0 ~ 147.4 MHz (with accessory converter)
MODE	SSB, CW, AM and FM	WWV 10.00 MHz
POWER REQUIREMENTS	100/117/220/240VAC, 50/60 Hz, 12 ~ 15VDC	
POWER CONSUMPTION	Less than 15 watts (AC) Less than 1A (at 13.8VDC)	
AUDIO OUTPUT IMPEDANCE	4 to 16 ohms (speaker or headphones)	
AUDIO OUTPUT	More than one watt (with less than 10% distortion) into an 8 ohm load	
ANTENNA INPUT IMPEDANCE	50 to 75 ohms (Unbalanced)	
FREQUENCY STABILITY	Within 100 Hz during any 30 minute period after warmup. Within ± 2 kHz during the first hour after 1 minute of warmup.	
IMAGE RATIO	Better than 50db	
IF REJECTION	Better than 50db	
SENSITIVITY	SSB -	
	1.8 ~ 28 MHz BAND	0.25 μ V S+N/N 10db or more
	50 MHz BAND	0.5 μ V S+N/N 10db or more (with accessory converter)
	144 MHz BAND	0.5 μ V S+N/N 10db or more (with accessory converter)
	WWV	0.25 μ V S+N/N 10db or more
	AM -	
	1.8 ~ 28 MHz BAND	1.5 μ V S+N/N 10db or more
	50 MHz BAND	3.0 μ V S+N/N 10db or more (with accessory converter)
	144 MHz BAND	3.0 μ V S+N/N 10db or more (with accessory converter)
	WWV	1.5 μ V S+N/N 10db or more
SELECTIVITY	SSB :	Better than 2.4 kHz (6db down)
		Better than 4.4 kHz (60db down)
	CW :	Better than 500 Hz (6db down)
		Better than 1.5 kHz (60db down)
	AM :	Better than 5 kHz (6db down)
		Better than 12 kHz (60db down)
FM :	Better than 20 kHz (6db down)	
	Better than 120 kHz (40db down)	

SEMICONDUCTOR COMPLEMENT

8 FET, 1IC, 32 transistors, 51 diodes, 2 zener diodes and
1 variable capacity diode

DIMENSIONS

10-1/8" W x 5-1/2" H x 12-7/32" D (inches)
270 W x 140 H x 310 D (mm)

WEIGHT

12.5 lbs. (5.7 kg)

R-599D FEATURES

1. All solid state circuits insure high quality reception of the amateur bands allocated over a frequency range from 1.8 to 29.7 MHz, and WWV's standard signal.
2. Field Effect Transistor (FET) used as RF amplifier and mixer – a S/N, cross modulation and image characteristics better than vacuum tube receivers characteristics.
3. IC employed as IF amplifier provides high stability and gain.
4. VFO employing FET provides a highly-stable, low noise-factor output.
5. Precision type double gear mechanism and variable capacitor with linear characteristic provided for main tuning dial covering a 100 kHz band with its one complete turn – a receiving frequency readable to the nearest 1 kHz.
6. Fixed channel oscillators self-contained for 5 channels-spot reception available for 5 specific frequencies without using VFO.
7. Amplifier type AGC circuit with time-constant selector switch – distortionless reception of a high input signal, which is specifically useful for SSB signal.
8. A 25 kHz crystal controlled calibrator circuits incorporated – precise frequency calibration available for every 1/4 turn of main tuning dial as well as for use of this set as a frequency measuring set during QSO.
9. Receiver incremental tuning (RIT) circuit incorporated provides means for fine adjustment of receiving frequency or correction of a tuned frequency without manipulation of main tuning dial during a combined transmitter-receiver operation, as practised using a mated transmitter.
10. Ring, linear and ratio detectors equipped for SSB, AM and FM signal receptions respectively.
11. Crystal and LC filters serving as IF filters for SSB and FM receptions respectively and crystal filters for AM and CW reception, are easily selected as desired by means of a SELECTIVITY switch using electron switch. Depending on the condition of radio interference, the SELECTIVITY switch can be placed in the AUTO position to be interlocked with the MODE switch.
12. Beat frequency oscillator (BFO) operated under control of crystals for both SSB and CW receptions with an electronic switch provided for selection of an appropriate crystal.
13. Built-in high performance solid-state noise blanker. The noise blanker is especially useful and effective for impulse type noise, resulting clear QSO.
14. Output transformerless (OTL) type audio frequency circuit adopted – high power output with low distortion factor available.
15. High stable regulated power supply, using zener diodes, applies power to major circuits.
16. Operable from an AC 100, 117, 220 or 240 V source as well as a DC 12 V source, as selected by means of a voltage selector switch.
17. A combined transmitter-receiver operation available when operated in conjunction with model T-599D Transmitter, a combination transmitter for model R-599D Receiver.
18. An extremely high-degree transmitter-receiver operation, or the so-called cross-operated VFO, is practicable when a combination of model R-599D Receiver and model T-599D Transmitter are operated with their VFOs placed under control of the mated sets.
19. Design of model R-599D' panels and dial, matched best to the human engineering, insures a well matched combination with the transmitter model T-599D, enabling users to compose a far pleasant shack.

SECTION 1. CIRCUIT DESCRIPTION

The block diagram of model R-599D Receiver is as shown in Fig. 1. This receiver generally operates on the double superheterodyne system, in which the receiving signals ranging from 1.8 to 29.7 MHz and the WWV's 10 MHz standard signal are converted by the 1st mixer into the 1st IF signals ranging from 8.895 to 8.295 MHz, which are further converted by the 2nd mixer into the 2nd IF signal of 3.395 MHz.

1. RF Unit (X44-0020-00)

The signal entered from the antenna passes through the protective diodes to the ANT coil of this RF unit selected in accordance with the frequency band to which the signal belongs. The ANT coils are provided independently for all receiving bands to insure the supreme performance of the receiver set.

The signal passing through the ANT coil is applied to RF amplifier Q1 comprising field effect transistor (FET) 3SK-22, where it is amplified enough.

An FET, featuring a better cross modulation characteristic

and a high output impedance compared with ordinary transistors, enables the RF coil inserted succeeding to the RF amplifier to provide a higher Q.

The AGC circuit operates in such a manner that the source is normally biased to 4V by a zener diode whereas gates 1 and 2 receive 4V in the absence of signals. And this gate voltage is lowered with the magnitude of incoming signals. In this case, FET used as RF amplifier Q1 provides a better AGC characteristic as compared with ordinary transistors. The RF coils, similar to the ANT coils, are provided independently for all receiving bands and mounted as a coil pack on a printed circuit board.

The amplified RF signal output ranging from 1.8 to 29.7 MHz is applied to gate 1 of 1st mixer Q2, to which the 1st local oscillator voltage is injected through gate 2. Thus, 1st mixer Q2 comprising FET 3SK22 heterodynes its input signal with 1st local oscillator output to deliver the 1st IF signal ranging from 8.895 to 8.295 MHz.

1st local oscillator Q3 is an overtone oscillator employing FET 2SK19, to which a voltage of 9 V is supplied as the B voltage from the regulated power supply.

The oscillation coils and crystals provided for 1st local oscillator Q3 are incorporated in a coil pack.

The output signal of 1st local oscillator Q3 is taken out from the collector of oscillator transistor and applied to

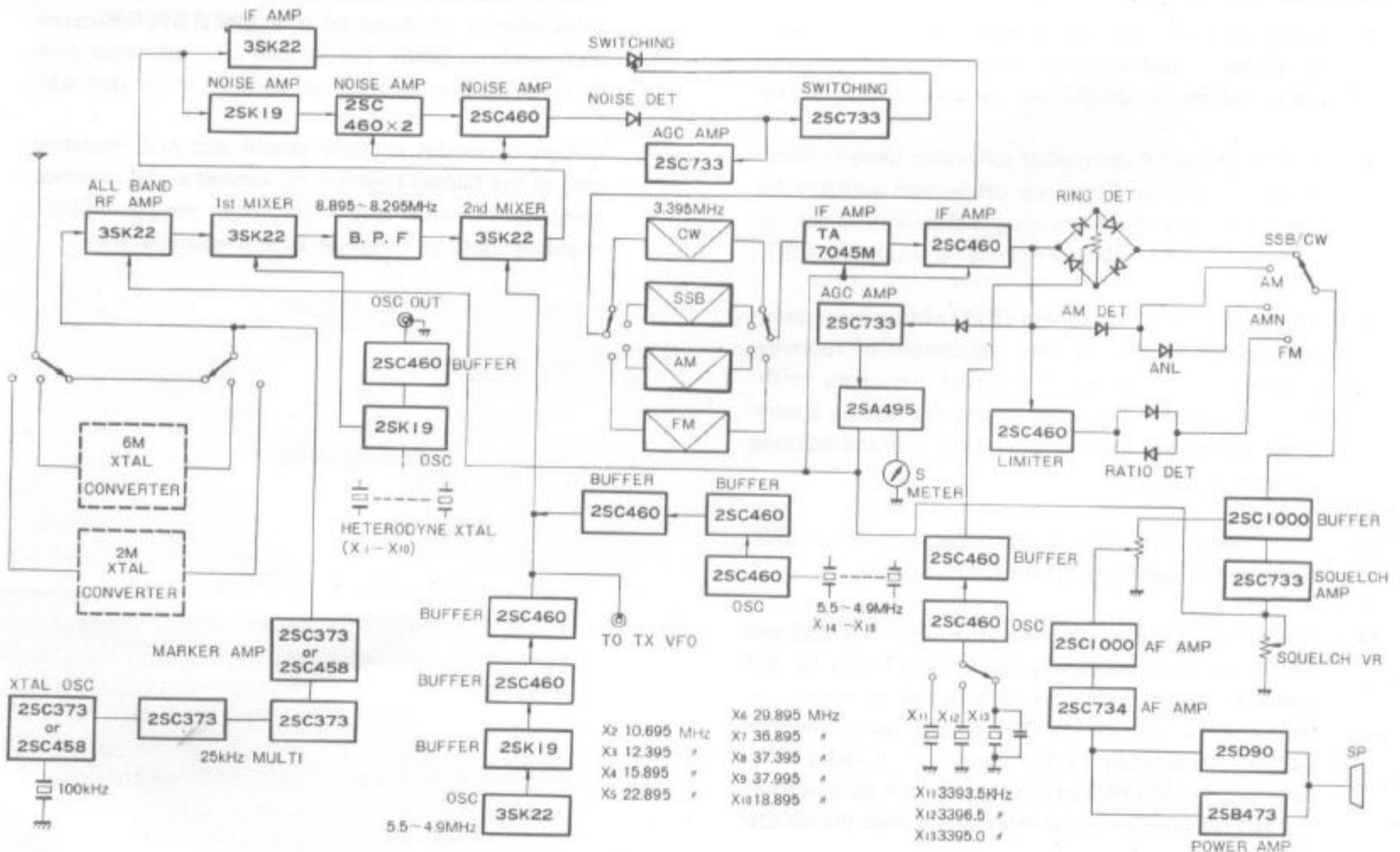

Fig 1 R-599D Block Diagram

1st mixer Q2. Part of the output is fed through buffer Q4 comprising type 2SC460 transistor to the remote terminal.

Buffer Q4 lowers the impedance of its input signal in order to have the output signal sent from the remote terminal to the transmitter operating under a combined transmitter-receiver basis serve as the 2nd mixer signal.

2. IF Unit (X48-0011-00)

The 1st IF signal delivered from 1st mixer Q2 in the RF unit is fed to band pass filter B.P.F. in this IF unit, where the unwanted frequency component of the input signal is rejected. The B.P.F. has a pass band of 600 kHz from 8.895 to 8.295 MHz.

The 1st IF signal is then applied to 2nd mixer Q1 consisting of an FET 3SK22, where it is heterodyned with the output signal of variable frequency oscillator (VFO) to turn into the 2nd IF signal. This 2nd IF signal is fed to NB unit (X54-1080-10) which eliminates pulsating noise from the signal if the noise blanker is turned on. The 2nd IF signal is then conducted to the filter unit and, at the output of the filter, is returned to the IF unit where it is applied to integrated circuit IF amplifier Q2 (TA7045M), then to transistor Q3 (2SC460) for amplification.

The output signal of 2nd IF amplifier Q3 is fed to three types of detector circuit: a ring detector comprising diodes D4 ~ D7, an AM detector consisting of capacitor C14 (33 pF) and diode D3 (1N60) and a ratio detector comprising a discriminator transformer connected succeeding to limiter Q8 (2SC460). Thus, the ring detector detects the SSB and CW signals applied as its input signals into an AF signal. The AM detector detects the AM signal applied as its input signal into another AF signal. While, the ratio detector detects the FM signal delivered from limiter Q8 (2SC460) into the third AF signal.

Part of 2nd IF amplifier Q3 is also applied via capacitor C13 to an AGC detector circuit consisting of diode D1 (1N60). The detected output from diode D1 is fed to an AGC amplifier Q4 (2SC733), where it is amplified and applied to transistor Q5 (2SA495) serving as both an emitter follower and a current amplifier for driving S meter. Thus, transistor Q5 delivers two outputs: One output, which is taken out from the emitter side for the AGC, is fed to 1st amplifier IC Q2 and 2nd amplifier Q3 and, via resistor R22 (10 K Ω), to RF amplifier Q1 in the RF unit. Part of the above output is also fed via resistor R23 (180 K Ω) to squelch amplifier Q6. While, the other output, taken out from the collector side, is directly supplied to the S meter, thereby deflecting the meter depending on the AGC voltage detected.

The time constant of the above mentioned AGC circuit is determined by time constant capacitor C1 inserted succeeding to AGC amplifier Q4 but outside the IF unit.

The rise-up of the AGC circuit depends on the collector-emitter resistance of AGC amplifier Q4 when amplifier transistor Q4 conducts and the operation of the above-mentioned time constant capacitor C1.

When the AGC circuit is started by the output of 2nd IF amplifier Q3, AGC amplifier Q4 offers a low impedance against time constant capacitor C1 because of its current amplification characteristic and, therefore, conducts at once owing to the time constant capacitor C1 discharged momentarily.

When the output of 2nd IF amplifier is cut off, on the contrary, AGC amplifier Q4 increases its impedance against time constant capacitor C1, thereby bringing itself to the cut-off condition slowly because of capacitor C1 charged gradually. Thus, it follows that AGC amplifier Q4 provides an ideal quick-start slow-release characteristic for its operation. (Note that the above-mentioned AGC operation applies to the case where the FUNCTION switch is placed in the (AGC) FAST position for the quick AGC operation. For the (AGC) SLOW position of FUNCTION switch AGC amplifier Q4 provides an AGC characteristic just opposite to the above characteristic because of the discharge and charge of time constant capacitor C1 conducted reversely.) By the way, the output of AGC transistor Q5 applied via resistor R23 to squelch amplifier Q6 (2SC733) is amplified there and then applied to the base of buffer transistor Q7 (2SC1000), thereby controlling the base voltage with the input signal. As a result, buffer transistor Q7 controls AF amplifier Q1 in the AF unit with its output to perform a squelch operation under control of the input signal.

Buffer transistor Q7, mentioned above, also acts as an emitter follower providing a higher impedance to the detected SSB, CW, AM or FM signal and lower output impedance to the AF volume control outside the IF unit, as selected by the MODE switch.

3. NB Unit (X54-1080-10)

Signal from the 2nd mixer passes a bandpass filter consisting of T1, T2, and T3 to G2 of Q1 (3SK22) and G1 of Q2 (2SK19). Q1 compensates for the loss in the NB unit so that the overall gain of the NB unit is approximately 0dB. Q2, Q3 and Q7 and transistor Q4 (2SC460) form a noise amplifier, whose output is rectified by diodes D5 and D6 (1N60) before fed to the base of switching transistor Q5 (2SC733). Part of this rectified output is also fed to the base of Q6 (2SC733) from the base of Q5 through a 10 k ohm resistor (R17) and the amplified signal is applied to transistor Q3, Q7 and Q4 as AGC voltage. The AGC circuit has such a time constant that it does not

respond to pulsating noises but to short duration, continuous signals like SSB.

Therefore, the noise blanker amplifier Q3, Q7 and Q4 is allowed to have a maximum gain or nearly a maximum on pulsating noises whereas it offers an extremely reduced gain on continuous signals. This selectivity gives transistors Q2, Q3, Q7 and Q4 performance of a noise amplifier. The emitter of Q5 is connected to the NB switch through D7 (MV13). The NB switch is turned on or off by pulling out or pushing in the AF GAIN knob on the panel. The NBS is grounded in the ON position.

When transistor Q5 is driven to conduct by noise signals, its collector voltage suddenly drops and a balanced type diode switch D1 thru D4 (1S1587) connected to the collector is biased in the reverse polarity for the period determined by C7 and R3 to close the signal line.

Thus, pulsating noises are eliminated to ensure the ham operator a noise-free, comfortable QSO when he turns the NB switch on in the presence of pulsating noises.

4. Filter Unit (X51-1050-10)

This unit incorporates four filters with diode switches provided for the SSB, CW, AM and FM signals respectively. These filters are so designed that an appropriate filter is selected by means of a diode switch when the MODE switch is placed in the position for a desired receiving signal. Now, suppose that the MODE switch is placed in the CW position for reception of the CW signal. This applies a voltage of 13.8 V to the CW terminal for the diode switch of filter XF-1. This causes a current to flow from the terminal through resistor R1 (220 Ω) in the two directions to resistors R2 (4.7 k Ω) and R3 (220 Ω). Thus, the current passing resistor R2 flows as the forward current through diode D1 (1S1587) and resistor R21 (2.2 k Ω) to the earth. While, the current passing resistor R3 flows as the forward current through resistor R4 (4.7 k Ω), diode D2 (1S1587) and resistor R22 (2.2 k Ω) to the earth. Under the above condition a positive voltage of approx. 2.3 V is built up across resistors R21 and R22 to the earth. This applies a backward voltage to diodes D3 through D14 (1S1587). As a result, diodes D1 and D2 turns ON and diodes D3 through D14 turns OFF, thereby allowing only the CW signal to pass through filter XF-1 from NB Unit to 2nd IF amplifier Q2. The ratio of the signals under the above ON and OFF conditions of the diodes is approx. 110 dB.

The XF-1 filter requires an external resistance of 4.7 k Ω and an external capacitance of 33 pF. Hence, the filter is so designed that it employs the DC resistors for diode switch as the external resistance of 4.7 k Ω and the internal capacitances of the printed circuit board and coils L1 and

L2 (1 mH), the capacitance of lead wires and other stray capacitance as the external capacitance of 33 pF.

Other filters for the SSB, AM and FM signals XF-2, XF-3 and an LC circuit are selected by their diode switches just in the same manner. There are however two switching diodes (1S1587) used for SSB, AM and FM modes respectively for improved switching characteristic.

5. VFO Unit (X40-0016-08)

The VFO Unit incorporates a variable frequency oscillator circuit, which delivers the output frequencies varied over a frequency range of 600 kHz from 5.5 to 4.9 MHz to the 2nd mixer in order to convert the 1st IF signals ranging from 8.895 to 8.295 MHz into the 2nd IF signal of 3.395 MHz.

The variable frequency oscillator consists of oscillator Q1 (3SK22) arranged as a modified Clapp oscillator circuit and operate quite stably with buffer Q2 (2SK19). The output of variable frequency oscillator is delivered through buffer Q2 and one stage of harmonic filter to the output circuit, a Darlington circuit comprising amplifier Q3 and Q4.

Hence, the output circuit operates stably against the variation of its load.

The VFO Unit also incorporates a receive incremental tuning (RIT) circuit.

The RIT circuit is operated from the RIT voltage generated in its generator circuit, which is incorporated in the X43-0010-00 Unit and actuated by a receiver relay during the reception under the combined transmitter-receiver operation, and varies the VFO frequency regardless of the setting of the dial.

The RIT control on the front panel provides means for controlling the above-mentioned RIT voltage.

Note that the VFO Unit should never be removed from its case or modified internally since its adjustment needs a high degree of adjustment technique.

6. Carrier (BFO) Unit (X50-0002-00)

The carrier unit incorporates a beat frequency oscillator (BFO) circuit.

The BFO circuit, consisting mainly of oscillator transistor Q1 (2SC460), buffer transistor Q2 (2SC460) and crystals X-1, X-2 and X-3 with a diode switch consisting of diodes D1 through D4 (1S1555), inserts a beat or carrier frequency in the ring detector for reception of the SSB or CW signal. Oscillator transistor Q1 is the Pierce B-E circuit and its output frequencies are adjusted by means of trimmer capacitors TC1 through TC3 inserted in parallel with crystal X1 through X3 respectively.

Selection of a crystal for the BFO in reception of the CW, LSB or USB signal is performed by the above-mentioned diode switch as follows:

Suppose, for example, that the MODE switch is placed in the LSB position for reception of a LSB signal. This applies a power supply voltage of 13.8 V to the LSB terminal of the Carrier (BFO) Unit.

As a result, a forward voltage is applied from the LSB terminal through resistor R4 (10 k Ω) and choke coil L4 (1 mH) to diode D4 (1S1555), thereby conducting the diode since the diode offers a low internal resistance because of the voltage applied.

This inserts crystal X3 connected in series with the diode via capacitor C6 (22pF) across the base and emitter of oscillator transistor Q1. Hence, oscillator transistor Q1 starts in oscillation at the X3 crystal frequency.

The beat frequency oscillator operates just in the same manner as mentioned above for reception of the USB or CW signal.

But, its center frequency 3.395 MHz is shifted by 700 to 800 Hz for reception of the CW signal because the center frequency zero beats with the output signal of 2nd IF amplifier in this case owing to the fact that the output signal is continuous wave and this makes it difficult to receive the incoming frequency.

The above-mentioned shift of the VFO frequency is accomplished by the diode switch as follows:

When the MODE switch is placed in the CW position, a DC voltage is applied from the CWR terminal of this carrier unit via resistor R1 (10 k Ω) and choke coil L1 (1 mH) to diode D1, turning the diode ON. This grounds crystal X1 through the diode without any capacitor and, therefore, insert the crystal directly across the base and emitter of oscillator transistor Q1. As a result, oscillator transistor Q1 starts in oscillation at a frequency a little lower than the crystal frequency. The beat tone for the CW reception may be adjusted through the use of trimmer capacitor TC1, which provides means for varying the BFO frequency by ± 200 Hz.

The output of BFO oscillator transistor Q1 is applied via a voltage divider circuit comprising capacitor C11 (10pF) and C13 (22pF) to buffer transistor Q2. Buffer transistor Q2, acting as an emitter follower, offers an output impedance as low as about 100 Ω , thereby minimizing variation of the output voltage and frequency.

7. 25 kHz Marker Unit (X52-0005-01)

The 25 kHz marker unit incorporates a marker signal generator circuit which generates a marker signal over a frequency range from 3.5 to 28 MHz at intervals of 25 kHz for calibration of the main tuning dial. Selection of a 25

kHz marker signal may be accomplished by means of the FUNCTION switch.

The marker signal generator circuit consists mainly of four transistors Q1 through Q4 (2SC373) and one 100 kHz crystal (HC/13U).

Transistor Q1, acting as an oscillator, oscillates with the 100 kHz crystal at a frequency of 100 kHz. Trimmer capacitor TC1 inserted in the collector circuit of oscillator transistor Q1 provides means for fine adjustment of the oscillator frequency.

The output of oscillator transistor Q1 is fed via capacitor C4 (33pF) to diode D1, through which it is shaped into a pulsed waveform occurring at a period of one fourth the 100 kHz and drive a free-running multivibrator consisting of transistors Q2 and Q3 at a period of just 25 kHz since the multivibrator has a free-running period of about 25 kHz.

The output of the multivibrator is applied to amplifier transistor Q4, through which it is shaped in the rectangular waveform and delivered to ANT COIL in the RF Unit.

8. Regulated Power Supply Unit (X43-0010-00)

The regulated power supply unit provides necessary operating voltages for the VFO, BFO and 1st local oscillator. Especially, it supplies a voltage with least variation to the VFO (including the RIT circuit) to prevent the VFO from changing its oscillator frequency with variation of the supply voltage.

The unit consists mainly of four transistors Q1 (2SA606), Q2 ~4 (2SC372), and reference diode D1 (WZ-061).

Transistor Q1 is the current control transistor, which controls the input current in accordance with an error voltage. Transistors Q2 and Q3 are the error voltage amplifier transistors. Transistor Q4 is the error voltage detector transistor and also serves as the temperature-characteristic canceling transistor for transistor Q3. Diode D1 is the zener diode for producing a reference voltage.

The error voltage detected by error voltage detector Q4 is amplified through two amplifier stages of transistors Q2 and Q3. This allows the regulated power supply unit to provide an extremely excellent voltage stability.

The voltage stability due to a temperature change depends on the temperature characteristics of the reference voltage diode and the error voltage amplifier circuit.

The reference voltage diode is used zener diode (WZ-061), which has a temperature coefficient of 0.

While, the error voltage amplifier circuit consists of amplifier transistors Q3 and Q4 coupled in differential connection and offers least variation of its characteristic due to temperature change because transistors Q3 and Q4

cancel their temperature characteristics.

Further, current control transistor Q1 suffers from almost no change of its characteristic due to temperature change because it is a silicon PNP transistor.

In addition, this regulated power supply unit is so arranged that it protects current control transistor Q1 against an excessive current which might be flowed through the transistor when the output terminal is shorted to earth, as encountered in ordinary regulated power supply circuits.

Resistors R10 and R11 and variable resistor VR2 are provided to produce necessary RIT voltages to be fed to the RIT circuit in the VFO unit.

9. AF Unit (X49-1040-10)

The AF unit incorporates an AF amplifier circuit to operate the speaker. This amplifier circuit amplifies the AF output delivered via variable resistor VR4 (10 k Ω), or the AF volume control, from squelch buffer transistor, which is connected through the MODE switch and detector circuits to 2nd IF amplifier transistor.

The AF amplifier circuit, consisting mainly of four amplifier transistor Q1 (2SC1000), Q2 (2SC734), Q3 (2SD90) and Q4 (2SB473), operates as follows:

The AF signal from squelch buffer transistor is conducted from the IN terminal of the unit via capacitor C1 to amplifier transistor Q1, where the signals is amplified on the voltage amplification basis. The output of amplifier transistor Q1 is amplified by amplifier transistor Q2 on both the voltage and power amplification bases. The output signal from amplifier transistor Q2 is applied to a power amplifier consisting of transistors Q3 and Q4, where it is amplified on the power amplification basis. Since transistors Q3 and Q4 are coupled through a complementary connection circuit to the preceding circuit, they form an output transformerless (OTL) circuit and, therefore, deliver the output signal with extremely small distortion compared with that of the conventional power transformer coupled to the preceding stage. A negative voltage is fed back from the joint of transistors Q3 and Q4 via resistor R12 (10 k Ω) to the input side of transistor Q2, thereby not only reducing the distortion of output signal further but lowering the output impedance with the resultant improvement of damping factor. In addition, a negative DC current is fed back from the collector of transistor Q4 to the emitter of transistor Q2 because of transistors Q2, Q3 and Q4 direct-coupled and this reduces the variation of the voltage at the joint of transistors Q3 and Q4.

Coil L1 (47 mH) forms an LC filter with capacitor C2 (0.047 μ F) and the input capacitance of Q2 to block out audio frequencies above 3 kHz.

The AF unit also features a difference in audio response

between SSB (including AM and FM) reception and CW. It cuts off audio frequencies above 1 kHz in the CW mode to reduce the operator's listening fatigue which would hasten with higher tones.

This tone control is automatically accomplished by setting the MODE switch to the CW mode since the switch grounds the CWG terminal, causes a current to flow through D1 (1S1115) in the path of R7, D1 and R9 and turns the diode on, thus grounding the collector of Q1 via C4 (0.47 μ F) and C5 (10 μ F). In other modes than CW, on the other hand, no current flows through D1 to return the frequency response to the normal state.

Variable resistor VR1 is for adjustment of the side-tone output level in CW transmission.

10. Fixed Channel Unit (X50-1140-10)

The fixed channel unit incorporates oscillator transistor Q1 arranged so as to form a Pierce C-B oscillator circuit and transistor Q2, Q3 acting as a buffer.

Oscillator transistor Q1 operates in conjunction with a fixed channel crystal selected by the CH SELECT switch.

The output of oscillator transistor Q1 is fed through Q2, Q3 to 2nd mixer Q1 (IF Unit), where it is heterodyned with the fixed channel signal under reception.

SECTION 2. OPERATING CONTROLS

FRONT PANEL CONTROLS (See Fig. 2.)

(1) BAND (Main Band Selector Switch)

Main band selector switch BAND, a 10-position rotary switch provides means for selection of a desired receiving band among the 8 bands allocated over a frequency range from 1.8 to 29.1 MHz the WWV's 10 MHz standard signal.

(2) BAND (Auxiliary Band Selector Switch)

Auxiliary band selector switch BAND, a 5-position rotary switch, provides means to select either HF or VHF band as the operating band. When this switch is placed in the HF position, it makes the main band selector switch effective to select any band for reception as mentioned in item (1) above. In other positions, the switch inserts a 50 or 144 MHz crystal converter (option) in the receiver circuit for reception of the 50 or 144 MHz band respectively.

(3) POWER (Power Switch)

The POWER switch provide power ON-OFF control to the receiver. In the ON position, it applies power to the power supply circuit and places the receiver in the running condition.

(4) RIT (Receiver Incremental Tuning Control)

Control RIT provides means for fine adjustment of a receiving frequency when this receiver is operated with model T-599D Transmitter as a combined transmitter-receiver.

If the user want to operate this receiver on the QSO basis, set up the receiver and model T-599D for a combined transmitter-receiver operation.

Then, set the BAND switches and main tuning dial on the receiver for the nominal transmitting frequency of a desired partner station with the RIT switch placed in position O. Tune the receiver to the actual transmitting frequency of the partner station and proceed to the QSO operation. If the receiving frequency shifts during the QSO operation, re-tune the receiver to the current receiving frequency by turning the RIT control to and for instead of manipulating

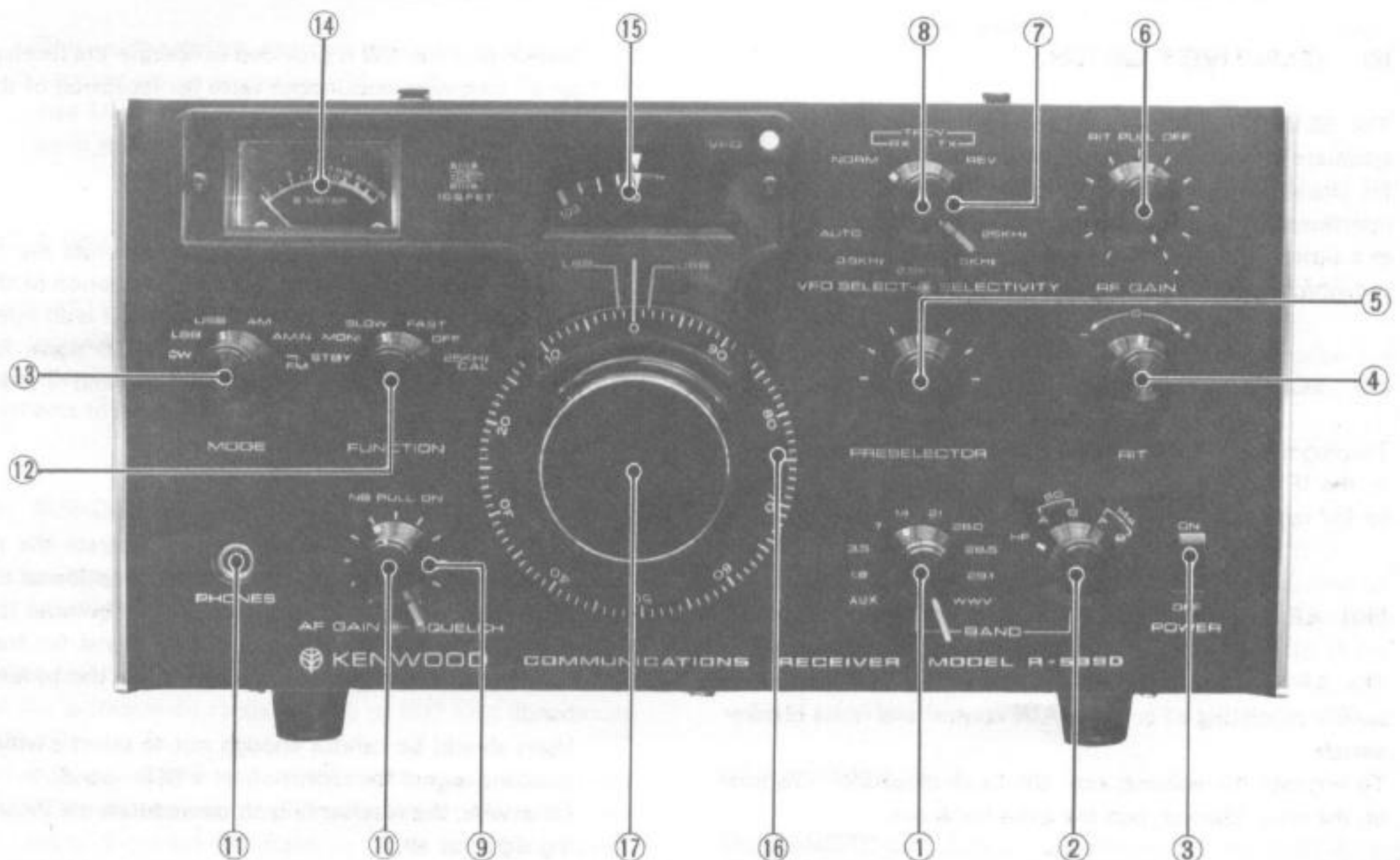

Fig. 2 R-599D Front Panel Controls

the main tuning dial. Otherwise, the transmitting frequency of the local station will be shifted.

(5) PRESELECTOR (RF Amplifier Tuning Control)

The PRESELECTOR switch is the tuning control for the RF amplifier stage of this receiver. This control should be adjusted until the receiver provides the maximum sensitivity.

(6) RF GAIN (RF Gain Control) – RIT PULL OFF

The RF gain control provides means to adjust the RF gain of the receiver. The gain is maximum when the knob is turned fully clockwise. This same switch turns RIT off when pulled out.

(7) VFO SELECT

The VFO SELECT switch provides means to select a desired VFO under the combined transmitter-receiver operation of models R-599D and T-599D. Normally, this switch should be kept in the NORM position.

(8) SELECTIVITY SWITCH

The SELECTIVITY switch provides means to select an adequate IF pass band depending on the type of emission for the signal under reception of the condition of radio interference. In other words, this switch should be placed at a position for which the speaker delivers the sound output which is most easy to hear.

(9) SQUELCH (Squelch Control)

Turning this control clockwise, intensify the squelch control to the IF output until the audio frequency circuit is disabled for regeneration of the incoming signal.

(10) AF GAIN (Volume Control) – NB PULL ON

The AF GAIN – NB PULL ON control is a combined switch consisting of an AF GAIN control and noise blanker switch.

To increase the volume, turn the knob clockwise. To turn on the noise blanker, pull the same knob out.

(11) PHONES (Phone Jack)

The PHONES jack is provided for connection of a headphone plug. This jack is available for a stereo headphone. It does not accept speaker.

(12) FUNCTION (Function Selector Switch)

The FUNCTION switch, a 6-position rotary switch, provides means to place model R-599D under a desired functional condition such as a stand-by operation, monitor, slow and fast responses, AGC off and calibration, as obtained by turning the switch in the STBY, MONI, SLOW, FAST, OFF, and 25 kHz CAL position respectively.

(13) MODE (Receiver Mode Selector Switch)

The MODE switch, a 6-position rotary switch, provides means to select an adequate mode of the receiver operation depending on the type of emission of the signal to be received.

(a) CW (Continuous Wave)

Switch position CW is provided to operate the receiver on an incoming continuous wave for reception of the Morse telegraph codes.

(b) LSB (Lower Side Band)

Switch position LSB is provided to operate the receiver on an incoming LSB signal for reception of the 3.5 and 7.5 MHz bands. This is because it is an international custom to use the LSB of SSB signal for transmission and reception of the 3.5 and 7 MHz bands.

(c) USB (Upper Side Band)

Switch position USB is provided to operate the receiver on an incoming USB signal for reception of the bands above the 14 MHz band. This is because it is a general rule to use the USB of SSB signal for transmission and reception of the bands above the 14 MHz band.

Users should be careful enough not to select a wrong sideband signal for reception of a SSB band.

Otherwise, the receiver fails to demodulate the incoming signal at all.

(d) AM (Amplitude Modulation)

Switch position AM is provided to operate the receiver on an incoming amplitude-modulated signal for reception of the radiotelephone speech.

If the receiver is operated on an incoming SSB signal with the MODE switch placed in this AM position by mistake, the speaker merely numbles out its sound output.

When operating the receiver with the incoming signals belonging to the bands below 7 MHz band, therefore, never fail to turn the MODE switch in the LSB position. For the signals belonging to the 14 MHz band or higher, turn the switch in the USB position.

(e) AM.N (Automatic Noise Suppression)

Switch position AM.N is provided to suppress the annoying pulsed noises due to the atmospheric, motor cars engine and so on appearing in the sound output of speaker during reception of an incoming signal from an AM station.

(f) FM (Frequency Modulation)

This is the switch position provided to operate the receiver on an incoming FM signal with the built-in 144 MHz or 50 MHz crystal converter (option) inserted in the receiver circuit.

(14) S METER

The S METER indicates the level of the signal under reception, as read on its scale in dB.

The scale is so calibrated that the meter reads 34 dB when it deflects to graduation S-9.

(15) SUB-DIAL SCALE

The sub-dial scale is the disc scale mounted below a rectangular small window at the upper center section of front panel.

The scale is calibrated around the circumference of the disc for a frequency range from 0 to 600 kHz at intervals of 25 kHz.

This scale, being mounted on the shaft of the main tuning dial, shifts its position by one graduation for every one 1/4 turn of the main dial scale, or a frequency band covering 25 kHz.

(16) MAIN DIAL SCALE (VFO)

One graduation covers 1 kHz for 100 kHz of one complete revolution.

The main dial scale receives the rotation of the main tuning dial, explained next, through an angular displacement reduction gear train.

Because of a constructional feature, this scale may be calibrated quite easily by shifting its zero graduation to a point for which the receiver zero-beats with the calibration signal while depressing the spring-clutched scale plate and turning it against the main tuning dial.

(17) MAIN TUNING DIAL

This dial provides means to tune the receiver circuit to a desired band signal within a band width of 600 kHz. One complete revolution (100 kHz) of the main dial scale is expanded to approximately four turns of this knob so that even SSB signals can be tuned to quite easily.

Note that this dial is stopped at a point when rotated outside the 0 to 600 kHz range of the sub-dial. Do not try to rotate the dial beyond the above point. Otherwise, the reduction gear mechanism for the dial may be damaged.

REAR PANEL CONTROLS AND TERMINALS

(See Fig. 3.)

(1) HF ANT

This is the antenna terminals provided for exclusive use with HF antenna having an impedance of 50 to 75 Ω and providing a receiving band from 1.8 to 28 MHz.

(2) SPEAKER

This is the AF output terminals provided for connection of an external speaker. This terminals have an output impedance of 8 Ω , but speakers with voice coil of 4 – 16 Ω are also available.

(3) REMOTE

The REMOTE terminals are the connecting terminals for a transmitter to be operated in combination with this receiver. When this receiver is to be operated with model T-599D transmitter, connect between the REMOTE terminals of

the receiver and transmitter using the cord supplied with the transmitter for the above purpose.

If the transmitter to be operated is the one other than model T-599D, use the cord with plug connector supplied with the receiver to connect between the transmitter and receiver.

(4) DC INPUT TERMINALS

This is the input terminals provided for connection of a DC source to this receiver.

The requirement for the DC source is such that the source should provide an output voltage of 12 to 15 V and a current capacity of 1A.

(5) AC - DC SELECTOR SWITCH

This is a selector switch for selection of an AC or DC source. But, the switch is normally fixed in the AC position. When it is desired to operate the receiver from a DC source, remove the stopper from the switch, turn the switch in the DC position, and fix it in that position by means of

the stopper.

(6) VOLTAGE SELECTOR

This is a plug socket with a built-in 0.5A fuse mounted for connection of an AC input line. The socket is provided with 100, 117, 220 and 240 volts terminals at the output side for selection of an AC 100, 117, 220 or 240 volts source.

(7) AC POWER CORD

This AC power cord connects the receiver to an AC 100, 117, 220 or 240 volts source providing a line frequency of 50 or 60 Hz when plugged in the AC line outlet available.

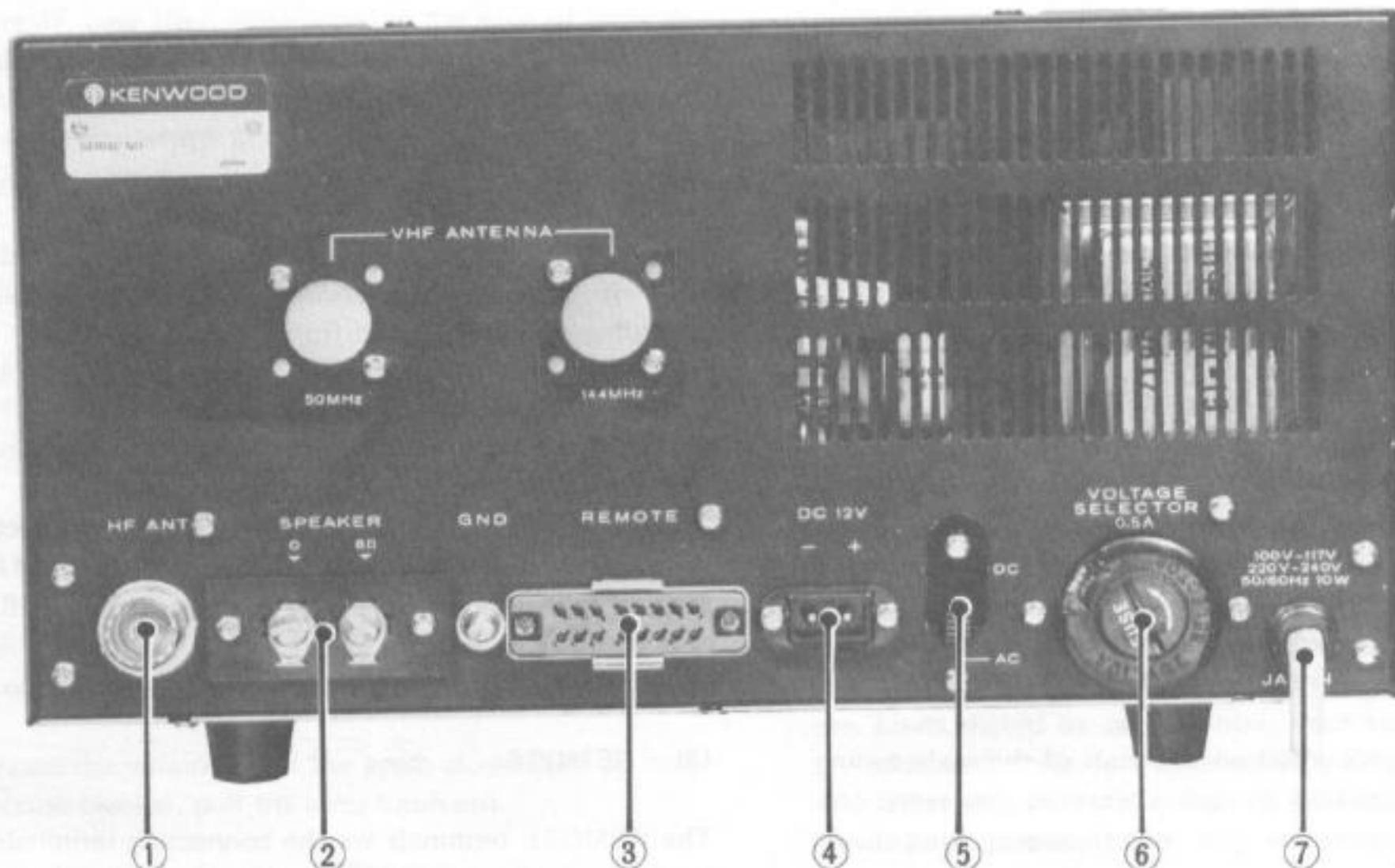

Fig. 3 R-599D Rear Panel Controls

SECTION 3. OPERATING INSTRUCTIONS

1. ACCESSORIES

The model R-599D Receiver is supplied with the accessories listed below.

Users are requested to check the contents of R-599D' container against the list below when unpacking the container.

16-pin connector (plug)	1
2-pin connector (plug)	1
Spare legs	2
Operating manual	1

2. INSTALLATION PLACE

Select a place where dry air and less moisture prevail and further the receiver installed is not exposed to direct sun beams at the installation place. Also, refrain from locating the receiver near an object generating high heat, since the receiver is a product using the transistors throughout its circuit.

3. POWER SOURCE

This receiver is operable from an AC 100, 117, 220 and 240 V, 50 or 60 Hz source, as selected by means of the VOLTAGE SELECTOR plug socket.

If the input voltage suffers from an error of input voltage, for instance an error of more than $\pm 10\%$ to AC 220 V input, insert an appropriate voltage regulator externally between the receiver and the power line to adjust the input voltage to 220 volts.

A fuse having a current carrying capacity of 0.5A is enough for use as the power fuse.

4. ANTENNA

In order to have this receiver fully demonstrate its performance, it is a prerequisite to operate the receiver with an antenna providing better characteristics.

A vertical or inverted-L type antenna may be erected easily as a simple antenna which meets the above requirement. Otherwise, it is recommendable to use a transmitting antenna designed for an amateur radio station commonly as a receiving antenna through provision of a selector switch and this will enable the receiver to receive a high-quality signal.

Use of a dipole or Yagi antenna is also recommendable since such antenna is employed widely among amateur radio stations.

Mind to ground the receiver set without fail to insure a stable reception and prevent dangers such as short-circuiting. Fig. 4 shows an example of the antenna operable with this receiver.

5. SPEAKER

Select high-quality speaker with an input impedance of 4 to 16 ohms for operation with this receiver and it is sure that users can make themselves with the high-quality sounds.

In this connection, use KENWOOD model S-599 speaker to respond the demand of users. This speaker makes a good match with the R-599D receiver in both design and performance.

6. RECEIVING PROCEDURE

First set up the model R-599D for operation by connecting the power line, the antenna and the speaker to their associated terminals. Then, set the front panel controls to the positions as shown below. Also, refer to paragraph given

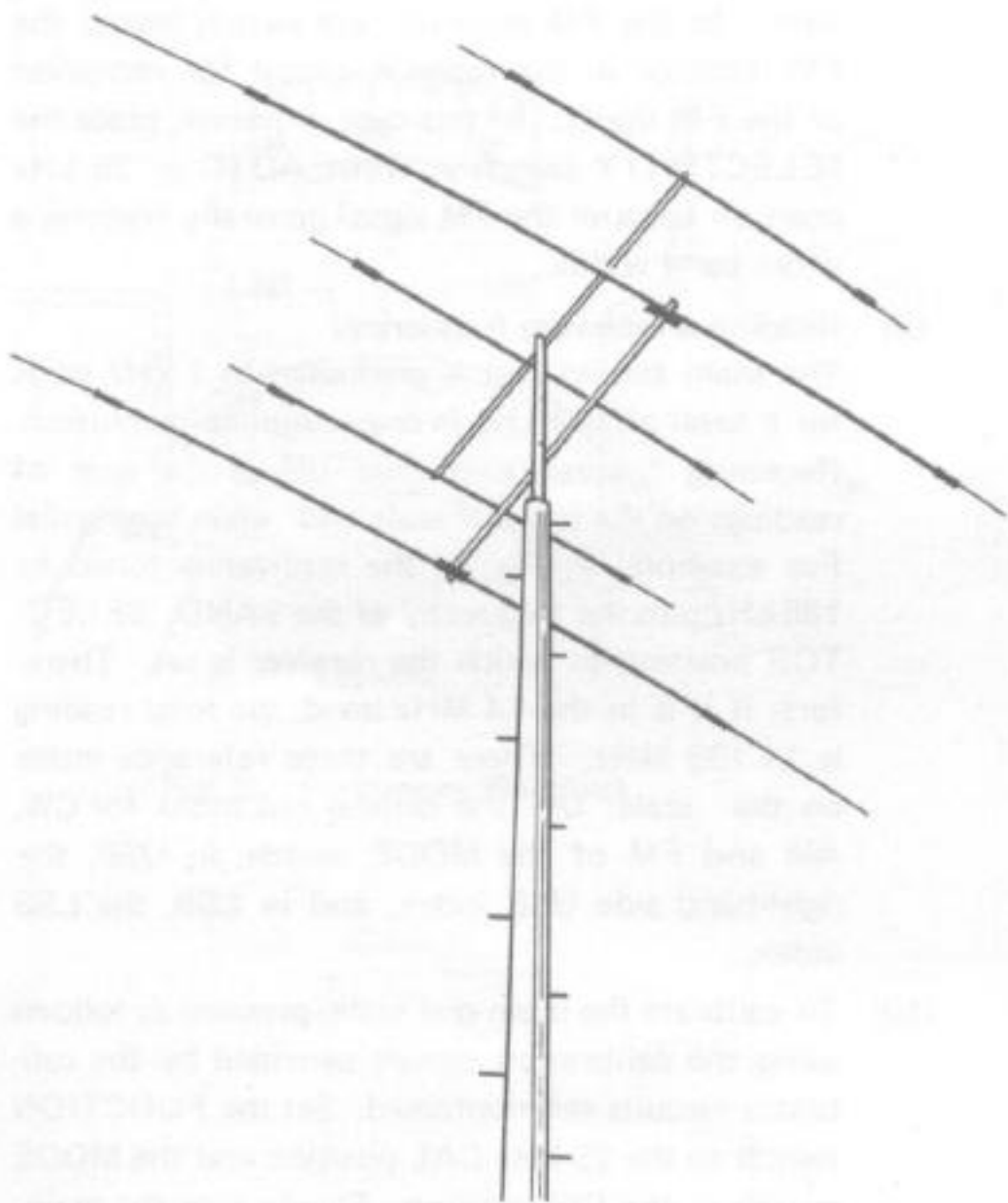

Fig. 4 One of Antennas

under the titles "Front Panel Controls" and "Rear Panel Controls".

POWER: OFF
BAND: A desired band and HF
RF GAIN: Fully clockwise (Also, set the knob to RIT ON position by pressing it in.)
AF GAIN: Centered (12 o'clock position)
(Also, set this knob to NB OFF position by pressing it in.)
MODE: A desired mode of receiver operation
FUNCTION: FAST
PRESELECTOR: Centered (12 o'clock position)
RIT: "0"
VFO SELECT: "NORM"
SELECTIVITY: "AUTO"
SQUELCH: Fully counterclockwise

Rear Panel

AC-DC selector "AC"

When the model R-599D is to be operated in combination with a transmitter, never fail to connect between the receiver and transmitter by inserting the connecting cord with 16-pin connector supplied with the receiver in their REMOTE terminals.

When all above-mentioned steps are completed, turn the POWER switch to ON. This lights all pilot lamps, which illuminate the dial surfaces and meter darkened higher to until they are loomed clearly on the front panel. Here, carry out the following steps:

- (1) Slowly turn the main tuning dial until the receiver is tuned to the desired signal.
- (2) Adjust the PRESELECTOR control until the receiver provides the maximum gain.
- (3) Set the AF GAIN control at a position for which the speaker gives a sound output at an adequate volume.
- (4) Place the FUNCTION switch in either SLOW or FAST position depending on the level fluctuation of the signal under reception.
- (5) Normally keep the RF GAIN control in the fully clockwise position, although it may be reduced as required if the signal is so strong that the RF section or S-meter is saturated.
- (6) Turn the SQUELCH control to a point where the AF input circuit is just cut off electrically. Setting the control at such a critical point makes it possible to turn on the AF input circuit as soon as an input signal presents and, therefore, is effective to eliminate the unwanted noise during reception of

no signal.

- (7) Finely tune the receiver to the receiving signal by tuning the RIT control, which varies the VFO frequency just a little. Hence, it is possible for the user to catch two different signals momentarily by operating the RIT control as follows:
Pull the RF GAIN control towards you to disable the RIT control. Catch a certain incoming signal using the main tuning dial. Depress the RF GAIN control to restore the RIT control to its normal condition. Then, catch another incoming signal by operating the RIT control. These steps make it possible for the user to catch the above-mentioned signals momentarily by pulling and depressing the RF GAIN control to turn the RIT control off and on.
- (8) The MODE switch should be placed in an appropriate position depending on the type of emission used in the partner station.

But, it is a general practice to use the LSB position for the SSB signal lower than 7 MHz and the USB for the signal higher than 14 MHz. Switch position AM.N is provided for reception of the AM signal under extraordinary heavy noises. Placing the MODE switch in the AM.N position inserts a noise limiter in the receiver circuit at the output side of AM detector, thereby limiting the noise level. In the FM position, the switch inserts the FM detector in the receiver circuit for reception of the FM signal. In this case, however, place the SELECTIVITY switch in either AUTO or 25 kHz position because the FM signal generally features a wider band width.

- (9) Reading a receiving frequency.
The main tuning dial is graduated in 1 kHz steps for a total of 100 kHz in one complete revolution. Receiving frequency is read off as the sum of readings on the sub-dial scale and main tuning dial. For example, in Fig. 5 the receiver is tuned to 185 kHz plus the frequency of the BAND SELECTOR position to which the receiver is set. Therefore, if it is in the 14 MHz band, the total reading is 14.185 MHz. There are three reference index on the scale: Use the central red index for CW, AM and FM of the MODE switch; in USB, the right-hand side USB index; and in LSB, the LSB index.
- (10) To calibrate the main-dial scale, proceed as follows using the calibration signals provided by the calibrator circuits self-contained. Set the FUNCTION switch to the 25 kHz CAL position and the MODE switch to the CW position. Slowly turn the main tuning dial and you will hear the beat tones

appearing and then dying away through the speaker as the dial is turned clockwise. Find a setting of the scale against the vertical red index where the receiver zero beats precisely. Depress the main dial scale using the black knob assembled around the main tuning dial and turn the scale until its 0, 25, 50 or 75 graduation is precisely set to the setting and this completes the calibration of the scale to the 25 kHz calibration signal.

Fig. 6 illustrates the procedure for calibration of the main dial scale.

- (11) When the receiver is operated with the SELECTIVITY switch placed in the AUTO position, it can be operated with an appropriate filter merely by placing the MODE switch in a desired position. In other words, a filter having the band width corresponding to the position of the MODE switch is inserted in the receiver circuit as follows when the MODE switch is placed in a desired position.

MODE switch position	Band width	Filter selected
CW	0.5 kHz	CW filter
LSB, USB	2.5 kHz	SSB filter
AM, AM.N	5 kHz	AM filter
FM	25 kHz	FM filter

- (12) When the receiver is operated with the MODE switch placed in a certain position, it can be operated with any desired band merely by switching the SELECTIVITY switch from the AUTO to a desired position.

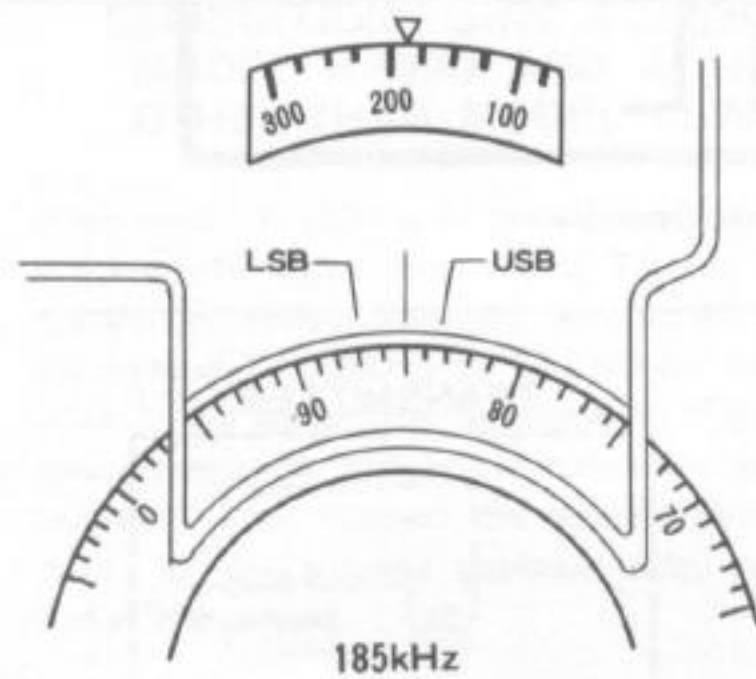

Fig. 5 Frequency Readout

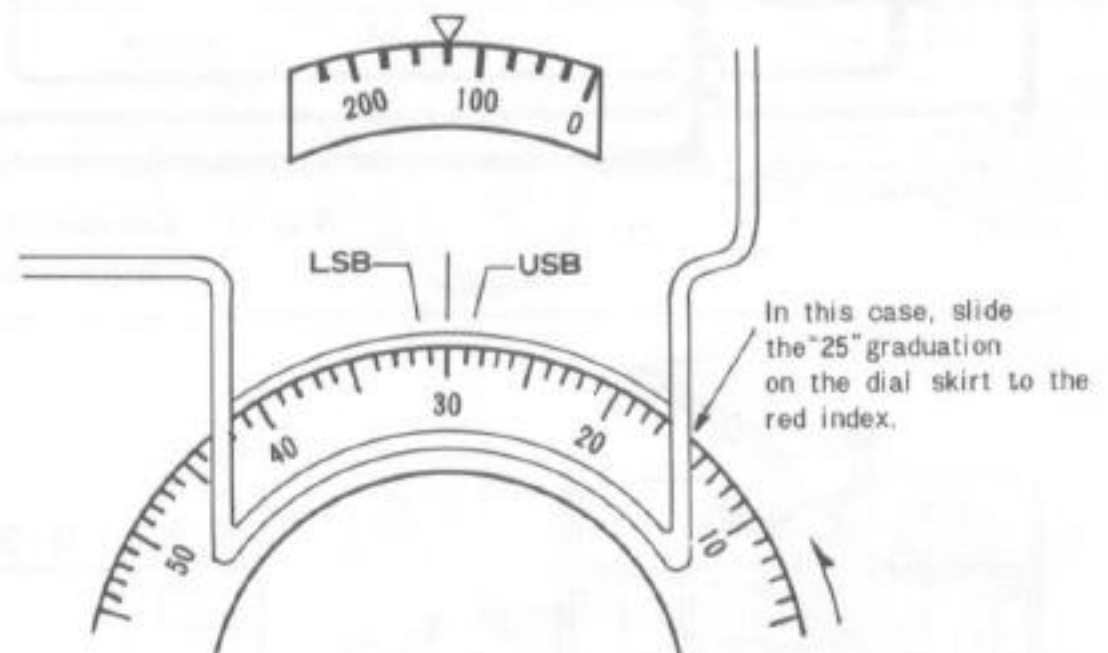

Fig. 6 Calibration

7. COMBINED TRANSMITTER-RECEIVER OPERATION USING A COMBINATION OF MODEL R-599D AND T-599D

The model R-599D Receiver can be operated with the model T-599D Transmitter as a combined transmitter-receiver when the receiver and transmitter are installed together and set up as described below.

- (1) Connect between the REMOTE terminals on the model T-599D and R-599D as shown in Fig. 7 using the connecting cable with 16-pin connector supplied with the model T-599D. Connect the antenna to the antenna terminal of the transmitter. Also, connect the RX ANT termi-

nal on the transmitter to the antenna terminal of model R-599D with connecting cable. Then, throw the switch on the rear transmitter panel into the TRCV position. The above completes the set-up of the model T-599D and R-599D for a combined transmitter-receiver operation.

- (2) As for the operation of the model T-599D under a combined transmitter-receiver operation, refer to the operating manual for model T-599D. When the VFO SELECT switch on model R-599D is in the NORM position, model R-599D and T-599D operate separately even though they are set up for the combined transmitter-receiver operation.

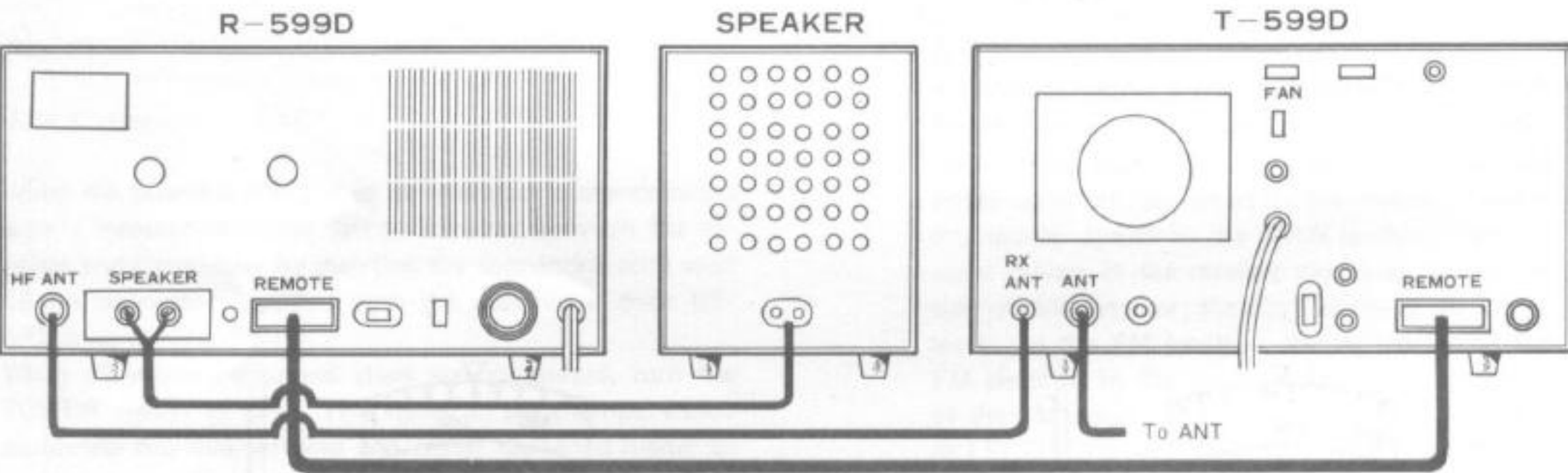

Fig. 7 Combined Transmitter-Receiver Operation Using R-599D & T-599D

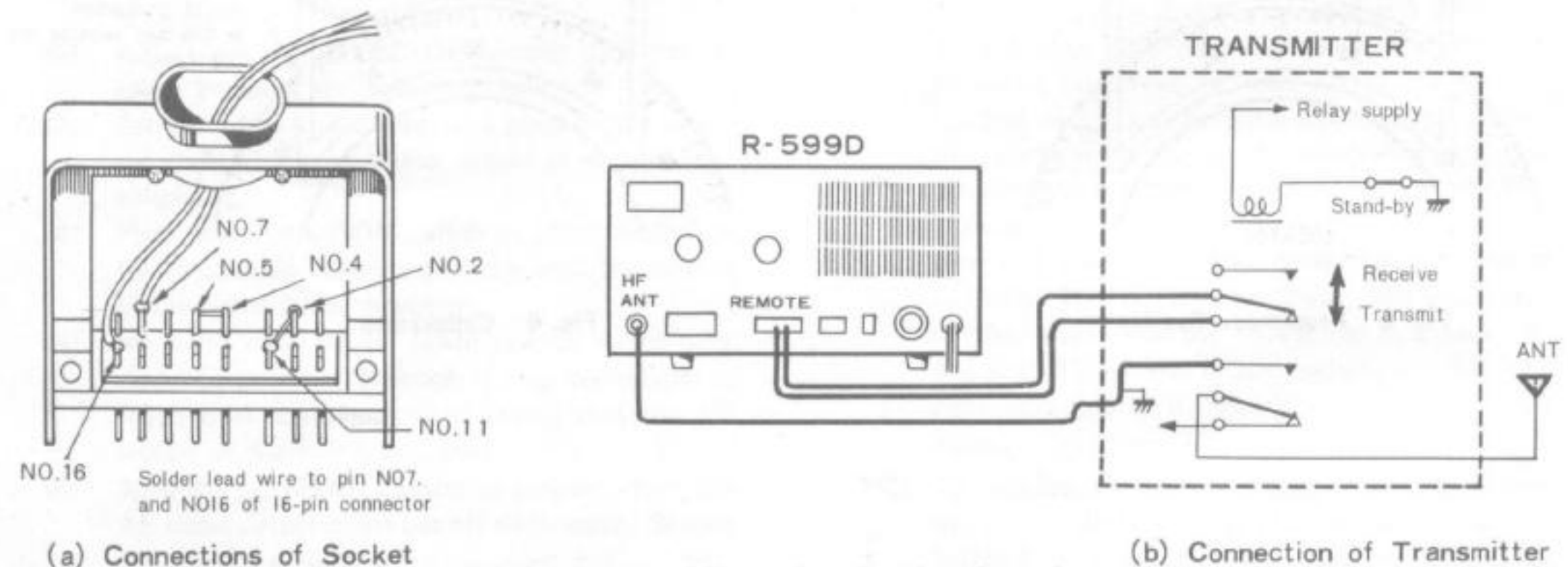

Fig. 8 Combined Transmitter-Receiver Operation Using R-599D & Transmitter Other Than T-599D

When model R-599D and T-599D set up for the combined transmitter-receiver operation are operated with the VFO SELECT switch on model R-599D set at the RX position, the VFO in model R-599D operates for both transmission and reception.

If the VFO SELECT switch is placed in the TX position under the above condition, then the VFO in model T-599D operates for both transmission and reception. If the VFO SELECT switch is placed in the REV position, the VFO of model R-599D operates in lieu of that of model T-599D for transmission and the VFO of T-599D in lieu of that of model R-599D for reception. This means that models R-599D and T-599D operate on the so-called reversed VFO operation.

- (3) When the FUNCTION switch on model R-599D is placed in the MONI position under the combined transmitter-receiver operation, the speaker delivers the sound output of the signal transmitted by model T-599D, thereby providing means for monitoring the signal under transmission. The volume of the monitor sound output can be adjusted appropriately by means of a semi-fixed resistor VR2 in model R-599D.

8. COMBINED TRANSMITTER-RECEIVER OPERATION USING A COMBINATION OF MODEL R-599D AND A TRANSMITTER OTHER THAN MODEL T-599D.

When model R-599D is to be operated in combination with a transmitter other than model T-599D for a combined transmitter-receiver operation, connect the REMOTE terminal on model R-599D to the STAND-BY switch or a control relay in the transmitter as shown in Fig. 8 (a) using the connecting cable with 16-pin connector supplied with the receiver. Also, connect the antenna terminals of the receiver to the antenna duplexer relay provided on the transmitter.

9. OPERATION OF MODEL R-599D FROM A DC POWER SOURCE

To operate model R-599D from a DC power source, proceed as follows:

Throw the AC-DC selector switch on the rear panel into the DC position. Solder the 2-pin connector supplied with model R-599D to one end of lead wires, connect the free end of the lead wires to the DC power source, and plug the 2-pin connector of the lead wires to the DC socket on the

rear panel of model R-599D. In this case, select the power source and lead wires appropriately so as to prevent model R-599D from being powered with an input voltage, which is excessively higher or lower than the reference voltage of 12 V.

Especially, be careful not to connect the power leads to the DC socket with wrong polarities.

It should be noted that the fuse provided on model R-599D is ineffective to the DC source. When operating model R-599D from a DC source, therefore, insert a 2A fuse in the power leads between the DC source and the receiver.

10. AC VOLTAGE SELECTION

The R-599D is equipped with a Voltage Selector to enable operation from 100, 117, 220, 240 AC line sources.

Before inserting power cord into the AC line, check the setting of this selector which is pre-set to the voltage generally available in the areas to which this unit is shipped. This selector must be set to the side that matches the voltage of your power line.

To reset the Selector, pull out the Selector Plug after the fuse holder remove as shown below and reinsert it firmly into the AC Voltage Selector with your line voltage appearing in the cutout of the Selector Plug.

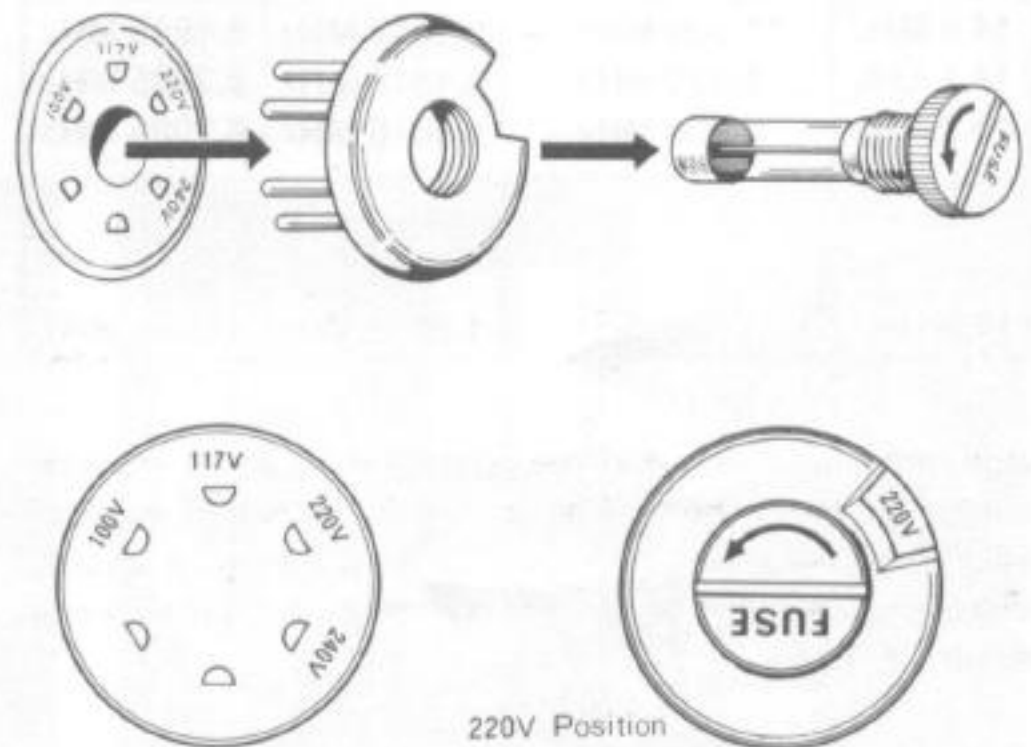

SECTION 5. ALIGNMENT

Model R-599D is marketed as a complete product and, therefore, needs no special adjustment when it is initially placed in its service. But, its components may be detuned more or less with the lapse of time. In order to operate the R-599D under the best operating condition at all times, therefore, it becomes necessary to re-adjust the receiver once every two or three years.

A more precise adjustment, however, requires to prepare many high-grade measuring sets and exceeds the region of the maintenance work permitted to the users because of the limited number of their measuring sets. For this reason, the adjustment procedure given below concerns with the adjustments practicable merely using a circuit tester. As to the adjustments beyond the users' maintenance region or any trouble of the component parts, make contact with the dealers of our products for the adjustments or repairs and the dealers will adjust or repair the set on a charged basis.

It should be noted that the users are requested not to make adjustment or repairs of the VFO, crystal filter, coil pack and BPF because of the high degree of skill required in the adjustment technique for said components. If the users fail to observe the above caution, the KENWOOD cannot guarantee the performance of the set adjusted or repaired.

1. MARKER OSCILLATOR (X52-0005-01)

(See Fig. 10.)

If the marker oscillator suffers from a frequency error by any chance despite of such fact that it is precisely adjusted to the 100 kHz at the factory, proceed as follows:

Set up the receiver for reception of the WWV's 10 MHz standard signal and, while receiving the signal, adjust trimmer TC1 with a screwdriver until the marker oscillator zero beats with the standard signal, as heard through the speaker.

2. AVR UNIT (X43-0010-00) (See Fig. 11.)

If the AVR unit fails to provide a voltage of 9 V at its OUT terminal, adjust VR1 until a voltage of 9 V presents at the terminal.

To make zero adjustment of the RIT control concerning the receiver incremental tuning signal generator circuit involved in this unit, proceed as follows:

Precisely set the RIT control to position 0. Tune the receiver to the 25 kHz standard signal and, while making the 25 kHz marker oscillator output beat with the standard signal, adjust VR2 until the speaker delivers the same

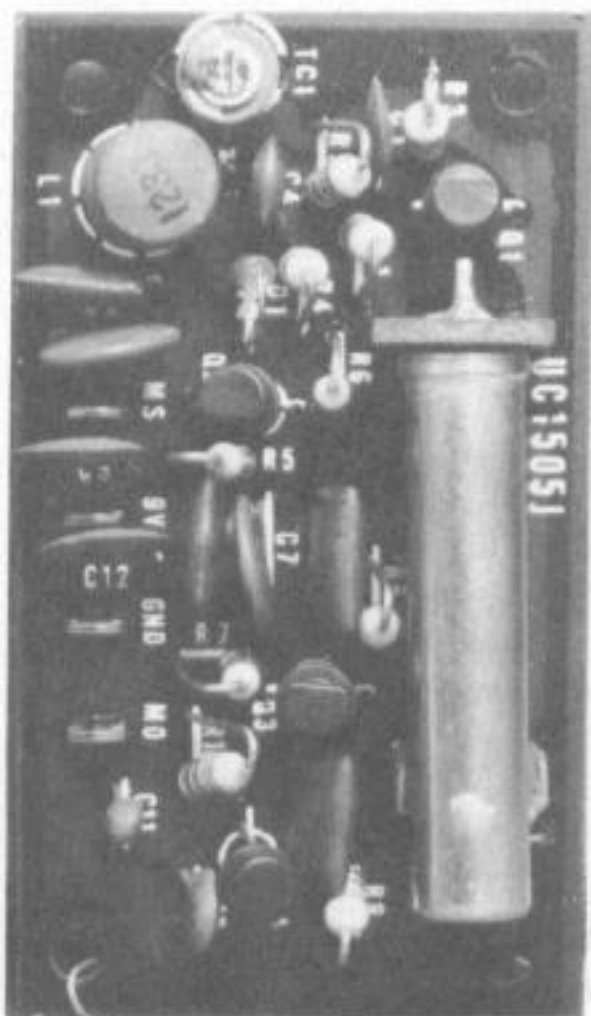

Fig. 10 X52-0005-01

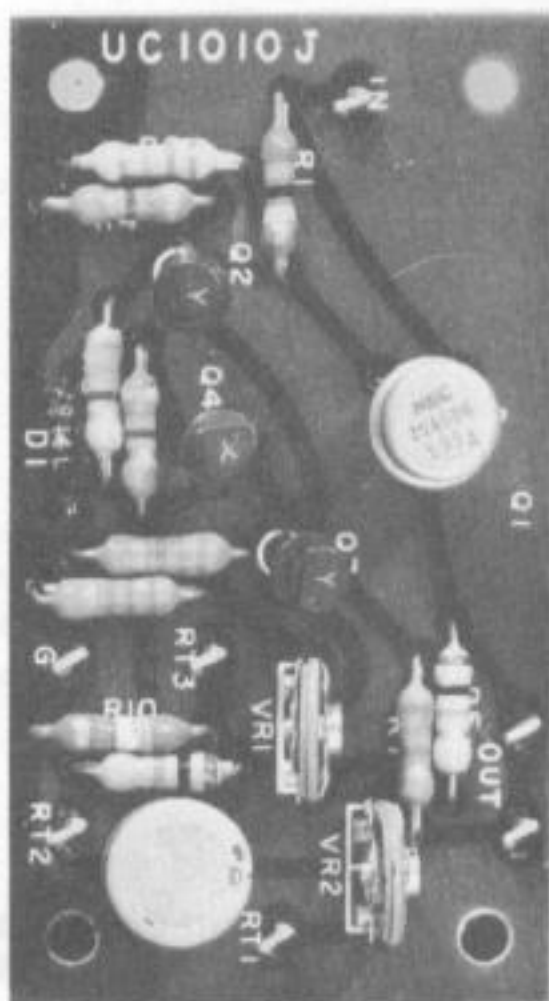

Fig. 11 X43-0010-00

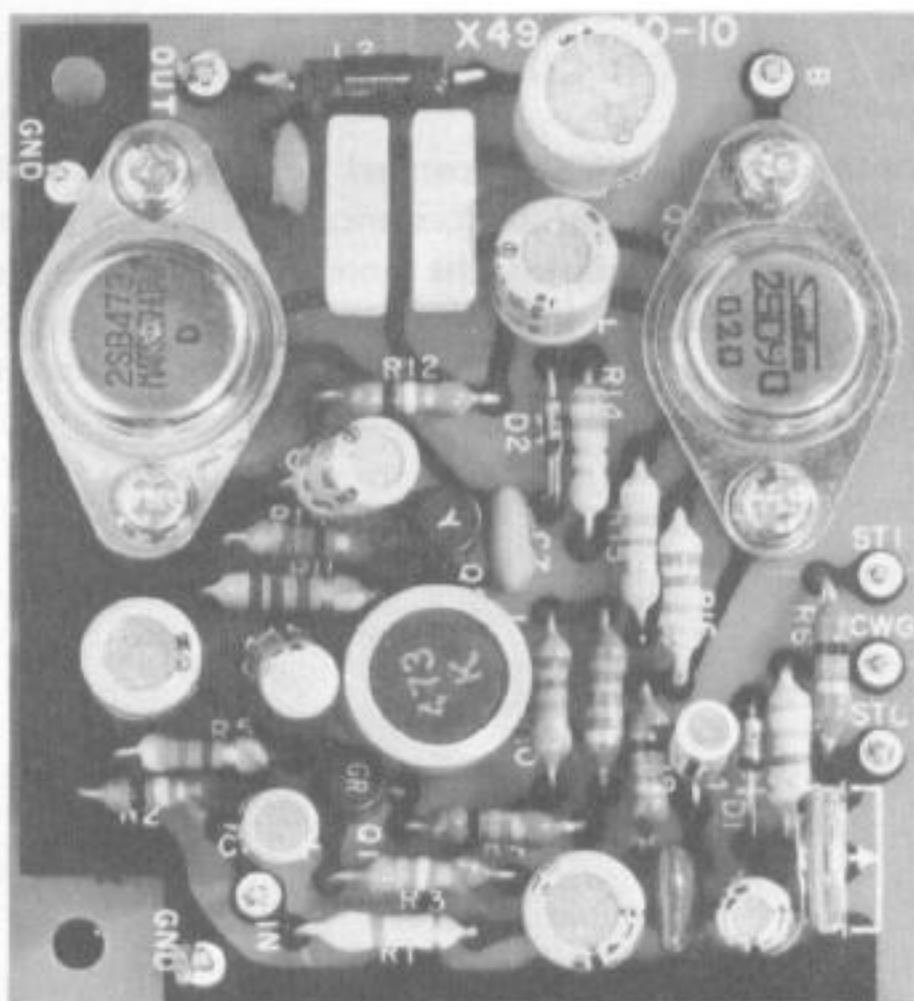

Fig. 12 X49-1040-10

number of beat tones for the RIT control placed in the ON and OFF position.

3. AF UNIT (X49-1040-10) (See Fig. 12.)

The semi-fixed variable resistor (VR1) contained in this unit is for adjusting the output level of the side-tone during CW operation. Adjust it for a comfortable volume of side-tone.

4. FIXED CHANNEL UNIT (X50-1140-10)

(Shown in page 24.)

If the crystal used has a crystal frequency which is not a multiple of the 25 kHz marker frequency, then it is impossible to make adjustment of the fixed channel frequency unless a frequency meter or counter is available.

But, if the crystal frequency is a multiple of the 25 kHz marker signal, for instance 5125 kHz, the channel frequency may be adjusted by making use of the marker signal.

Insert the crystal to be adjusted in its holder for a fixed channel and set the CH SELECT switch to the position corresponding to that channel.

Turn the FUNCTION switch on the front panel to the 25 kHz CAL position. This should cause the speaker to deliver a beat tone. Adjust the trimmer capacitor inserted in parallel with the crystal in the fixed channel unit the speaker gives a zero beat tone. In the above adjustment, it is adequate to place the MODE switch in the LSB position.

5. MONITOR CIRCUIT (Shown in page 25.)

When model R-599D is operated with model T-599D or other transmitter for performance of a combined transmitter-receiver operation, the monitor circuit is inserted in the receiver circuit for monitoring the transmitting signal. In this case, adjust VR2 until the monitoring output from the speaker is set to an appropriate volume.

SECTION 6. MAINTENANCE

1. REMOVAL OF CABINET CASE

Top Plate:

Remove two black screws on the top plate and a total 6 screws from the right and left side plate.

Lift the top plate upwards and the plate can be removed from the chassis.

Bottom Plate:

Remove 6 setscrews holding the bottom plate to the chassis and the plate can be removed from the chassis. Note that the legs provided have nothing to do with removal of the bottom plate. Also, use a ⊕screwdriver for removal of setscrews and place the removed screws in a container. This will prevent the screws from missing and insure a speedy work.

2. GEAR

Thoroughly clean and lubricate with machine oil the gearing such as the double gears of a dial, which are always subjected to friction, once a year. This alleviates the friction of gears.

3. PILOT LAMP

Model R-599D employs tubular pilot lamps. If any of these pilot lamps suffers from an open circuit by any chance, replace it with a replacement lamp which is available at the dealers of our products. When purchasing the lamp, however, never fail to designate the ratings of the lamp; 14 V, 200 mA.

Note that replacement of the pilot lamp used in the meter section may be facilitated provided that the replacement work is performed after removal of the metal fittings fixing the meter to the panel.

4. FUSE

Model R-599D employs a 0.5A glass-tube fuse. If this fuse is blown out by any chance, inspect the receiver circuit thoroughly for any possible cause of a blown fuse, remove the cause of trouble, and replace the faulty fuse.

5. CLEANING

The control knobs and the like become dark owing to the rust generated by sweat or hand-stained when they are in service for a long time. Hence, remove the knobs as required and wash them in neutral cleaner. And you may enjoy

a smooth and favourable operation to the receiver using the clean knobs.

To remove the dust and stains from the panels and case, blast them with LP shower and the like and then wipe them clean with soft, dry cloth. This makes the receiver take on an entirely new charm.

Also, clean the interior of the receiver set once half-year since the dust and other are accumulated within the set and turned into such trouble as improper contact or insulation.

TOP VIEW OF THE R-599D(Fig 13)

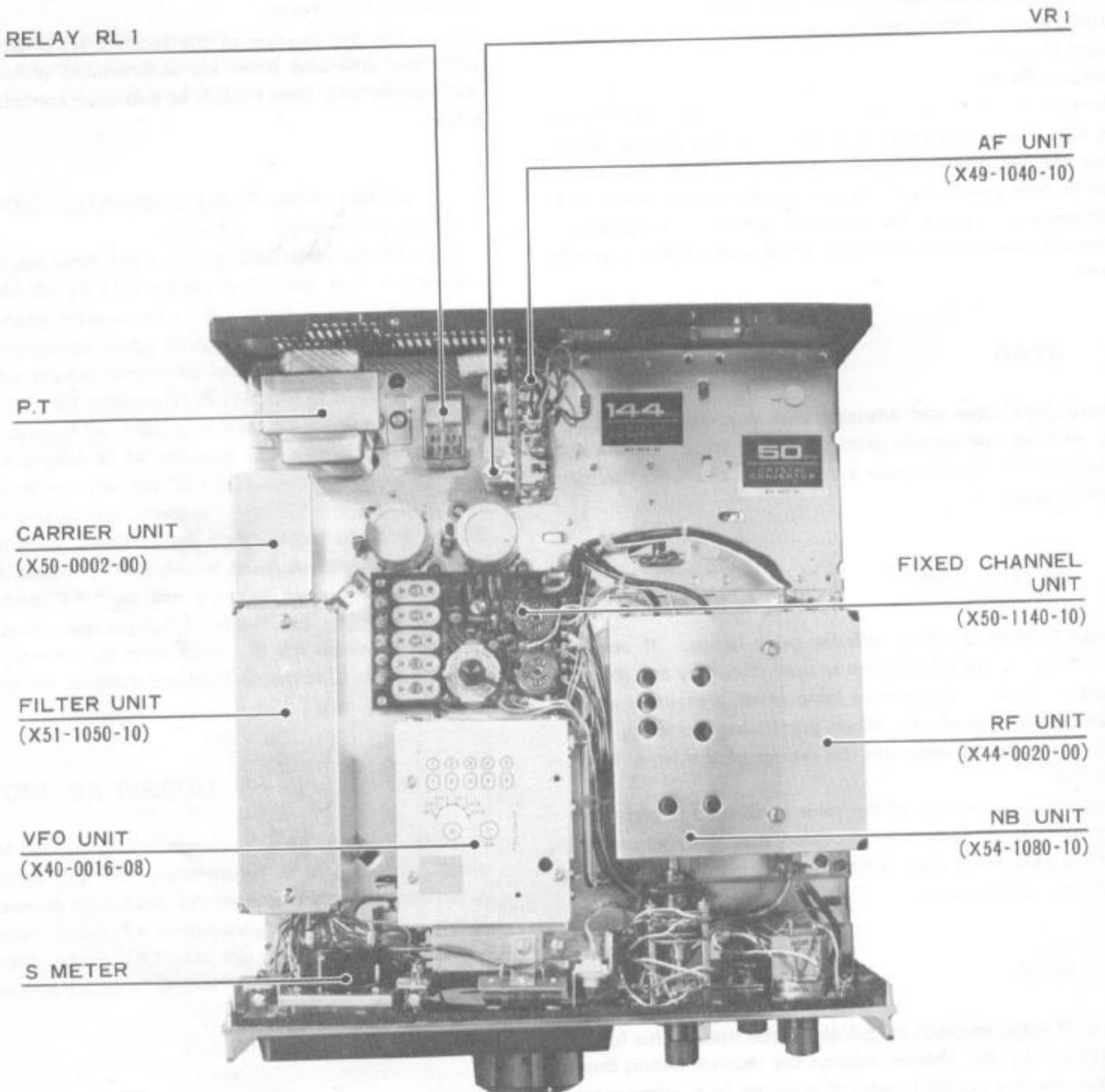

BOTTOM VIEW OF THE R-599D(Fig 14)

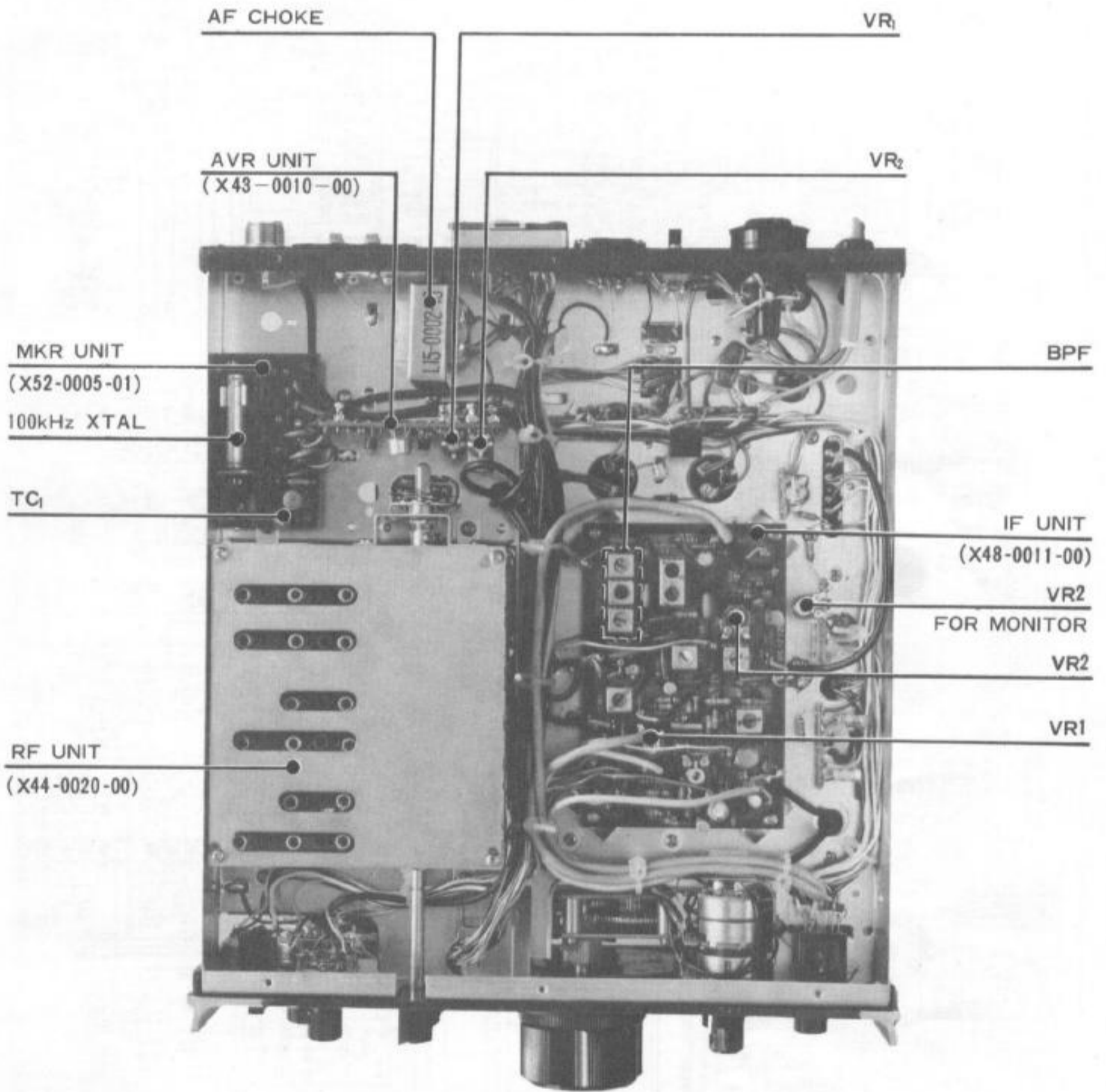

R-599D SCHEMATIC DIAGRAM

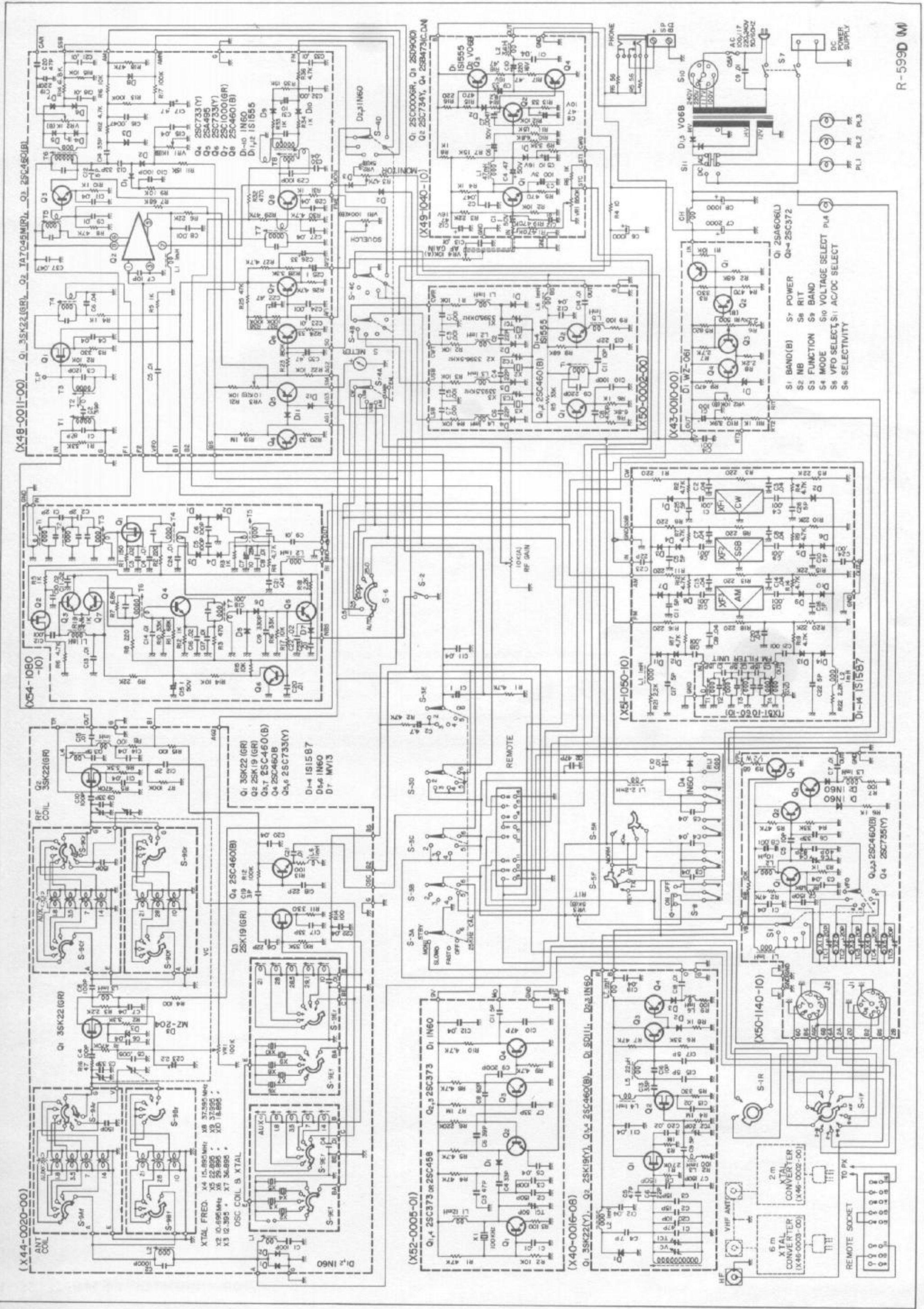

R-599D (M)

NOTE

The BAND switch on your receiver has an AUX position, utilization of which will be described here in an example.

Example: Addition of the 15 MHz WWV band. Receive frequency band: 15 to 15.6 MHz

parts used:

	Part No.
Antenna tuning coil	L31-0016-04
RF tuning coil	L31-0023-04
Oscillator coil	L32-0007-04
Oscillator crystal ($f = 23.895$ MHz)	L77-0180-15

Installation

1. Remove the bottom cover from the receiver.
2. Remove the shield plate on the coil pack.
3. Loosen the two screws holding the band switch shaft as shown in Figure 1.

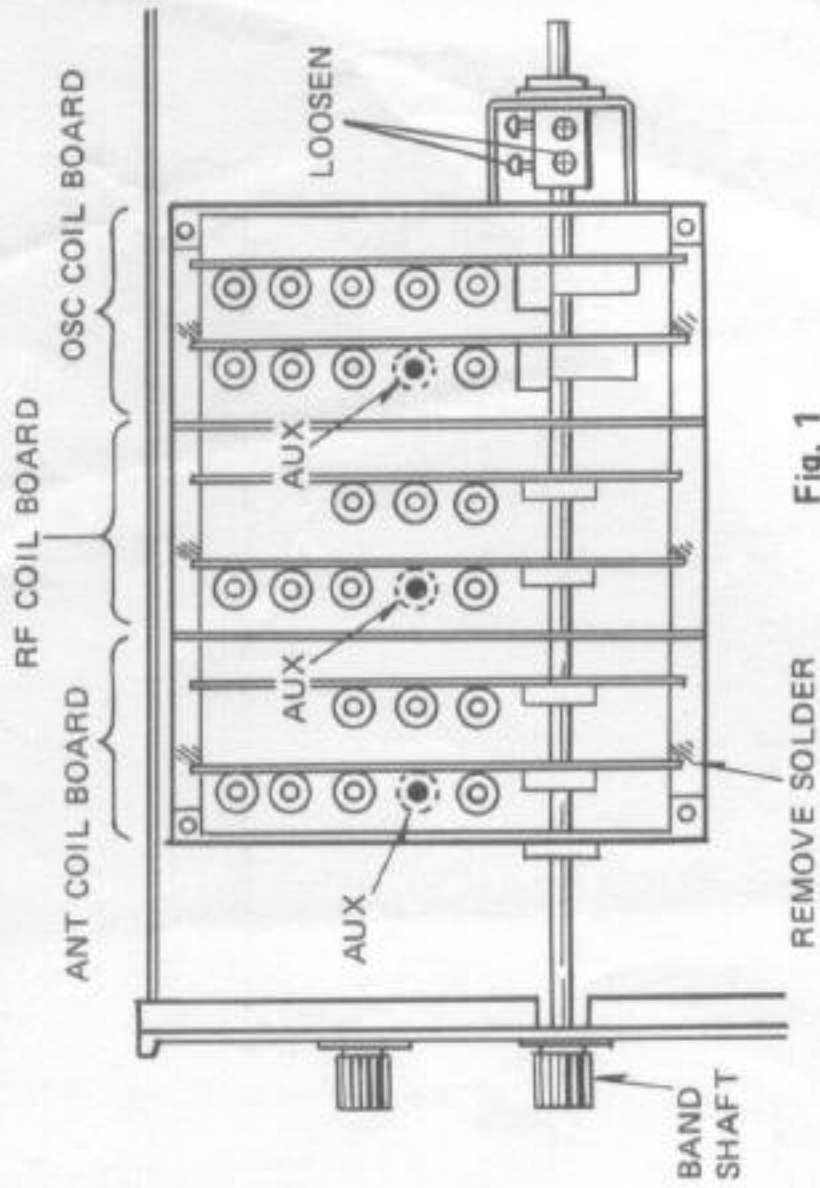

4. Draw the band switch shaft knob toward you for removal.
5. Each coil pack contains a pair of PC boards.
6. Unsolder the leads from the AUX band PC board in the coil pack.
CAUTION: Record the position of each lead before unsoldering.

7. Install the parts in each coil pack in a manner similar to those already installed.

- a. Install antenna coil on the antenna PC board.
 - b. Install the RF coil on the RF PC board.
 - c. Install the oscillator coil and crystal on the oscillator PC board.
8. After parts installation, reinstall PCB's by reversing Steps 1 through 6.

Alignment

A. Set-up

1. Loosen the quick release latches, opening the top cover of the receiver.
2. Connect an RF VTVM to the OSC and G terminals on the RF unit as shown in Figure 2.

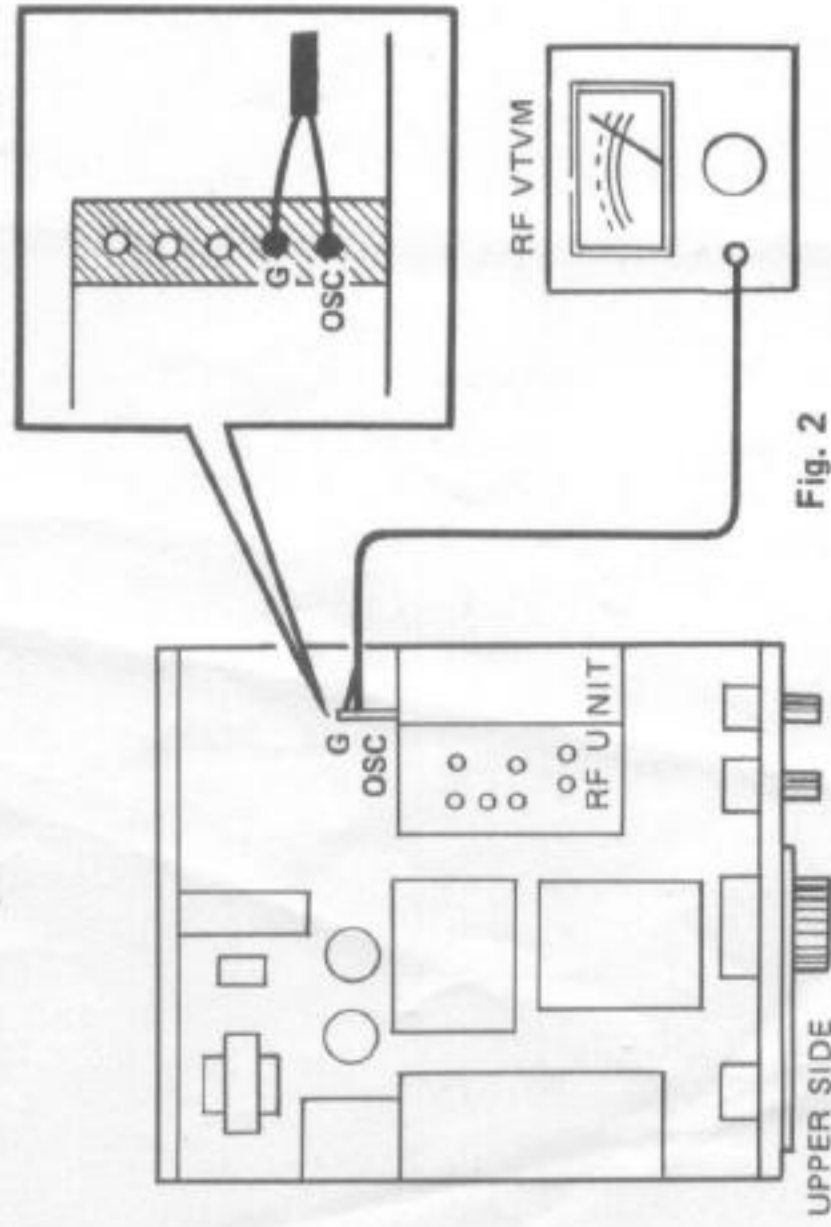

3. Set the BAND switch to the AUX position.

B. Aligning the oscillator coil

Adjust the AUX band oscillator coil for maximum.

C. Aligning the antenna and RF tuning coils

1. Disconnect the RF VTVM.
2. Set the FUNCTION switch to the 25 kHz CAL position.
3. Tune the marker signal at "0" dial setting.
4. Set the PRESELECTOR control to the 10:30 position.
5. Adjust the AUX band antenna and RF coils for maximum S meter reading.



KENWOOD

Manufactured by TRIO ELECTRONICS, INC., Tokyo, Japan