

INSTRUCTION MANUAL
FOR
MODEL NRD-545



DSP RECEIVER

<Introduction>

Congratulations on your purchase of Japan Radio Company's NRD-545 DSP RECEIVER.

This product is a receiver which fully covers frequencies in the range 100 kHz to 1999.999 MHz. Note that you need the wideband converter unit CHE-199 (option) to receive frequencies higher than 30 MHz.

- Before using this product, be sure to thoroughly read this instruction manual to ensure correct use.



- After reading this instruction manual store in a safe place so that it can be referred to whenever necessary.
This instruction manual will come in useful if you are unsure of an operation during use or if some trouble occurs.

< Before Use >

Carefully read the Precautions Upon Use before using the equipment to ensure proper use.

The cautions show here describe how to avoid injuring yourself or others while using the equipment, and how to avoid damaging the equipment. Be sure to follow these instructions.

The follow warning and caution labels indicate the degree of equipment damage or personal injury that can occur if you do not follow the safety instructions and use the equipment improperly.

 WARNING	This label indicate there is a possibility of death or serious injury if the proper procedures are not followed.
 CAUTION	This label indicate there is a possibility of injury or damage to the equipment if the proper procedures are not followed.

Examples of Icons



CAUTION
ELECTRIC SHOCK

△ icons tell you that caution (including DANGER and WARNING) is urged.

The actual details of the caution are pictured inside the icon. (The icon on the left indicates that caution is urged to prevent electric shock.)



DISMANTLING
FORBIDDEN



FORBIDDEN

⊘ icons tell you that a certain action is forbidden.

The actual details of the forbidden action are pictured either inside or near to the icon. (The icon in the left indicates that dismantling is forbidden.)



REMOVE PLUG



INSTRUCTION









● icons tell you that a certain action is compulsory.

The actual details of the compulsory action are pictured inside the icon.

(The icon in the left indicates that the power plug must be removed from its outlet.)

<Precautions Upon Use>

WARNING

-  Do not insert metal or flammable objects through the vents on the back and top cover. Doing so can result in fire or electric shock.
-  Do not use any cable other than the supplied AC cable. Doing so can result in fire or electric shock.
-  Do not scratch, tear, modify, excessively bend, yank, or twist the power cord, or allow it to become excessively hot. Doing so can damage and tear the cord, resulting in igniting, electric shock, or equipment failures.
-  Do not set anything heavy on the power cord or connector cords, or sandwich them between objects. Doing so can damage and tear the cords, resulting in igniting, electric shock, or equipment failures.
-  Do not use the power cord if the cord or plug is damaged, or if it fits loosely in the outlet. Doing so can result in a short circuit and start fire.
-  Only use the specified supply voltage. Using a different supply voltage can cause the equipment to ignite or burst into flames.
-  Only use the specified fuse type. Using a different type of fuse can cause the equipment to ignite or burst into flames.
-  You are forbidden to subject the cell to any of the following when handling the cell:
 - Charging
 - Forced charging
 - Uses other than specified
 - Burning of cells
 - Heating above 70 °C
 - Short-circuiting
 - Disassembly, damage and deformation by applied pressure
 - Exposure (e.g. leaving the cell outside or in a hot, humid environment)
 - Water leakageFailure to observe the above handling precautions may cause the cell to explode, ignite or emit gases that are harmful to the human body.
If the cell emits gases, avoid inhaling the gas, and immediately ventilate the surrounding area.
-  Do not disassemble nor remodel this product. Illegal remodeling not only results in a fine according to the Regulations, but also can result in fire, electrocution or malfunction.
To internal inspection or repair, contact your dealer or the nearest JRC office.

WARNING



When connecting the DC power cord, be sure the positive (+) and negative (-) polarities are correct. Connecting the cord with the polarities set backwards can result in igniting, electric shock, or equipment failures.



The equipment will become very hot if it is used for an extended period of time. Be careful not to allow children or other adults in the area to touch the equipment. Touching the equipment can burn the skin. The equipment should be installed in an area with good ventilation.



Using the product while it is emitting smoke, emitting a strange odor, or otherwise functioning abnormally can result in fire or electric shock. In the event of such problems, immediately turn the power OFF and be sure to remove the power plug from the electric outlet. Next, contact your dealer or the nearest JRC office. Do not ever attempt to fix the product yourself.



If you hear thunder, turn the power switch OFF and remove the power plug from the AC outlet as a safety precaution. Never touch the antenna or the main unit under such conditions. Doing so can result electric shock.



Never touch the equipment or its power plug with wet hands. Doing so can result in electric shock.

CAUTION



Do not install the product in locations such as those listed below. Doing so can result in fire or electric shock, or cause the product to fail.

- Locations which are exposed to direct sunlight, in the path of heaters, or otherwise exposed to hot air
- Locations with poor ventilation
- Locations which are subject to large amounts of moisture or dust
- Locations in the vicinity of objects which could change in shape or ignite if heated
- Locations in the vicinity of flower vases or other objects containing water
- Unstable locations



Do not open the product case except to add options. Opening the case can result in injury or electric shock, or damage the equipment. Also, may invalidate the equipment guarantee.



Do not sit on the product or place anything on top of it. Doing so may cause the product to fall or be knocked over, resulting in injury or damaging the equipment.



Do not drop or bang the product. Doing so can result in injury or damage the equipment.



Do not touch areas of the equipment which are not described in this manual. In particular, do not touch the interior of the equipment. Doing so can cause the equipment to fall.



Do not use headphones when using the product for a long time. Doing so can impair hearing.



Do not install the product near televisions, radios, or computers. Doing so can cause radio frequency interference in the product or nearby electronic devices.



As a safety precaution, turn the power OFF and remove the power plug from its outlet before cleaning the exterior of the product. Wipe off dust, etc. with a dry towel. If the exterior is extremely dirty, use a neutral detergent soaked in water. Never use paint thinner, benzene, or alcohol. Doing so can cause the equipment to fail.



Be sure to hold the power cord or connector cable by its plug when inserting or removing it. Failure to do so can result in electric shock, or cause a short circuit and start a fire.



Ground terminals should be as thick as possible and installed securely. Wire runs should be as short as possible. Never connect a ground terminal to a gas pipe, wire conduit, etc. Doing so can result in explosion or electric shock in the event of a failure or electric leak.



If you do not plan to use the equipment for an extended period of time, remove the power plug from the AC outlet. Grab the cord by the plug when removing it from the outlet. Do not pull directly on the cord. Doing so can result in heating, igniting, and fire.

JRC Offices

Refer to the end of this manual for a list of JRC offices.

■ NOTICE

When you first use this product, you may smell a strange odor. This odor is caused by volatilization of the varnish solvent applied to the transformer. This is not a malfunction.

CONTENTS

SECTION 1: UNIT OVERVIEW	1
1.1 FUNCTION	1
1.2 FEATURES	1
1.3 UNIT CONFIGURATION	2
1.4 BLOCK DIAGRAM	3
1.5 OUTLINE DRAWING	4
SECTION 2: OPERATING CONTROLS	5
2.1 FRONT PANEL	5
2.2 REAR PANEL	12
SECTION 3: INSTALLATION	14
3.1 INSTALLATION LOCATION	14
3.2 INSTALLING THE RECEIVER	14
SECTION 4: OPERATING THE NRD-545	16
4.1 RECEIVING DIFFERENT TYPES OF SIGNALS	16
4.2 MEMORY OPERATIONS	19
4.3 SCAN & SWEEP OPERATIONS	19
4.4 CLOCK & TIMER OPERATIONS	21
4.5 MODIFYING OPERATIONS BY USER SETUP	23
4.6 OPERATING THE NRD-545 FROM A PERSONAL COMPUTER	24
SECTION 5: ADJUSTMENT AND MAINTENANCE	31
5.1 ADJUSTMENT	31
5.2 MAINTENANCE	31
5.3 TROUBLESHOOTING	32
5.3.1 SIMPLE PROBLEMS	32
5.3.2 MORE SERIOUS PROBLEMS	33
SECTION 6: CUSTOMER SERVICE	34
SECTION 7: OPTIONAL UNITS	35
7.1 INTRODUCTION	35
7.2 REMOVING COVERS	36
7.3 REMOVING INTERNAL UNITS	37
7.4 FASTENING COVERS	37
SECTION 8: ABOUT DISCARDING THE UNIT	38
8.1 DISCARDING THE UNIT	38
8.2 DISCARDING LITHIUM CELLS	38
SECTION 9: SPECIFICATIONS	39
LIST OF JRC OFFICES	THE END OF THIS MANUAL

Explanation of Main Technical Terms

CPU	Central Processing Unit
DDS	Direct Digital Synthesizer
FET	Field Effect Transistor
PLL	Phase Locked Loop
PPM	Parts Per Million
DSP	Digital Signal Processor
TCXO	Temperature Compensated X'tal Oscillator

1.1 FUNCTION

The NRD-545 is a DSP receiver that continuously covers the 100 kHz to 29.999999 MHz range. The NRD-545 can be upgraded to cover the range 100 kHz to 1999.999 MHz range by attaching the CHE-199 wideband converter unit (option). However, note that in this reception frequency range, reception of some frequencies is prohibited.

1.2 FEATURES

(1) DSP-BASED DIGITAL SIGNAL PROCESSING

In addition to the digital IF filter, circuits from the IF onwards process digital signals so that high-quality signals free from distortion can be played back.

(2) HIGH SENSITIVITY AND DYNAMIC RANGE

An RF amplifier with four parallel-connected JFETs and a double balanced mixer with quadruple-connected FETs provide high sensitivity and dynamic range.

(3) ELECTRONIC TUNING SYSTEM

Capacitor diode-based electronic tuning is used for the front-end double-tuned circuit. This circuit attenuates unwanted signals to greatly improve multi-signal characteristics.

(4) DDS IC OPERATED HIGH-SPEED 1 HZ STEP SYNTHESIZER

One-chip DDS is used in combination with PLL to achieve high-speed 1 Hz step frequency selection, high C/N and overall simplification of circuits.

(5) VARIOUS INTERFERENCE REJECTION

• NR (Noise Reduction)

By enhancing signals having cyclic characteristics such as reception signals and attenuating random signals such as noise, reception signals buried in noise stand out so that they are audible.

• BC (Beat Canceler)

The Beat Canceler enhanced signals having perfect cyclic characteristics such as beat disturbance so that they are canceled.

Voice signals are processed so that they are not judged to be cyclic signals and have no distortion. The Beat Canceler is effective on multiple beats.

• NB (Noise Blanker)

This Noise Blanker is for pulse-type noise. Two blankers are provided: NB1 and NB2. NB1 is effective on noise having a comparatively narrow pulse width, and NB2 is

effective on noise having a comparatively wide pulse width.

• Notch Filter

This notch filter has sharp attenuating characteristics, and greatly reduces beat disturbance adjacent to the desired signal. The variable range is ± 2.5 kHz. When notch tracking is turned ON, the notch filter tracks within the range ± 10 kHz even if the MAIN TUNING dial is turned.

• PBS (Pass Band Shift)

The center frequency of the digital IF filter can be apparently shifted up or down so that disturbance signals are pushed out of the band. The variable range is ± 2.3 kHz.

• BWC (Bandwidth Control)

The pass band width of the digital IF filter can be continuously varied within the range 10 Hz to 9.99 kHz.

• ECSS (Exalted Carrier Selectable Sideband)

When AM signals disturbed by an adjacent station are being received, the disturbance can be removed by selecting a sideband on the USB or LSB side that is not subject to the disturbance. ECSS differs from conventional methods where disturbance is removed by a narrowband filter, and allows clear reception with little deterioration in audio quality.

(6) RTTY DEMODULATOR PROVIDED AS STANDARD

Shift width 170, 425 and 850 Hz, baud rate 37 to 75 baud ITU-T No.2 code RTTY signals can be demodulated. Demodulated output can be displayed on a personal computer display via the RS-232C interface.

(7) PC-BASED REMOTE CONTROL

Personal computer remote control functions are provided as standard. In addition to control and confirmation of panels, S meter information can also be downloaded.

(8) INTERNAL CLOCK/TIMER

The built-in real-time clock and timer function can be used to automatically turn the NRD-545 ON and OFF at specified times. Up to 21 timer reservations can be set.

(9) 1000-CHANNELS MEMORY CAPACITY

The NRD-545 has a 1000-channels memory capacity which is backed up by a lithium cell.

(10) BUILT-IN SPEAKER

The built-in speaker allows satisfactory reception on the NRD-545 body alone. Those wishing even clearer reception should use the NVA-319 external speaker (option).

(11) WIDEBAND CONVERTER (OPTION)

When the wideband converter unit CHE-199 (option) is installed, you can receive with the range 100 kHz up to 1999.999 MHz. Note that reception modes from 30 MHz or higher are limited to AM, FM and WFM, and that reception of some frequencies is prohibited.

1.3 UNIT CONFIGURATION

1.3.1 STANDARD COMPONENTS

Table 1-1

Product Name	Model Name	Q'ty	Remarks
Receiver	NRD-545	1	
M-type coaxial Plug	M-P-5	1	
RCA-type Plug	AR-568M	5	
Headphone Plug	PJ-2272	1	
Record Plug	AP314	1	
Fuse	MF61NR1	1	Glass, cylindrical 1A
DC Power Cord	6ZCJD00127	1	
AC Power Cord	MPKC02531 or MPKC02532	1	MPKC02531 = For 120 VAC MPKC02532 = For 220 VAC
Instruction Manual		1	

1.3.2 OPTIONAL UNITS

Table 1-2

Product Name	Model Name	Applications and Outline
Wideband converter unit	CHE-199	30 MHz ~ 1999.999 MHz
TCXO	CGD-197	± 0.5 ppm
External speaker	NVA-319	8 Ω
Headphone	ST-3	600 W dual-ear type
RS-232C cable	6ZCJD00350	For personal computer remote control

1.4 BLOCK DIAGRAM

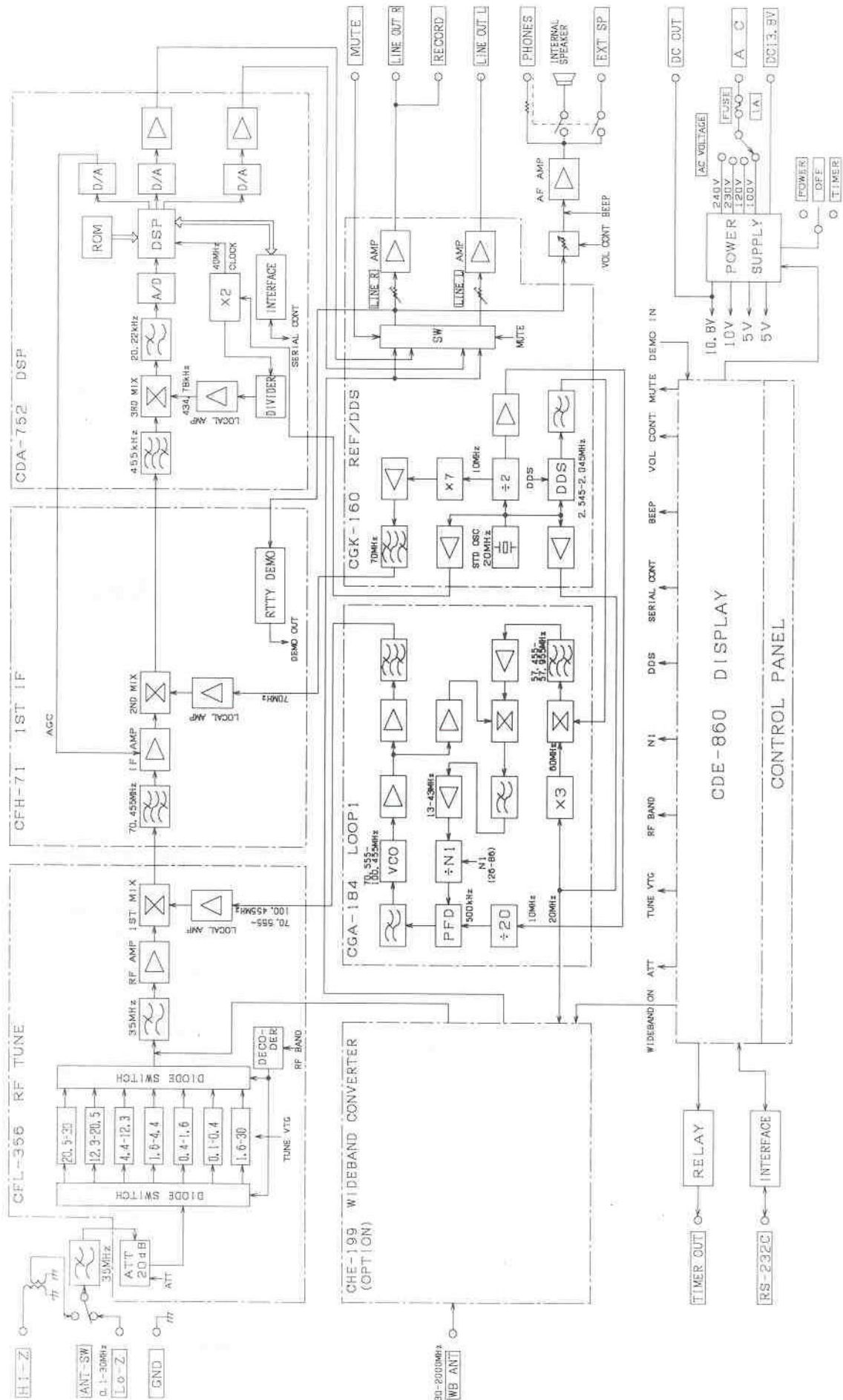
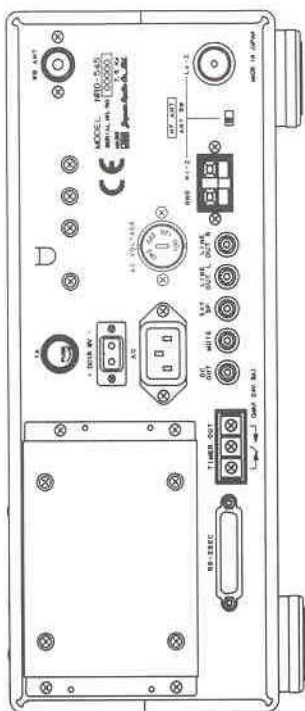
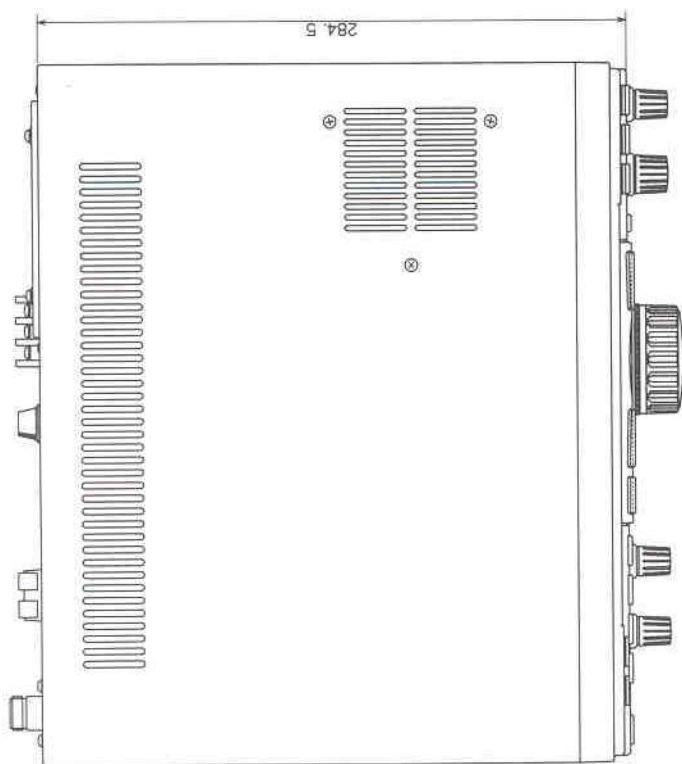
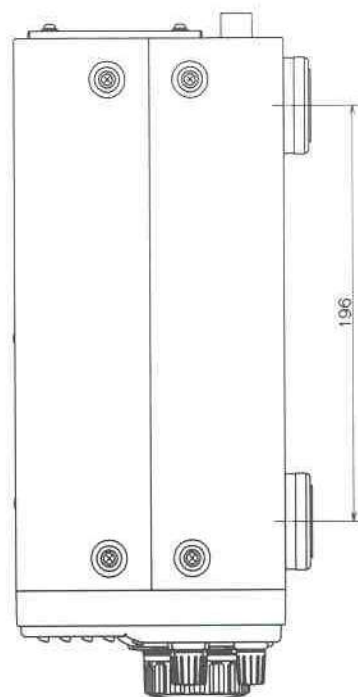
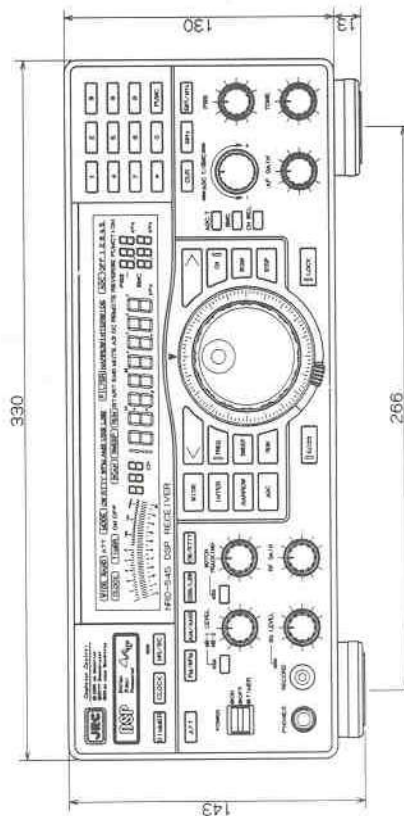

Figure 1.1 NRD-545 DSP Receiver Block Diagram

1.5 OUTLINE DRAWING



Rear panel



(unit: mm)

Figure 1-2 NRD-545 Outline Drawing

SECTION 2

OPERATING CONTROLS

2.1 FRONT PANEL

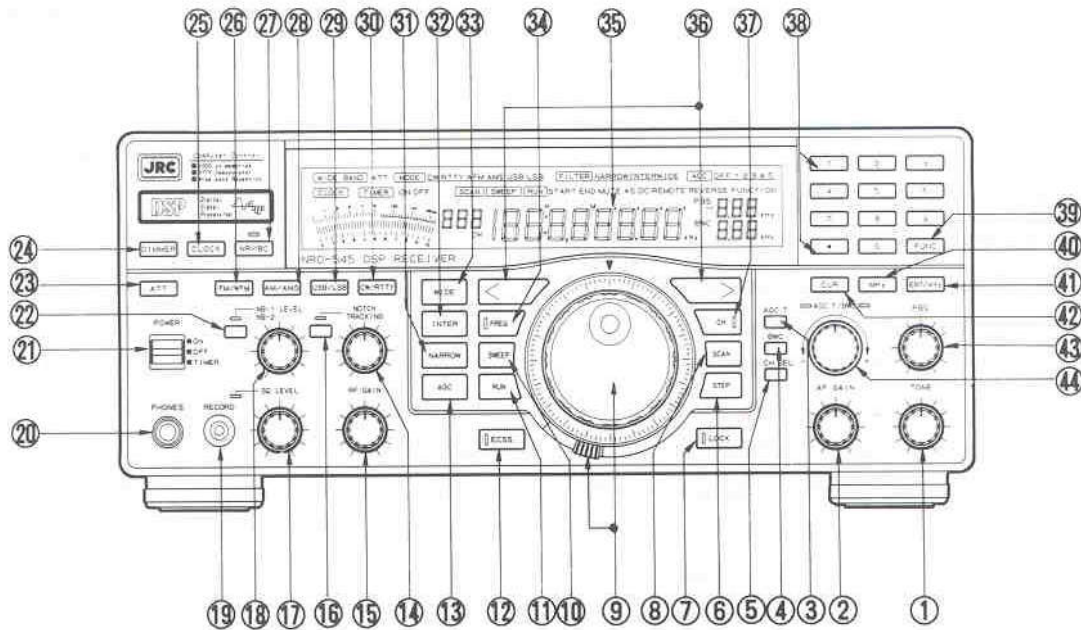

① TONE control

The TONE control can be used to adjust the NRD-545's tone by changing the high frequency response for speaker and headphone output. Turn the control clockwise to raise the high band level. Set the tone as desired. Note that when you narrow the IF filter to receive outside of the high band level, turning this control clockwise will not output high band tone.

When the RTTY mode is set, this control functions as a RTTY demodulation filter fine-adjustment control. Normally, set this control to the center position. This control is not applicable when in the WFM mode.

② AF GAIN control

The AF GAIN control is used to adjust the volume of the speaker and headphone. Turn the knob clockwise to increase the volume.

③ AGC T button

When you press this button, the AGC T LED at FINE control ④ lights green.

When you turn FINE control ④ with this LED lit, the AGC discharge time constant can be adjusted in 20 m second steps with the range 0.04 to 5.1 seconds, and the discharge time constant is displayed on the LCD. As the discharge time constant is memorized for each mode, the discharge time constant automatically becomes the preset time constant when you select a mode. Note that the time constants for the FM, WFM, AM and AMS modes are fixed and cannot be adjusted.

④ BWC (bandwidth control) button

When you press this button, the BWC LED at FINE control ④ lights green. When you turn FINE control ④ with this LED lit, the IF filter bandwidth can be adjusted in 10 or 100 Hz steps with the range 10 Hz to 9.99 kHz. When this control is turned clockwise, the bandwidth broadens, and when turned counterclockwise, the bandwidth narrows. Normally, the bandwidth is adjusted in 10 Hz steps. To change the step to 100 Hz, press FUNC button ③ and press the BWC button ④. The bandwidth is displayed on the LCD. The bandwidth cannot be changed in the FM, WFM or AMS modes.

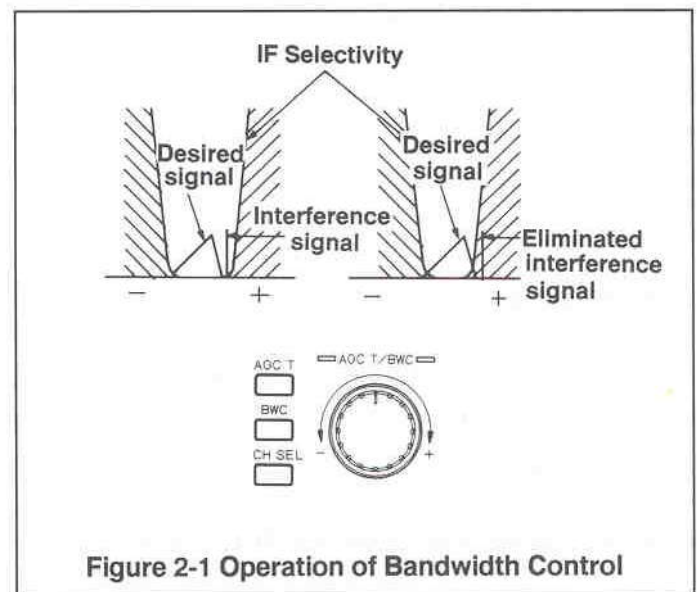

Figure 2-1 Operation of Bandwidth Control

⑤ CH SEL (channel select) button

When you press this button, the memory channels are called up, and you can increment or decrement the memory channel by FINE control ④.

⑥ STEP button

Use this button to select the tuning step when the frequency is changed by the MAIN TUNING dial ⑨. Pressing this button moves the ◀ mark from the 10 Hz digit on the display to the top right of the 100 kHz digit. The frequency can be changed at the step of the digit indicated by the ◀ mark. When all ◀ marks are out, the tuning step is 1 Hz (100 kHz when the frequency is 30 MHz or higher). In modes other than the FM mode, 1 Hz/10 Hz/100 Hz/1 kHz can be selected as the tuning step, and in the FM mode, 1 kHz/10 kHz can be selected. The digit lower than the specified step is cleared to "0" when the MAIN TUNING dial ⑨ is turned.

At frequencies 30 MHz or higher, 5 kHz/10 kHz/100 kHz can be selected. (Note that the wideband converter unit CHE-199 (option) must be attached.)

The tuning can also be changed to a special step in the user setup. For details, see 4.5. For reception frequencies 30 MHz or higher, the tuning step can be changed automatically according to the reception frequency band. For details, see 4.5.

⑦ LOCK button

Use this button to lock operation of all buttons and controls on the panels. When you press this button, operation of buttons and controls is locked, and the red LED lights. To cancel the lock, press this button again. You can also lock operation of only the MAIN TUNING dial ⑨ in the user setup when this button is pressed. For details, see 4.5.

When the REMOTE display on the LCD and the red LED on the LOCK button are both lit at the same time, this indicates that the NRD-545 is being remote-controlled by a personal computer, and all buttons and controls on the panels cannot be operated.

⑧ SCAN button

Use this button to select the scan start and scan end frequencies. Each press of this button toggles between the scan start and scan end frequency. For details on how to scan a frequency range, see 4.3.

⑨ MAIN TUNING dial/VARIABLE TORQUE control

The MAIN TUNING dial is used to change the reception frequency in steps as small as 1 Hz. Tuning the dial clockwise raises the frequency, and turning it counterclockwise lowers the frequency.

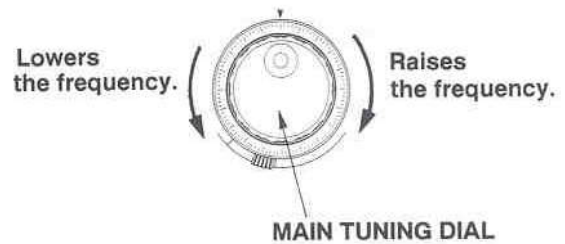

The standard setting is 1000 pulses/turn of the MAIN TUNING dial. So, the amount that the frequency changes is "1000 x the frequency step." This setting can be changed to 500 pulses/turn or 250 pulses/turn in the user setup.. For details, see 4.5.

Moving the VARIABLE TORQUE control makes movement of the MAIN TUNING control heavier.

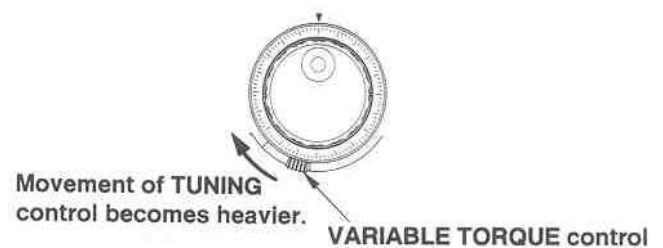

⑩ SWEEP button

Use this button to select the sweep start and sweep end frequencies. Each press of this button toggles between the sweep start and sweep end frequency. For details on how to sweep frequencies, see 4.3.

⑪ RUN button

Use this button to execute a frequency scan or sweep. Each press of this button toggles frequency scan or sweep ON and OFF.

⑫ ECSS button

Use this button for activating the ECSS circuit. When you press this button when the mode is set to AM, the button LED lights, the ECSS circuit operates, and USB on the mode display lights. Each press of this button cyclically changes its operation as follows:

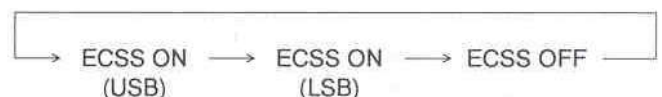

When the reception signals are subject to beat disturbance by an adjacent station, or when fading distorts voice signals, try changing the setting of this button and receive again

according to the reception conditions. If you detune above 500 Hz with ECSS set to ON, the ECSS circuit will automatically turn OFF.

Caution

1. Set the NOTCH control to OFF before using ECSS.
2. Make sure that the reception frequency is completely tuning before ECSS ON.
3. If the signal is extremely small, or fairly large fading is applied, ECSS may become unlocked, and beat may occur instantaneously.

⑬ AGC button

Use this button to turn AGC ON and OFF. Press this button once to turn AGC ON, and press it again to turn AGC OFF.

⑭ NOTCH control

Use this control for adjusting the notch filter. When the reception signals are subject to beat disturbance by continuous carrier signals or simple signals such as telegraph signals, press the NOTCH button ⑮, and adjust this control to beat disturbance until it is minimal.

Beat disturbance can be adjusted within the range ± 2.5 kHz in 10 Hz steps. When you press the NOTCH control again in this state, the red LED lights to indicate that notch tracking is functioning. While notch tracking is functioning, the notch filter will track within the range ± 10 kHz even if the MAIN TUNING dial is turned, and reception will be continued with the disturbance signals suppressed. If you detune above 10 kHz, the notch filter is automatically turned OFF.

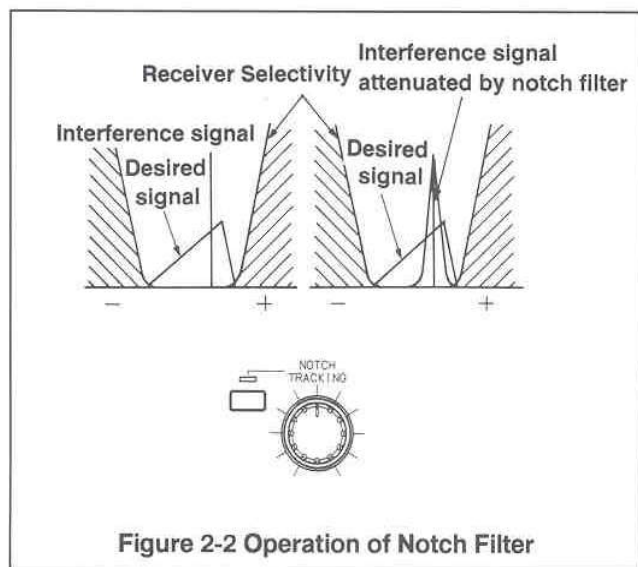

Figure 2-2 Operation of Notch Filter

⑮ RF GAIN control

Use this control to adjust the gain of the 1st-stage IF in the receiver and the gain of the IF stage in the DSP. Maximum gain is achieved when this control is turned clockwise as far as possible. Turning this control counterclockwise reduces gain. Normally, use the NRD-545 with this control turned clockwise as far as possible.

This control does not function in the WFM mode.

⑯ NOTCH button

Use this button to turn the notch filter and notch tracking ON and OFF. When you press this button once, the notch filter is turned ON, and the green LED lights. When you press it again, notch tracking is turned ON, and the red LED lights. When you press it again, the notch filter and notch tracking both are turned OFF, and the LEDs go out.

The NOTCH button does not function in the AMS mode.

Caution

When the notch filter is set to ON, reception noise may be distorted. Be sure to set the notch filter to OFF when the notch filter or notch tracking is not used.

⑰ SQ LEVEL (squelch level) control

Use this control to eliminate noise in a no-signal state. The further this control is turned to the right, the deeper the squelch level becomes. Squelch will not open unless the signal is stronger. If you turn this control to the left as far as possible, squelch remains open (squelch OFF) at all times, and sound will always be output from the speaker. The LED to the left of the control lights when squelch is closed.

Caution

Noise is not output from the speaker when squelch is closed.

⑱ NB LEVEL (NOISE BLANKER) control

Use this control to adjust the sensitivity of noise blanker operations. When there is a large amount of pulse-type noise, the noise can be reduced by turning the noise blanker ON by the NB button ⑳ and turning this control. Turning this control clockwise increases sensitivity and facilitates functioning of the noise blanker. Find the optimum level based on the reception conditions and the noise level.

Caution

Turning the NB LEVEL control clockwise too far may cause distortion in the desired signal.

19 RECORD jack

This jack is used to record reception content to a tape recorder. The output level is fixed regardless of the AF GAIN control ② setting. The output impedance is 600 Ohms.

20 PHONES (headphones) jack

This jack is used for headphone output. When headphones are used, output to the internal speaker and external speaker is turned OFF. This is a monaural jack that outputs the same signal as the LINE OUT R.

21 POWER switch

When the POWER switch is in the ON position, the power will turn ON and the NRD-545 will start operating. When the POWER switch is changed to the TIMER position the timer function will turn ON. Both the power and timer turn OFF when the POWER switch is moved to the OFF position.

22 NB (noise blanker) button

This button is for operating the noise blanker circuit. Each press of this button toggles the setting between NB1, NB2 and OFF.

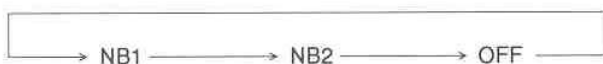

When this button is set to NB1, the green LED lights. When set to NB2, the red LED lights. NB1 is effective in blanking narrow width pulse noise such as ignition noise, and NB2 is effective in blanking wide width noise.

23 ATT (attenuator) button

Use this button to input the 20 dB radio frequency attenuator to the antenna input terminal. This option should be used if the desired signal is being blocked by a very strong interference signal. During attenuation, ATT on the LCD lights.

24 DIMMER button

Use this button to adjust the brightness of the LCD panel. Each press of this button toggles brightness between light and dark.

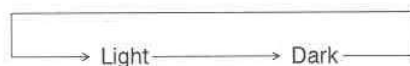

25 CLOCK button

This button switches between CLOCK, TIMER ON and TIMER OFF. Each press of this button toggles the setting between, CLOCK, TIMER ON and TIMER OFF.



To return the CLOCK, TIMER ON and TIMER OFF display to the frequency display, press either FREQ (frequency) button 34 or CH (channel) button 37.

26 FM/WFM button

Use this button to select the FM or WFM modes. Each press of this button toggles between the FM and WFM modes. The selected mode is displayed on the LCD.

The WFM mode can be selected only when the wideband converter unit CHE-199 (option) is mounted.

Caution

If you select the FM mode without the antenna connected, the amount of noise increased markedly compared with other modes.

27 NR/BC (noise reduction/beat canceler) button

Use this button to select noise reduction or the beat canceler. Each press of this button toggles the setting between noise reduction, beat canceler and OFF. When this button is set to noise reduction, the green LED lights. When it is set to the beat canceler, the red LED lights.

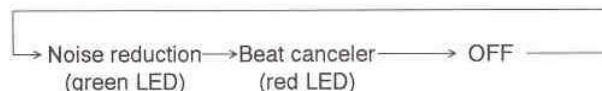

When noise reduction is activated, the voice signal spectrum is enhanced, random signals such as noise are attenuated, and signals buried in noise are made to stand out so that they are audible. How far noise reduction is activated can be adjusted in the user setup. For details, see 4.5.

When the beat canceler is activated, signals having perfect cyclic characteristics such as beat disturbance are canceled to attenuate the beat disturbance. How far the beat canceler is activated can be adjusted in the user setup. For details, see 4.5.

The NR/BC button does not function in the AMS, WFM modes and ECSS ON.

28 AM/AMS button

Use this button to select the AM or AMS mode. Each press of this button toggles between the AM and AMS modes. The selected mode is displayed on the LCD. Select the AMS mode to listen to AM broadcasts in hi-fi.

29 USB/LSB button

Use this button to select the USB or LSB mode. Each press of this button toggles between the USB and LSB modes. The selected mode is displayed on the LCD.

30 CW/RTTY button

Use this button to select the CW or RTTY mode. Each press

of this button toggles between the CW and RTTY modes. The selected mode is displayed on the LCD.

③① NARROW button

Use this button to select the narrow bandwidth of the digital IF filter. The selected bandwidth is displayed on the LCD. The default for the narrow bandwidth can be set for each mode. Set as follows:

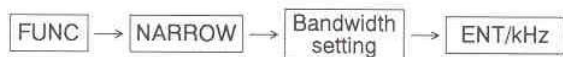

Defaults are as follows:

- CW, RTTY 0.5 kHz
- AM 2.4 kHz
- USB, LSB 1.8 kHz

Note: AMS, FM and WFM are fixed to WIDE.

③② INTER button

Use this button to select the intermediate bandwidth of the digital IF filter. The selected bandwidth is displayed on the LCD. The default for the narrow bandwidth can be set for each mode. Set as follows:



Defaults are as follows:

- CW, RTTY 1.0 kHz
- AM 4.5 kHz
- USB, LSB 2.4 kHz

Note: AMS, FM and WFM are fixed to WIDE.

③③ WIDE button

Use this button to select the wide bandwidth of the digital IF filter. The selected bandwidth is displayed on the LCD. The default for the narrow bandwidth can be set for each mode. Set as follows:

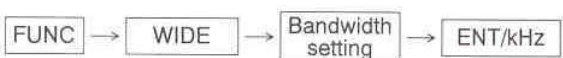

Defaults are as follows:

- CW, RTTY 2.4 kHz
- AM 6.0 kHz
- USB, LSB 2.7 kHz

Note: AMS, FM and WFM are fixed to the maximum value and can not be changed.

③④ FREQ button

When you press this button, the LED to its left lights, and you can set the frequency using the numerical keypad ③⑧. To return to channel setup, press this button again.

③⑤ LCD display

The NRD-545 uses a large-size liquid crystal display

(LCD):

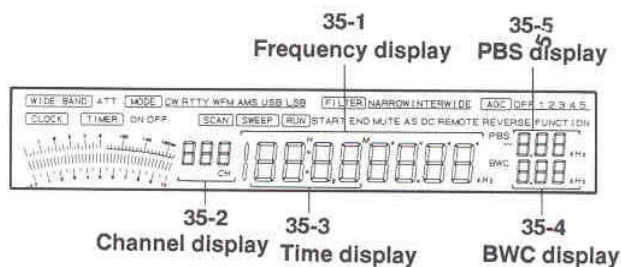

35-1 Frequency display: Displays the reception frequency

35-2 Channel display: Displays the memory channel number.

35-3 Time display: Displays the time and the timer ON/OFF times.

35-4 BWC display: Displays the bandwidth of the digital IF filter or the AGC discharge time constant.

35-5 PBS display: Displays the shift width of pass band shift.

WIDE BAND: Lights when the wideband converter unit CHE-199 (option) is mounted.

ATT: Lights when attenuator is ON.

MODE: Displays the mode. One of CW, RTTY, FM, WFM, AM, AMS, USB or LSB is lit. USB or LSB lights in addition to AM when ECSS is set to ON in the AM mode.

FILTER: Displays the bandwidth of the digital IF filter. One of NARROW, INTER and WIDE lights to indicate that it is selected.

AGC: Displays AGC. One of OFF, 1, 2, 3, 4 and 5 lights to indicate that it is selected. The relationship between indications 1 to 5 and the discharge time constant is as follows:

- 1: 0.04 to 1.48 seconds
- 2: 1.50 to 2.48 seconds
- 3: 2.50 to 3.48 seconds
- 4: 3.50 to 4.48 seconds
- 5: 4.50 to 5.10 seconds

CLOCK: Lights when the clock is displayed.

TIMER: Lights in the timer mode

TIMER ON: Lights when the timer ON time is displayed.

TIMER OFF: Lights when the timer OFF time is displayed.

SCAN START: Lights when the scan start channel is displayed.

SCAN END: Lights when the scan end channel is displayed.

SWEEP START: Lights when the sweep start frequency is displayed.

SWEEP END: Lights when the sweep end frequency is

displayed.

RUN: Lights while scan or sweep is being executed. Blinks when scan or sweep have been stopped.

MUTE: Lights when mute is applied. AF output is not possible when mute is applied.

AS: Lights when the receiver is set to the mode for automatically stopping scan or sweep by squelch operation. Blinks when scan or sweep has been automatically stopped by squelch operation.

DC: Lights when the receiver is running on a DC power supply.

REMOTE: Lights when the receiver is being remote-controlled by a personal computer via the RS-232C interface.

REVERSE: Lights when the polarity of demodulated signals is reversed when the RTTY signal is being received.

FUNCTION: Lights when the function (FUNC) keys are used for input.

SIGNAL (S) METER: The received signal strength is displayed on a scale of 1 to 9, +20 dB to +60 dB.

Hysteresis is provided at the S meter deflection boundaries.

The S meter can also be used for displaying peak hold or displaying level by movement of a single pointer in the user setup. For details, see 4.5.

Caution

S meter deflection is no longer normal when AGC is set to OFF.

②⑥ > UP, < DOWN button

These buttons function to increment and decrement the frequency when **FREQ** button ②④ is selected. When **CH** button ②① is selected, these buttons function to increment and decrement the channel. These buttons are auto repeaters. So, the frequency or channel is continuously incremented or decremented for the duration that these buttons are pressed.

②⑦ CH (channel) button

When you press this button, the LED to its right lights, and you can set the channel using numerical keypad ②⑧. To return to frequency setting, press this button again.

②⑧ Numerical keypad

The numerical keypad is used to set frequencies, channels,

clock, and the timer.

②⑨ FUNC (function) button

Use this button when you are using the function buttons for input. When you press this button, **FUNCTION** on the LCD lights. Use of function buttons is automatically canceled if no operation is carried out for 15 seconds after pressing this button.

Description of Function Buttons

(1) Setting user setup

Press the **FUNC** button and then **ENT/kHz** button ②④ to enter the user setup mode.

(2) Saving memory channels

Press the **FUNC** button and then **CH** button ②⑦ to enter the memory channel save/setup mode.

(3) Turning stereo reception ON/OFF in WFM mode

Press the **FUNC** button and then **FM/WFM** button ②⑥ to turn the WFM stereo mode ON and OFF.

In the stereo mode, **WFM** and **S** on the LCD light when stereo is detected. **S** blinks if stereo cannot be detected at this time.

(4) Setting the sleep timer time

Press the **FUNC** button and then **CLOCK** button ②⑤ to set up the sleep timer time.

(5) Transferring memory channel data to VFO

Press the **FUNC** button and then **FREQ** button ②④ to transfer the content of memory channels to VFO.

(6) Selecting BWC change step (10 Hz/100 Hz)

Press the **FUNC** button and then **BWC** button ② to alternately select the BWC change step.

②④ MHz button

Use this button to set the frequency in MHz steps using the numerical keypad ②⑧. Entered data is registered when you press this button.

②④ ENT/kHz button

Use this button to input the frequency in kHz steps, specify the channel and adjust the clock and the timer settings using the numerical keypad ②⑧. Press this button to enter the input data.

②② CLR (clear) button

If you make an entry error while entering frequency, channel, or time data using the numerical keypad ②⑧, press the **CLR** button to erase the entered data and restore the pre-entry settings.

④③ PBS (pass band shift) control

Use this button to change the center frequency of the digital IF filter within the range ± 2.3 kHz (in 50 Hz steps) with no apparent change in the reception frequency. This acts to push adjacent signals out of the signal band when the reception signals are being disturbed by adjacent signals. The degree of change is displayed on the LCD. In the USB mode, disturbance signals can be removed from the higher of the voice signals when this control is turned counterclockwise from the center position. Note that the high area of the desired signal will be cut off at this time. In the LSB mode, the reverse is true. This button does not function in the FM, WFM or AMS modes.

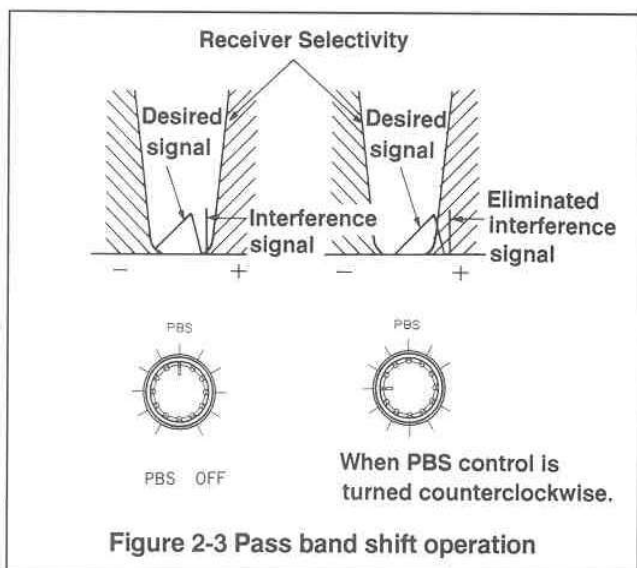

Caution

When there is no radio interference, operate the receiver with this control at the center (PBS OFF) position.

④④ FINE control

This control generates 24 pulses per turn. These pulses can change the memory channel, digital IF filter bandwidth, AGC discharge time constant, user setups, etc. Turning this control clockwise increases the amount proportional to the number of pulses, and turning it counterclockwise decreases the amount.

2.2 REAR PANEL

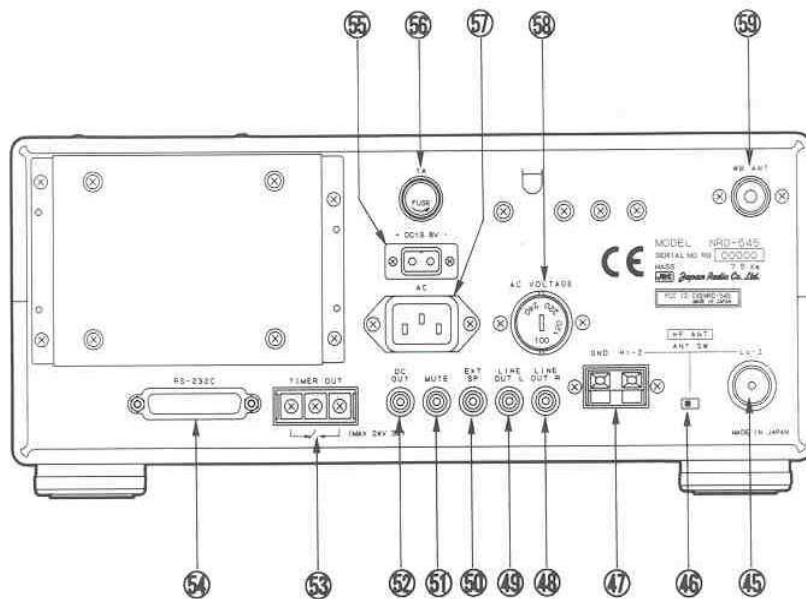

45 ANT Lo-Z (low impedance) connector

Use this connector to connect to an antenna of low (50 Ohms) impedance in the HF band.

To ensure optimum performance for the NRD-545, use the best possible antenna.

46 ANT SW (antenna switch)

Use this switch to select between low impedance (Lo-Z) antenna and high impedance (Hi-Z) antenna inputs. Slide the antenna switch to the antenna input in use.

47 ANT Hi-Z (high impedance) terminal

Use this terminal to connect a high-impedance terminal in the HF band.

48 LINE OUT R jack

This jack is for line output. The same signal as the signal currently output to the RECORD jack on the front panel is output from here.

49 LINE OUT L jack

This jack is for line output. Output from this jack is possible only during stereo reception in the WFM mode. In other modes, the same signal as LINE OUT R is output.

50 EXT SP (SPEAKER) jack

Use this jack to connect an external speaker.

This jack outputs the same signal as the LINE OUT R 48.

51 MUTE jack

Use this input terminal for controlling the mute circuit of the NRD-545 when it is used in combination with a transmitter. Grounding this terminal during transmission mutes (disabled AF output) the NRD-545.

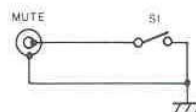

When S1 is closed (grounded), NRD-545 is muted.

52 DC OUT (DC output) jack

10.8 VDC is output from this jack. Permissible current is about 30 mA.

Caution

Use the pin plugs AR-568M (provided) in jacks 48 to 52.

53 TIMER OUT terminal

These are relay contacts for controlling externally connected equipment using the timer function.

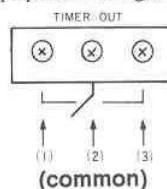

- When the timer is ON (NRD-545 power is ON), contacts (2) and (3) are connected.
- When the timer is OFF (NRD-545 power is OFF), contacts (1) and (2) are connected.
- Contact capacity is maximum 24 V, 3A.

Never connect this terminal to the AC power supply.

When the timer function is OFF with "2" in the user setup NO.13, relay contacts are connected in the following manner:

- When the squelch is open, contacts (2) and (3) are connected.

- When the squelch is closed, contacts (1) and (2) are connected.

⑤4 **RS-232C connector**

This connector allows the NRD-545 to be remotely controlled through a personal computer. Use the RS-232C cable (DSUB, 25-pin, male-male cross-connection) to connect the receiver to a personal computer.

⑤5 **DC POWER connector**

This connector is for connecting a DC power supply. Connect this connector to the DC power cord provided with this receiver. Be sure to provide a fuse (3A) on the power cord between the receiver and the power supply when using other power cords.

⑤6 **Fuse holder**

This holds the AC power fuse (1A).

⑤7 **AC POWER connector**

This connector is for connecting an AC power supply. Connect this connector to the AC power cord provided with this receiver.

⑤8 **Voltage selector**

Use this selector for selecting 100, 120, 220 and 240 VAC as the power supply voltage. (For details on how to select the power supply voltage, see 3.2.3.)

⑤9 **WB ANT (wideband antenna) connector**

Connect the antenna (impedance 50 Ohms) for wideband reception.

SECTION 3

INSTALLATION

3.1 INSTALLATION LOCATION

To ensure many years of optimum performance, place your NRD-545 in a well-ventilated area and avoid places that are exposed to direct sunlight, hot air from heaters, dust, vibration, or moisture. Also, allow sufficient space between the rear of NRD-545 and surrounding walls.

3.2 INSTALLING THE RECEIVER

Before operating the NRD-545, the following procedures should be followed. Connect the NRD-545 as shown in Figure 3-6.

3.2.1 ANTENNA CONNECTION

For optimum performance, an outdoor antenna should be used. Use a 50-Ohm antenna which is suitable for the reception frequency. Connect the antenna to the Lo-Z coaxial connector on the rear panel. (Switch the ANT SW to Lo-Z.)

If you are using 4-6 meters of vinyl-coated wire or similar as a simple antenna, connect the antenna to the Hi-Z antenna terminal on the rear panel. When using a simple antenna, be sure there is sufficient space between the antenna and noise sources such as computers.

To receive wideband frequencies above 30 MHz, use a wideband antenna (e.g. a wideband discone antenna) connected to the WB ANT connector ⑤⑨. (Note that reception is possible only when the wideband converter unit CHE-199 (option) is attached.)

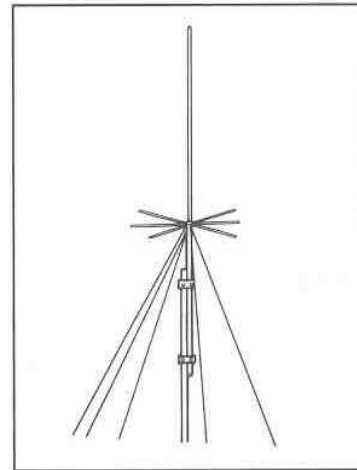
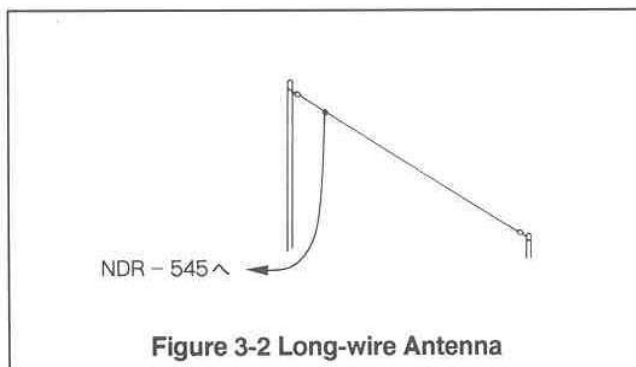
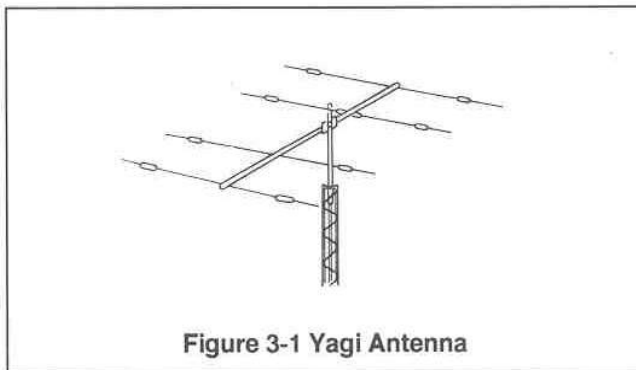

Figure 3-3 Wideband Discone Antenna

3.2.2 GROUNDING THE RECEIVER

Use the thickest possible copper wire as a ground line to prevent electrical shock and related hazards, and to reduce static interference from other equipment. Connect the ground to the GND terminal on the rear panel.

NOTE

Never connect the earth lead to gas or electrical wire piping. This is dangerous.

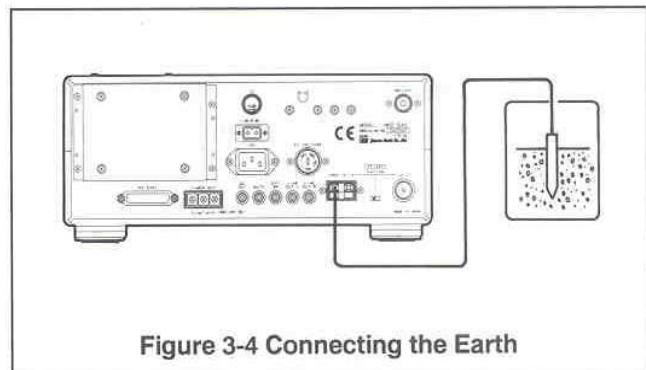

3.2.3 CONNECTING THE POWER

When you are operating the receiver on a AC power supply, connect the AC power cord (provided) to the AC POWER connector ⑤⑦ on the rear panel. Likewise, when you are operating the receiver on a DC power supply, connect the DC power cord (provided) to the DC (13.8 V) POWER connector ⑤⑤ on the rear panel.

The AC power supply that can be used as the receiver power supply is indicated on the packaging. Make sure that the voltage of the power supply in use matches the voltage value indicated on the voltage selector on the rear panel. If

you are operating the receiver on a different AC power voltage, select the voltage closest to one of 100, 120, 220 or 240 V, and set this voltage on the Voltage selector. Before you select the power voltage, first turn the POWER switch OFF, and then disconnect the power cord from the outlet. Make sure that the difference in voltages is within $\pm 10\%$ of the voltage value indicated on the Voltage selector.

Example: 117 V \rightarrow 120 V, 230V \rightarrow 240V

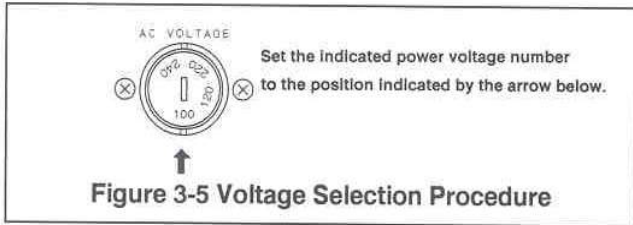

Caution

A minute current flows for clock backup even if POWER is set to OFF. Be sure to remove the power cord from the outlet when you are not using the receiver for a long period of time. (When the power cord is removed, the clock will not be backed up.) When using batteries as the main power source, be sure not to allow the battery to expire while connected power cord. (The backup DC is Approx. 3 mA.)

3.2.4 CONNECTING AN EXTERNAL SPEAKER

The NRD-545 has a built-in speaker. An external speaker can also be connected. We recommended using JRC's NVA-319 (option) as the external speaker.

In the WFM or AMS mode, AF is output also from the LINE OUT L jack. To listen to this output at a loud volume, connect a commercially available speaker with amplifier to this jack.

3.2.5 CONNECTING HEADPHONES

We recommend using JRC's ST-3 communication equipment headphones (option). If you plan to use headphones made by another manufacturer, make sure that the impedance is within 8 to 32 Ohms.

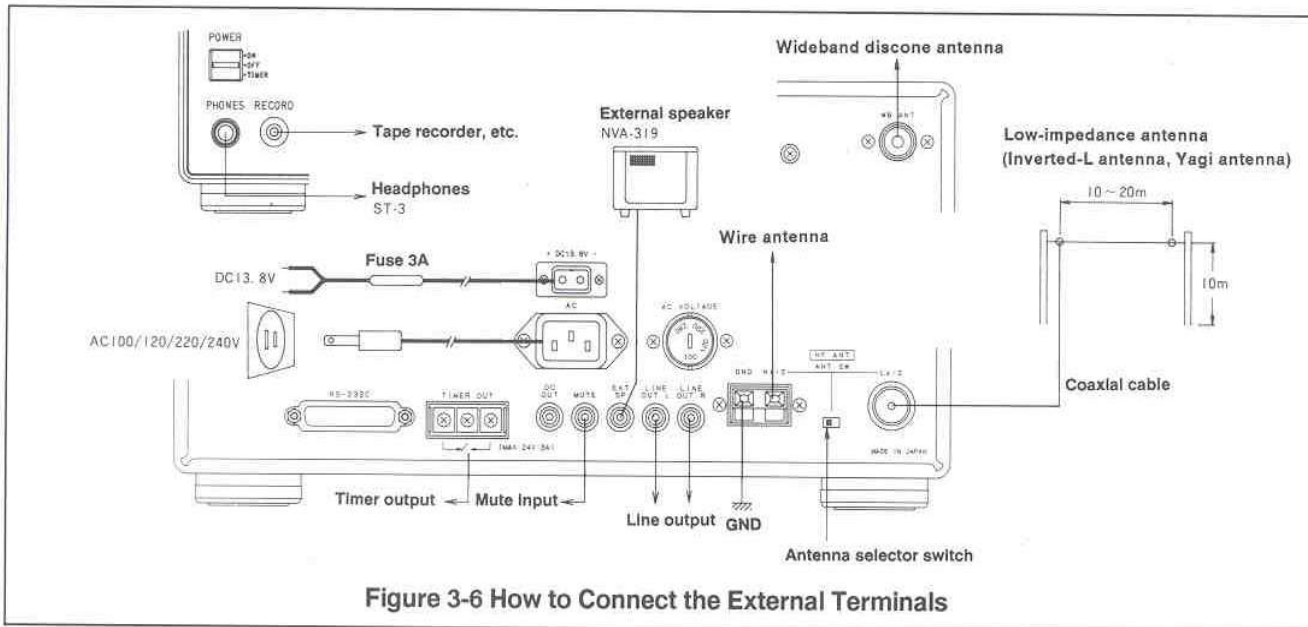

For the names of the various buttons and controls and descriptions of their functions, see Section 2 (OPERATING CONTROLS)

4.1 RECEIVING DIFFERENT TYPES OF SIGNALS

The following sections describe the basics of receiving signals with the NRD-545.

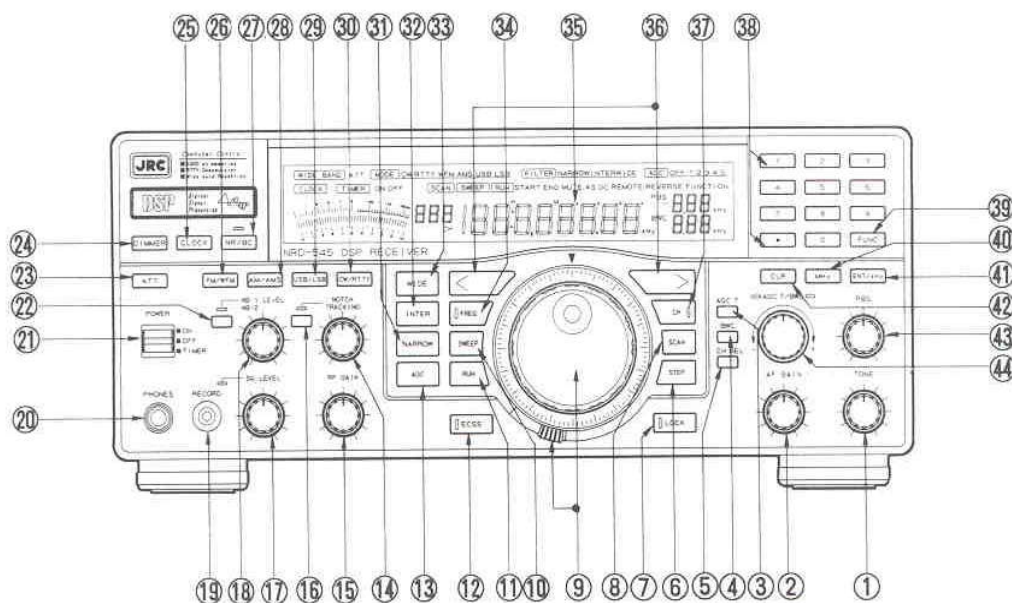

4.1.1 PRELIMINARY SETTINGS

After all antenna and power connections have been made, set the POWER switch to ON and set the receiver controls and buttons as described below.

- LOCK button (7): OFF
- AF GAIN control (2): Full counterclockwise position
- RF GAIN control (15): Full clockwise position
- TONE control (1): Center position
- SQ LEVEL control (17): Full counterclockwise position
- PBS control (43): Center position
- ATT button (23): OFF

4.1.2 SETTING THE FREQUENCY

There are three different ways to set the frequency of the NRD-545.

● Method 1: Using the MAIN TUNING DIAL (9)

The MAIN TUNING dial is capable of continuously tuning over the entire reception frequency range in 1 kHz, 100 Hz, 10 Hz and 1 Hz steps. When the MAIN TUNING dial is turned, the lower digit will be set to 0 Hz.

For example, when the setup is set to 100 Hz, the lower

digit of 10 Hz and 1 Hz is set to 0 Hz. Normally, the MAIN TUNING dial (9) is used to change frequencies within a single 1 MHz band.

● Method 2: Using the UP button (>) and DOWN button (<) (36)

Before you use these buttons, set FREQ button (34) to ON. The frequency can be continuously incremented or decremented at high speed at the step of the currently selected digit with the auto repeat function when the UP or DOWN buttons (36) are pressed. This method is useful when searching over a relatively wide range of frequencies.

● Method 3: Using the numerical keypad (38)

There are two different ways to enter frequency data through the numerical keypad. These methods differ according to the frequency unit (kHz or MHz). In the following example, a frequency of 12.3456 MHz is entered.

(1) If the unit is kHz, enter the following sequence:

[1] [2] [3] [4] [5] [.] [6] [ENT/kHz]

(2) If the unit is MHz, enter the following sequence:

[1] [2] [.] [3] [4] [5] [6] [MHz]

If you accidentally enter the wrong sequence, press the

CLR (clear) button ⑫ and then re-enter the frequency. The CLR (clear) button ⑫ can be used to clear the entered data and restore the pre-entry frequency as long as the ENT/kHz button ④① or MHz button ④② has not been pressed.

NOTE

The numerical keypad cannot be used to enter the 1 Hz digit. This digit is always set to 0 Hz.

Special Operation

Changing the Reception Frequency Range

Normally, tuning is set to receive from 100 kHz. However, if you turn the power ON with the ENT/kHz button ④① held down, tuning is possible from 10 kHz. Note that reception functions are not assured within the range 10 to 100 kHz. To return the turning start point to 100 kHz, repeat the same operation.

4.1.3 RECEIVING SSB SIGNALS

The frequency displays LSB and USB are both suppressed carrier frequencies.

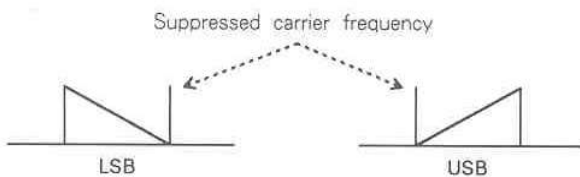

In addition to the settings described in section 4.1.1, set the following controls as described below.

USB/LSB button ⑳: Press to select USB or LSB mode
 INTER button ㉑: Press this button.
 AGC button ㉒: Press to select ON.
 AF GAIN control ㉓: Set the desired volume.
 Reception frequency: Set the desired frequency.

Slowly tune the MAIN TUNING dial ㉔ until the SSB signal can be clearly heard.

Special Operation

Selecting the Mode

Normally, the USB/LSB and CW/RTTY modes cannot be selected when you receive frequencies 30 MHz or higher with the wideband converter unit CHE-199 (option) mounted. You can select the USB/LSB and CW/RTTY modes by turning the power ON with the USB/LSB and CW/RTTY buttons held down. Though these modes can be selected, but reception functions are not assured. To reset the NRD-545, repeat the above operation.

4.1.4 RECEIVING CW SIGNALS

In addition to the settings described in section 4.1.1, set the following controls as described below.

CW/RTTY button ㉕: Press to select CW
 WIDE button ㉖: Press this button.
 AGC button ㉗: Press to select ON.
 AF GAIN control ㉘: Set the desired volume.
 Reception frequency: Set the desired frequency.

Use the MAIN TUNING dial ㉔ to make adjustments so that the CW signal is received and the AF (audio) output signal is set to approximately 800 Hz. (If the demodulated tone is at 800 Hz in CW mode, the local reception frequency and the remove transmission frequency will be zeroed in.) Normally, the offset frequency of BFO is set to +800 Hz. However, this frequency can be set freely within the range -2550 to +2550 Hz in 10 Hz steps. For details on how to set the frequency range, refer to item 4.5.

If you press the INTER button ㉑ or NARROW button ㉙ while signals are being received, the IF filter bandwidth narrows, and radio interference and noise are eliminated so that signals can be clearly received.

4.1.5 RECEIVING AM SIGNALS

In addition to the settings described in section 4.1.1, set the following controls as described below.

AM/AMS button ㉚: Press to select AM
 INTER button ㉑: Press this button.
 AGC button ㉒: Press to select ON.
 AF GAIN control ㉓: Set the desired volume.
 Reception frequency: Set the desired frequency.

If there is disturbance, press the ECSS button ㉛ to select whichever of the USB or LSB signals that is free from disturbance. To listen to medium-wave broadcasts in hi-fi, select AMS using the AM/AMS button ㉚. In the AMS mode, you cannot change the bandwidth of the IF filter.

In the AM/AMS modes, changing of the AGC discharge time constant is disabled.

4.1.6 RECEIVING RTTY SIGNALS

The frequency display is the center frequency between a mark signal and a space signal.

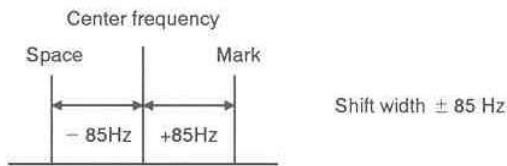

In addition to the settings described in section 4.1.1, set the following controls as described below.

- CW/RTTY button ⑩: Press to select RTTY
 INTER button ⑫: Press this button.
 AGC button ⑬: Press to select ON.
 AF GAIN control ②: Set the desired volume.
 Reception frequency: Set the desired frequency.
 TONE control ①: Center position

When the center frequency of the transmitted signal matches the reception frequency, the center frequency for AF (audio) output will be 2210 Hz.

Set as follows according to the type of RTTY signal:

- (1) Set the RTTY baud rate according to item 4.5. Set to 45.5 baud in the case of amateur radio.
(Set the display to 45.)
- (2) Set the RTTY shift width according to item 4.5. Set to 170 Hz baud in the case of amateur radio.
- (3) Set the RTTY polarity as described in 4.5. In the case of amateur radio, the mark frequency is the higher of the reception frequencies, and the space frequency is the lower. In the case of commercial use RTTY signals, the relationship between mark and space frequencies is inverted to that for amateur radio. (This conforms to standard ITU-R Rec. 246-3.) The NRD-545 takes the higher of the reception frequencies as the mark frequency and the lower as the space frequency.
Accordingly, set the RTTY polarity for amateur radio to "normal."
- (4) Set the output selection of the RTTY demodulation sign as described in 4.5. Set so that it is output to the personal computer on the RS-232C line.
- (5) When you have finished setting the above, receive RTTY signals, and turn the MAIN TUNING dial ⑨ so that the LED at AGC T above the FINE control ④ is brightest and lights red. At this time, make sure that the BWC LED also lights red. If it does not, the shift width of the RTTY signals currently being received may not be matching the preset shift width.
(When the AGC T or BWC green LED is lit, so, be

sure to set so that the green LED is out.)

- (6) Next, fine adjust the TONE control ① to the left and right of the center position, so that the BWC LED is brightest and lights red. (In the RTTY mode, the TONE control doubles as a fine-adjustment control for the RTTY demodulation filter. Turning this control changes the center frequency of the space filter for RTTY demodulation. Normally, set this control at the center position for use.)
- (7) The above operation demodulates RTTY signals and outputs the demodulated signal to the RS-232C line.
- (8) To display incoming signals on a personal computer via the RS-232C line, a control program is needed. The computer control software that we have provided you contains a control program.

4.1.7 RECEIVING FM SIGNALS

The frequency indication is the non-modulated carrier wave frequency.

Non-modulated carrier wave frequency (f_0)



In addition to the settings described in section 4.1.1, set the following controls as described below.

- FM/WFM button ⑧: Press to select FM
 AF GAIN control ②: Set the desired volume.
 Reception frequency: Set the desired frequency.

FM signals having a maximum frequency deviation of ± 5 kHz can be received. In the FM mode, selection of the IF filter bandwidth and changing of the AGC discharge time constant are disabled.

In the WFM mode, WFM signals having a frequency deviation of ± 250 kHz can be received. This mode can be selected only when the wideband converter unit CHE-199 (option) is mounted.

Special Operation

Stereo Reception in WFM Mode

The NRD-545 enters the stereo mode and S lights on the LCD if you press the **FUNC** and **WFM** button. S blinks if a stereo signal is not detected at this time. Repeat the above operation to reset the stereo mode.

4.2 MEMORY CHANNEL OPERATIONS

NRD-545 has 1,000 memory channels for saving frequency, mode, IF filter bandwidth, AGC, ATT and tuning step setups. The timer ON/OFF times can also be saved to memory channels 0 to 19. Setups saved to memory channel are backed up by a lithium cell.

4.2.1 SETTING MEMORY CHANNELS

To set a channel, press the CH button ⑳.

● Using the FINE control ㉔

Press the CH SEL button ㉑, and then turn the FINE control ㉔ to increment or decrement the channel until you reach the desired channel.

● Using the > UP, < DOWN button ㉒

Press these buttons to increment or decrement the channel until you reach the desired channel.

● Using the numerical keypad ㉓

In the following example, enter the following sequence to enter channel 999:

[9] [9] [9] [ENT/kHz]

If a channel that is not set to memory is entered, “-----” will be displayed on the frequency display on the LCD.

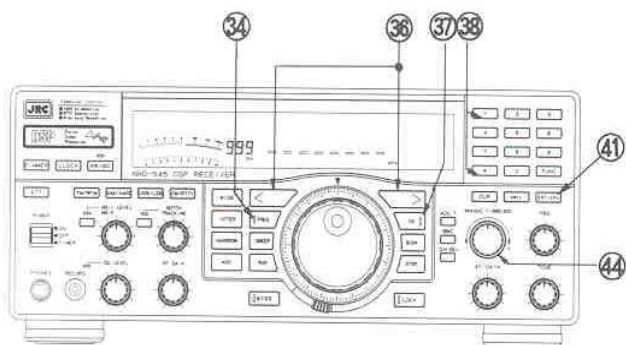

4.2.2 SAVING TO MEMORY

- Turn the FREQ (frequency) switch ⑳ ON.
- Set the frequency, mode, IF filter bandwidth, ATT, AGC, tuning step and timer ON/OFF time to save to a memory channel.
- Input the following on the numerical keypad to save to memory channel 001:

[FUNC] [CH] [0] [0] [1] [ENT/kHz]

This recalls the present setup in memory channel 001.

Then, press [ENT/kHz] ㉔ again to save the setup made in (2) above.

- Or, select a memory channel by using the FINE control ㉔ or by using UP and DOWN buttons ㉒ after pressing

[FUNC] [CH]. Then, press [ENT/kHz] ㉔ to save the setup in memory.

4.2.3 CHANGING MEMORY INFORMATION

- Set the CH (channel) button ㉑ to ON, and select the channel number.
- To make changes in the setting use, the MAIN TUNING dial to adjust the frequency, mode, IF filter bandwidth, ATT, AGC, tuning step or timer ON/OFF time.
- Press [FUNC] [CH] [ENT/kHz] to save the change to memory.
- Or, select the channel number by using the FINE control ㉔ or by using UP and DOWN buttons ㉒ after pressing [FUNC] [CH]. Then, press [ENT/kHz] ㉔ to save the change in memory. To make changes using the numerical keypad, follow the procedure for (3) in item 4.2.2.

4.2.4 ERASING MEMORY CHANNEL INFORMATION

In this example, enter the following to erase information for memory channel 999:

[FUNC] [CH] [9] [9] [9] [ENT/kHz] [CLR]

You can also erase information from memory channel even if you press the CLR button ㉕ after you have set the channel using the FINE control ㉔ or UP and DOWN buttons ㉒ after pressing [FUNC] [CH].

Special Operation

You can return memory channels and user setups to their defaults by turning the power ON with the CLR button ㉕ held down.

4.2.5 USING MEMORY CHANNELS FOR SIGNAL RECEPTION

Set the CH (channel) button ㉑ to ON, and set the desired channel number. When the channel number is set, the information saved to that memory channel is displayed on the LCD, and reception is possible in this state. You can also fine-adjust the frequency using the MAIN TUNING dial ⑨.

Special Operation

To transfer memory channel information to FREQ (VFO), press FUNC button ㉑ and then the FREQ button ㉒.

4.3 SCAN & SWEEP OPERATIONS

“Scanning” is a function for automatically scanning between specified channels. “Sweep” is a function for automatically scanning between specified frequencies.

4.3.1 CHECKING & SETTING THE SCAN START AND END CHANNELS

- **SCAN START:** Channel number at which scan is started by the scan function
- **SCAN END:** Channel number at which scan is ended by the scan function

Press the SCAN button (8) and select SCAN START and SCAN END. When SCAN START and SCAN END are selected, the previously set channel number and the information saved to that channel are displayed on the LCD, and reception is possible using that information.

To change a channel number, select SCAN START or SCAN END, and set the channel according to the description in "4.2.1 Setting the Channel." When the channel is changed, the newly set channel number and the information saved to that channel are displayed on the LCD, and reception is possible using that information.

NOTE

Channel between the SCAN START and SCAN END channels to which data has not been saved are skipped.

To cancel the SCAN mode, press any of CH, FREQ, SWEEP, CLOCK and CLR buttons as required.

4.3.2 CHECKING & SETTING THE SWEEP START AND END FREQUENCIES

- **SWEEP START:** Channel number at which sweep is started by the sweep function
- **SWEEP END:** Channel number at which sweep is ended by the sweep function

Press the SWEEP button (10) and select SWEEP START and SWEEP END. When SWEEP START and SWEEP END are selected, the previously set frequency is displayed on the LCD, and reception is possible at that frequency.

To change a frequency, select SWEEP START or SWEEP END, and set the frequency according to the description in "4.1.2 Setting the Frequency." When the frequency is changed, the newly set frequency is displayed on the LCD, and reception is possible at that frequency.

To cancel the SWEEP mode, press any of CH, FREQ, SWEEP, CLOCK and CLR buttons as required.

4.3.3 EXECUTING SCAN OR SWEEP (RUN)

If you press the RUN button (11) when the SCAN button (8) is pressed, and SCAN START or SCAN END is displayed, scanning is executed from the start channel number.

Alternatively, if you press the RUN button (11) when the SWEEP button (10) is pressed, and SWEEP START or SWEEP END is displayed, the sweep is executed from the

start frequency. The frequency step of the sweep is the same as the step selected on the MAIN TUNING DIAL (9).

When the RUN button (11) is pressed, the letters "RUN" light on LCD, and the letters "START" or "END" disappear.

To pause a scan or sweep, press the RUN button (11) again. During a pause, the "RUN" display blinks. To resume the scan or sweep, press the RUN button (11) again. The scan or sweep is resumed from the channel number where the scan or sweep was stopped.

The scan speed can be set to within the range 0.3 to 5 seconds/channel, and the sweep speed to within 0.05 to 0.5 seconds/step. For details on how to set these speeds, see "4.5 Modifying Operations by User Setup."

If you press a key on the numerical keypad during scanning that corresponds to a group that you want to scan, scanning is carried out within the group that you specified. For example, if you enter "0", channel 0 and 49 are set as the SCAN START and SCAN END, respectively.

Table 4-1 shows the correspondence between channel numbers assigned to a group and the key on the numerical keypad for entering that group.

However, when all the channel numbers are not registered in a group, memory scanning terminates when that group number is selected.

Table 4-1 Group Channel List

Group	Channel numbers	Numerical Keypad Keys to Enter
1	0~49	0
2	50~99	1
3	100~149	2
4	150~199	3
5	200~249	4
6	250~299	5
7	300~349	6
8	350~399	7
9	400~449	8
10	450~499	9
11	500~549	FUNC+0
12	550~599	FUNC+1
13	600~649	FUNC+2
14	650~699	FUNC+3
15	700~749	FUNC+4
16	750~799	FUNC+5
17	800~849	FUNC+6
18	850~899	FUNC+7
19	900~949	FUNC+8
20	950~999	FUNC+9

If you press a key on the numerical keypad during a sweep that corresponds to a group that you want to sweep, the sweep is carried out within the group that you specified.

Table 4-2 Group Sweep List

Group	START Frequency	END Frequency	Step	Bandwidth	Mode
0	2.300MHz	2.495MHz	100Hz	WIDE	AM
1	3.900MHz	4.000MHz	100Hz	WIDE	AM
2	4.750MHz	5.060MHz	100Hz	WIDE	AM
3	5.950MHz	6.200MHz	100Hz	WIDE	AM
4	7.100MHz	7.300MHz	100Hz	WIDE	AM
5	9.500MHz	9.900MHz	100Hz	WIDE	AM
6	11.650MHz	12.050MHz	100Hz	WIDE	AM
7	13.600MHz	13.800MHz	100Hz	WIDE	AM
8	15.100MHz	15.600MHz	100Hz	WIDE	AM
9	17.550MHz	17.900MHz	100Hz	WIDE	AM

Table 4-2 shows the correspondence between sweep frequencies assigned to a group and the key on the numerical keypad for entering that group. You can also change the setups in Table 4-2.

How to Change the Setup

- (1) Press the SWEEP button ⑩.
- (2) Press the CH SEL button ⑤. "-" or the group number is displayed in the BWC display area. When you enter a group number (0 to 9) whose setup you want to change on the numerical keypad, the indicated group number lights.
- (3) Enter the START frequency, and press ENT/kHz button ④.
- (4) Enter the END frequency, and press ENT/kHz button ④.
- (5) Set tuning step, bandwidth and mode, and press ENT/kHz button ④.

If signals are received during a scan or sweep and squelch opens when the AS (auto stop) function is set to ON, the scan or sweep is automatically paused. This pause time can be set to within 0 to 10 seconds. The scan or sweep is resumed when the preset pause time has elapsed. (However, scan or sweep remains paused when the pause time is set at 0 sec. while the squelch is open.) The AS display blinks during the pause. For details on how to set the AS function and the pause time, see "4.5 Modifying Operations by User Setup."

NOTE

During a scan or sweep, BWC and ECSS do not operate.

4.4 CLOCK & TIMER OPERATIONS

The NRD-545 has a built-in clock and timer function. This function allows you to turn the NRD-545 ON and OFF at preset times. Relay contacts for simultaneously controlling external equipment are also output to TIMER OUT terminal ⑤③ of the rear panel.

4.4.1 DISPLAYING AND SETTING THE TIME

- CLOCK (TIME): Time such as LOCAL time
- TIMER ON: Time that the receiver power turns ON by the timer function
- TIMER OFF: Time that the receiver power turns OFF by the timer function

Press the CLOCK button ⑳ to select one of CLOCK, TIMER ON and TIMER OFF. When one of these is selected, the selected time is displayed on the LCD. Though the reception frequency is not displayed at this time, reception at the frequency that was set before the CLOCK button ⑳ was pressed is possible. Also, note that the reception frequency cannot be changed.

To change the time, select the time type with the CLOCK button ⑳, and enter the time using the numerical keypad.

For example, to set the correct time 13:23 (hours: minutes), enter as follows:

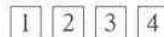

Then, press the ENT/kHz button ④. During entry of the time, the time display blinks.

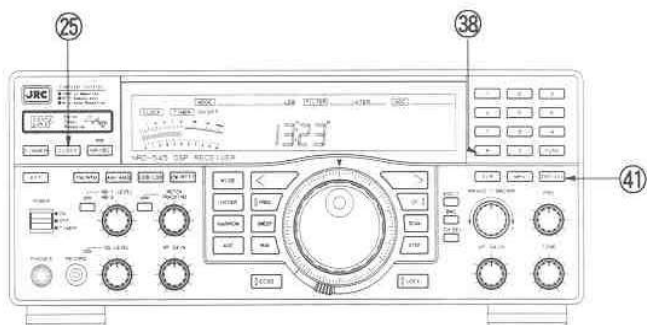

When the time is displayed, blinking of the colon ":" for delimiting hours and minutes on the LCD can be stopped. For details on how to set this, see "4.5 Modifying Operations by User Setup."

Special Operation

You can display the second digit by turning the power ON with the CLOCK button (25) and the ENT/kHz button (41) held down simultaneously. To cancel display, repeat the above operation.

4.4.2 ADJUSTING THE CLOCK SECOND SETTING

Press the CLOCK button (25), and select CLOCK. If you press [•] button (38), the colon ":" blinks at high speed. If you set the exact time, for example, matched to a radio time signal, and press the ENT/kHz button (41), the second digit is set to "00".

4.4.3 USING THE TIMER FUNCTION

21 timers, FREQ (VFO) and memory channels 0 to 19, can be set.

The example used for the timer function assumes that reserved recording is carried out under the following conditions:

Reception frequency: 12.3456 MHz

Recording time: From 19:10 to 20:20 LOCAL time

First, connect a tape recorder to the NRD-545 as shown in the Figure 4-1.

● Setting procedure

1. Set the CLOCK time to LOCAL time.
2. Set the TIMER ON time to 19:10.
3. Set the TIMER OFF time to 20:20.
4. Set the reception frequency to 12.3456 MHz.
Set the mode, IF filter bandwidth and ATT if necessary.
5. Set the POWER switch (15) to the TIMER position. The timer function is started at this moment. The CLOCK time is only displayed on the LCD for about 15 seconds, and then the time display in the LCD disappears. (To resume the time display, press the CLOCK button and the time will be displayed for another 15 seconds.)
6. This completes the operation.

When the timer ON time 19:10 is reached, the NRD-545 turns ON, the reception frequency, mode, bandwidth, AGC and ATT information that were set above are displayed on the LCD, and recording at that reception frequency is started. When the timer OFF time 20:20 is reached, the NRD-545 turns OFF and recording stops.

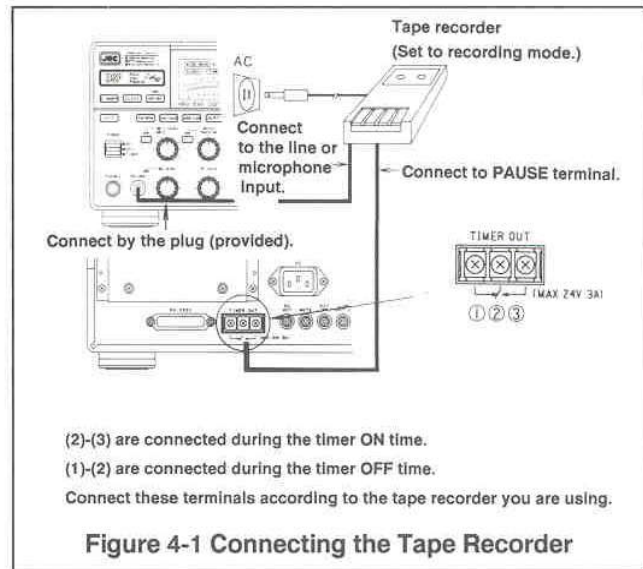

4.4.4 SAVING THE TIMER TIMES TO MEMORY CHANNEL

You can save timer ON/OFF times and memory channels 0 to 19 to turn each channel ON and OFF at the timer times saved to memory channel. Timer ON/OFF times cannot be saved to memory channels 20 to 999. (Note that operations on these channels are possible using the FREQ (VFO) timer.)

When the preset timer ON time is reached, the NRD-545 turns ON, and reception is started at the selected channel.

(The timer does not function without channel memory presetting.)

● Setting procedure

1. Select the desired channel to save information to.
2. Set the TIMER ON time.
3. Set the TIMER OFF time.
4. Set the POWER button to the TIMER position.
5. This completes the operation.

Different times can be set to each of memory channels 0 to 19.

When the preset timer ON time is reached, the NRD-545 turns ON, and reception is started at the selected channel.

Caution

While the timer is operating, no change can be made to the CLOCK, TIMER ON, and TIMER OFF settings. Moreover, only the TIMER ON/OFF times can be displayed in the LCD.

4.4.5 SLEEP TIMER OPERATIONS

When the time specified by the sleep timer has elapsed, the NRD-545 automatically turns OFF. The sleep timer time can be set to within the range 0 to 180 minutes.

● Setting procedure

1. Press the **FUNC** and **CLOCK** keys in that order.
2. Enter **1 8 0** on the numerical keypad, and press the ENT/kHz button **(4)**. (This sets "180".)
3. Set the POWER switch to the TIMER position.
4. This completes the operation.

The NRD-545 overrides the TIMER ON setting (see section 4.4.3) and turns the power OFF when the sleep timer reaches 0 min (OFF).

4.5 MODIFYING OPERATIONS BY USER SETUP

The user can change the setup (user setup) of some operations. Follow the procedures below to modify operations by user setup:

(1) Call up the user setup mode.

To enter the user setup mode, press the **FUNC** and **ENT/kHz** buttons, in that order.

The user setup number is displayed blinking on the LCD channel display (35-2), and the user setup information is displayed on the frequency display (35-1).

(2) Select the user setup number.

You can change the user setup number displayed blinking on the LCD channel display (35-2) by turning the FINE control **(4)**. Change the user setup. Select the desired number, and press the ENT/kHz button **(4)** to register the number. Next, the number of the user setup information on the frequency display (35-1) blinks.

(3) Change the user step number.

The user setup information on the frequency display is blinking. Change the information by turning the FINE control **(4)**. For details on user setup information, see Table 4-3.

(4) Register the user setup.

To register the new user setup information that you made in step (3), press the ENT/kHz button **(4)**.

The user setup number on the channel display blinks again. To set other items, repeat steps (2) onwards. If you have no other items to setup, press the CLR button **(4)** to quit the user setup mode.

Special Operation

You can return user setups to their defaults by turning the power ON with the CLR button **(4)** and CH button **(3)** held down. User setups saved to memory channels are held as they are.

Table 4-3 List of User Setups

* Default

Number	Item	Description	Setting
1	1 Hz tuning (frequency less than 30 MHz)	0: 1 Hz not added to tuning step 1: 1 Hz added to tuning step	*
2	10 kHz tuning (frequency less than 30 MHz)	0: 10 kHz not added to tuning step 1: 10 kHz added to tuning step	*
3	1 kHz tuning (frequency less than 30 MHz)	0: 1 kHz tuning step 1: 5 kHz tuning step 2: 6.25 kHz tuning step 3: 9 kHz tuning step	*
4	100 Hz tuning (FM, AM frequency 30 MHz or more)	0: 100 Hz not added to tuning step 1: 100 Hz added to tuning step	*
5	5 kHz tuning (frequency 30 MHz or more)	0: 5 kHz tuning step 1: 6.25 kHz tuning step 2: 9 kHz tuning step	*
6	10 kHz tuning	0: 10 kHz tuning step 1: 12.5 kHz tuning step 2: 20 kHz tuning step 3: 25 kHz tuning step 4: 30 kHz tuning step 5: 50 kHz tuning step	*
7	Automatic selection of tuning step (frequency 30 MHz or more)	0: OFF 1: ON	*
8	Number of pulses of MAIN TUNING dial	0: 1000 pulses/turn 1: 500 pulses/turn 2: 250 pulses/turn	*
9	S METER indication	0: Single display 1: Bar display 2: Peak hold display	*
10	Beep tone	0: OFF 1: ON	*
11	Scan auto stop	0: OFF 1: ON	*
12	Unwritten channel skip	0: OFF during scanning 1: ON during scanning	*
13	Timer relay operation	0: OFF at all times 1: ON at all times 2: Proportionate to squelch	*
14	BFO offset frequency	-2550 Hz to +2550 Hz (10 Hz steps) + 800 Hz	*
15	RTTY baud rate	37 to 75 baud 45 baud (45.45 baud)	*
16	RTTY shift width	170Hz 425Hz 850Hz	*
17	RTTY polarity	0: Reverse 1: Normal	*
18	SSB display frequency	0: Display shift 1: Local shift	*
19	Blinking colon in time display	0: OFF 1: ON	*
20	Scan time	0.3 to 5 seconds/channel 0.5 seconds/channel	*
21	Sweep time	0.05 seconds/step~ 0.5 seconds/step 0.05 seconds/step	*
22	Scan auto stop time	0: 0 to 10 seconds (0.5 second step) 1: 3 seconds	*
23	RTTY demodulation signal output	0: OFF 1: ON	*
24	Input tuning circuit	0: Pass 1: Use	*
25	RTTY unshift on space	0: OFF 1: ON	*

Table 4-3 shows a list of user setups.

Table 4-3 (continued)

Number	Item	Description	Setting
26	RTTY error display	0: Space display 1: * display	*
27	Filter hold of Noise reduction	0: ON 1: OFF	*
28	Panel lock	0: MAIN TUNING dial locked 1: All dials and buttons locked	*
29	Noise reduction function	0.0000 (effect) to 0.0255 (not effect) 0.0050	*
30	Beat canceler function	0.0000 (not effect) to 0.0255 (effect) 0.0020	*
31	Change squelch LED lighting	0: Lights when squelch is closed 1: Lights when squelch is open	*
32	Digital IF filter attenuation slope	0: SHARP 1: LOOSE	*

If you set user setup 7 to "1" (automatic selection of tuning step ON), the frequency step is automatically selected as shown in Table 4-4 at reception frequencies 30 MHz or higher.

Table 4-4 Automatic Frequency Step Selection List

Frequency	Step	Frequency	Step
30~ 50MHz	10kHz	170~ 225MHz	50kHz
50~ 54MHz	20kHz	225~ 430MHz	12.5kHz
54~ 76MHz	10kHz	430~ 450MHz	20kHz
76~108MHz	50kHz	450~ 470MHz	12.5kHz
108~142MHz	25kHz	470~ 770MHz	50kHz
142~144MHz	10kHz	770~1000MHz	12.5kHz
144~146MHz	20kHz	1000~2000MHz	20kHz
146~170MHz	10kHz		

4.6 OPERATING THE NRD-545 FROM A PERSONAL COMPUTER

The NRD-545 is standard-equipped with an RS-232C interface. This allows various controls to be performed from a personal computer.

Use the 6ZCJDO0350 RS-232C cable (option) to connect your computer with the NRD-545. Use a commercially available RS-232C cable (cross connection, DSUB-25 pin connector, male-male connector).

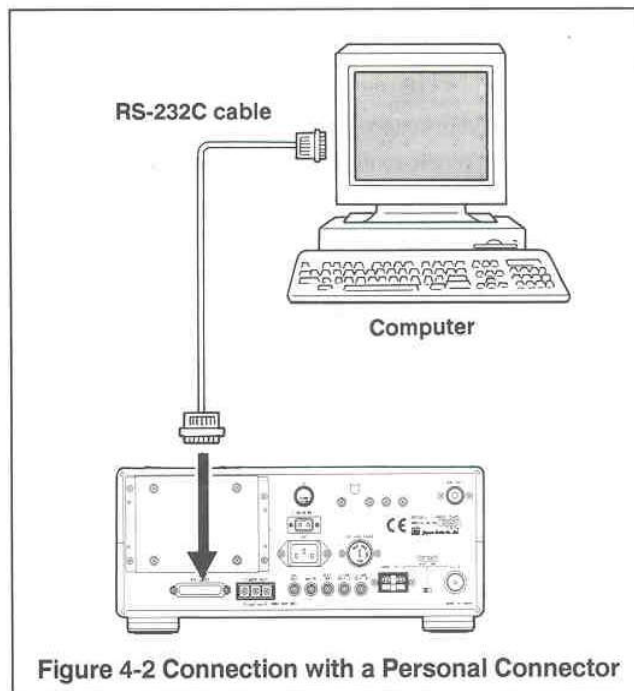

Figure 4-2 Connection with a Personal Connector

4.6.1 Setup

The first step is to enter communication parameters for the computer.

Enter the following terminal parameter settings.

Communication rate: 4800 bps

Data length: 8 bits

Stop bit: 1 bit

Parity: None

X parameter: None

This completes the preparations for computer-based control of the NRD-545.

4.6.2 Description of control commands

The format of commands for controlling the NRD-545 is as follows:

Enter one or two alphabet characters as the control item.

Though the length of the control item varies according to the control item, use numbers 0 to 9. "CR" stands for Carriage Return, and is used as the delimiter. The following describes each of the items.

To remote control the NRD-545 from a personal computer, first issue the "H1" command to set computer control ON. When control is ON, REMOTE on LCD ⑤ and the LED for the LOCK button ⑦ light, and all buttons and dials (excluding the POWER switch) are electrically locked.

To restore operations on the NRD-545 front panel, issue the "H0" command. Computer control of the NRD-545 can be turned OFF even when the POWER switch on the NRD-545 is turned OFF. The current status is reported when

the "H" command is issued.

● "H": Turning computer control ON/OFF

Command	Description
"H"CR	Status report "H0" CR or "H1" CR
"H0"CR	Computer control is turned OFF.
"H1"CR	Computer control is turned ON.

● "A": Set ATT

Command	Description
"A0"CR	ATT OFF
"A1"CR	ATT ON

● "B": Set IF bandwidth

Command	Description
"B0"CR	WIDE
"B1"CR	INTER
"B2"CR	NARROW

● "C": Set memory channel and automatic response

Command	Description
"C000"CR	Set channel 0
"C999"CR	Set channel 999

Automatic response from receiver

Response	Description
"C000"CR	Written to channel 0
"C999V"CR	Not written to channel 999

● "D": Set mode

Command	Description
"D0"CR	RTTY
"D1"CR	CW
"D2"CR	USB
"D3"CR	LSB
"D4"CR	AM
"D5"CR	FM
"D6"CR	AMS
"D7"CR	ECSS – USB
"D8"CR	ECSS – LSB
"D9"CR	WFM

● "E": Write to channel

Command	Description
"E1"CR	Write to channel

When command "E1" is send after the status of the selected channel is changed by a command, the information of the channel is written to memory channel.

● "F": Set frequency

Command	Description
"F"CR	Current status report
"F0000100000"CR	Set to 100 kHz
"F1999999999"CR	Set to 1999999.999 kHz

● "G": Set AGC

Command	Description
"G0"CR	ON(1S)
"G1"CR	ON(100mS)
"G2"CR	OFF
"G3ccc"CR	ON (Time = ccc x 20 mS) ccc: 002

● "I": Turn receiver setup status output ON and OFF

Command	Description
"I"CR	Output ON (output only once)
"I0"CR	Output OFF
"I1"CR	Output ON (output continuously)

This command is functional even if command "H1" is not sent.

When output is set to ON, REMOTE on the NRD-545 LCD lights, and the setup status is output to the personal computer in the following format.

Output	Description
"Iabdfg"CR	Settings output

I: Header code

a: Attenuator, 1 digit (0, 1)

b: IF Bandwidth, 1 digit (0 to 2)

d: Mode, 1 digit (0 to 9)

f: Reception frequency, 10 digit (0000100000 to 1999999999)

g: AGC, 3 digit (002 to 255) 255 x 20 mS = time

If the settings on the panel are changed while output is ON, the changes are output to the computer in the format shown above. When output is turned OFF, REMOTE on the NRD-545 LCD turns OFF. Output is also turned off if the POWER switch is turned OFF.

● "J": Write to channel

Output	Description
"Jlccc"CR	Write to channel

ccc: channel numbers (000 to 999)

The status indicated on the LCD is written to channel ccc. The LCD channel number does not change even if data is written.

● "K": Set channel data

The LCD display does not change even if channel data is set.

Command	Description
"Kcccabdfg"CR	Sets the channel data

K: Header code

ccc: Channel No. (000 to 999)

a: Attenuator, 1 digit (0, 1)

b: IF bandwidth 1 digit (0 to 2)

d: Mode, 1 digit (0 to 9)

f: Reception frequency, 10 digit (0000100000 to 1999999999)

g: AGC, 3 digit (002 to 255) 255 x 20 mS = time

● "L": Read channel data

Command	Description
"L"CR	"Lcccabdfg"CR
"Lsssee"CR	"Lsscabdfg"CR~"Leecabdfg"CR

ccc: Current channel

sss: Reading-start channel number

nnn: Intermediate channel number

eee: Reading-end channel number

The format of the data that is output from NRD-545 is as follows:

Output	Description
"Lsscabdfg"CR	Reading-start channel number
"Lnnabdfg"CR	Intermediate channel number
"Leecabdfg"CR	Reading-end channel number

L: Header code

a: Attenuator, 1 digit (0, 1)

b: IF bandwidth (0 to 2)

d: Mode, 1 digit (0 to 9)

f: Reception frequency, 10 digit (0000100000 to 1999999999)

g: AGC, 3 digit (002 to 255) 255 x 20 mS = time

21 characters can be assigned to each channel. This means

that the total amount of data that can be read from all channels is 21,000 characters (21 x 1,000). The time this takes is about 44 seconds (21,000 x 10/4800).

If an attempt is made to read a channel to which data has not been written, "V" is output to the attenuator position. (Example: "L999V"CR)

● "M": Output S meter information

Command	Description
"M"CR	Output ON

Output to computer in 256 steps.

Output	Description
"M000"CR	Minimum meter deflection
"M255"CR	Maximum meter deflection
"Mnnn"CR	nnn: 000~255

● "N": Enter a noise blanker setting

Command	Description
"N"CR	Current status report "Nn"CR n: 0, 1, 2
"N0"CR	NB OFF
"N1"CR	NB1
"N2"CR	NB2

● "O": Turn timer relay ON/OFF

Command	Description
"O0"CR	Timer relay OFF
"O1"CR	Timer relay ON

This setting is valid when the POWER switch is at the ON position, and invalid when it is at the TIMER position. When the POWER switch is OFF, the timer relay enters the operation mode that is set in the user setup.

● "P": Set the PBS frequency

Command	Description
"P"CR	Current status report "P-2200"CR
"P - 220"CR	Set PBS to -2200 Hz.
"Psnm"CR	s: +, - nnn: 000~255

● “Q”: Request output of squelch status

Command	Description
“Q”CR	Request output of squelch status

The format of the data that is output from NRD-545 is as follows:

Output	Description
“Q0”CR	Squelch is open.
“Q1”CR	Squelch is closed.

● “R”: Reading of time and change time

Command	Description
“R0”CR	Request reading of time
“R1hhmm”CR	Change time
“R2hhmm”CR	Set timer ON time
“R3hhmm”CR	Set timer OFF time
“R4”CR	Display current time
“R5”CR	Display timer ON time
“R6”CR	Display timer OFF time
“R7”CR	Display frequency

Though the second digit is not set when the time is changed, it is automatically set to “0”.

The time is output in the following format from the NRD-545 in response to the time read request.

Output	Description
“Rhhmmss”CR	Time data

R: Header code

hh: hours (00 to 23)

mm: minutes (00 to 59)

ss: seconds (00 to 59)

(Note) R5 and R6 are not output in seconds (ss).

● “S”: Set channel data

Once channel data is set, the LCD is updated with the new settings.

Command	Description
“Sccabdfg”CR	Set channel data

S: Header code

ccc: Channel number (000 to 999)

a: Attenuator, 1 digit (0, 1)

b: IF bandwidth 1 digit (0 to 2)

d: Mode, 1 digit (0 to 9)

f: Reception frequency, 10 digit (0000100000 to 1999999999)

g: AGC, 3 digit (002 to 255) 255 x 20 mS = time

● “T”: Turn power supply (10.8 V) for analog circuit ON/OFF

Command	Description
“T0”CR	10.8 V OFF (standby)
“T1”CR	10.8 V ON (during operation)

● “U”: Set user setup (For details, see Table 4-3.)

Command	Description
“U010”CR	1 Hz not added to tuning step
“U011”CR	1 Hz added to tuning step
“U020”CR	10 Hz not added to tuning step
“U021”CR	10 Hz added to tuning step
“U030”CR	1 kHz tuning step
“U031”CR	5 kHz tuning step
“U032”CR	6.25 kHz tuning step
“U033”CR	9 kHz tuning step
“U040”CR	100 Hz not added to tuning step
“U041”CR	100 Hz added to tuning step
“U050”CR	5 kHz tuning step
“U051”CR	6.25 kHz tuning step
“U052”CR	9 kHz tuning step
“U060”CR	10 kHz tuning step
“U061”CR	12.5 kHz tuning step
“U062”CR	20 kHz tuning step
“U063”CR	25 kHz tuning step
“U064”CR	30 kHz tuning step
“U065”CR	50 kHz tuning step
“U070”CR	Automatic selection of tuning step OFF
“U071”CR	Automatic selection of tuning step ON
“U080”CR	1000 pulses/turn
“U081”CR	500 pulses/turn
“U082”CR	250 pulses/turn
“U090”CR	Single display
“U091”CR	Bar display
“U092”CR	Peak hold display
“U100”CR	Beep tone OFF
“U101”CR	Beep tone ON
“U110”CR	Scan auto stop OFF
“U111”CR	Scan auto stop ON
“U120”CR	Skip OFF during scanning
“U121”CR	Skip ON during scanning
“U130”CR	OFF at all times
“U131”CR	ON at all times
“U132”CR	Proportionate to squelch
“U14snnnn”CR	BFO offset frequency s: +or - nnnn: 0000~2550

Command	Description
"U15brsp"CR	RTTY demodulation mode Baud rate = 37 to 75 br: 37 to 75 s: Shift width (0 to 2) p: Polarity (0, 1)
"U16n"CR	RTTY shift width n:0, 1, 2 0:170Hz、1:425Hz、2:850Hz
"U170"CR	RTTY polarity Reverse
"U171"CR	RTTY polarity Normal
"U180"CR	Display shift
"U181"CR	Local shift
"U190"CR	Colon blinking OFF
"U191"CR	Colon blinking ON
"U20nn"CR	Scan time nn:03~50 03(0.3秒)~50(5.0秒)
"U21nnn"CR	Sweep time nnn: 005 to 050 005 (0.05 seconds) to 050 (0.50 seconds)
"U22nnn"CR	Scan auto stop time nnn: 000 to 100 000 to 100 (10 seconds): 000=∞
"U230"CR	Demodulation code output OFF
"U231"CR	Demodulation code output ON
"U240"CR	Input tuning circuit Pass
"U241"CR	Input tuning circuit Use
"U250"CR	Unshift on space OFF
"U251"CR	Unshift on space ON
"U260"CR	Space display
"U261"CR	* display
"U270"CR	Filter hold of Noise reduction ON
"U271"CR	Filter hold of Noise reduction OFF
"U280"CR	MAIN TUNING dial locked
"U281"CR	All dials and buttons locked
"U29nnn"CR	Change effect of noise redaceion nnn: 000 to 255
"U30nnn"CR	Change effect of beat canceler nnn: 000 to 255
"U310"CR	Lights when squelch is closed
"U311"CR	Lights when squelch is open
"U320"CR	SHARP
"U321"CR	LOOSE

● "V": Set tuning step

Command	Description
"V"CR	Current status report "Vn"CR n: 0, 1, 2, 3, 4, 5
"V0"CR	1Hz
"V1"CR	10Hz
"V2"CR	100Hz
"V3"CR	1kHz
"V4"CR	10kHz
"V5"CR	100kHz

● "W": Set BWC

Command	Description
"W"CR	Current status report "Wnnnn"CR (nnnn: 0010 to 9990)
"W+"CR	Maximum (9.99 kHz)
"W - "CR	Minimum (10 Hz)
"Wnnn"CR	Setting (nnn: 000 to 999)

● "Y": Increment/decrement frequency

Command	Description
"Y"CR	Current status report
"Y0"CR	Stop
"Y+"CR	Increment frequency
"Y - "CR	Decrement frequency

● "Z": Initial setting

Command	Description
"Z1"CR	Clear memory channels
"Z2"CR	Return user setup to default
"Z3"CR	Execute Z1 and Z2 simultaneously

● "AA": Set dimmer

Command	Description
"AA0"CR	Light
"AA1"CR	Dark

● "BB": Set noise reduction/beat canceler function

Command	Description
"BB0"	Noise reduction/Beat canceller OFF
"BB1"	Noise reduction
"BB2"	Beat canceler

● “CC”: Set ECSS

Command	Description
“CC0”	ECSS OFF
“CC1”	ECSS ON (USB)
“CC2”	ECSS ON (LSB)

● “DD”: Set LOCK

Command	Description
“DD0”	LOCK OFF
“DD1”	LOCK ON

● “EE”: Select notch/notch tracking

Command	Description
“EE0”CR	Notch/notch tracking OFF
“EE1”CR	Notch ON
“EE2”CR	Notch tracking ON

● “FF”: Set NB level

Command	Description
“FF”CR	Current status report “FFccc”CR ccc: 000 to 255
“FFccc”CR	ccc: 000 (effect) to 255 (not effect)

● “GG”: Set notch level

Command	Description
“GG”CR	Current status report “GGscccc”CR s: +, - cccc: 0000 ~ 1023
“GGscccc”CR	scccc: -1023 ~ +1023

● “HH”: Set RF GAIN level

Command	Description
“HH”CR	Current status report “HHccc”CR ccc: 000 to 255
“HHccc”CR	ccc: 000 (minimum) to 255 (maximum)

● “JJ”: Set AF GAIN level

Command	Description
“JJ”CR	Current status report “JJccc”CR ccc: 000 to 255
“JJccc”CR	ccc: 000 (minimum) to 255 (maximum)

● “KK”: Set tone

Command	Description
“KK”CR	Current status report “KKccc”CR ccc: 000 to 255
“KKccc”CR	ccc: 000 (low) to 255 (high)

● “LL”: Set squelch level

Command	Description
“LL”CR	Current status report “LLccc”CR ccc: 000 to 255
“LLccc”CR	ccc: 000 (shallow) to 255 (deep)

● “MM”: Set numerical keypad, buttons

Command	Description
“MM00”CR	0
“MM01”CR	1
“MM02”CR	2
“MM03”CR	3
“MM04”CR	4
“MM05”CR	5
“MM06”CR	6
“MM07”CR	7
“MM08”CR	8
“MM09”CR	9
“MM10”CR	.
“MM11”CR	FUNC
“MM12”CR	CLR
“MM13”CR	MHz
“MM14”CR	ENT/kHz
“MM15”CR	AGC T
“MM16”CR	BWC
“MM17”CR	CH SEL
“MM18”CR	CH
“MM19”CR	SCAN
“MM20”CR	STEP
“MM21”CR	FREQ
“MM22”CR	SWEEP
“MM23”CR	RUN
“MM24”CR	<
“MM25”CR	>
“MM26”CR	AGC

● “NN”: Set AGC TIME

Command	Description
“NN”CR	Current status report
“NNccc”CR	ccc: 002~255

● “OO”: Set BWC

Command	Description
“OO”CR	Current status report
“OOccc”CR	ccc: 001~999

● “PP”: Set IF filter

Command	Description
“PP0”CR	SHARP
“PP1”CR	LOOSE

● “QQ”: Set beat canceler

Command	Description
“QQ0”CR	Beat canceler OFF
“QQ1”CR	Beat canceler ON

● “SS”: stereo information

Command	Description
“SS”CR	Current status report “SSn”CR n: 0, 1 0: Monaural 1: Stereo

● “TT”: AM detection information

Command	Description
“TT”CR	Current status report “TTn”CR n:0, 1 0: Envelope detection 1: Synchronism detection

4.6.3 COMPUTER CONTROL SOFTWARE

Computer control software for operating NRD-545 on Windows 95 is provided as a sample program. This software contains software for displaying RTTY reception signals on display, and panoramic reception software (for displaying the status of radio signals interfering with each at a glance).

Those requiring this software should contact your dealer or the nearest JRC office.

(Note: Computer control software is not interlocked with the MAIN TUNING dial or controls on the receiver.

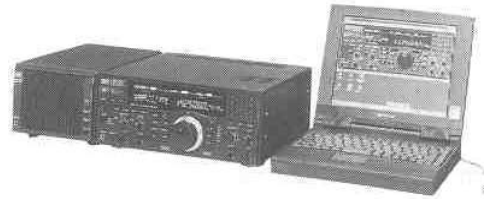

Computer control

5.1 ADJUSTMENT

Your NRD-545 was fully adjustment and inspected at the factory before shipping, and therefore should not require any adjustments other than the ones described below. Fine adjustments other than those described below require sophisticated measurement equipment. In the event that your receiver requires such adjustments, please contact JRC or the dealer where you bought the unit.

■ Preparation for adjustment

Refer to section 7.2 'REMOVING COVERS' to remove the upper cover.

At this time, do not to remove the connector at the tip of the speaker cable. (If this is necessary, connect the external speaker to the EXT SP jack on the rear panel.)

(1) REFERENCE OSCILLATOR FREQUENCY ADJUSTMENT

- ① Turn the POWER switch ON and select the CW mode to receive the standard time station (JJY, WWV, etc.). At this time, adjust as far as the 10 Hz digit of the reception frequency to the frequency of the reference wave.
- ② Set the BFO offset frequency to ± 0 Hz referring to "4.5 Modifying Operations by User Setup."
- ③ Adjust the trimmer capacitor (CV1), located at the top of the shield case of the CGK-160 REF/DDS unit, as shown in Figure 5-1 until no beat note is heard from the speaker.
- ④ This completes adjustment of the reference oscillator frequency. Return the BFO offset frequency to +800 Hz, turn the POWER switch OFF and attach the top cover.

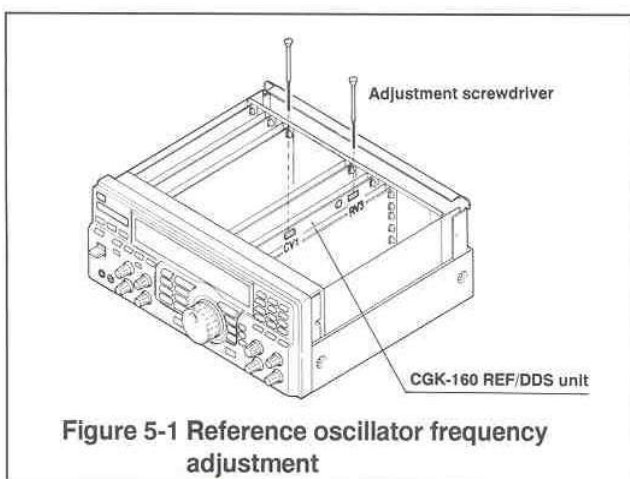

Figure 5-1 Reference oscillator frequency adjustment

(2) BEEP TONE ADJUSTMENT

- ① A beep sound will be heard when a numeric key operation or an incorrect operation has been made.
- ② Adjust the semi-fixed variable resistor (RV3) on the shield case on the CGK-160 REF/DDS unit to adjust the beep tone as desired.
- ③ When you have completed the adjustment, turn the POWER switch OFF and attach the top cover.

5.2 MAINTENANCE

(1) ELECTRIC COMPONENTS

The ICs, transistors and diodes of the NRD-545 are extremely sensitive and will be destroyed even if short-circuited for an extremely short period of time. Therefore it is important to take special care of them.

(2) FUSE

If the power fuse is blown, try to determine the cause of the problem before replacing the fuse. The fuse is located on the back panel. A DC fuse is also provided on the power cord between the receiver and the power supply.

(3) CR2032 LITHIUM CELL

The NRD-545 memory channel information is backed up by a lithium cell. this cell should function properly for about five years before requiring replacement. If the memory channel information errors occur, or if the information is not saved to memory, the lithium cell will need to be replaced. The model name of the lithium cell is CR2032 (3V).

Contact the dealer where you bought your NRD-545 if you are unable to obtain a new battery or would like your battery to be replaced by service personnel.

● Replacing the lithium cell

- (1) Disconnect the power cord from the NRD-545.
- (2) Remove the top and bottom covers as shown in item 7.2.
- (3) Remove the control panel from the NRD-545 body.
- (4) Replace the lithium cell attached to the display unit as shown in Figure 5-2.
- (5) Attach the control panel onto the NRD-545 body.
- (6) Attach the top and bottom covers. This completes the procedure.

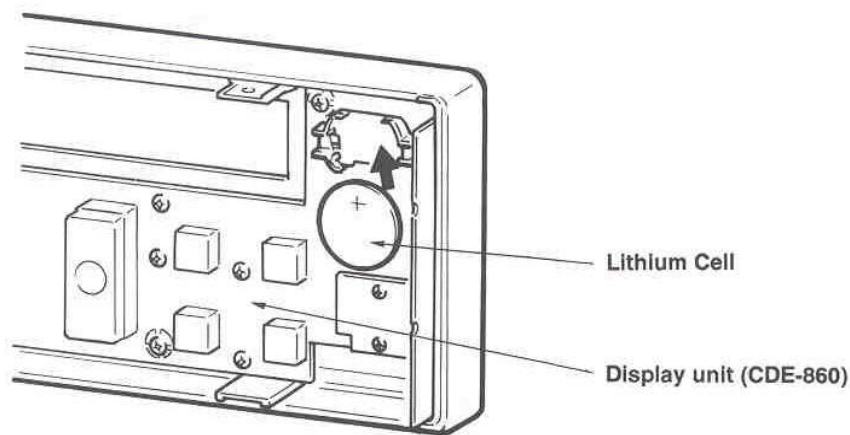

Figure 5-2 Replacing the Lithium Cell

5.3 TROUBLESHOOTING

The NRD-545 has many features, but may not perform as desired if it is operated improperly. If you experience a problem, first review the operating procedures presented in this manual before deciding that the problem is due to an equipment failure. This section describes various symptoms which can occur if the NRD-545 is not handled or operated properly. None of these symptoms are indicative of an equipment failure. Therefore it is important to carefully review the possible causes of a problem before placing a repair order. If the NRD-545 still does not operate properly after going through the troubleshooting procedures, determine what the detailed symptoms are and contact JRC's customer service center or the dealer where you bought the unit.

5.3.1 SIMPLE PROBLEMS

No.	Symptom	Cause	Solution
1	No display appears when the power is switched ON.	(1) The power connector is not fully connected. (2) The fuse is blown.	(1) Check whether the connector is plugged in. (2) After determining the cause of the problem, replace the fuse with a new fuse that has the same rating.
2	The display works but there is no sound when the power is switched ON.	(1) The headphones are connected to the PHONES jack. (2) Squelch is closed. (3) The RF GAIN control is at the most counterclockwise position.	(1) Disconnect the headphones. (2) Set squelch to OFF. (3) Turn the RF GAIN control to the most clockwise position.
3	LCD is dark.	Dimmer is set to minimum brightness.	Set the DIMMER to the "light".
4	The S meter is deflecting even though there are no incoming signals.	The RF GAIN control is not at the most clockwise position.	Turn the RF GAIN control to the most clockwise position.
5	Distorted sound and/or poor audio quality.	(1) AGC is OFF. (2) The receiver is out of tuned frequency. (3) The wrong mode is selected. (4) The notch filter is ON. (5) The pass band shift control is not at the center position. (6) The noise blanker is ON. (7) Noise reduction is functioning.	(1) Set AGC to ON. (2) Adjust MAIN TUNING dial. (3) Select the mode for the incoming signal. (4) Set notch to OFF. (5) Set the pass band shift control at the center position. (6) Set the noise blanker to OFF. (7) Set noise reduction to OFF.
6	Low sensitivity	(1) ATT is on. (2) The antenna is not connected.	(1) Set ATT to OFF. (2) Properly connect the antenna. Check whether the antenna selector switch on the back side is set properly.

5.3.2 MORE SERIOUS PROBLEMS

(1) DISPLAY ERROR, RECEPTION ERROR

Vibrations that occur during transportation sometimes cause printed circuit boards inside the NRD-545 to come loose or faulty connections between connectors and the mother board. This may result in display error, reception error, or other phenomena. If this happens, remove the top cover as shown in Figure 7-3, and press the printed circuit board from above to firmly insert the board.

(2) TELEVISION, RADIO, STEREO, OR OTHER EQUIPMENT IS RECEIVING INTERFERENCE WHICH SEEMS TO BE FROM NRD-545

The NRD-545 has been RFI shielded sufficiently for practical use. However, inadequate grounding, an improper antenna installation location, and other factors can result in noise interference in other electronic devices. If you experience such problems, try the following:

1. Replace the NRD-545 grounding wire with a wire that has a thicker conductor. Be sure that all connections such as copper plates are securely buried in the ground or connected to a water pipe. Also make sure that all runs of wire are as short as possible.
2. Place the antenna on the other device at a sufficient distance from the NRD-545 and the NRD-545 antenna.
3. If the other device is a television or FM receiver, try changing the orientation of the set's antenna, or replace it with a higher-performance antenna.
4. Try plugging the NRD-545 and the other device into separate outlets.
5. Use a thicker ground wire on the other device.
6. Insert a noise filter or isolation transformer in the power supply line.

(3) OBVIOUS NOISE INTERFERENCE WHICH IS PROBABLY DUE TO ARTIFICIAL NOISE DURING RECEPTION

There are numerous artificial and natural noise sources that can affect receivers. Natural noise can be caused by thunder, rain, and snow storms. Artificial noise is produced by motorcycle and auto ignitions, power lines, sewing machines, personal computers, fluorescent lights, hair dryers, and other devices. In addition, nearby radio stations may cause noise which is only a problem during transmission. Basically, measures to prevent artificial noise interference must be taken at the noise source. However, changing the NRD-545 receiving antenna design and changing the location where it is installed may be helpful. In addition, improving your grounding system is often an effective means of reducing interference.

Even if there are strong noise sources in your area, your receiver should work well as long as the signal you are trying to receive has sufficient field strength. Noise leads to interference only when you are trying to receive a weak signal.

(4) INTERFERENCE DUE TO INTERMODULATION

If your receiver is close to live broadcast stations or other sources of strong radio emissions, you may simultaneously receive signals from one or more stations at a frequency where you would normally not expect to receive such broadcasts. This type of occurrence is called intermodulation. If you seem to be experiencing such a problem, turn the NRD-545 ATT button to ON. If this does not solve the problem, lower the antenna height and/or use a shorter antenna. These steps will almost always solve the problem.

(5) RECEIVER SENSITIVITY SEEM LOW

The field strength of a signal from a given station can vary widely according to factors such as sun spots, the season, the time of day, and the frequency. This is especially true at high frequencies. Therefore a comparison of receiver sensitivities is only meaningful if you compare output S/N ratios at the same time of day, using the same frequency and the same antenna.

The sensitivity you hear may also vary according to the speaker volume. If you think your receiver has poor sensitivity, be sure to consider factors such as the frequency and antenna orientation.

This product was passed through rigorous quality control procedures and testing before it was shipped. In the event of a failure, please contact the dealer where you bought the product. Try to describe the problem in as much detail as possible.

- **If the product needs to be repaired:**

Before placing a repair order, please review the information presented in the troubleshooting section 5.3.

- **If you are unsure about the availability and terms of after-service:**

Contact the dealer where you bought the product.

Note

The cardboard box that the NRD-545 is shipped in was designed to provide maximum protection during shipping. Therefore we recommend that you save this box in case you need to ship the radio at a later date for servicing , etc.

SECTION 7

OPTIONAL UNITS

7.1 INTRODUCTION

Several optional units are available to help you operate the NRD-545 more effectively.

■ Temperature Compensated X'tal Oscillator

This oscillator is for improving the frequency stability to within ± 0.5 ppm.

- (1) Contents of package
 - TCXO CGD-197: 1
 - Printed circuit board puller: 2
 - Instruction manual: 1

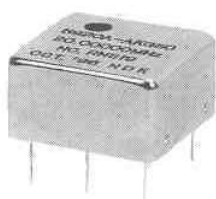

TCXO CGD-197

(2) INSTALLATION

Be sure to turn the NRD-545 POWER switch ② to OFF and remove the power cord before installing the CGD-197. Also do not unnecessarily touch any of the units inside the NRD-545.

1. Remove the top cover according to "7.2 Removing Covers."
2. Remove the CGK-160 REF/DDS unit from the NRD-545 body according to "7.3 Removing Internal Units."
3. Solder the TCXO on to XU1 on CGK-160. (See Figure 7-1.)
4. Swap P1 JP1-1, JP1-2 and JP1-3 on the TCXO-ON side.

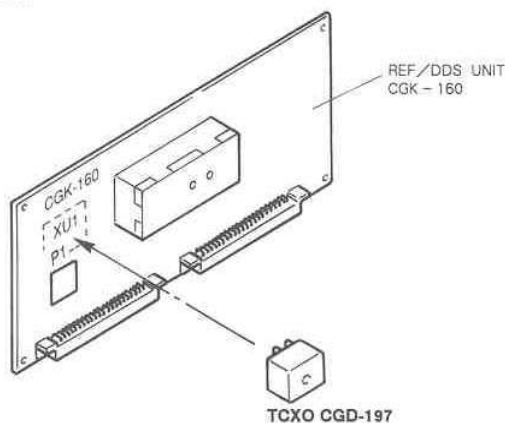

Figure 7-1 Installing the TCXO

5. The TCXO (CGD-197) has been adjusted to provide the ultimate performance, thus no re-adjustment is required.
6. Firmly mount the unit at the specified location.
7. Attach the top cover. This completes mounting of the crystal oscillator.

■ Wideband converter unit CHE-199

The CHE-199 can extend the reception frequency range to 100 kHz to 1999.999 MHz.

- (1) Contents of package
 - Wideband converter unit: 1
 - Printed circuit board puller: 2
 - Instruction manual: 1

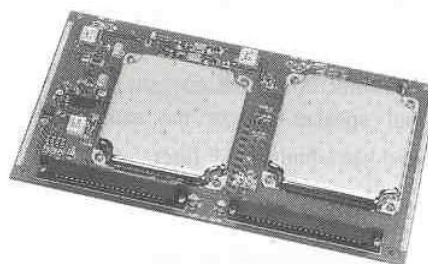

Wideband converter unit CHE-199

(2) INSTALLATION

Be sure to turn the NRD-545 POWER switch ② to OFF and remove the power cord before installing a CHE-199. Also do not unnecessarily touch any of the units inside the NRD-545.

1. Remove the top cover according to "7.2 Removing Covers."
2. Attach the wideband converter unit CHE-199 at the specified location according to Figure 7-2, and insert the coaxial cable into J1 on the wideband converter unit. If the cable is not properly inserted into the wideband converter unit at this time, the contact may be faulty and prevent the NRD-545 from functioning.
3. Attach the top cover. This completes mounting of the wideband converter unit.
4. Turn the main power ON while holding down the CLR button ② to return the memory channels and user setup to the factory setting (default).
5. When the wideband converter unit is mounted, the CPU automatically recognizes this, and the unit becomes operable. When the unit is mounted, the **WIDE BAND** display on the LCD lights.
6. To receive frequencies 30 MHz or higher, a wideband connector must be connected to the WB ANT connector.

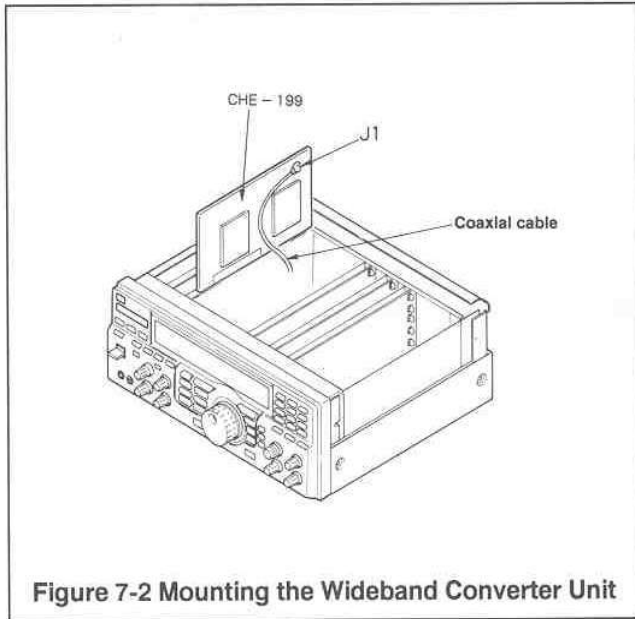

Figure 7-2 Mounting the Wideband Converter Unit

■ **External speaker NVA-319**

This external speaker adopts the same design as the NRD-545, and has a built-in AF filter.



External speaker NVA-319

■ **ST-3 Headphones**

The ST-3 headphones are designed for radio communication equipment.



ST-3 Headphones

■ **6ZCJDOO350 RS-232C cable**

This cable is designed to connect the NRD-545 with a personal computer.

7.2 REMOVING COVERS

Remove the upper or lower cover as shown in Figure 7-3.

Remove the six screws on each cover to remove the cover. The speaker is attached to the upper cover, so remove the cover gently taking care to prevent the speaker cable from being cut. If necessary, remove the connector on the cable end from the internal unit. Then, remove the protective material for securing the printed circuit boards.

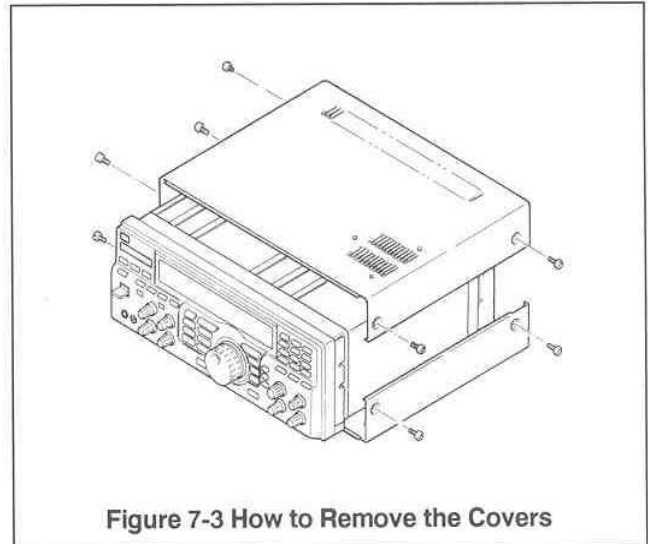
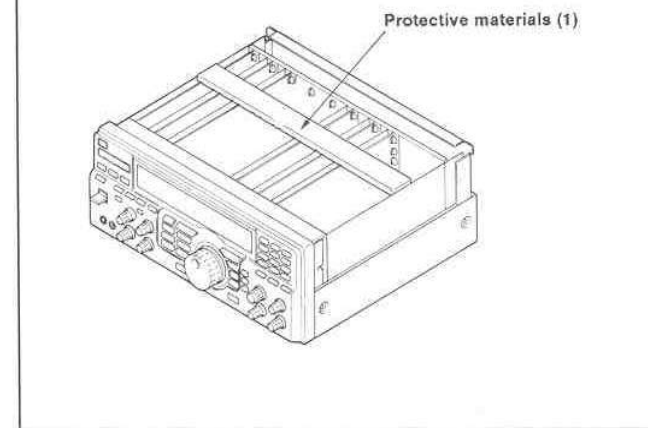

Figure 7-3 How to Remove the Covers

Note

When you remove the top cover of the NRD-545, you will find protective material (1) attached inside the body as shown in the figure below. This material is attached to prevent NRD-545 plug-in units from coming loose during transportation. Even if this material is attached, it will not adversely affect the electrical functions of the NRD-545.



7.3 REMOVING INTERNAL UNITS

Internal units are laid out as shown in Figure 7-4.
(PRINTED CIRCUIT BOARD)

- (1) Insert the printed circuit board pullers (option) into the holes on both ends of the printed circuit board from the components mounting side. (See Figure 7-5.)
- (2) Press the printed circuit board pullers down in the direction of the arrow as if they were levers.
- (3) When the printed circuit board comes loose, gently pull the board up to remove.

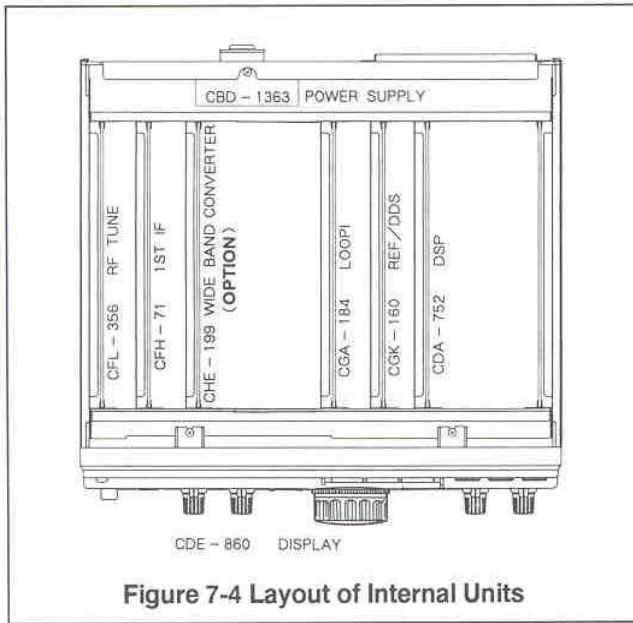

Figure 7-4 Layout of Internal Units

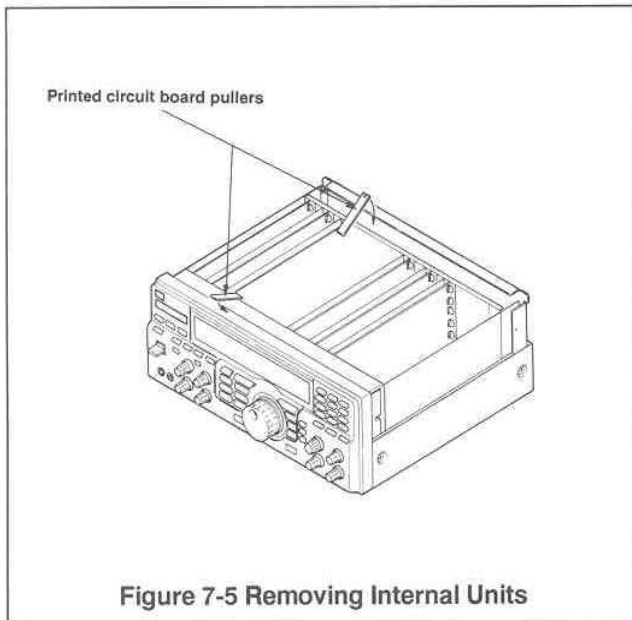

Figure 7-5 Removing Internal Units

7.4 FASTENING COVERS

Make sure that the internal printed circuit board units are firmly mounted. Insert the speaker connector on the top cover to the **SP OUT** J31 of the CGK-160, and mount the top cover. Then, tighten each of the four screws.

 **WARNIG**

Before you discard this unit, remove the used lithium cells from the NRD-545, and fix insulating tape to their + and - terminals. Failure to do this can cause heat generation, bursting or fire.

8.1 DISCARDING THE NRD-545

- Dispose of the NRD-545 according to local government rules and bylaws.
- Before you discard the NRD-545, remove the lithium cells from CPU unit CDE-860 attached to the front of the unit. For details on how to remove the lithium cells, see "5.2 (3)."

8.2 DISCARDING LITHIUM CELLS

- Do not save used lithium cells, nor dispose of used lithium cells as disposable rubbish.
- Before disposing of used lithium cells, and insulate them by fixing insulating tape to their + or - terminals. Next, separate them from other batteries or cells to dispose of, and dispose of them according to local government rules and bylaws. For details, contact your dealer.

SECTION 9

SPECIFICATIONS

Operating Frequency Range:	0.1 to 29.999999 MHz With option board (CHE-199) installed.	Frequency stability:	± 10 ppm or less after 5 to 60 minute warm-up period; ± 2 ppm per hour or less from then on
NRD-545G:	100 kHz to 1999.999 MHz		
NRD-545U:	100 kHz~823.900 MHz 849.100 MHz~868.900 MHz 894.100 MHz~1849.900 MHz 1910.100 MHz~1929.900 MHz 1990.100 MHz~1999.999 MHz	Minimum Tuning Step:	1 Hz (10 Hz to 100 kHz steps possible)
Modes of Reception:	USB, LSB, CW, RTTY, AM, FM WFM (with option board installed) (Note: USB, LSB, CW and RTTY modes are valid at under 30- MHz. WFM mode is valid at 30 MHz or more.)	Memory Channels:	1000 (frequency, mode, bandwidth, ATT, AGC and Tuning step can be stored to memory)
		Receiving System:	Triple superheterodyne First IF: 70.455 MHz Second IF: 455 kHz Third IF: 20.22 kHz

Sensitivity

	USB,LSB,CW,RTTY	AM	FM	WFM
0.1~0.499999MHz	14dB μ (5 μ V)	24dB μ (15.8 μ V)	—	—
0.5~1.599999MHz	6dB μ (2 μ V)	16dB μ (6.3 μ V)	—	—
1.6~29.999999MHz	- 10dB μ (0.32 μ V)	6dB μ (2 μ V)	- 6dB μ (0.5 μ V)	—
30~1000MHz	—	10dB μ (3.2 μ V)	- 2dB μ (0.8 μ V)	6dB μ (2 μ V)
1260~1300MHz	—	10dB μ (3.2 μ V)	- 2dB μ (0.8 μ V)	—

Bandwidth USB/LSB/CW/RTTY/AM: 2.4 kHz

S/N: 10 dB, Modulation: 400 Hz, 30% (at AM measurement), 12 dB SINAD (at FM, WFM measurement), according to JAIA measurement method

(sensitivity at 30 MHz or more with option board installed)

Selectivity

	Bandwidth	6dB	60dB
WIDE	4.5kHz	4.5 kHz or more	8 kHz or less
INTER	2.4kHz	2.4 kHz or more	5 kHz or less
NARROW	1kHz	1 kHz or more	4 kHz or less
FM	10kHz	10 kHz or more	—

The WIDE, INTER and NARROW are only examples. Any bandwidth in the range 0.01 to 9.99 kHz can be set. (except for AM, FM, WFM)

Dynamic range:	106 dB (IF bandwidth 300 Hz)	AGC characteristics:	10 dB or less AF output varia- tion for antenna input signal change from 3 μ V to 100 mV.
Image rejection:	70 dB or more		Release time 40 mS to 5.1 S (20 mS steps)
Spurious response:	60 dB or more		
IF rejection:	70 dB or more		
PBS variable range:	± 2.3 kHz (50 Hz steps)		
Notch attenuation amount:	40 dB or more	AF output:	Speaker output: 1 W or more (at 4-0hms load and 10% distortion)
Notch variable range:	± 2.5 kHz (10 Hz steps)		Line output, recording output: 1mW or more (at 600-0hms load and 10% distortion)
Notch tracking range:	± 10 kHz		
Antenna impedance:	50 Ω at Lo-Z terminal; 600 Ω at Hi-Z terminal		
Attenuator:	Approx. 20 dB	RS-232C interface:	Baud rate: 4800 baud (character

structure: 1 start bit, 8 data bits,
no parity, 1 stop bit)

Power requirements: AC100/120/220/240 V \pm 10%
40 VA or less
DC 12 to 16 V (standard
13.8 V) 30 W or less

Dimensions: 330 mm (W) x 130 (143) (H) x
285 (327) (D)
Figures in parentheses "()" are
maximum dimensions including
protrusions.

Weight: Approx. 7.5 kg

Note 1) Specifications conform to JAIA (Japan Amateur Radio
Industrirs Association).

Note 2) Specifications and external dimensions are subject to
change without notice.

Note 3) If operation described in the Instruction Manual differs
from that of the actual product, the operation of the
actual product shall take precedence.

For further information, contact:

JRC

Since 1915

Japan Radio Co., Ltd.

Main Office: Akasaka Twin Tower(main),
17-22, Akasaka 2-chome, Minato-ku,
Tokyo 107-8432 JAPAN
Phone: +81-3-3584-8838
FAX: +81-3-3584-8879

Overseas Branches: London, New York, Seattle
Liaison Offices: Jakarta, Bangkok, Manila, New Delhi,
Rio de Janeiro, Rotterdam, Las Palmas,
Caohsiung, Singapore, Greece

CODE No. H-7ZPDN0002A

SECOND EDITION 98.2

AUG. 1998

AB '98. 8(800)

No. 87900