

iCOM

INSTRUCTION MANUAL

FM TRANSCEIVERS

IC-T8A
IC-T8E

This device complies with Part 15 of the FCC rules. Operation is subject to the following two conditions: (1) This device may not cause harmful interference, and (2) this device must accept any interference received, including interference that may cause undesired operation.

Icom Inc.



FOREWORD

Thank you for purchasing the **IC-T8A** or **IC-T8E**. This product represents Icom's state-of-the-art handheld transceiver technology. The IC-T8A/E features tri-band capabilities (VHF, UHF operation and 50 MHz reception), numerous functions and superior performance—in a package as compact as that of a single bander. With proper care this Icom product will provide years of trouble-free operation.

IMPORTANT

READ ALL INSTRUCTIONS carefully and completely before using the transceiver.

SAVE THIS INSTRUCTION MANUAL—This instruction manual contains important operating instructions for the IC-T8A and IC-T8E.



The IC-T8E complies with essential requirements of the 89/336/EEC directive for Electromagnetic Compatibility. This compliance is based on conformity with the ETSI specification ETS300 684 (EMC product standard for Commercially Available Amateur Radio Equipment).

CAUTIONS

⚠ WARNING! NEVER hold the transceiver so that the antenna is very close to, or touching exposed parts of the body, especially the face or eyes, while transmitting. The transceiver will perform best if the microphone is 5 to 10 cm (2 to 4 in) away from the lips and the transceiver is vertical.

⚠ WARNING! NEVER operate the transceiver with a headset or other audio accessories at high volume levels. Hearing experts advise against continuous high volume operation. If you experience a ringing in your ears, reduce the volume level or discontinue use.

NEVER connect the transceiver to an AC outlet or to a power source of more than 16 V DC. Such a connection will damage the transceiver.

NEVER connect the transceiver to a power source that is DC fused at more than 5 A. Accidental reverse connection will be protected by this fuse, higher fuse values will not give any protection against such accidents and the transceiver will be ruined.

NEVER attempt to charge alkaline or dry cell batteries. Be aware that external DC power connections will charge batteries inside the battery case. This will damage not only the battery case but also the transceiver.

DO NOT push the PTT when not actually desiring to transmit.

DO NOT allow children to play with any radio equipment containing a transmitter.

DO NOT operate the transceiver near unshielded electrical blasting caps or in an explosive atmosphere.

AVOID using or placing the transceiver in direct sunlight or in areas with temperatures below -10°C ($+14^{\circ}\text{F}$) or above $+60^{\circ}\text{C}$ ($+140^{\circ}\text{F}$).

The use of non-Icom battery packs/chargers may impair transceiver performance and invalidate the warranty.

Even when the transceiver power is OFF, a slight current still flows in the circuits. Remove the battery pack or case from the transceiver when not using it for a long time. Otherwise, the battery pack or installed dry cell batteries will become exhausted.

UNPACKING

Accessories included with the transceiver:

	Qty.
① Battery pack (BP-199 or BP-200) or battery case (BP-197) attached to the transceiver	1
② Antenna (S6270B)	1
③ Handstrap	1
④ Belt clip	1
⑤ Wall charger (BC-110A/D/V)*	1

*Not supplied with some versions.

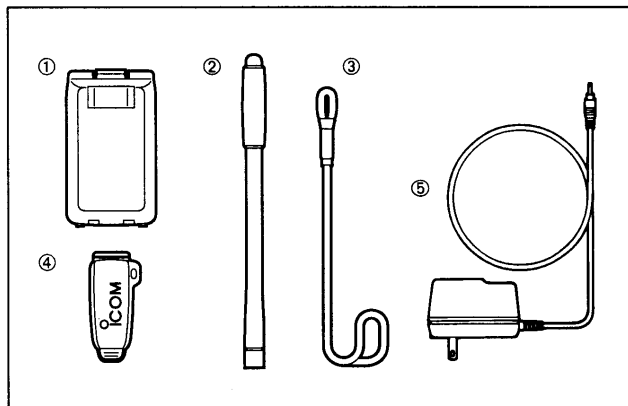

TABLE OF CONTENTS

FOREWORD	i	7	SCAN FUNCTIONS	19 – 21
IMPORTANT	i	■ Scan types	19	
CAUTIONS	i	■ Full/programmed scan	20	
UNPACKING	ii	■ Memory (skip) scan	20	
TABLE OF CONTENTS	iii	■ Skip channel setting	21	
		■ Scan resume condition	21	
1 ACCESSORY ATTACHMENT	1	8 SUBAUDIBLE TONE OPERATION	22 – 23	
2 PANEL DESCRIPTION	2 – 7	■ Tone squelch	22	
■ Switches, controls, keys and connectors	2	■ Tone scan	23	
■ Function display	6	■ Pocket beep	23	
3 BASIC OPERATION	8 – 11	9 OTHER FUNCTIONS	24 – 27	
■ Power ON	8	■ Help function	24	
■ Setting a frequency	8	■ Initial set mode	24	
■ Setting tuning steps	9	■ Channel indication mode	26	
■ Selecting a memory channel	10	■ Resetting the CPU	26	
■ Lock function	10	■ Handheld-to-handheld cloning	27	
■ Receive and transmit	10	10 BATTERY PACKS AND CHARGING	28 – 30	
■ FM broadcast reception	11	■ General	28	
■ Air band reception	11	■ Charging precautions	28	
■ FM narrow operation	11	■ About the battery pack	28	
4 REPEATER OPERATION	12 – 14	■ Charging connections	29	
■ General	12	■ Battery case	30	
■ Subaudible tones for repeater use	13	11 TROUBLESHOOTING	31	
■ Setting an offset frequency	13	12 OPTIONS	32	
■ Auto repeater function	14	13 SPECIFICATIONS	33	
5 MEMORY/CALL CHANNELS	15 – 17	14 OPERATION FLOW CHART	34 – 35	
■ General	15			
■ Programming during selection	15			
■ Programming after selection	16			
■ Editing	16			
6 DTMF MEMORY	18			
■ Programming a DTMF code	18			
■ Transmitting a DTMF code	18			

ACCESSORY ATTACHMENT

◇ Antenna

Insert the supplied antenna into the antenna connector and rotate the antenna as shown in the diagram below.

Keep the jack cover attached when jacks are not in use to avoid bad contacts.

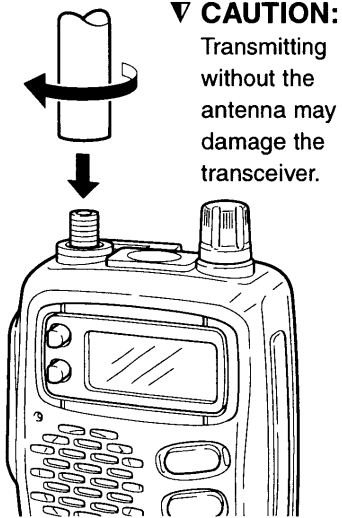

◇ Handstrap

Attach the handstrap to the belt clip, before attaching the belt clip to the transceiver, as below.

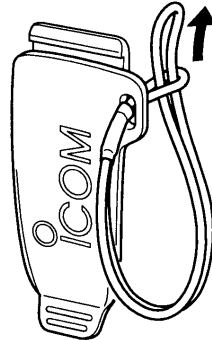

◇ Belt clip

Attach the belt clip to the transceiver as illustrated below.

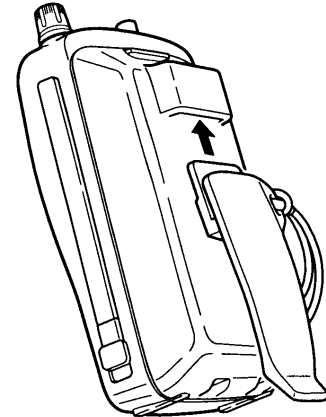

PANEL DESCRIPTION

■ Switches, controls, keys and connectors

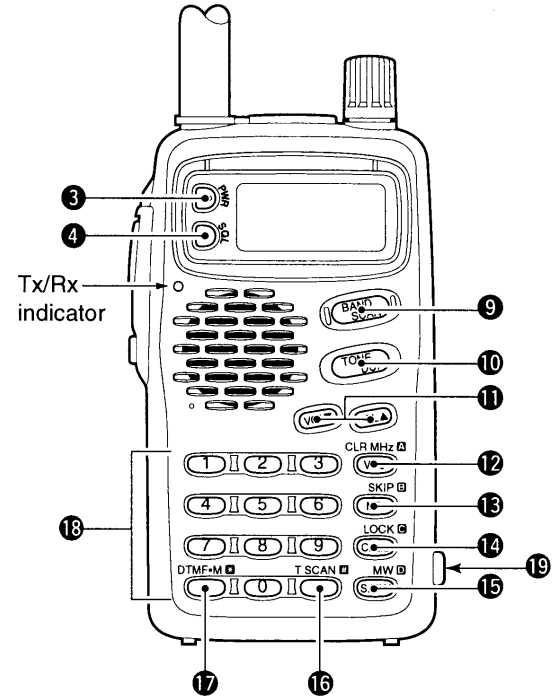
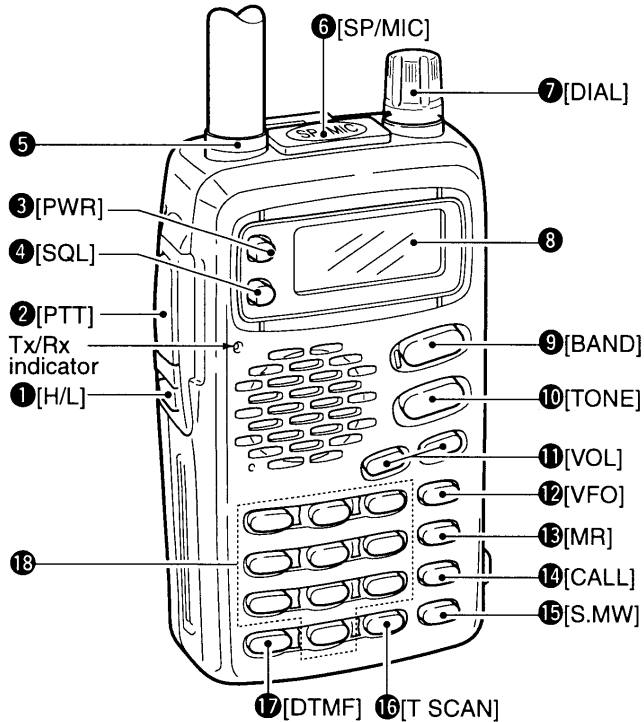

1 OUTPUT POWER SWITCH [H/L(SET)] (p. 10)



- ➔ Push to toggle between high and low output powers.
 - “LOW” appears when low output power is selected.
- ➔ Push for 1 sec. to select set mode.

2 PTT SWITCH [PTT] (p. 10)



Push and hold to transmit; release to receive.

3 POWER SWITCH [PWR] (p. 8)



Push for 1 sec. to turn power on and off.

4 SQUELCH SWITCH [SQL] (p. 10)



- ➔ Push and hold to temporarily open the squelch to listen to weak signals.
- ➔ While pushing, rotate [DIAL] to set the squelch to “AUTO” or one of eight levels.

5 ANTENNA CONNECTOR (p. 1)

Connects the supplied antenna.

6 EXTERNAL SPEAKER AND MICROPHONE JACKS [SP/MIC]

Connect an optional speaker-microphone or headset, if desired. The internal microphone and speaker will not function when either is connected. (See p. 32 for options.)

External connection

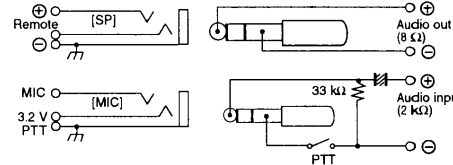

This connection does not apply when a condenser microphone is connected.

7 TUNING DIAL [DIAL]

Rotate to select an operating frequency, select a memory channel, select set mode contents, change scan direction, etc.

8 FUNCTION DISPLAY (p. 6)

Displays the operating frequency and other operating conditions.

9 BAND SWITCH [BAND(SCAN)] (p. 9)



- ➔ Push to select a frequency band (except when in memory mode).
- ➔ Push for 1 sec. to start scanning.

10 TONE SWITCH [TONE(DUP)]



- ➔ Push to activate the following functions in order:
 - Subaudible tone encoder—“T” appears (p. 12).
 - Pocket beep—“T SQL (••)” appears (p. 23).
 - Tone squelch—“T SQL” appears (p. 22).
 - No tone operation—no indicator appears.
- ➔ Push for 1 sec. to select semi-duplex or simplex operation (p. 12).

2 PANEL DESCRIPTION

- “-DUP” appears during minus duplex operation; “DUP” appears during plus duplex operation; and no indication appears during simplex operation.

➔ For the European version only, while pushing [PTT], push this switch to transmit a 1750 Hz tone burst signal (p. 12).

11 VOLUME SWITCHES [VOL▲/VOL▼] (p. 10)

VOL▼

Push or push and hold to adjust the audio output.

VOL▲

12 VFO/CLEAR KEY [VFO(CLR/MHz)]

CLR MHz

➔ Push to select VFO mode (p. 8).

VFO

➔ Cancels some functions such as digit input before entry, scan, etc.

➔ Push and hold for 1 sec., then rotate [DIAL] to change the MHz digit (p. 21).

➔ While pushing [PTT], this key sends a DTMF “A.”

13 MEMORY MODE KEY [MR(SKIP)]

SKIP

➔ Push to select memory mode (p. 10).

MR

- “MR” appears while in memory mode.

➔ While in memory mode, push this key for 1 sec. to toggle the selected memory channel between a skip and non-skip channel (p. 21).

- “SKIP” appears when the channel is set as a skip channel.

➔ While pushing [PTT], this key sends a DTMF “B.”

14 CALL MODE KEY [CALL(LOCK)]

LOCK

➔ Push to select the call channel (p. 15).

CALL

- “C” appears when the call channel is selected.

➔ Push for 1 sec. to toggle the lock function on and off (p. 10).

- “” appears when the lock function is activated.

➔ While pushing [PTT], this key sends a DTMF “C.”

15 SELECT MEMORY WRITE KEY [S.MW(MW)]

MW

➔ Push to enter memory select mode (p. 15).

S.MW

- “” flashes and the [DIAL] can be used for channel selection (for memory writing or clearing).

➔ Push for 1 sec. to write the set contents into the selected memory channel (or VFO, call channel) (p. 15).

➔ Push, then push and hold this key while in memory select mode to erase the contents of the selected memory channel (p. 17).

➔ While pushing [PTT], this key sends a DTMF “D.”

16 TONE SCAN KEY [T•SCAN]

T SCAN

➔ Push for 1 sec. to start tone decode scan (p. 23); push momentarily to stop it.

- When a subaudible tone is detected, the tone frequency is displayed and overwrites the preprogrammed:

→ tone squelch frequency when the tone squelch is in use;

→ tone encoder (repeater tone) frequency when the

tone squelch is not in use.

- ➔ Push momentarily to toggle between regular FM and FM narrow operation on the VHF band. (Europe and Italy versions only—p. 11).
 - “FM” appears when FM narrow operation is selected.
- ➔ While pushing [PTT], this key sends a DTMF “#.”

17 DTMF KEY [DTMF•M



- ➔ Enters a decimal for the MHz unit during frequency input (p. 9).
- ➔ Push for 1 sec. to enter DTMF memory mode for programming or recall (p. 18).
 - To program use [(H/L)SET].
 - To transmit use [SQL] while transmitting.
- ➔ While pushing [PTT], this key sends a DTMF “*.”

18 DIGIT KEYS

- ➔ Input the specified digit during frequency input, memory channel selection, etc.
- ➔ Transmit the DTMF code of the specified digit while pushing [PTT].

19 EXTERNAL DC POWER JACK [DC13.5V]

Allows you to operate the transceiver with a 4.5 to 16 V DC power source using optional cables, CP-12L or OPC-254L.

∇ CAUTION: Operation with an external DC power source simultaneously charges batteries inside the battery case or the battery pack. When using dry cell batteries this may cause battery leakage and damage the transceiver; when using a Ni-Cd battery pack this may cause battery overcharging and shorten the life of the battery pack.

2 PANEL DESCRIPTION

■ Function display

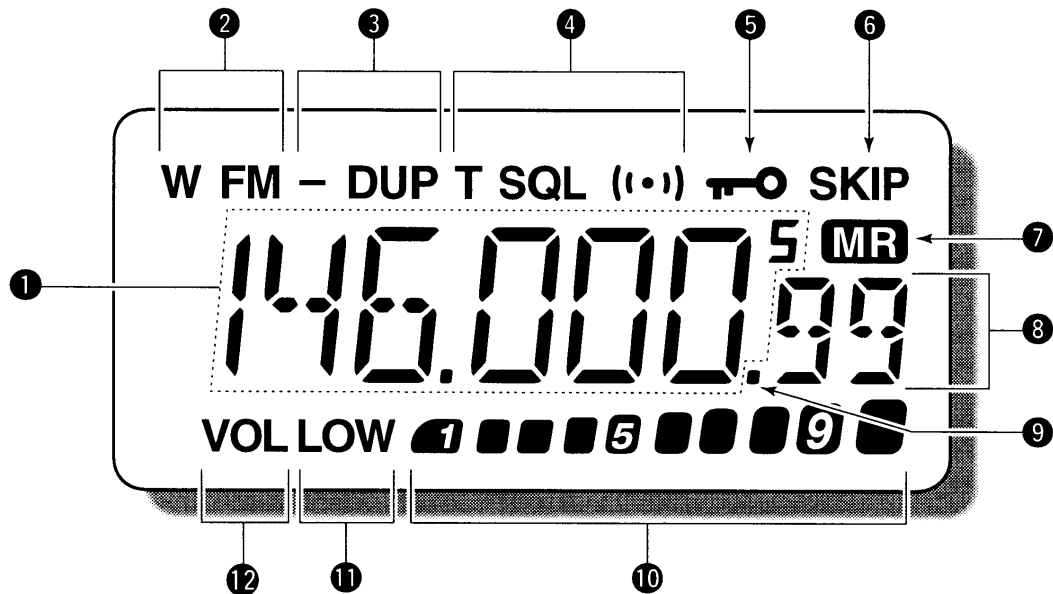

1 FREQUENCY INDICATION

Shows the selected frequency, set mode contents, etc.

2 WFM MODE INDICATOR (p. 11)

Indicates WFM (wide FM) mode is selected—automatically appears when selecting a frequency in the range 76–107.995 MHz.

- “FM” only appears when narrow FM operation is selected.

3 DUPLEX INDICATORS (p. 12)

Appear during semi-duplex operation.

- “-DUP” appears for minus duplex; “DUP” only appears for plus duplex.

4 TONE INDICATORS (pgs. 12, 22, 23)

“T” appears when the subaudible tone encoder is in use, “T SQL (··)” appears during pocket beep operation and “T SQL” appears when the tone squelch function is activated.

5 LOCK INDICATOR (p. 10)

Appears when the lock function is activated.

6 SKIP INDICATOR (p. 21)

Appears when a selected memory channel is set as a skip channel.

7 MEMORY MODE INDICATOR (p. 10)

Appears while in memory mode.

8 MEMORY CHANNEL INDICATOR (p. 15)

Indicates the selected memory channel and other items such as the call channel.

9 AM INDICATOR (p. 11)

Appears when the air band is selected (118–136 MHz) and indicates that AM mode is the receive mode.

10 S/R/F INDICATORS (p. 10)

Show the relative signal strength while receiving and the output power selection while transmitting.

11 LOW POWER INDICATOR (p. 10)

Appears when low output power is selected.

12 VOLUME INDICATOR (p. 10)

Appears while adjusting the volume.

- The S/R/F indicators also appear while adjusting volume to visually indicate the selected volume level.

■ Power ON

NOTE: Charge the battery pack before turning power on for the first time (see pgs. 28–31).

Push and hold [PWR] for 1 sec. to turn power on.

• Current battery voltage may be displayed for 2 sec.



for 1 sec.

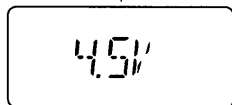

after 2 sec.

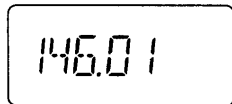

- The display shows the approx. voltage in 0.5 V steps.
- When the battery voltage is lower than a specified level (varies according to battery pack used), "LOW V" appears. Charge the battery pack in this case or replace the alkaline cells in the battery case.
- If "OVER V" appears, **UNPLUG** the external DC plug immediately. Connected voltage is over 16 V and could damage the transceiver.

■ Setting a frequency

◇ Via the keypad

(from the MHz digits)

- ① Push [VFO] to select VFO mode.
- ② Push digit keys corresponding to the desired frequency.
 - When inputting a frequency in the 50 MHz band, it is necessary to input the decimal point.
 - When a digit is mistakenly input, push [VFO] and input from the beginning.
 - When an unacceptable frequency is input, the display reverts to the previously displayed frequency.
 - "0," "2," "5" and "7" are acceptable as the 1 kHz digit input depending on the 10 kHz digit.

[Example]

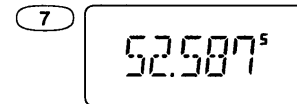
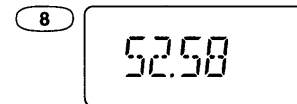
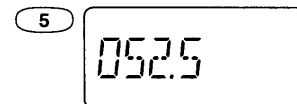
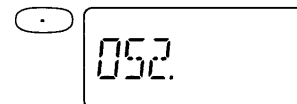
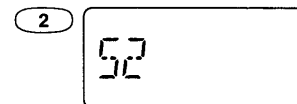
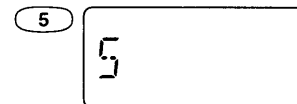

◇ **Via the keypad**

(from the decimal point)

- ① Push [VFO] to select VFO mode.
- ② Push [.] to leave the MHz setting as is and input from the kHz digits.

[Example]

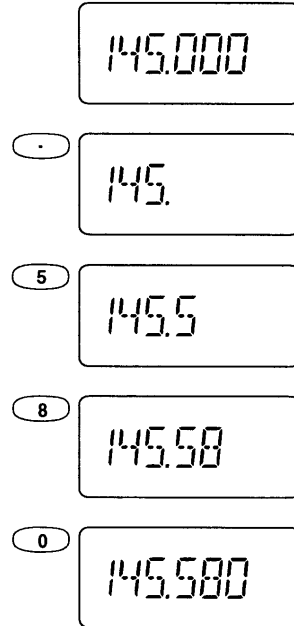

◇ **Other methods**

- **VIA THE DIAL:** Rotate [DIAL] to change the frequency according to the set tuning steps.
- **USING THE MHz STEP:** Push [(VFO)MHz] for 1 sec., then rotate [DIAL] to change the frequency in 1 MHz steps.

■ **Setting tuning steps**

USING SET MODE

This transceiver has 9 tuning steps (each band has independent settings) as follows:

- 5 kHz • 10 kHz • 12.5 kHz • 15 kHz • 20 kHz
- 25 kHz • 30 kHz • 50 kHz • 100 kHz

- ① Push [VFO] to select VFO mode.
- ② Push [BAND] to select the desired band.
- ③ Push [(H/L)SET] for 1 sec. to enter set mode.
- ④ Push [TONE] or [H/L] several times until "TS" appears.
- ⑤ Rotate [DIAL] to select the desired tuning step.
- ⑥ Push [(VFO)CLR] to exit set mode.

✓ **CONVENIENT**

Select a tuning step that matches the frequency intervals of repeaters in your area.

[Display example]

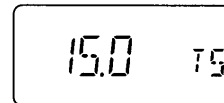

15 kHz tuning step

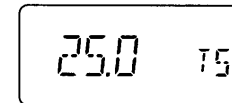

25 kHz tuning step

3 BASIC OPERATION

■ Selecting a memory channel

- ① Push [MR] to select memory mode.
- ② Push 2 digit keys to select the desired memory channel (or rotate [DIAL]).
 - The first nine memory channels are preceded by a "0."
 - To select scan edges 0A to 9B, use [A] for "A" and [B] for "B."
 - Only programmed memory channels can be selected.

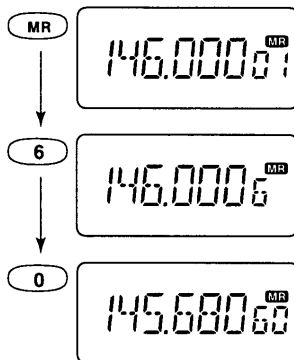

■ Lock function

The lock function prevents accidental frequency changes and accidental function activation.

Push [(CALL)LOCK] for 1 sec. to toggle the lock function on and off.

- "🔑" appears while the lock function is activated.
- [PTT], [PWR], [VOL▲]/[VOL▼], [SQL], and [H/L] can be used even when the lock function is activated.

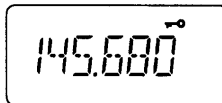

■ Receive and transmit

- ① Push [PWR] for 1 sec. to turn power on.
- ② Push [VOL▲]/[VOL▼] to set a volume level.
 - The volume level is indicated by the S/R/F readout while holding [VOL▲]/[VOL▼].
- ③ Set the squelch level.
 - While pushing [SQL], rotate [DIAL].
 - 10 selections are available, "OPEN", "AUTO", and "SQL 1" to "SQL 8."
- ④ Set an operating band and frequency.

When a signal is received:

 - ➔ Squelch opens and audio is emitted from the speaker.
 - ➔ The S/R/F indicator shows the relative signal strength.
- ⑤ Push [H/L] to toggle output power between high and low.
 - "LOW" appears when low output power is selected.
- ⑥ Push and hold [PTT] to transmit; then speak into the mic.
 - **Do not** hold the microphone too close to your mouth or speak too loudly. This may distort the signal.
 - The S/R/F indicator shows the output power selection.
- ⑦ Release [PTT] to return to receive.

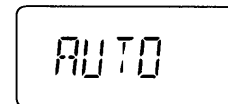

✓ CONVENIENT

Monitor function: Push and hold [SQL] to listen to weak signals that do not open the squelch.

■ FM broadcast reception

The transceiver can receive FM radio broadcasts. These are typically in the range 76–107.995 MHz and are in WFM receive mode.

To select the FM broadcast band:

- ➔ Push [BAND] one or more times until “WFM” appears in the display;

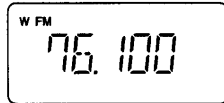

- or,
- ➔ Select a frequency with the digit keys directly.
 - “WFM” automatically appears when a frequency in the range 76–107.995 MHz is input.

🔊 **NOTE:** When pushing [PTT], “OFF” appears indicating the frequency and mode are outside the permitted range.

■ Air band reception

The transceiver can receive frequencies reserved for commercial/private aircraft and ground support. These are in the range 118–135.995 MHz and are in AM receive mode.

To select the air band:

- ➔ Push [BAND] one or more times until the AM indicator appears in the display (see right); or,

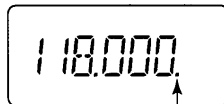

AM receive indicator

- ➔ Select a frequency with the digit keys directly.
 - The AM indicator automatically appears when a frequency in the range 118–135.995 MHz is input.

🔊 **NOTE:** When pushing [PTT], “OFF” appears indicating the frequency and mode are outside the permitted range.

■ Narrow FM operation

(Europe, Italy versions only)

- ① Push band one or more times to select the 144 MHz band.
- ② Push [#(T SCAN)] to toggle between wide and narrow FM operation.
 - “FM” appears when narrow FM operation is selected—max. deviation is ± 2.5 kHz.
 - No indicator appears when regular FM operation is selected (same as for operation on other bands).

🔊 **NOTE:** When FM narrow operation is selected, memory and call modes operate in FM narrow also.

◇ FM narrow/regular lock

Push [#(T SCAN)] + [PWR] to turn power on and lock the transceiver in FM narrow or regular FM operation.

- When locked, pushing [#(T SCAN)] DOES NOT toggle between FM narrow and regular FM operation.

■ General

When using a repeater, the transmit frequency is shifted from the receive frequency by the offset frequency. It is convenient to program repeater information into memory channels (pgs. 15–17).

- ① Set the operating band and receive frequency (repeater output frequency).
- ② Push [TONE(DUP)] for 1 sec. once to select – DUP or twice to select DUP.
 - “– DUP” or “DUP” appears to indicate the transmit frequency for minus shift or plus shift, respectively.
 - When the auto repeater function is in use (U.S.A. version only) this selection and step ③ are not necessary (p. 14).
- ③ Push [TONE] to activate the subaudible tone encoder, according to repeater requirements.
 - “T” appears.
 - Refer to the table of tone frequencies on the following page.
- ④ Push and hold [PTT] to transmit.
 - The displayed frequency automatically changes to the transmit frequency (repeater input frequency).
 - If “OFF” appears, check the offset frequency (p. 13).
- ⑤ Release [PTT] to receive.
- ⑥ Push and hold [SQL] to check whether the other station’s transmit signal can be directly received or not.

◇ Tone information

Some repeaters require a tone to be accessed. In this case, precede step ④ at left with the required tone.

DTMF TONES (U.S.A. and Asia versions only)

While pushing [PTT], push the desired digit key(s) to transmit DTMF tones.

- The transceiver has 9 DTMF memory channels. See p. 18 for details.

1750 Hz TONE (Europe and Italy versions only)

While pushing [PTT], push and hold [TONE] for 1 to 2 sec. to transmit a 1750 Hz tone signal.

✓ CONVENIENT

Tone scan function: When you don’t know the subaudible tone used for a repeater, the tone scan is convenient for detecting the tone frequency.

Push and hold [T SCAN] to activate. See p. 23 for more information.

■ Subaudible tones for repeater use

USING SET MODE

Some repeaters require subaudible tones to be accessed. Subaudible tones are superimposed over your normal signal and must be set in advance.

- ① Push [VFO] to select VFO mode.
- ② Push [BAND] to select a band.
- ③ Push [(H/L)SET] for 1 sec. to enter set mode.
- ④ Push [TONE] or [H/L] several times until "rT" appears.
- ⑤ Rotate [DIAL] to select the desired subaudible tone.
- ⑥ Push [VFO(CLR)] to exit set mode.

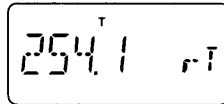
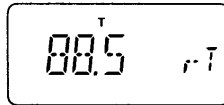

• Available subaudible tone frequencies (unit: Hz)

67.0	79.7	94.8	110.9	131.8	156.7	171.3	186.2	203.5	229.1
69.3	82.5	97.4	114.8	136.5	159.8	173.8	189.9	206.5	233.6
71.9	85.4	100.0	118.8	141.3	162.2	177.3	192.8	210.7	241.8
74.4	88.5	103.5	123.0	146.2	165.5	179.9	196.6	218.1	250.3
77.0	91.5	107.2	127.3	151.4	167.9	183.5	199.5	225.7	254.1

■ Setting an offset frequency

USING SET MODE

When communicating through a repeater, the transmit frequency is shifted from the receive frequency by an amount determined by the offset frequency.

- ① Push [VFO] to select VFO mode.
- ② Push [BAND] to select a band.
- ③ Push [H/L(SET)] for 1 sec. to enter set mode.
- ④ Push [TONE] or [H/L] several times until "OW" appears.
- ⑤ Rotate [DIAL] to select the desired offset.
 - The offset frequency changes according to the selected tuning steps.
 - The MHz step may be helpful for large frequency changes—push [VFO(MHz)] for 1 sec.
- ⑥ Push [VFO(MHz)] to exit set mode.

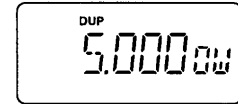

4 REPEATER OPERATION

■ Auto repeater function (U.S.A. version only)

USING INITIAL SET MODE

The U.S.A. version automatically activates the repeater settings (duplex on/off, duplex direction, tone encoder on/off) when the operating frequency falls within the general repeater output frequency range. The offset and repeater tone frequencies are not changed by the auto repeater function, reset these frequencies, if necessary.

- ① Turn power on while pushing [H/L(SET)] to enter initial set mode.
- ② Push [H/L] or [TONE] one or more times until "Ar" appears.
- ③ Rotate [DIAL] to turn the auto repeater function on ("ON1" or "ON2") or off.
- ④ Push [VFO] to exit initial set mode.

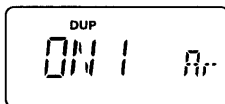

Activates for duplex only.

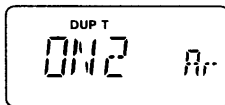

Activates for duplex and tone.

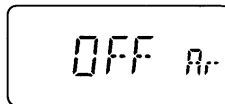

Auto repeater function is turned off.

• Frequency range and offset direction

FREQUENCY RANGE	DUPLEX DIRECTION
145.200–145.495 MHz 146.610–146.995 MHz	"–DUP" appears
147.000–147.395 MHz	"DUP" appears
442.000–444.995 MHz	"DUP" appears
447.000–449.995 MHz	"–DUP" appears
51.620–51.980 MHz 52.500–52.980 MHz 53.500–53.980 MHz	"–DUP" appears

■ General

The transceiver has 123 memory channels (100 regular, 10 pairs of scan edge channels for mixed bands and 1 call channel for each band—VHF, UHF and 50 MHz). Note that memory channels are not grouped according to band. In other words, a given memory channel can be programmed with either a VHF frequency, a UHF frequency or a 50 MHz band frequency. This is not the case with call channels. Call channels are band specific.

The following can be programmed into memory/call channels:

- Operating frequency
- Duplex direction with an offset frequency (pgs. 12, 13)
- Subaudible tone encoder or tone squelch on/off with a tone (CTCSS) frequency (pgs. 12, 22)
- Skip information (p. 21)

📌 NOTE:

- Memory channels can be assigned names (of up to 4 characters) using an IBM compatible PC and the optional CS-T8 CLONING SOFTWARE.
- When memory names are assigned, each push of [MR] toggles between frequency and name indication (or channel and name indication in channel indication mode).

■ Programming during selection

① Push [VFO] to select VFO mode.

② Set the desired frequency:

- Set other data, such as repeater information, etc. using set mode if required.



③ Push [S.MW] momentarily.

- “[MR]” and the previously selected memory channel number flash.
- Do not hold [S.MW] for more than 1 sec., otherwise the memory channel will be overwritten.

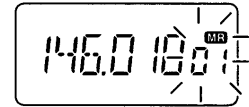

④ Rotate [DIAL] to select the desired channel.

- Call channel and scan edge channels, as well as regular memory channels, can be programmed in this way.

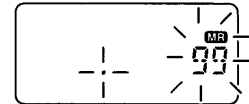

- Only the decimal point appears for memories not yet programmed.

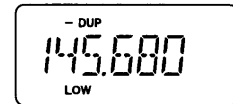

- If you want to confirm the VFO frequency, push [S.MW] momentarily—the VFO frequency appears briefly.

⑤ Push [S.MW] for 1 sec. to program.

- “[MR]” and the memory channel number stop flashing.
- VFO mode is selected.

5 MEMORY/CALL CHANNELS

■ Programming after selection

- ① Select the memory channel to be programmed:

➔ Push [MR] to select memory mode.

➔ Rotate [DIAL] (or use the keypad) to select the memory channel.

• Non-programmed channels cannot be selected.

- ② Set the desired frequency in VFO mode:

➔ Push [VFO] to select VFO mode.

➔ Set the desired frequency using the keypad or [DIAL].

➔ Set other data, if desired.

- ③ Push [S.MW] for 1 sec. to program.

- ④ Push [MR] to confirm that the memory channel has been programmed, if desired.

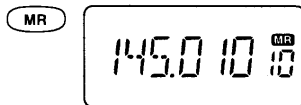

Select memory ch.

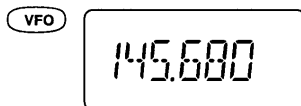

Set freq. in VFO mode

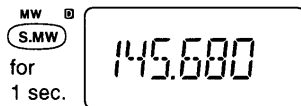

■ Editing

◇ Memory/call ⇒ VFO

- ① Select the memory/call channel to be transferred:

➔ Push [MR] (or [CALL]) to select memory (call) mode.

➔ Rotate [DIAL] (or use the keypad) to select the memory channel.

- ② Push [S.MW] for 1 sec. to transfer to VFO.

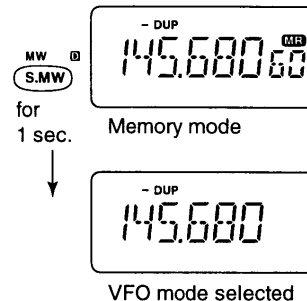

◇ Memory/call ⇒ call/memory

① Select the memory/call channel to be transferred:



➔ Push [MR] (or [CALL]) to select memory (call) mode.

➔ Rotate [DIAL] (or use the keypad) to select the memory channel.

② Push [S.MW] momentarily.



- A beep sounds, "VF" appears and "MR" flashes.
- Do not hold [S.MW] for more than 1 sec., otherwise the memory channel will overwrite the VFO.

③ Rotate [DIAL] to select a memory or call channel to transfer the data to.



④ Push [S.MW] for 1 sec. to program.

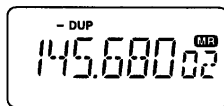

- "MR" stops flashing.

◇ Memory clear

① Push [S.MW] momentarily.

② Select the memory channel to be cleared with [DIAL].

③ Push [S.MW] briefly, then a second time for 1 sec.



- 3 beeps sound, then the frequency is cleared.
- "MR" and the memory channel number flash continuously.
- Scan edges 0A/0B and call channels cannot be cleared.

④ Push [VFO] to select VFO mode.

👉 **NOTE:** Be careful—the contents of cleared memories **cannot** be recalled.

■ Programming a DTMF code

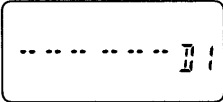
The transceiver has 9 DTMF memory channels (D1 to D9) for storage of often-used DTMF codes of up to 16 digits.

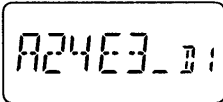
- ① Push [(*)DTMF • M] for 1 sec. to enter DTMF memory mode.
- ② Rotate [DIAL] to select the desired channel.
 
- ③ Push [H/L(SET)] for 1 sec. to enter DTMF programming mode.
 - “-----” appears.
 
 - Programmed DTMF memories can be cleared in this way.
- ④ Push digit keys to enter the desired DTMF code.
 - A maximum of 16 digits can be input.
 - If a digit is mistakenly input, push [H/L] then repeat from step ③.
- ⑤ Push [H/L(SET)] to input the digits.
 - A beep sounds.
 - To program additional DTMF memories, repeat from step ②.
- ⑥ Push [VFO] or [SQL] to exit DTMF programming mode.
 - When pushing [SQL], the programmed contents can be monitored.

■ Transmitting a DTMF code

- ① Select the DTMF channel to be transmitted:
 - Push [(*)DTMF • M] for 1 sec. to select DTMF memory mode.
 - Rotate [DIAL] to select the desired DTMF channel.
- ② While pushing [PTT], push [SQL] to transmit the selected DTMF channel's contents.

◇ DTMF transmit speed

USING INITIAL SET MODE

When slow DTMF transmission speeds are required (such as for some repeaters) the transceiver's rate of DTMF transmission can be adjusted.

- ① Turn power on while pushing [H/L(SET)] to enter initial set mode.
- ② Push [H/L] or [TONE] one or more times until “DT” appears.
- ③ Rotate [DIAL] to select the desired DTMF transmission speed.
- ④ Push [VFO] exit initial set mode.

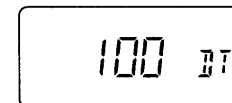

fastest (100 msec. intervals)

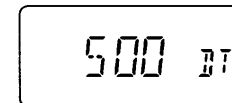

slowest (500 msec. intervals)

Scan types

FULL SCAN (p. 20)

Repeatedly scans all frequencies over a selected band.

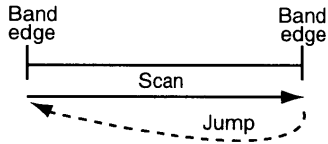

PROGRAMMED SCAN (p. 20)

Repeatedly scans between two user-programmed frequencies. Used for checking for frequencies within a specified range such as repeater output frequencies.

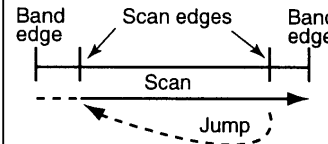

MEMORY SCAN (p. 20)

Repeatedly scans all programmed memory channels.

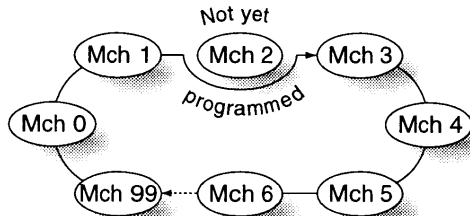

MEMORY SKIP SCAN (p. 20)

Repeatedly scans all memories, except those set as skip channels.

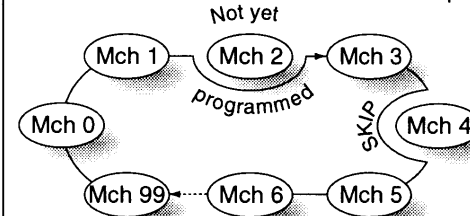

NOTE:

Push [BAND] during full/programmed scan to change the band being scanned or to select a different pair of scan edges.

Push [BAND] during memory (skip) scan to change memory channel groups: VHF, UHF, 50 MHz, air band or WFM programmed memories; or, all programmed memories.

■ Full/programmed scan

- ① Push [VFO] to select VFO mode.
- ② Push [(BAND)SCAN] for 1 sec.; then, while continuing to push [(BAND)SCAN], rotate the tuning dial to select the desired scan range.
 - The following scan ranges are selectable:
 - “ALL 50” for full scan on the 50 MHz band.
 - “ALL 144” for full scan on the 144 MHz band.
 - “ALL 430” or “ALL 440” for full scan on the 430(440) MHz band.
 - “ALL WFM” for full scan on the WFM (FM broadcast) band.
 - “ALL 118” for full scan on the air band.
 - “PROG 0” to “PROG 9” for one of the programmed scans.
 - After releasing [(BAND)SCAN] the selected scan starts.
 - To activate the previously selected scan, dial rotation is not necessary—just push [(BAND)SCAN] for 1 sec.
 - During scan, the following can be changed:
 - Scan range using [(BAND)SCAN], with/without [DIAL].
 - Scan direction using [DIAL].
- ③ To stop the scan, push [(VFO)CLR].

🔗 **NOTE:** For programmed scan, scan edges must be programmed in advance (0A/0B are programmed by default). Program scan edges in the same manner as regular memory channels (p. 15)

If the same frequencies are programmed into a pair of scan edges, programmed scan does not proceed.

■ Memory (skip) scan

- ① Push [MR] to select memory mode.
- ② Push [(BAND)SCAN] for 1 sec.; then, while continuing to push [(BAND)SCAN], rotate the tuning dial to select the desired band.
 - The following memory groups are selectable:
 - “SEL ALL” scans all programmed memory channels.
 - “SEL 50” scans programmed memories in the 50 MHz band.
 - “SEL 144” scans programmed memories in the 144 MHz band.
 - “SEL 430” or “SEL 440” scans programmed memories in the 430(440) MHz band, depending on version.
 - “SEL WFM” scans all programmed WFM channels.
 - “SEL 118” scans all programmed air band channels.
 - After releasing [(BAND)SCAN], the selected scan starts.
 - To activate the previously selected scan, dial rotation is not necessary—just push [(BAND)SCAN] for 1 sec.
 - During scan, the following can be changed:
 - Memory groups using [(BAND)SCAN], with/without [DIAL].
 - Scan direction using [DIAL].
- ③ To stop the scan, push [(VFO)CLR].

🔗 **NOTE:** For memory skip scan, program memory channels you don't want to search, as “skip” channels (p. 21). Scan proceeds as above except that any channels specified as skip channels are not searched.

■ Skip channel setting

Memory channels can be set to be skipped during memory scan. This is useful to speedup the memory scan interval.

- ① Select the memory channel to be programmed as a skip channel:
 - ➔ Push [MR] to select memory mode.
 - ➔ Rotate [DIAL] (or use the keypad) to select a memory channel.

- ② Push [(MR)SKIP] for 1 sec. to set the memory channel as a skip channel.

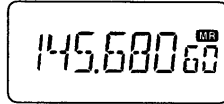

- "SKIP" appears.

- ③ Repeat step ② to cancel a skip channel.

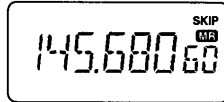

- "SKIP" disappears.

👉 **NOTE:** Scan edge channels, 0A to 9B, cannot be set to show "SKIP" settings, however, they will be skipped during memory scan.

■ Scan resume condition

USING SET MODE

The resume condition can be selected as a pause or timer scan. This setting is common for all scans.

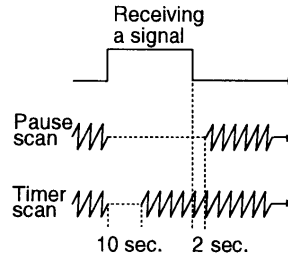

When receiving a signal, pause scan pauses until the signal disappears; timer scan pauses for 10 sec.

- ① Push [(H/L)SET] for 1 sec. to enter set mode.
- ② Push [H/L] or [TONE] one or more times until "SC" appears.
- ③ Rotate [DIAL] to select the desired scan resume condition.
 - "T-10": scan pauses for 10 sec. on a received signal.
 - "P-02": scan pauses on a received signal until it disappears.
- ④ Push [(VFO)CLR] to exit set mode.

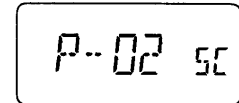
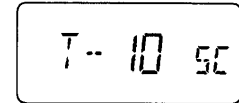

■ Tone squelch

◇ Operation

The tone squelch opens only when receiving a signal containing a matching subaudible tone. You can silently wait for calls from group members using the same tone.

- ① Set the operating frequency.
- ② Set the desired subaudible tone in set mode.
 - See right for programming.
- ③ Push [TONE] one or more times until "TSQL" appears.
- ④ When the received signal includes a matching tone, squelch opens and the signal can be heard.
 - When the received signal's tone does not match, tone squelch does not open, however, the S-indicator shows signal strength.
 - To open the squelch manually, push and hold [SQL].
- ⑤ Operate the transceiver in the normal way.
- ⑥ To cancel the tone squelch, push [TONE].

NOTE: The transceiver has 50 tone frequencies and consequently their spacing is narrow compared with units having 38 tones. Therefore, some tone frequencies may receive interference from adjacent tone frequencies.

✓ CONVENIENT

Store subaudible tone frequencies and tone squelch on/off settings in memory or call channels for easy recall.

◇ Setting subaudible tones for tone squelch operation (CTCSS* tones)

USING SET MODE

Separate tone frequencies can be set for tone squelch operation than for repeater operation (the same range of tones is available—see below). Like repeater tones, these are set in set mode.

- ① Select VFO or a memory channel.
- ② Push [(H/L)SET] for 1 sec. to enter set mode.
- ③ Push [TONE] or [H/L] one or more times until "CT" appears.
- ④ Rotate [DIAL] to select the desired subaudible tone.
- ⑤ Push [(VFO)CLR] to exit set mode.

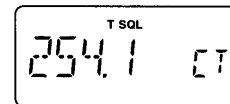
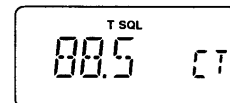

• Available subaudible tone frequencies (unit: Hz)

67.0	79.7	94.8	110.9	131.8	156.7	171.3	186.2	203.5	229.1
69.3	82.5	97.4	114.8	136.5	159.8	173.8	189.9	206.5	233.6
71.9	85.4	100.0	118.8	141.3	162.2	177.3	192.8	210.7	241.8
74.4	88.5	103.5	123.0	146.2	165.5	179.9	196.6	218.1	250.3
77.0	91.5	107.2	127.3	151.4	167.9	183.5	199.5	225.7	254.1

*CTCSS stands for continuous tone coded squelch system.

■ Tone scan

The transceiver can detect the subaudible tone frequency in a received signal. By monitoring a signal, such as that being transmitted on a repeater input frequency, you can determine the tone frequency required to access the repeater.

- ① Set the desired frequency or memory channel to be checked for a tone frequency.
- ② Push [T • SCAN] for 1 sec. to start the tone scan.
 - To change the scanning direction, rotate [DIAL].
- ③ When the tone frequency is decoded, the set mode contents are programmed with the tone frequency.
 - The decoded tone frequency is used for the tone encoder or tone decoder, depending on the the tone squelch ON/OFF setting.
 - “CT” appears during tone scan when the tone squelch is activated; “rT” appears when the tone squelch is not activated.
 - Subaudible tone frequencies flash as they are scanned.

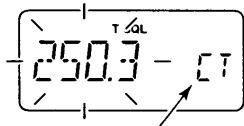

“CT” appears during tone scan with tone squelch

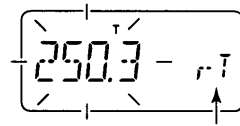

“rT” appears during tone scan without tone squelch

- ④ Push [VFO] to stop the scan.

■ Pocket beep

This function uses subaudible tones for calling and can be used as a “common pager” to inform you that someone has called while you were away from the transceiver.

◇ Waiting for a call from a specific station

- ① Set the operating frequency.
- ② Set the desired subaudible tone (same as that used for tone squelch operation, “CT”) in set mode.
 - See p. 22 for programming.
- ③ Push [TONE] two times until “TSQL ((·))” appears.
- ④ When a signal with a matched tone is received, the transceiver emits beep tones for 30 sec. and flashes “((·)).”
- ⑤ Push [PTT] to answer or push [VFO] to stop the beeps and flashing.
 - Tone squelch is automatically selected.

◇ Calling a waiting station using pocket beep

A subaudible tone matched with the station’s tone frequency is necessary. Use the tone squelch on the opposite page or a subaudible tone encoder.

■ Help function

When in set mode or initial set mode and no operation is performed for 5 sec., the name of the selected item scrolls across the function display for convenience.

■ Initial set mode

AT POWER ON

Initial set mode is accessed at power on and allows you to set seldom-changed settings. In this way you can “customize” transceiver operation to suit your preferences and operating style.

- ① While pushing [(H/L)SET], turn power on to enter initial set mode.
- ② Push [H/L] or [TONE] one or more times until the desired item appears.
- ③ Rotate [DIAL] to select the desired setting.
- ④ Push [VFO] to exit initial set mode.

◇ Optional HM-75A functions USING INITIAL SET MODE

This item turns the microphone simple mode to one of two settings or off. Microphone simple mode is used to change the function assignments for switches on the optional HM-75A REMOTE CONTROL MICRO-

PHONE as below. These assignments are convenient for 3-channel use of simple operation.

NOTE: VFO mode cannot be selected via the microphone when SIMPLE mode is selected.

SWITCH	NORMAL 1/NORMAL 2	SIMPLE
	NORMAL 1: BAND Selects a band. No function in memory mode.	MONITOR Toggles squelch between open and closed.
	NORMAL 2: MONITOR Toggles squelch between open and closed.	
	VFO/MEMORY Toggles VFO and memory mode.	CALL Selects the call channel.
	Change the frequency or memory channel when pushed. Start previously selected scan when pushed and held. <ul style="list-style-type: none"> • Normal 2 (while squelch is open): Adjust volume. 	M00 Selects memory channel 1.
		M01 Selects memory channel 2.

NOTE: During transmit, pushing [A] transmits a 1750 Hz tone for Europe and Italy versions.

◇ Auto-power off

The transceiver can be set to automatically turn off after a specified period in which no switch is pushed. 60 min., 40 min., 20 min. and off can be specified. This setting is retained even after the transceiver is turned off.

USING INITIAL SET MODE

OFF AO

60 AO

◇ Display backlighting

When set to AUTO, display backlighting automatically turns on when a key is pushed, and then turns off automatically; when set to OFF, display backlighting cannot be turned on; when set to ON, display backlighting remains on continuously.

USING INITIAL SET MODE

AUTO LI

OFF LI

ON LI

◇ LCD contrast

This item sets function display contrast to one of two levels. "1" is for low contrast and "2" is for high contrast.

USING INITIAL SET MODE

1 LC

low contrast

2 LC

high contrast

◇ Beep tones

Switch and function confirmation beep tones can be turned on or off as you prefer.

USING INITIAL SET MODE

ON BE

OFF BE

9 OTHER FUNCTIONS

◇ Power saver

This item sets the power saver duty cycle—the ratio of receive circuit on to receive circuit off while standing by. The duty cycle can be set to auto, 1:4, or off. Setting to auto conserves the most battery power.

USING INITIAL SET MODE

AUTO PS

1:4 PS

AUTO	Selects "1:4" duty ratio when receiving no signal for 5 sec., then "1:8" 60 sec. after that.	The power saver is deactivated when more than 12 V DC is connected to the [13.5VDC] jack.
1:4	Standby : 150 msec. Circuit idle : 600 msec.	
OFF	No power save function.	

◇ Battery voltage indication

This sets the battery voltage indication on or off. When set to on, the battery voltage is indicated for 2 sec. at power on (LOW V, 3.5–16 V in .05 V steps). If the voltage surpasses 16 V, "OVER V" appears and flashes regardless of this setting.

USING INITIAL SET MODE

ON VO

OFF VO

■ Channel indication mode

AT POWER ON

Channel indication mode is used to simplify operation. In this mode only pre-programmed memory channel numbers are displayed and functions are limited ([PWR], [PTT], [SQL], [H/L], [SCAN], [LOCK] and the tuning dial are functional).

- While pushing [MR], push [PWR] for 1 sec. to turn power on.
- Repeat this operation to return to normal indication.
 - Frequencies must be programmed into memory channels in advance.

■ Resetting the CPU

AT POWER ON

Reset the CPU before operating the transceiver for the first time, or when the internal CPU malfunctions.

While pushing [MR] + [VFO] + [BAND], push [PWR] for 1 sec. to turn power on and reset the transceiver.

▼ **CAUTION:** Resetting the CPU returns all programmed contents to their default settings.

■ Handheld-to-handheld cloning

at POWER ON

Cloning allows you to quickly and easily transfer the programmed contents from one transceiver to another transceiver; or, data from a PC to a transceiver using the optional CS-T8 CLONING SOFTWARE.

- ① Connect the OPC-474 cloning cable with adapter plugs to the [SP] jack of the master and slave transceivers.
 - The master transceiver is used to send data to the slave transceiver.
- ② While pushing [S.MW], turn power on to enter cloning mode (master transceiver only—power on only for slave transceiver).
 - “CLONE” appears and the transceivers enter the clone standby condition.
- ③ Push [PTT] on the master transceiver.
 - “CLOUT” appears in the master transceiver’s display and the S/RF indicator shows that data is being transferred to the slave transceiver.
 - “CL IN” appears automatically in the slave transceiver’s display and the S/RF indicator shows that data is being received from the master trans-

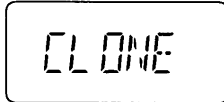
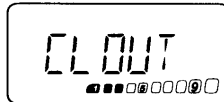
ceiver.

- ④ When cloning is finished, turn power off, then on again to exit cloning mode.

◇ Cloning using a PC

Data can be cloned to and from a PC (IBM compatible) using the optional CS-T8 CLONING SOFTWARE and the optional OPC-478 CLONING CABLE. Cloning from a PC allows you to name memory channels. Consult the CS-T8 CLONING SOFTWARE Read Me files for details.

◇ Cloning error

⚠ **NOTE:** DO NOT push the [PTT] on the slave transceiver during cloning. This will cause a cloning error.

When the display at right appears, a cloning error has occurred.

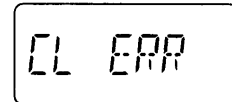

In such a case, both transceivers automatically return to the clone standby condition and cloning must be repeated.

10 BATTERY PACKS AND CHARGING

■ General

The supplied* BP-199 or BP-200 BATTERY PACK includes rechargeable Ni-MH batteries and can be charged approx. 300 times. Charge the battery pack before first operating the transceiver or when the battery pack becomes exhausted.

*Optional for versions which come with the BP-197 BATTERY CASE.

If you want to get the longest life out of your battery pack (300+ charges), the following points should be observed:

1. Avoid overcharging. The charging period should be less than 15 hours.
2. Use the battery until it becomes almost completely exhausted under normal conditions. We recommend battery charging just after transmitting becomes impossible.

■ Charging precautions

NEVER attempt to charge alkaline batteries. This will cause internal liquid leakage and damage the battery case and transceiver.

NEVER connect two or more chargers at the same time.

Charging may not occur under temperatures of 10°C (50°F) or over temperatures of 40°C (104°F).

■ About the battery pack

◇ Operating period

Depending on the attached battery pack, the operating period of the transceiver varies. When the approx. voltage of battery packs BP-198 to BP-200 falls to 4, 5 or 8 V, respectively, charging is necessary. Refer to p. 32 for battery pack specifications.

◇ Battery pack life

If your battery pack seems to have no capacity even after being fully charged, completely discharge it by leaving the power on overnight. Then, fully charge the battery pack again. If the battery pack still does not retain a charge (or very little), a new battery pack must be purchased.

⚠ **NOTE:** When using a battery pack for the first time or after long periods of inactivity between charges (approx. 2 months or more), the battery pack will not be able to retain a full charge immediately. Subsequent charge/discharge cycles will eventually bring the battery pack up to full charge capacity.

■ Charging connections

◇ Regular charging

Attach the supplied* or optional battery pack; then, connect the supplied* wall charger via an AC outlet as shown at right.

*Optional for versions which include a battery case.

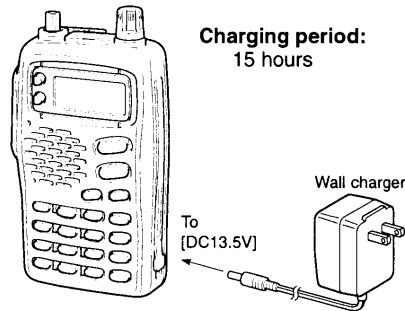

Charging periods: 1 hour (w/BP-198 or BP-199)
1.5 hours (w/BP-200)

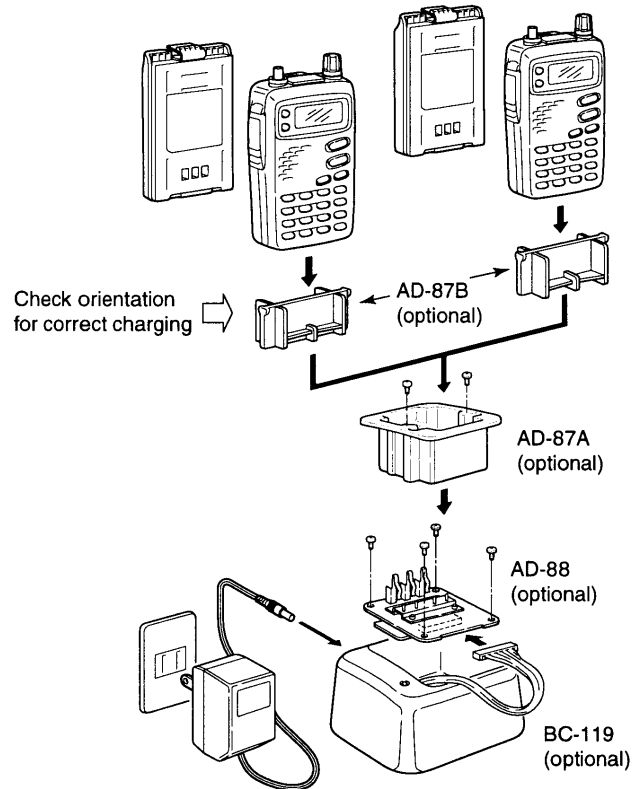

◇ Rapid charging with the BC-119

- ① Fix the optional AD-88 TERMINAL PC BOARD FOR CHARGER into the BC-119 with the 4 supplied screws.
- ② Insert the optional AD-87A CHARGE ADAPTER into the charging slot of the BC-119.
- ③ Insert the optional AD-87B CHARGE ADAPTER into the AD-87A (check orientation).
- ④ Insert the battery pack, either by itself or attached to the transceiver, into the whole assembly for charging (see right).

10 BATTERY PACKS AND CHARGING

◇ Operation with an optional cable

Connect an optional charger or cable to the transceiver as illustrated below. Be careful of battery overcharging as the connected battery is charged simultaneously.

▼ **CAUTION:** When the BP-197 BATTERY CASE is connected, charging cannot take place.

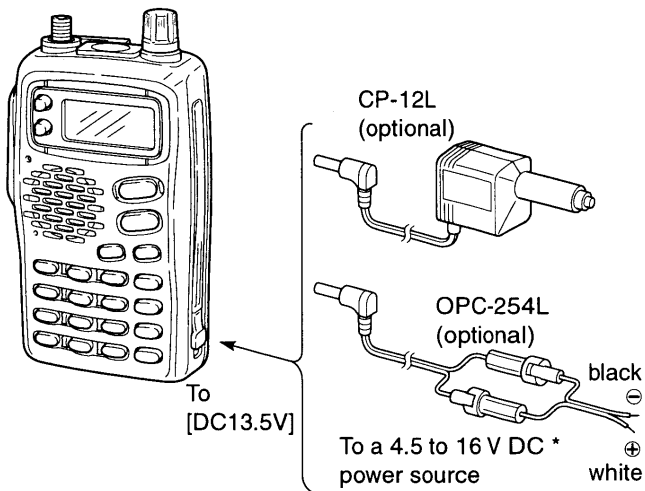

*To charge the battery pack 13 to 16 V DC is necessary.

■ Battery case

When using a battery case attached to the transceiver, install 3 AA(R6) size alkaline batteries as illustrated below.

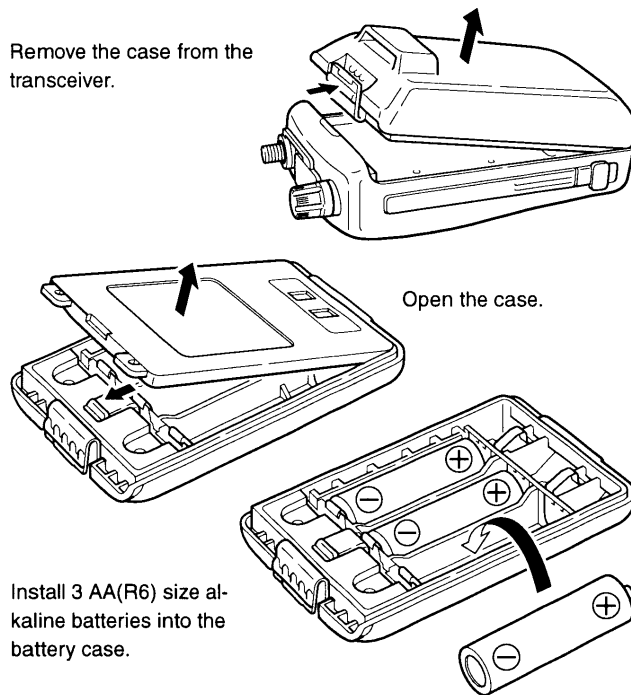



If your transceiver seems to be malfunctioning, please check the following points before sending it to a service center.

PROBLEM	POSSIBLE CAUSE	SOLUTION	REF.
No power comes on.	<ul style="list-style-type: none"> The battery is exhausted. (A slight current flows in the circuits even when the power is off.) 	<ul style="list-style-type: none"> Charge the battery pack or place new dry cell batteries in the battery case. (Remove the battery pack if you will not be using the transceiver for a long time.) 	pgs. 29, 30
	<ul style="list-style-type: none"> Poor plug connection to the external DC power cable. 	<ul style="list-style-type: none"> Check the connector or remove and replace the cable. 	—
Transmitting is impossible.	<ul style="list-style-type: none"> The battery is exhausted. 	<ul style="list-style-type: none"> Charge the battery pack or place new dry cells in the battery case. 	pgs. 29, 30
Frequency cannot be set.	<ul style="list-style-type: none"> Memory mode, call channel or channel indication mode is selected. The lock function is activated. 	<ul style="list-style-type: none"> Push [VFO] to select VFO mode; or push [MR] at power on to cancel channel indication. Push [LOCK(CALL)] for 1 sec. to turn it off. 	pgs. 8, 26 p. 10
Scan does not function.	<ul style="list-style-type: none"> The same frequencies are programmed into XA and XB (a pair of scan edge channels). 	<ul style="list-style-type: none"> Program different frequencies. 	p. 15
[▲] or [▼] keys do not function when using the optional HM-75A.	<ul style="list-style-type: none"> Memory channels 1 and/or 2 are not programmed and simple mode is selected. 	<ul style="list-style-type: none"> Program the memory channels or set to microphone normal 1 or normal 2. 	pgs. 15, 24
Squelch does not open for received signals.	<ul style="list-style-type: none"> Tone squelch is activated. 	<ul style="list-style-type: none"> Turn off the tone squelch. 	p. 22
No beep sounds even when a key is pushed.	<ul style="list-style-type: none"> Beep tones are turned off in initial set mode. 	<ul style="list-style-type: none"> Set beep tones on in initial set mode. 	p. 25

12 OPTIONS

◇ Battery packs

BATTERY PACK	VOLTAGE	CAPACITY	OUTPUT POWER	OPER. PERIOD*
BP-197	Battery case for R6(AA) x 3 alkaline cells		0.8 W	9.1 h
BP-198	4.8 V	700 mAh	1.2 W	3.8 h
BP-199	6.0 V	700 mAh	2.0 W	3.5 h
BP-200	9.6 V	680 mAh	4.5 W	3.8 h

*Operating periods are calibrated for the following conditions:

Tx : Rx : standby=1 : 1 : 8 min.

◇ Chargers and cables

BC-110A/D/V WALL CHARGER

Regularly charge battery packs attached to the transceiver in 15 hrs.

BC-119 DESKTOP CHARGER +

AD-88 TERMINAL PC BOARD FOR CHARGER +

AD-87 DESKTOP CHARGER ADAPTER

Rapidly charge battery packs in 1 to 1.5 hrs. depending on the battery pack. An AC adapter is packed with the BC-119 (except for the UK version). The AD-87 must be used with the BC-119 for charging the battery pack. The CP-17L or OPC-515L can be used instead of the supplied AC adapter.

CP-12L CIGARETTE LIGHTER CABLE WITH NOISE FILTER

For operation and charging via a 12 V cigarette lighter socket.

OPC-254L DC POWER CABLE

For operation and charging via an external power supply.

◇ Speaker-microphones

HM-46



HM-54



HM-75A



HS-85

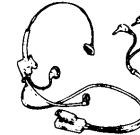

- PTT switch
- VOX
- One-touch PTT for hands-free operation

Remote control capability (see p. 24)

◇ Others

CS-T8 CLONING SOFTWARE

LC-147 CARRYING CASES

SP-13 EARPHONE

Provides clear receive audio in noisy environments.

SPECIFICATIONS 13

- Frequency coverage (MHz):

	50 MHz	VHF	UHF
USA	50–54	Tx: 144–148	Tx: 440–450* ³
		Rx: 118–174* ¹	Rx: 400–470* ³
Europe	50–52 (Rx only)	144–146	430–440
Italy	50–52 (Rx only)	Tx: 144–148	Tx: 430–440
		Rx: 136–174* ¹	Rx: 400–470* ²
Asia	50–54	Tx: 144–148	430–440
		Rx: 118–174* ¹	

Guaranteed range (MHz): *¹144–148, *²430–440 *³440–450

- Mode: FM (F3E), WFM (Rx only), AM (118–135.995 MHz; Rx only)
- Frequency stability: ±10 ppm (0°C to 50°C; 32°F to 122°F)
- No. of memory channels: 123 (incl. 10 scan edges + 1 call channel for each band)
- Antenna connector: SMA (50 Ω)
- Usable battery pack/case: BP-198–BP-200/BP-197
- Power supply requirement: 4.5–16 V DC (neg. ground)
- Current drain (at 13.5 V DC):

Transmit	high	1.8 A
	low	1.0 A
Receive	max. audio	250 mA (typical)
	standby	16 mA (typical)
- Usable temperature range: –10°C to 60°C; 14°F to 140°F
- Dimensions: 106(W) × 58(H) × 28.5(D) mm; 4³/₁₆(W) × 2⁵/₁₆(H) × 1¹/₈(D) in
- Weight (w/BP-198): 270 g; 9½ oz

GENERAL

TRANSMITTER

- Output power (13.5 V DC): 5 W (high) 0.5 W (low)
- Modulation system: Variable reactance frequency modulation
- Spurious emissions: Less than –60 dB
- Max. freq. deviation: ±5 kHz
- Microphone impedance: 2 kΩ

RECEIVER

- Receive system: Double conversion superheterodyne
- Intermediate frequencies: 1st 41.85 MHz
13.35 MHz WFM
2nd 450 kHz
- Sensitivity (12 dB SINAD): Less than 0.18 μV*
- Squelch sensitivity (threshold): Less than 0.18 μV*
- Selectivity: Less than 15 kHz/–6 dB*
More than 30 kHz/–60 dB*
*Excluding WFM.
- Spurious and image rejection ratio (except 2nd image freq.):
144/50 MHz –60 dB (typical)
430 MHz –50 dB (typical)
- Audio output power: 250 mW (typ. with an 8 Ω load) (at 13.5 V DC)

All stated specifications are subject to change without notice or obligation.

14 OPERATION FLOW CHART

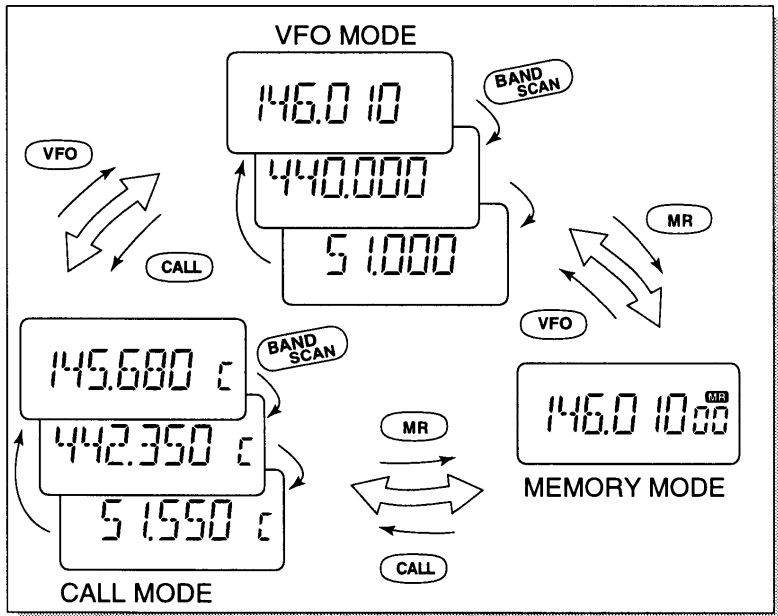

CHANNEL INDICATION MODE

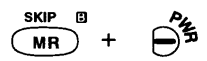

AT POWER ON

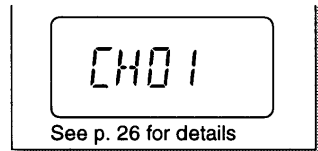

NOTE:

Displays for set and initial set modes show the default settings—rotate [DIAL] to change the condition.

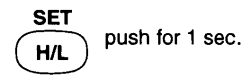

Additional bands may be available in VFO mode depending on version.

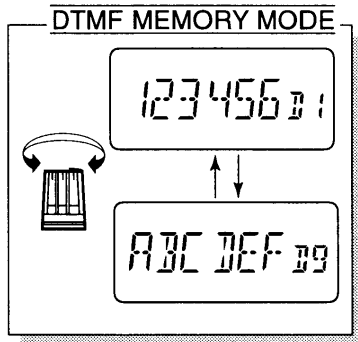
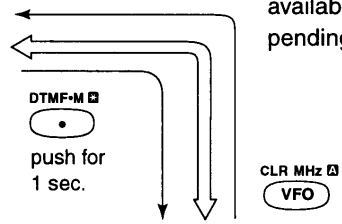

SET MODE

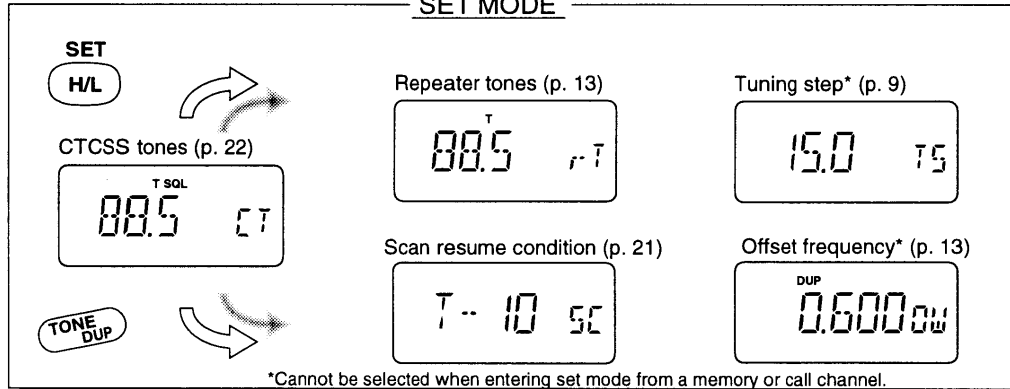

CLR MHz \square
VFO

INITIAL SET MODE

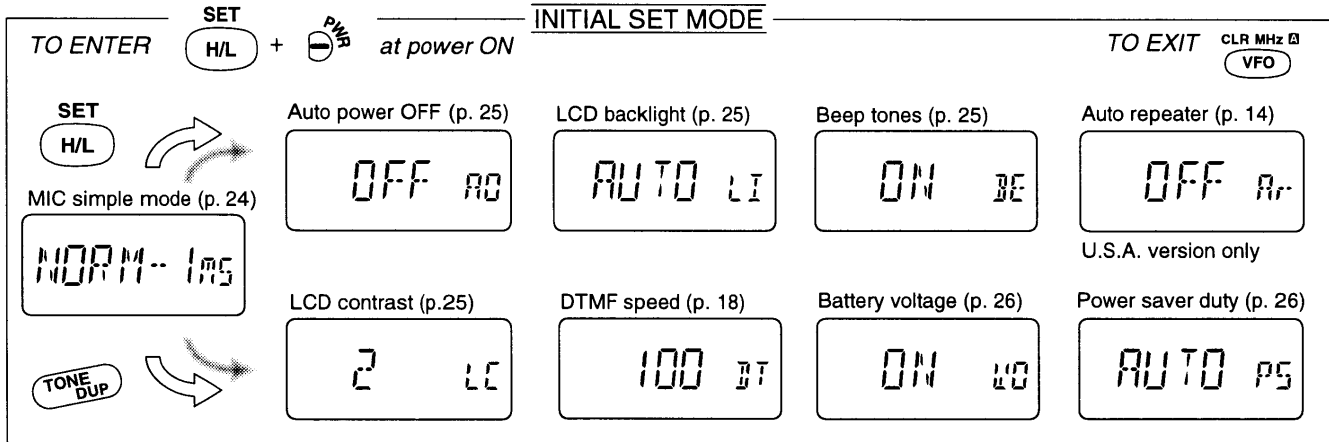

Count on us!

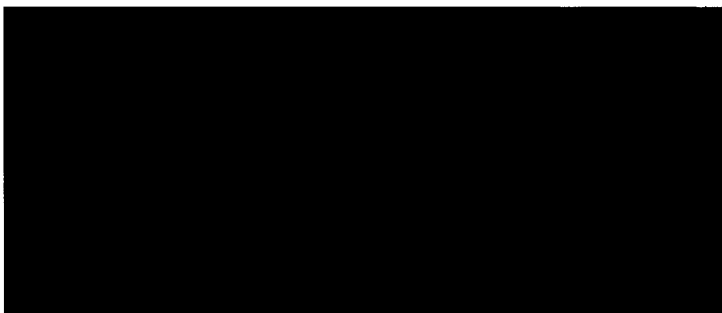

A-5468D-1EX
Printed in Japan
Copyright © 1997 by Icom Inc.

Icom Inc.
6-9-16 Kamihigashi, Hirano-ku, Osaka 547 Japan