



INSTRUCTION MANUAL

COMMUNICATIONS RECEIVER

IC-R10

This device complies with Part 15 of the FCC rules. Operation is subject to the following two conditions: (1) This device may not cause harmful interference, and (2) this device must accept any interference received, including interference that may cause undesired operation.

Icom Inc.

IMPORTANT

READ ALL INSTRUCTIONS CAREFULLY before attempting to operate the receiver.

SAVE THIS INSTRUCTION MANUAL — This instruction manual contains important safety and operating instructions for the **IC-R10**.

EXPLICIT DEFINITIONS

The following explicit definitions apply to this manual.

WORD	DEFINITION
⚠ WARNING	Personal injury, fire hazard or electric shock may occur.
CAUTION	Equipment damage may occur.
NOTE	If disregarded, inconvenience only. No risk of personal injury, fire or electric shock.

 Versions of the IC-R10 which display the “CE” symbol on the serial number seal, comply with the ETSI specification prETS300 684 (EMC product standard for Commercially Available Amateur Radio Equipment).

CAUTIONS

⚠ WARNING! NEVER connect the receiver to an AC outlet. This may pose a fire hazard or result in an electric shock.

⚠ WARNING! NEVER operate the receiver with a headset or other audio accessories at high volume levels. Hearing experts advise against continuous high volume operation. If you experience a ringing in your ears, reduce the volume level or discontinue use.

NEVER connect the receiver to a power source of more than 16 V DC such as a 24 V battery. This connection will ruin the receiver.

NEVER cut the DC power cable between the DC plug and fuse holder. If an incorrect connection is made after cutting, the receiver might be damaged.

NEVER expose the receiver to rain, snow or any liquids.

DO NOT connect the receiver to a power source using reverse polarity. This connection will not only blow fuses but also may damage the receiver.

DO NOT use or place the receiver in areas with temperatures below -10°C ($+14^{\circ}\text{F}$) or above $+50^{\circ}\text{C}$ ($+122^{\circ}\text{F}$) or, in areas subject to direct sunlight, such as the dashboard.

AVOID placing the receiver in excessively dusty environments.

AVOID the use of chemical agents such as benzine or alcohol when cleaning, as they damage the receiver surfaces.

Even when the receiver power is OFF, a slight current still flows in the circuits. Remove cell batteries from the receiver when not using it for a long time. Otherwise, the installed batteries will become exhausted.

For U.S.A. only

Caution: Changes or modifications to this receiver, not expressly approved by Icom Inc., could void your authority to operate this receiver under FCC regulations.

UNPACKING

Accessories included with the receiver:

	Qty.
1 ① Antenna.....	1
1 ② Handstrap.....	1
1 ③ Belt clip (with 2 screws).....	1
4 ④ Wall charger*.....	1
1 ⑤ Ni-Cd batteries	4

*Not supplied with some versions.

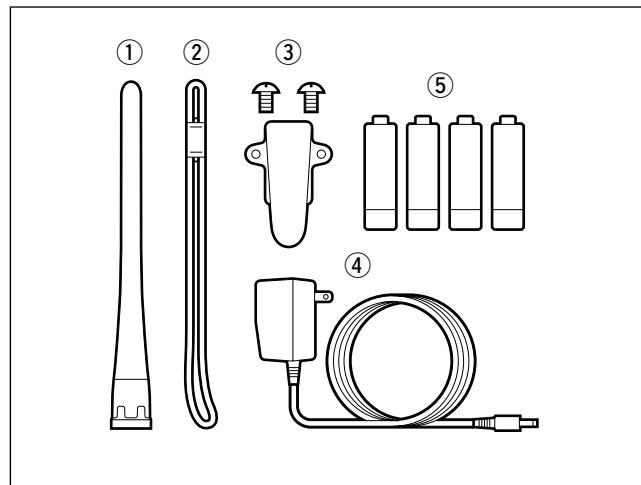

TABLE OF CONTENTS

IMPORTANT	i
EXPLICIT DEFINITIONS	i
CAUTIONS	i
UNPACKING	ii
TABLE OF CONTENTS	iii
OPERATING THEORY	iv
OPERATING NOTES	iv
1 PANEL DESCRIPTION	1–6
■ Front and side panels	1
■ Top panel	2
■ Function display	3
■ Keypad	5
2 Ni-Cd BATTERIES AND ACCESSORIES	7–9
■ Charging Ni-Cd batteries	7
■ Charging precautions	7
■ About Ni-Cd batteries	7
■ Battery installation	8
■ Charging connections	8
■ Accessory attachment	9
3 BASIC OPERATION	10–22
■ General	10
■ Selecting VFO mode	10
■ Selecting a receive mode	12
■ Selecting a tuning step	13
■ Tuning a frequency (via the keypad)	14
■ Tuning a frequency (via the [DIAL])	15
■ Dial select steps	16
■ Band scope function	17
■ Listening example 1	19
■ Listening example 2	21
4 MEMORY MODE	23–34
■ General	23
■ Selecting memory mode	23
■ Setting a bank and memory channel	24
■ Programming a memory channel—1	25
■ Programming a memory channel—2	26
■ Programming a memory channel—3	27
■ Programming example 1	29
■ Programming example 2	30
■ Programming example 3	31
■ Memory copy	33
■ Copying example 1	34
■ Copying example 2	34
5 SCANNING OPERATION	35–46
■ General	35
■ Before scanning	37
■ Full scan	39
■ Memory scan	39
■ Program scan	40
■ Auto memory write scan	41
■ BANK scan	43
■ Mode select scan	44
■ Skip function	45
■ SIGNAVI function	46
6 PRIORITY WATCH	47–49
■ General	47
7 EASY MODE	50
■ General	50
■ EASY mode operation	50
8 EDIT FUNCTION	51–58

TABLE OF CONTENTS

■ General	51
■ Memory channel edit	51
■ Program scan channel edit	55
■ EASY mode channel edit	55
■ Program scan or EASY mode channel edit	57
9 SET MODE	59–62
■ General	62
10 OTHER FUNCTIONS	63–71
■ Low battery indicator	63
■ AFC function	63
■ Monitor function	64
■ Lock function	64
■ ATT function	65
■ NB/ANL function	65
■ Sleep timer	66
■ User TS setting	66
■ Memory search function	67
■ Auto mode and TS function	69
■ Resetting the CPU	70
■ Data cloning	71
11 ALPHANUMERIC KEY ASSIGNMENT	72
12 CONTROL COMMANDS	73–74
■ General	73
■ Data format	73
■ Command table	73
13 TROUBLESHOOTING	75–76
14 SPECIFICATIONS	77
15 OPTIONS	78

OPERATING THEORY

Electromagnetic radiation which has frequencies of 20,000 Hz (20 kHz*) and above is called radio frequency (RF) energy because it is useful in radio transmissions. The IC-R10 receives RF energy from 0.5 MHz to 1300 MHz* and converts it into audio frequency (AF) energy which in turn actuates a loudspeaker to create sound waves. AF energy is in the range of 20 to 20,000 Hz.

*kHz is an abbreviation of kilohertz or 1000 hertz, MHz is abbreviation of megahertz or 1,000,000 hertz, where hertz is a unit of frequency.

OPERATING NOTES

The IC-R10 may receive its own oscillated frequency, resulting in no reception or only noise reception, on some frequencies.

The IC-R10 may receive interference from extremely strong signals on different frequencies or when using an external high-gain antenna.

1

PANEL DESCRIPTION

■ Front and side panels

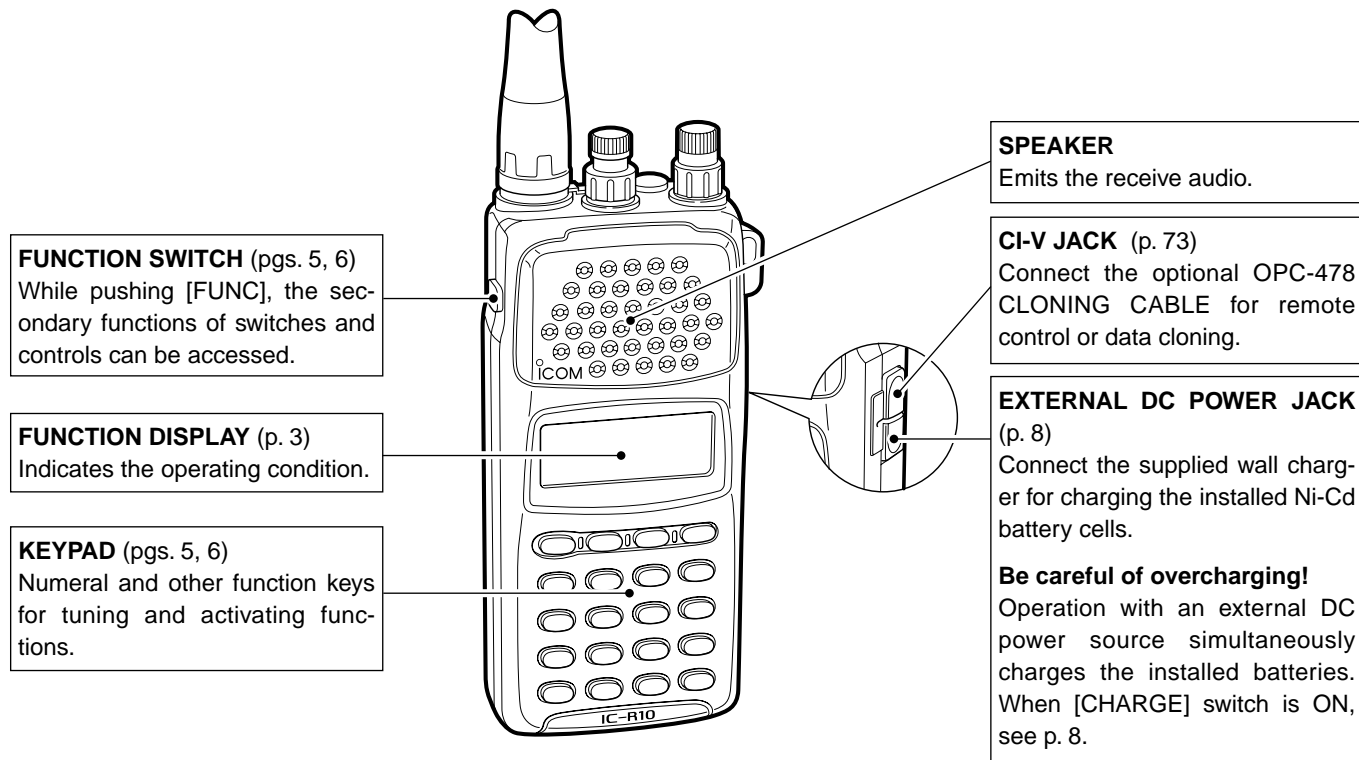

■ Top panel

ANTENNA CONNECTOR (p. 9)

Connects the supplied flexible antenna. Be careful when connecting an external antenna (See Operating Notes, p. iv).

VOLUME CONTROL [VOL]

(p. 10)
Adjusts the audio output level.

SQUELCH CONTROL [SQL]

(p. 11)
 ➤Varies the squelch threshold point for audio mute.
 • Pushing [MONI] opens the squelch momentarily.
 ➤Varies the RF gain in LSB, USB and CW modes.

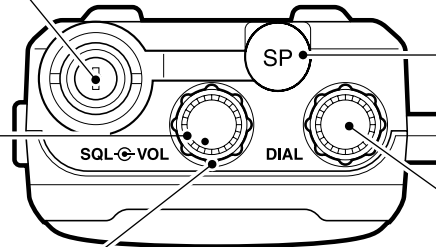

EXTERNAL SPEAKER JACK [SP]

Connect an 8 ohm optional speaker or an earphone, if desired. The internal speaker will not function when either option is connected.

Connect the optional OPC-478/479 CLONING CABLE for cloning from a PC or another IC-R10 (p. 71).

TUNING CONTROL [DIAL]

Used to set an operating frequency (p. 15), memory channel (p. 24), etc.

1 PANEL DESCRIPTION

■ Function display

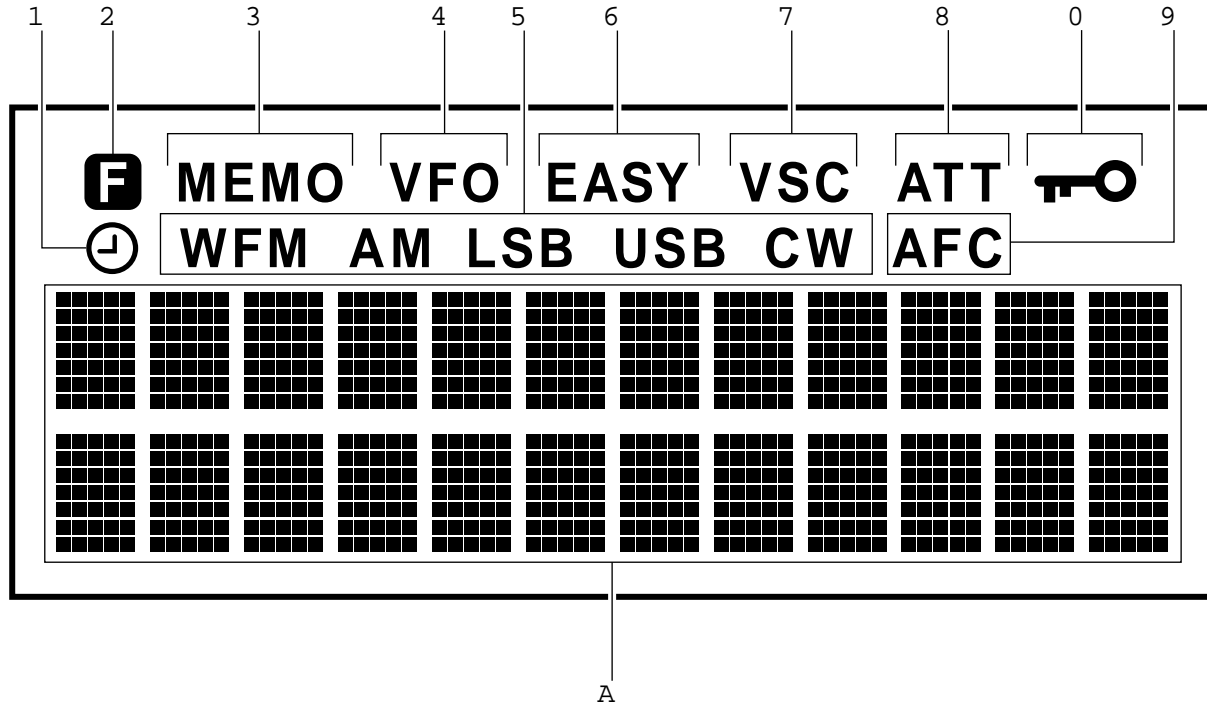

❶ SLEEP TIMER INDICATOR

Appears while the sleep timer is activated (p. 66).

❷ FUNCTION INDICATOR

Appears while the function ([FUNC]) switch is pushed.

❸ MEMORY MODE INDICATOR

Appears while in memory mode (p. 23).

❹ VFO MODE INDICATOR

Appears while in VFO mode (p. 11).

❺ RECEIVE MODE INDICATOR

Indicates the selected receive mode (p. 12).

❻ EASY MODE INDICATOR

Appears while in easy mode (p. 50).

❼ VSC INDICATOR

Appears while the VSC function is turned ON (p. 38).

❽ ATTENUATOR INDICATOR

Appears while the attenuator is turned ON (p. 65).

❾ AFC INDICATOR

Appears while the AFC function is turned ON (p. 63).

❿ LOCK INDICATOR

Appears while the lock function is activated (p. 64).

⓫ MULTI-FUNCTION DOT MATRIX

Indicates the following items:

Opening message (p. 10)

Receive frequency (p. 11)

Tuning steps (p. 13)

Band scope (p. 17)

Memory bank and channel number (p. 23)

Memory name (p. 31)

Memory bank name (p. 32)

Programmable scan edges and name (p. 40)









Priority frequency (p. 49)

SET mode contents (p. 59)

Signal strength indicator

1 PANEL DESCRIPTION

■ Keypad

KEY	PRIMARY FUNCTION	SECONDARY FUNCTION (while pushing [FUNC])
	Push for 1 sec. to toggle power ON and OFF. Opening message appears for 1 sec. after power ON (p. 10).	Not available
	Push and hold this switch to force the squelch open (p. 64).	Not available
	Selects a receive mode: FM, AM, USB, LSB, CW or WFM (p. 12).	Selects tuning step set mode (p. 13).
	Clears numeric key input (p. 14). Stops scanning (p. 39).	Selects SET mode (p. 59).
	Toggles VFO or MEMORY mode (pgs. 11, 23).	In VFO mode: writes to a memory channel (p. 29). In MEMORY mode: transfers memory contents to VFO mode (p. 33) or copies to another channel (p. 33).
	Starts/stops scanning (p. 39).	In VFO mode: selects a dial select step (p. 16).
	Selects EASY mode (p. 50).	Selects memory channel name search mode (p. 67).
	Selects memory edit mode. (except when in VFO mode; p. 51).	Locks all switches and controls electronically except [VOL], [SQL], [FUNC], [POWER] and [MONI] (p. 64).
	In VFO mode: enters the selected receive frequency (p. 14). In MEMORY mode: enters the selected memory channel by the memory search function (p. 68).	Activates the noise blanker while in SSB and CW mode, or the ANL function while in AM mode (p. 65).

KEY	PRIMARY FUNCTION	SECONDARY FUNCTION (while pushing [FUNC])
BSCOPE ①	BSCOPE VSC SLEEP ① ② ③ PROG-S AMWS SIGNAVI ④ ⑤ ⑥ MODE-S BANK-S PRIO ⑦ ⑧ ⑨ AFC ATT NB/ANL . 0 ENT	When FM receive mode is selected in VFO mode: toggles the band scope function (p. 17).
VSC ②		Toggles the VSC function ON and OFF (p. 38).
SLEEP ③		Selects the sleep timer conditions (p. 66).
PROG-S ④		In VFO mode: sets program scan edge frequencies for programmed scan (p. 40).
AMWS ⑤		In VFO mode: sets program scan edge frequencies for auto memory write scan (p. 41).
SIGNAVI ⑥		In VFO mode: toggles the signal navigator function ON/OFF for full, programmed or auto memory write scan (p. 46).
MODE-S ⑦		In MEMORY mode: sets the receive mode for mode select scan (p. 44).
BANK-S ⑧		In MEMORY mode: sets the BANK for bank scan (p. 43).
PRIO ⑨		Starts/stop priority watch (p. 49).
ATT ⑩		Toggles the attenuator ON/OFF (p. 65).

■ Charging Ni-Cd batteries

The supplied Ni-Cd batteries are rechargeable and can be charged approx. 300 times. Charge the batteries before first operating the receiver or when the batteries become exhausted.

If you want to be able to charge the batteries more than 300 times, the following points should be observed:

1. Avoid overcharging. The charging period should be less than 48 hours.
2. Use the batteries until they become almost completely exhausted under normal conditions. We recommend battery charging just after receiving becomes impossible.

■ Charging precautions

NEVER attempt to charge dry cell batteries. This will cause internal liquid leakage and damage the receiver.

NEVER connect two or more chargers at the same time.

Charging may not occur under temperatures of 10°C (50°F) or over temperatures of 40°C (104°F).

■ About Ni-Cd batteries

Ni-Cd battery life

If your Ni-Cd batteries seems to have no capacity even after being fully charged, completely discharge them by leaving the power ON overnight. Then, fully charge the Ni-Cd batteries again. If the Ni-Cd batteries still do not retain a charge (or very little), new batteries must be purchased.

Recycling information (U.S.A. only)



The product that you purchased contains rechargeable batteries. The batteries are recyclable. At the end of their useful life, under various state and local laws, it may be illegal to dispose of these batteries into the municipal waste stream. Call 1-800-8-BATTERY for battery recycling options in your area or contact your dealer.

■ Battery installation

Install 4 AA (R6) size batteries as illustrated below.

Remove the cover from the receiver.

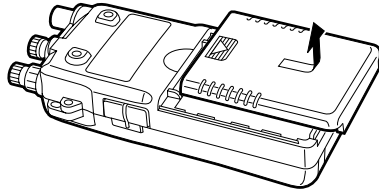

Install 4 AA (R6) size dry cell, alkaline or the supplied Ni-Cd batteries into the receiver.

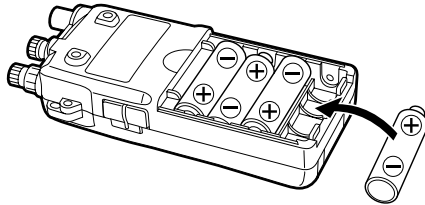

CAUTION: Make sure the polarity of the batteries is correct before installing. Reverse polarity may damage the receiver.

NOTE: DO NOT use different types of batteries at the same time otherwise the receiver may not work properly.

■ Charging connections

Confirm that the [CHARGE] switch is ON, then connect the supplied wall charger via an AC outlet as shown below.

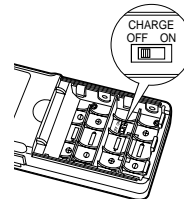
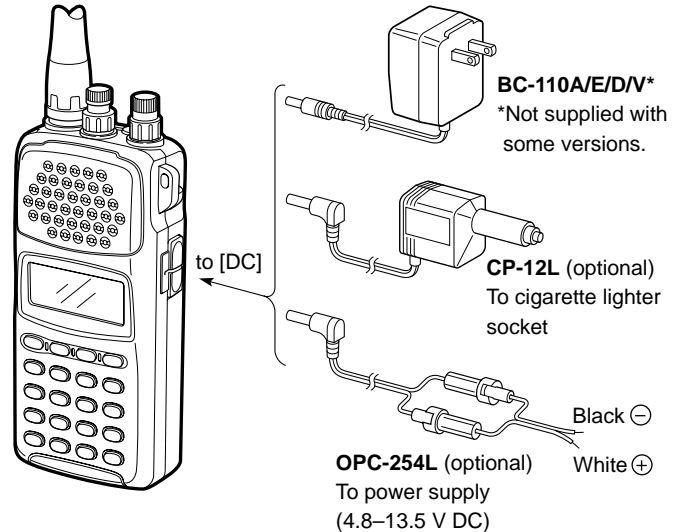

CAUTION: Make sure the [CHARGE] switch is in the OFF position when operating the receiver with one of the above power supplies.

2 Ni-Cd BATTERIES AND ACCESSORIES

■ Accessory attachment

Antenna

Insert the supplied antenna into the antenna connector and rotate the antenna as shown in the diagram below. Keep the jack cover attached when jacks are not in use to avoid bad contacts.

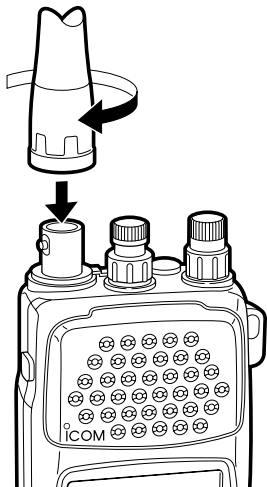

Belt clip

Attach the belt clip using the supplied screws.
Conveniently attaches to your belt.

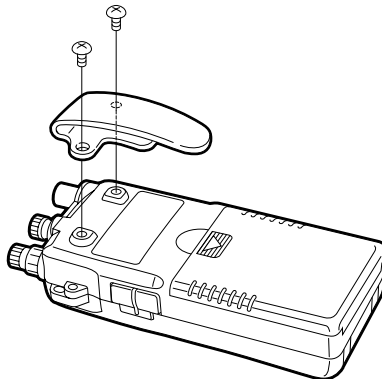

Handstrap

Attach the handstrap as shown in the diagram below. Facilities carrying.

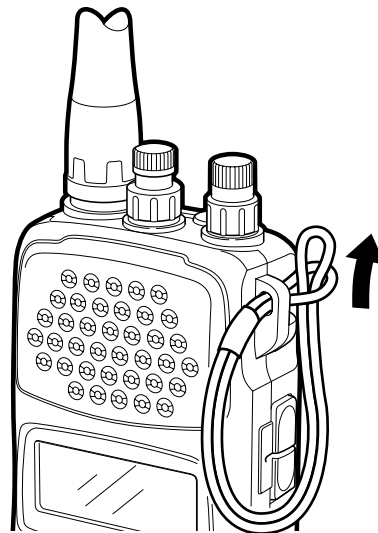

■ General

Operating the IC-R10 is easy. However, in order to get the most out of its operating potential, please go through the following procedures, step-by-step. Then, try the examples contained at the end of this chapter.

What is VFO?

The IC-R10 has several operating modes, each of which has its own distinct functions. VFO (Variable Frequency Operation) is one of these modes.

VFO mode is used to change the operating frequency, receive mode, tuning step, etc. Therefore, for most every day operations of the receiver, you will be using VFO mode.

■ Selecting VFO mode

1. Turn power ON

Push [POWER] for 1 sec. to turn power ON.

- Opening message is displayed for 1 sec.

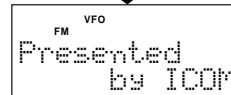
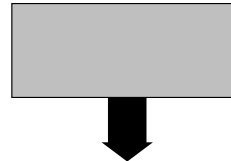
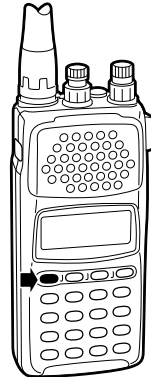

Opening message as above is displayed on the multi-function display.

2. Adjust the volume

Adjust the audio to a suitable level using [VOL].

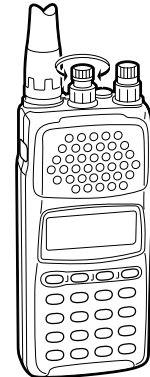

Check the squelch position (see next page) or VSC function setting (p. 38) if no audio is emitted.

3 BASIC OPERATION

3. Adjust the squelch

Rotate [SQL] maximum counter-clockwise, then rotate it clockwise until audio is just muted when receiving no signal for FM, WFM or AM mode. (see right page)



What is squelch?

A squelch circuit allows you to mute undesired noise while receiving no signal and emit audio while receiving signals. This provides quiet standby. The [MONI] switch changes the squelch setting. This is useful for weak signal reception (p. 64).

3-1. Adjust the RF gain

Rotate [SQL] maximum counter-clockwise, to adjust RF gain to optimum level.



What is RF gain?

RF gain controls receive sensitivity gain—reduce the gain when you don't want to receive very weak signals or when excessively strong interfering signals are being received, etc.

4. Select VFO mode

When MEMORY mode is selected, push [V/M] to select VFO mode. When SET or TS set mode is selected, push [CLR] to select VFO mode.

- The VFO indicator appears.

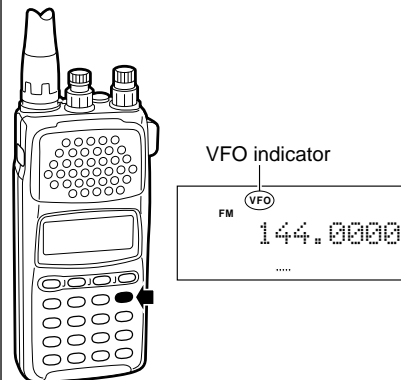

■ Selecting a receive mode

What are receive modes?

Radio signals can be propagated in a variety of ways (or modes). Each mode has its own physical properties that determine to some degree its uses.

The IC-R10 receives the 6 most common modes: AM, FM, WFM, USB, LSB and CW. When you want to tune a station, you MUST set the receive mode first. The table below shows common uses for each mode.

MODE	COMMON USAGE
AM	amateur, aviation, broadcasting
FM	amateur, utility
WFM	TV broadcasting, FM broadcasting
USB, LSB	commercial, amateur, short wave radio
CW	commercial, amateur

Major symptoms of incorrect receive mode

Distorted sound

Sudden interruption in reception

Noise only

Noise with weak reception

Low or unstable signal strength indicator value

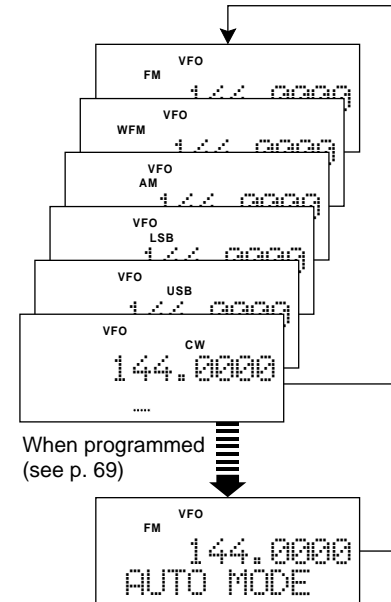
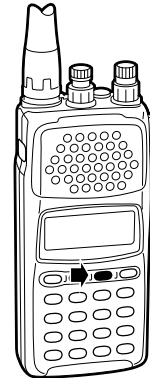

3 BASIC OPERATION

■ Selecting a tuning step

What are tuning steps?

Tuning steps are the frequency change increments when you rotate the tuning control or operate a scan. The following steps are available: *0.1, 0.5, 1, 5, 6.25, 8, 9, 10, 12.5, 15, 20, 25, 30, 50, 100 kHz* and *user programmable tuning steps* (p. 66).

It is important to set the proper tuning step for the type of station you want to listen to. Some tuning steps are determined by frequency band or receive mode and others are set by tradition.

Generally speaking, if you set a tuning step smaller than that needed you will still be able to tune a station you want (or scan it), however, tuning (or scanning) will not be efficient. On the other hand, if you select a tuning step which is too large, you may not be able to find the station you are looking for.

Consult local listings.

1. Call up the tuning step set mode

Once you have selected VFO mode and the desired receive mode, while pushing [FUNC], push [(MODE)TS].

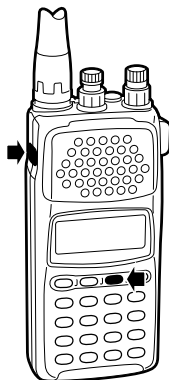

2. Select the tuning step

- 1 Rotate [DIAL] to select the desired tuning step.
- 2 Push [CLR] to return to VFO mode after the selection.

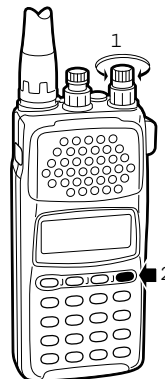

■ Tuning a frequency (via the keypad)

When you know the exact frequency you want to listen to, the quickest way to tune it is by direct keypad entry.

Remember that the frequency must be between 0.5 MHz and 1300 MHz.

The diagram below shows the correlation between the function display frequency digits and the frequency.

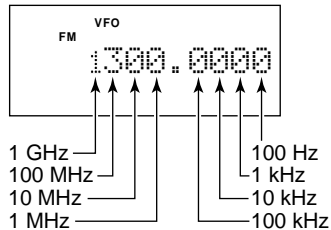

1. Select the frequency

Select VFO mode and the receive mode in advance then:

Push the numeral keys in the same order as the frequency you want to tune (including the decimal key).



- If you make a mistake, push [CLR] and start again.

2. Enter the frequency

When the frequency you want is displayed:

Push [ENT] (or numeral keys for the 0.1 kHz digit) to enter it.

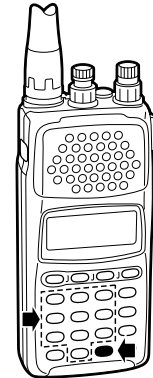

- When you select a frequency outside of the allowed range, the display will revert back to the previously displayed frequency.

3 BASIC OPERATION

■ Tuning a frequency (via the dial)

When you want to listen to frequencies near the displayed frequency, the easiest way to tune them is with the tuning dial.

All signals have what is called an “occupied bandwidth.” They will be received as long as the receiver is tuned anywhere within this bandwidth. Even though the frequency received may not be the central frequency, the tuning step should be made as small as possible (0.5 or 5 kHz) and the receiver tuned to the point of greatest signal strength indicator deflection.

To change frequencies faster than the tuning step, use the dial select function (p. 16).

1. Select VFO mode and a receive mode

- ① Push [CLR] or [V/M] to select VFO mode.
- ② Push [MODE] to select a receive mode.
- ③ Set tuning step if desired (p. 14).

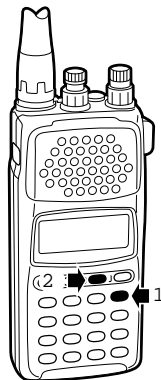

2. Tune a frequency

Rotate [DIAL] to change the frequency.

- The frequency changes in increments determined by the tuning step.
- To change the frequency faster, use the dial select function (p. 16).

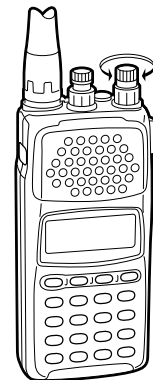

■ Dial select steps

What are dial select steps?

When tuning with the dial, if you want to change the frequency faster than the selected tuning step can, use the dial select function.

A dial select step is an increment of frequency change much like a tuning step is. Unlike a tuning step however, a dial select step has no relation to the type of station you want to tune or to the scan operations.

Dial select steps are available for:

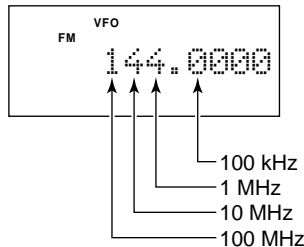

Changing the frequency with the dial select step

In VFO mode:

Push and hold [FUNC], then rotate [DIAL].

To change the dial select step:

While pushing [FUNC], push [(SCAN)DIAL SEL] one or several times until the frequency digit you want to change flashes.

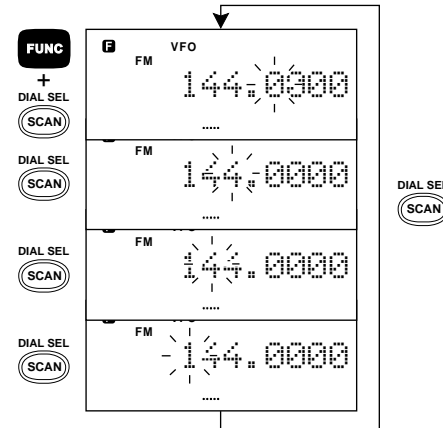

3 BASIC OPERATION

■ Band scope function

What is the band scope function?

The band scope detects signal availability in the range of ± 5 channels (up to ± 100 kHz) from the displayed frequency, and displays the result on the multi function dot-matrix display. This gives you a visual reference of current band conditions.

In this case, *channel* refers to sweep step or channel space according to the set tuning step. For example, when the tuning step is set to 5 kHz, the band scope detects 25 kHz above and below the displayed frequency, then displays the result on the LCD.

When the tuning step is set above 20 kHz, the band scope function automatically changes its sweep step to 20 kHz. However, when the sweep step is changed to 20 kHz, the tuning step remains the same.

Also, when a user-programmable tuning step is selected, the band scope function automatically selects the 20 kHz sweep step.

Preparation

The band scope function is activated only when FM receive mode is selected in VFO mode.

- ① Push [V/M] to select VFO mode. (p. 11)
- ② Push [MODE] one or more times to select FM mode. (p. 12)
- ③ While pushing [FUNC], push [(MODE)TS]
- ④ Rotate [DIAL] to select the tuning/sweep step.
- ⑤ Push [CLR] to return to VFO mode.

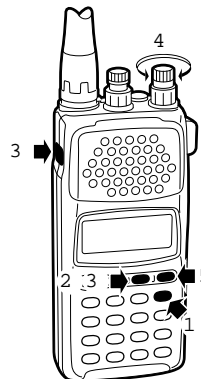

Set band scope function

- ① While pushing [FUNC], push [(1)BSCOPE].

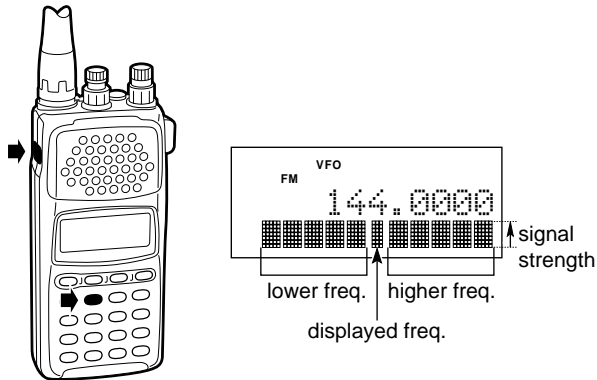

Repeat the above step or push [CLR] to turn OFF the band scope function.

3 BASIC OPERATION

■ Listening example 1 — television broadcast in WFM mode

1. Turn power ON

Push [POWER] for 1 sec. to turn power ON.

2. Select VFO

Push [CLR] or [V/M] to select VFO mode.

3. Adjust volume

Rotate [VOL] to obtain the desired level of audio output.

4. Adjust squelch

Rotate [SQL] fully counterclockwise, then clockwise until the audio noise just disappears.

5. Select the receive mode

Television sound is broadcast in WFM mode. If the receiver is not already in WFM mode:

Push [MODE] one or more times until WFM appears in the function display.

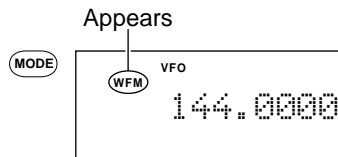

6. Select the tuning step

In most countries* television stations are spaced about 50 kHz apart. To select the 50 kHz tuning step:

While pushing [FUNC], push [(MODE)TS], then rotate [DIAL] until the function display shows "50 kHz". Push [CLR] after setting to return to VFO mode.

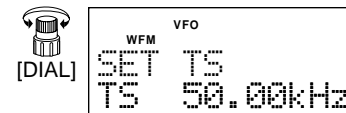

*Check listings for your area.

(Example 59.75 MHz)

7. Tune the station

Use the keypad to enter the frequency — (example 59.75 MHz).

[Example]

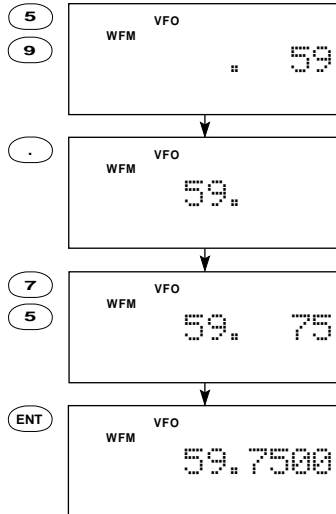

(Example 59.25 MHz)

7-1. Tune the station

Enter the frequency from the 100 kHz digit when you want to change below the 1 MHz digit only — (example from 59.75 MHz to 59.25 MHz).

[Example]

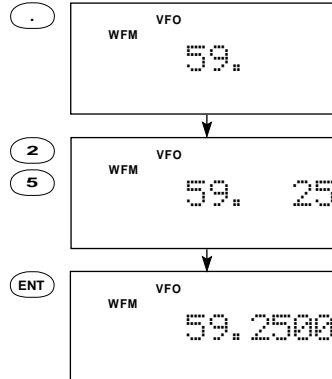

8. Use the tuning dial

Rotate [DIAL] to search for nearby stations above and below the tuned frequency.

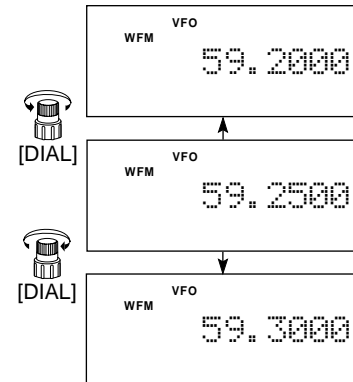

NOTE: WFM and regular FM share the same circuit. Depending on the receive condition, this may result in distortion. In such cases, try lowering the frequency 30–50 kHz.

3 BASIC OPERATION

■ Listening example 2 — airband broadcast in AM mode

1. Turn power ON

Push [POWER] for 1 sec. to turn power ON.

2. Select VFO

Push [CLR] or [V/M] to select VFO mode.

3. Adjust volume

Rotate [VOL] to obtain the desired level of audio output.

4. Adjust squelch

Rotate [SQL] fully counterclockwise, then clockwise until the audio noise just disappears.

5. Select the receive mode

Airband communications are in AM mode. If the receiver is not already in AM mode:

Push the [MODE] switch one or more times until AM appears in the function display.

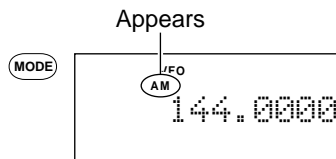

6. Select the tuning step

Tuning steps for the airband are usually 25 kHz*. To set the 25 kHz tuning step:

While pushing [FUNC], push [(MODE)TS], then rotate [DIAL] until "25 kHz" appears in the function display.

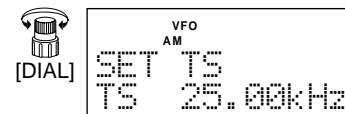

*Check listings for your area.

(Example 118.00 MHz) (Example 118.925 MHz)

7. Tune the station

Enter a frequency of 118.0000 MHz* using the keypad (p. 14).

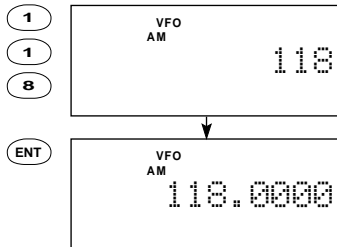

*Check listings for your area.

7-1. Tune the station

Enter the frequency from the 100 kHz digit when you want to change below the 1 MHz digit only — (example from 118 MHz to 118.925 MHz).

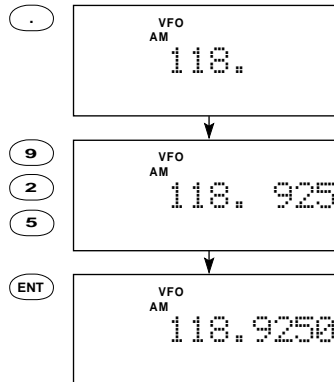

8. Use the tuning dial

Rotate [DIAL] to search for nearby stations above and below the tuned frequency.

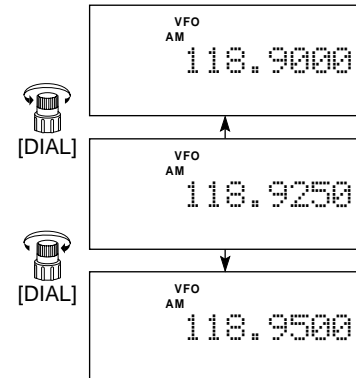

■ General

What is memory mode?

MEMORY mode is the second operating mode—the first being VFO mode. MEMORY mode is used to store often-used frequencies, their receive modes, attenuator settings (p. 65), as well as skip information for scanning (p. 56). This provides convenient recall and scanning capabilities. Also, frequencies are receivable in MEMORY mode which means you can listen to received signals while you are in MEMORY mode.

The IC-R10 has 1000 memory channels for your convenience. They are divided into 18 banks: BANKS A to P contain 50 channels each for normal usage, while BANKS Q and R contain 100 channels each for auto-memory write scan (p. 41) and program skip scan (p. 45), respectively.

Each BANK and memory channel has BANK or memory name capabilities, for convenience. BANK names can be up to 10 characters; channel names up to 8 characters. Programmed contents and names can be easily copied to other channels using the memory copy function (p. 33) and easily edited using the EDIT function (p. 51).

■ Selecting MEMORY mode

Select MEMORY mode

- Push [V/M] to select MEMORY mode.
- “MEMO” appears in the function display.
 - Push [V/M] again to return to VFO mode.

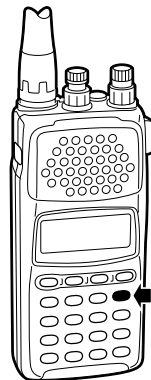

Appears



■ Selecting a BANK and memory channel

Selecting a BANK channel

When your desired memory channel is not stored or you do not want to store a frequency in the displayed BANK, you must change the BANK number.

While pushing [FUNC], rotate [DIAL].

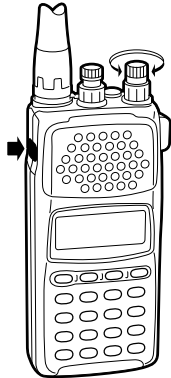

Selecting a memory channel—1

If you want to recall a memory channel which has been memorized, this is the easiest way.

Rotate [DIAL].

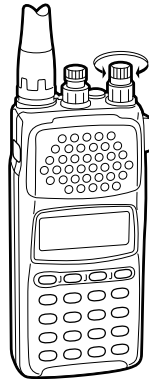

Selecting a memory channel—2

If you remember the memory channel number you want to recall, this is the fastest way to recall it.

Enter the full 2-digit memory channel number via the keypad.

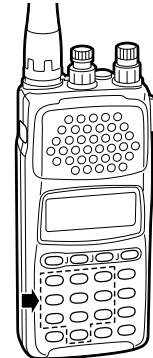

Also, when you want to recall a blank channel for programming, you have to enter a channel number via the keypad.

4 MEMORY MODE

■ Programming a memory channel — 1

This is the quickest way to memorize a received frequency, along with its receive mode and other information.

When you memorize the frequency in this way, the previously memorized data is replaced with the new data. If you do not want to lose the previously memorized data, select a blank channel number before programming (p. 24).

1. BANK and memory channel setting

- ① Select MEMORY mode (p. 23).
- ② Set the BANK and memory channel number (p. 24) you want to program to.

2. Setting other information

- ① Select VFO mode (p. 11).
- ② Set the frequency and receive mode (p. 12) you want in VFO mode.

3. Programming

While pushing [FUNC], push [(V/M)MW] to program the data.

- When programming is successfully completed, 3 beeps sound.

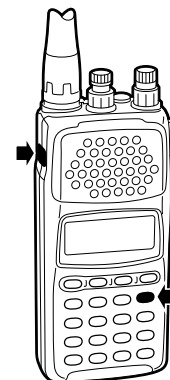

■ Programming a memory channel — 2

This is the simplest method to memorize the received frequency along with its receive mode and other information.

1. Setting receive conditions

- ① Select VFO mode (p. 11).
- ② Set the frequency and receive mode (p. 12).

2. BANK and memory channel setting

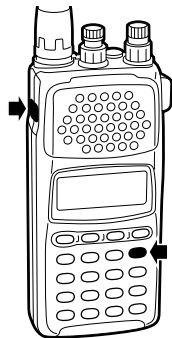

While pushing [FUNC], push [(V/M)MW].

3. BANK and memory channel setting

- ① While pushing [FUNC], rotate [DIAL] to select the BANK you want to program into.
- ② Rotate [DIAL] to select the memory channel you want to program.

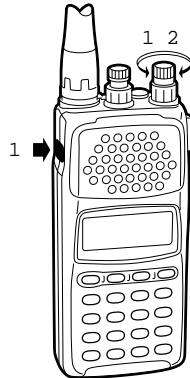

4. Programming

While pushing [FUNC], push [(V/M)MW] for 2 sec. to program the data.

- When programming is successfully completed, 3 beeps sound and VFO mode is automatically selected.

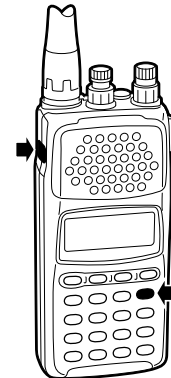

4 MEMORY MODE

■ Programming a memory channel — 3

This is the easiest way to memorize the received frequency, mode and other information along with memory, BANK names, scanning condition, etc. in one operation.

1. Set up

- ① Set the frequency you want to program in VFO mode.
- ② While pushing [FUNC], push [(V/M)MW] to enter memory write mode.

2. BANK and memory channel setting

- ① While pushing [FUNC], rotate [DIAL] to select the BANK you want to program (p. 24).
- ② Rotate [DIAL] or push 2 digit keys to select the memory channel you want to program (p. 24).

3. Programming details

- ① Push [EDIT] to enter memory programming mode.
- ② Rotate [DIAL] or enter the alphanumeric characters via the keypad to program a memory name.
 - When you enter channel names with [DIAL] or a character assigned to the same key, push [ENT] before you enter the next character to change the digit (see page 72 for alphanumeric key assignments).

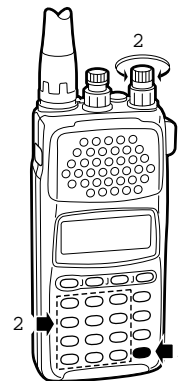

3. Programming details — cont.

- 3 Push [EDIT], then rotate [DIAL] to select receive mode.
- 4 Push [EDIT], then rotate [DIAL] to select the skip scan condition.
- ⑤ Push [EDIT], then rotate [DIAL] to select the attenuator condition.
- ⑥ Push [EDIT], then rotate [DIAL] or enter alphanumeric characters to program a BANK name.
- When you enter channel names with [DIAL] or a character assigned to the same key, push [ENT] before you enter the next character to change the digit (see page 72 for alphanumeric key assignments).

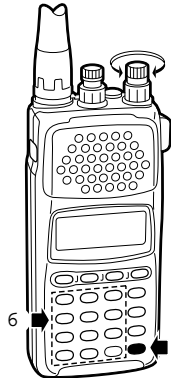

3. Programming details — cont.

- ⑦ Push [EDIT], to display your programmed frequency for confirmation. When the correct frequency is displayed, push [EDIT] for 2 sec. to return to VFO mode.

When you want to return to VFO mode immediately, push [EDIT] for 2 sec. at any time.

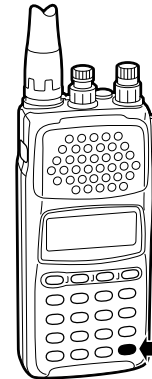

4 MEMORY MODE

■ Programming example 1 — (118.0250 MHz; AM to channel B07)

1. BANK and memory channel setting

- ① Push [V/M] to select MEMORY mode.
- ② While pushing [FUNC], rotate [DIAL] to select BANK "B".

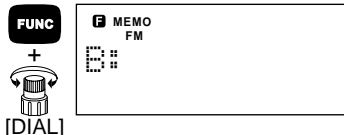

- ③ Push [0] and [7] to enter the memory channel number.

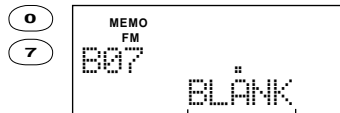

"BLANK" appears when the memory channel is not programmed.

2. Data setting

- ① Push [V/M] to select VFO mode.
- ② Push [MODE] one or more times to select AM mode.

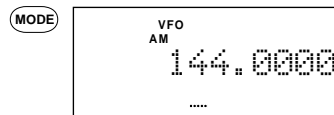

- ③ Push numeral keys or rotate [DIAL] to set the frequency 118.0250 MHz.

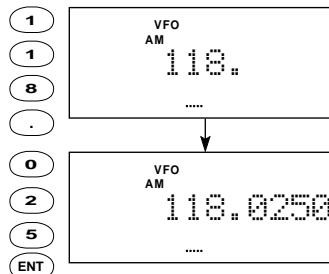

3. Programming the data

While pushing [FUNC], push [(V/M)MW] for 2 sec.

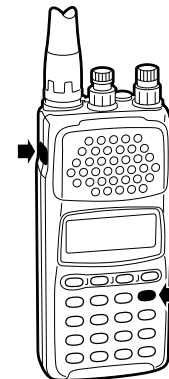

■ Programming example 2 — (59.75 MHz; WFM to channel A45)

1. Setting the frequency

- ① Push [V/M] to select VFO mode.
- ② Push [MODE] one or more times to select WFM mode.

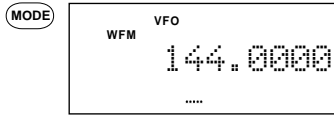

- ③ Push numeral keys or rotate [DIAL] to set the frequency to 59.75 MHz.

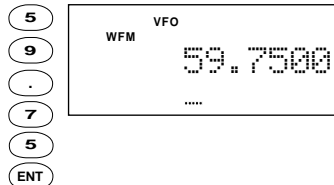

2. Set the BANK and memory channel

- ① While pushing [FUNC], push [(V/M)MW] to enter memory write mode.
- ② While pushing [FUNC], rotate [DIAL] to select BANK "A".

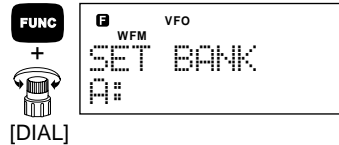

- ③ Rotate [DIAL] select channel "45" or push [4] and [5] to enter the memory channel number.

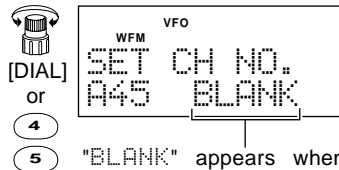

"BLANK" appears when the memory channel is not programmed.

3. Programming the data

- While pushing [FUNC], push [(V/M)MW] for 2 sec.

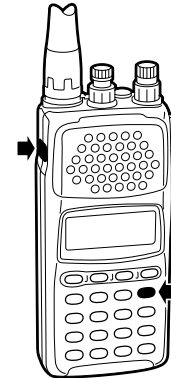

4 MEMORY MODE

■ Programming example 3 — (121.5 MHz, EMER., AM, SKIP: OFF, ATT: OFF, Aviation to channel F01)

1. Setting the frequency

- ① Push [V/M] to select VFO mode.
- ② Rotate [DIAL] or push numeral keys to enter 121.5 MHz.

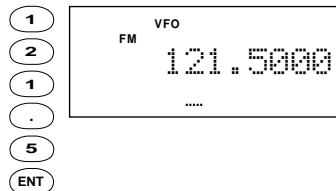

2. BANK and memory channel setting

- ① While pushing [FUNC], push [(V/M)MW].
- ② While pushing [FUNC], rotate [DIAL] to select BANK "F".

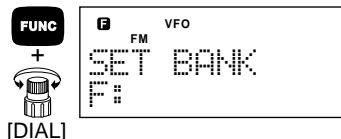

- ③ Rotate [DIAL] or push [0] then [1] to select channel "01".

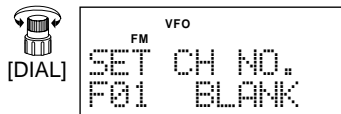

3. Programming details

- ① Push [EDIT] to enter memory setting mode.

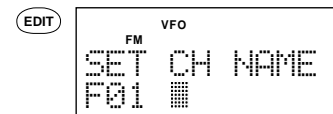

- ② Rotate [DIAL] until the character "E" appears then push [ENT] or push [3] twice to enter the "E."

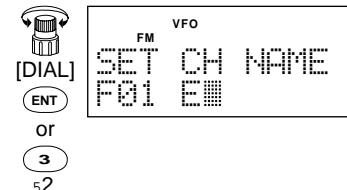

- ③ Rotate the [DIAL] then push [ENT] to enter the characters "M", "E", "R" and "." for memory names or push numeral keys (see page 72 for alphanumeric key assignments).

3. Programming details — cont.

- ⑤ Push [EDIT] to change the receive mode item.
- ⑥ Rotate [DIAL] to select AM mode, then push [EDIT] to change the item.



- ⑦ Rotate [DIAL] to select the OFF position for SKIP setting, then push [EDIT].

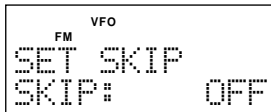

3. Programming details — cont.

- ⑧ Rotate [DIAL] to select the OFF position for attenuator setting, then push [EDIT].

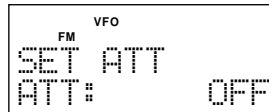

- ⑨ Rotate [DIAL] until the character “A” appears, then push [ENT] or push [2] once to enter “A”.

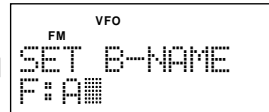

- ⑩ Rotate [DIAL] then push [ENT] to enter the characters for BANK names or push numeral keys (see page 72 for alphanumeric key assignments).

3. Programming details — cont.

- ⑪ The display shows the programmed frequency for confirmation; push and hold [EDIT] for 2 sec. if the frequency is correct.
 - After pushing and holding [EDIT], VFO mode is automatically selected.



Push for 2 sec.



4 MEMORY MODE

■ Memory copy

What is the memory copy function?

The memory copy function copies the contents (minus BANK names) of the selected memory channel to VFO or to another memory channel. This is quite useful when you want to search for signals around the displayed frequency or when you want to edit memory channels.

Copy to VFO mode

- ① Push [V/M] to select memory mode.
- ② Select the BANK and memory channel you want to copy (p. 24).
- ③ While pushing [FUNC], push [(V/M)MW] for 2sec.

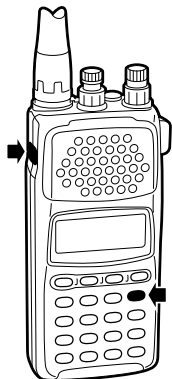

Copy to the other memory channel

- ① Push [V/M] to select memory mode. (p. 23)
- ② Select the BANK and memory channel you want to copy (p. 24).
- ③ While pushing [FUNC], push [(V/M)MW].
- ④ Set the BANK and channel number you want to copy to (p. 24).
- ⑤ While pushing [FUNC], push [(V/M)MW] for 2 sec.

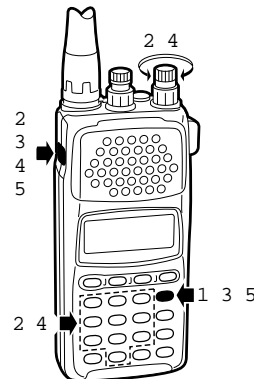

■ Copying example 1 (59.7500 MHz, WFM, A45 to VFO)

- 1 Push [V/M] to select memory mode (p. 23).
 - 2 Select the memory channel A45 (p. 24).
 - 3 While pushing [FUNC], push [(V/M)MW] for 2 sec. to copy the contents of memory A45 to VFO.
- VFO mode is automatically selected.

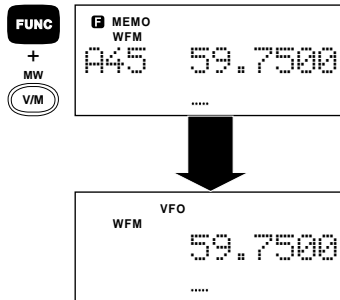

■ Copying example 2 (118.0250 MHz, AM, B07 to F02)

- 1 Push [V/M] to select memory mode (p. 23).
- 2 Select the memory channel B07. (p. 24)
- 3 While pushing [FUNC], push [(V/M)MW].

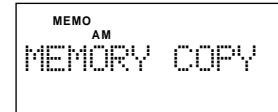
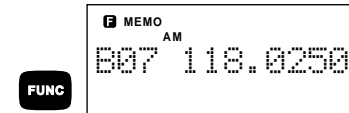

- 4 While pushing [FUNC], rotate [DIAL] to select BANK "F".

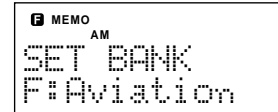

- 5 Rotate [DIAL], or push [0], [2] to select channel "02".

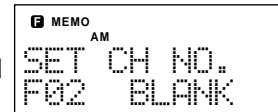

- 6 While pushing [FUNC], push [(V/M)MW] for 2 sec. to transfer the contents of B07 to F02.

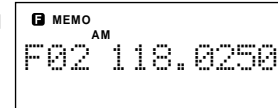

5

SCANNING OPERATION

■ General

Scan types

The IC-R10 has 2 major scan types: PROGRAMMED SCAN and MEMORY SCAN. These, in turn, can be subdivided into 3 variations of each, making a total of 6 scan operations. Additional scanning functions are available to “fine tune” scanning operation.

The following diagrams illustrate the operation of each scan type.

Step-by-step instructions on how and when to use each scan type follow these diagrams.

What is scanning?

Scanning is an automatic search function that detects signals as it checks through a range of frequencies or memory channels.

Scanning functions are useful for discovering new frequencies to listen to or for searching through previously programmed frequencies for signals.

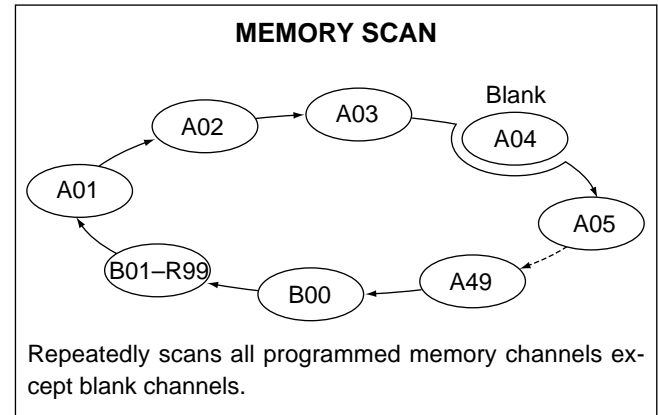
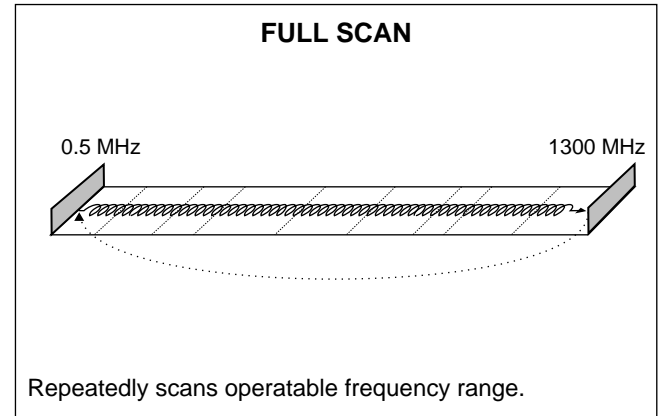

PROGRAM SCAN

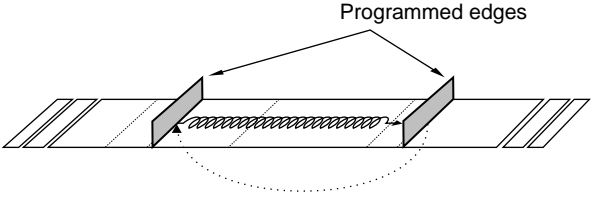

Repeatedly scans between two user-programmed frequencies (scan edges).

AUTO-MEMORY WRITE SCAN

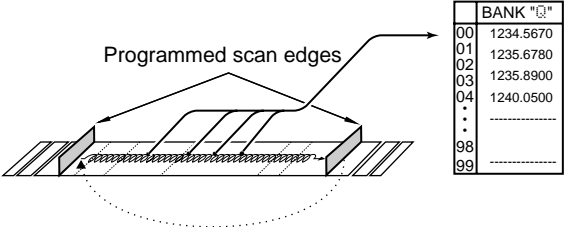

Same as PROGRAMMED SCAN except that paused frequencies are automatically stored in memory channels Q00–Q99.

BANK SCAN

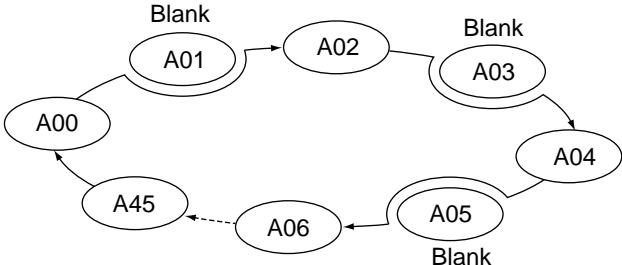

Repeatedly scans all memory channels in the selected BANK except blank channels.

MODE SELECT SCAN

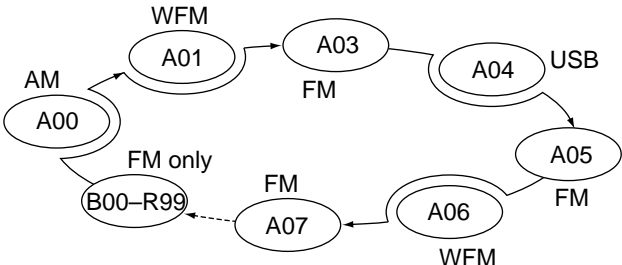

Repeatedly scans all memory channels with the selected receive mode.

5 SCANNING OPERATION

■ Before scanning

Set the following conditions before scanning.

INFORMATION

What happens when you rotate the tuning dial during scanning?

While scanning—

Scanning direction is changed.

Example:

If you rotate [DIAL] counterclockwise while scanning up (frequency/memory channel number increase), scan changes to down scanning (frequency/memory channel number decrease).

While pausing—

Scanning starts again (pause is cancelled).

1. Set receive mode

Set any receive mode EXCEPT USB, LSB and CW.

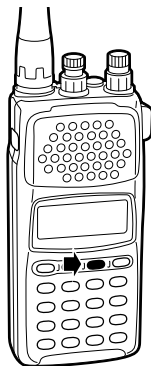

The squelch control activates for RF gain control while USB, LSB, or CW mode is selected. RF gain control does not activate for audio noise muting, therefore, the receiver is in a busy condition at all times. In such case, searching speed is either very slow or searching doesn't even start.

2. Set the volume and squelch levels

Set [VOL] to a suitable audio output level.

Set [SQL] so that the noise audio is just muted.

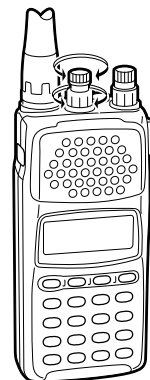

Set the VSC

Set the VSC ON if necessary.

While pushing [FUNC], push [(2)VSC] (VSC indicator appears).

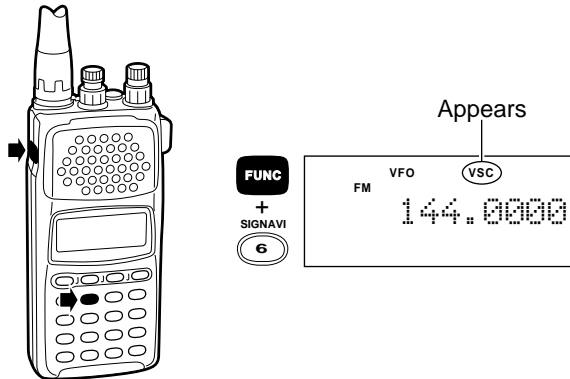

While pushing [FUNC], push [(2)VSC) to turn OFF the VSC (VSC indicator disappears).

What is VSC?

The VSC (Voice Scanning Control) pauses a scan only when modulated signals are received. Scanning continues when unmodulated or beat signals are received.

Set the scan delay

Set the scan delay.

While pushing [FUNC], push [(CLR)SET], then push [EDIT] one or more times until SCAN DELAY appears (p. 62).

Rotate [DIAL] to set the scan delay time.

Push [CLR] to return to VFO or MEMORY mode.

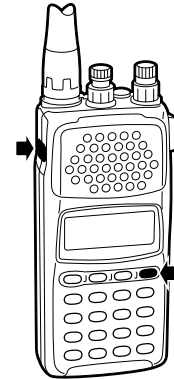

What is scan delay?

Scan delay affects scan pausing as follows:

- 5SEC: scan automatically resumes 5 sec. after pausing
- 10SEC: scan automatically resumes 10 sec. after pausing
- PAUSE: scan automatically resumes 2 sec. after a received signal disappears

5 SCANNING OPERATION

■ Full scan

This is the simplest scanning operation, searching the full frequency range (0.5–1300 MHz) in the selected receive mode and tuning step.

Start and stop the scan

1 Push [V/M] to select VFO mode. (p. 11)

2 Push [SCAN] to start scanning.

(SCAN)

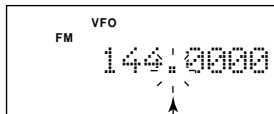

Flashes while scanning

To change the direction of the scanning, rotate [DIAL] during scanning.

When the program skip function is ON (p. 61), frequencies stored in BANK R memories are skipped. Also, "SKIP" is displayed.

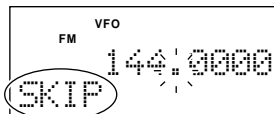

Skip indicator

3 Push [SCAN] or [CLR] to stop scanning.

■ Memory scan

This is the simplest way to search for all stored frequencies in memory channels.

Start and stop the scan

1 Push [V/M] to select MEMORY mode.

2 Push [SCAN] to start scanning.

(SCAN)

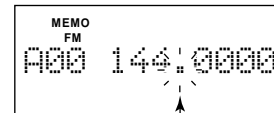

Flashes while scanning

To change the direction of the scan, rotate [DIAL] during scanning.

When the memory skip function is ON (p. 61), specified memory channels (p. 56) are skipped. Also, "SKIP" is displayed.

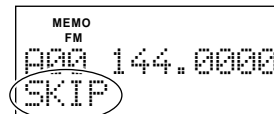

Skip indicator

3 Push [SCAN] or [CLR] to stop scanning.

■ Program scan

This is the most useful basic scan for searching over a specified frequency range.

1. Select program scan channel

① Push [V/M] to select VFO mode (p. 11).

② While pushing [FUNC], push [(4)PROG-S].



Rotate [DIAL] to select the program scan channel.



Displays "PROGRAM SCAN" with program channel number and the names for 2 sec., then scan edges, "S" and "E", are displayed.

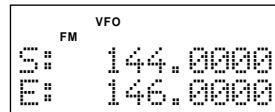

Displays "S (start)" and "E (end)" frequencies after 2 sec.

2. Start and stop scanning

Push [SCAN] to start scanning.

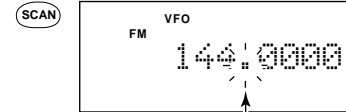

Flashes while scanning

To change the direction of the scan, rotate [DIAL] during scanning.

When the program skip function is ON (p. 61), frequencies stored in BANK R memories are skipped. Also, "SKIP" is displayed.

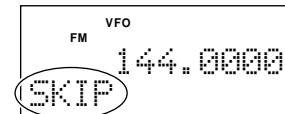

Skip indicator

Push [CLR] or [SCAN] to stop scanning.

When the same frequency is stored in both scan edges, program scan will not proceed.

The default frequency range is 144.0000–146.0000 MHz. Set up scan frequency ranges before starting program scan. See page 57 for program scan channel set up.

5 SCANNING OPERATION

■ Auto memory write scan

This scan is useful for searching a specified frequency range and automatically storing busy frequencies into memory channels. The same frequency ranges used for program scan are used for auto memory write scan.

1. Select program scan channel

① Push [V/M] to select VFO mode (p. 11).

② While pushing [FUNC], push [(5)AMWS].

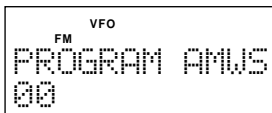

Rotate [DIAL] to select the program scan channel.

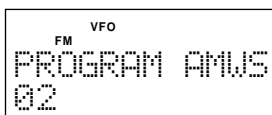

Displays "PROGRAM AMWS" with program channel number and the names as program scan channel.

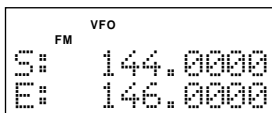

Displays "S (start)" and "E (end)" frequencies after 2 sec.

2. Start and stop scanning

Push [SCAN] to start scanning.

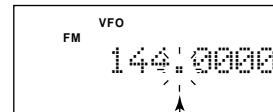

Flashes while scanning

To change the direction of the scan, rotate [DIAL] during scanning.

When the program skip function is ON (p. 61), frequencies stored in BANK R memories are skipped. Also, "SKIP" is displayed.

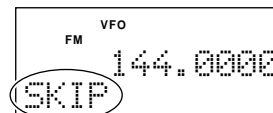

Skip indicator

Push [CLR] or [SCAN] to stop scanning.

During auto-memory write scanning:

- 1 Busy (paused) frequencies are automatically stored into BANK Q memory channels.
- 2 The scan is automatically cancelled when BANK Q becomes full.
- 3 Unmodulated or beat signals may not be stored into memory channels when the VSC function is turned ON.
- 4 While pushing [FUNC], push [(V/M)MW] when unwanted signals (ones you don't want to store) are received.

For your convenience:

Auto-memory write scan automatically clears all previously stored information when it is started. Therefore, it is a good idea to copy desired frequency data memorized during auto-memory write scan into BANK A to P's memory channels before operating the scan.

5 SCANNING OPERATION

■ BANK scan

Scans all stored frequencies into a specified BANK, except for SKIP channels.

1. Select BANK scan and BANK number

① Push [V/M] to select MEMORY mode (p. 23).

② While pushing [FUNC], push [(8)BANK-S].

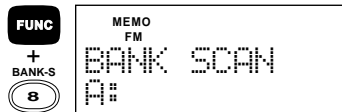

Rotate [DIAL] to select the BANK number.

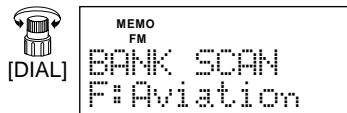

Displays "BANK SCAN" with BANK number and the names.

2. Start and stop scanning

Push [SCAN] to start scanning.

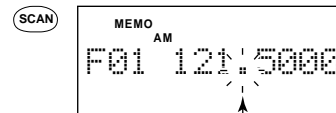

Flashes while scanning

To change the scan direction, rotate [DIAL] during scanning.

When the memory skip function is ON (p. 61), specified memory channels (p. 56) are skipped. Also, "SKIP" is displayed.

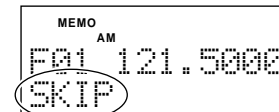

Skip indicator

Push [CLR] or [SCAN] to stop scanning.

The specified BANK must have 2 or more stored channels, otherwise, the scan will not proceed.

■ Mode select scan

Scans all stored frequencies that have the specified receive mode, except SKIP channels.

1. Select mode select scan and mode

① Push [V/M] to select MEMORY mode (p. 23).

② While pushing [FUNC], push [(7)MODE-S].



Displays "MODE SCAN".

③ Push [MODE] once or more times to select the receive mode.

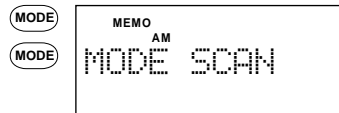

2. Start and stop scanning

Push [SCAN] to start scanning.

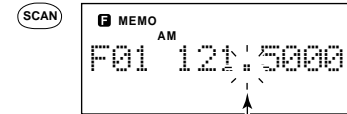

Flashes while scanning

To change the scan direction, rotate [DIAL] during scanning.

When the memory skip function is ON (p. 61), specified memory channels (p. 56) are skipped. Also, "SKIP" is displayed.

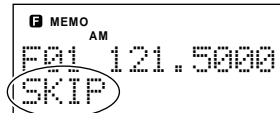

Skip indicator

Push [CLR] or [SCAN] to stop scanning.

If 2 or more channels do not have the specified receive mode, scan will not proceed.

5 SCANNING OPERATION

■ Skip function

Two skip functions are available as follows:

1. Program skip function

Used with full, program and auto-memory write scans, this function allows you to skip specified frequencies stored in BANK R (skip function must be ON for these channels).

2. Memory skip function

Used with memory, BANK and mode select scans, this function allows you to skip specified memory channels.

These are activated when PROGRAM SKIP or MEMORY SKIP is turned ON in set mode (p. 59).

Their factory pre-programmed settings are:

PROGRAM SKIP : OFF
MEMORY SKIP : ON

1. Program skip setting

- ① Set PROGRAM SKIP to ON in set mode (p. 59).

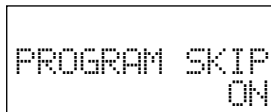

- ② Push [V/M] to select VFO mode. (p. 11)
- ③ Start full or program scan (p. 35).

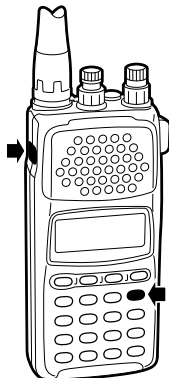

④ While pushing [FUNC], push [(V/M)MW] during scan pause if you want to skip the paused frequency.

Skip frequencies are stored in BANK-R memory channels (counting down from channel 99 to 00).

2. Program skip setting — cont.

When BANK R becomes full, an error beep sounds when trying to set more skip frequencies. When you want to cancel the skip function, turn OFF the SKIP setting in the memory channel (p. 56).

- ⑤ After set up, push [SCAN] or [CLR] to stop scanning.

Stored frequencies are skipped during the next full, program or auto-memory write scan operation.

1. Memory skip setting

Set the skip condition in each memory channel—refer to p. 55 MEMORY EDIT for details.

■ SIGNAVI function

The SIGNAVI function activates while paused during full, program or auto-memory write scans in FM mode. It searches for busy frequencies up to 100 kHz* (+100 kHz when scanning up, -100 kHz when scanning down) from the paused frequency (f₀), then jumps to the next busy frequency (f₁) detected (by SIGNAVI) when scan resumes.

*The SIGNAVI search range varies according to tuning step settings. The maximum range is 5 channels or steps from the receive frequency, therefore, the tuning step must be equal to or smaller than 20 kHz.

1. Set SIGNAVI function

- ① Push [V/M] to select VFO mode (p. 11).
- ② While pushing [FUNC], push [(6)SIGNAVI].
 - Displays “SIGNAVI” below frequency.

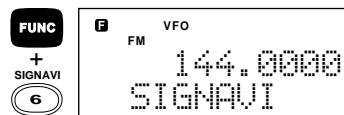
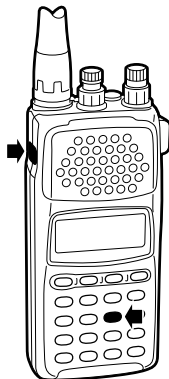

2. Select scan type and start scanning

- 1 While pushing [FUNC], push [(4)PROG-S] for program scan or [(5)AMWS] for auto-memory write scan, then rotate [DIAL] to select scanning frequency band.
 - Confirm that the receive mode of the selected scan band is FM and also that the tuning step is equal to or smaller than 20 kHz.
 - If you want to search the entire frequency range (0.5–1300 MHz) skip this step.
- 2 Push [SCAN] to start scanning.

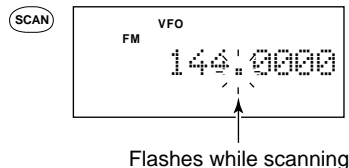

- 3 Push [SCAN] or [CLR] to stop scanning.

■ General

What is priority watch?

Priority watch checks for signals on a priority frequency while listening to another frequency or, while searching one or more frequencies or memory channels.

When receiving a signal on the priority channel, priority watch pauses for 5 sec.

This function is useful when you want to monitor for a signal that appears infrequently. In this case, you can wait for the signal while listening to another signal on a different frequency.

Types of priority watch

There are two basic priority watches: *VFO FREQUENCY WATCH* and *MEMORY CHANNEL WATCH*. Also, the priority watch can be activated in conjunction with a scanning function, thereby making a total of 8 priority watch operations.

The following diagrams illustrate the operation of each priority watch type.

VFO FREQUENCY WATCH

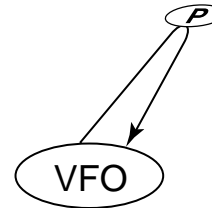

While listening to a VFO frequency, priority watch checks for signals on the priority frequency every 5 sec.

MEMORY CHANNEL WATCH

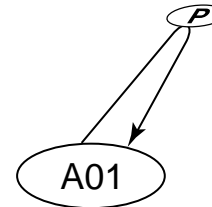

While listening to a selected memory channel, priority watch checks for signals on the priority frequency every 5 sec.

- When the selected memory channel is masked (blank), the watch does not start.
- SKIP memory channels can be selected.

FULL SCAN WATCH/PROGRAM SCAN/AUTO-MEMORY WRITE SCAN WATCH

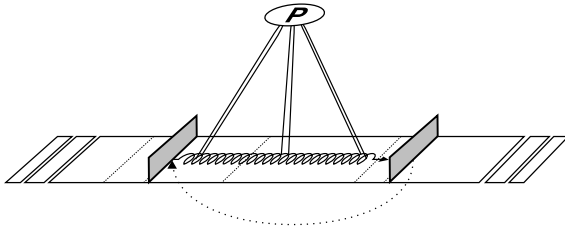

While scanning the full frequency range or a programmed frequency range, priority watch checks for signals on the priority frequency every 5 sec.

- When the skip function is ON, skips specified frequencies.
- The priority frequency is never programmed into BANK Q even if a signal is received on the priority frequency when auto-memory write scan is selected.

MEMORY SCAN/BANK SCAN/MODE SELECT SCAN WATCH

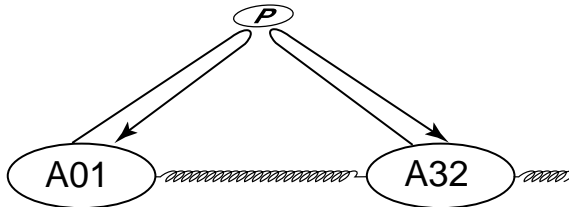

While scanning all or selected memory channels, priority watch checks for signals on the priority frequency every 5 sec.

- When the skip function is ON, skips specified memory channels.
- When the selected BANK or receive mode is not memorized, priority watch does not start.

6 PRIORITY WATCH

1. Program a priority channel

144.0000 MHz is initially programmed by default.

- ① Select the frequency (ex.) you want to program into the priority channel in VFO mode (p. 11) or MEMORY mode (p. 23).

```
MEMO
AM
F01 121.5000
```

- ② While pushing [FUNC], push [(9)PRIO] for 2 sec.



```
MEMO
AM
F01 121.5000
144.0000
```



```
MEMO
AM
PRIO SET
121.5000
```



```
MEMO
AM
F01 121.5000
121.5000
```

Start priority watch automatically.

2. Set MAIN frequency

Set the frequency in VFO mode (pgs. 14, 15) or select the memory channel (p. 24) you want to listen to with the priority channel, or start scanning (p. 35).

(ex.)

```
WFM VFO
59:7500
121:5000
```

Flashes when priority watch is selected scanning

```
VFO
AM
59 7500
121.5000
```

Appears while watching frequency or band

While pushing [FUNC], push [(9)PRIO], or push [CLR] only to stop priority watch.

■ General

The IC-R10 has an EASY mode which provides simple operation by only scanning programmed frequency ranges. When you select EASY mode, 1 of 10 pre-programmed frequency ranges can be selected.

10 different frequency ranges are programmed for EASY mode operation in some transceiver versions; however, 0.5–1300.0000 MHz with FM receive mode is pre-programmed into all 10 channels in other versions.

Settings for each range are programmable. See page 55, before you operate in EASY mode, in case EASY mode doesn't have the frequency ranges you want or when you want to set up preferred conditions.

■ EASY mode operation

1. Select EASY mode

Push [EASY] to select EASY mode.

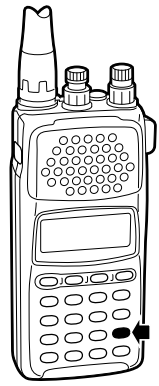

Appears

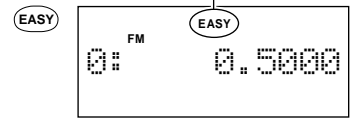

2. Select frequency range and start scanning

1 Push a numeral key to select a frequency range to search.

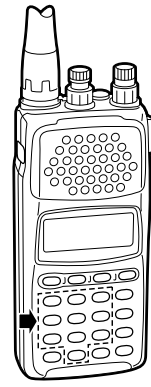

2 Push [SCAN] to start scanning.

3 Push [SCAN] or [CLR] to stop scanning.

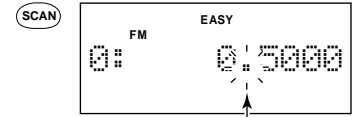

Flashes while scanning

■ General

The edit function is used for arranging memorized contents into the following channels:

Memory channels

Program/auto-memory write scan channels

EASY mode channels

■ Memory channel edit

You can store the following items into a memory channel:

1. *Frequency settings:* (SET FREQ)
Memorized frequencies can be edited or erased.
2. *Channel names:* (SET CH NAME)
Alphanumeric names can be input or edited. (Up to 8 characters per name.)
3. *Receive mode:* (SET MODE)
Receive mode can be specified.
4. *SKIP setting:* (SET SKIP)
SKIP settings can be toggled ON or OFF for memory skip scan (pgs. 39, 43, 44).
5. *Attenuator setting:* (SET ATT)
Attenuator settings can be toggled ON or OFF.
6. *BANK names:* (SET B-NAME)
Alphanumeric names can be input or edited. (Up to 10 characters per name.)

Memory channel edit flow chart

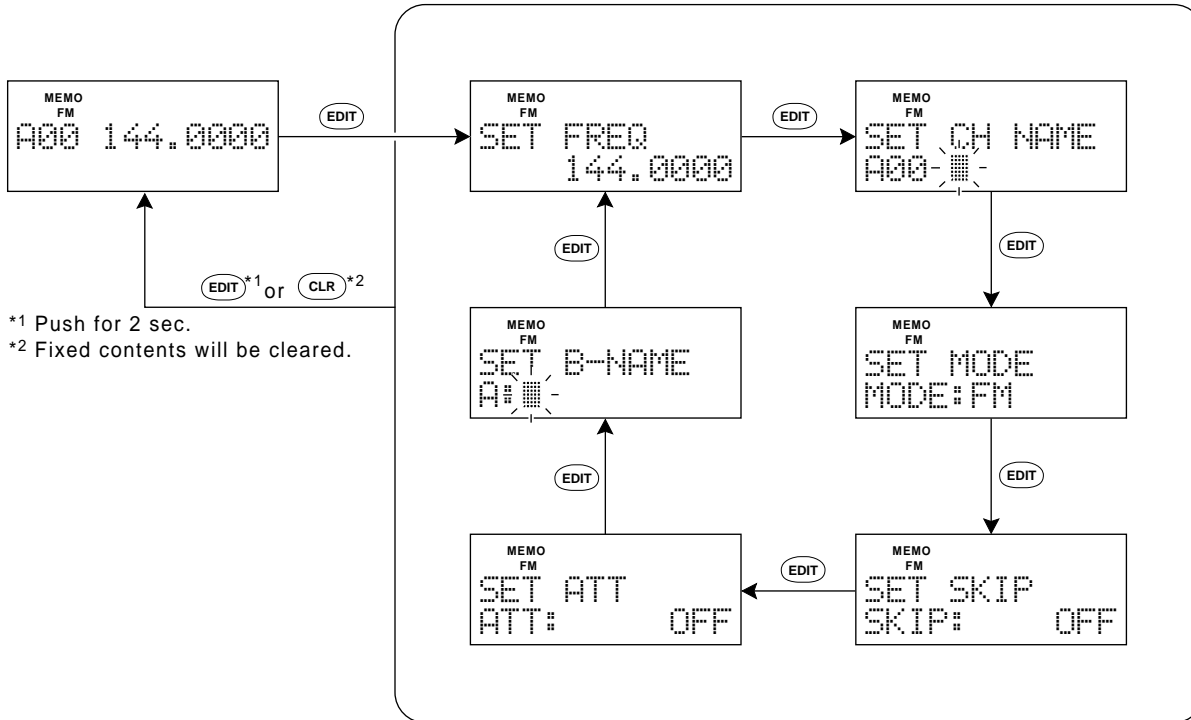

*1 Push for 2 sec.
 *2 Fixed contents will be cleared.

8 EDIT FUNCTION

■ Memory channel edit

1. Enter memory edit mode

- ① Push [V/M] to select MEMORY mode, then select the memory channel (pgs. 23, 24).
- ② Push [EDIT] to enter memory edit mode.

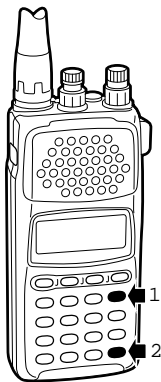

2. Set frequency

- ① Enter the frequency via the keypad or by rotating [DIAL].
- ② Push [EDIT] to change the item.





[DIAL]
or
digit
keys

MEMO
FM
SET FREQ
144.0000

3. Set channel names

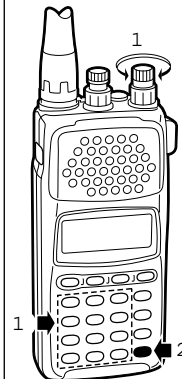
- ① Enter channel names via the keypad or by rotating [DIAL].
 - When you enter channel names from the [DIAL] or a character assigned in the same key, push [ENT] before you enter the next character to change the digit (see page 72 for alphanumeric key assignment).



- ② Push [EDIT] to change the item.

[DIAL]

MEMO
FM
SET CH NAME
ABC*
|
|

4. Set receive mode and skip condition

- ① Rotate [DIAL] to select receive mode.

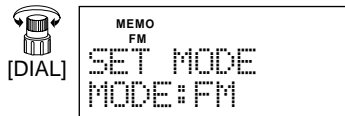

- ② Push [EDIT] to change the item.
- ③ Rotate [DIAL] to select skip condition.



- ④ Push [EDIT] to change the item.

5. Set attenuator condition

- ① Rotate [DIAL] to select attenuator condition.

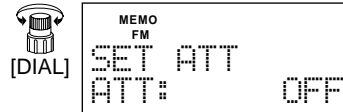

- ② Push [EDIT] to change the item.

6. Set BANK names

- ① Enter BANK names from the keypad or via [DIAL] as for channel name setting (see page 72 for alphanumeric key assignments).
- ② Push and hold [EDIT] to enter the fixed contents.
 - Push [EDIT] one or more times to confirm the entered contents, or push [CLR] to cancel all entered contents, if required.

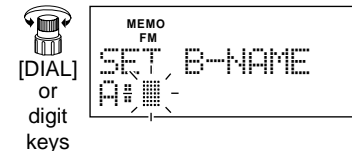

■ Program scan channel edit

Arrange memorized contents into program scan channels 00 to 19.

You can edit the following items:

1. *Channel names:* (SET CH NAME)
Set channel names for programmed frequency range; up to 8 characters per name.
2. *Scan band edge 1:* (START FREQ)
Set the start frequency for scan frequency range.
3. *Scan band edge 2:* (END FREQ)
Set the end frequency for scan frequency range.
4. *Receive mode:* (SET MOD)
Select a receive mode.
5. *Tuning step:* (SET TS)
Select or program a tuning step.
6. *Scan delay time:* (SCAN DELAY)
Select the scan delay (pausing) time.

■ EASY mode channel edit

Arrange memorized contents in EASY mode channels 0 to 9.
You can edit the following items:

1. *Channel names:* (SET CH NAME)
Set channel names for programmed frequency range; up to 8 characters per name.
2. *Scan band edge 1:* (START FREQ)
Set the start frequency for scan frequency range.
3. *Scan band edge 2:* (END FREQ)
Set the end frequency for scan frequency range.
4. *Receive mode:* (SET MOD)
Select a receive mode.
5. *Tuning step:* (SET TS)
Select or program a tuning step.
6. *Scan delay time:* (SCAN DELAY)
Select the scan delay (pausing) time.

Program/auto-memory write scan and EASY mode channel edit flow chart

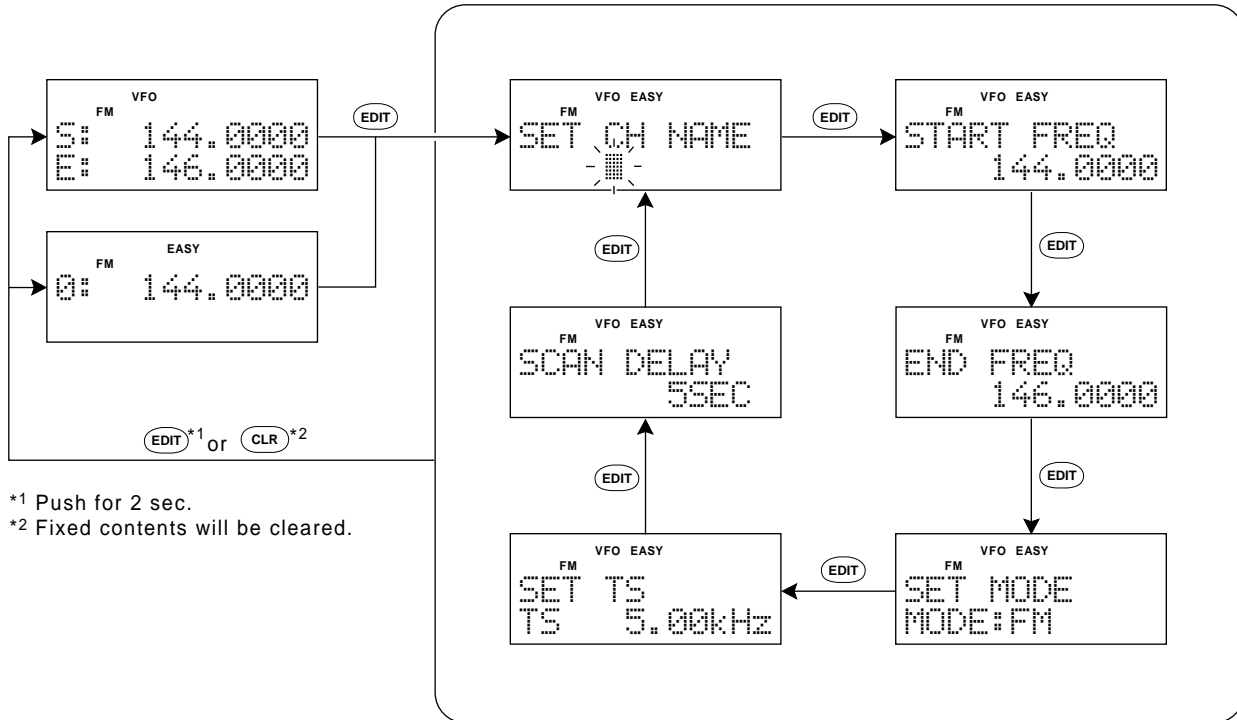

*1 Push for 2 sec.

*2 Fixed contents will be cleared.

■ Program scan or EASY mode channel edit

1. Enter edit mode

- ① Push [V/M] or [EDIT] to select VFO or EASY mode (p. 11 or 50).
- ② While pushing [FUNC], push [(4)PROG-S] or [(5)AMWS] to select program or auto-memory write scan mode; then select the scan channel (pgs. 40, 41) when VFO mode is selected in 1, push digit key to select scan channel when EASY mode is selected in 1.

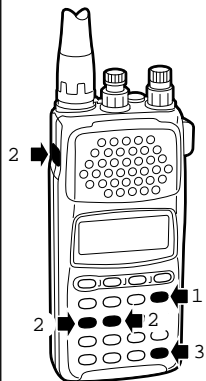

- ③ Push [EDIT] to enter memory edit mode.

2. Set channel names

- ① Enter channel names from the keypad or by rotating [DIAL].
 - When you enter channel names with [DIAL] or a character assigned to the same key, push [ENT] before you enter the next character to change the digit (see page 72 for alphanumeric key assignments).
- ② Push [EDIT] to change the item.

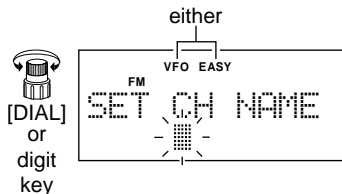
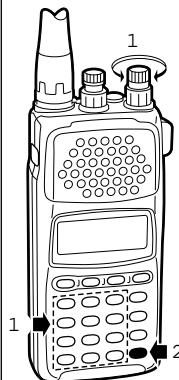

3. Set start frequency

- ① Enter the start frequency via the keypad or [DIAL].
- ② Push [EDIT] to change the item.

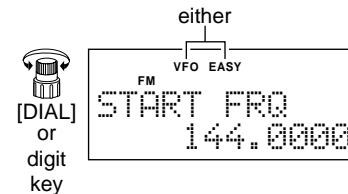

4. Set end frequency

- ① Enter the start frequency via the keypad or [DIAL].
- ② Push [EDIT] to change the item.

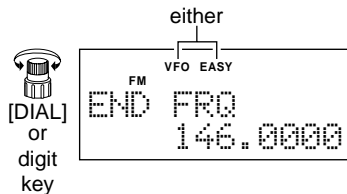

5. Set receive mode and tuning step

- ① Rotate [DIAL] to select receive mode.

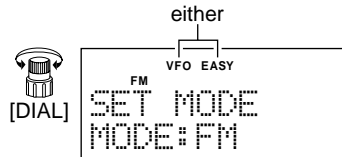

- ② Push [EDIT] to change the item.
- ③ Rotate [DIAL] to select skip condition.

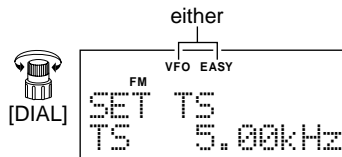

- ④ Push [EDIT] to change the item.

6. Set scan delay time

- ① Rotate [DIAL] to select scan delay time.

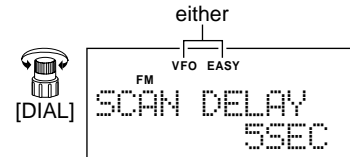

- ② Push and hold [EDIT] to enter the set contents.
 - Push [EDIT] one or more times to confirm the set contents, or push [CLR] to cancel, if desired.

General

What is SET mode?

SET mode is accessed from VFO, MEMORY or EASY mode and allows you to modify certain receiver conditions to suit your operating requirements.

Adjusting these settings to your own individual preferences allows you to “customize” the receiver’s operating parameters to suit your operating style.

If you are not sure what effect changing a particular condition will have on the receiver’s performance—experiment with different settings. Don’t worry, there is no way you can damage the receiver by altering these settings.

There are 11 conditions which can be modified in SET mode. The displays at right show the initial or all reset (p. 70) conditions. See the following pages for an example of each condition and how to modify them.

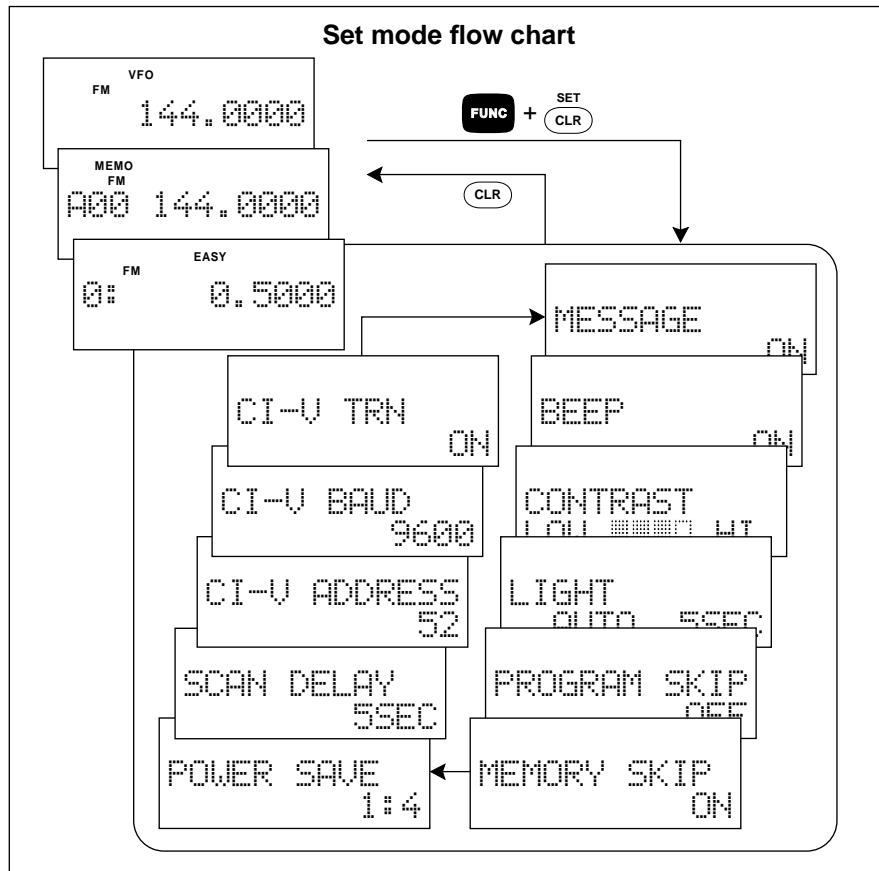

Entering SET mode

While pushing [FUNC], push [(CLR)SET] to enter SET mode.

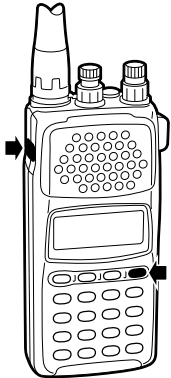

Push [EDIT] to select next item.

Opening message

Rotate [DIAL] to toggle opening message ON or OFF.

MESSAGE ON



MESSAGE OFF

Beep audio

Rotate [DIAL] to set beep audio ON or OFF.

BEEP ON



BEEP OFF

Display contrast

Rotate [DIAL] to adjust the LCD contrast to a suitable level.

CONTRAST
LOW [|||||] HI

CONTRAST
LOW [|||||] HI

CONTRAST
LOW [|||||] HI



CONTRAST
LOW [|||||] HI

9 SET MODE

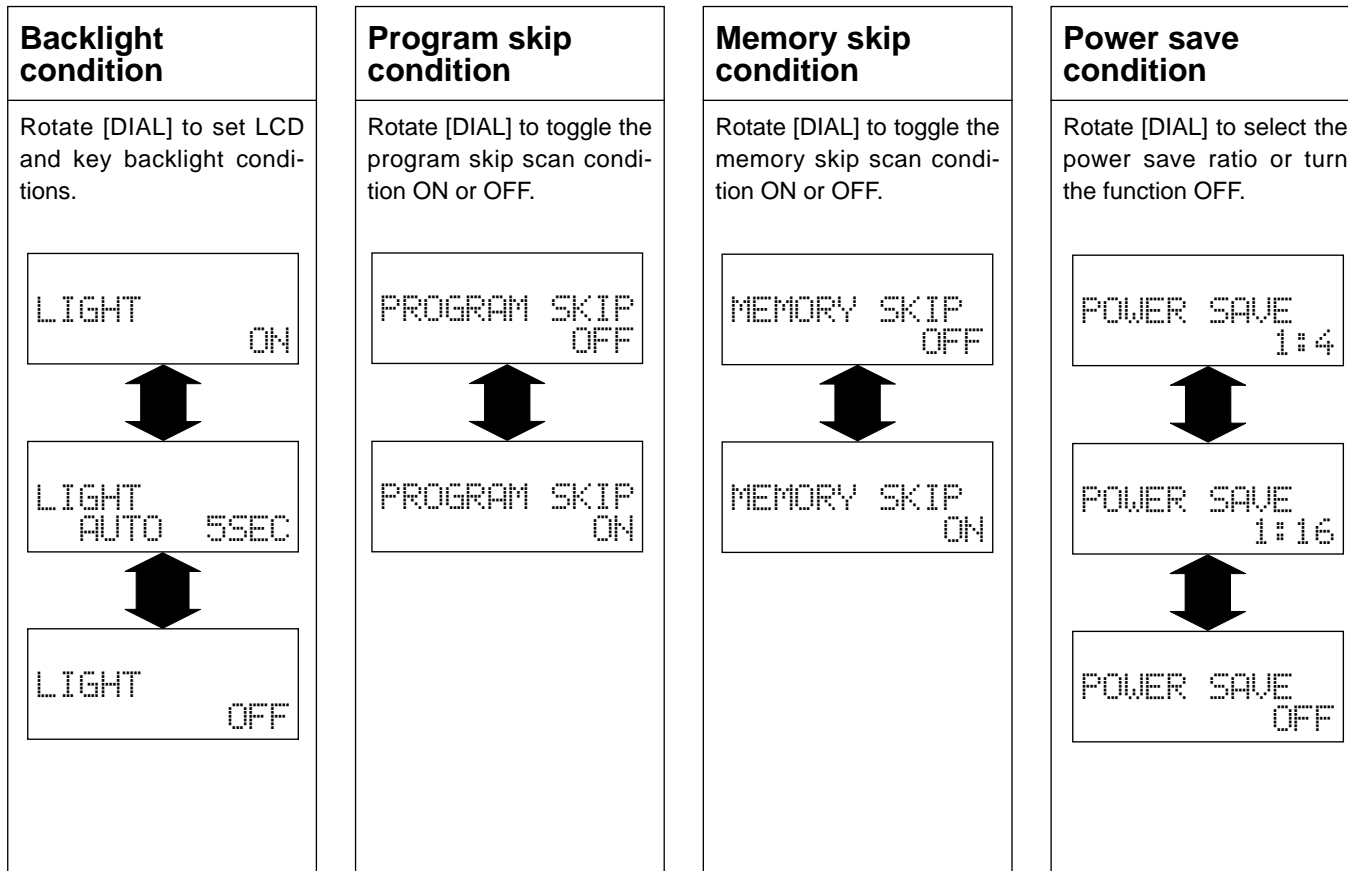

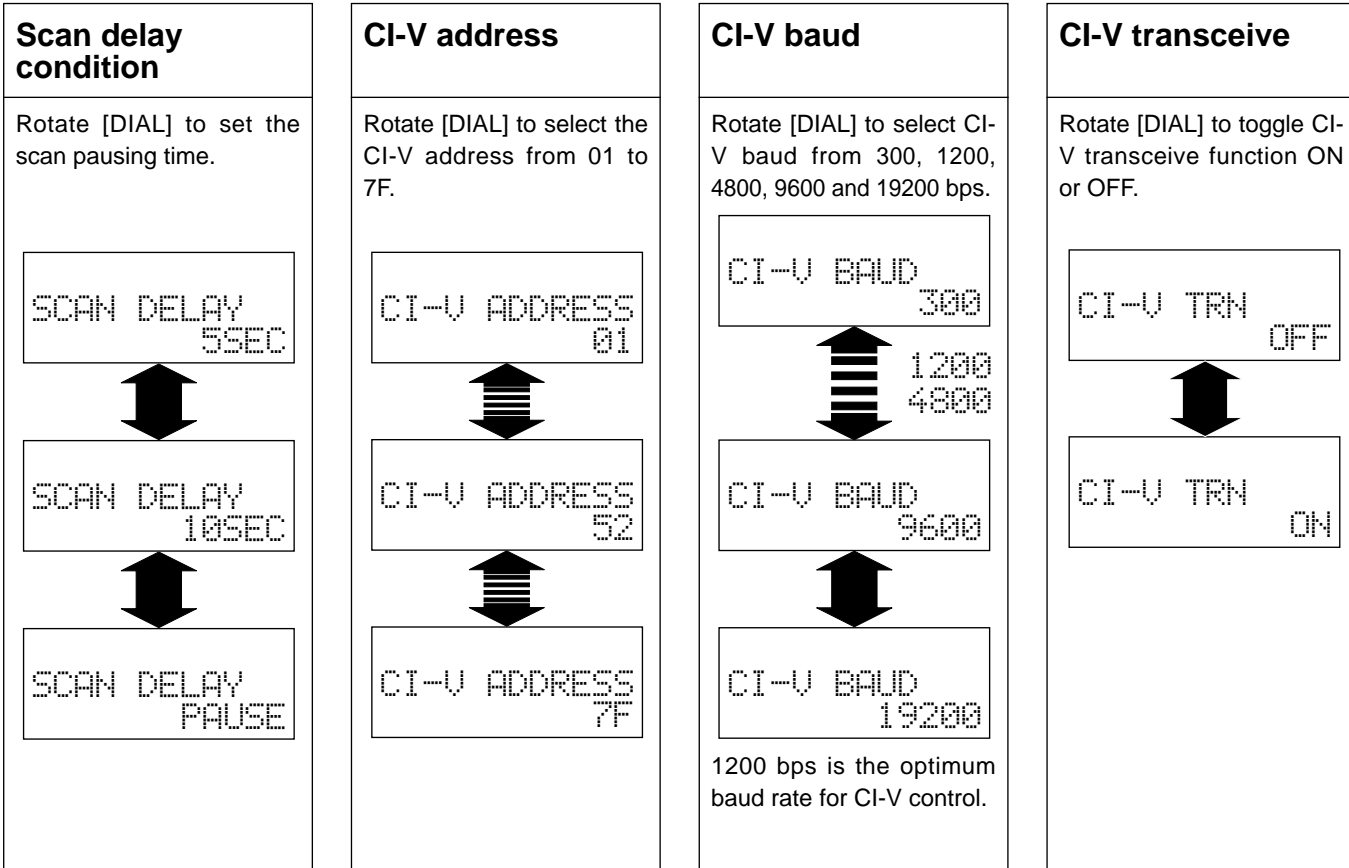

10 OTHER FUNCTIONS

■ Low battery indicator

The low battery indicator activates when the installed batteries fall to a specified voltage level. The receiver emits beeps and displays “LOW BATTERY” to inform you that battery capacity is low. Beeps sound once every 10 sec. and are synchronized with the beep setting in SET mode (p. 60).

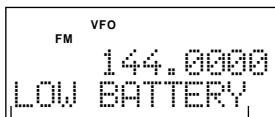

appears once every 5 sec.

■ AFC function

The AFC (Automatic Frequency Control) function tunes the displayed frequency automatically when an off-center frequency is received. It activates in FM modes only.

Setting AFC

While pushing [FUNC], push [(.)AFC] to toggle the AFC function ON and OFF.

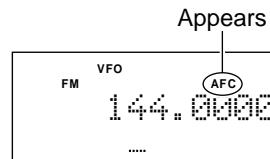
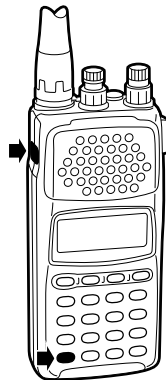

■ Monitor function

The monitor function releases the squelch or VSC mute momentarily when very weak signals are received without having to re-adjust the squelch manually.

Set monitor

While pushing [MONI], squelch mute is released; when the VSC function is ON, both squelch and VSC mute are released.

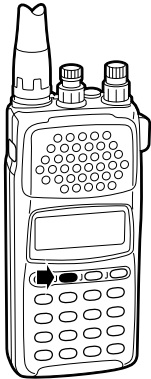

■ Lock function

The lock function is available so that you can listen to one frequency continuously and not worry about accidentally changing it or activating an undesired function.

Set lock

While pushing [FUNC], push [(EDIT)LOCK] to toggle the lock function ON and OFF.

All switches and controls are electronically locked except for [POWER], [MONI] and [FUNC].

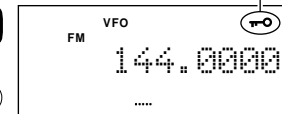
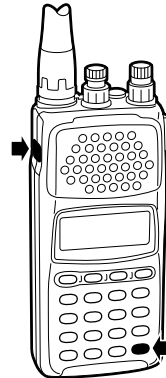

10 OTHER FUNCTIONS

■ ATT function

The ATT (attenuator) function protects desired signals from distorting when excessively strong signals, such as broadcast, pager signals, etc. are nearby. This setting can be memorized into memory channels.

Set ATT

While pushing [FUNC], push [(0)ATT] to toggle the ATT function ON and OFF.

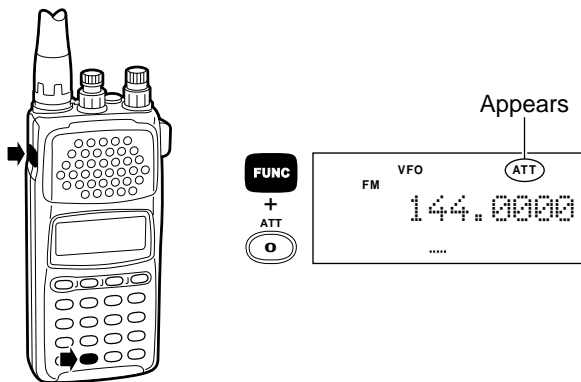

■ NB/ANL function

The NB (noise blanker) function removes pulse-type noise when USB, LSB or CW is selected. The ANL (automatic noise limiter) function reduces noise components when AM is selected.

Set NB/ANL

While pushing [FUNC], push [(ENT)NB/ANL] to toggle the NB or ANL function ON and OFF.

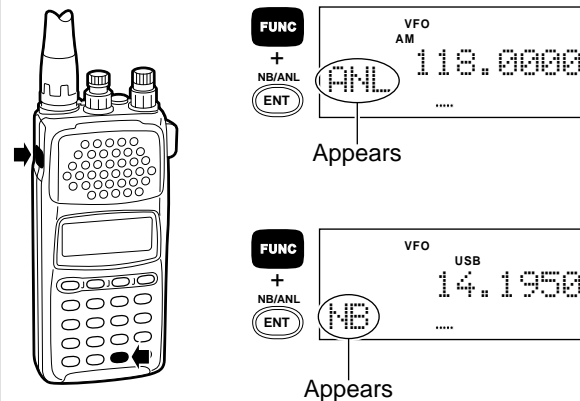

■ Sleep timer function*

The sleep timer activates after a specified time elapses, automatically turning the receiver power OFF.

Set sleep timer

- ① While pushing [FUNC], push [(3)SLEEP] one or more times to set the sleep timer condition.
- ② Release [FUNC] to set the selected condition.
- ③ When the specified time elapses, the receiver emits 5 beeps then powers OFF.

*When you want to use the sleep timer function in EASY mode—set it in VFO or MEMORY mode first, then enter EASY mode.

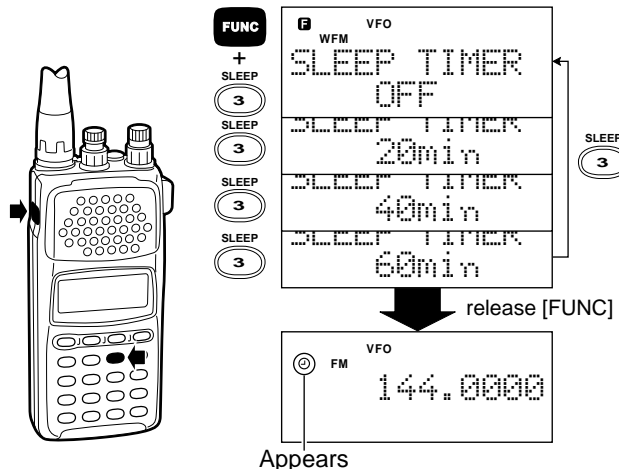

■ User TS setting

The user programmable tuning step allows you to set optimum tuning steps for specific channel spacing using the [DIAL].

Set tuning step

- ① Enter tuning step set mode (p. 13), then rotate [DIAL] until "USER TS" appears.
- ② Enter the desired tuning step using the numeral keys (including the decimal key, if necessary).
 - User tuning step is selectable from 0.1 kHz to 999.90 kHz (0.1 kHz step).
- ③ Push [CLR] to set tuning step and return to VFO.

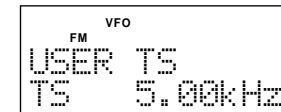

User TS default setting

10 OTHER FUNCTIONS

■ Memory search function

The memory search function searches memory channels using channel names. This is useful for recalling memory channels when you forget their channel number.

Enter memory search mode

- ① Push [V/M] to select MEMORY mode (p. 23).
- ② While pushing [FUNC], push [(EASY)SEARCH].

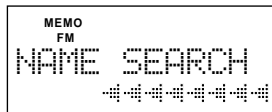
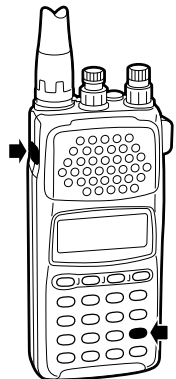

Enter memory channel names

Enter memory channel names via the keypad or [DIAL].

- When you enter channel names with [DIAL] or a character assigned to the same key, push [ENT] before you enter the next character to change the digit (see page 72 for alphanumeric key assignments).

Refer to memory edit for entering alphanumeric characters.

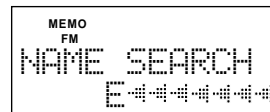
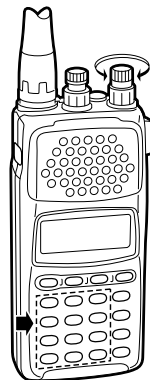

Searching

Push [SCAN] to start memory channel search.

- Only the first one or two characters are needed to start a search. Smaller channel numbers are displayed first in cases where two or more channels start with the same characters.
- Push [SCAN] again to display the next candidate in a search.

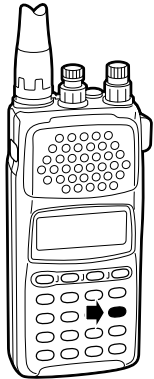

ENT

```
MEMO
FM
NAME SEARCH
F01:EMER.
```



```
MEMO
AM
F01 121.5000
```

Selecting a memory channel

Push [ENT] to select a memory channel.

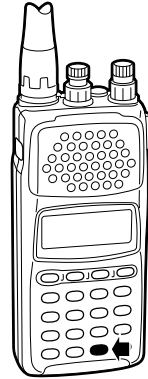

```
MEMO
FM
NAME SEARCH
F01:EMER.
```

when matching channel is found

```
MEMO
FM
NOT FOUND
E-444444
```

when no match is found

10 OTHER FUNCTIONS

■ Auto mode and TS function

The auto receive mode select and auto tuning step select functions are optionally available. This function can be set up and modified by programming from a computer using the optional CS-R10 CLONING SOFTWARE. Some versions may be pre-programmed.

Set auto mode

Push [MODE] one or more times, in VFO mode, until "AUTO MODE" appears, then push [CLR] to return to VFO mode.

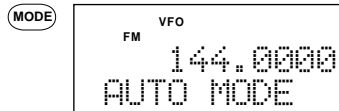
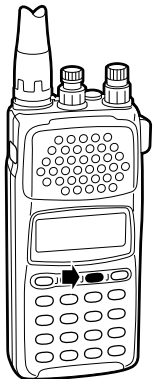

Set auto TS

While pushing [FUNC], push [(MODE)TS] in VFO mode, then rotate [DIAL] to select "TS AUTO"

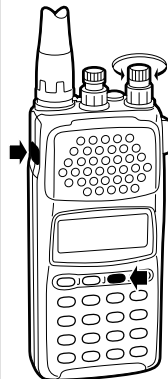

■ Resetting the CPU

There are 2 ways to reset the CPU as follows:

PARTIAL RESET:

When you want to initialize the operating conditions (VFO frequency, VFO settings, SET mode contents) without clearing the memory, program scan, EASY mode and auto TS/mode settings, a partial reset function is available for the receiver.

ALL RESET:

Use this option when the CPU malfunctions.

CAUTION: Resetting the CPU returns all programmed contents to their default settings.

Partial reset

① Turn power OFF.

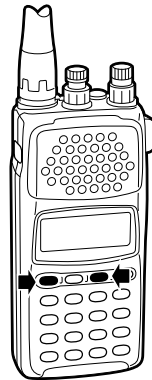

② While pushing [MODE], push [POWER] for 1 sec. to turn power ON.

③ Rotate [DIAL] to select "YES" or "NO", then push [ENT].

A partial reset is performed when "YES" is selected; selecting "NO" cancels the operation.



PARTIAL ?
NO

All reset

① Turn power OFF.

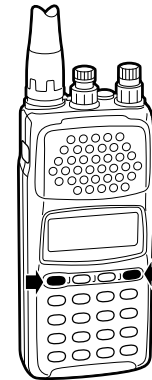

② While pushing [CLR], push [POWER] for 1 sec. to turn power ON.

③ Rotate [DIAL] to select "YES" or "NO", then push [ENT].

An all reset is performed when "YES" is selected; selecting "NO" cancels the operation.



ALL-RESET ?
NO

ALPHANUMERIC KEY ASSIGNMENT 11

Keypad Input	Corresponding Alphanumeric Character	
	No modifier key	While pushing [FUNC]
1	Q (Q), Z(Z), 1 (1)	q (q), z(z), 1 (1)
2	A (A), B(B), C(C), 2(2)	a (a), b(b), c(c) 2(2)
3	D (D), E(E), F(F), 3(3)	d (d), e(e), f(f), 3(3)
4	G (G), H(H), I (I), 4(4)	g (g), h(h), i (i), 4(4)
5	J (J), K(K), L(L), 5(5)	j (j), k (k), l (l), 5(5)
6	M (M), N(N), O(O), 6(6)	m (m), n(n), o(o), 6(6)
7	P (P), R(R), S(S), 7(7)	p (p), r(r), s(s), 7(7)
8	T (T), U(U), V(V), 8(8)	t (t), u(u), v(v), 8(8)
9	W (W), X(X), Y(Y), 9(9)	w (w), x(x), y (y), 9(9)
0	0 (0)	0 (0)
.	(space), # (period), ÷ (comma), - (hyphen)	(space), # (period), ÷ (comma), - (hyphen)

NOTE: In addition to the characters listed in the table at left, the following characters are available when using [DIAL] for alphanumeric input:

- | | |
|---------------------------|---------------------------|
| ! (exclamation mark) | " (double quotation mark) |
| # (number) | \$ (dollar sign) |
| % (percent sign) | & (ampersand) |
| ' (single quotation mark) | ((left parenthesis) |
|) (right parenthesis) | * (asterisk) |
| + (plus sign) | / (slash) |
| : (colon) | ; (semi-colon) |
| < (left angle bracket) | = (equals sign) |
| > (right angle bracket) | ? (question mark) |
| @ (at symbol) | [(left bracket) |
| ¥ (yen symbol) |] (right bracket) |
| ^ (caret) | ~ (under score) |
| ` (grave accent) | { (left brace) |
| (bar) | } (right brace) |

12 CONTROL COMMANDS

■ General

The IC-R10 can be connected to a PC via the PC's RS-232C port using an optional CT-17 CI-V LEVEL CONVERTOR. This allows you to control the receiver from the PC and/or transfer data from the receiver to the PC.

Control is provided via Icom's CI-V Communication Interface.

■ Data format

The CI-V system can be operated using the following data formats. Data formats differ according to command numbers. A data area is added for some commands.

Controller → IC-R10

FE	FE	52	E0	Cn	Sc	Data area	FD
①	②	③	④	⑤	⑥	⑦	

IC-R10 → Controller

FE	FE	E0	52	Cn	Sc	Data area	FD
①	③	②	④	⑤	⑥	⑦	

- ① Preamble code (fixed)
- ② Receiver's default address
- ③ Controller's default address
- ④ Command number (see table below)
- ⑤ Sub command number (see table below)
- ⑥ BCD code data for frequency entry
- ⑦ End of message code (fixed)

■ Command table

Description	Cn	Sc
Transfers frequency data (transceive)	00	—
Transfers mode data (transceive)	01	—
Reads display frequency	03	—
Reads display mode	04	—
Sets frequency data	05	—
Sets LSB mode	06	00
Sets USB mode		01
Sets AM mode		02
Sets CW mode		03
Sets FM mode		05
Sets WFM mode		06
Reads squelch condition (open or closed)	15	01
Reads S-meter level		02

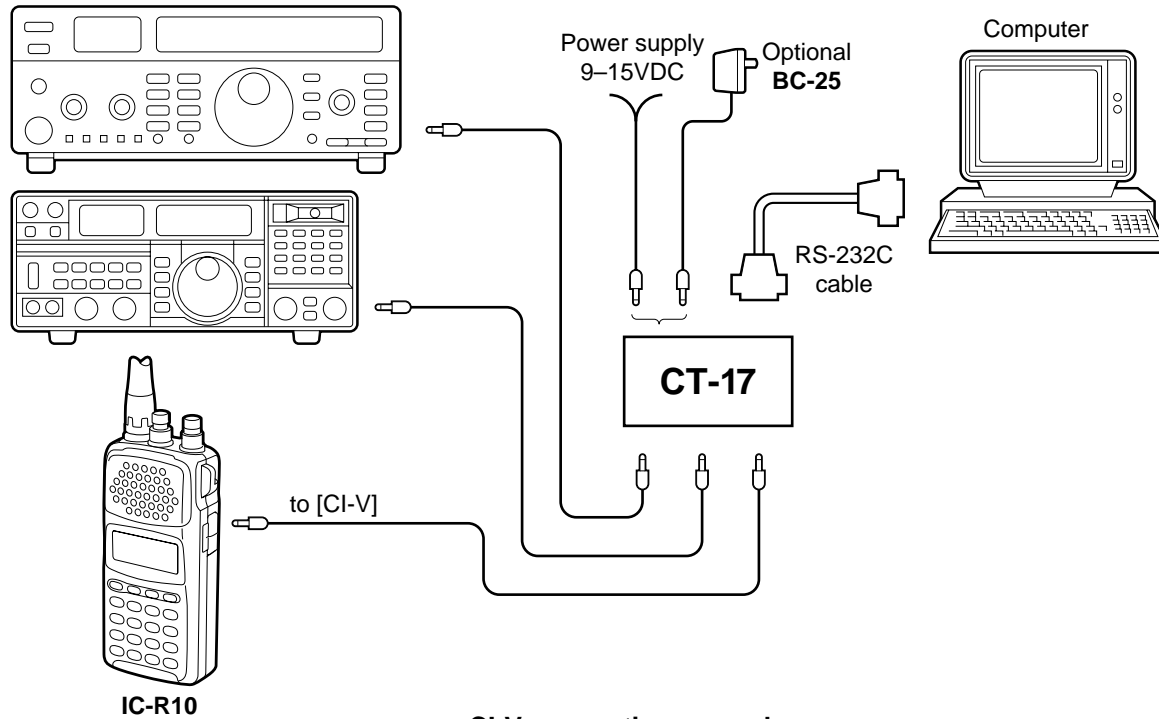

CI-V connection example

13 TROUBLESHOOTING

If your receiver seems to be malfunctioning, please check the following points before sending it to a service center.

PROBLEM	POSSIBLE CAUSE	SOLUTION	REF.
No power comes on.	<ul style="list-style-type: none"> •The installed batteries are exhausted. (A slight current flows in the circuits even when the power is OFF.) •The batteries have been installed in reverse polarity. 	<ul style="list-style-type: none"> •Charge the batteries or place new dry cell batteries in the battery case. (Remove the batteries if you will not be using the receiver for a long time.) •Re-install the batteries in the correct orientation. 	<p>p. 8</p> <p>p. 8</p>
No audio is output.	<ul style="list-style-type: none"> •[VOL] is turned to the minimum position. •Earphone or headphone is connected. •The [SQL] is turned too far clockwise. •VSC function is activated. 	<ul style="list-style-type: none"> •Turn [VOL] to a suitable level. •Disconnect the earphone or headphone. •Turn the [SQL] counterclockwise. •Release the VSC function. 	<p>p. 10</p> <p>p. 11</p> <p>p. 38</p>
Weak reception, excessive distortion or too much noise.	<ul style="list-style-type: none"> •Not centered on the frequency. •Wrong receive mode is selected. •ATT function is activated. •The [SQL] (RF gain) is set too far clockwise (when USB, LSB or CW is selected). •Batteries are nearly exhausted. 	<ul style="list-style-type: none"> •Set to the center frequency using a small tuning step. •Select the correct receive mode. •Release the ATT function. •Turn the [SQL] (RF gain) counterclockwise. •Charge the batteries or place new dry cell batteries in the battery case. 	<p>p. 13</p> <p>p. 12</p> <p>p. 65</p> <p>p. 11</p> <p>p. 8</p>
Cannot tune frequency via the keypad or [DIAL]	<ul style="list-style-type: none"> •Lock function is ON. 	<ul style="list-style-type: none"> •While pushing [FUNC], push [(EDIT)LOCK] to turn the lock function OFF. 	<p>p. 64</p>
Cannot charge the installed Ni-Cd batteries.	<ul style="list-style-type: none"> •[CHARGE] is set to the OFF position. 	<ul style="list-style-type: none"> •Set [CHARGE] to the ON position. 	<p>p. 8</p>

PROBLEM	POSSIBLE CAUSE	SOLUTION	REF.
Cannot start scanning.	<ul style="list-style-type: none"> •[SQL] is rotated too far clockwise. •Incorrect receive mode (LSB, USB or CW) is selected. •Scan edges are set to the same frequencies. •2 or more memory channels have not been programmed. •No channels have been programmed with the selected receive mode (when using mode select scan). 	<ul style="list-style-type: none"> •Rotate [SQL] counterclockwise. •Set receive mode to one of FM, WFM or AM. •Set scan edges to different frequencies. •Program 2 or more memory channels. •Program at least 2 channels with the selected receive mode. 	<p>p. 11 p. 12</p> <p>p. 57 pgs. 25, 26, 27</p> <p>pgs. 25, 26, 27</p>
Cannot recall memory channels.	<ul style="list-style-type: none"> •Wrong operating mode is selected. 	<ul style="list-style-type: none"> •Push [V/M] to select memory mode. 	p. 23
WFM signal is distorted.	<ul style="list-style-type: none"> •Not tuned to the proper frequency. 	<ul style="list-style-type: none"> •Set the frequency 30–50 kHz less. 	p. 20

14 SPECIFICATIONS

GENERAL

Frequency coverage : (Unit: MHz)

Version	Frequency Range
U.S.A.	0.5000– 823.9999
	849.0001– 868.9999
	894.0001–1300.0000
Europe	0.5000–1300.0000
France	0.5000– 87.5000
	108.0000–1300.0000

Tuning steps : 0.1, 0.5, 1, 5, 6.25, 8, 9, 10, 12.5, 15, 20, 25, 30, 50 and 100 kHz
or user programmable (0.1–999.99 kHz/0.1 kHz steps)

Number of mem. channels : 1000

Receive modes : FM, AM, WFM, USB, LSB, CW

Antenna connector : BNC (50 Ω)

Power supply requirement : 4.8 V DC [4 AA (R6) Ni-Cd cells];
4.8–16 V DC acceptable
(negative ground)

Current drain (at 13.5 V DC) :

Rated audio : 180 mA typ.

Stand-by : 110 mA typ.

Power saved : 38 mA typ.

Usable temperature range : –10°C to +50°C (+14°F to +122°F)

Scan speed : 16.7 ch/sec. (programmed)

6.25 ch/sec. (memory)

Dimensions : 58.5(W) × 130(H) × 31.3(D) mm

2.3(W) × 5.1(H) × 1.2(D) in

Weight : 310 g; 10.9 oz.

CI-V connector : 3-conductor 3.5 (d) mm (1/8 in)

All stated specifications are subject to change without notice or obligation.

RECEIVER

Receive system : Triple-conversion superheterodyne

Intermediate frequencies :

1st 266.7 MHz (340.0000–999.9999MHz)

429.1 MHz (except above freq.)

2nd 10.7 MHz

3rd 455 kHz

Sensitivity :

Freq. (MHz)	FM	WFM	AM	SSB/CW
0.5– 4.9999	0.5 μV	—	1.6 μV	0.4 μV
5– 74.9999	0.32 μV	—	1.0 μV	0.25 μV
75– 199.9999		1.0 μV		
200– 339.9999	0.45 μV	2.2 μV	1.6 μV	0.4 μV
340– 699.9999	0.35 μV	1.3 μV	1.4 μV	0.32 μV
700– 799.9999	0.79 μV	2.0 μV	2.0 μV	0.63 μV
800– 899.9999	0.5 μV	1.6 μV	1.6 μV	0.4 μV
900–1300.0000		—		

Squelch sensitivity :

Freq. (MHz)	FM	WFM	AM
0.5– 4.9999	0.5 μV	—	1.6 μV
5– 74.9999	0.32 μV	—	1.0 μV
75– 199.9999		1.0 μV	
200– 339.9999	0.45 μV	2.2 μV	1.6 μV
340– 699.9999	0.35 μV	1.3 μV	1.4 μV
700– 799.9999	0.79 μV	2.0 μV	2.0 μV
800– 899.9999	0.5 μV	1.6 μV	1.6 μV
900–1300.0000		—	

Selectivity

: AM, FM More than 15 kHz/6 dB
SSB More than 4 kHz/6 dB
WFM More than 150 kHz/6 dB

Audio output power

: More than 120 mV at 10 % distortion
with an 8 Ω load

External speaker connector

: 3-conductor 3.5 (d) mm (1/8 in)

- **CS-R10** CLONING SOFTWARE + **OPC-478** CLONING CABLE
Allows you to transfer data from memories, etc., quickly and easily edit and store data via an IBM compatible PC.
- **LC-140** CARRYING CASE
Protects the receiver from everyday wear and tear.
- **CT-17** CI-V LEVEL CONVERTOR
For receiver remote control using an IBM compatible personal computer.
- **HP-4** HEADPHONE/**SP-13** EARPHONE
Provides increased readability of signals in noisy environments and listening privacy.
- **CP-12L** CIGARETTE LIGHTER CABLE WITH NOISE FILTER
Allows you to operate the receiver through a 12 V cigarette lighter socket.
- **OPC-254L** POWER CABLE
Allows you to operate the receiver with 4.5 to 16 V external DC power.
- **OPC-474** CLONING CABLE
Allows you to transfer data between receivers.

Count on us!

A-5410H-1EX-⑤
Printed in Japan
Copyright 1996 by Icom Inc.

Icom Inc.
6-9-16 Kamihigashi, Hirano-ku, Osaka 547 Japan