



INSTRUCTION MANUAL

HF/50 MHz
ALL MODE TRANSCEIVER

IC-756

IMPORTANT

READ THIS INSTRUCTION MANUAL CAREFULLY before attempting to operate the transceiver.

SAVE THIS INSTRUCTION MANUAL. This instruction manual contains important safety and operating instructions for the IC-756.

PRECAUTIONS

⚠ WARNING HIGH VOLTAGE! NEVER attach an antenna or internal antenna connector during transmission. This may result in an electrical shock or burn.

⚠ NEVER apply AC to the [DC13.8V] socket on the transceiver rear panel. This could cause a fire or ruin the transceiver.

⚠ NEVER apply more than 16 V DC, such as a 24 V battery, to the [DC13.8V] socket on the transceiver rear panel. This could cause a fire or ruin the transceiver.

⚠ NEVER let metal, wire or other objects touch any internal part or connectors on the rear panel of the transceiver. This will cause electric shock.

⚠ NEVER expose the transceiver to rain, snow or any liquids.

NEVER allow children to play with the transceiver.

AVOID using or placing the transceiver in areas with temperatures below -10°C ($+14^{\circ}\text{F}$) or above $+60^{\circ}\text{C}$ ($+140^{\circ}\text{F}$). Be aware that temperatures on a vehicle's dashboard can exceed 80°C ($+176^{\circ}\text{F}$), resulting in permanent damage to the transceiver if left there for extended periods.

AVOID placing the transceiver in excessively dusty environments or in direct sunlight.

AVOID placing the transceiver against walls or putting anything on top of the transceiver. This will obstruct heat dissipation.

During mobile operation, **DO NOT** operate the transceiver without running the vehicle's engine. When transceiver power is ON and your vehicle's engine is OFF, the vehicle's battery will soon become exhausted.

Make sure the transceiver power is OFF before starting the vehicle. This will avoid possible damage to the transceiver by ignition voltage spikes.

During maritime mobile operation, keep the transceiver and microphone as far away as possible from the magnetic navigation compass to prevent erroneous indications.

BE CAREFUL! The heatsink will become hot when operating the transceiver continuously for long periods.

BE CAREFUL! If a linear amplifier is connected, set the transceiver's RF output power to less than the linear amplifier's maximum input level, otherwise, the linear amplifier will be damaged.

Use Icom microphones only (supplied or optional). Other manufacturer's microphones have different pin assignments and connection to the IC-756 may damage the transceiver.

EXPLICIT DEFINITIONS

| WORD | DEFINITION |
|------------------|---|
| ⚠ WARNING | Personal injury, fire hazard or electric shock may occur. |
| CAUTION | Equipment damage may occur. |
| NOTE | If disregarded, inconvenience only. No risk of personal injury, fire or electric shock. |

The explicit definitions described at left apply to this instruction manual.



The IC-756 complies with the essential requirements of the 89/336/EEC directive for Electromagnetic Compatibility. This compliance is based on conformity with the ETSI specification prETS300 684 (EMC product standard for Commercially Available Amateur Radio Equipment).

TABLE OF CONTENTS

| | | | |
|--|-------|--|---|
| IMPORTANT | i | 4 RECEIVE AND TRANSMIT ... 25–40 | <ul style="list-style-type: none"> ■ ΔF scan operation 48 ■ Fine programmed scan/ fine ΔF scan 49 ■ Memory scan operation 49 ■ Select memory scan operation 50 ■ Setting select memory channels ... 50 |
| PRECAUTIONS | i | <ul style="list-style-type: none"> ■ Mode selection 25 ■ Twin PBT operation 25 ■ Auto notch function 26 ■ Noise reduction 26 ■ Noise blanker 26 ■ APF function 27 ■ CW reverse mode 27 ■ RTTY reverse mode 27 ■ CW pitch control 27 ■ Filter selection 28 ■ RIT and ΔTX 29 ■ Dualwatch operation 30 ■ Split frequency operation 31 ■ Quick split function 32 ■ Monitor function 33 ■ VOX function 33 ■ Meter function 34 ■ Speech compressor 34 ■ SWR reading 34 ■ Electronic CW keyer 35 ■ Memory keyer 36 ■ Spectrum scope screen 37 ■ Band memory (for automatic antenna selection) 37 ■ Repeater operation 38 ■ Dial lock function 38 ■ Antenna tuner operation 39 ■ Optional external tuner operation 40 | |
| EXPLICIT DEFINITIONS | i | | |
| TABLE OF CONTENTS | ii | | |
| UNPACKING | ii | | |
| 1 PANEL DESCRIPTION | 1–12 | 5 MEMORY OPERATION | 41–46 |
| <ul style="list-style-type: none"> ■ Front panel 1 ■ Microphone (HM-36) 8 ■ LCD display 9 ■ Screen menu arrangement 10 ■ Rear panel 11 | | <ul style="list-style-type: none"> ■ Memory channels 41 ■ Memory channel selection 41 ■ Memory channel screen 42 ■ Memory channel programming 43 ■ Frequency transferring 44 ■ Memory names 45 ■ Memory clearing 45 ■ Memo pads 46 | |
| 2 INSTALLATION AND CONNECTIONS | 13–20 | 6 SCANS | 47–50 |
| <ul style="list-style-type: none"> ■ Unpacking 13 ■ Selecting a location 13 ■ Grounding 13 ■ Antenna 13 ■ Required connections 14 ■ Advanced connections 15 ■ Power supply connections 16 ■ Linear amplifier connections 17 ■ External antenna selector or antenna tuner connections 18 ■ FSK and AFSK (SSTV) connections 19 ■ Remote jack (CI-V) information 20 | | <ul style="list-style-type: none"> ■ Scan types 47 ■ Preparation 47 ■ Programmed scan operation 48 | |
| 3 FREQUENCY SETTING | 21–24 | 7 CLOCK AND TIMERS | 51–52 |
| <ul style="list-style-type: none"> ■ When first applying power (CPU resetting) 21 ■ Initial settings 21 ■ VFO description 22 ■ Frequency setting with the tuning dial 23 ■ Direct frequency entry with the keypad 23 ■ Advanced tuning functions 24 | | <ul style="list-style-type: none"> ■ Setting the current time 51 ■ Setting power-on time 51 ■ Setting power-off period 52 ■ Timer operation 52 | |
| | | 8 SET MODE | 53–60 |
| | | <ul style="list-style-type: none"> ■ Set mode description 53 ■ Level set mode 54 ■ Display set mode 54 ■ Timer set mode 55 ■ Miscellaneous (others) set mode .. 55 | |
| | | 9 OPTION INSTALLATIONS | 61–62 |
| | | <ul style="list-style-type: none"> ■ Opening the transceiver's case 61 ■ UT-102 VOICE SYNTHESIZER UNIT 61 ■ Optional IF filters 62 ■ CR-502 HIGH STABILITY CRYSTAL UNIT 62 | |
| | | 10 MAINTENANCE | 63–65 |
| | | <ul style="list-style-type: none"> ■ Troubleshooting 63 ■ Fuse replacement 64 ■ Clock backup battery replacement 64 ■ Tuning dial brake adjustment 65 ■ Frequency calibration (approximate) 65 | |
| | | 11 INTERNAL VIEWS | 66 |
| | | 12 SPECIFICATIONS | 67 |
| | | 13 OPTIONS | 68 |

UNPACKING

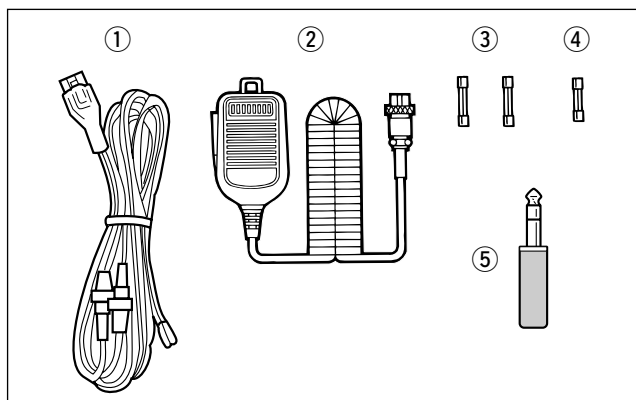

| Accessories included with the IC-756: | Qty. |
|---------------------------------------|------|
| ① DC power cable (OPC-025A) | 1 |
| ② Hand microphone (HM-36) | 1 |
| ③ Spare fuses (FGB 20 A) | 2 |
| ④ Spare fuse (FGB 5 A) | 1 |
| ⑤ CW keyer plug (AP-330) | 1 |

■ Front panel

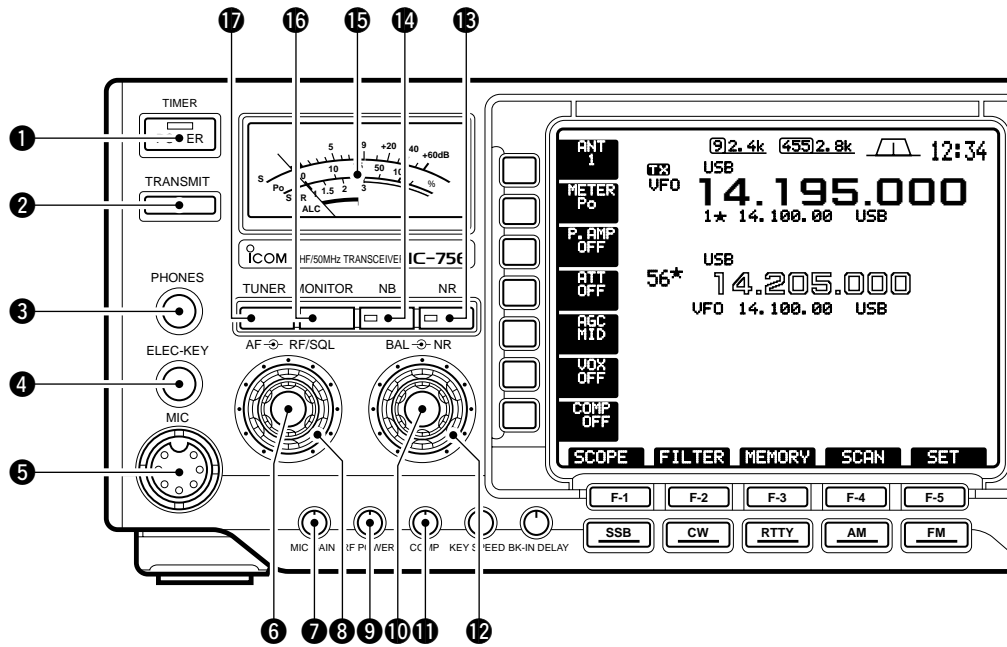

1 POWER SWITCH [POWER/TIMER]

- Push momentarily to turn power ON.
 - Turn the optional DC power supply ON in advance.
- Push momentarily to toggle the timer function ON and OFF. (p. 52)
 - The power switch lights while the timer function is ON.
- Push for 2 sec. to turn power OFF.

2 TRANSMIT SWITCH [TRANSMIT]

- Selects transmitting or receiving.
 - The [TX] indicator lights red while transmitting and the [RX] indicator lights green when the squelch is open.

3 HEADPHONE JACK [PHONES]

- Accepts headphones.
 - When headphones are connected, the internal speaker or connected external speaker does not function.

4 ELECTRONIC KEYS JACK [ELEC-KEY] (p. 35)

- Accepts a paddle to activate the internal electronic keyer for CW operation.
 - Selection between the internal electronic keyer, bug-key and straight key operation can be made in keyer set mode. (p. 35)
 - A straight key jack is separately available on the rear panel. See [KEY] on p. 11.
 - Keyer polarity (dot and dash) can be reversed in keyer set mode. (p. 35)
 - 4-channel memory keyer is available for your convenience. (p. 36)

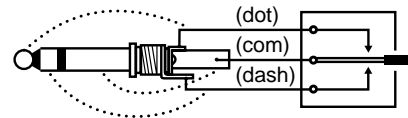

5 MICROPHONE CONNECTOR [MIC]

- Accepts the supplied or optional microphone.
 - See p. 68 for appropriate microphones.
 - See p. 8 for microphone connector information.

6 AF CONTROL [AF] (inner control)

- Varies the audio output level from the speaker.

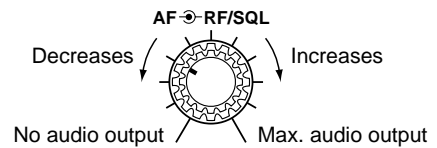

7 MIC GAIN CONTROL [MIC GAIN]

- Adjusts microphone input gain.

✓ How to set the microphone gain.

Set the [MIC] control so that the ALC meter sometimes swings during normal voice transmission in SSB mode.

Recommended level for an Icom microphone

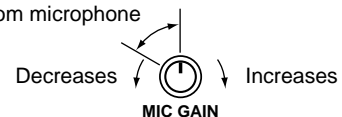

8 RF GAIN CONTROL/SQUELCH CONTROL [RF/SQL] (outer control)

Adjusts the RF gain and squelch threshold level. The squelch removes noise output from the speaker (closed condition) when no signal is received.

- The squelch is particularly effective for FM. It is also available for other modes.
- The control can be set as the RF gain control only (squelch is fixed open) or squelch control (RF gain is fixed at maximum) in set mode as follows. (p. 56)
- 11 to 12 o'clock position is recommended for any setting of the [RF/SQL] control.

•When setting as RF gain/squelch control

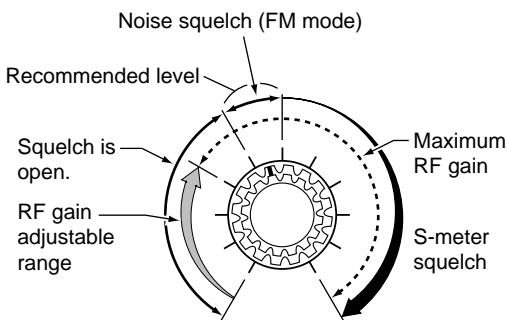

•When setting as RF gain control (Squelch is fixed open.)

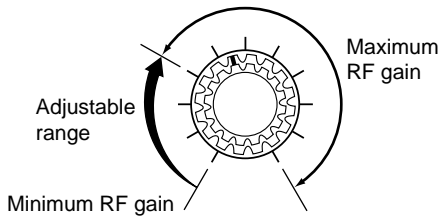

•When setting as squelch control (RF gain is fixed at maximum.)

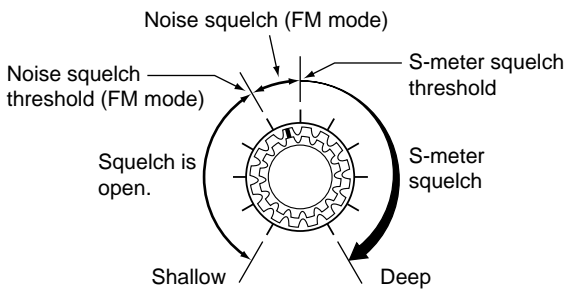

9 RF POWER CONTROL [RF POWER]

Continuously varies the RF output power from minimum (2 W*) to maximum (100 W*).

* AM mode: 1 W to 40 W



10 BALANCE CONTROL [BAL] (inner control; p. 30)
Adjusts the audio output balance between main and sub readout frequencies while in dualwatch.

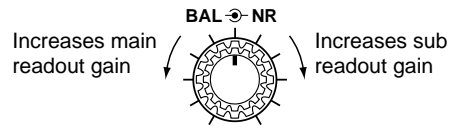

11 COMPRESSION LEVEL CONTROL [COMP] (p. 34)

Adjusts the speech compression level in SSB.



12 NOISE REDUCTION LEVEL CONTROL [NR] (outer control; p. 26)

Adjusts the noise reduction level when the noise reduction is in use. Set for maximum readability.

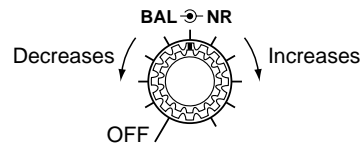

13 NOISE REDUCTION SWITCH [NR] (p. 26)

Toggles the noise reduction ON and OFF. Functions in SSB, CW and RTTY modes.

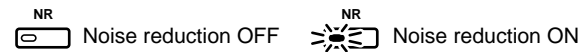

14 NOISE BLANKER SWITCH [NB] (p. 26)

Toggles the noise blanker ON and OFF. The noise blanker reduces pulse-type noise such as that generated by automobile ignition systems. This function cannot be used for FM, or non-pulse-type noise.

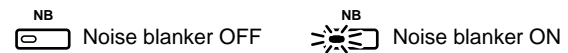

15 S/RF METER (p. 34)

Shows the signal strength while receiving. Shows the relative output power, SWR or ALC levels while transmitting.

16 MONITOR SWITCH [MONITOR] (p. 33)

Monitors your transmitted IF signal.
- The CW sidetone functions when [MONITOR] is OFF in CW mode.

17 ANTENNA TUNER SWITCH [TUNER] (p. 39)

- Turns the antenna tuner ON and OFF (bypass) when pushed momentarily.
- Starts to tune the antenna manually when pushed for 2 sec.
- When the tuner cannot tune the antenna, the tuning circuit is bypassed automatically after 20 sec.

1 PANEL DESCRIPTION

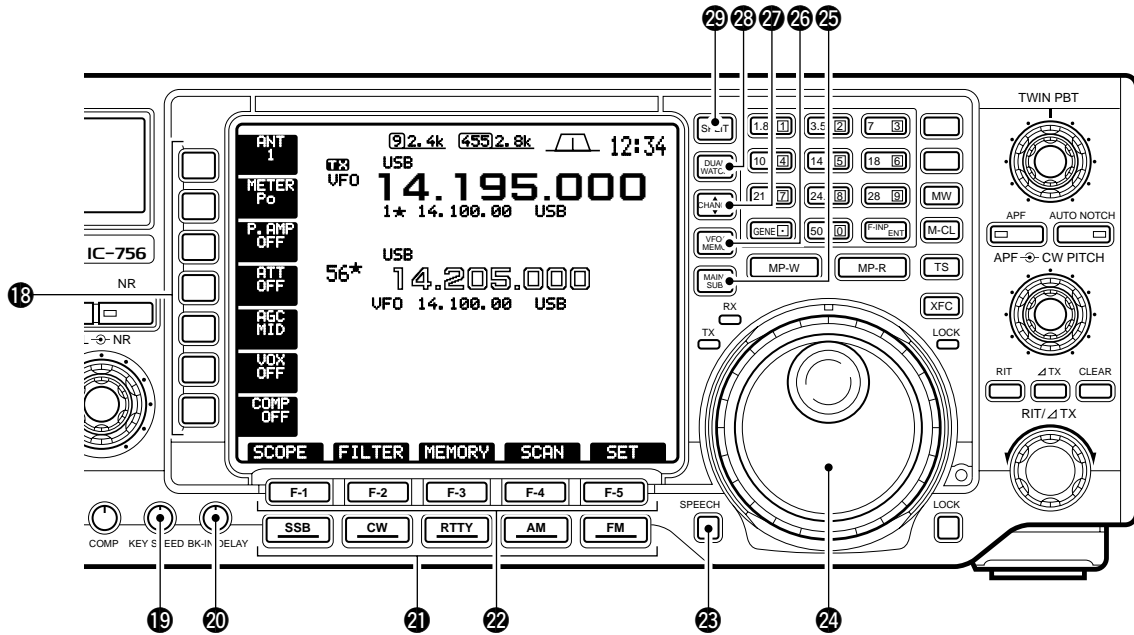

18 MULTI-FUNCTION SWITCHES

- Push to select the functions indicated in the LCD display to the right of these switches.
 - Functions vary depending on the operating condition.
- Push to input a character for memory keyer programming or memory name. (pgs. 36, 45)

ANT 1

- Toggles the antenna connector selection between ANT1/R and ANT2/R when pushed. (p. 37)
- Toggles the receive antenna ON and OFF when pushed for 2 sec.

METER Po

- Selects RF power (Po), SWR or ALC metering during transmit. (p. 34)

P. AMP OFF

- Selects one of 2 receive RF preamps or bypasses them.
 - "P. AMP1" activates 10 dB preamp for HF all bands.
 - "P. AMP2" activates 16 dB high-gain preamp for 21 MHz band and above.

✓ What is the preamp?

The preamp amplifies received signals in the front end circuit to improve the S/N ratio and sensitivity. Select "P. AMP1" or "P. AMP2" when receiving weak signals.

ATT OFF

- Selects 6 dB, 12 dB or 18 dB attenuator, or bypasses them.

✓ What is the attenuator?

The attenuator prevents a desired signal from distorting when very strong signals are near the desired frequency or when very strong electric fields, such as from a broadcasting station, are near your location.

AGC MID

- Activates or selects fast, middle or slow AGC time constant when pushed.
 - The setting becomes "fast" in FM mode regardless of this setting.
- Deactivates the AGC circuit when pushed for 2 sec.

NOTE: While "AGC OFF" is selected, the S-meter does not function.

✓ What is the AGC?

The AGC controls receiver gain to produce a constant audio output level even when the received signal strength is varied by fading, etc. Select "FAST" for tuning and select "MID" or "SLOW" depending on the receiving condition.

VOX OFF

- Turns the VOX function ON and OFF when pushed in non-CW modes. (p. 33)

- Enters the VOX set mode when pushed for 2 sec. in non-CW modes. (p. 33)

BK-IN OFF

- Selects semi break-in, full break-in operation, or turns the break-in operation OFF when pushed in CW mode.

✓ What is the VOX function?

The VOX function (voice operated transmission) starts transmission without pushing the transmit switch or PTT switch when you speak into the microphone; then, automatically returns to receive when you stop speaking.

✓ What is the break-in function?

The break-in function toggles transmit and receive with CW keying. Full break-in (QSK) can monitor the receive signal during keying.



• Turns the speech compressor ON and OFF in SSB and AM modes. (p. 34)



• Enters memory keyer set mode in CW mode. (pgs. 35, 36)



• Turns the 1/4 function ON and OFF in RTTY mode. (p. 24)
 - 1/4 function sets dial rotation to 1/4 of normal for fine tuning.

✓ **What is the speech compressor?**

The speech compressor compresses the transmitter audio input to increase the average audio output level. Therefore, talk power is increased. This function is effective for long distance communication or when propagation conditions are poor.

19 ELECTRONIC CW KEYSER SPEED CONTROL [KEY SPEED] (p. 35)

Adjusts the internal electronic CW keyer's speed.
 - 7 wpm (min.) to 56 wpm (max.) can be set.



20 SEMI BREAK-IN DELAY CONTROL [BK-IN DELAY]

Adjusts the transmit-to-receive switching delay time for CW semi break-in operation.



21 MODE SWITCHES

Selects the desired mode. (p. 25)
 - Announces the selected mode when an optional UT-102 is installed. (pgs. 59, 61)



• Selects SSB and SSB narrow (USB-N, LSB-N) mode alternately.
 • Toggles USB and LSB mode when pushed for 2 sec.



• Selects CW and CW narrow (CW-N) mode alternately.
 • Toggles CW and CW-R (CW reverse) mode when pushed for 2 sec.



• Selects RTTY and RTTY narrow (RTTY-N) mode alternately.
 • Toggles RTTY and RTTY-R (RTTY reverse) mode when pushed for 2 sec.



• Selects AM and AM narrow (AM-N) mode alternately.



• Selects FM and FM narrow (FM-N) mode alternately.
 • Toggles the subaudible tone encoder ON and OFF in FM mode when pushed for 2 sec. (pgs. 38, 57)

22 LCD FUNCTION SWITCHES [F-1]–[F-5]

Push to select the function indicated in the LCD display above these switches.
 - Functions vary depending on the operating condition.

23 SPEECH SWITCH [SPEECH] (pgs. 59, 61)

Announces the selected readout frequency when an optional UT-102 is installed.

24 TUNING DIAL (p. 23)

Changes the displayed frequency, selects set mode items, etc.

25 MAIN/SUB SWITCH [MAIN/SUB]

Selects the main or sub readout for access.
 - The sub readout frequency is displayed in outline and functions only during split operation or dualwatch.

26 VFO/MEMORY SWITCH [VFO/MEMO]

• Toggles the selected readout operating mode between the VFO mode and memory mode when pushed. (pgs. 22, 41)
 • Transfers the memory contents to VFO when pushed for 2 sec. (p. 44)

27 MAIN/SUB CHANGE SWITCH [CHANGE]

• Toggles the frequency and selected memory channel between main and sub readouts when pushed.
 - Toggles between transmit frequency and receive frequency when the split frequency function is ON. (p. 31)
 • Equalizes the sub readout frequency to the main readout frequency when pushed for 2 sec.

28 DUALWATCH SWITCH [DUALWATCH] (p. 30)

• Turns the dualwatch function ON and OFF when pushed.
 • Turns the dualwatch function ON and equalizes the sub readout frequency to the main readout when pushed for 2 sec. (Quick dualwatch function)
 - The quick dualwatch function can be turned OFF using set mode. (p. 56)

29 SPLIT SWITCH [SPLIT] (p. 31)

• Turns the split function ON and OFF when pushed.
 • Turns the split function ON, equalizes the sub readout frequency to the main readout and sets the sub readout for frequency input when pushed for 2 sec. in non-FM modes. (Quick split function)
 - The offset frequency is shifted from the main readout frequency in FM mode. (pgs. 38, 57)
 • Turns the split function ON and shifts the sub readout frequency after inputting an offset (± 1 MHz in 1 kHz steps).

1 PANEL DESCRIPTION

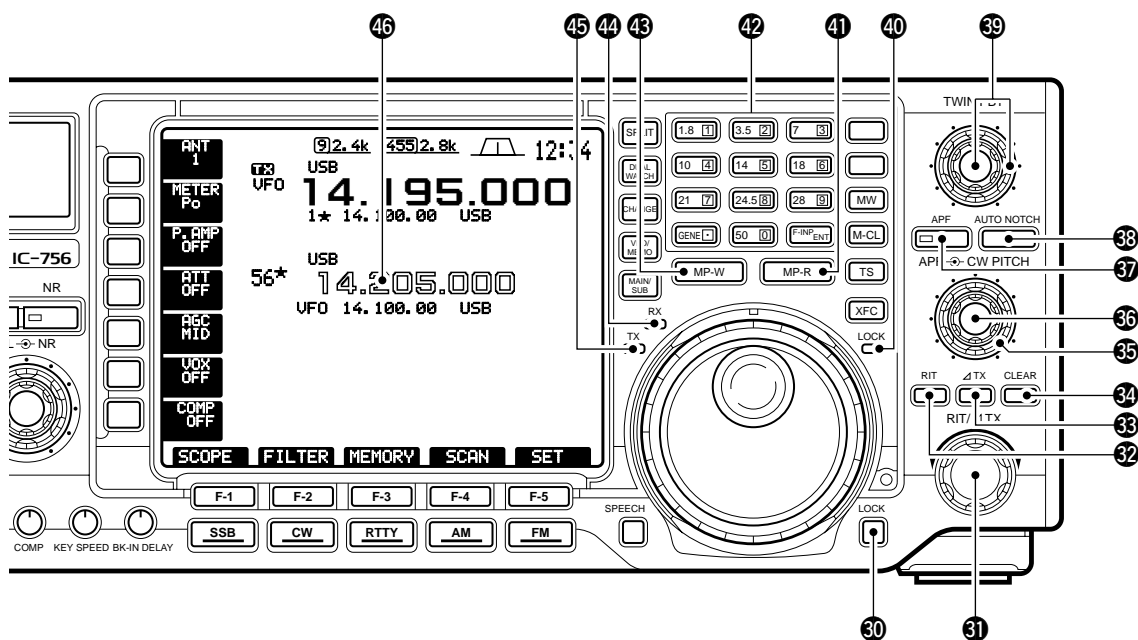

30 LOCK SWITCH [LOCK] (p. 38)

Turns the dial lock function ON and OFF.

31 RIT/ΔTX CONTROL [RIT/ΔTX] (p. 29)

Shifts the receive and/or transmit frequency without changing the transmit and/or receive frequency while the RIT and/or ΔTX functions are ON.

- Rotate the control clockwise to increase the frequency, or rotate the control counterclockwise to decrease the frequency.
- The shift frequency range is ± 9.999 kHz in 1 Hz steps (or ± 9.99 kHz in 10 Hz steps).



32 RIT SWITCH [RIT] (p. 29)

- Turns the RIT function ON and OFF when pushed.
- Use the [RIT/ΔTX] control to vary the RIT frequency.
- Adds the RIT shift frequency to the operating frequency when pushed for 2 sec.

✓ What is the RIT function?

The RIT (Receiver Incremental Tuning) shifts the receive frequency without shifting the transmit frequency.

This is useful for fine tuning stations calling you on an off-frequency or when you prefer to listen to slightly different-sounding voice characteristics, etc.

33 ΔTX SWITCH [ΔTX] (p. 29)

- Turns the ΔTX function ON and OFF when pushed.
- Use the [RIT/ΔTX] control to vary the ΔTX frequency.
- Adds the ΔTX shift frequency to the operating frequency when pushed for 2 sec.

✓ What is the ΔTX function?

The ΔTX shifts the transmit frequency without shifting the receive frequency. This is useful for simple split frequency operation in CW, etc.

34 CLEAR SWITCH [CLEAR] (p. 29)

Clears the RIT/ΔTX shift frequency when pushed for 2 sec.

35 CW PITCH CONTROL [CW PITCH]

(outer control; p. 27)
Shifts the received CW audio pitch and monitored CW audio pitch without changing the operating frequency.

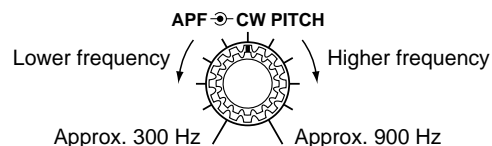

36 AUDIO PEAK FILTER CONTROL [APF]

(inner control; p. 27)

Varies the peak frequency of the audio peak filter to pick out a CW signal from interference while the APF function is ON.

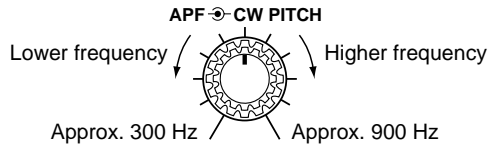

37 AUDIO PEAK FILTER SWITCH [APF] (p. 27)

- Turns the audio peak filter ON and OFF when pushed.
- The APF indicator appears in the LCD.
- The audio peak filter functions in CW only.
- Toggles the bandwidth of the audio peak filter between 320, 160 or 80 Hz when pushed for 2 sec.
- Use the [APF] control to vary the peak frequency.



38 AUTO NOTCH SWITCH [AUTO NOTCH] (p. 26)

Turns the auto notch function ON and OFF.

- The auto notch functions in SSB only.

✓ What is the notch function?

The notch function eliminates unwanted CW or AM carrier tones while preserving the desired signal's audio response. The filtering frequency is adjusted to effectively eliminate unwanted tones via the DSP circuit.



39 PASSBAND TUNING CONTROLS [TWIN PBT]

Adjust the receiver's "passband width" of the 455 kHz and 9 kHz IF filters for the inner and outer controls, respectively. (p. 25)

- Passband width and center frequency are displayed in the LCD.
- Set to the center positions when not in use.
- Variable range depends on the filter selection. ± 1.29 kHz in 15 Hz steps and ± 258 kHz in 3 Hz steps are available.

✓ What is the PBT control?

The PBT function electronically narrows the IF passband width to reject interference. The PBT is especially effective in SSB operation and is not available in FM operation.

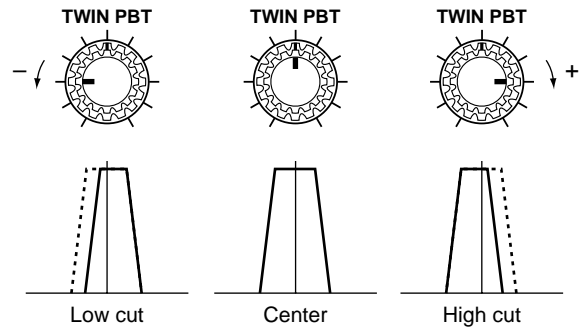
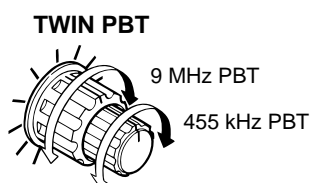

40 LOCK INDICATOR [LOCK] (p. 38)

Lights when the dial lock function is activated.

41 MEMO PAD-READ SWITCH [MP-R] (p. 46)

Each push calls up a frequency and operating mode in a memo pad. The 5 (or 10) most recently programmed frequencies and operating modes can be recalled, starting from the most recent.

- The memo pad capacity can be expanded from 5 to 10 in set mode for your convenience. (p. 59)

42 KEYPAD

- Pushing a key selects the operating band.
- [GENE] selects the general coverage band.
- Pushing the same key 2 or 3 times calls up other stacked frequencies in the band. (p. 23)
- Icom's triple band stacking register memorizes 3 frequencies in each band.
- After pushing [F-INP•ENT], enters a keyed frequency or memory channel. Pushing [F-INP•ENT] or [▲]/[▼] is necessary at the end. (pgs. 23, 41)
- e.g. to enter 14.195 MHz, push [F-INP•ENT] [1] [4] [•] [1] [9] [5] [F-INP•ENT].

43 MEMO PAD-WRITE SWITCH [MP-W] (p. 46)

Programs the selected readout frequency and operating mode into a memo pad.

- The 5 most recent entries remain in memo pads.
- The transmit frequency is programmed when pushed together with [XFC].
- The memo pad capacity can be expanded from 5 to 10 in set mode for your convenience. (p. 59)

44 RECEIVE INDICATOR [RX]

Lights green while receiving a signal and when the squelch is open.

45 TRANSMIT INDICATOR [TX]

Lights red while transmitting.

46 LCD FUNCTION DISPLAY (See p. 9 for details.)

Shows the operating frequency, function switch menus, spectrum screen, memory channel screen, set mode settings, etc.

1 PANEL DESCRIPTION

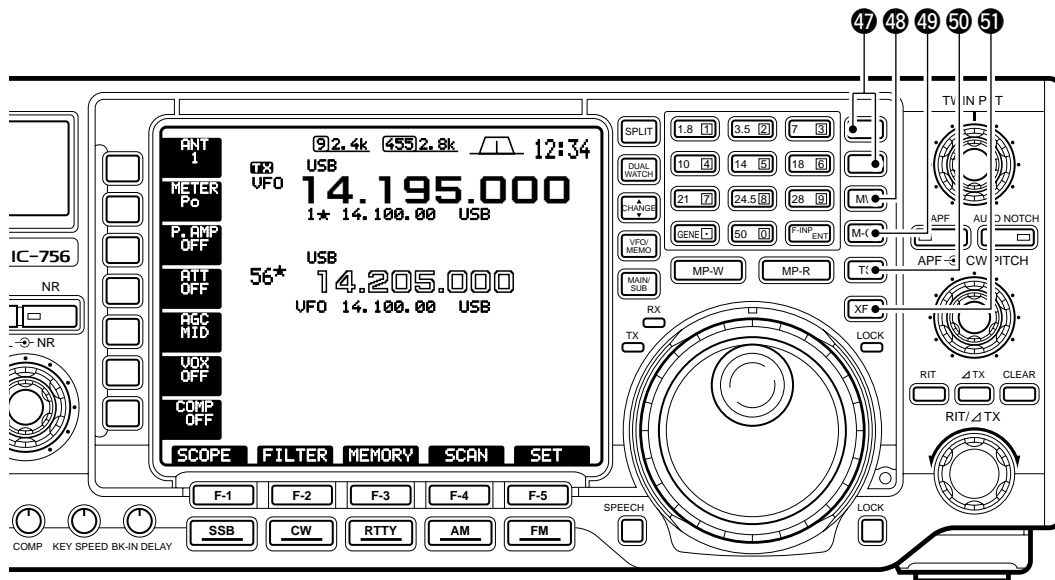

- 47 MEMORY UP/DOWN SWITCHES [▲]/[▼]** (p. 41)
- Select the memory channel number for the selected readout.
 - Memory channels can be selected both in VFO and memory modes.
 - Select the desired memory channel directly after pushing [F-INP] and a memory channel number.

- 48 MEMORY WRITE SWITCH [MW]** (p. 43)
- Stores the selected readout frequency and operating mode into the displayed memory channel when pushed for 2 sec.
- This function is available both in VFO and memory modes.

- 49 MEMORY CLEAR SWITCH [M-CL]** (p. 45)
- Clears the selected readout memory channel contents when pushed for 2 sec. in memory mode.
- The channel becomes a blank channel.
 - This switch does not function in VFO mode.

- 50 QUICK TUNING SWITCH [TS]** (p. 24)
- Turns the quick tuning step ON and OFF.
 - While the quick tuning indicator is displayed, the frequency can be changed in programmed kHz steps.
 - 1, 5, 9 and 10 kHz quick tuning steps are available.

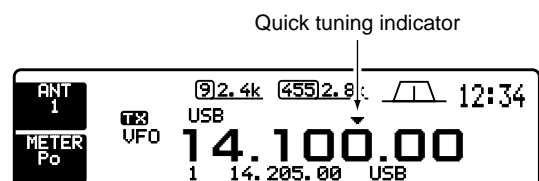

- While the quick tuning step is OFF, turns the 1 Hz step ON and OFF when pushed for 2 sec.
 - 1 Hz indications appear in both readouts and the frequency can be changed in 1 Hz steps.
- While the quick tuning step is ON, enters the quick tuning step set mode when pushed for 2 sec.

- 51 TRANSMIT FREQUENCY CHECK SWITCH [XFC]**
- Monitors the transmit frequency when pushed and held when the split frequency function is ON.
- While pushing this switch, the transmit frequency can be changed with the tuning dial, keypad, memo pad or the [▲]/[▼] switches.
 - When the split lock function is turned ON, pushing [XFC] cancels the dial lock function. (p. 57)

■ Microphone (HM-36)

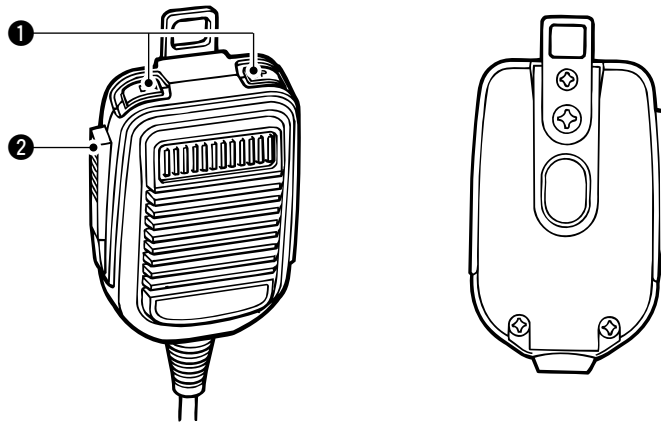

❶ UP/DOWN SWITCHES [UP]/[DN]

Change the selected readout frequency or memory channel.

- Continuous pushing changes the frequency or memory channel number continuously.
- While pushing [XFC], the transmit readout frequency can be controlled while in split frequency operation.
- The [UP]/[DN] switch can simulate a key paddle. Preset in the keyer set mode. (p. 35)

❷ PTT SWITCH

Push and hold to transmit; release to receive.

• MICROPHONE CONNECTOR

(Front panel view)

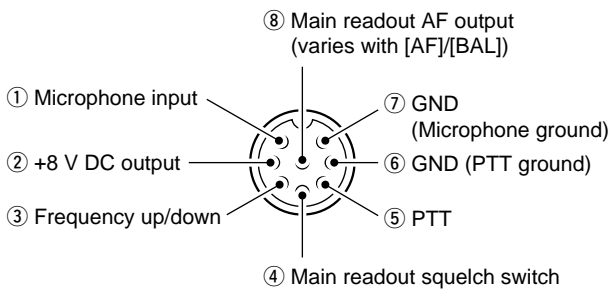

| PIN NO. | FUNCTION | DESCRIPTION |
|---------|----------------|----------------------|
| ❷ | +8 V DC output | Max. 10 mA |
| ❸ | Frequency up | Ground |
| | Frequency down | Ground through 470 Ω |
| ❹ | Squelch open | "LOW" level |
| | Squelch closed | "HIGH" level |

CAUTION: DO NOT short pin 2 to ground as this can damage the internal 8 V regulator.

• HM-36 SCHEMATIC DIAGRAM

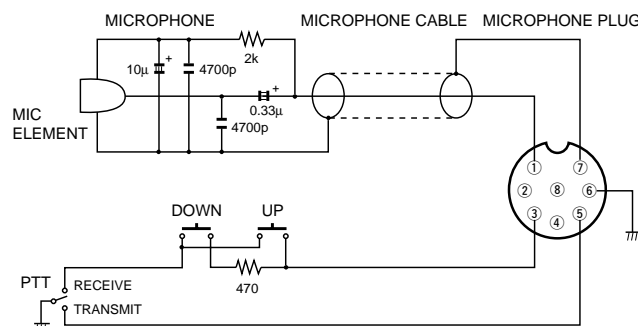

■ LCD display

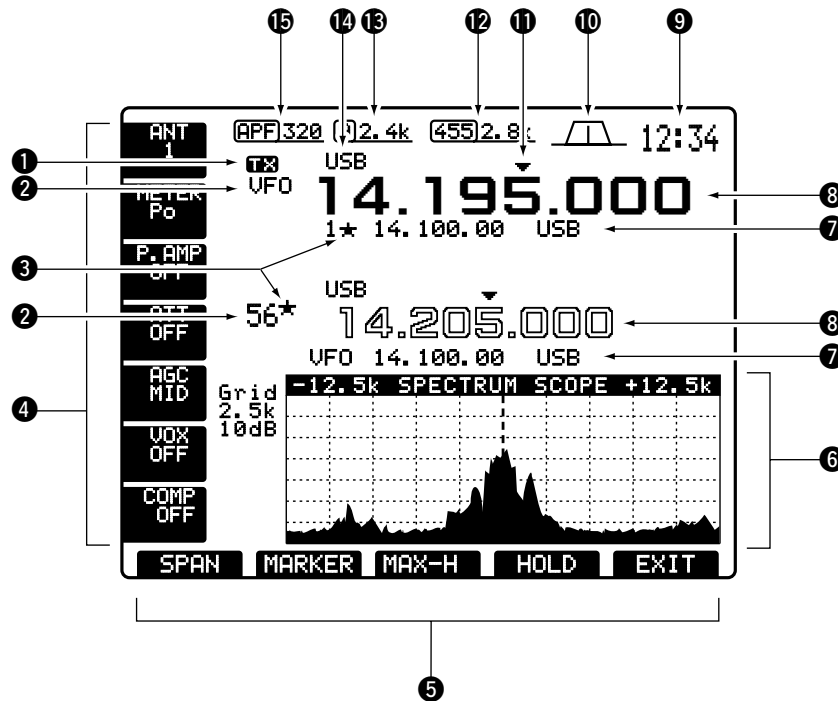

1 TX INDICATOR

Indicates the frequency readout for transmit.

2 VFO/MEMORY CHANNEL INDICATOR

(pgs. 22, 41)
Indicates the VFO mode or selected memory channel number.

3 SELECT MEMORY CHANNEL INDICATOR

(p. 50)
Indicates the displayed memory channel is set as a select memory channel.

4 MULTI-FUNCTION SWITCH GUIDE

Indicates the function of the multi-function switches.

5 LCD FUNCTION SWITCH GUIDE

Indicates the function of the LCD function switches ([F-1] – [F-5]).

6 MULTI-FUNCTION SCREEN (p. 10)

Shows the screens for the spectrum scope, IF filter selection, memory channel, scan or set modes.

7 MEMORY CHANNEL READOUTS (p. 41)

- Show the selected memory channel contents in VFO mode.
- Show the VFO contents in memory mode.

8 FREQUENCY READOUTS (p. 23)

Show the operating frequency.
- Outline characters are used for non-accessing readout.

9 CLOCK READOUT (p. 51)

Shows the current time.

10 TWIN PBT INDICATOR (p. 25)

Graphically displays the passband width for twin PBT operation and center frequency for IF shift operation.

11 QUICK TUNING INDICATOR (p. 24)

Appears when the quick tuning step function is in use.

12 455 kHz IF FILTER INDICATOR (p. 28)

Shows the 455 kHz IF filter selection using passband width.

13 9 MHz IF FILTER INDICATOR (p. 28)

Shows the 9 MHz IF filter selection using passband width.

14 MODE INDICATOR (p. 25)

Shows the selected mode.

15 APF FREQUENCY INDICATOR (p. 27)

Appears when the audio peak filter is turned ON and shows the boost frequency width of the audio peak filter.

■ Screen menu arrangement

The following screens can be selected from the start up screen. Choose the desired screen using the following chart.

Pushing [(F-5)EXIT] one or more times returns to the start up screen. See p. 53 for set mode arrangement.

•Start up screen

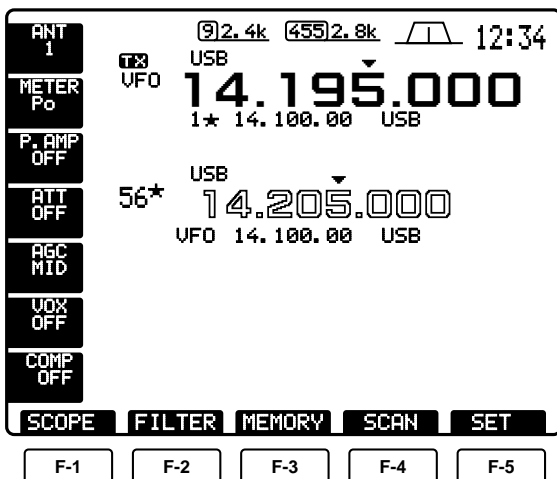

•Spectrum scope screen (p. 37)

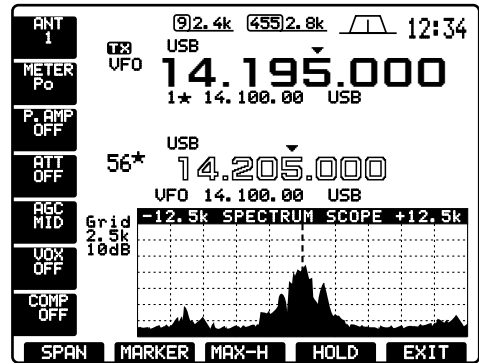

•Filter selection screen (p. 28)

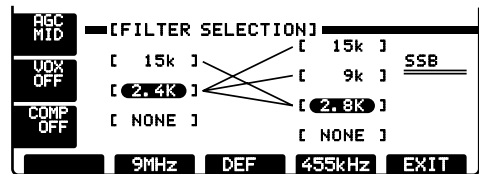

•Memory channel screen (p. 42)

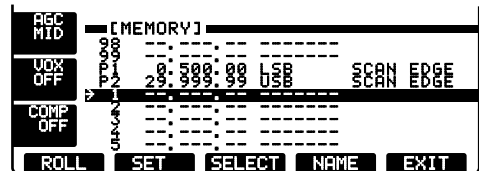

•Scan screen (p. 47)



•Set mode screen (p. 53)



■ Rear panel

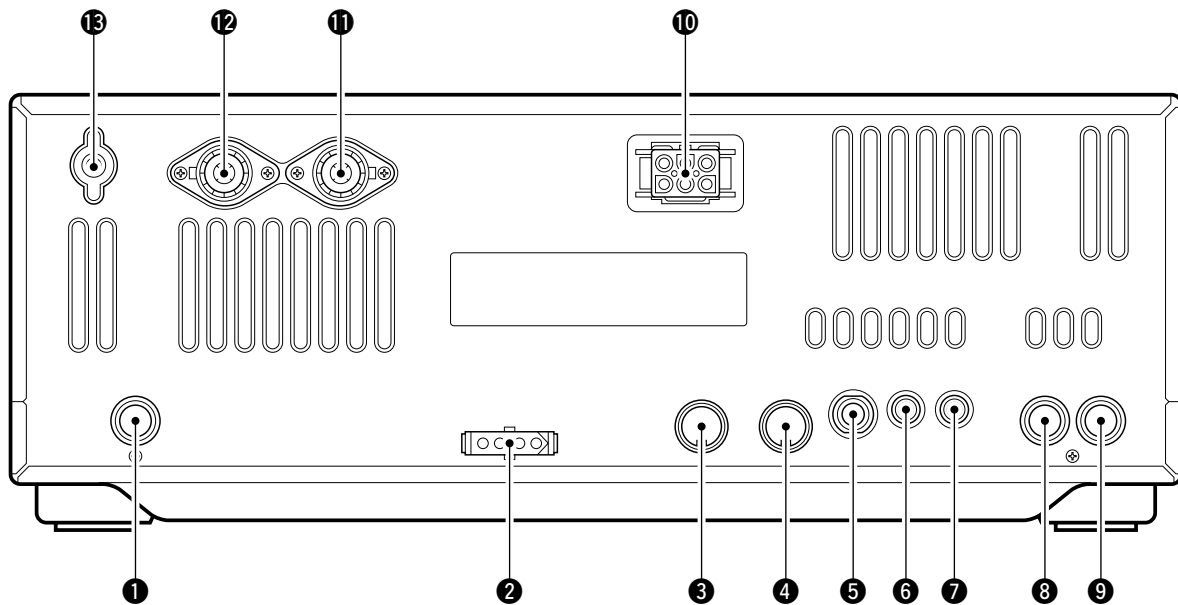

1 RECEIVE ANTENNA CONNECTOR [RX ANT]

(p. 15)

Connects a 50 Ω general coverage antenna with an RCA connector.

2 TUNER CONTROL SOCKET [TUNER] (p. 15)

Accepts the control cable from an optional AH-3 HF AUTOMATIC ANTENNA TUNER.

3 ACCESSORY SOCKET 1 [ACC(1)]

4 ACCESSORY SOCKET 2 [ACC(2)]

Enable connection to external equipment such as a linear amplifier, an automatic antenna selector/tuner, TNC for data communications, etc.

- See the page at right for socket information.

5 STRAIGHT KEY JACK [KEY] (p. 14)

Accepts a straight key or external electronic keyer with 1/4 inch standard plug.

- [ELEC-KEY] on the front panel can be used for a straight key or external electronic keyer. Deactivate the internal electronic keyer in keyer set mode. (p. 35)

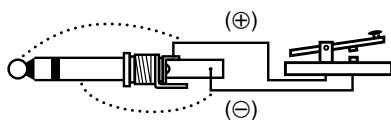

NOTE: If you use an external electronic keyer, make sure the voltage retained by the keyer is less than 0.4 V when the key is ON.

6 CI-V REMOTE CONTROL JACK [REMOTE]

(p. 20)

- Designed for use with a personal computer for remote control of transceiver functions.
- Used for transceive operation with another Icom CI-V transceiver or receiver.

7 EXTERNAL SPEAKER JACK [EXT SP]

(pgs. 15, 68)

Accepts an 4–8 Ω speaker.

8 ALC INPUT JACK [ALC] (p. 17)

Connects to the ALC output jack of a non-Icom linear amplifier.

9 SEND CONTROL JACK [SEND] (p. 17)

Goes to ground while transmitting to control external equipment such as a linear amplifier.

- Max. control level: 16 V DC/2 A

10 DC POWER SOCKET [DC 13.8V] (p. 14)

Accepts 13.8 V DC through the supplied DC power cable (OPC-025A).

Rear panel view

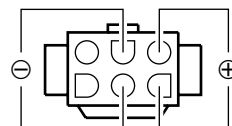



- ❶ **ANTENNA CONNECTOR 1 [ANT1]**
- ❷ **ANTENNA CONNECTOR 2 [ANT2]** (pgs. 13, 14)
Accept a 50 Ω antenna with a PL-259 connector.

- ❸ **GROUND TERMINAL [GND]** (pgs. 13, 14)
Connect this terminal to a ground to prevent electrical shocks, TVI, BCI and other problems.

NOTE: When using an optional AH-3 HF AUTOMATIC ANTENNA TUNER, connect it to the [ANT1] connector. The internal antenna tuner activates for [ANT2] and deactivates for [ANT1] when connecting the AH-3.

◇ **ACC SOCKETS**

| ACC(1) | PIN NO. | PIN NAME | DESCRIPTION | SPECIFICATIONS |
|---|---------|----------|---|---|
|  Rear panel view | 1 | RTTY | Controls RTTY keying. | "HIGH" level : More than 2.4 V "LOW" level : Less than 0.6 V Output current : Less than 2 mA |
| | 2 | GND | Connects to ground. | Connected in parallel with ACC(2) pin 2. |
| | 3 | SEND | Input/output pin. Goes to ground when transmitting. When grounded, transmits. | Ground level : -0.5 V to 0.8 V Output current : Less than 20 mA Input current (Tx) : Less than 200 mA Connected in parallel with ACC(2) pin 3. |
| | 4 | MOD | Modulator input. Connects to a modulator. | Input impedance : 10 kΩ Input level : Approx. 100 mV rms |
| | 5 | AF | AF detector output. Fixed, regardless of [AF] position. | Output impedance : 4.7 kΩ Output level : 100 to 300 mV rms |
| | 6 | SQLS | Squelch output. Goes to ground when squelch opens. | Squelch open : Less than 0.3 V/5 mA Squelch closed : More than 6.0 V/100 μA |
| | 7 | 13.8 V | 13.8 V output when power is ON. | Output current : Max. 1 A Connected in parallel with ACC(2) pin 7. |
| | 8 | ALC | ALC voltage input. | Control voltage : -4 to 0 V Input impedance : More than 10 kΩ Connected in parallel with ACC(2) pin 5. |

| ACC(2) | PIN NO. | PIN NAME | DESCRIPTION | SPECIFICATIONS |
|--|---------|----------|--|---|
|  Rear panel view | 1 | 8 V | Regulated 8 V output. | Output voltage : 8 V ±0.3 V Output current : Less than 10 mA |
| | 2 | GND | Same as ACC(1) pin 2. | |
| | 3 | SEND | Same as ACC(1) pin 3. | |
| | 4 | BAND | Band voltage output. (Varies with amateur band) | Output voltage : 0 to 8.0 V |
| | 5 | ALC | Same as ACC(1) pin 8. | |
| | 6 | NC | No connection. | |
| | 7 | 13.8 V | Same as ACC(1) pin 7. | |

■ Unpacking

After unpacking, immediately report any damage to the delivering carrier or dealer. Keep the shipping cartons.

For a description and a diagram of accessory equipment included with the IC-756, see UNPACKING on p. ii of this manual.

■ Selecting a location

Select a location for the transceiver that allows adequate air circulation, free from extreme heat, cold, or vibrations, and away from TV sets, TV antenna elements, radios and other electro-magnetic sources.

OPERATING ANGLE ADJUSTMENT

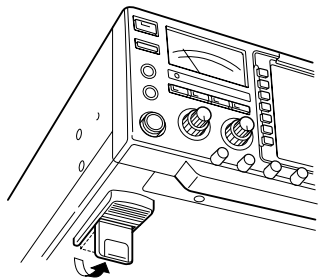

The rubber feet on the bottom of the transceiver provide two operating angles.

■ Grounding

To prevent electrical shock, television interference (TVI), broadcast interference (BCI) and other problems, ground the transceiver through the GROUND terminal on the rear panel.

For best results, connect a heavy gauge wire or strap to a long earth-sunk copper rod. Make the distance between the GROUND terminal and ground as short as possible.

⚠ WARNING: NEVER connect the [GND] terminal to a gas or electric pipe, since the connection could cause an explosion or electric shock.

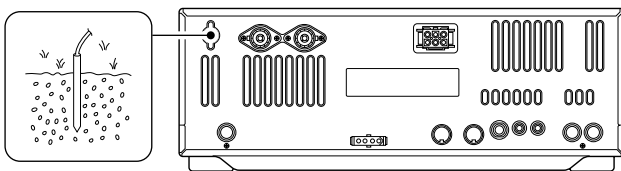

■ Antenna

For radio communications, the antenna is of critical importance, along with output power and sensitivity. Select antenna(s), such as a well-matched 50 Ω antenna, and feedline. 1.5:1 of Voltage Standing Wave Ratio (VSWR) is recommended for a desired band. Of course, the transmission line should be a coaxial cable.

When using 1 antenna, use the [ANT1] connector.

CAUTION: Protect your transceiver from lightning by using a lightning arrestor.

PL-259 CONNECTOR INSTALLATION

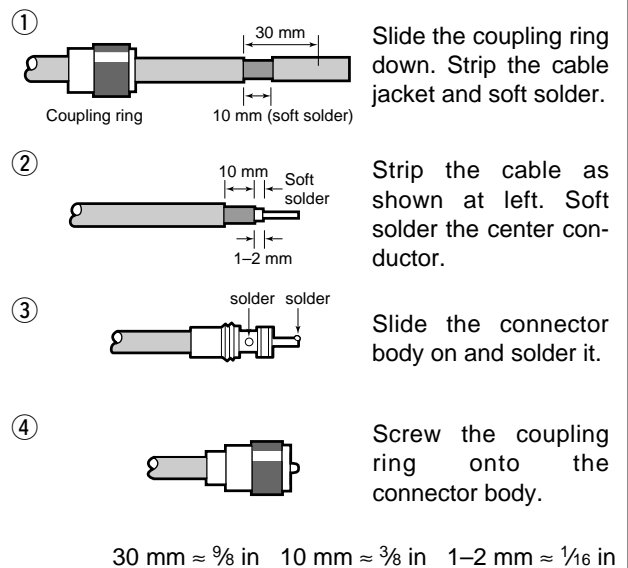

Antenna SWR

Each antenna is tuned for a specified frequency range and SWR may be increased out-of-range. When the SWR is higher than approx. 2.0:1, the transceiver's power drops to protect the final transistor. In this case, an antenna tuner is useful to match the transceiver and antenna. Low SWR allows full power for transmitting even when using the antenna tuner. The IC-756 has an SWR meter to monitor the antenna SWR continuously.

Required connections

Front panel

CW KEY

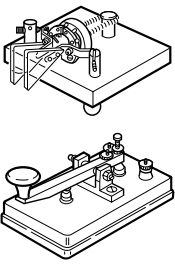

A straight key can be used when the internal electronic keyer is turned OFF in keyer set mode. (p. 35)

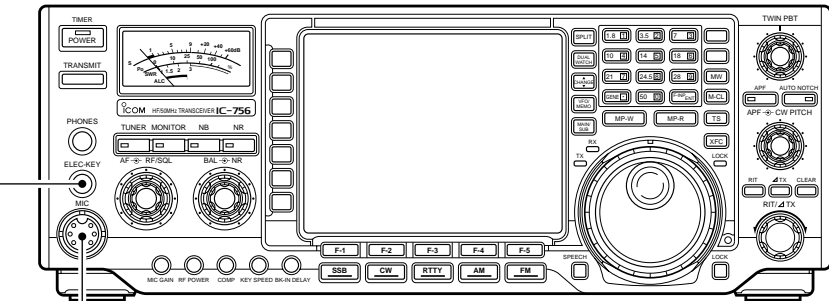

MICROPHONES (p. 68)

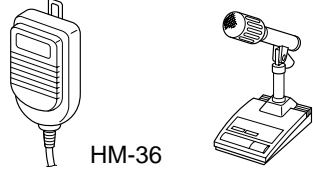

HM-36 SM-20

Rear panel

ANTENNA 1, 2 (p. 13)
 [Example]: ANT1 for 1.8–18 MHz bands
 ANT2 for 21–50 MHz bands

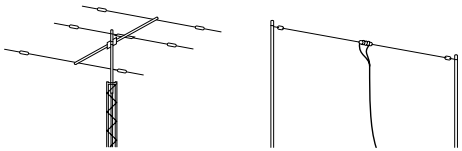

DC POWER SUPPLY

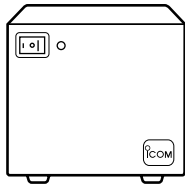

PS-85

GROUND (p. 13)

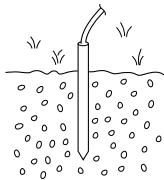

Use the heaviest gauge wire or strap available and make the connection as short as possible.

Grounding prevents electrical shocks, TVI and other problems.

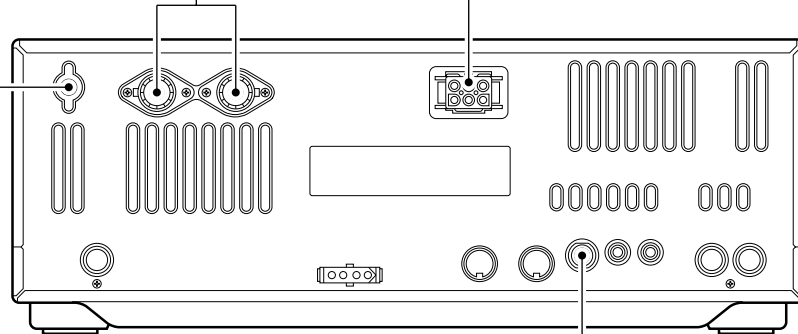

STRAIGHT KEY

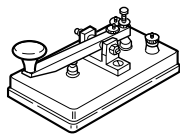

Advanced connections

• Front panel

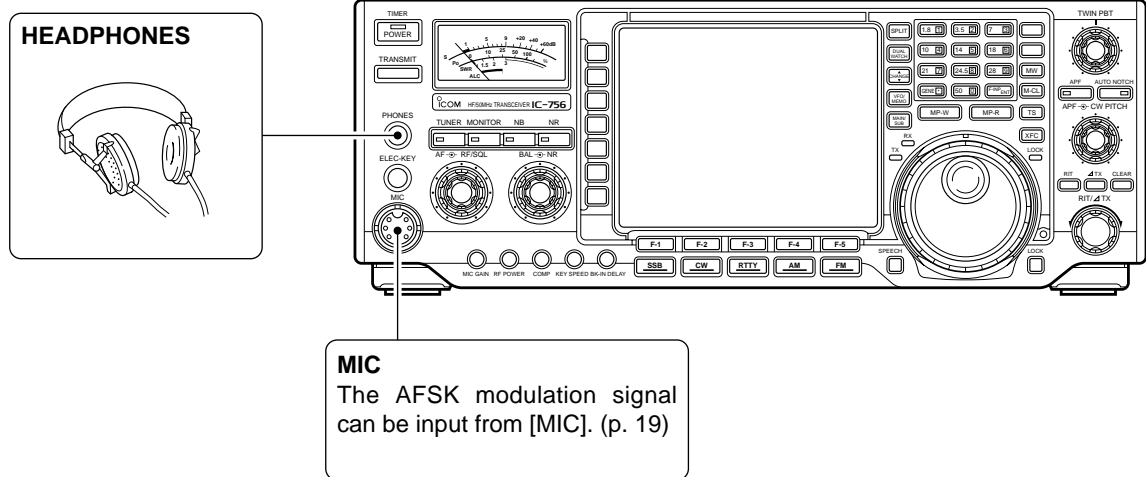

• Rear panel

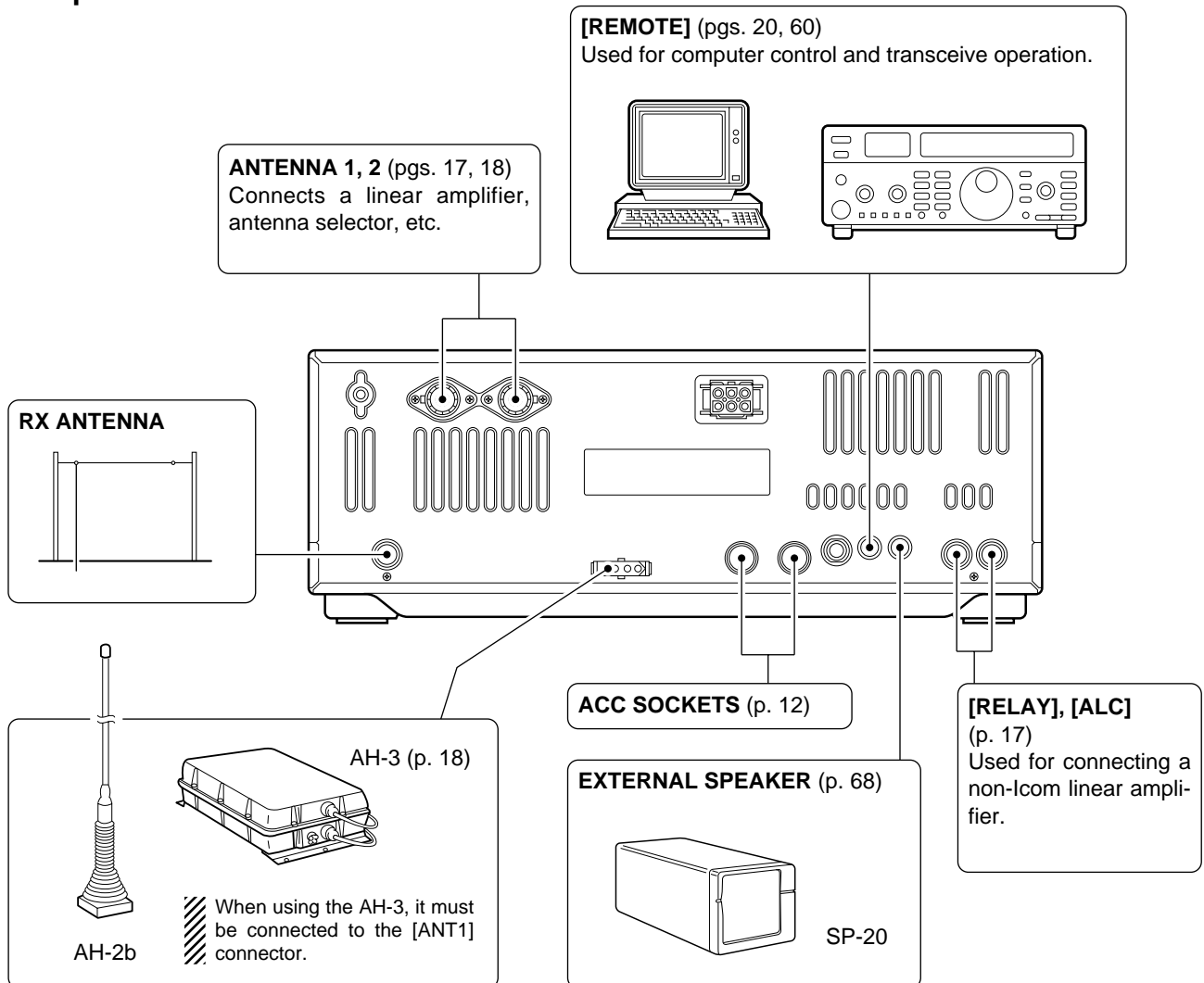

■ Power supply connections

Use an optional PS-85 DC POWER SUPPLY, etc. when operating the transceiver with AC power. Refer to the diagrams below.

CAUTION: Before connecting the DC power cable, check the following important items. Make sure:

- The [POWER] switch is OFF.
 - Output voltage of the power source is 12–15 V when you use a non-Icom power supply.
 - DC power cable polarity is correct.
- Red : positive ⊕ terminal
Black : negative ⊖ terminal

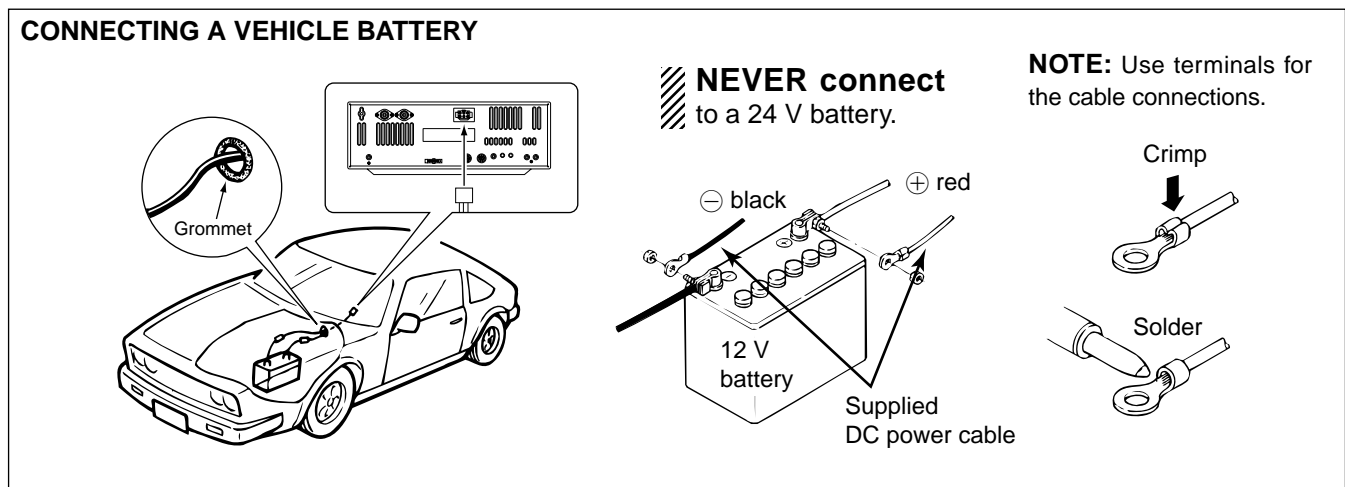
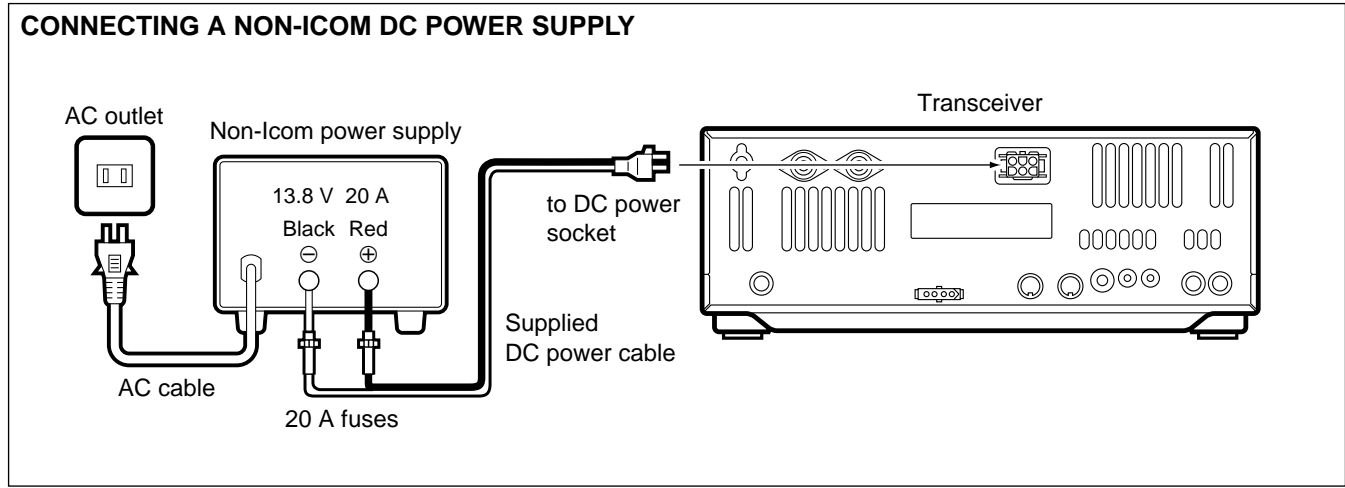
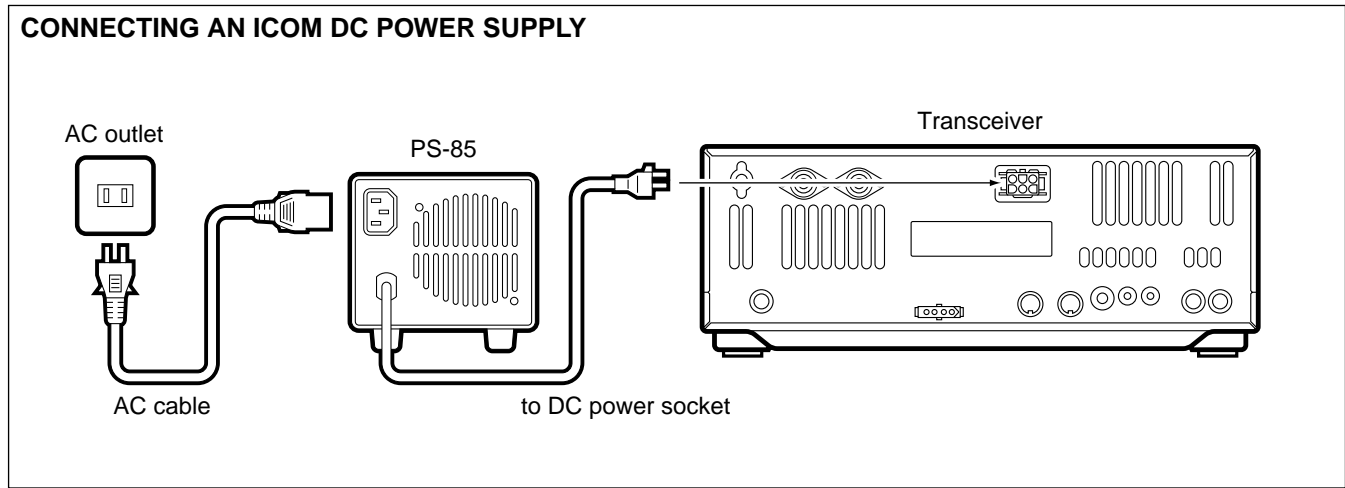

Linear amplifier connections

Use the [ANT1] connector when connecting a linear amplifier.

CONNECTING THE IC-4KL

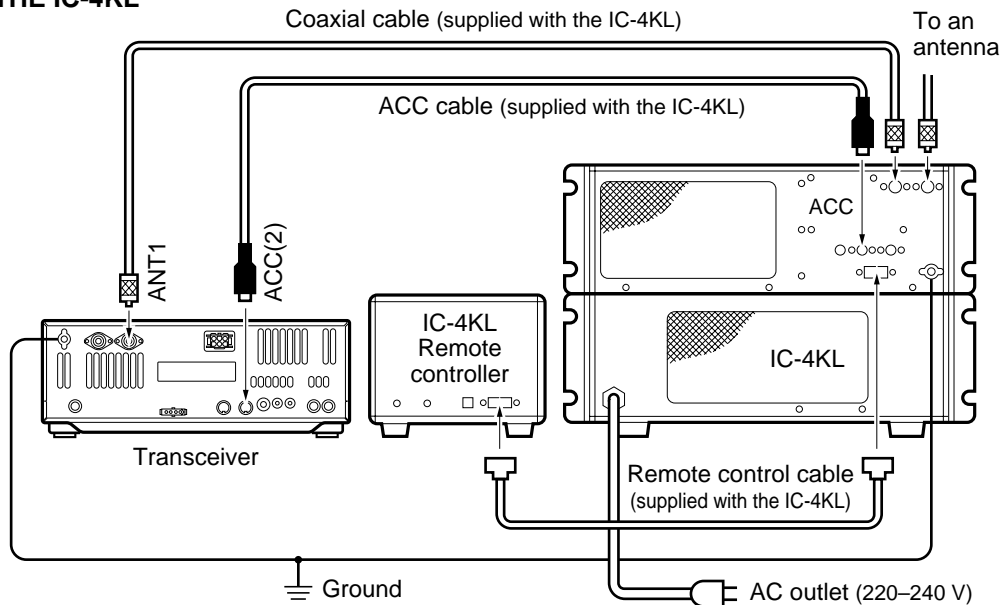

NOTE: Turn OFF the transceiver's antenna tuner while tuning the IC-4KL's tuner.

CONNECTING THE IC-2KL

CAUTION:

Set the transceiver output power for 80 W max. with the [RF POWER] control, otherwise, a protection circuit will activate.

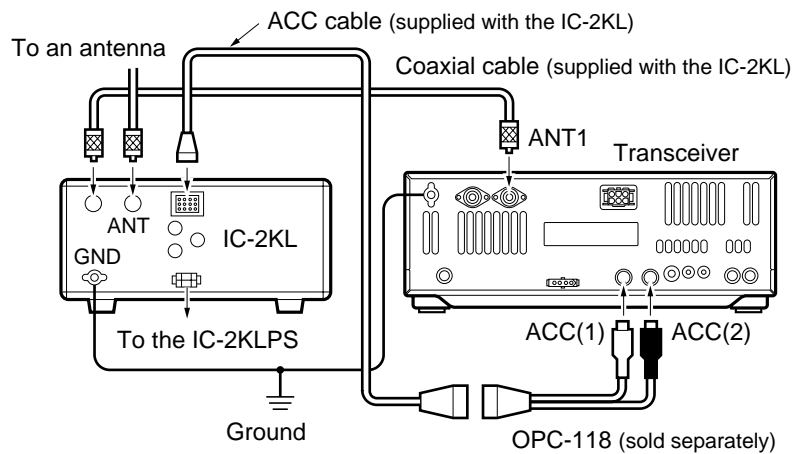

CONNECTING A NON-ICOM POWER AMPLIFIER

WARNING:

Set the transceiver output power and linear amplifier ALC output level referring to the linear amplifier instruction manual.

The ALC input level must be in the range 0 V to -4 V, and the transceiver does not accept positive voltage. Non-matched ALC and RF power settings could cause a fire or ruin the linear amplifier.

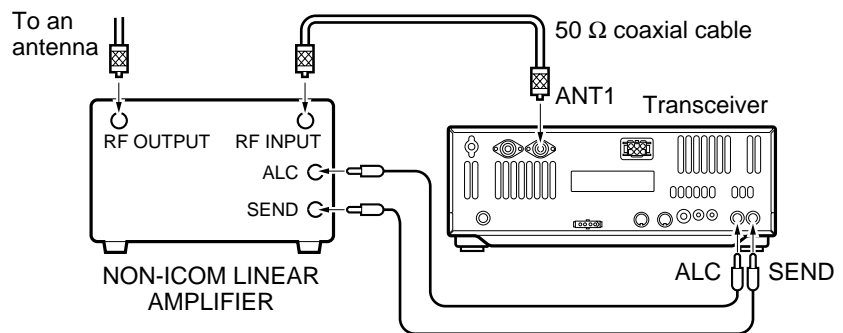

NOTE: The specifications for the SEND relay are 16 V DC 2 A. If this level is exceeded, a large external relay must be used.

External antenna selector or antenna tuner connections

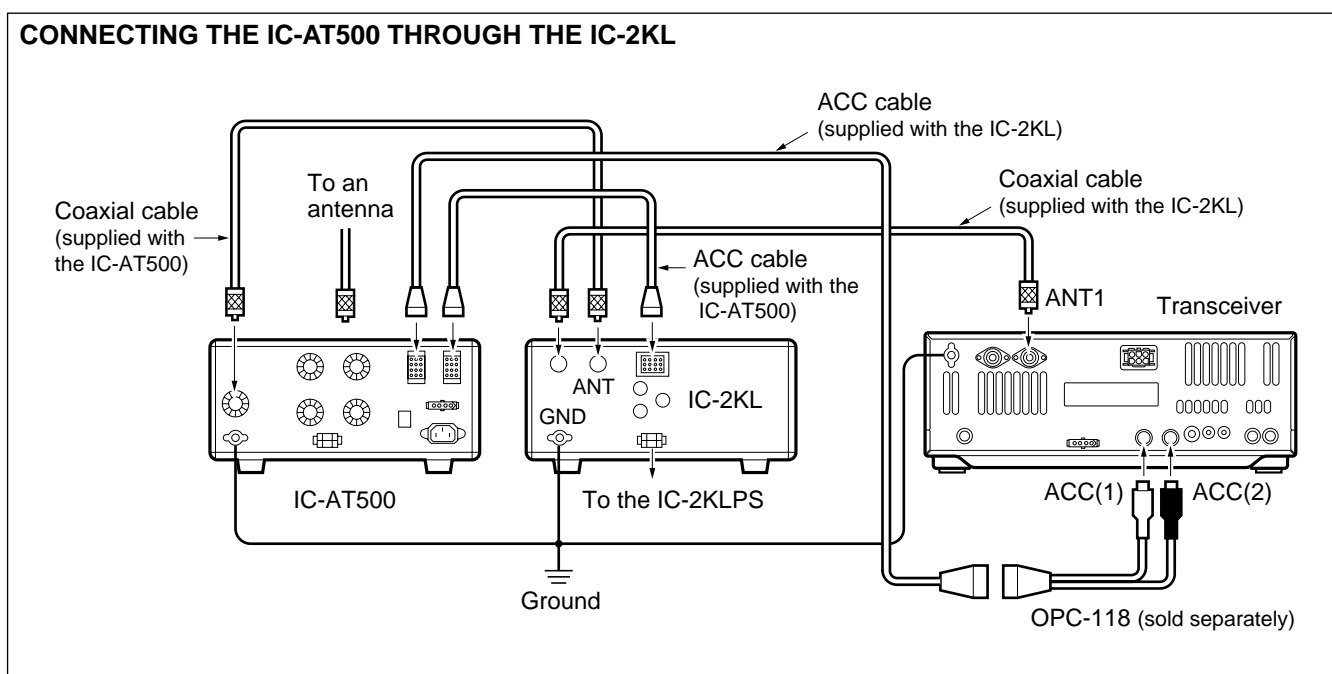
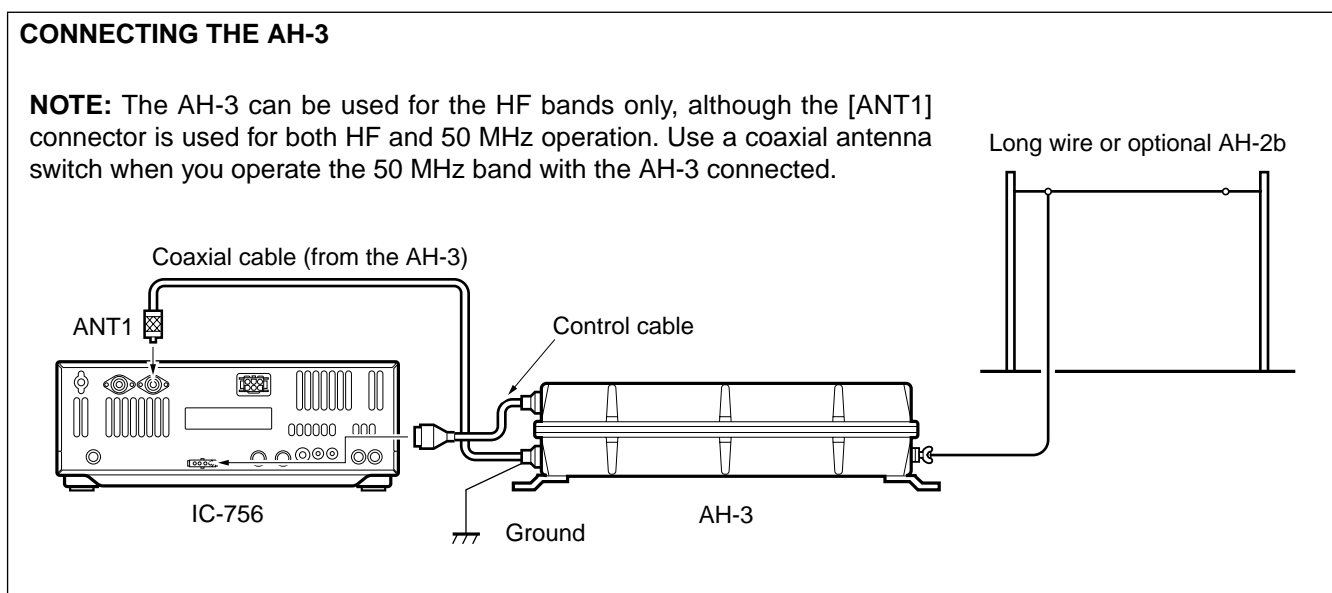
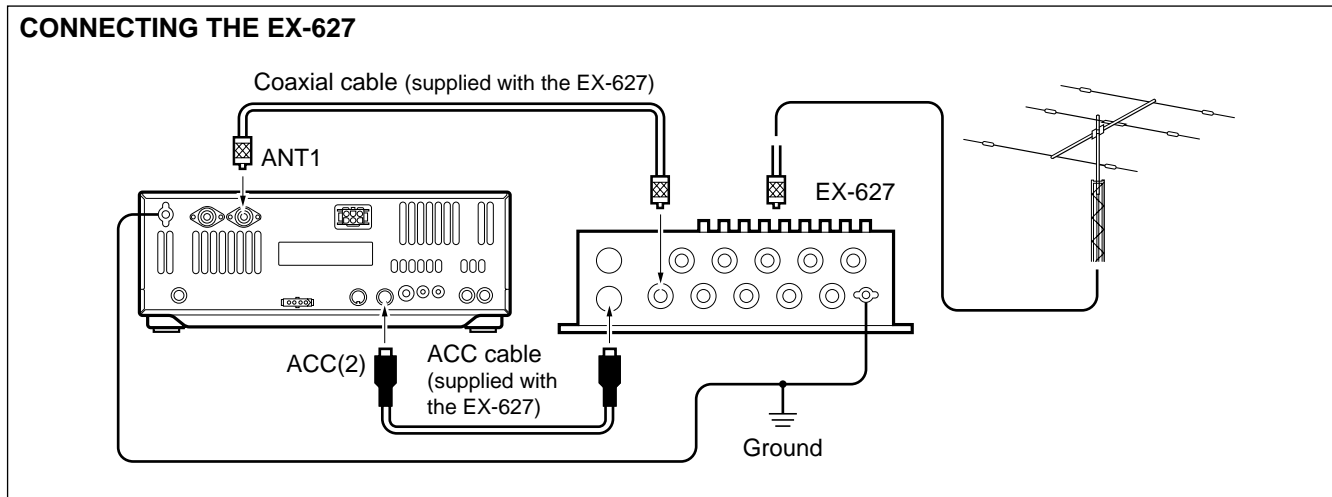

■ FSK and AFSK (SSTV) connections

To connect a terminal unit, TNC or scan converter, refer to the diagram below.

For RTTY operation
 The optional 250 Hz CW narrow filters may not pass RTTY signals. Be sure to select the appropriate IF filters corresponding to the signal width. (p. 28)

FSK (RTTY) connection

Use RTTY mode for operation

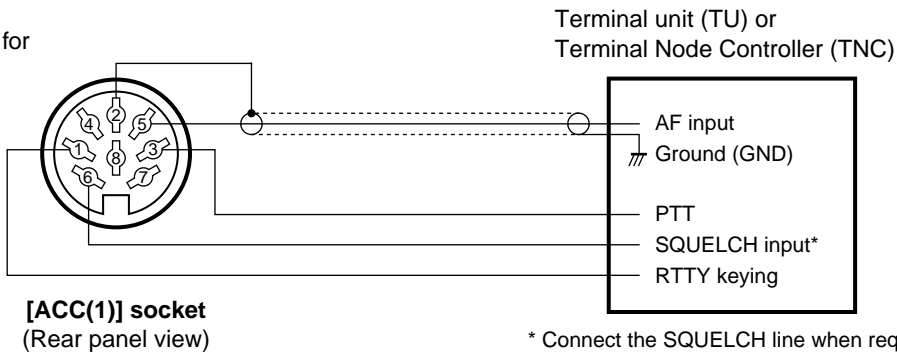

AFSK and SSTV connections

Use SSB or FM mode for operation

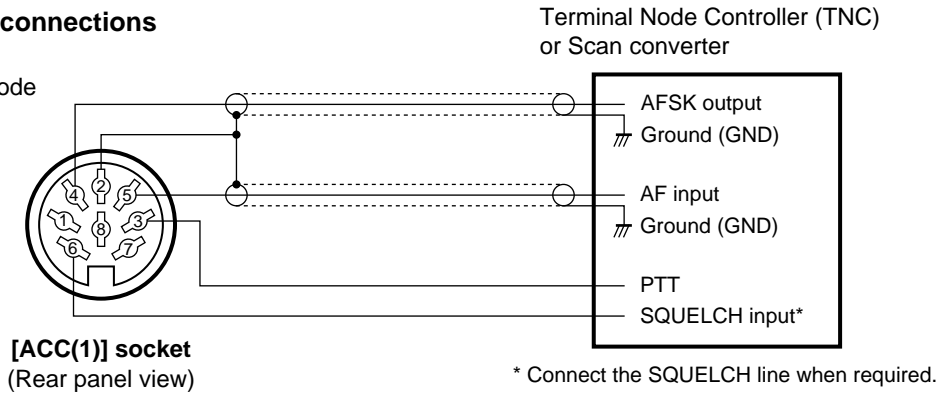

AFSK and SSTV connections via microphone connector

Use SSB or FM mode for operation

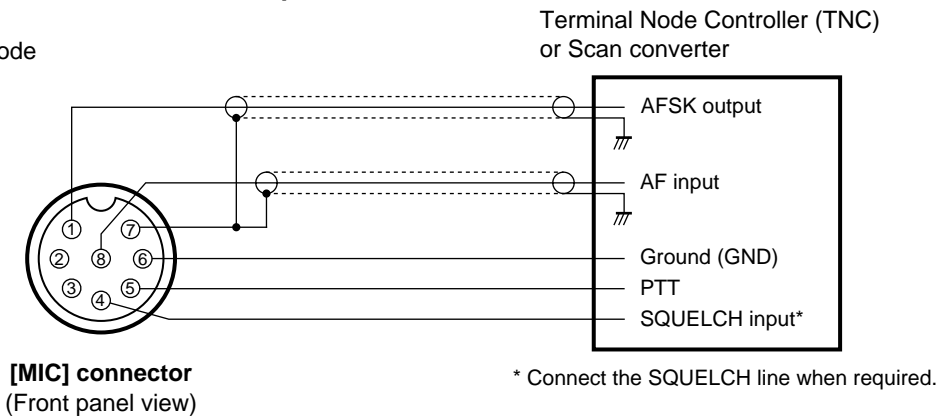

When connected to the [MIC] connector, [MIC GAIN] and [AF] control adjustment is required.

Remote jack (CI-V) information

• CI-V connection example

The transceiver can be connected through an optional CT-17 CI-V LEVEL CONVERTER to a personal computer equipped with an RS-232C port. The Icom Communication Interface-V (CI-V) controls the following functions of the transceiver.

Up to four Icom CI-V transceivers or receivers can be connected to a personal computer equipped with an RS-232C port. See p. 60 for setting the CI-V condition using set mode.

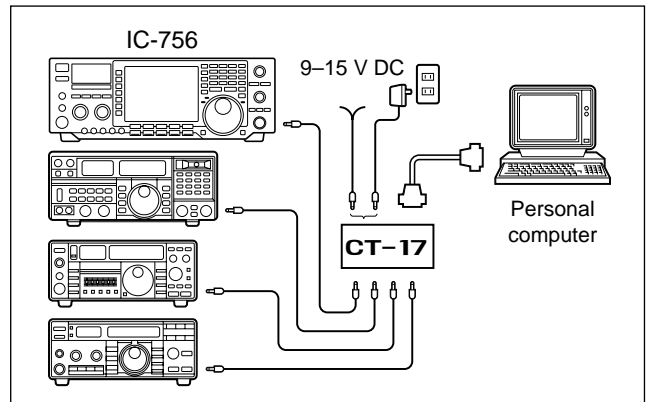

• Data format

The CI-V system can be operated using the following data formats. Data formats differ according to command numbers. A data area or sub command is added for some commands.

CONTROLLER TO IC-756

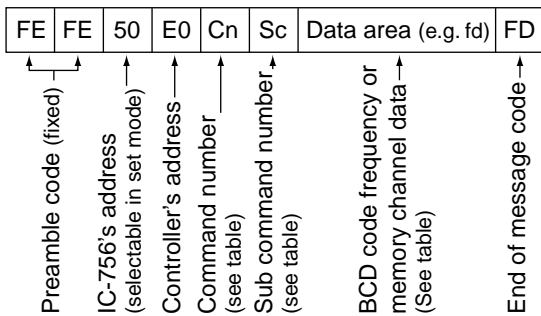

IC-756 TO CONTROLLER

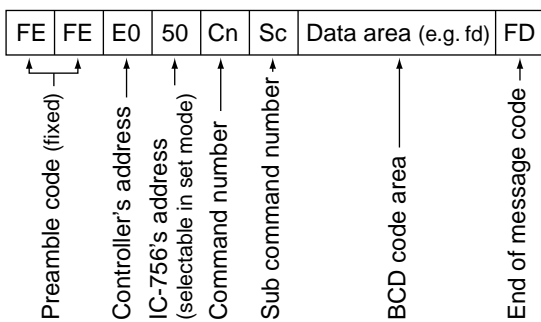

OK or NG MESSAGE TO CONTROLLER

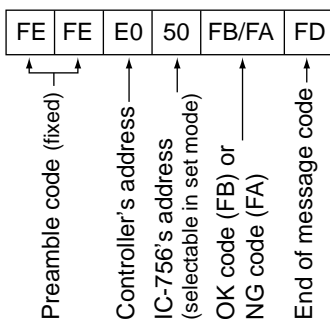

• Command table

| Description | Command | Sub command |
|--|---------|-------------|
| Frequency setting | 05 | Data*1 |
| Operating mode | 06 | 00 |
| | | 01 |
| | | 02 |
| | | 03 |
| | | 04 |
| VFO mode selection MAIN ↔ SUB MAIN = SUB Dualwatch OFF Dualwatch ON Main readout selection Sub readout selection | 07 | 05 |
| | | — |
| | | B0 |
| | | B1 |
| | | C0 |
| Memory mode selection Memory channel selection | 08 | C1 |
| | | D0 |
| Memory write Memory transfer to VFO Memory clear | 09 | D1 |
| | | — |
| | | — |
| Scan stop Start programmed/memory scan Start programmed scan Start ΔF scan Start fine programmed scan Start fine ΔF scan Start memory scan Start select memory scan | 0E | — |
| | | 00 |
| | | 01 |
| | | 02 |
| | | 03 |
| | | 12 |
| | | 13 |
| | | 22 |
| Split OFF Split ON | 0F | 23 |
| | | 00 |
| [TS] OFF (10 or 1 Hz step) [TS] ON (1 kHz step) [TS] ON (5 kHz step) [TS] ON (9 kHz step) [TS] ON (10 kHz step) | 10 | 01 |
| | | 02 |
| | | 03 |
| | | 04 |
| | | 04 |
| [ANT1] selection [ANT2] selection [ANT1/RX] selection [ANT2/RX] selection | 12 | 00 or 0000 |
| | | 01 or 0100 |
| | | 0001 |
| | | 0101 |

*1 Frequency data arrangement (BCD code)
10 Hz, 1 Hz, 1 kHz, 100 Hz, 100 kHz, 10 kHz,
10 MHz, 1 MHz, 1 GHz then 100 MHz

*2 Scan edge channel P1=0100, P2=0101

■ When first applying power (CPU resetting)

Before first applying power, make sure all connections required for your system are complete by referring to chapter 2. Then, reset the transceiver using the following procedure.

NOTE: Resetting CLEARS all programmed contents in memory channels and returns programmed values in set mode to default values.

- ① Make sure the transceiver power is OFF.
- ② While pushing [M-CL] and [F-INP], push [POWER] for 2 sec. to turn power ON.
 - The internal CPU is reset.
 - The transceiver displays its initial VFO frequencies when resetting is complete.

Correct the set mode settings after resetting:
- Optional filter settings (p. 55)

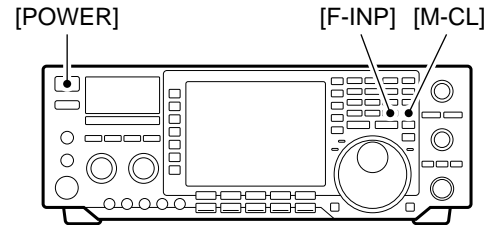

Under cooler temperatures, the LCD may appear dark and unstable after turning power ON. This is normal and does not indicate any equipment malfunction.

■ Initial settings

After resetting the transceiver, set controls and switches as shown in the figure below.

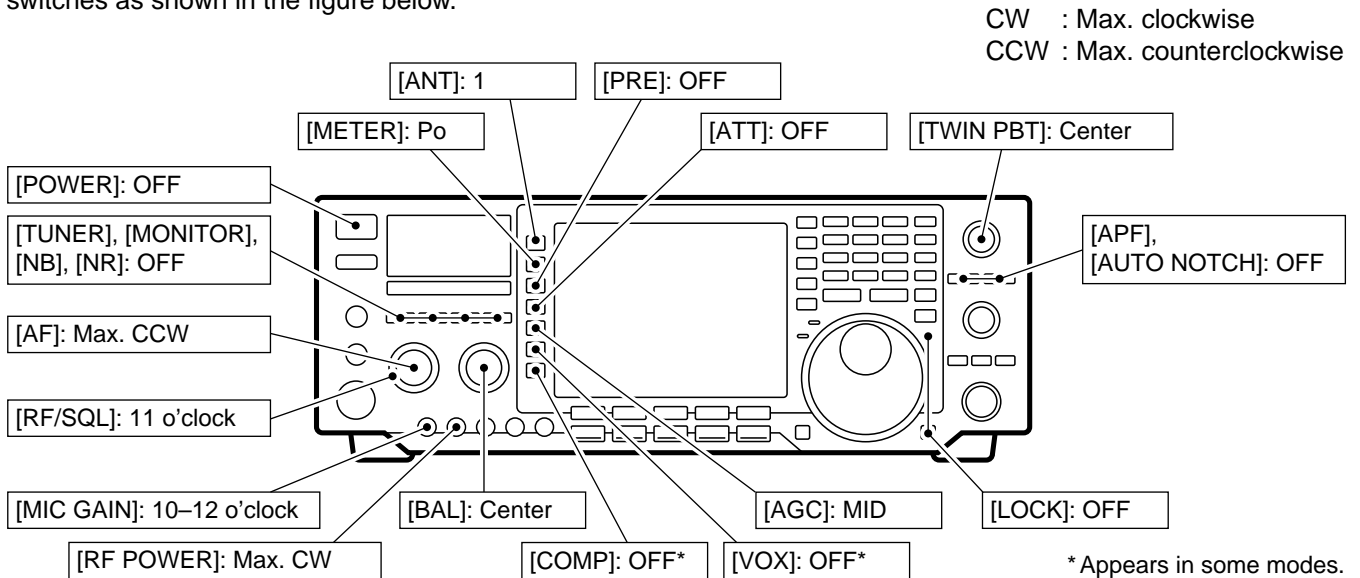

Turn power ON, then check the display. If any of the following indicators appear, turn them OFF as follows:

- Quick tuning step indicator “▼”: Push [TS].
- 1 Hz frequency readout : Push [TS] for 2 sec. (while quick tuning step is OFF)
- RIT indicator “**RIT**” : Push [RIT].
- ΔTX indicator “**ΔTX**” : Push [ΔTX].
- Split indicator “**SPLIT**” : Push [SPLIT].
- Dualwatch indicator “**DUAL-W**” : Push [DUAL WATCH].
- APF indicator “**APF320**”, etc. : Push [APF].

■ VFO description

VFO is an abbreviation of Variable Frequency Oscillator, and traditionally refers to an oscillator.

The transceiver's VFO is somewhat different. The VFO of the IC-756 acts like a computer's window and can show one frequency and one operating mode.

You can call up a desired frequency to the VFO with the keypad, memo pad-read switch (see p. 46) or the memory transfer function (see p. 44). You can also change the frequency with the tuning dial and select the operating mode with the mode switches.

During dualwatch or split frequency operation, the sub VFO is functional (non-outline, larger frequency characters). While pushing [XFC] during split frequency operation, you can change the transmit readout frequency with the keypad, memo pad-read switch or the memory transfer function.

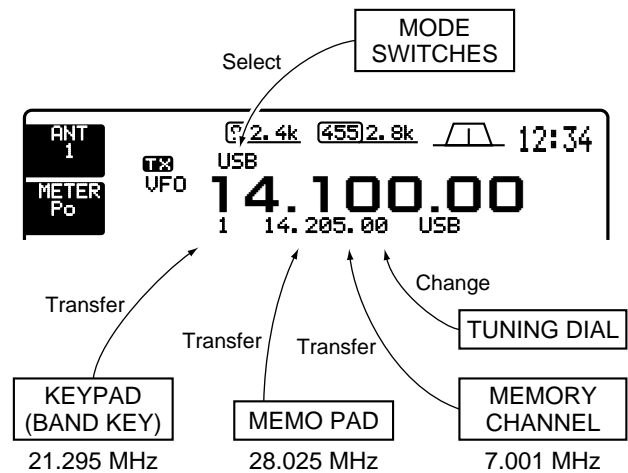

• Differences between VFO mode and memory mode

| VFO MODE | MEMORY MODE (pgs. 41–45) |
|---|--|
| VFO shows a frequency and operating mode. If the frequency or operating mode is changed, the VFO automatically memorizes the new frequency or new operating mode. | Each memory channel shows a frequency and operating mode like a VFO. Even if the frequency or mode is changed, the memory channel does not memorize the new frequency or operating mode. |
| When a VFO is selected from another band or memory mode, the last used frequency and operating mode for that VFO appear. | When the memory channel is selected from another memory channel or VFO mode, the memorized frequency and operating mode appear. |
| [EXAMPLE] VFO is selected. | [EXAMPLE] Memory channel 1 is selected. |
| | |
| The frequency is changed. | The frequency is changed. |
| | |
| Memory mode is selected. | Another memory channel is selected. |
| | |
| VFO is selected again. | Memory channel 1 is selected again. |
| | |
| Changed frequency (14.123 MHz) appears. | Changed frequency (14.123 MHz) does not appear and memorized frequency (14.100 MHz) appears instead. |

Frequency setting with the tuning dial

For ham band use

- Push the desired band key on the keypad 1–3 times.
- 3 different frequencies can be selected on each band with the band key. (See “Triple band stacking register” below.)

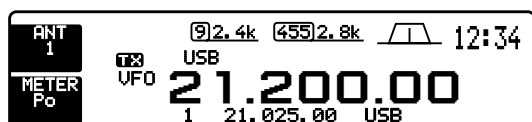

- Rotate the tuning dial to set the desired frequency.

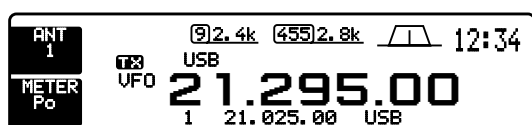

- Select the desired operating mode with the mode switch. (p. 25)

NOTE: If the dial lock function is activated, the lock indicator lights and the tuning dial does not function. In this case, push [LOCK] to deactivate the lock function.

For general coverage receiver use

- Push [GENE] on the keypad 1–3 times.
- The [GENE] key calls up a frequency for general coverage receiver use.

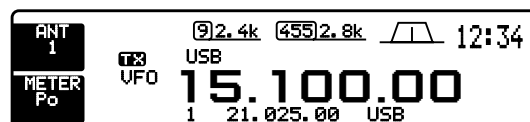

- Rotate the tuning dial to set the desired frequency.
- For quick tuning, use the quick tuning step function. (p. 24)

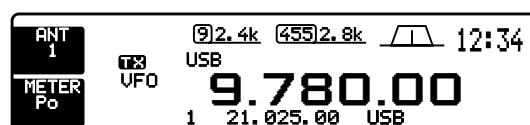

- Select the desired operating mode with the mode switch. (p. 25)

TRIPLE BAND STACKING REGISTER

The triple band stacking register provides 3 memories in one band. 3 sets of a frequency and mode on each band are automatically stored when used.

If a band key is pushed once, the last used frequency and mode are called up. When the key is pushed again, another stored frequency and mode are called up.

This function is convenient when you operate 3 modes on one band. For example, one register is used for a CW frequency, another for an SSB frequency and the other one for an RTTY frequency.

[EXAMPLE]

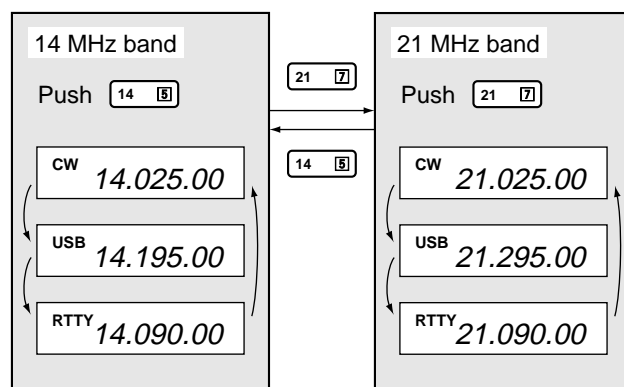

Direct frequency entry with the keypad

The transceiver has a keypad for direct frequency entry as described below.

- Push [F-INP].
- “F-Inp” appears.
- Input the desired frequency.
- Input “.” (decimal point) between the MHz units and kHz units.
- Push [F-INP•ENT] to enter the input frequency.
- To cancel the input, push [MAIN/SUB] instead of [F-INP•ENT]

[EXAMPLE]

- 14.025 MHz
[F-INP] [1] [4] [.] [0] [2] [5] [ENT]
- 18.0725 MHz
[F-INP] [1] [8] [.] [0] [7] [2] [5] [ENT]
- 706 kHz
[F-INP] [.] [7] [0] [6] [ENT]
- 5.100 MHz
[F-INP] [5] [.] [1] [ENT]
- 7.000 MHz
[F-INP] [7] [ENT]
- 21.280 → 21.245
[F-INP] [.] [2] [4] [5] [ENT]

Advanced tuning functions

QUICK TUNING STEP

The operating frequency can be changed in kHz steps (1, 5, 9 or 10 kHz selectable) for quick tuning.

- 1 Push [TS] momentarily to display the quick tuning indicator.

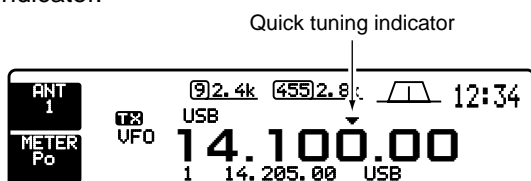

- 2 Rotate the tuning dial to change the frequency in programmed kHz steps.
- 3 Push [TS] again to turn OFF the indicator.
- 4 Rotate the tuning dial for normal tuning if desired.

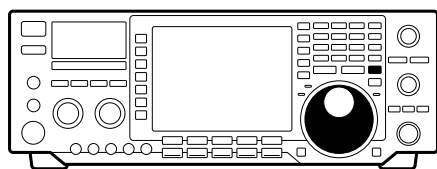

SELECTING THE kHz STEP

- 1 Push [TS] momentarily to turn the quick tuning step ON.
- 2 Push [TS] for 2 sec. to enter the quick tuning step setting display.
- Selected tuning steps for all modes appear.



- 3 Select the desired operating mode.
- 4 Push [F-1] – [F-4] to select the 1 kHz, 5 kHz, 9 kHz or 10 kHz tuning step, respectively.
- 5 Repeat steps 3 and 4 to select quick tuning steps for other modes, if desired.
- 6 Push [F-5] to exit the setting display.

SELECTING THE 1 Hz STEP

The minimum tuning step of 1 Hz can be used for fine tuning.

- 1 Turn OFF the quick tuning step.
- "▼" does not appear.
- 2 Push [TS] for 2 sec. to toggle the 1 Hz tuning step ON and OFF.
- RIT and/or ΔTX also functions in 1 Hz tuning step when used.

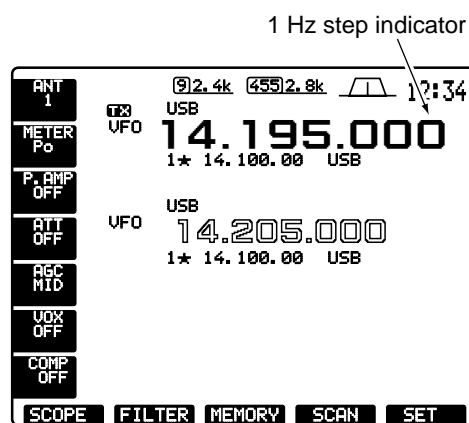
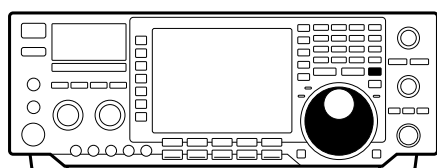

1/4 TUNING STEP FUNCTION (RTTY only)

While operating in RTTY, the 1/4 function is available for critical tuning. Dial rotation is reduced to 1/4 of normal when the 1/4 function is in use.

Push [1/4] to toggle the 1/4 function ON and OFF.

1/4 tuning step OFF



1/4 tuning step ON



AUTO TUNING STEP FUNCTION (AM/FM only)

When selecting AM or FM, the quick tuning step is automatically selected by the auto tuning step function.

Mode selection

The following modes are available in the IC-756:

SSB (LSB/USB), CW, CW-R (CW reverse), RTTY, RTTY-R (RTTY reverse), AM, FM and FM-T (FM with subaudible tone). Narrow modes of each of these are also available.

To select a mode of operation, push the desired mode switch momentarily. Push the switch again to toggle between normal and narrow mode. Push the switch for 2 sec. to toggle between USB and LSB, CW and CW-R, RTTY and RTTY-R, FM and FM-T, if necessary.

See the diagram at right for the order of selection.

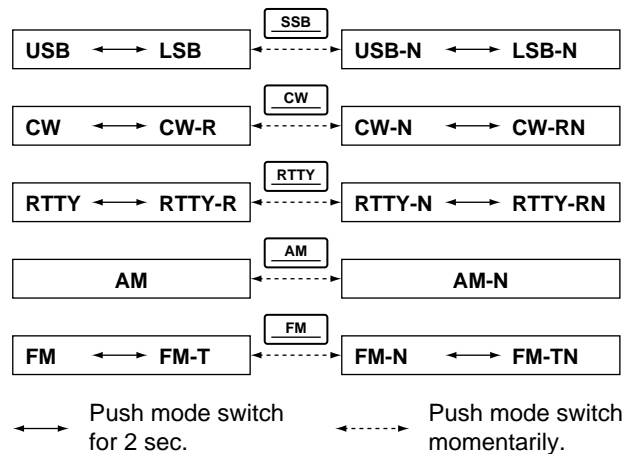

Twin PBT operation

The twin PBT (Passband Tuning) function electronically narrows the receiver's IF passband widths to reduce interference. Moving both [TWIN PBT] controls to the same position shifts the IF.

-The LCD shows the passband width graphically.

Variable range depends on the filter selection. ± 1.29 kHz in 15 Hz steps and ± 258 kHz in 3 Hz steps are available.

- [TWIN PBT] should normally be set to the center positions when there is no interference.
- When PBT is used, the audio tone may be changed.
- PBT may not function with some IF filter combinations.
- Not available for FM mode.

PBT OPERATION EXAMPLE

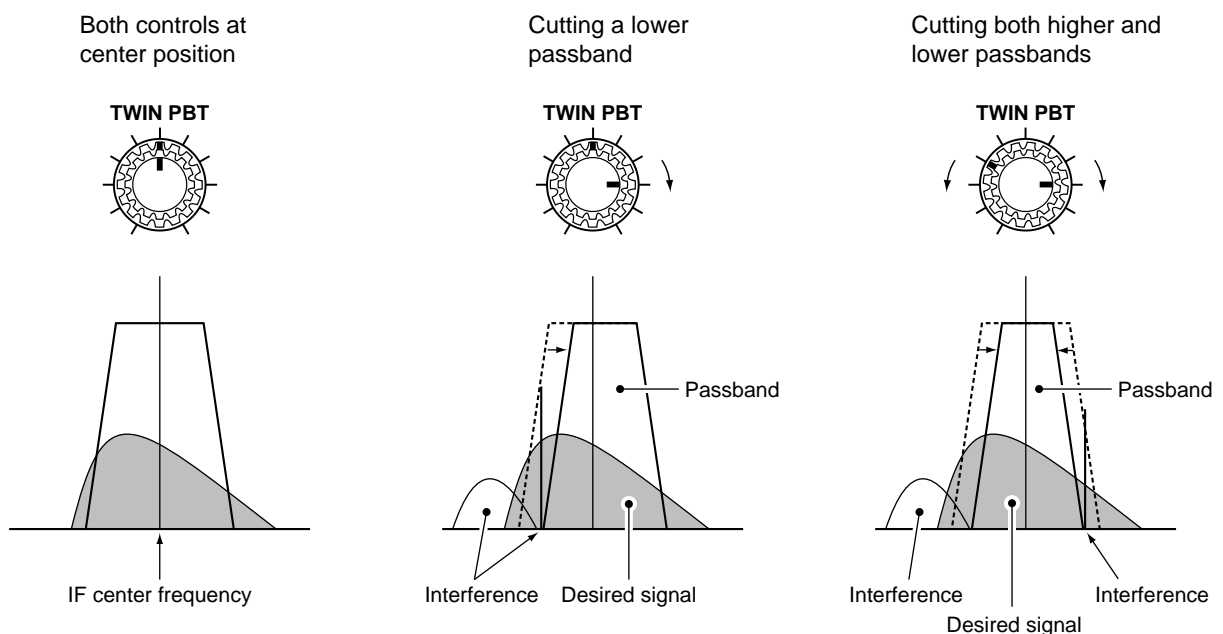

■ Auto notch function

The auto notch function automatically attenuates more than 3 beat tones, tuning signals, etc., even if they are moving.

The auto notch functions in SSB mode only.

- ① Select SSB mode.
- ② Push [AUTO NOTCH] to turn the auto notch function ON.
- ③ Push [AUTO NOTCH] again to cancel the function.

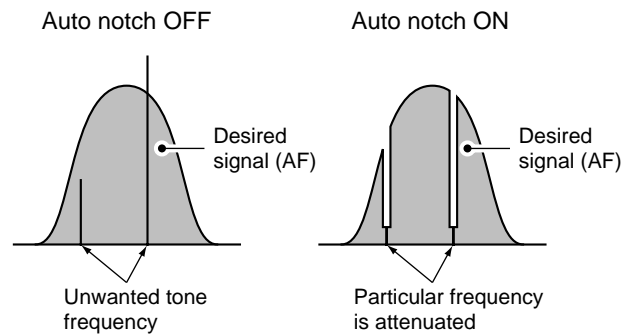

■ Noise reduction

The noise reduction function reduces noise components and picks out desired signals which are buried in noise. The received AF signals are converted to digital signals and then the desired signals are separated from the noise.

- ① Push the [NR] switch to turn the noise reduction ON.
- [NR] indicator lights.
- ② Rotate the [NR] control to adjust the noise reduction level.
- ③ Push the [NR] switch to turn the noise reduction OFF.
- [NR] indicator does not light.

Deep rotation of the [NR] control results in audio signal masking or distortion. Set the [NR] control for maximum readability. The noise reduction function is not available in AM and FM modes.

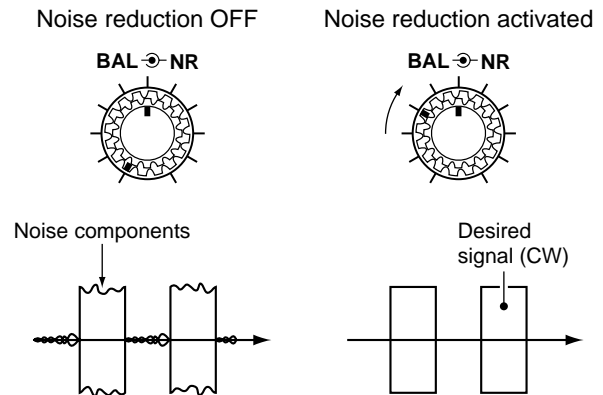

■ Noise blanker

The noise blanker eliminates pulse-type noise such as from car ignitions. The noise blanker is not available for FM mode.

- Push the [NB] switch to turn the noise blanker ON or OFF.

 Noise blanker OFF  Noise blanker ON

NOTE: When using the noise blanker, received signals may be distorted if they are excessively strong.

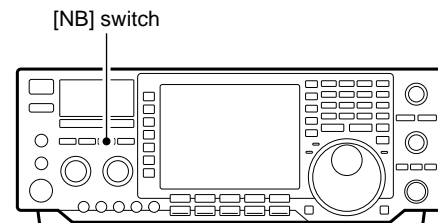

■ APF function

The APF (Audio Peak Filter) changes the receive frequency response by boosting a particular frequency for better copying of desired CW signals. The peak frequency can be adjusted with [APF] from 300 to 900 Hz manually. The boost frequency width can be selected from 80, 160 or 320 Hz.

- ① Push [CW] to select CW mode.
- ② Push the [APF] switch to turn the audio peak filter ON.
 - The [APF] switch lights.
 - “**APF320**,” etc. appears in the LCD.
- ③ Rotate the [APF] control to adjust the center frequency of the peak frequency.
- ④ Push [APF] for 2 sec. to select the boost frequency width of the audio peak filter between 80, 160 and 320 Hz.
 - “**APF 80**,” “**APF160**” or “**APF320**” indicate the frequency width.
- ⑤ Push the [APF] switch momentarily to cancel the audio peak filter.

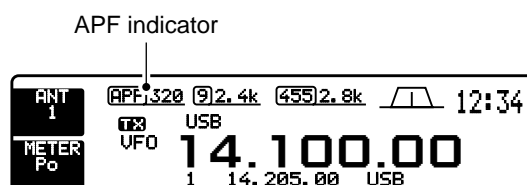
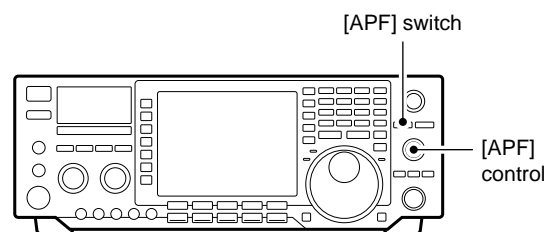

■ CW reverse mode

CW-R (CW Reverse) mode receives CW signals with a reverse side CW carrier point like that of LSB and USB modes.

Use when interfering signals are near a desired signal and you want to change the interference tone.

- Push [CW] for 2 sec. once or twice to select CW or CW-R mode.
 - Check the interfering tone.

• Receive audio tone response

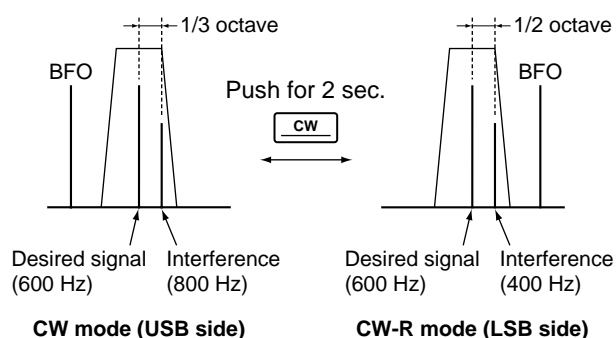

■ RTTY reverse mode

Received characters are occasionally garbled when the receive signal is reversed between MARK and SPACE. This reversal can be caused by incorrect TNC connections, settings, commands, etc.

To receive a reversed RTTY signal correctly, select RTTY-R (RTTY Reverse) mode.

- Push [RTTY] for 2 sec. once or twice to select RTTY or RTTY-R mode.
 - Check the receive signal.

■ CW pitch control

The received CW audio pitch and monitored CW audio can be adjusted to suit your preferences (300 to 900 Hz) without changing the operating frequency.

The received CW audio pitch can be adjusted in 3 Hz steps.

Filter selection

The filter selection switches the IF passband width as shown in the table at right.

The filter selection is automatically memorized in each mode.

When an optional filter is installed, set the optional filter setting in set mode. (p. 55) Optional filters are not selected by default.

- ① If the start up screen is not selected (if [F-5]'s function is [EXIT]), push [F-5] one or more times to exit.
- ② Push the desired mode switch.
- ③ Push [(F-2)FILTER] to enter the filter selection screen.
 - The lines show the selectable combination of IF filters.
- ④ Push [(F-2)9MHz] or [(F-4)455kHz] one or more times to select the 9 MHz or 455 kHz IF filter, respectively.
 - Push [(F-3)DEF] to select a default filter combination for the selected mode.
- ⑤ Repeat steps ② to ④ if desired.
- ⑥ Push [(F-5)EXIT] to exit the filter selection screen.

Optional filter information

| IF | Filter | Passband width | Used selectivity |
|---------|--------|----------------|---------------------|
| 9 MHz | FL-100 | 500 Hz/-6 dB | CW-N, RTTY-N |
| | FL-101 | 250 Hz/-6 dB | CW-N, RTTY-N |
| | FL-223 | 1.9 kHz/-6 dB | SSB-N, CW-N, RTTY-N |
| | FL-232 | 350 Hz/-6 dB | CW-N, RTTY-N |
| 455 kHz | FL-52A | 500 Hz/-6 dB | CW-N, RTTY-N |
| | FL-53A | 250 Hz/-6 dB | CW-N, RTTY-N |
| | FL-222 | 1.8 kHz/-6 dB | SSB-N, CW-N, RTTY-N |

FL-257 information

The IC-756 can use the optional FL-257 SSB WIDE FILTER. It has 3.3 kHz/-6 dB passband width.

To use the FL-257, select FL-222 and SSB narrow mode.

Filter construction

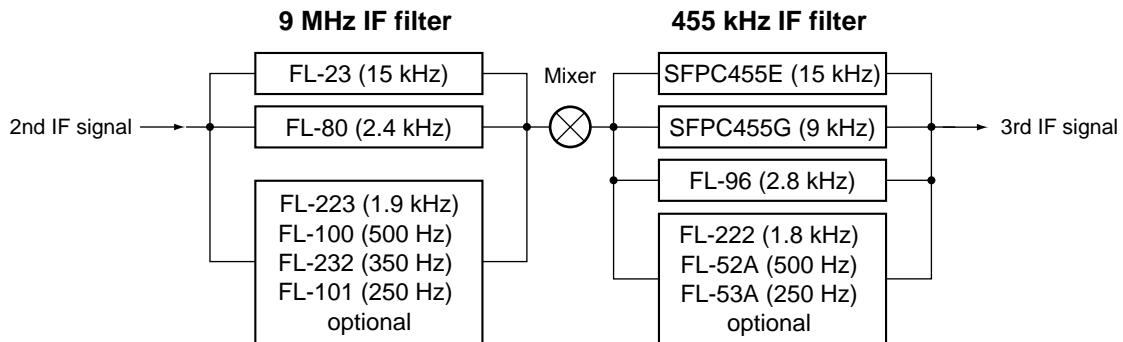

Filter selection screen

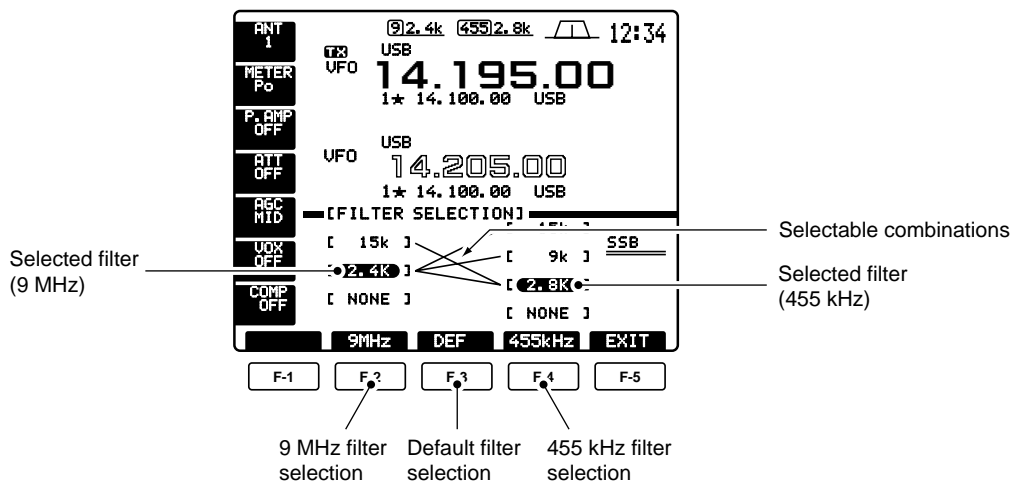

RIT and ΔTX

•RIT function

The RIT function shifts the receive frequency up to ±9.999 kHz in 1 Hz steps (10 Hz steps when cancelling the 1 Hz step readout) without moving the transmit frequency.

- See 32 on p. 5 for function description.

- 1 Push the [RIT] switch.

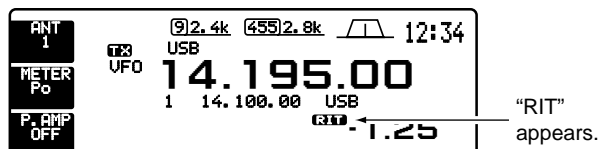

- 2 Rotate the [RIT/ΔTX] control.

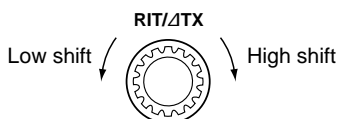

- 3 To reset the RIT frequency, push [CLEAR] for 2 sec.

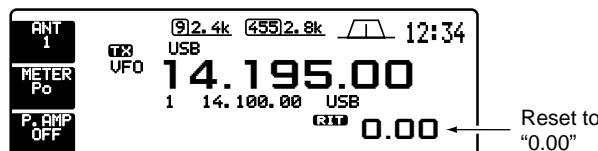

- 4 To cancel the RIT function, push [RIT] again.
 - "RIT" disappears.

NOTE: When RIT and ΔTX are ON at the same time, the [RIT/ΔTX] control shifts both the transmit and receive frequencies from the displayed frequency at the same time.

•ΔTX function

The ΔTX function shifts the transmit frequency up to ±9.999 kHz in 1 Hz steps (10 Hz steps when cancelling the 1 Hz step readout) without moving the receive frequency.

- See 33 on p. 5 for function description.

- 1 Push the [ΔTX] switch.

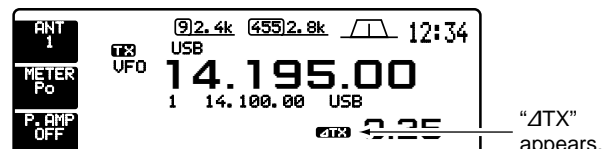

- 2 Rotate the [RIT/ΔTX] control.

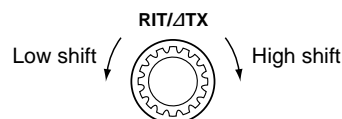

- 3 To reset the ΔTX frequency, push [CLEAR] for 2 sec.

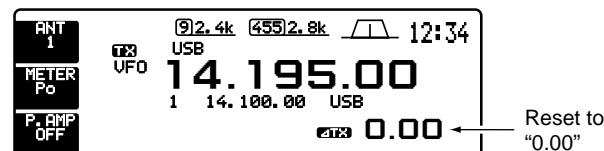

- 4 To cancel the ΔTX function, push [ΔTX] again.
 - "ΔTX" disappears.

•Calculate function

The shift frequency of the RIT or ΔTX function can be added/subtracted to the displayed frequency.

While displaying the RIT and/or ΔTX shift frequency, push [RIT] or [ΔTX] for 2 sec.

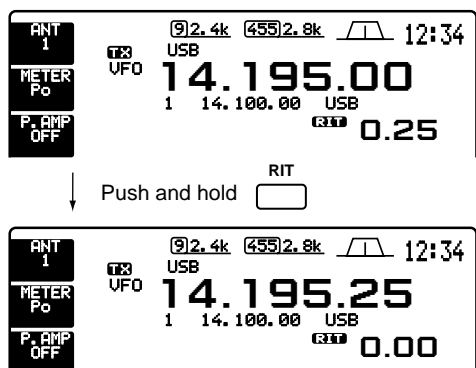

PRACTICAL EXAMPLE

When you find a DX station on 21.025 MHz/CW and the station is picking up stations transmitting slightly up from 21.025 MHz.

- 1 Push [RIT] and [ΔTX] to turn both the RIT and ΔTX functions ON.
- 2 Rotate [RIT/ΔTX] to find the DX station's receive frequency.
- 3 When you find the DX station's receive frequency, push [RIT] to turn the RIT function OFF.
 - Now you can transmit the DX station's receive frequency and receive the DX station's transmit frequency (21.025 MHz).
- 4 Start transmitting while the station is standing by.

Dualwatch operation

Dualwatch monitors 2 frequencies with the same mode simultaneously.

During dualwatch, both frequencies should be on the same band because the bandpass filter in the RF circuit is selected for the main readout frequency.

- ① Set a desired frequency.
- ② Push [DUALWATCH] for 2 sec.
 - Equalized receive frequency and "DUAL-W" appear in the LCD. This quick dualwatch function can be turned OFF. (p. 56)
 - Pushing [DUALWATCH] momentarily activates the dualwatch with the previously operated frequency.

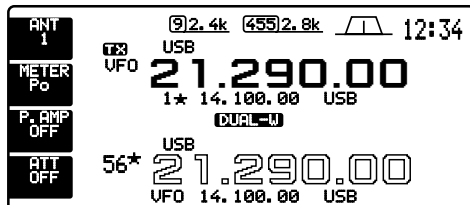

- ③ Set another desired frequency using the tuning dial.
- ④ Adjust [BAL] to set a suitable signal strength balance between the main and sub readout frequencies.
 - S-meter shows the combined signal strength.
- ⑤ To transmit on the sub readout frequency, push [CHANGE] or [SPLIT].

/// RIT function can be used for the main readout only.
 /// ΔTX function can be used for the transmit readout (main readout when the split function is OFF; sub readout when the split function is ON).

Scanning during dualwatch

Scanning operates only for the main readout. To operate the scan during dualwatch, scan on the main readout and use the sub readout for your QSO using both dualwatch and split frequency operation.

- ① Program the desired programmed scan edges in the same amateur band. See p. 43 for programming.
 - If you plan to operate a ΔF scan, programming the scan edges may not be necessary.
- ② Push [SPLIT] to turn the split frequency function ON.
 - "SPLIT" appears.



- ③ Select VFO mode for the main readout.
- ④ Set the desired operating frequency for the main readout.

- ⑤ Push [DUALWATCH] for 2 sec.
 - The main and sub readout frequencies are equalized and the dualwatch function is turned ON.

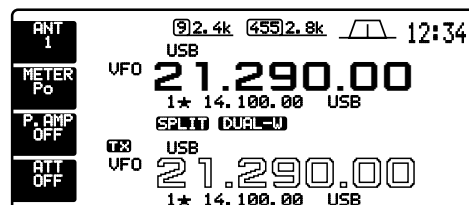

- ⑥ Push [(F-4)SCAN] to select the scan screen.
 - If the start up screen is not selected (if [F-5]'s function is [EXIT]), push [F-5] one or more times to exit.
- ⑦ Push [(F-1)PROG] or [(F-2)ΔF] to start the programmed scan or ΔF scan, respectively.
 - Scan activates on the main readout between the programmed scan edges or within the ΔF span.
 - Transmitting on the sub readout stops the scan.

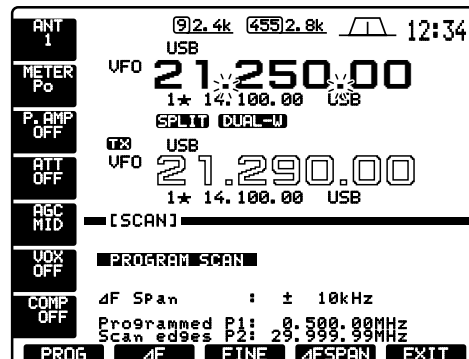

- ⑧ To cancel the scan, push [(F-5)EXIT].

Split frequency operation

Split frequency operation allows you to transmit and receive in the same mode on two different frequencies. The split frequency operation is basically performed using 2 frequencies on the main and sub readouts.

Following is an example of setting 21.290 MHz for receiving and 21.310 MHz for transmitting.

- Set 21.290 MHz (USB) in VFO mode.

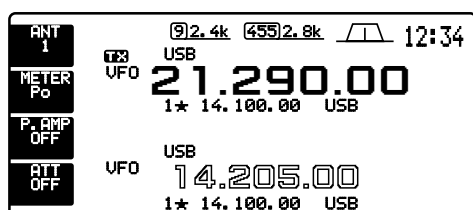

- Push [SPLIT] momentarily, then push [CHANGE] for 2 sec.

- The quick split function is much more convenient for selecting the transmit frequency. See the next section for details.
- Equalized transmit frequency and "SPLIT" appear on the LCD.
- "TX" appears to show the transmit frequency's readout.

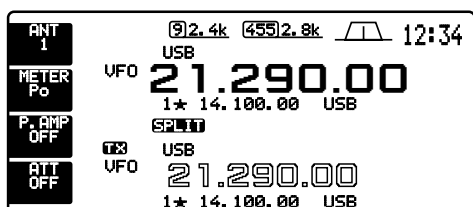

- Rotate the tuning dial while pushing [XFC] to set the transmit frequency to 21.310 MHz.

- The transmit frequency can be monitored while pushing [XFC] or using dualwatch.

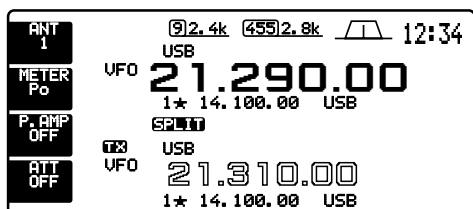

- Now you can receive on 21.290 MHz and transmit on 21.310 MHz.

To change the transmit and receive frequencies, push [CHANGE] to exchange the main and sub readouts.

CONVENIENT

DIRECT SHIFT FREQUENCY INPUT

The shift frequency can be entered directly.

- Push [F-INP].
- Enter the desired shift frequency with the digit keys.
 - 1 kHz to 1 MHz can be set.
 - When you require a minus shift direction, push [•] in advance.
- Push [SPLIT].
 - The shift frequency is input in the sub readout and the split function is turned ON.

[EXAMPLE]

To operate on 1 kHz higher frequency:

[F-INP] [1] [SPLIT]

To operate on 3 kHz lower frequency:

[F-INP] [•] [3] [SPLIT]

CONVENIENT

DUALWATCH FUNCTION

The dualwatch function is convenient for tuning the transmit frequency while monitoring both frequencies used for transmitting and receiving.

CONVENIENT

SPLIT LOCK FUNCTION

Accidentally releasing the [XFC] switch while rotating the tuning dial changes the receive frequency. To prevent this, use both the split lock and dial lock functions to change the transmit frequency only. The split lock function cancels the dial lock function while pushing [XFC] during split frequency operation.

The dial lock's effectiveness during split frequency operation can be selected in the set mode for both receive and transmit frequencies; or only the receive frequency. (p. 57)

■ Quick split function

When you find a DX station, an important consideration is how to set the split frequency.

When you push the [SPLIT] switch for 2 sec., split frequency operation is turned ON, the sub readout is equalized to the main readout frequency and enters standby for transmit frequency input.

This shortens the time needed to start split frequency operation.

The quick split function is ON by default. For your convenience, it can be turned OFF in set mode. (p. 56) In this case, the [SPLIT] switch does not equalize the main and sub readout frequencies.

- ① Suppose you are operating at 21.290 MHz (USB) in VFO mode.

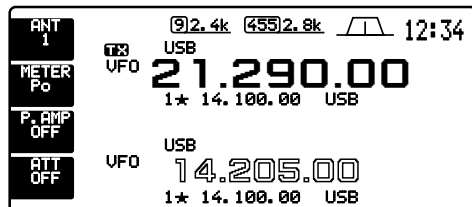

- ② Push [SPLIT] for 2 sec.
- Split frequency operation is turned ON.
 - The sub readout is equalized to the main readout frequency.
 - The sub readout enters standby for transmit frequency input.

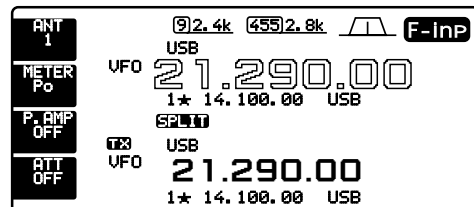

- ③ Rotate the tuning dial to set the transmit frequency; or, input the transmit frequency using the keypad and [ENT]; or, input a shift frequency using the keypad and [SPLIT].
- The transmit frequency can be monitored while pushing [XFC] or using dualwatch.

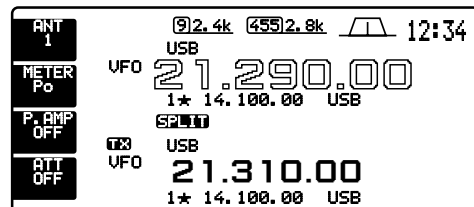

PRACTICAL EXAMPLE

When you are searching for DX stations and you suspect that a DX station may say "up 'X' kHz" for their receive frequency:

OPERATION 1

- ① Push [SPLIT] for 2 sec. to standby for split operation.
- ② If the DX station says "up 10 kHz":
- Push [1], [0] then [SPLIT].
 - Or, rotate the tuning dial.

OPERATION 2

If the DX station says "down 5 kHz" before you enter standby for split operation:

- Push [F-INP], [•], [5] then [SPLIT].
- The split function is turned ON and "5 kHz down" frequency is entered in the sub readout.

PRACTICAL EXAMPLE

When you receive a pile-up and you want to start split frequency operation to simplify picking out stations:

- ① Push [SPLIT] momentarily and push [CHANGE] for 2 sec.
- The sub readout frequency is equalized to the main readout frequency and "SPLIT" appears.
- ② Rotate the tuning dial to set your receive frequency in the main readout.
- ③ Announce your receive frequency.
- ④ After you catch one of the calling stations' call signs, push and hold the PTT switch to respond.
- While pushing [XFC], you can monitor your transmit frequency.

■ Monitor function

The monitor function allows you to monitor your transmit IF signals in any mode through the speaker. Use this to check voice characteristics while adjusting transmit tones. (p. 54) The CW sidetone functions regardless of the [MONITOR] switch setting.

- ① Push [MONITOR].
 - The indicator lights when the monitor function is ON.
- ② If the start up screen is not selected (if [F-5]'s function is [EXIT]), push [F-5] one or more times to exit.
- ③ Push [(F-5)SET] then [(F-1)LEVEL] to enter level set mode.
- ④ Push [(F-1)▲] or [(F-2)▼] to select the monitor adjustment item.
- ⑤ Adjust monitor gain using the tuning dial.
 - Pushing [(F-3)DEF] sets the selected item to the default value of the item.
- ⑥ Push [(F-5)EXIT] twice to exit level set mode.

- Use headphones to prevent feedback.
- Set the transmit tone settings to the 0 dB positions to check the unaltered characteristics of transmitter or microphone.

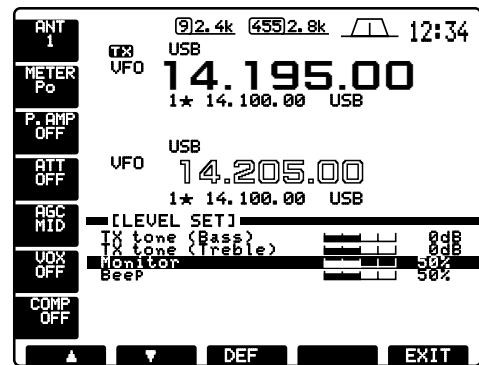
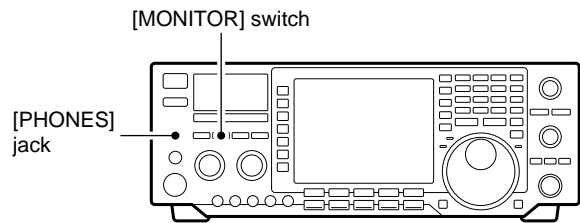

■ VOX function

The VOX (Voice-Operated Transmission) function toggles between transmit and receive with your voice. This function provides an opportunity to input log entries into your computer, etc., while operating.

• Using the VOX function

- ① Select a phone mode (SSB, AM, FM).
- ② Push [VOX] to turn the VOX function ON or OFF.

• Adjusting the VOX function

- ① Select a phone mode (SSB, AM, FM).
- ② Push [VOX] to turn VOX function ON.
- ③ Push [VOX] for 2 sec. to enter VOX set mode.
- ④ Select the VOX gain item using [F-1] or [F-2].
- ⑤ While speaking into the microphone, rotate the tuning dial to the point where the transceiver is continuously transmitting.
- ⑥ Adjust the VOX delay for a convenient interval before returning to receive.
 - Select the VOX delay item using [F-1] or [F-2].
 - Rotate the tuning dial.
- ⑦ If the receive audio from the speaker toggles to transmit, adjust the anti VOX to the point where it has no effect.

[VOX] switch in phone modes

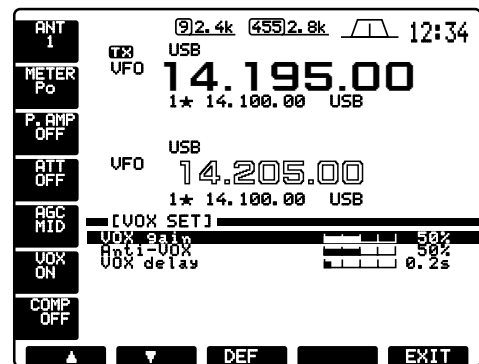
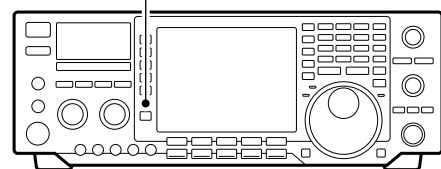

■ Meter function

The transceiver has 3 transmit meter functions for your convenience. Select the desired meter with the [METER] switch.

- Push [METER] to select RF power (Po), SWR or ALC for transmit metering.

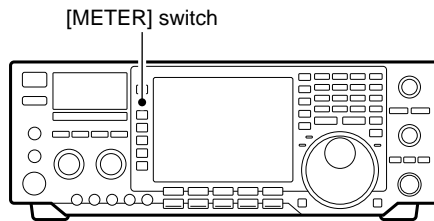

| DISPLAY INDICATION | MEASUREMENT |
|--------------------|---|
| Po | Indicates the relative RF output power in %. |
| SWR | Indicates the SWR over the transmission line. |
| ALC | Indicates the ALC level. When the meter movement shows the input signal level exceeds the allowable level, the ALC limits the RF power. In such cases, reduce the [MIC GAIN] control. |

■ Speech compressor

The RF speech compressor increases average RF output power, improving signal strength and readability in SSB.

- 1 Select USB or LSB mode.
- 2 Preset the transceiver as follows:
 - [COMP] function : OFF
 - [METER] function : ALC
 - [RF POWER] control : Max. counterclockwise
- 3 Adjust the [MIC GAIN].
 - While transmitting at your normal voice level, the ALC meter should read at about the middle of the ALC zone.
- 4 Push [COMP] to turn the speech compressor ON.
- 5 Adjust the [COMP] control so that the ALC meter reads within the ALC zone whether you speak softly or loudly.

When the ALC meter peaks above the ALC zone, your transmitted voice may be distorted.

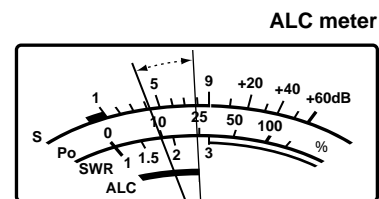
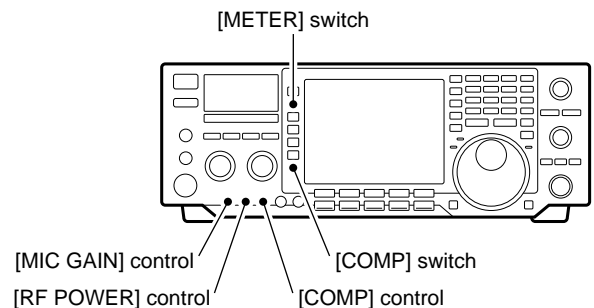

■ SWR reading

The SWR meter indicates the SWR over the transmission line in all modes.

- 1 Push [TUNER] to turn the antenna tuner OFF.
- 2 Push [METER] to select the Po meter.
- 3 Push [RTTY] to select RTTY mode.
- 4 Push [TRANSMIT].
- 5 Rotate [RF POWER] clockwise past the 12 o'clock position for more than 30 W output power (30%).
- 6 Set transmit meter to the SWR meter.
- 7 Read the SWR on the SWR meter.

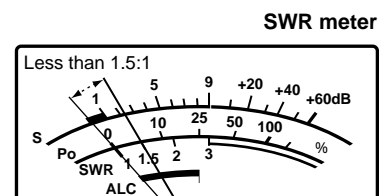

The built-in antenna tuner matches the transmitter to the antenna when the SWR is lower than 3 : 1.

Electronic CW keyer

The transceiver has an electronic keyer. Keying speed can be adjusted with [KEY SPEED]. Keying weight, the ratio of dot:space:dash, can be set from 1:1:2.8 to 1:1:4.5 in keyer set mode.

Setting the electronic keyer

- Push [CW] to select CW mode.

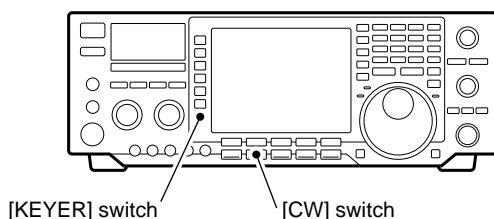

- Push [KEYER] to select keyer set mode.

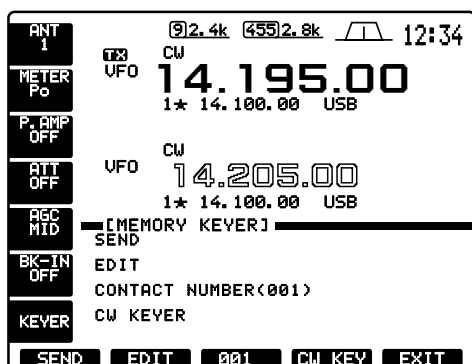

- Push [(F-4)CW KEYS] to enter keyer set mode.
- Select the "Dot/dash ratio" item using [F-1] or [F-2].



- Rotate the tuning dial to select the keying weight.
 - 1:1:2.8 to 1:1:4.5 can be set.
 - Check the ratio with side tone in CW mode.
 - Push [(F-3)DEF] to select a default ratio of 1:1:3.0.
- Push [F-2] to select the "Paddle polarity" item.



- Rotate the tuning dial to select the key polarity between normal and reverse polarity.

- Push [F-2] to select the "Keyer type" item.



- Rotate the tuning dial to set the electronic keyer function to electronic keyer, bug-key or straight key (electronic keyer OFF).
 - Bug-key setting can be substituted for a bug-key while operating with a paddle. Set for "straight" for a real bug-key or connect the bug-key to [KEY] on the rear panel.
- Push [F-2] to select the "Mic up/down keyer" item.



- Rotate the tuning dial to turn the substitute paddle function ON or OFF.
 - The up/down keys of the microphone can be substituted for a paddle. When ON is selected, they do not function as up/down keys in all modes.
- Push [(F-5)EXIT] to exit keyer set mode.

KEYING WEIGHT EXAMPLE: morse code "K"

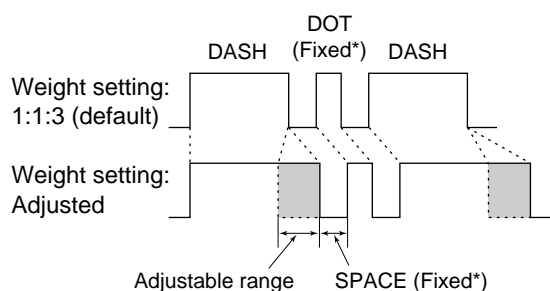

*SPACE and DOT length can be adjusted with [KEY SPEED] only.

Memory keyer

The memory keyer memorizes and can re-transmit 4 CW key codes for often-used CW sentences, antenna types, etc. Total capacity of the memory keyer is 55 characters in each memory channel.

• Programming the memory keyer

- ① Push [CW] to select CW mode.
- ② Push [KEYER] to select keyer set mode.
- ③ Push [(F-2)EDIT] to enter the memory keyer edit screen.



- ④ Push [M1...M4] one or more times to select the desired keyer memory channel.
- ⑤ Input the desired character by pushing the character keys (as shown above) one or more times or by pushing the band key for number input.
 - Push [(F-1)◀] or [(F-2)▶] for cursor movement.
 - Push [(F-3)DEL] to delete the selected character.
 - Push [(F-4)SPACE] to input a space.
 - "*" is for contact numbers and can be input for the count up trigger channel (underlined memory channel).
- ⑥ Repeat step ⑤ until the desired contents are input.
- ⑦ Push [M1...M4] to select next memory channel and repeat step ⑤ for character input, if desired.
- ⑧ Push [(F-5)EXIT] to exit the memory keyer edit screen.

• Transmitting memory keyer contents

- ① Push [CW] to select CW mode.
- ② Push [KEYER] to select keyer set mode.
- ③ Push [(F-1)SEND] to enter the memory keyer screen.

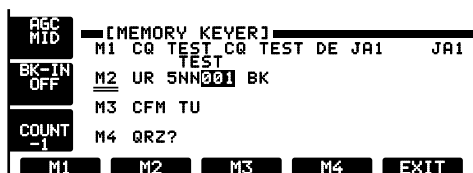

- ④ Push [(F-1)M1] – [(F-4)M4] momentarily to transmit the contents one time; push these keys for 2 sec. to transmit the contents repeatedly.
 - "M1"–"M4" are highlighted while transmitting.
 - "M1"–"M4" blink while transmitting repeatedly.
 - Set the repeat interval of the memory keyer to 1, 2, 10 or 30 sec. See the the previous page for keyer set mode.
 - To count down the contact number, push [COUNT–1].
- ⑤ Push [(F-5)EXIT] to exit memory keyer screen.

• Setting the contact (serial) number

Contact number can be automatically transmitted from one of the memory keyer channels. The morse cut numbers can be used as the contact numbers. The maximum number for contact numbers is 9999.

- ① Push [CW] to select CW mode.
- ② Push [KEYER] to select keyer set mode.
- ③ Push [(F-3)001] to enter contact number screen.

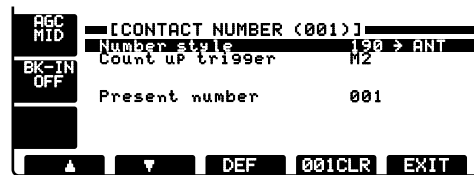

- ④ Rotate the tuning dial to select the cut number type, if desired.
 - "NORMAL" does not use morse cut numbers.
 - "190 → ANO" sets 1 as A, 9 as N and 0 as O.
 - "190 → ANT" sets 1 as A, 9 as N and 0 as T.
 - "90 → NO" sets 9 as N and 0 as O.
 - "90 → NT" sets 9 as N and 0 as T.
- ⑤ Push [F-2] to select the "Count up trigger" item.

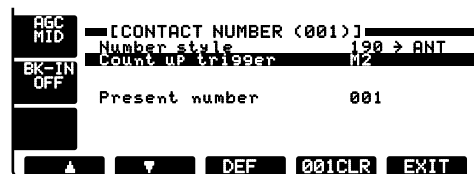

- ⑥ Rotate the tuning dial to select the desired memory channel for contest numbers.
- ⑦ Push [(F-5)EXIT] to exit keyer set mode.

• Clearing contact numbers

- ① Push [CW] to select CW mode.
- ② Push [KEYER] to select keyer set mode.
- ③ Push [(F-3)001] to enter the contact number screen.
- ④ Push [(F-4)001CLR] for 2 sec. to clear the contact number.
- ⑤ Push [(F-5)EXIT] to exit keyer set mode.

Spectrum scope screen

This function allows you to display the relative strengths of signals around the center frequency. The span can be set to ± 12.5 kHz, ± 25 kHz, ± 50 kHz and ± 100 kHz. Ideal for monitoring band conditions in an instant.

- ① If the start up screen is not selected (if [F-5]'s function is [EXIT]), push [F-5] one or more times to exit.
- ② Push [(F-1)SCOPE] to select the scope screen.

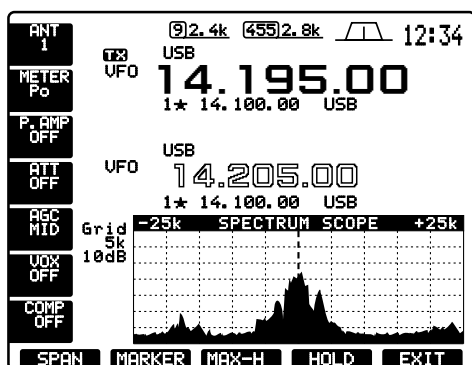

- ③ Push [(F-1)SPAN] one or more times to select the scope span.

- ④ Push [(F-2)MARKER] to select the marker or turn the marker OFF.
 - SUB MARK displays the marker at the sub readout frequency.
 - TX MARK displays the marker at the transmit frequency.

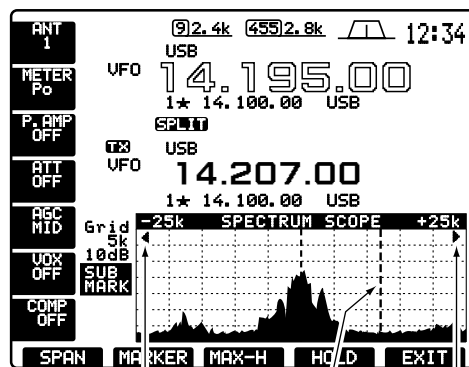

Appears when the marker is out of range. Sub readout or TX marker Appears when the marker is out of range.

- ⑤ Push [(F-3)MAX-H] to hold peak levels or not.
- ⑥ Push [(F-4)HOLD] to freeze the current spectrum waveform.
- ⑦ Push [(F-5)EXIT] to exit the scope screen.

Band memory (for automatic antenna selection)

The transceiver covers 0.1–60 MHz over 10 bands. Each band key has a band memory which can memorize a selected antenna (ANT1, ANT2, ANT1/RX antenna and ANT2/RX antenna). When you change the operating frequency beyond a band, the previously used antenna is automatically selected for the new band. This function is convenient when you use 2 or 3 antennas.

To use the band memory, enter set mode and confirm that "AUTO" is selected as the [ANT] switch item. (p. 58)



- When OFF is selected, the [ANT] switch does not function and [ANT1] is always selected.
- When MANUAL is selected, the [ANT] switch functions, however, band memory does not function. In this case, you must select an antenna manually.
- When AUTO is selected (default setting), the antenna tuner ON/OFF condition is also memorized in the band memory.
- When AUTO or MANUAL is selected, the antenna tuner ON/OFF condition is consistent with the [ANT] switch.

Antenna switch selection example

Under the following condition, "AUTO" should be selected as the [ANT] switch set mode item.

- When you use 2 antennas.

Under the following conditions, "MANUAL" should be selected as the [ANT] switch set mode item.

- When using 1 antenna.
- When using the EX-627 HF AUTOMATIC ANTENNA SELECTOR for more than 3 antennas (except for receive antenna).
- When using an external antenna tuner.

■ Repeater operation

A repeater amplifies received signals and retransmits them at a different frequency. When using a repeater, the transmit frequency is shifted from the receive frequency by an offset frequency. A repeater can be accessed using split frequency operation with the shift frequency set to the repeater's offset frequency.

NOTE: For accessing a repeater which requires a subaudible tone, set the subaudible tone frequency in set mode. Refer to p. 57.

- ① Set the offset frequencies (HF, 50 MHz) and turn ON the quick split function in set mode in advance.
- ② Push [VFO/MEMO] to select VFO mode.

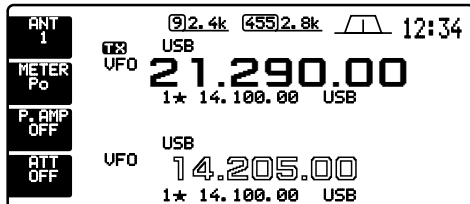

- ③ Push the desired band key.
- ④ Push [FM] to select FM mode.
- ⑤ Set the receive frequency (repeater output frequency).

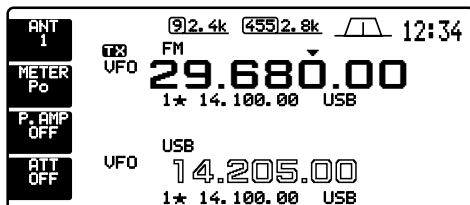

- ⑥ Push [SPLIT] for 2 sec. to start repeater operation.
 - Subaudible tone encoder is turned ON automatically.
 - Shifted transmit frequency and "TX" appear in the sub readout.
 - The transmit frequency can be monitored while pushing [XFC] or using dualwatch.

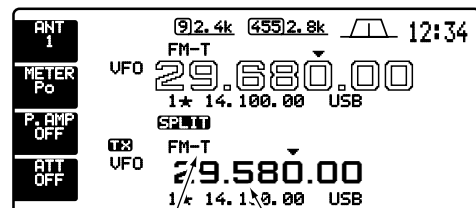

Tone encoder is automatically turned ON.

Shifted frequency appears.

- ⑦ Push and hold [PTT] to transmit; release [PTT] to receive.
- ⑧ To return to simplex, push [SPLIT] momentarily to clear the sub display.

■ Dial lock function

The dial lock function prevents accidental changes caused by the tuning dial. The lock function electronically locks the dial.

- Push [LOCK] to toggle the dial lock function ON and OFF.
 - The [LOCK] indicator lights when the dial lock function is in use.

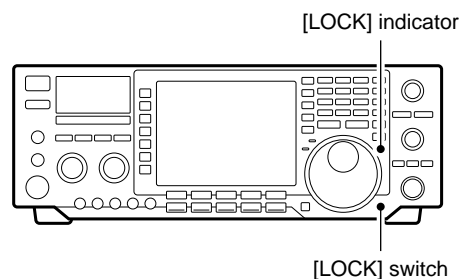

■ Antenna tuner operation

The internal automatic antenna tuner matches the transceiver to the connected antenna automatically. Once the tuner matches an antenna, the variable capacitor angles are memorized as a preset point for each frequency range (100 kHz steps). Therefore, when you change the frequency range, the variable capacitors are automatically preset to the memorized point.

CAUTION: NEVER transmit with the tuner ON when no antenna is connected. This will damage the transceiver. Be careful of the antenna selection.

TUNER OPERATION

Push the [TUNER] switch to turn the internal antenna tuner ON. The antenna is tuned automatically when the antenna SWR is higher than 1.5:1.

- When the tuner is ON, the [TUNER] switch lights.

Push [TUNER].

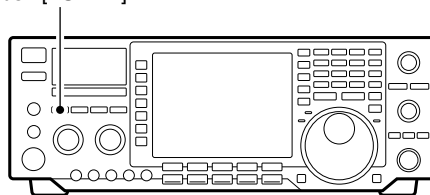

MANUAL TUNING

During SSB operation at low voice levels, the internal tuner may not be tuned correctly. In such cases, manual tuning is helpful.

Push [TUNER] for 2 sec., to start manual tuning.

- A side tone is emitted and [TUNER] blinks while tuning.
- If the tuner cannot reduce the SWR to less than 1.5:1 after 20 sec. of tuning, the [TUNER] switch indicator goes out.

Push [TUNER] for 2 sec.

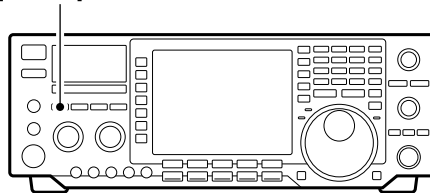

AUTOMATIC TUNER START (HF bands only)

If you want to deactivate the tuner under conditions of VSWR 1.5:1 or less, use the auto tuner start function and turn the tuner OFF. This function activates the tuner automatically when the SWR exceeds 1.5:1.

This function is turned ON in set mode. (p. 57).

PTT TUNER START

The tuner is always tuned when the PTT is pushed after the frequency is changed (more than 1% from last-tuned frequency). This function removes the "push and hold [TUNER]" operation and activates for the first transmission on a new frequency.

This function is turned ON in set mode. (p. 58).

NOTES:

•If the tuner cannot tune the antenna

Check the following and try again:

- the [ANT] connector selection.
- the antenna connection and feedline.
- the unaltered antenna SWR. (Less than 3:1 for HF bands;
Less than 2.5:1 for 50 MHz band)
- the transmit power. (8 W for HF bands; 15 W for 50 MHz band)
- the power source voltage/capacity.

If the tuner cannot reduce the SWR to less than 1.5:1 after checking the above, perform the following:

- repeat manual tuning several times.
- tune with a 50 Ω dummy load and re-tune the antenna.
- turn power OFF and ON.
- adjust the antenna cable length.

(This is effective for higher frequencies in some cases.)

•Tuning a narrow bandwidth antenna

Some antennas, especially for low bands, have a narrow bandwidth. These antennas may not be tuned at the edge of their bandwidth, therefore, tune such an antenna as follows:

Suppose you have an antenna which has an SWR of 1.5:1 at 3.55 MHz and an SWR of 3:1 at 3.8 MHz.

- ① Push [TUNER] to turn the antenna tuner ON.
- ② Select CW mode.
- ③ Turn OFF the break-in function. (p. 3)
- ④ Push [TRANSMIT] to set to the transmit condition.
- ⑤ Set 3.55 MHz and key down.
- ⑥ Set 3.80 MHz and key down.
- ⑦ Push [TRANSMIT] to return to the receive condition.

■ Optional external tuner operation

• AH-3 HF AUTOMATIC ANTENNA TUNER

The AH-3 matches the IC-756 to a long wire antenna more than 3 m/10 ft long (3.5 MHz and above) or more than 12 m/40 ft long (1.8 MHz and above).

- See p. 18 for the transceiver and AH-3 connection.
- See the AH-3 instruction manual for AH-3 installation and antenna connection details.

AH-3 setting example:

For mobile operation

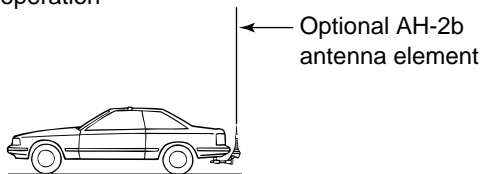

For outdoor operation

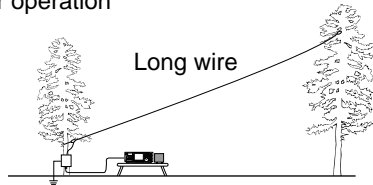

⚠ WARNING: HIGH VOLTAGE!

NEVER touch the antenna element while tuning or transmitting.

NEVER operate the AH-3 without an antenna wire. The tuner and transceiver will be damaged.

NEVER operate the AH-3 when it is ungrounded.

Transmitting before tuning may damage the transceiver. Note that the AH-3 cannot tune when using a $\frac{1}{2} \lambda$ long wire or multiple of the operating frequency.

NOTE: When connecting the AH-3, the antenna connector assignments are [ANT2] for the internal tuner and [ANT1] for the AH-3. The antenna indicator in the LCD displays "ANT1(EXT)" when the AH-3 is connected and selected.

NOTE: The AH-3 can be used for HF bands only. It cannot be used for the 50 MHz band.

• AH-3 operation

Tuning is required for each frequency. **Be sure** to re-tune the antenna before transmitting when you change the frequency—even slightly.

- ① Set the desired frequency in an HF band.
 - The AH-3 will not operate on frequencies outside of ham bands.
- ② Push [TUNER] for 2 sec.
 - The [TUNER] light blinks while tuning.

[TUNER] switch

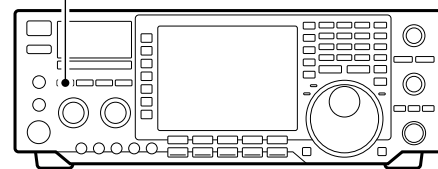

- ③ The [TUNER] light lights constantly when tuning is complete.
 - When the connected wire cannot be tuned, the [TUNER] light goes out, the AH-3 is bypassed and the antenna wire is connected to the antenna connector on the transceiver directly.
- ④ To bypass the AH-3 manually, push [TUNER].

• ANTENNA TUNER OF THE IC-4KL or IC-2KL/IC-AT500

When using an external antenna tuner such as the IC-4KL's tuner or IC-AT500 with a linear amplifier, tune with the external antenna tuner, while the internal tuner is turned OFF. After tuning is completed, turn the internal tuner ON. Otherwise, both tuners tune simultaneously and correct tuning may not be obtained.

See the instruction manual included with each antenna tuner for their respective operations.

Memory channels

The transceiver has 101 memory channels. The memory mode is very useful for quickly changing to often-used frequencies.

All 101 memory channels are tunable which means the programmed frequency can be tuned temporarily with the tuning dial, etc. in memory mode.

| MEMORY CHANNEL | MEMORY CHANNEL NUMBER | CAPABILITY | TRANSFER TO VFO | OVER-WRITING | CLEAR |
|---------------------------|-----------------------|--|-----------------|--------------|-------|
| Regular memory channels | 1–99 | One frequency and one mode in each memory channel. | Yes | Yes | Yes |
| Scan edge memory channels | P1, P2 | One frequency and one mode in each memory channel as scan edges for programmed scan. | Yes | Yes | No |

Memory channel selection

Using the [▲]/[▼] keys

- Push [VFO/MEMO] to select memory mode.
- Push [▲]/[▼] several times to select the desired memory channel.
 - Push and hold [▲]/[▼] for continuous selection.
 - [UP] and [DN] on the microphone can also be used.
- To return to VFO mode, push [VFO/MEMO] again.

Using the keypad

- Push [F-INP].
- Push the desired memory channel number using the keypad.
 - Enter 100 or 101 to select scan edge channel P1 or P2, respectively.
- Push [▲] or [▼] to select the desired memory channel.

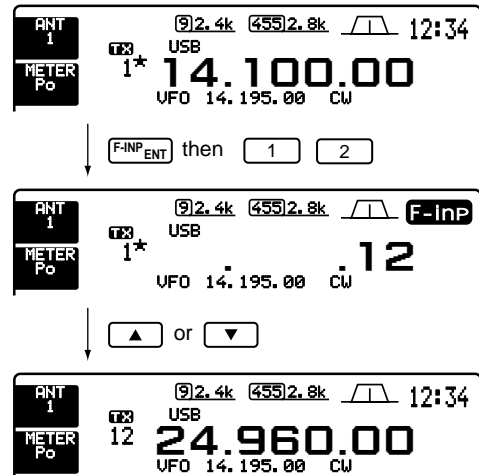
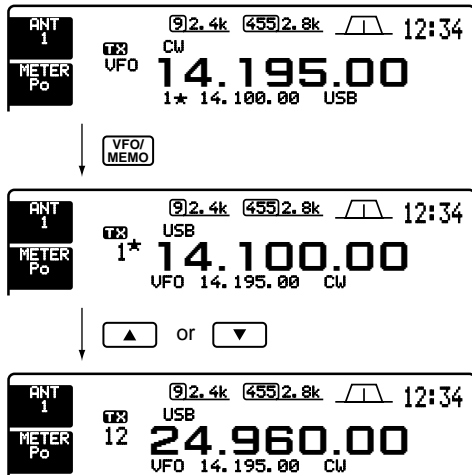

■ Memory channel screen

The memory channel screen simultaneously shows 9 memory channels and their programmed contents.

You can select a desired memory channel from the memory channel screen.

• Selecting a memory channel using the memory channel screen

- ① If the start up screen is not selected (if [F-5]'s function is [EXIT]), push [F-5] one or more times to exit.
- ② Push [(F-3)MEMORY] to select the memory channel screen.

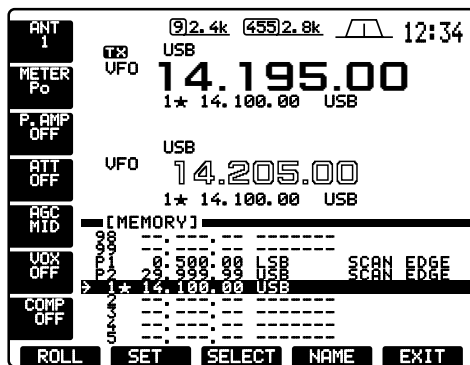

- ③ Rotate the tuning dial while pushing [(F-2)SET] to select the desired memory channel.
- ④ Push [(F-5)EXIT] to exit the memory channel screen.

• Confirming programmed memory channels

- ① Select the memory channel screen as described above.
- ② Rotate the tuning dial while pushing [(F-1)ROLL] to scroll the screen.
- ③ Push [(F-2)SET] to select the highlighted memory channel, if desired.

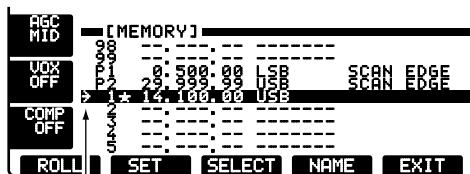

"→" appears when the memory channel is selected.

- ④ Push [(F-5)EXIT] to exit the memory channel screen.

• Setting a memory channel as a select memory

Select memory channels are used for select memory scan. Select memory scan repeatedly scans the select memory channels only. This is useful to speedup the memory scan interval. Of course, select memory channels are also scanned during normal memory scan.

- ① Select the memory channel screen as described at left.
- ② Rotate the tuning dial while pushing [(F-2)SET] to select the desired memory channel.
- ③ Push [(F-3)SELECT] to set the memory channel as a select memory or not.

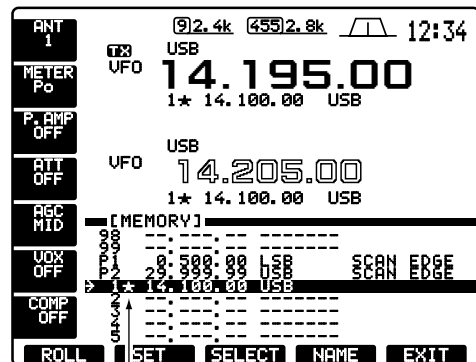

"★" appears for select memory channel.

- ④ Repeat steps ② to ③ to program another memory channel as a select memory channel, if desired.
- ⑤ Push [(F-5)EXIT] to exit the memory channel screen.

NOTE: Setting select memory channels is also possible in the scan screen.

Memory channel programming

Memory channel programming can be performed either in VFO mode or in memory mode.

• Programming in VFO mode

- ① Set the desired frequency and operating mode in VFO mode.
- ② Push [▲]/[▼] several times to select the desired memory channel.
 - Memory channel screen is convenient for selecting the desired channel.
 - Memory channel contents appear in the memory channel readout (below the frequency readout).
 - “---” appears if the selected memory channel is a blank channel (and does not have contents).
- ③ Push [MW] for 2 sec. to program the displayed frequency and operating mode into the memory channel.

[EXAMPLE]: Programming 7.088 MHz/LSB into memory channel 12.

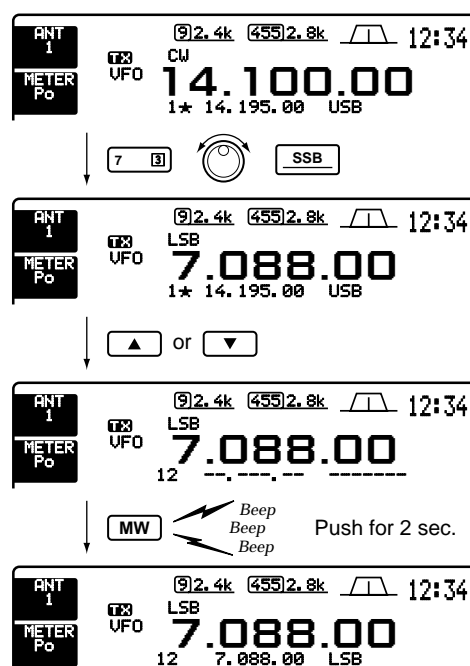

• Programming in memory mode

- ① Select the desired memory channel with [▲]/[▼] in memory mode.
 - Memory channel contents appear in the memory channel readout (below the frequency readout).
 - “ . . . ” appears if the selected memory channel is a blank channel (and does not have contents).
- ② Set the desired frequency and operating mode in memory mode.
 - To program a blank channel, use direct frequency entry with the keypad or memo pads, etc.
- ③ Push [MW] for 2 sec. to program the displayed frequency and operating mode into the memory channel.

[EXAMPLE]: Programming 21.280 MHz/USB into memory channel 18.

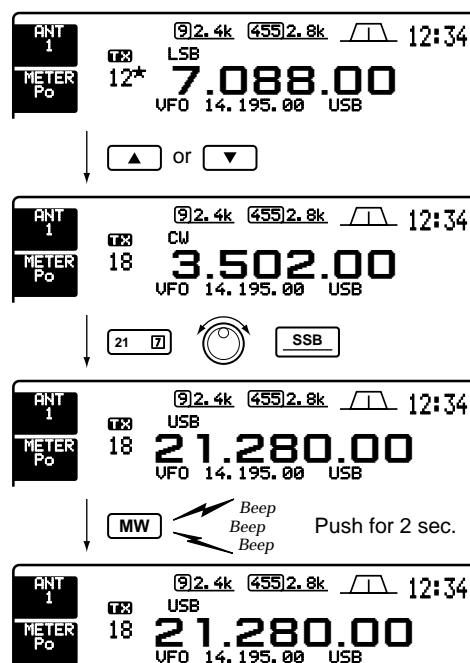

■ Frequency transferring

The frequency and operating mode in a memory channel can be transferred to the VFO.

Frequency transferring can be performed in either VFO mode or memory mode.

•Transferring in VFO mode

This is useful for transferring programmed contents to VFO.

- ① Select VFO mode with [VFO/MEMO].
- ② Select the memory channel to be transferred with [▲]/[▼].
 - Memory channel screen is convenient for selecting the desired channel.
 - Memory channel contents appear in the memory channel readout (below the frequency readout).
 - “---,---,---” appears if the selected memory channel is a blank channel. In this case transferring is impossible.
- ③ Push [VFO/MEMO] for 2 sec. to transfer the frequency and operating mode.
 - Transferred frequency and operating mode appear on the frequency readout.

TRANSFERRING EXAMPLE IN VFO MODE

Operating frequency : 21.320 MHz/USB (VFO)
 Contents of M-ch 16 : 14.018 MHz/CW

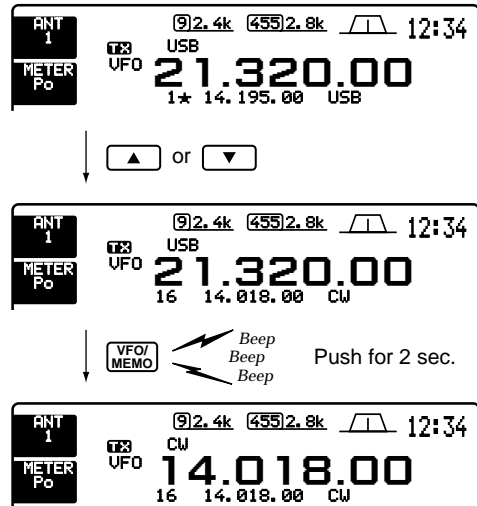

•Transferring in memory mode

This is useful for transferring frequency and operating mode while operating in memory mode.

NOTE: When you have changed the frequency or operating mode in the selected memory channel:
 - **Displayed** frequency and mode are transferred.
 - **Programmed** frequency and mode in the memory channel are not transferred, and they remain in the memory channel.

- ① Select the memory channel to be transferred with [▲]/[▼] in memory mode.
 - And, set the frequency or operating mode if required.
- ② Push [VFO/MEMO] for 2 sec. to transfer the frequency and operating mode.
 - Displayed frequency and operating mode are transferred to the VFO.
- ③ To return to VFO mode, push [VFO/MEMO] momentarily.

TRANSFERRING EXAMPLE IN MEMORY MODE

Operating frequency : 14.020 MHz/CW (M-ch 16)
 Contents of M-ch 16 : 14.018 MHz/CW

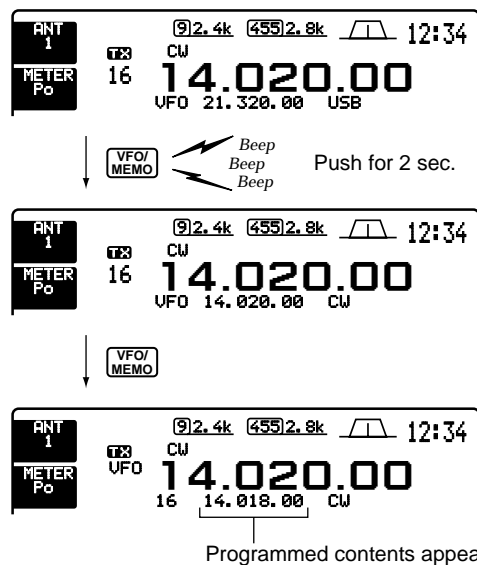

Memory names

All memory channels (including scan edges) can be tagged with alphanumeric names of up to 10 characters each.

Letters (capitals), numerals, some symbols (/, ?, *) and spaces can be used.

Editing (programming) memory names

- ① If the start up screen is not selected (if [F-5]'s function is [EXIT]), push [F-5] one or more times to exit.
- ② Push [(F-3)MEMORY] to select the memory channel screen.

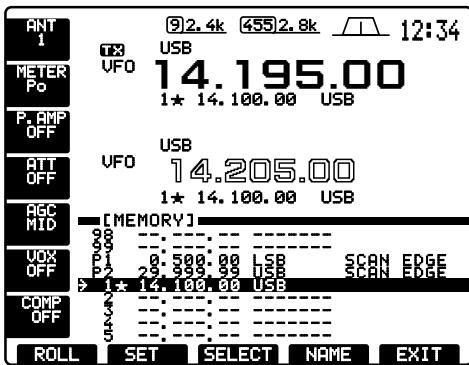

- ③ Select the desired memory channel.

- ④ Push [(F-4)NAME] to edit memory channel name.
 - A cursor appears and blinks.
 - Memory channel names of blank channels cannot be edited.

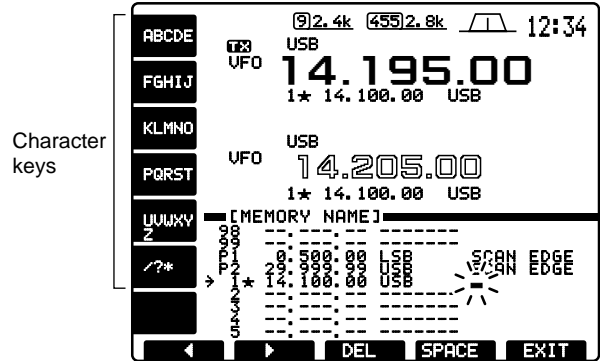

- ⑤ Input the desired character by pushing the character keys (as shown above) one or more times or by pushing the band key for number input.
 - Push [(F-1)◀] or [(F-2)▶] for cursor movement.
 - Push [(F-3)DEL] to delete the selected character.
 - Push [(F-4)SPACE] to input a space.
- ⑥ Push [(F-5)EXIT] to input the set the name.
 - The cursor disappears.
- ⑦ Repeat steps ③ to ⑥ to program another memory channel's name, if desired.
- ⑧ Push [(F-5)EXIT] to exit the memory channel screen.

Memory clearing

Any unnecessary memory channels can be cleared. The cleared memory channels become blank channels.

- ① Select memory mode with [VFO/MEMO].
- ② Select the desired memory channel with [▲]/[▼].
- ③ Push [M-CL] for 2 sec. to clear the contents.
 - The programmed frequency and operating mode disappear.
- ④ To clear other memory channels, repeat steps ② and ③.

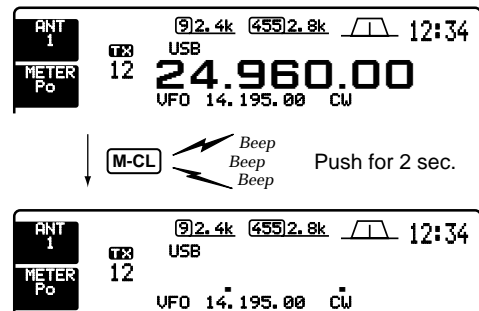

■ Memo pads

The transceiver has a memo pad function to store frequency and operating mode for easy write and recall. The memo pads are separate from memory channels.

The default number of memo pads is 5, however, this can be increased to 10 in set mode if desired. (p. 59)

Memo pads are convenient when you want to memorize a frequency and operating mode temporarily, such as when you find a DX station in a pile-up or when a desired station is busy for a long time and you want to temporarily search for other stations.

Use the transceiver's memo pads instead of relying on hastily scribbled notes that are easily misplaced.

• Writing frequencies and operating modes into memo pads

You can simply write the accessed readout frequency and operating mode by pushing [MP-W].

When you write a 6th frequency and operating mode, the oldest written frequency and operating mode are automatically erased to make room for the new settings.

NOTE: Each memo pad must have its own unique combination of frequency and operating mode; memo pads having identical settings cannot be written.

Displayed frequency and mode

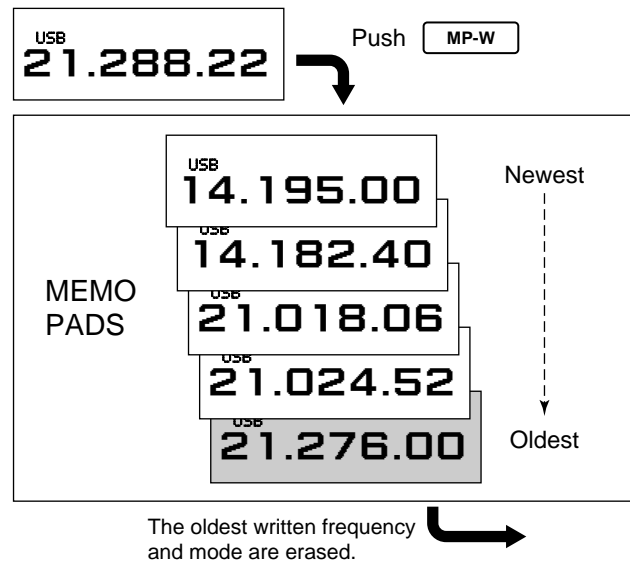

• Calling up a frequency from a memo pad

You can simply call up the desired frequency and operating mode of a memo pad by pushing [MP-R] one or more times.

- Both VFO and memory modes can be used.
- The frequency and operating mode are called up, starting from the most recently written.

When you call up a frequency and an operating mode from memo pads with [MP-R], the previously displayed frequency and operating mode are automatically stored in a temporary pad. The frequency and operating mode in the temporary pad can be recalled by pushing [MP-R] one or more times.

- You may think there are 6 memo pads because 6 different frequencies (5 are in memo pads and 1 is in the temporary pad) are called up by [MP-R].

NOTE: If you change the frequency or operating mode called up from a memo pad with the tuning dial, etc., the frequency and operating mode in the temporary pad are erased.

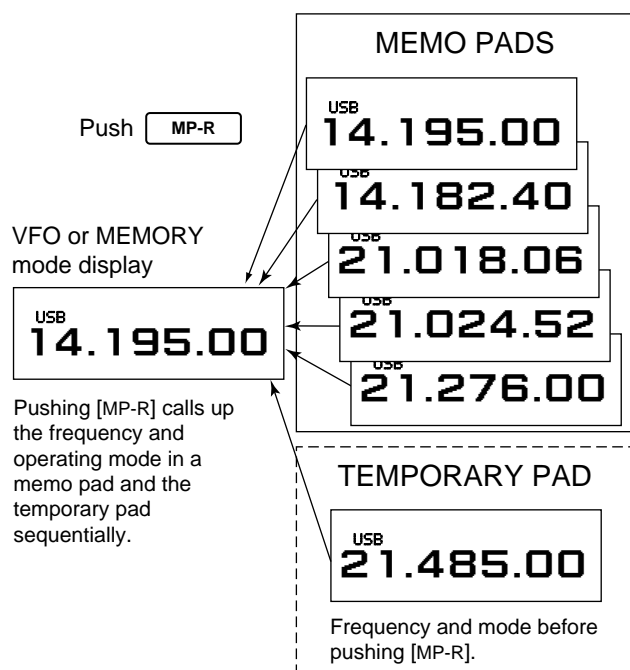

Scan types

- The scan function can be used on the main readout only.
- You can operate a scan while operating on a frequency using the dualwatch or split functions. See p. 30 for details.

PROGRAMMED SCAN

Repeatedly scans between two scan edge frequencies (scan edge memory channels P1 and P2).

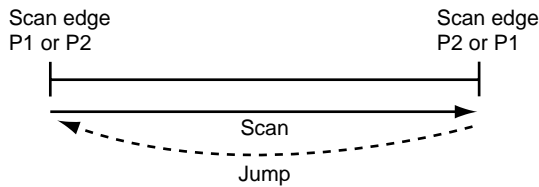

This scan operates in VFO mode.

ΔF SCAN

Repeatedly scans within ΔF span area.

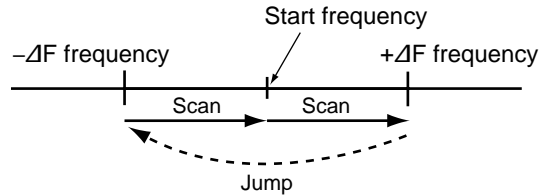

This scan operates in both VFO and memory modes.

MEMORY SCAN

Repeatedly scans all programmed memory channels.

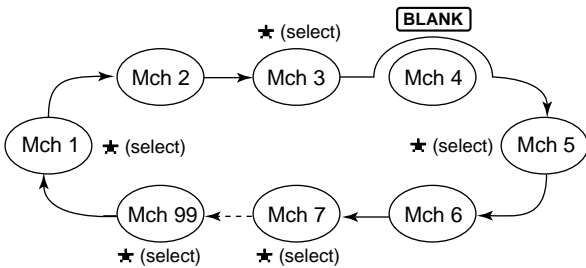

This scan operates in memory mode.

SELECT MEMORY SCAN

Repeatedly scans all select memory channels.

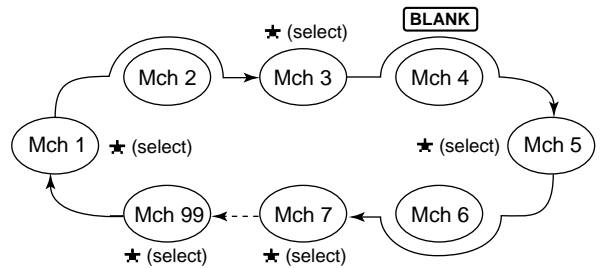

This scan operates in memory mode.

Preparation

Channels

For programmed scan:

Program scan edge frequencies into scan edge memory channels P1 and P2.

For ΔF scan:

Set the ΔF span (ΔF scan range) in the scan screen.

For memory scan:

Program 2 or more memory channels except scan edge memory channels.

For select memory scan:

Designate 2 or more memory channels as select memory channels. To designate the channel as a select memory channel, select a memory channel, then push [(F-3)SELECT] in the scan screen (memory mode) or in the memory channel screen.

Scan resume ON/OFF

You can select the scan to resume or cancel when detecting a signal, in set mode. Scan resume ON/OFF must be set before operating a scan. See p. 56 for ON/OFF setting and scan resume condition details.

Scan speed

Scan speed can be selected from 2 levels, high or low, in set mode. See p. 56 for details.

Squelch condition

| SCAN STARTS WITH | PROGRAMMED SCAN | MEMORY SCAN |
|------------------|--|--|
| SQUELCH OPEN | The scan continues until it is stopped manually, and does not pause even if it detects signals. | Scan pauses on each channel when the scan resume is ON; not applicable when OFF. |
| SQUELCH CLOSED | Scan stops when detecting a signal. If you set scan resume ON in set mode, the scan pauses for 10 sec. when detecting a signal, then resumes. When a signal disappears while scan is paused, scan resumes 2 sec. later. | |

■ Programmed scan operation

- ① If the start up screen is not selected (if [F-5]'s function is [EXIT]), push [F-5] one or more times to exit.
- ② Select VFO mode.
- ③ Select the desired operating mode.
 - The operating mode can also be changed while scanning.
- ④ Push [(F-4)SCAN] to select the scan screen.

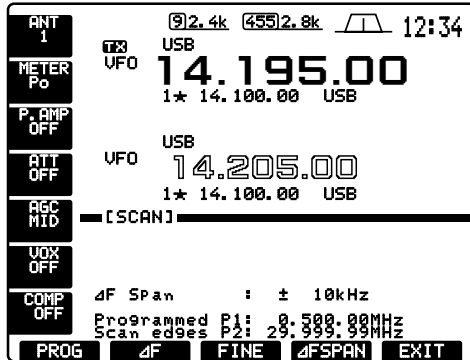

- ⑤ Set [RF/SQ] open or closed.
 - See previous page for scan condition.
 - If the [RF/SQ] control function is set as RF control, the squelch always opens. See pgs. 2, 56 for details.

- ⑥ Push [(F-1)PROG] to start the programmed scan.
 - Decimal points blink while scanning.



- ⑦ When the scan detects a signal, the scan stops, pauses or ignores it depending on the resume setting and the squelch condition.
- ⑧ To cancel the scan, push [(F-1)PROG].

/// **NOTE:** If the same frequencies are programmed into the scan edge memory channel P1 and P2, programmed scan does not start.

■ ΔF scan operation

- ① If the start up screen is not selected (if [F-5]'s function is [EXIT]), push [F-5] one or more times to exit.
- ② Select VFO mode or a memory channel.
- ③ Select the desired operating mode.
 - The operating mode can also be changed while scanning.
- ④ Push [(F-4)SCAN] to select the scan screen.

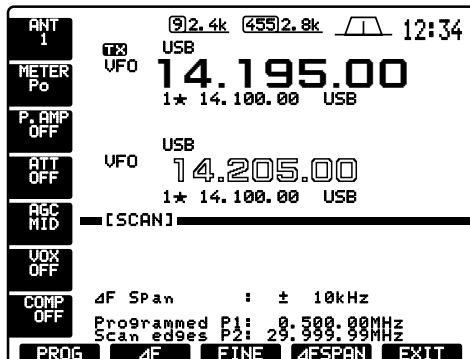

- ⑤ Set [RF/SQ] open or closed.
 - See previous page for scan condition.
 - If the [RF/SQ] control function is set as RF control, the squelch always opens. See pgs. 2, 56 for details.

- ⑥ Set the ΔF span by pushing [(F-4)ΔF SPAN].
- ⑦ Set center frequency of the ΔF span.
- ⑧ Push [(F-2)ΔF] to start the ΔF scan.
 - Decimal points blink while scanning.

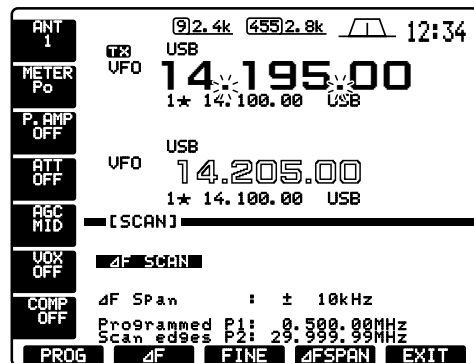

- ⑨ When the scan detects a signal, the scan stops, pauses or ignores it depending on the resume setting and the squelch condition.
- ⑩ To cancel the scan, push [(F-2)ΔF].

Fine programmed scan/fine ΔF scan

Fine scan functions as programmed or ΔF scan, but scan speed decreases when the squelch opens and does not stop. The scanning tuning step shifts from 50 Hz to 10 Hz while the squelch opens.

- ① Select the scan screen from the start up screen by pushing [(F-4)SCAN].
- ② Set for programmed scan or ΔF scan as described on previous page.
- ③ Push [(F-1)PROG] or [(F-2)ΔF] to start a scan.
- Decimal points blink while scanning.

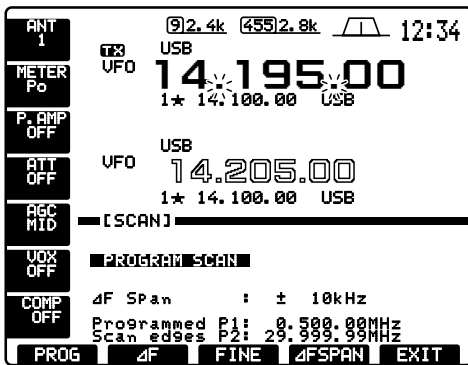

- ④ Push [(F-3)FINE] to start a fine scan.
- "FINE PROGRAM SCAN" or "FINE ΔF SCAN" appears.

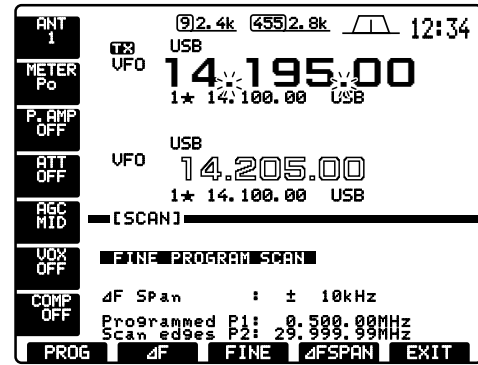

- ⑤ When the scan detects a signal, the scan speed decreases but does not stop.
- ⑥ Push [(F-1)PROG] or [(F-2)ΔF] to stop the scan; push [(F-3)FINE] to cancel the fine scan.

Memory scan operation

- ① If the start up screen is not selected (if [F-5]'s function is [EXIT]), push [F-5] one or more times to exit.
- ② Select memory mode.
- ③ Select the desired operating mode.
- The operating mode can also be changed while scanning.
- ④ Push [(F-4)SCAN] to select the scan screen.

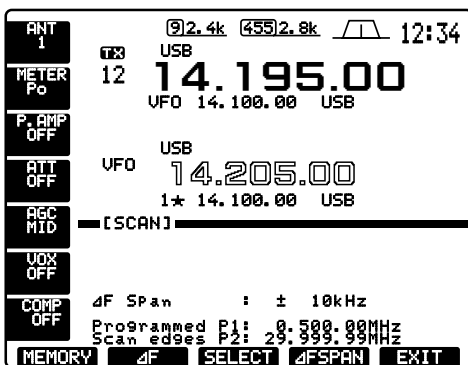

- ⑥ Push [(F-1)MEMORY] to start the memory scan.
- Decimal points blink while scanning.

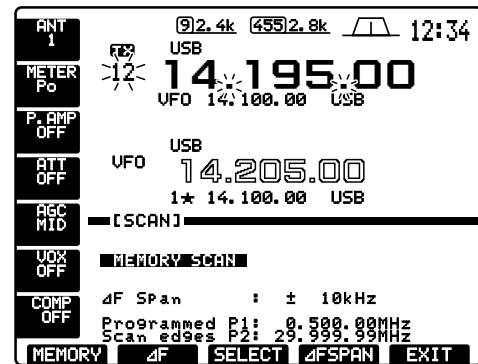

- ⑤ Set [RF/SQL] open or closed.
- See p. 47 for scan condition.
- If the [RF/SQL] control function is set as RF control, the squelch always opens. See pgs. 2, 56 for details.

- ⑦ When the scan detects a signal, the scan stops, pauses or ignores it depending on the resume setting and the squelch condition.
- ⑧ To cancel the scan, push [(F-1)MEMORY].

NOTE: 2 or more memory channels must be programmed for memory scan to start.

■ Select memory scan operation

- ① If the start up screen is not selected (if [F-5]'s function is [EXIT]), push [F-5] one or more times to exit.
- ② Select memory mode.
- ③ Select the desired operating mode.
 - The operating mode can also be changed while scanning.
- ④ Push [(F-4)SCAN] to select the scan screen.

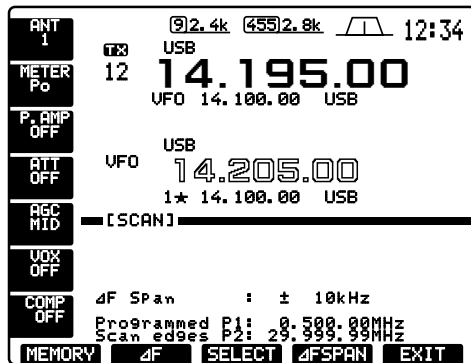

- ⑤ Set [RF/SQL] open or closed.
 - See p. 47 for scan condition.
 - If the [RF/SQL] control function is set as RF control, the squelch always opens. See pgs. 2, 56 for details.

- ⑥ Push [(F-1)MEMORY] to start the memory scan.
 - Decimal points blink while scanning.
- ⑦ Push [(F-3)SELECT] to start select memory scan; push [(F-3)SELECT] again to return to memory scan, if desired.

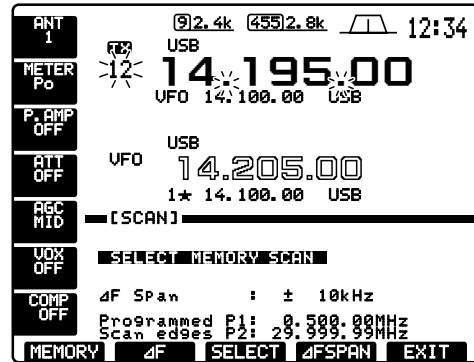

- ⑧ When the scan detects a signal, the scan stops, pauses or ignores it depending on the resume setting and the squelch condition.
- ⑨ To cancel the scan, push [(F-1)MEMORY].

/// **NOTE:** 2 or more memory channels must be designated as select memory channels for select memory scan to start.

■ Setting select memory channels

- ① If the start up screen is not selected (if [F-5]'s function is [EXIT]), push [F-5] one or more times to exit.
- ② Select memory mode.
- ③ Push [(F-4)SCAN] to select the scan screen.

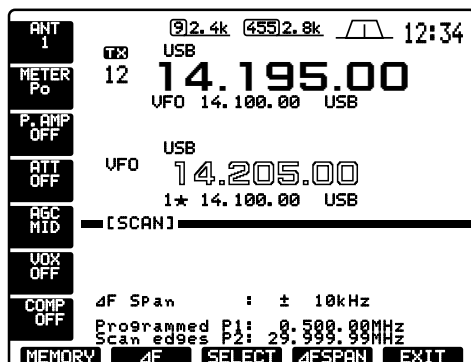

- ④ Select the desired memory channel to set as select memory channel.

- ⑤ Push [(F-3)SELECT] to set the memory channel as a select memory or not.

“★” appears for select memory channels.

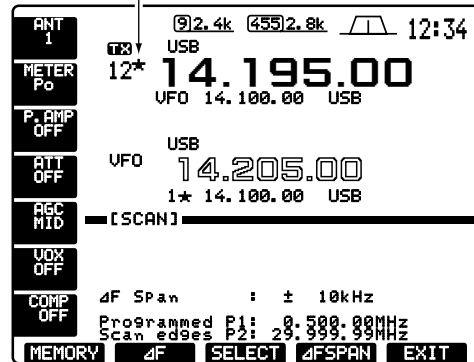

- ⑥ Repeat steps ④ to ⑤ to program another memory channel as a select memory channel, if desired.
- ⑦ Push [(F-5)EXIT] to exit the scan screen.

/// **NOTE:** Select memory channels can also be set in the memory channel screen. (p. 42)

Setting the current time

The transceiver has a built-in 24-hour clock with power-off and power-on timer functions. This is useful when logging QSO's and so on. The clock indication is always displayed except after pushing [F-INP].

- ① If the start up screen is not selected (if [F-5]'s function is [EXIT]), push [F-5] one or more times to exit.
- ② Push [(F-5)SET] then [(F-3)TIME] to enter timer set mode.
- ③ Push [(F-1)▲] or [(F-2)▼] to select the time adjustment item.

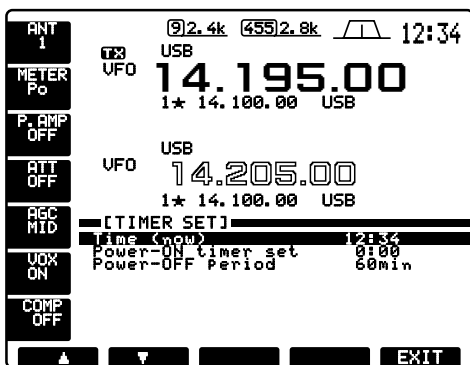

- ④ Set the current time using the tuning dial.
 - "TIME – set push [SET]" blinks.

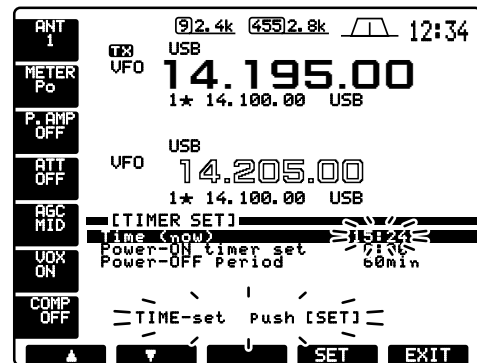

- ⑤ Push [(F-4)SET] to enter the set time.
 - Push [(F-5)EXIT] to cancel the setting.

Set time appears.

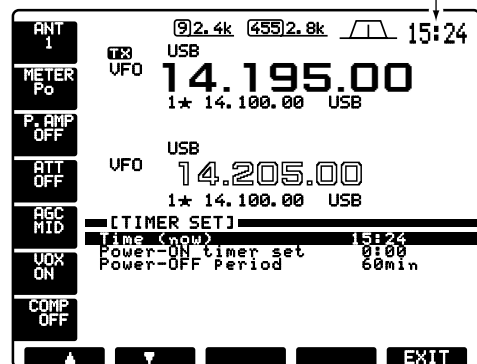

- ⑥ Push [(F-5)EXIT] twice to exit timer set mode.

Setting power-on time

The transceiver can be set to turn ON automatically at a specified time.

- ① If the start up screen is not selected (if [F-5]'s function is [EXIT]), push [F-5] one or more times to exit.
- ② Push [(F-5)SET] then [(F-3)TIME] to enter timer set mode.
- ③ Push [(F-1)▲] or [(F-2)▼] to select the power-on time item.



- ④ Set the desired power-on time using the tuning dial.
 - "TIMER – set push [SET]" blinks.

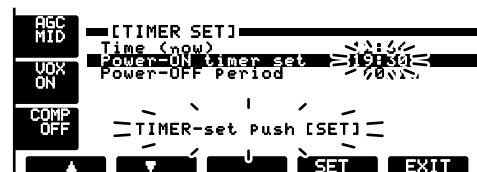

- ⑤ Push [(F-4)SET] to enter the set time.
 - Push [(F-5)EXIT] to cancel the setting.
- ⑥ Push [(F-5)EXIT] twice to exit timer set mode.

■ Setting power-off period

The transceiver can be set to turn OFF automatically after being activated via the power-on timer. The power-off period can be set to 5–120 min. in 5 min. steps.

- ① If the start up screen is not selected (if [F-5]'s function is [EXIT]), push [F-5] one or more times to exit.
- ② Push [(F-5)SET] then [(F-3)TIME] to enter timer set mode.
- ③ Push [(F-1)▲] or [(F-2)▼] to select the power-off period item.



- ④ Set the desired power-off periods using the tuning dial.

- "TIMER – set push [SET]" blinks.



- ⑤ Push [(F-4)SET] to enter the set time.
- Push [(F-5)EXIT] to cancel the setting.
- ⑥ Push [(F-5)EXIT] twice to exit timer set mode.

■ Timer operation

- ① Preset the power-on time and power-off period as described previously.
- ② Push [POWER] momentarily to turn the timer function ON.
- The [POWER] light lights when the timer function is ON.

[POWER]

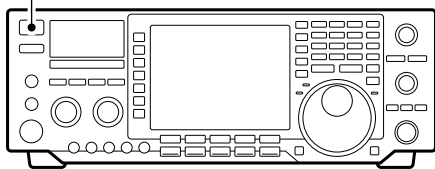

- ③ Push [POWER] for 2 sec. to turn the power OFF.
- The [POWER] light lights continuously.

- ④ When the set time arrives, the power is automatically turned ON.
- ⑤ The transceiver emits 10 beeps and turns OFF after the power-off period elapses.
- The [POWER] light blinks while beeping.
- Push [POWER] momentarily to cancel the power-off timer, if desired.

■ Set mode description

Set mode is used for programming infrequently changed values or conditions of functions. This transceiver has a level set mode, display set mode, timer set mode and miscellaneous (others) set mode.

•Set mode operation

- ① If the start up screen is not selected (if [F-5]'s function is [EXIT]), push [F-5] one or more times to exit.
- ② Push [(F-5)SET] to select the set mode screen.
- ③ Push [(F-1)LEVEL], [(F-2)DISP], [(F-3)TIME] or [(F-4)OTHERS] to enter the desired set mode.
- ④ Push [(F-1)▲] or [(F-2)▼] to select the desired item.
- ⑤ Set the desired condition using the tuning dial.
 - Push [(F-3)DEF] to select a default condition or value.
- ⑥ For timer set mode, push [(F-4)SET] to enter the set time.
- ⑦ Push [(F-5)EXIT] twice to exit the set mode.

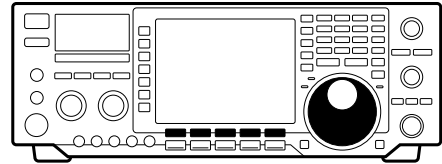

•Start up screen

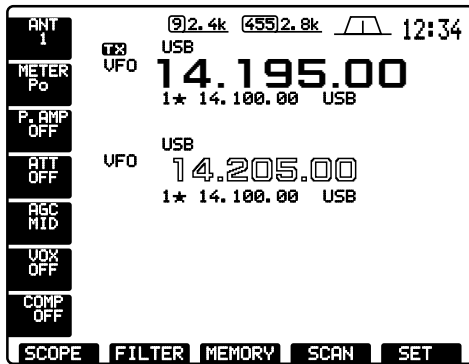

•Set mode screen

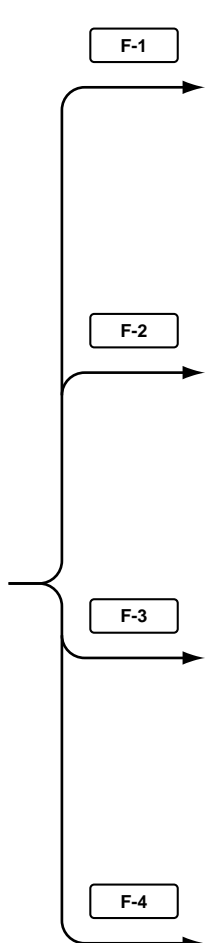
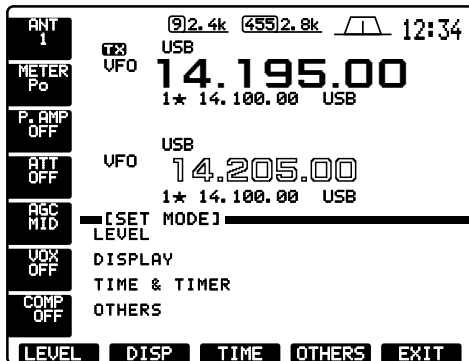

•Level set mode (p. 54)



•Display set mode (p. 54)



•Timer set mode (pgs. 51, 55)



•Miscellaneous (others) set mode (p. 55)



■ Level set mode

Tx tone (Bass)

This item adjusts the bass level of the transmit audio tone in SSB/AM mode from -12 dB to +12 dB in 2 dB steps.

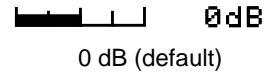

Tx tone (Treble)

This item adjusts the treble level of the transmit audio tone in SSB/AM mode from -12 dB to +12 dB in 2 dB steps.

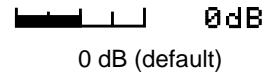

Monitor

This item adjusts the CW side tone and transmit IF signal monitor level from 0 % to 100 % in 1 % steps.

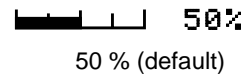

See p. 33 for details.

Beep

This item adjusts the volume level for confirmation beep tones from 0 % to 100 % in 1 % steps.

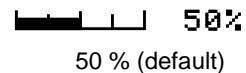

■ Display set mode

NOTE: To adjust the LCD contrast or backlight, wait until the LCD becomes stable (10 min. or more after turning power ON). This is an inherent characteristic of LCDs and LCD backlights and does not indicate a transceiver malfunction.

Contrast (LCD)

This item adjusts the contrast of the LCD from 0 % to 100 % in 1 % steps.

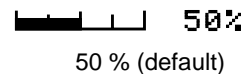

Backlight (LCD)

This item adjusts the brightness of the LCD from 0 % to 100 % in 1 % steps.

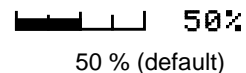

Backlight (switches)

This item adjusts the brightness of the switches from 1 to 8.

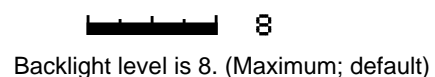

■ Timer set mode

Time (now)

This item sets the current time for the built-in 24-hour clock.

15:00

Push [(F-4)SET] to enter the time.

See p. 51 for details.

Power-ON timer set

This item sets the power-on time.

15:00

Push [(F-4)SET] to enter the time.

See p. 51 for details.

Power-OFF Period

This item sets the power-off period for automatic shut-down after the power-on timer has turned power ON.

60min

Push [(F-4)SET] to enter the time.

See p. 52 for details.

■ Miscellaneous (others) set mode

Calibration marker

This item is used for a simple frequency check of the transceiver.

ON

Calibration marker ON

OFF

Calibration marker OFF (default)

See p. 65 for calibration procedure.

▨ Turn the calibration marker OFF after checking the frequency of the transceiver.

Filter (9MHz)

When an optional 9 MHz filter is installed, this selection is necessary, otherwise, the filter cannot be selected.

NONE

No optional 9 MHz filter is installed. (default)

FL-223

FL-223 optional filter is installed.

FL-223, FL-100, FL-232, FL-101 and "NONE" are selectable. See p. 28 for details.

FL-100

FL-100 optional filter is installed.

Filter (455kHz)

When an optional 455 kHz filter is installed, this selection is necessary, otherwise, the filter cannot be selected.

NONE

No optional 455 kHz filter is installed. (default)

FL-222

FL-222 optional filter is installed.

FL-222, FL-52A, FL-53A and "NONE" are selectable. See p. 28 for details.

FL-52A

FL-52A optional filter is installed.

■ Miscellaneous (others) set mode (continued)

| | | |
|---|---|--|
| <p>Beep (confirmation)</p> <p>A beep sounds each time a switch is pushed to confirm it. This function can be turned OFF for silent operation.</p> <p>The volume level can be set in level set mode. (p. 54)</p> | <p>ON</p> <p>Confirmation beep ON (default)</p> | <p>OFF</p> <p>Confirmation beep OFF</p> |
| <p>Beep (band edge)</p> <p>A beep sounds when an operating frequency enters or exits an amateur band. This functions independent of the confirmation beep setting (above).</p> <p>The volume level can be set in level set mode. (p. 54)</p> | <p>ON</p> <p>Band edge beep ON (default)</p> | <p>OFF</p> <p>Band edge beep OFF</p> |
| <p>Scan speed</p> <p>The transceiver has 2 speeds for scanning, high and low.</p> <p>See p. 47 for scanning details.</p> | <p>HIGH</p> <p>High speed (default)</p> | <p>LOW</p> <p>Low speed</p> |
| <p>Scan resume</p> <p>This item sets the scan resume function ON or OFF. <i>ON</i>: scan resumes 10 sec. after stopping on a signal (or 2 sec. after a signal disappears); <i>OFF</i>: scan does not resume after stopping on a signal.</p> <p>See p. 47 for scanning details.</p> | <p>ON</p> <p>Scan resume ON (default)</p> | <p>OFF</p> <p>Scan resume OFF</p> |
| <p>RF/SQL control</p> <p>The [RF/SQL] control can be set as the RF/squelch control (default), the RF gain control only (squelch is fixed as open) or squelch control (RF gain is fixed at maximum).</p> <p>See p. 2 for details.</p> | <p>RF+SQL</p> <p>[RF/SQL] control as RF/squelch control (default)</p> <p>RF</p> <p>[RF/SQL] control as RF gain control</p> <p>SQL</p> <p>[RF/SQL] control as squelch control</p> | |
| <p>Quick dualwatch</p> <p>When this item is set to ON, pushing [DUALWATCH] for 2 sec. sets the sub readout frequency to the main readout frequency and activates dualwatch operation.</p> <p>See p. 30 for details.</p> | <p>ON</p> <p>Quick dualwatch ON (default)</p> | <p>OFF</p> <p>Quick dualwatch OFF</p> |
| <p>Quick split</p> <p>When this item is set to ON, pushing [SPLIT] for 2 sec. sets the sub readout frequency to the main readout frequency and activates split operation.</p> <p>See p. 32 for details.</p> | <p>ON</p> <p>Quick split ON (default)</p> | <p>OFF</p> <p>Quick split OFF</p> |

■ Miscellaneous (others) set mode (continued)

FM sPlit offset (HF)

This item sets the offset (difference between transmit and receive frequencies) for the quick split function. However, this setting is used for HF bands in FM mode only and is used to input the repeater offset for an HF band.

The offset frequency can be set from -4 MHz to +4 MHz in 1 kHz steps.

-0.100MHz

Minus 0.1 MHz offset
(default)

-4.000MHz

Minus 4.0 MHz offset

FM sPlit offset (50M)

This item sets the offset (difference between transmit and receive frequencies) for the quick split function. However, this setting is used for 50 MHz band FM mode only and is used to input the repeater offset for the 50 MHz band.

The offset frequency can be set from -4 MHz to +4 MHz in 1 kHz steps.

-1.000MHz

Minus 1.0 MHz offset
(default)

+4.000MHz

Plus 4.0 MHz offset

FM subaudible tone

This item selects a subaudible tone for FM-T mode operation to access a repeater. There are 50 tones available from 67.0 Hz to 254.1 Hz (see table at right).

88.5Hz

88.5 Hz subaudible tone
(default)

254.1Hz

254.1 Hz subaudible tone

• Available subaudible tones

(Unit: Hz)

| | | | | | | |
|------|-------|-------|-------|-------|-------|-------|
| 67.0 | 88.5 | 114.8 | 151.4 | 177.3 | 203.5 | 250.3 |
| 69.3 | 91.5 | 118.8 | 156.7 | 179.9 | 206.5 | 254.1 |
| 71.9 | 94.8 | 123.0 | 159.8 | 183.5 | 210.7 | |
| 74.4 | 97.4 | 127.3 | 162.2 | 186.2 | 218.1 | |
| 77.0 | 100.0 | 131.8 | 165.5 | 189.9 | 225.7 | |
| 79.7 | 103.5 | 136.5 | 167.9 | 192.8 | 229.1 | |
| 82.5 | 107.2 | 141.3 | 171.3 | 196.6 | 233.6 | |
| 85.4 | 110.9 | 146.2 | 173.8 | 199.5 | 241.8 | |

sPlit lock

When this item is ON the tuning dial can be used to adjust the transmit frequency while pushing [XFC] even while the lock function is activated.

See p. 31 for split frequency operation details.

ON

Split lock function ON

OFF

Split lock function OFF
(default)

Tuner (auto start)

The internal antenna tuner has an automatic start capability which starts tuning if the SWR is higher than 1.5–3 in the HF bands.

When "OFF" is selected, the tuner remains OFF even when the SWR is poor (1.5–3). When "ON" is selected, automatic tune starts even when the tuner is turned OFF.

ON

Automatic tuner start
ON

OFF

Automatic tuner start
OFF (default)

■ Miscellaneous (others) set mode (continued)

| | | |
|--|---|--|
| <p>Tuner (PTT start)</p> <p>Tuning of the internal antenna tuner can be started automatically at the moment the PTT is pushed after the operating frequency is changed (more than 1% from last-tuned frequency).</p> | <p>ON</p> <p>Automatic PTT start ON</p> | <p>OFF</p> <p>Automatic PTT start OFF (default)</p> |
| <p>[ANT] switch</p> <p>You can set the antenna connector selection to automatic, manual or non-selection (when using 1 antenna only).</p> <p>When "AUTO" is selected, the antenna switch is activated and the band memory memorizes the selected antenna. See p. 37 for details.</p> <p>When "MANUAL" is selected, the antenna switch is activated and selects an antenna manually.</p> <p>When "OFF" is selected, the antenna switch is not activated and does not function. The [ANT1] connector is always selected in this case.</p> | <p>AUTO</p> <p>MANUAL</p> <p>OFF</p> | <p>Antenna switch is activated and the selection is automatically memorized. (default)</p> <p>Antenna switch is activated.</p> <p>Antenna switch is deactivated and [ANT1] is always selected.</p> |
| <p>RTTY mark freq.</p> <p>This item selects the RTTY mark frequency. RTTY mark frequency is toggled between 1275, 1615 and 2125 Hz.</p> | <p>2125</p> <p>2125 Hz RTTY mark frequency (default)</p> | <p>1275</p> <p>1275 Hz RTTY mark frequency</p> |
| <p>RTTY shift width</p> <p>This item adjusts the RTTY shift width. There are 3 selectable values: 170, 200 and 425 Hz.</p> | <p>170</p> <p>170 Hz RTTY shift frequency (default)</p> | <p>425</p> <p>425 Hz RTTY shift frequency</p> |
| <p>RTTY keying polarity</p> <p>This item selects the RTTY keying polarity. Normal or reverse keying polarity can be selected.</p> <p>When reverse polarity is selected, Mark and Space are reversed.</p> <ul style="list-style-type: none"> - Normal : Key open/close = Mark/Space - Reverse : Key open/close = Space/Mark | <p>NORMAL</p> <p>Normal polarity (default)</p> | <p>REVERSE</p> <p>Reverse polarity</p> |

■ Miscellaneous (others) set mode (continued)

Scope during tx

The spectrum scope shows the transmit signal waveform while transmitting. This can be deactivated if desired.

When "OFF" is selected, the spectrum scope holds the received waveform while transmitting and does not show the transmit waveform.

ON

Spectrum scope displays the transmit waveform (default)

OFF

Spectrum scope does not display the transmit waveform

Speech synthesizer

When the optional UT-102 VOICE SYNTHESIZER UNIT is installed, you can select between English and Japanese as the language.

See p. 61 for unit installation.

English

English announcement (default)

Japanese

Japanese announcement

Speech speed

When the optional UT-102 VOICE SYNTHESIZER UNIT is installed, you can select between faster or slower synthesizer output.

See p. 61 for unit installation.

HIGH

Faster announcement (default)

LOW

Slower announcement

Speech S-level

When the optional UT-102 VOICE SYNTHESIZER UNIT is installed, you can have frequency, mode and signal level announcement. Signal level announcement can be deactivated if desired.

When "OFF" is selected, the signal level is not announced.

See p. 61 for unit installation.

ON

Signal level announcement (default)

OFF

No signal level announcement

Memo Pad numbers

This item sets the number of memo pad channels available. 5 or 10 memo pads can be set.

5

5 memo pads (default)

10

10 memo pads

Mic UP/down speed

This item sets the rate at which frequencies are scanned when the microphone [UP]/[DN] switches are pushed and held. High or low can be selected.

HIGH

High speed (default, 50 tuning steps/sec.)

LOW

Low speed (25 tuning steps/sec.)

■ Miscellaneous (others) set mode (continued)

| | | |
|---|--|---|
| <p>CI-V baud rate</p> <p>This item sets the data transfer rate. 300, 1200, 4800, 9600, 19200 bps and "AUTO" are available.</p> <p>When "AUTO" is selected, the baud rate is automatically set according to the connected controller or remote controller.</p> | <p>AUTO</p> <p>Auto baud rate (default)</p> | <p>19200</p> <p>19200 bps</p> |
| <p>CI-V address</p> <p>To distinguish equipment, each CI-V transceiver has its own Icom standard address in hexadecimal code. The IC-756's address is 50h.</p> <p>When 2 or more IC-756's are connected to an optional CT-17 CI-V LEVEL CONVERTER, rotate the tuning dial to select a different address for each IC-756 in the range 01h to 7Fh.</p> | <p>50h</p> <p>Address of 50h (default)</p> | <p>7Fh</p> <p>Address of 7Fh</p> |
| <p>CI-V transceive</p> <p>Transceive operation is possible with the IC-756 connected to other Icom HF transceivers or receivers.</p> <p>When "ON" is selected, changing the frequency, operating mode, etc. on the IC-756 automatically changes those of connected transceivers (or receivers) and vice versa.</p> | <p>ON</p> <p>Transceive ON (default)</p> | <p>OFF</p> <p>Transceive OFF</p> |
| <p>CI-V with IC-731</p> <p>When connecting the IC-756 to the IC-735 for transceive operation, you must change the operating frequency data length to 4 bytes.</p> <ul style="list-style-type: none"> • This item must be set to "ON" only when operating transceiver with the IC-735. | <p>OFF</p> <p>5 bytes of frequency data (default)</p> | <p>ON</p> <p>4 bytes of frequency data</p> |

Opening the transceiver's case

Follow the case and cover opening procedures shown here when you want to install an optional unit or adjust the internal units, etc.

CAUTION: DISCONNECT the DC power cable from the transceiver before performing any work on the transceiver. Otherwise, there is danger of electric shock and/or equipment damage.

- 1 Remove 2 screws from the left side of the transceiver to remove the carrying handle as shown below.

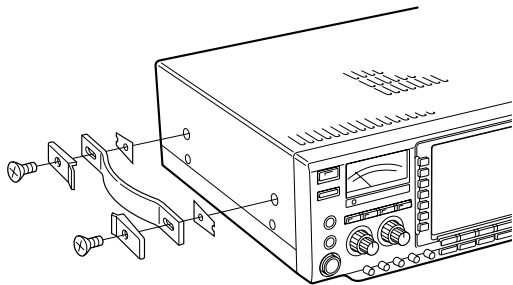

- 2 Remove 7 screws from the top of the transceiver and 4 screws from the sides, then lift up the top cover.
- 3 Turn the transceiver upside down.
- 4 Remove 6 screws from the bottom of the transceiver, then lift up the bottom cover.

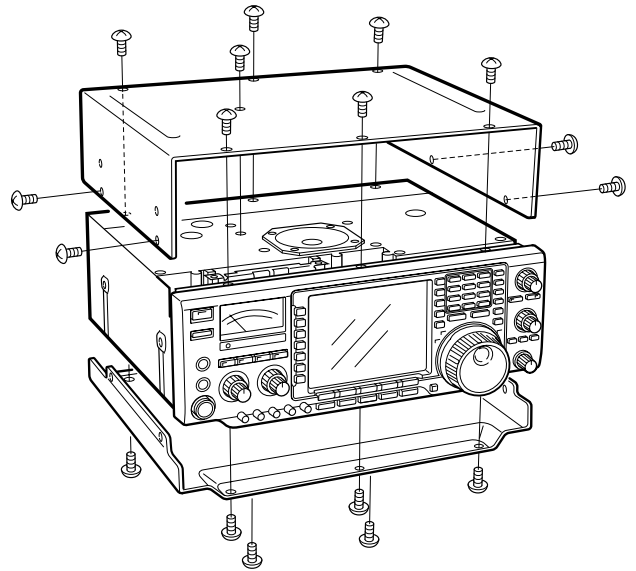

UT-102 VOICE SYNTHESIZER UNIT

The UT-102 announces the accessed readout's frequency, mode, etc. (S-meter level can also be announced—p. 59) in a clear, electronically-generated voice, in English (or Japanese).

- 1 Remove the top and bottom covers as shown above.
- 2 Remove the protective paper attached to the bottom of the UT-102 to expose the adhesive strip.
- 3 Plug UT-102 into J801 (SPEECH UT-102) on the MAIN unit as shown in the diagram at right.
- 4 Adjust R572 to set the speech level if desired. Refer to inside views on p. 66.
- 5 Return the top and bottom covers to their original positions.

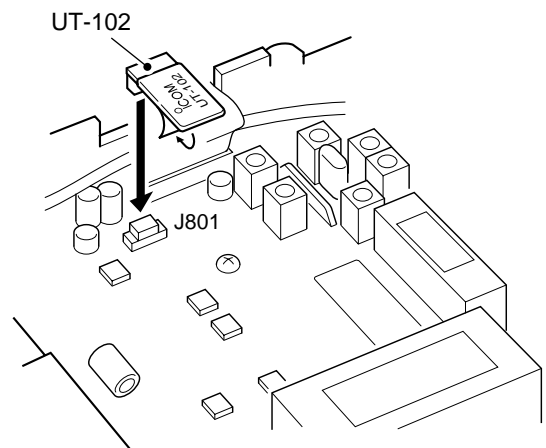

■ Optional IF filters

Several IF filters are available for the IC-756. You can install 2 filters for 9 MHz and 455 kHz IF. Choose appropriate filter(s) for your operating needs.

9 MHz optional filters:

| | |
|--------------------------|---------------|
| FL-100 CW NARROW FILTER | 500 Hz/−6 dB |
| FL-101 CW NARROW FILTER | 250 Hz/−6 dB |
| FL-223 SSB NARROW FILTER | 1.9 kHz/−6 dB |
| FL-232 CW NARROW FILTER | 350 Hz/−6 dB |

455 kHz optional filters:

| | |
|--------------------------|---------------|
| FL-52A CW NARROW FILTER | 500 Hz/−6 dB |
| FL-53A CW NARROW FILTER | 250 Hz/−6 dB |
| FL-222 SSB NARROW FILTER | 1.8 kHz/−6 dB |
| FL-257 SSB WIDE FILTER | 3.3 kHz/−6 dB |

- Remove the top and bottom covers as shown on the opposite page.
- Turn the transceiver upside down. Install the desired filter as shown in the diagram at right.
 - The 9 MHz filters can be installed in either direction.
- Replace the top and bottom covers.

NOTE: After filter installation, specify the installed filter using set mode. (p. 55) Otherwise, the installed filter will not function properly.

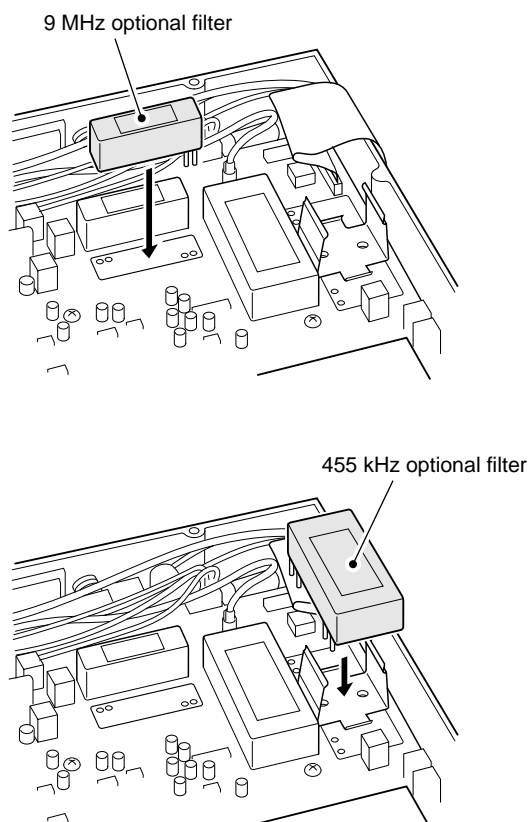

■ CR-502 HIGH STABILITY CRYSTAL UNIT

By installing the CR-502, the total frequency stability of the transceiver will be improved.

- Remove the top and bottom covers as shown on the opposite page.
- Turn the transceiver upside down. Remove 6 screws from the PLL shielding plate, then remove the plate.
- Cut the leads of R56 and L55 (in a shielded box) on the PLL unit.
- Put the CR-502 in the space available as shown in the diagram, then solder its feet into place (6 points).
- Adjust the reference frequency using a frequency counter.
- Return the shield case, shield plate and top/bottom covers to their original positions.

CR-502 frequency stability: ± 0.5 ppm
 (−30°C to +60°C;
 −22°F to +140°F)

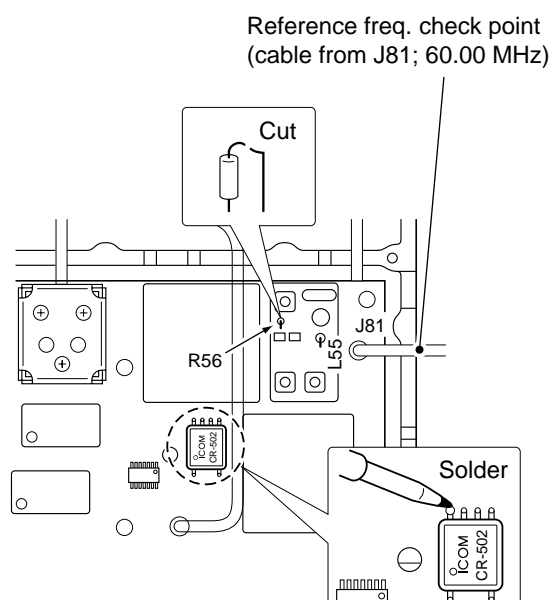

10 MAINTENANCE

■ Troubleshooting

The following chart is designed to help you correct problems which are not equipment malfunctions.

If you are unable to locate the cause of a problem or solve it through the use of this chart, contact your nearest Icom Dealer or Service Center.

| | PROBLEM | POSSIBLE CAUSE | SOLUTION | REF. |
|-------------------------------------|---|--|---|--|
| POWER | Power does not come on when the [POWER] switch is pushed. | <ul style="list-style-type: none"> • DC power cable is improperly connected. • Fuse is blown. | <ul style="list-style-type: none"> • Reconnect the DC power cable correctly. • Check for the cause, then replace the fuse with a spare one. (Fuses are installed in the DC power cable and the internal PA unit.) | p. 16 p. 64 |
| | RECEIVE | No sound comes from the speaker. | <ul style="list-style-type: none"> • Volume level is too low. • The squelch is closed. • The transceiver is in the transmitting condition. | <ul style="list-style-type: none"> • Rotate [AF] clockwise to obtain a suitable listening level. • Rotate [RF/SQL] to 10 o'clock position to open the squelch. • Push [TRANSMIT] to receive or check the SEND line of an external unit, if desired. |
| Sensitivity is low. | | <ul style="list-style-type: none"> • The antenna is not connected properly. • The antenna for another band is selected. • The antenna is not properly tuned. • The attenuator is activated. | <ul style="list-style-type: none"> • Reconnect to the antenna connector. • Select an antenna suitable for the operating frequency. • Push [TUNER] for 2 sec. to manually tune the antenna. • Push [ATT] one or more times to select "ATT OFF." | — p. 3 p. 39 p. 3 |
| Receive audio is distorted. | | <ul style="list-style-type: none"> • The operating mode is not selected correctly. • PBT function is activated. • Noise blanker function is activated. • Preamp is activated. • The noise reduction is activated and the [NR] control is set too far clockwise. | <ul style="list-style-type: none"> • Select a suitable operating mode. • Set [TWIN PBT] to the center position. • Push [NB] to turn the function OFF. • Push [P.AMP] once or twice to turn the function OFF. • Set the [NR] control for maximum readability. | p. 25 p. 25 p. 26 p. 3 p. 26 |
| The [ANT] switch does not function. | | <ul style="list-style-type: none"> • The antenna switch has not been activated. | <ul style="list-style-type: none"> • Set the antenna switch in set mode to "AUTO" or "MANUAL." | p. 58 |
| TRANSMIT | Transmitting is impossible. | <ul style="list-style-type: none"> • The operating frequency is not set to a ham band. | <ul style="list-style-type: none"> • Set the frequency to a ham band. | p. 23 |
| | Output power is too low. | <ul style="list-style-type: none"> • [RF POWER] is set too far counterclockwise. • [MIC GAIN] is set too far counterclockwise. • The antenna for another band is selected. • The antenna is not properly tuned. | <ul style="list-style-type: none"> • Rotate [RF POWER] clockwise. • Set [MIC GAIN] to a suitable position. • Select an antenna suitable for the operating frequency. • Push [TUNER] for 2 sec. to manually tune the antenna. | p. 2 p. 1 p. 3 p. 39 |
| | No contact possible with another station. | <ul style="list-style-type: none"> • RIT or ΔTX function is activated. • Split frequency function and/or dualwatch are activated. | <ul style="list-style-type: none"> • Push [RIT] or [ΔTX] to turn the function OFF. • Push [SPLIT] and/or [DUALWATCH] to turn the function OFF. | p. 5 pgs. 4, 30, 31 |
| | Transmitted signals are distorted. | <ul style="list-style-type: none"> • [MIC GAIN] is set too far clockwise. | <ul style="list-style-type: none"> • Set [MIC GAIN] to a suitable position. | p. 1 |
| | Repeater cannot be accessed. | <ul style="list-style-type: none"> • Split frequency function is not activated. • Programmed subaudible tone frequency is wrong. | <ul style="list-style-type: none"> • Push [SPLIT] to turn the function ON. • Reset the frequency using set mode. | p. 4 p. 57 |
| SCAN | Programmed scan does not stop. | <ul style="list-style-type: none"> • Squelch is open. • [RF/SQL] is assigned to RF gain control and squelch is open. | <ul style="list-style-type: none"> • Set [RF/SQL] to the threshold point. • Reset [RF/SQL] control assignment and set it to the threshold point. | p. 2 pgs. 2, 56 |
| | Programmed scan does not start. | <ul style="list-style-type: none"> • The same frequencies have been programmed in scan edge memory channels P1 and P2. | <ul style="list-style-type: none"> • Program different frequencies in scan edge memory channels P1 and P2. | p. 43 |
| | Memory scan does not start. | <ul style="list-style-type: none"> • 2 or more memory channels have not been programmed. | <ul style="list-style-type: none"> • Program 2 or more memory channels. | p. 43 |
| | Select memory scan does not start. | <ul style="list-style-type: none"> • 2 or more memory channels have not been designated as select channels. | <ul style="list-style-type: none"> • Designate 2 or more memory channels as select channels for the scan. | pgs. 42, 50 |

| | PROBLEM | POSSIBLE CAUSE | SOLUTION | REF. |
|---------|---|---|--|------------------------------|
| DISPLAY | The displayed frequency does not change properly. | <ul style="list-style-type: none"> • The dial lock function is activated. • A set mode screen is selected. • The internal CPU has malfunctioned. | <ul style="list-style-type: none"> • Push [LOCK] to deactivate the function. • Push [(F-5)EXIT] one or more times to exit the set mode screen. • Reset the CPU. | p. 5 pgs. 10, 53 p. 21 |

■ Fuse replacement

If a fuse blows or the transceiver stops functioning, try to find the source of the problem, and replace the damaged fuse with a new, rated fuse.

CAUTION: Disconnect the DC power cable from the transceiver when changing a fuse.

The IC-756 has 2 types of fuses installed for transceiver protection.

- DC power cable fuses FGB 20 A
- Circuitry fuse FGB 5 A

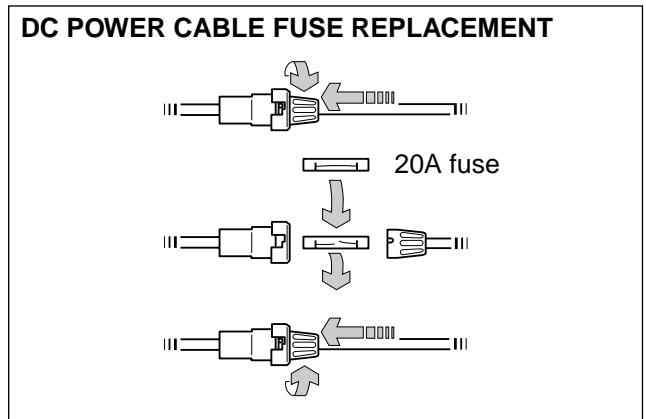

CIRCUITRY FUSE REPLACEMENT

The 13.8 V DC from the DC power cable is applied to all units in the IC-756, except for the power amplifier, through the circuitry fuse. This fuse is installed in the PA unit.

- ① Remove the top cover as shown on p. 61.
- ② Remove 11 screws from the PA shielding plate, then remove the plate.

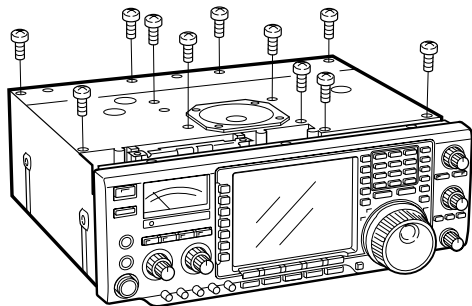

- ③ Replace the circuitry fuse as shown in the diagram below.
- ④ Replace the PA shielding plate and top cover.

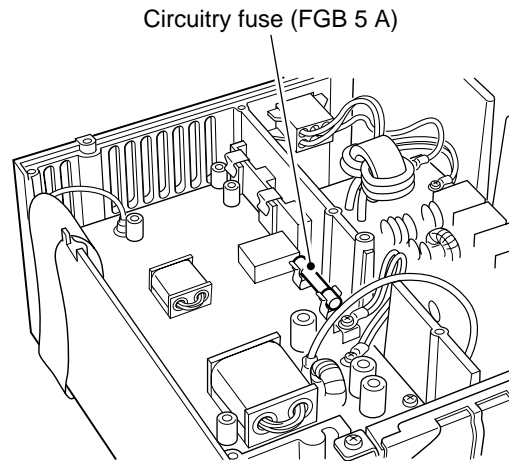

■ Clock backup battery replacement

The transceiver has a lithium backup battery on the inside of the front panel for clock and timer functions. The usual life of the backup battery is approximately 5 years.

When the backup battery is exhausted, the transceiver transmits and receives normally but cannot retain the current time.

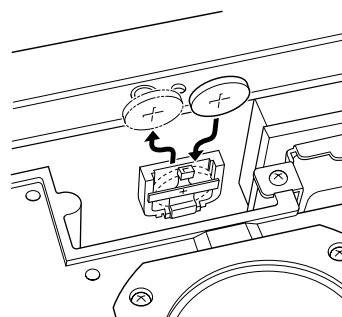

■ Tuning dial brake adjustment

The tension of the tuning dial may be adjusted to suit your preference.

The brake adjustment screw is located on the right side of the tuning dial. See the figure at right.

Turn the brake adjustment screw clockwise or counterclockwise to obtain a comfortable tension level while turning the dial continuously and evenly in one direction.

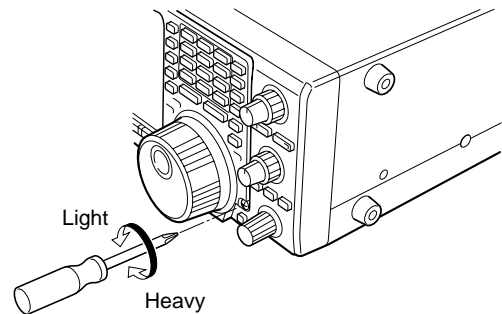

■ Frequency calibration (approximate)

A very accurate frequency counter is required to calibrate the frequency of the transceiver. However, a rough check may be performed by receiving radio station WWV, or other standard frequency signals.

CAUTION: Your transceiver has been thoroughly adjusted and checked at the factory before being shipped. You should not calibrate frequencies, except for special reasons.

- ① Push [SSB] to select USB mode. Make sure the [TWIN PBT] controls are set to the center position and RIT/ΔTX function is not activated.
- ② Set the frequency to the standard frequency station minus 1 kHz.
 - When receiving WWV (10.000.00 MHz) as a standard frequency, set the operating frequency for 9.999.00 MHz.
 - Other standard frequencies can also be used.

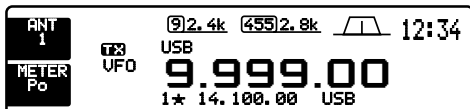

- ③ If the start up screen is not selected (if [F-5]'s function is [EXIT]), push [F-5] one or more times to exit.
- ④ Push [(F-5)SET] to select the set mode screen.
- ⑤ Push [(F-4)OTHERS] to enter miscellaneous (others) set mode.

- ⑥ Push [(F-1)▲] several times to select the "Calibration marker" item.
- ⑦ Rotate the tuning dial clockwise to turn the calibration marker ON.
 - Side tone may be heard.



- ⑧ Adjust the calibration pot on the right side panel of the transceiver for a zero beat with the received standard signal as shown below.
 - Zero beat means that two signals are exactly the same frequency, resulting in a single tone being emitted.

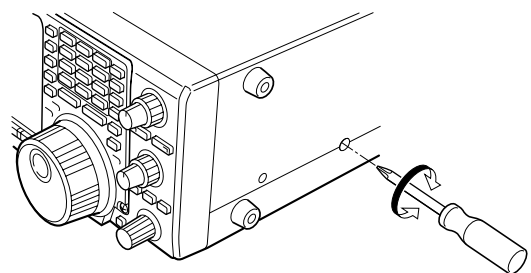

- ⑨ Rotate the tuning dial counterclockwise to turn the calibration marker OFF.
- ⑩ Push [(F-5)EXIT] twice to exit set mode.

• **Top view**

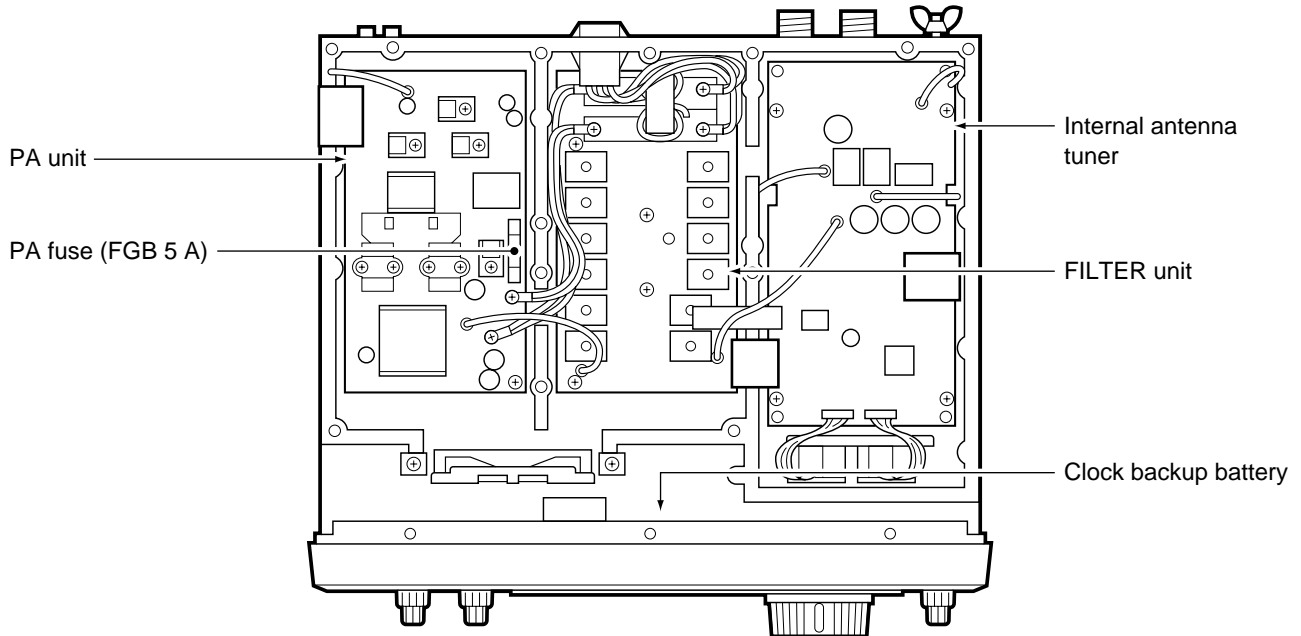

• **Bottom view**

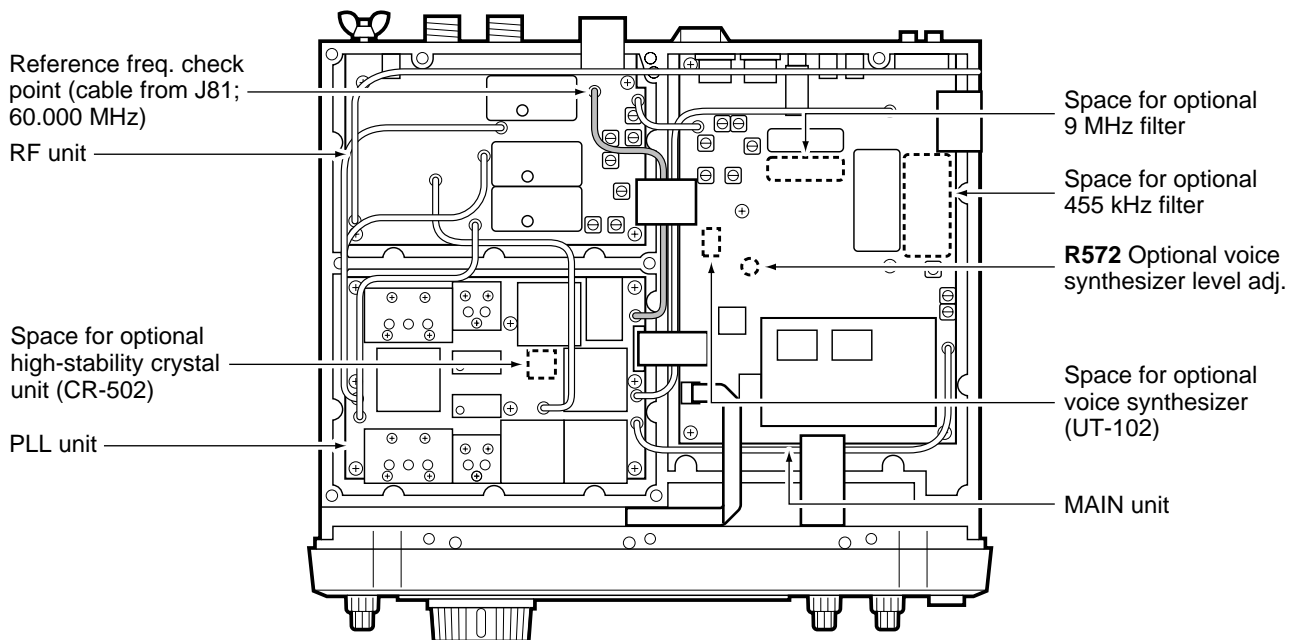

12 SPECIFICATIONS

■ General

- Frequency coverage:
 - Receive 0.030–60.000 MHz^{*1}
 - Transmit 1.800– 1.999 MHz^{*2}
 - 3.500– 3.999 MHz^{*2}
 - 7.000– 7.300 MHz^{*2}
 - 10.100–10.150 MHz
 - 14.000–14.350 MHz
 - 18.068–18.168 MHz
 - 21.000–21.450 MHz
 - 24.890–24.990 MHz
 - 28.000–29.700 MHz
 - 50.000–54.000 MHz^{*2}
- ^{*1} Some frequency bands are not guaranteed.
- ^{*2} 1.830–1.850, 3.500–3.800, 7.000–7.100, 50.200–51.200 for France version.
- Mode : USB, LSB, CW, RTTY, AM, FM
- Number of memory channels : 101 (99 regular, 2 scan edges)
- Antenna connector : PL-239×2 and phono (RCA, 50 Ω)
- Usable temperature range : –10°C to 60°C (14°F to 140°F)
- Frequency stability : Less than ±200 Hz from 1 min. to 60 min. after power ON. After that rate of stability less than ±30 Hz/hr. at +25°C (+77°F). Temperature fluctuations 0°C to +50°C (+32°F to +122°F) less than ±350 Hz.
- Frequency resolution : 1 Hz
- Power supply : 13.8 V ± 15% (negative ground) requirement
- Current consumption :

| | | |
|----------|------------|-------|
| Transmit | max. power | 20 A |
| Receive | standby | 2.5 A |
| | max. audio | 2.7 A |
- Dimensions : 340(W)×111(H)×285(D) mm
13³/₈(W)×4³/₈(H)×11⁷/₃₂(D) in
- Weight : 10.5 kg (23 lb 2 oz)
- CI-V connector : 2-conductor 3.5(d) mm (1/8")

■ Transmitter

- Output power (continuously adjustable):
 - SSB/CW/RTTY/FM 2–100 W
 - AM 1–40 W
- Modulation system :
 - SSB, AM PSN modulation
 - FM Variable reactance modulation
- Spurious emissions : 50 dB (HF bands)
60 dB (50 MHz band)
- Carrier suppression : 40 dB
- Unwanted sideband suppression : 55 dB
- ΔTX variable range : ±9.999 kHz

- Microphone connector: 8-pin connector (600 Ω)
- ELEC-KEY connector : 3-conductor 6.35(d) mm (1/4")
- KEY connector : 3-conductor 6.35(d) mm (1/4")
- SEND connector : Phono (RCA)
- ALC connector : Phono (RCA)

■ Receiver

- Intermediate frequencies:

| | SSB | CW, RTTY | AM | FM |
|------------|-------------|-------------|-------------|-------------|
| 1st | 69.0115 MHz | 69.0106 MHz | 69.0100 MHz | 69.0115 MHz |
| 2nd | 9.0115 MHz | 9.0106 MHz | 9.0100 MHz | 9.0115 MHz |
| 3rd | 455 kHz | 455 kHz | 455 kHz | 455 kHz |
| 4th | 15.625 kHz | 15.625 kHz | 15.625 kHz | — |

- Sensitivity :
 - SSB, CW, RTTY 0.16 μV (1.80–29.99 MHz)^{*1}
(10 dB S/N) 0.13 μV (50.0–54.0 MHz)^{*2}
 - AM 13 μV (0.5–1.799 MHz)
(10 dB S/N) 2 μV (1.80–29.99 MHz)^{*1}
 - FM 0.5 μV (28.0–29.99 MHz)^{*1}
(12 dB SINAD) 0.32 μV (50.0–54.0 MHz)^{*2}
- ^{*1} Pre-amp 1 ON; ^{*2} Pre-amp 2 ON
- Squelch sensitivity (threshold):
 - SSB, CW, RTTY Less than 5.6 μV
 - FM Less than 1.0 μV
- Selectivity :
 - SSB, CW, RTTY More than 2.4 kHz/–6 dB
Less than 3.8 kHz/–60 dB
 - AM More than 9.0 kHz/–6 dB
Less than 20 kHz/–60 dB
 - FM More than 15 kHz/–6 dB
Less than 30 kHz/–60 dB
- Spurious and image rejection ratio : More than 70 dB
(except IF through in 50 MHz band)
- ΔRIT variable range : ±9.999 kHz
- Audio output power : More than 2.0 W at 10%
distortion with an 8 Ω load
- PHONES connector : 3-conductor 6.35(d) mm (1/4")
- EXT SP connector : 2-conductor 3.5(d) mm (1/8")/
8 Ω

■ Antenna tuner

- Matching impedance range:
 - HF bands 16.7 to 150 Ω unbalanced
(Less than VSWR 3:1)
 - 50 MHz band 20 to 125 Ω unbalanced
(Less than VSWR 2.5:1)
- Minimum operating input power : 8 W (HF bands)
15 W (50 MHz band)
- Tuning accuracy : VSWR 1.5:1 or less
- Insertion loss : Less than 1.0 dB
(after tuning)

IC-4KL HF 1 kW LINEAR AMPLIFIER

Full-duty 1 kW linear amplifier including an automatic antenna tuner. Has automatic tuning and band selection capability. Full break-in (QSK) operation is possible. The amplifier/power supply unit and the remote control unit are separated.

EX-627 AUTOMATIC ANTENNA SELECTOR

Automatically selects the antenna for the selected HF ham band. Manual selection is possible for the 50 MHz band.
•Max. input power: 1000 W PEP

AH-3 HF AUTOMATIC ANTENNA TUNER

Specially designed to tune a long wire antenna for portable or mobile HF operation. The PTT tuner start function provides simple operation.
•Input power rating: 150 W

AH-2b ANTENNA ELEMENT

A 2.5 m long antenna element for mobile operation with the AH-3.

- Frequency coverage: 3.5–28 MHz bands with the AH-3

PS-85 DC POWER SUPPLY

Light weight switching regulator system power supply.
•Output voltage: 13.8 V DC
•Max. current drain: 20 A

SM-20 DESKTOP MICROPHONE

Unidirectional, electret microphone for base station operation. Includes [UP]/[DOWN] switches and a low cut function.

FL-100, FL-101 FL-223 and FL-232 9 MHz FILTERS

- FL-100: 500 Hz/–6 dB (CW nar.)
- FL-101: 250 Hz/–6 dB (CW nar.)
- FL-223: 1.9 kHz/–6 dB (SSB nar.)
- FL-232: 350 Hz/–6 dB (RTTY/CW nar.)

FL-52A, FL-53A, FL-222 and FL-257 455 kHz FILTERS

- FL-52A: 500 Hz/–6 dB (CW nar.)
- FL-53A: 250 Hz/–6 dB (CW nar.)
- FL-222: 1.8 kHz/–6 dB (SSB nar.)
- FL-257: 3.3 kHz/–6 dB (SSB wide)

IC-2KL HF 500 W LINEAR AMPLIFIER

All solid-state 500 W linear amplifier. The power amplifier unit can be separately set-up from the power supply unit.

IC-AT500 HF AUTOMATIC ANTENNA TUNER

500 W automatic antenna tuner. Includes an automatic antenna selector for 4 separate antennas.

SM-8 DESKTOP MICROPHONE

Electret condenser-type desktop microphone including 2 connection cables for simultaneous connection of 2 transceivers. [UP] and [DOWN] switches are included.

HM-36 HAND MICROPHONE

Hand microphone equipped with the [UP]/[DOWN] switches.

SP-20 EXTERNAL SPEAKER

4 audio filters; headphone jack; can connect to 2 transceivers.

- Input impedance: 8 Ω
- Max. input power: 5 W

SP-21 EXTERNAL SPEAKER

Designed for base station operation.

- Input impedance: 8 Ω
- Max. input power: 5 W

UT-102 VOICE SYNTHESIZER UNIT

Announces operating frequency, mode and S-meter level.

CT-16 SATELLITE INTERFACE UNIT

Easy tuning when connecting another Icom VHF transceiver for instant satellite communications.

CT-17 CI-V LEVEL CONVERTER

For remote transceiver control using a personal computer equipped with an RS-232C port. You can change frequencies, operating mode, memory channels, etc.

CR-502 HIGH-STABILITY CRYSTAL UNIT

Contains a temperature-compensating oven heater and crystal unit for improved frequency stability.

- Frequency stability: ± 0.5 ppm (–30°C to +60°C; –22°F to +140°F)

Count on us!

