

INTRODUCTION

About these Advanced Instructions (PDF format)

These Advanced Instructions describe the details of the IC-7200 features. This PDF formatted manual provides you with convenient functions, as follows.

Move to the previously read page.

Click [Previous view] at the left top on an each page, to move back to the previously read page.

The screen shots at the right column, correspond to the operating instructions and procedures shows both setting and operating example.

Shows the location of keys

When the cursor is moved over a term with a red underline, a red circle appears around the appropriate key(s) on the figure of the transceiver.

Example: When the cursor is moved over TS in the description, a red circle appears around the appropriate key(s).

Shows a term description

When the mouse cursor is moved over a term which is highlighted in yellow, the description of the term is displayed.

The screenshot shows page 3-7 of the manual, titled 'BASIC OPERATION'. It contains two main sections: 'Quick tuning function' and 'Selecting kHz step'. The 'Quick tuning function' section includes a list of steps: 1. Push TS to turn ON the Quick tuning function. 2. Rotate [DIAL] to change the frequency in programmed kHz steps. 3. Push TS again to turn OFF the Quick tuning function. 4. Rotate [DIAL] for normal tuning, if desired. The 'Selecting kHz step' section includes steps: 1. Push TS to turn ON the Quick tuning function. 2. Hold down TS for 1 second to enter tuning step Set mode. 3. Rotate [DIAL] to select the desired tuning step. 4. Push TS to exit the tuning step Set mode. 5. Rotate [DIAL] to change the frequency according to the set tuning step. 6. Push TS to turn OFF the Quick tuning function. The page features two screenshots of the transceiver's LCD display. The first screenshot shows the frequency '44.100.00' and 'VFO A'. The second screenshot shows 'Tuning step Set mode' with '15' and '1K' displayed. A 'Previous view' button is located at the top left. Red circles and lines highlight the 'TS' and '[DIAL]' keys on the transceiver's control panel, corresponding to the instructions. A yellow highlight is placed on the 'tuning step Set mode' text in the second screenshot, with a callout box providing a description: 'Incremental steps to change the operating frequency'.

Icom, Icom Inc. and the Icom logo are registered trademarks of Icom Incorporated (Japan) in Japan, the United States, the United Kingdom, Germany, France, Spain, Russia and/or other countries.

Adobe and Adobe Reader are registered trademark of Adobe Systems Incorporated.

All other products or brands are registered trademarks or trademarks of their respective holders.

INTRODUCTION

Functions and features of Adobe® Reader®

The following functions and features can be used with Adobe® Reader®.

- **Keyword search**

Click “Find (Ctrl+F)” or “Advanced Search (Shift+Ctrl+F)” in the Edit menu to open the search screen. This is convenient when searching for a particular word or phrase in this manual.

*The menu screen may differ, depending on the Adobe® Reader® version.

Click to open the find or search screen or advanced search screen.

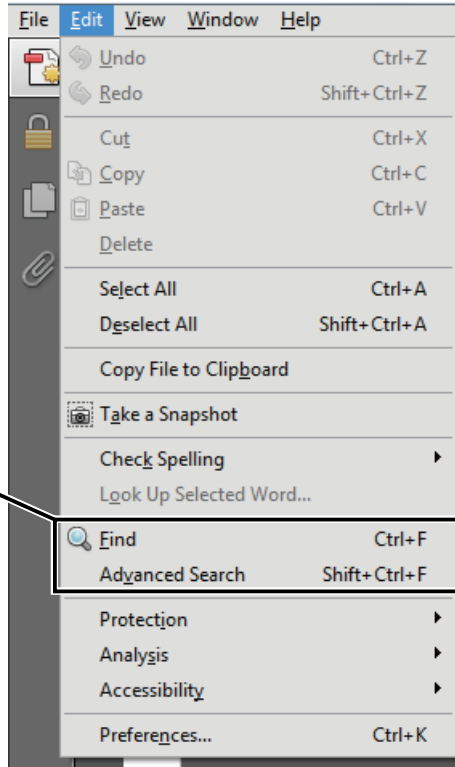

- **Find screen**

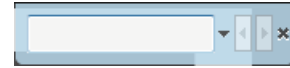

- **Advanced search screen**

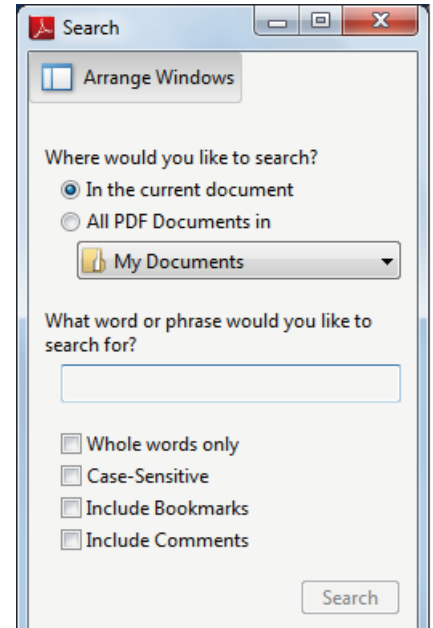

- **Printing out the desired pages.**

Click “Print (P)” in File menu, and then select the paper size and page numbers you want to print.

*The printing setup may differ, depending on the printer. Refer to your printer’s instruction manual for details.

*Select "A4" size to print out the page in the equalized size.

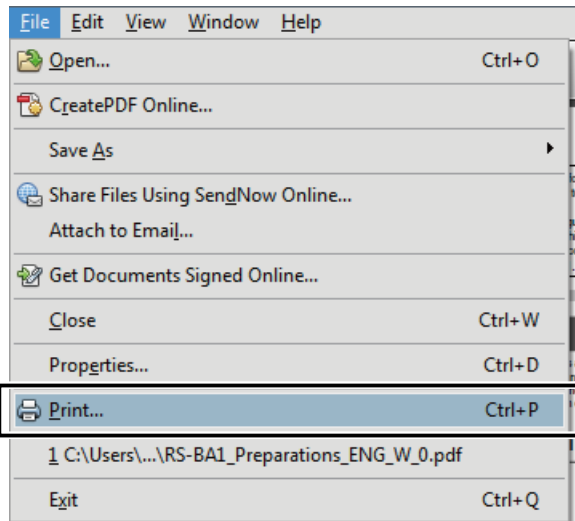

- **Read Out Loud feature.**

The Read Out Loud feature reads aloud the text in this Instruction Manual.

Refer to the Adobe® Reader® Help for the details. (This feature may not be usable, depending on your PC environment including the operating system.)

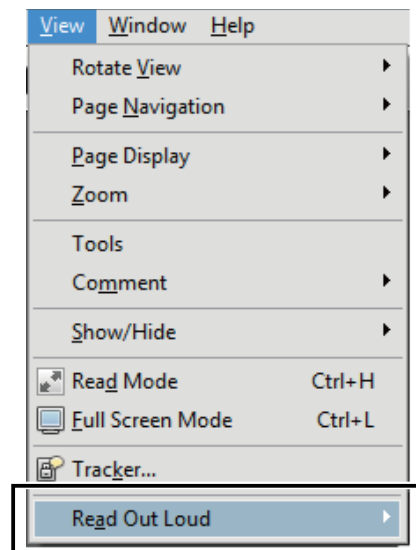

*The screen may differ, depending on the Adobe® Reader® version.

■ Front panel	1-2
◇ Keypad.....	1-9
■ Function display.....	1-12
■ Rear panel.....	1-14
◇ ACC socket information	1-16
■ Microphones.....	1-17
◇ SM-50 (Option)	1-17
◇ SM-30 (Option)	1-17
◇ HM-36.....	1-17

■ Front panel

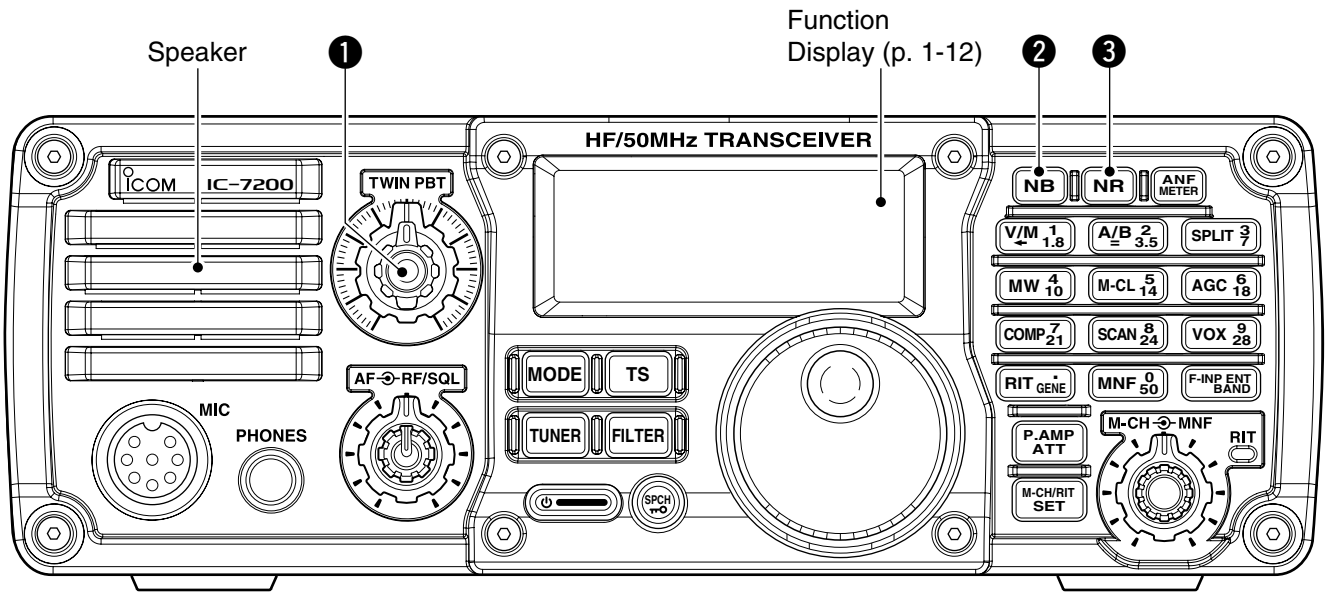

① PASSBAND TUNING CONTROLS [TWIN PBT]

Adjust the receiver's **DSP filter** passband width. (p. 5-4)

- The limit of the variable range depends on the passband width and operating mode. The limit of the variable range is half of the passband width, and PBT is adjustable in 200 Hz (AM) or 50 Hz (other modes) steps.
- Rotating both [TWIN PBT] controls (PBT1 and PBT2) to the same position shifts the **IF** higher or lower.

✓ What is the PBT control?

Generally, the PBT electronically narrows the IF passband width to reject interference. This transceiver uses the DSP circuit for the PBT function.

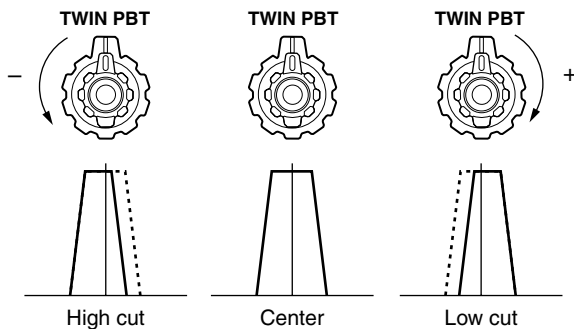
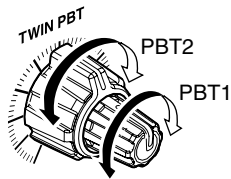

② NOISE BLANKER KEY [NB] (p. 5-7)

- ➔ Push to turn the **noise blanker** function ON or OFF.
 - “[NB]” appears when the noise blanker function is ON.
- ➔ Hold down for 1 second to enter the noise blanker Set mode to set the noise blanker level and blank width; push again to return to normal operation.
 - When entering the noise blanker Set mode, the noise blanker function is automatically turned ON.
 - In the noise blanker Set mode, rotate [M-CH] (7) to select the item, then rotate [DIAL] to set.

✓ What is the noise blanker?

The noise blanker reduces pulse-type noise such as that generated by automobile ignition systems. This function is not effective against non pulse-type noise.

③ NR KEY [NR] (p. 5-8)

- ➔ Push to turn the **noise reduction** function ON or OFF.
 - “[NR]” appears when the noise reduction function is ON.
- ➔ Hold down for 1 second to enter the noise reduction level Set mode; push again to return to normal operation.
 - When entering the noise reduction Set mode, the noise reduction function is automatically turned ON.
 - In the noise reduction Set mode, rotate [DIAL] to set.

✓ What is the Noise Reduction function?

The Noise Reduction (NR) function removes random noise from the receiver passband. The level is adjustable to allow maximum clarity without harming the intelligibility of the desired signal. Noise Reduction should generally not be used in the digital modes.

1 PANEL DESCRIPTION

■ Front panel (Continued)

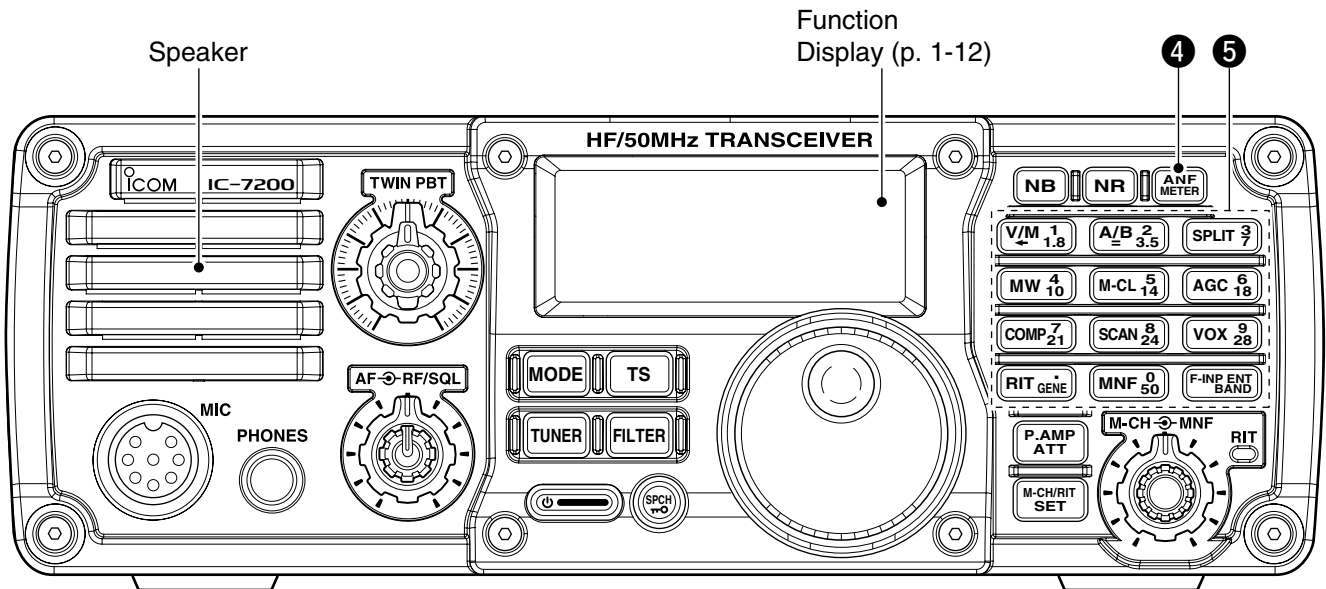





4 ANF/METER KEY (p. 5-9)

- ➔ Push to turn the Automatic **Notch Filter** function ON or OFF in the SSB and AM modes.
 - “ANF” appears when the automatic notch filter function is ON.
- ➔ Hold down for 1 second to toggle the meter function. (pp. 3-13, 6-11)
 - PO → SWR → ALC
 - **PO** : Displays the relative RF output power.
 - **SWR** : Displays the **SWR** of the antenna.
 - **ALC** : Displays the **ALC** level.







✓ **What is the Automatic Notch Filter?**

The Automatic Notch Filter is a narrow **DSP** filter that automatically identifies and attenuates beat tones, tuning signals, CW, and so on, even if they are moving. It removes them from the receiver passband while preserving the desired signal’s audio frequency response.

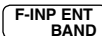
5 KEYPAD

- ➔ Push the keys to select various functions. Details on each function are listed on page 1-9.
- ➔ After holding down  for 1 second, push a key on the keypad to select the operating **band**. (p. 3-4)
 - After the band has been used once, the last used frequency is recalled when the band is selected again.
 -  selects the general coverage receive band.
- ➔ After pushing , push a key on the keypad to enter a frequency. After entering, push  again. (p. 3-6)

- For example To enter 14.195 MHz;

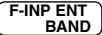
Push , , , , , , 
and .

1 PANEL DESCRIPTION

■ Front panel (Continued)

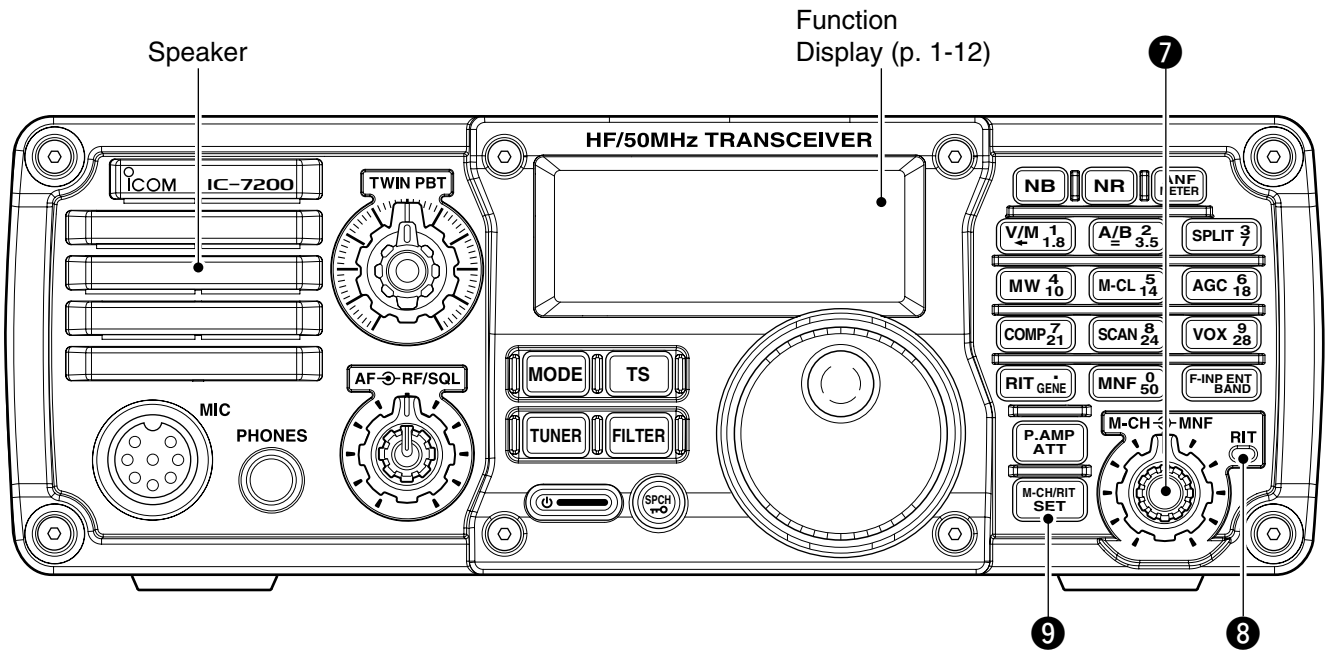

7 M-CH/RIT CONTROL [M-CH] (inner control)

- While in the Set mode/Quick Set mode, rotate to select the Set mode item. (p. 10-2)
- This control can be set as the memory channel control or the RIT control.
 - The RIT function should be turned ON first to activate this control as the RIT control. (p. 5-2)
 - “RIT” appears when the RIT function is ON.
 - The RIT control indicator (8) lights orange when this control is activated as the RIT control.

When [M-CH] acts as the M-CH control:
Rotate to select a memory channel. (p. 7-2)

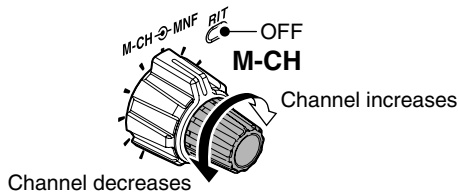

When [M-CH] acts as the RIT control:
Rotate to shift the receive frequency. (p. 5-2)

- Rotate the control clockwise to increase the frequency, or rotate the control counterclockwise to decrease the frequency.
- The shift frequency range is ± 9.999 kHz in 1 Hz steps (or ± 9.99 kHz in 10 Hz steps).

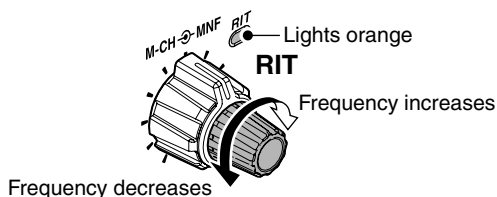

✓ What is the RIT function?

The RIT (Receiver Incremental Tuning) shifts the receive frequency without shifting the transmit frequency. This is useful for fine tuning stations calling you off frequency, or when you prefer to listen to slightly different sounding audio characteristics.

- About the [M-CH] control activation:

		RIT control indicator (8 as below)	
		Lights	OFF
RIT icon (16 on page 1-13)	Appears	Acts as the RIT control	Acts as the memory channel control
	Disappears	N/A	

8 RIT CONTROL INDICATOR (pp. 5-2, 7-2)

Lights orange when the [M-CH] control (7) is selected as the RIT control.

9 M-CH/RIT•SET KEY

- Push to toggle the [M-CH] control between the memory channel control and the RIT control.
 - The RIT function should be turned ON first. (p. 5-2)
 - The RIT control indicator (8) lights orange when the [M-CH] control functions as the RIT control.
- Hold down for 1 second to enter the Quick Set mode. (p. 10-2)
- In the Quick Set mode, hold down for 1 second to enter the Set mode (p. 10-3)
- In the Quick Set mode or Set mode, push to return to normal operation. (p. 10-2, 10-3)

1 PANEL DESCRIPTION

■ Front panel (Continued)

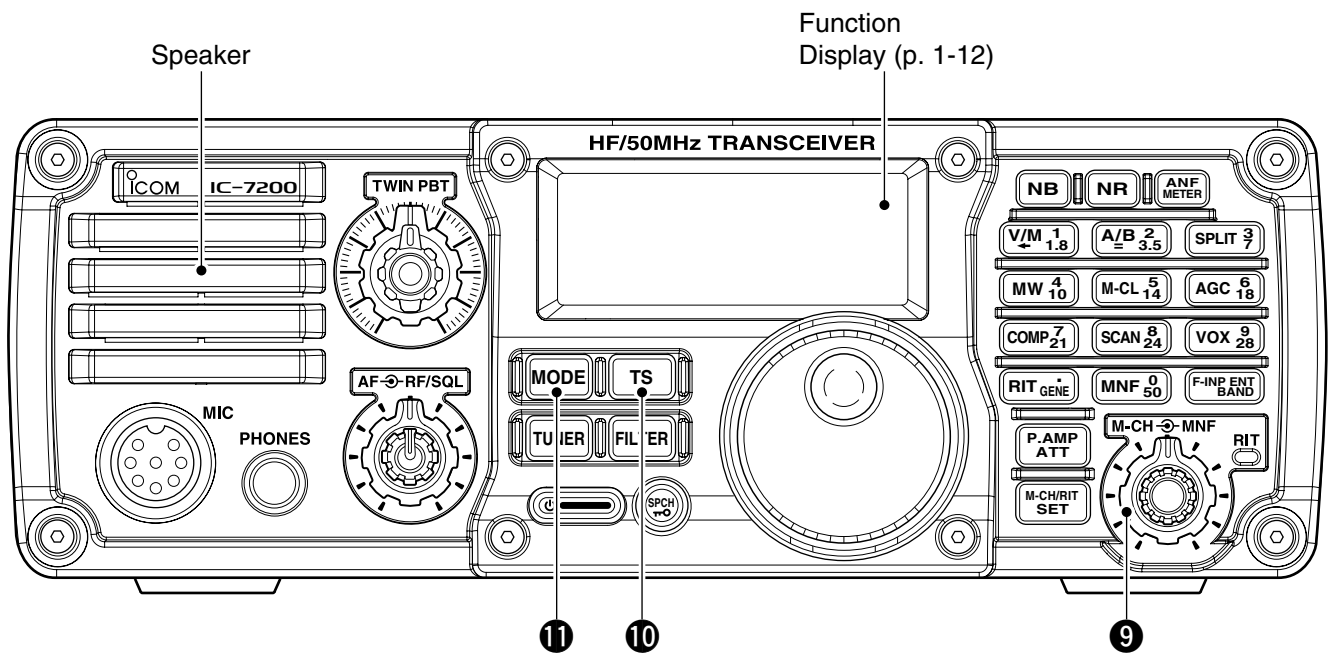

9 MANUAL NOTCH FILTER CONTROL [MNF]

(outer control; p. 5-9)

Rotate to adjust the **notch filter** frequency to reject an interfering signal while the manual notch function is ON.

- Select the narrow, mid or wide filter width in the manual notch filter Set mode.

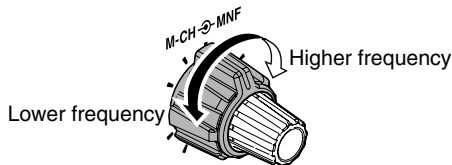

✓ What is the Manual Notch Filter?

The Manual Notch Filter is an adjustable narrow **DSP** filter that removes tones from CW, SSB, AM or RTTY or other signals, while preserving the desired signal's frequency response.

10 TUNING STEP KEY [TS] (pp. 3-7, 3-8)

- ➔ Push to turn the Quick tuning function ON or OFF.

- “▼” appears above the 1 kHz indicator when the Quick tuning function is turned ON and the frequency is changed in the selected ‘kHz’ steps.

- ➔ “▼” appears when the Quick tuning function is turned ON. Hold down for 1 second to enter tuning step Set mode.

After selecting a step, push again to return to normal operation.

- 0.1, 1, 5, 9 and 10 kHz **tuning steps** are selectable.

- ➔ While the Quick tuning function is turned OFF, hold down for 1 second to turn the 1 Hz step ON or OFF.

- 1 Hz indication appears, and the frequency is changed in 1 Hz steps.

11 MODE KEY [MODE] (p. 3-11)

- ➔ Push to cycle through the operating modes:
- ➔ USB/LSB → CW/CW-R → RTTY/RTTY-R → AM
- ➔ Hold down for 1 second to toggle the following operating modes:

USB ↔ LSB (p. 4-2)

CW ↔ CW-R (Reverse) (p. 4-5)

RTTY ↔ RTTY-R (Reverse) (p. 4-10)

- “CW-R” or “RTTY-R” appears when the reverse mode is selected.

- ▨ You can temporarily disable modes you do not want to be selectable, in the Set mode. (p. 10-16)

1 PANEL DESCRIPTION

■ Front panel (Continued)

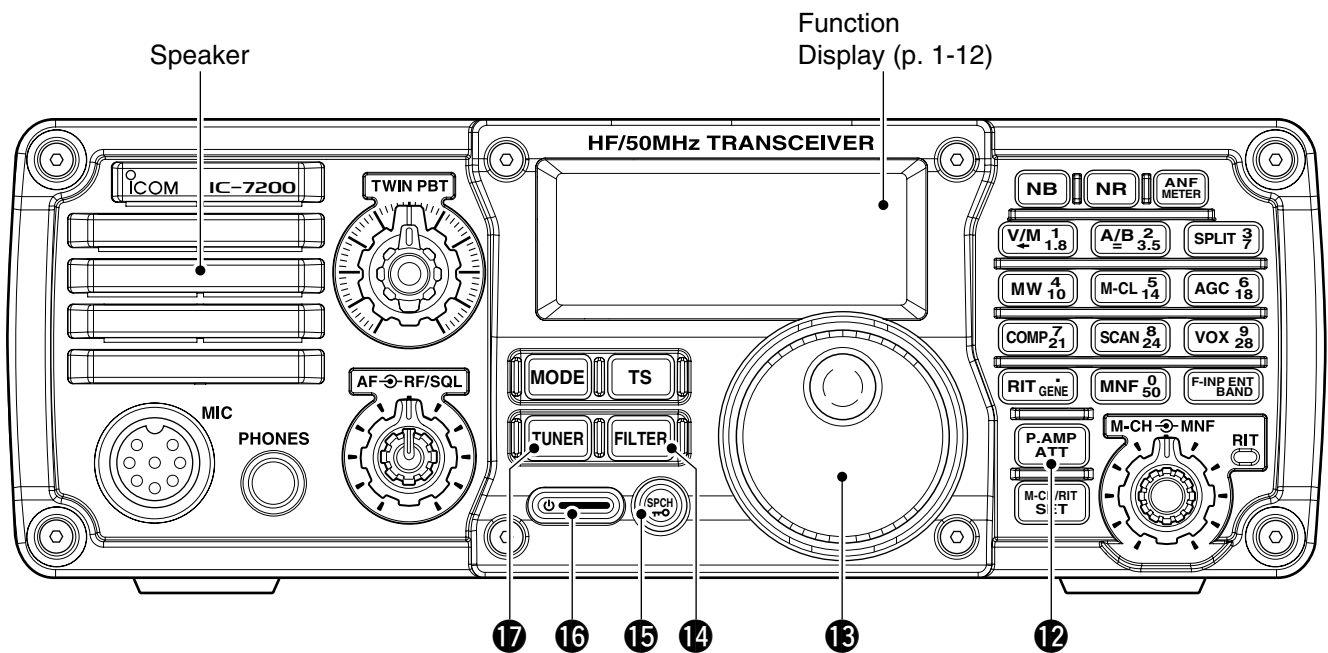

12 PREAMP/ATTENUATOR KEY P.A.M.P ATT (p. 5-3)

- ➔ Push to turn the preamp ON or OFF.
 - “**P.A.M.P**” appears when the preamp is ON.
- ➔ Hold down for 1 second to turn ON the 20 dB attenuator; push to turn OFF the attenuator.
 - “**ATT**” appears when the attenuator is ON.

✓ *What is the preamp?*

The preamp amplifies signals in the receiver front end (input) circuit to improve the **sensitivity**. Turn ON the preamp when receiving weak signals.

✓ *What is the attenuator?*

The attenuator prevents a strong undesired signal near the desired frequency or near your location, such as from a broadcast station, from causing distortion or spurious signals.

13 MAIN DIAL [DIAL]

Changes the displayed frequency and selects values for selected Set mode/Quick Set mode items.

14 FILTER KEY FILTER (p. 5-5)

- ➔ Push to select the wide, mid or narrow **IF filter** setting for the selected **band**.
- ➔ Hold down for 1 second to enter the filter Set mode.
 - Rotate [DIAL] to adjust the filter width, then hold down the key again to return to normal operation.

15 SPCH•LOCK KEY SPCH LOCK

- ➔ Push to announce the displayed frequency and S-meter level by the speech synthesizer. (p. 3-13)
 - The items to be announced can be selected in the Set mode. (p. 10-12)
- ➔ Hold down for 1 second to turn the Dial lock function ON or OFF. (p. 3-12)
 - The dial lock function electronically locks the main dial.
 - “**LOCK**” appears while the dial lock function is ON.

16 POWER KEY POWER

- ➔ Push to turn ON power.
 - First turn ON the DC power supply.
- ➔ Hold down for 1 second to turn OFF power.

17 TUNER KEY TUNER (p. 9-2, 9-4)

- ➔ Push to turn the automatic **antenna tuner** function ON or OFF.
 - An optional antenna tuner must be connected.
 - “**TUNE**” appears when the automatic antenna tuner function is ON.
- ➔ Hold down for 1 second to start the antenna tuner.
 - An optional antenna tuner must be connected.
 - When the tuner cannot tune the antenna within 20 seconds, the tuning circuit is automatically bypassed.

1 PANEL DESCRIPTION

■ Front panel (Continued)

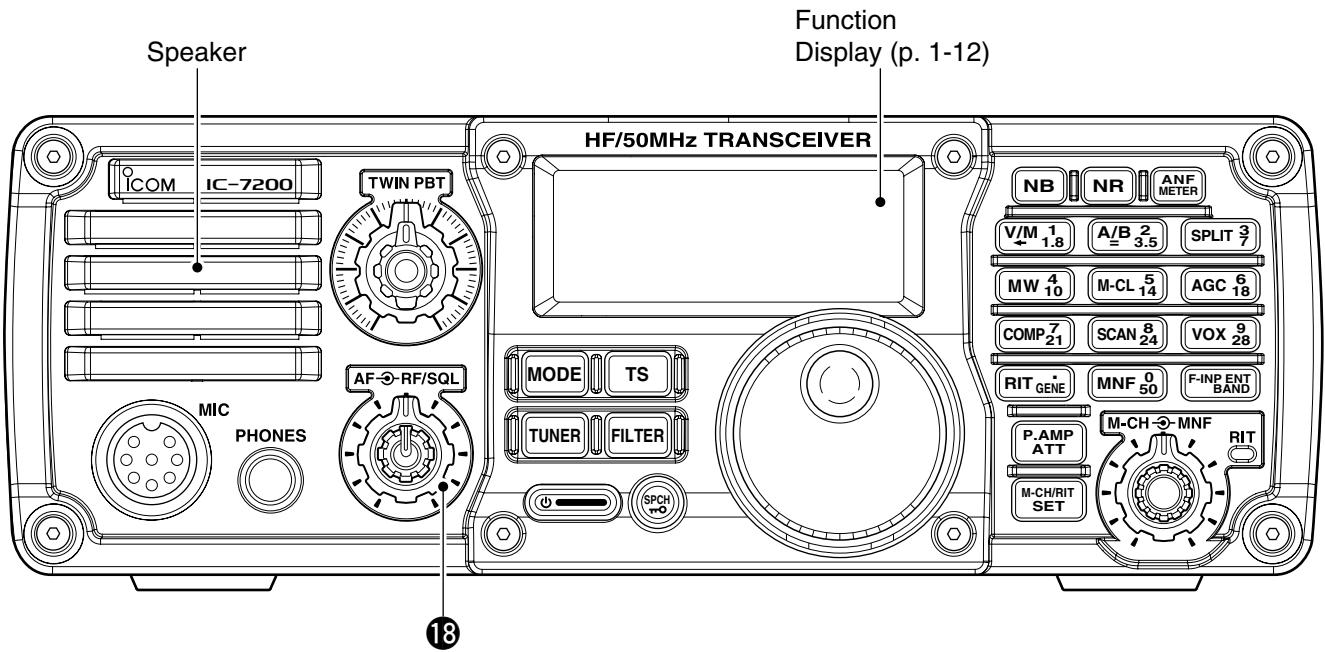

18 RF GAIN/SQUELCH CONTROL [RF/SQL]

(outer control: p. 3-12)

➔ Adjusts the RF gain and **squelch** threshold level.

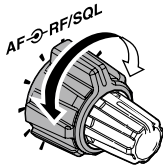

- ➔ The squelch removes noise output from the speaker (closed) when no signal is received.
 - The squelch is usable in all modes.
 - The control can be set as the squelch plus RF gain controls, squelch control only (RF gain is fixed at maximum) or Auto (RF gain control in SSB, CW and RTTY; squelch control in AM) in the Set mode.

MODE	SET MODE SETTING		
	AUTO	SQL	RF + SQL
SSB, CW RTTY	RF GAIN	SQL	RF GAIN + SQL
AM	SQL	SQL	RF GAIN + SQL

• When functioning as the RF GAIN/SQL control

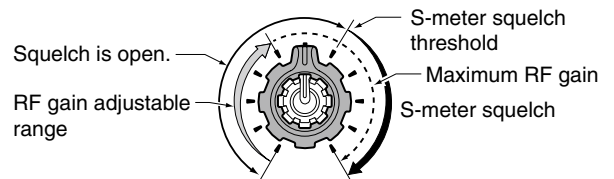

• When functioning as the RF GAIN control (Squelch is fixed open; SSB, CW, RTTY only)

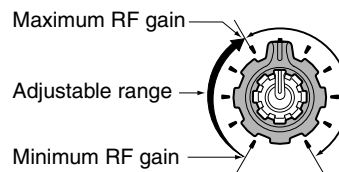

• When functioning as the SQL control (RF gain is fixed at maximum.)

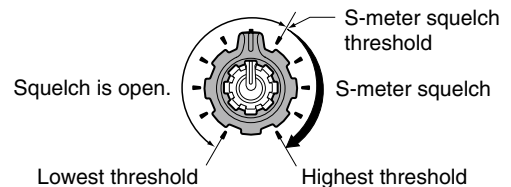

1 PANEL DESCRIPTION

■ Front panel (Continued)

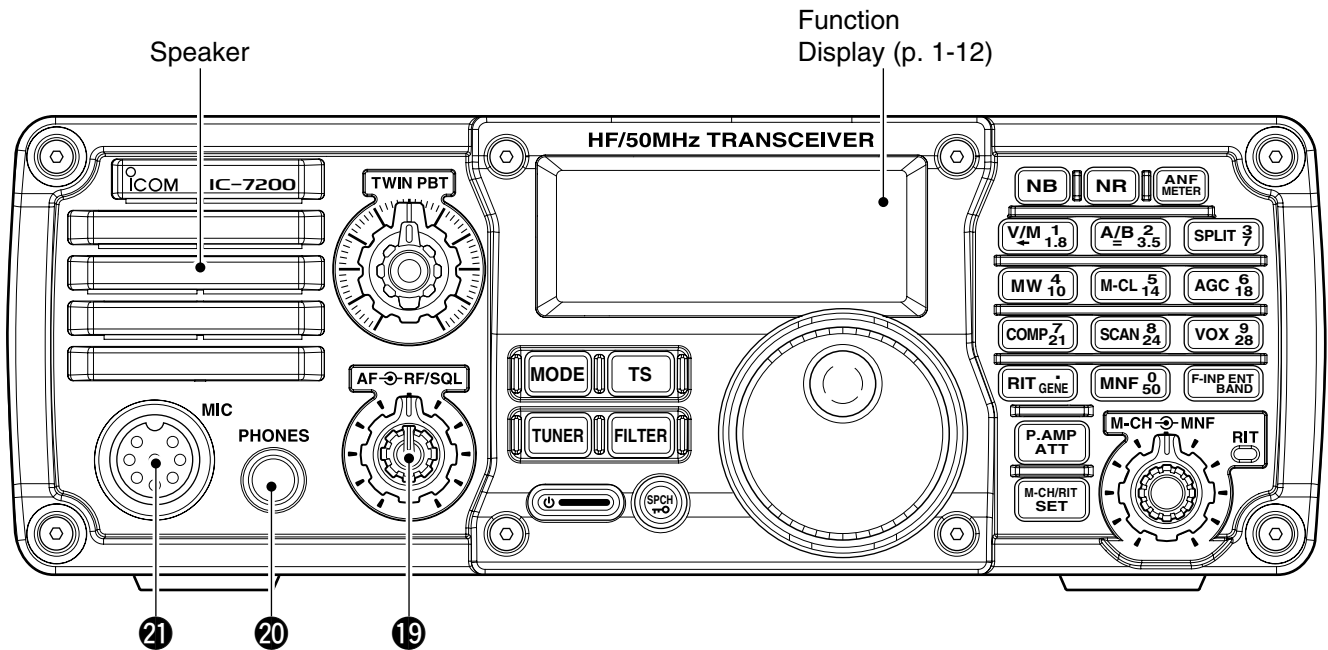

19 AF CONTROL [AF] (inner control; p. 3-11)

Adjusts the audio output level from the speaker.

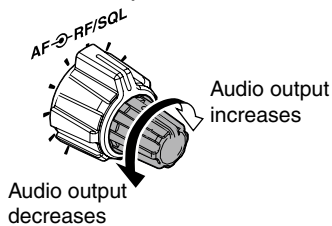

20 HEADPHONE JACK [PHONES]

Accepts headphones with 8–16 Ω impedance.

- Output power: 5 mW with an 8 Ω load.
- When headphones are connected, the speaker audio is disabled.

21 MICROPHONE CONNECTOR [MIC]

Accepts the supplied or optional microphones.

- See page 1-17 for appropriate microphones and microphone connector information.

1 PANEL DESCRIPTION

◇ Keypad

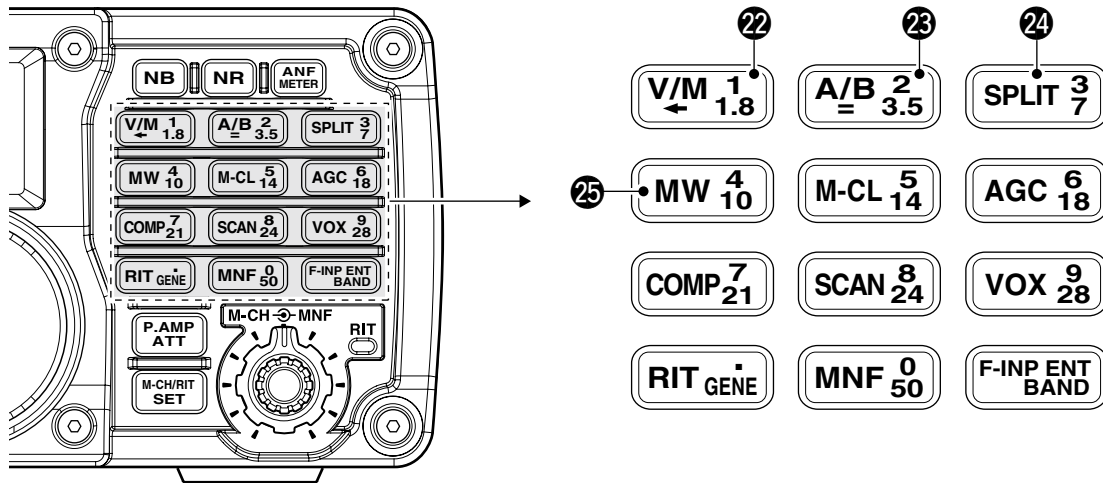

22 VFO/MEMORY/1/1.8 MHz BAND KEY



- ➔ Push to toggle the operating mode between the VFO mode and the memory mode. (pp. 3-3, 7-2)
- ➔ Hold down for 1 second to copy the memory contents to the VFO. (p. 7-5)

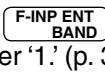
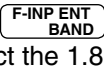

- ➔ Push , then push this key to input the number '1.' (p. 3-6)
- ➔ Hold down  for 1 second, then push this key to select the 1.8 MHz band. (p. 3-4)

23 VFO SELECT/EQUALIZATION/2/3.5 MHz BAND KEY



- ➔ Push to toggle between VFO A and VFO B. (p. 3-2)
- ➔ Hold down for 1 second to equalize the frequency and operating mode of the two VFOs. (p. 3-2)
 - The undisplayed VFO frequency and operating mode are set to the same frequency and operating mode as the displayed VFO.

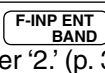
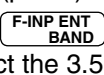

- ➔ Push , then push this key to input the number '2.' (p. 3-6)
- ➔ Hold down  for 1 second, then push this key to select the 3.5 MHz band. (p. 3-4)

24 SPLIT/3/7 MHz BAND KEY



- ➔ Push to turn the Split function ON or OFF. (p. 6-8)
 - "SPLIT" appears when the split function is ON.
- ➔ Hold down for 1 second to activate the Quick split function. (p. 6-10)
 - VFO B's frequency and operating mode are set to the same frequency and operating mode as VFO A.
 - The quick split function can be disabled in the Set mode. (p. 10-10)

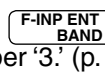
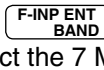

- ➔ Push , then push this key to input the number '3.' (p. 3-6)
- ➔ Hold down  for 1 second, then push this key to select the 7 MHz band. (p. 3-4)

25 MEMORY WRITE/4/10 MHz BAND KEY



Hold down for 1 second to store the displayed VFO frequency and operating mode into the selected memory channel. (p. 7-3, 7-4)

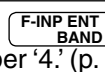
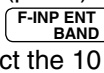

- ➔ Push , then push this key to input the number '4.' (p. 3-6)
- ➔ Hold down  for 1 second, then push this key to select the 10 MHz band. (p. 3-4)

1 PANEL DESCRIPTION

◇ Keypad (Continued)

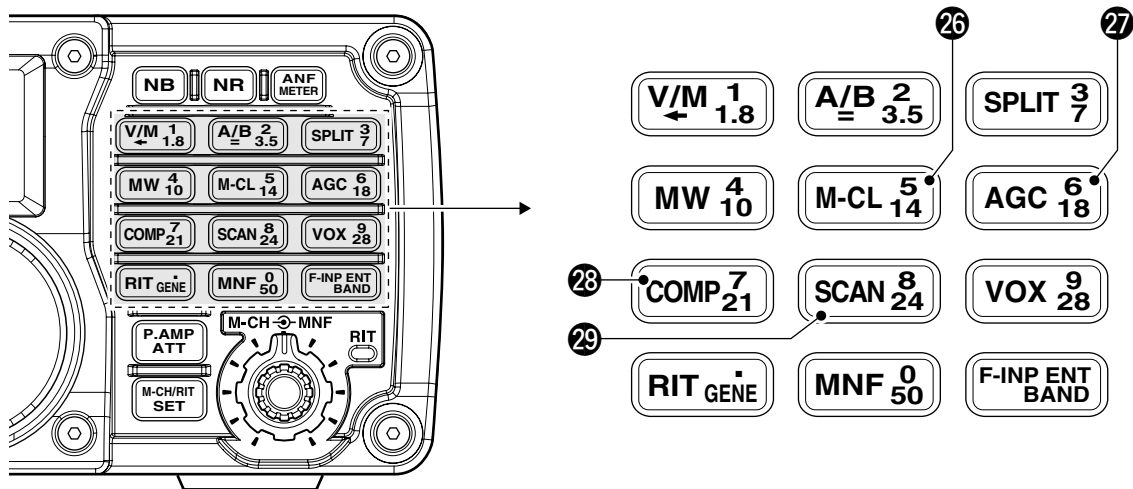

26 MEMORY CLEAR/5/14 MHz BAND KEY

M-CL

- ➔ Hold down for 1 second to clear the displayed frequency and operating mode in the selected memory channel. (p. 7-6)
 - “BLANK” appears above the memory channel number.
- ➔ Hold down for 1 second, to select a default option or value when in the Set mode or the Quick Set mode. (p. 10-2, 10-3)

5
14

- ➔ Push **F-INP ENT BAND**, then push this key to input the number ‘5.’ (p. 3-6)
- ➔ Hold down **F-INP ENT BAND** for 1 second, then push this key to select the 14 MHz band. (p. 3-4)

27 AGC/6/18 MHz BAND KEY

AGC

- ➔ Push to toggle the time constant for the AGC circuit fast or slow. (p. 5-3)
 - “F.AGC” appears when fast AGC is selected; no indication appears when slow AGC is selected
- ➔ Hold down for 1 second to turn OFF the AGC function.
 - “AGC-OFF” appears.

6
18

- ➔ Push **F-INP ENT BAND**, then push this key to input the number ‘6.’ (p. 3-6)
- ➔ Hold down **F-INP ENT BAND** for 1 second, then push this key to select the 18 MHz band. (p. 3-4)

28 SPEECH COMPRESSOR/7/21 MHz BAND KEY

COMP

- ➔ Push to turn the Speech compressor function ON or OFF. (p. 6-6)
 - “COMP” appears when the speech compressor function is ON.
- ➔ Hold down for 1 second to enter the speech compression level Set mode. Rotate [DIAL] to set the compression level, then push the key again to return to normal operation.

7
21

- ➔ Push **F-INP ENT BAND**, then push this key to input the number ‘7.’ (p. 3-6)
- ➔ Hold down **F-INP ENT BAND** for 1 second, then push this key to select the 21 MHz band. (p. 3-4)

29 SCAN/8/24 MHz BAND KEY

SCAN

Push to start/stop the programmed/memory scan in the VFO/memory mode. (p. 8-4, 8-5)

- “SCAN” appears during a scan.

8
24

- ➔ Push **F-INP ENT BAND**, then push this key to input the number ‘8.’ (p. 3-6)
- ➔ Hold down **F-INP ENT BAND** for 1 second, then push this key to select the 24 MHz band. (p. 3-4)

1 PANEL DESCRIPTION

◇ Keypad (Continued)

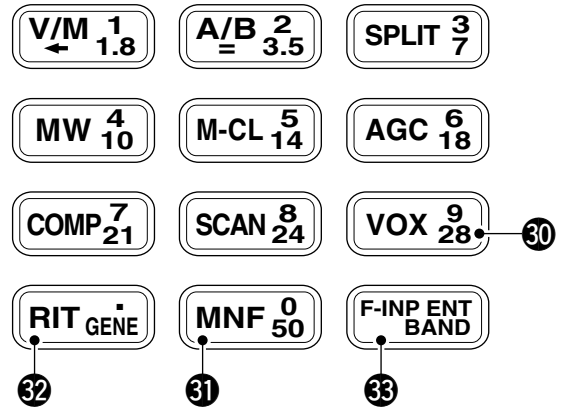
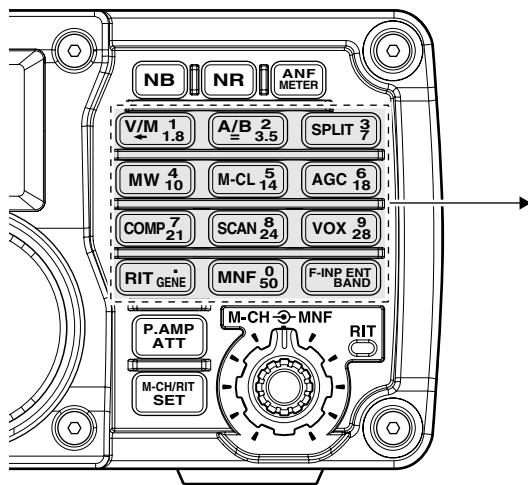

30 VOX/9/28 MHz BAND KEY

VOX

- ➔ Push to turn the **VOX** function ON or OFF. (p. 6-2)
- ➔ Hold down for 1 second to enter the VOX Set mode; push again to return to normal operation.

9
28

- ➔ Push **F-INP ENT BAND**, then push this key to input the number '9.' (p. 3-6)
- ➔ Hold down **F-INP ENT BAND** for 1 second, then push this key to select the 28 MHz **band**. (p. 3-4)

✓ What is the VOX function?

The VOX function (Voice-Operated Transmission) activates the transmitter when you speak into the microphone and automatically returns to receive when you stop speaking.

31 MANUAL NOTCH FILTER/0/50 MHz BAND KEY

MNF

- ➔ Push to turn the Manual **notch filter** function ON or OFF. (p. 5-9)
 - “**MNF**” appears when the Manual notch filter function is ON.
- ➔ Hold down for 1 second to enter the manual notch Set mode. Rotate [DIAL] to select Wide, Mid or Narrow width. Push again to return to normal operation. (p. 5-10)

0
50

- ➔ Push **F-INP ENT BAND**, then push this key to input the number '0.' (p. 3-6)
- ➔ Hold down **F-INP ENT BAND** for 1 second, then push this key to select the 50 MHz band. (p. 3-4)

32 RIT/*/GENERAL BAND KEY

RIT

- ➔ Push to turn the RIT (Receiver Incremental Tuning) function ON or OFF. (p. 5-2)
 - “**RIT**” appears when the RIT function is ON.
 - The RIT frequency can be adjusted with the [M-CH] control when the RIT mode is selected.
- ➔ Hold down for 1 second to add the RIT shift frequency to the operating frequency. (p. 5-2)
 - Selectable only when the XFC (transmit frequency check function) is turned OFF. (p. 10-11)

GENE

- ➔ Push **F-INP ENT BAND**, then push this key to input the number ‘• (decimal point).’ (p. 3-6)
- ➔ Hold down **F-INP ENT BAND** for 1 second, then push this key to select the general coverage receive mode. (p. 3-4)

33 FREQUENCY INPUT/ENTER/BAND KEY

F-INP ENT BAND

- ➔ Push to enter the direct frequency input mode. (p. 3-6)
- ➔ Hold down for 1 second, then push a band key on the keypad to select the desired operating band. (p. 3-4)
 - **GENE** selects the general coverage receive band.

■ Function display

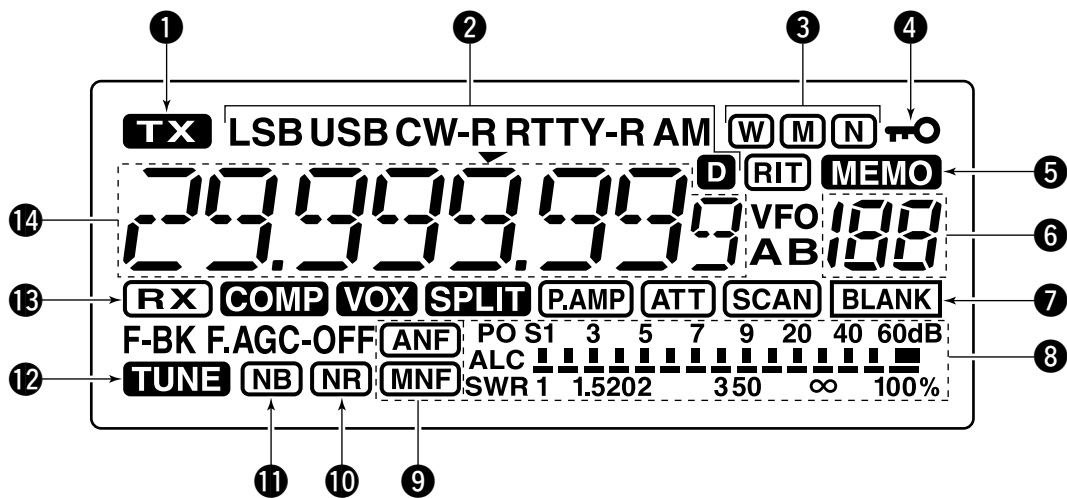

1 TRANSMIT ICON

Appears while transmitting.

2 MODE ICONS

Shows the selected operating mode.

- “**D**” appears when the SSB/AM data mode is selected. (p. 10-5)
- “**-R**” appears when the CW reverse or RTTY reverse mode is selected. (pp. 3-11, 4-5, 4-10)

3 IF FILTER ICONS (p. 5-5)

Shows the selected IF filter.

- ➔ “**W**” appears when the wide **IF filter** is selected.
- ➔ “**M**” appears when the mid IF filter is selected.
- ➔ “**N**” appears when the narrow IF filter is selected.

4 LOCK ICON (p. 3-12)

Appears when the dial lock function is ON.

5 MEMORY ICON (p. 7-2)

Appears when in the memory mode is selected.

6 MEMORY CHANNEL NUMBER READOUT

(p. 7-2)

Shows the selected memory channel number.

7 BLANK ICON (p. 7-3)

Appears when the selected memory channel is blank.

- This icon appears in both the VFO and memory modes.

8 S/R/F METER

- ➔ Displays the receiving signal strength.
- ➔ Displays either the transmit power (PO), **SWR** or **ALC** while transmitting. (p. 3-13)

9 NOTCH ICONS (p. 5-9, 5-10)

- ➔ “**ANF**” appears when the automatic notch function is ON.
- ➔ “**MNF**” appears when the manual notch function is ON.

10 NOISE REDUCTION ICON (p. 5-8)

Appears when the **noise reduction** function is ON.

11 NOISE BLANKER ICON (p. 5-7)

Appears when the **noise blanker** is ON.

12 TUNE ICON (p. 9-2, 9-4)

- ➔ Appears when an automatic **antenna tuner** is activated.
- ➔ Blinks while tuning.

13 RECEIVE ICON

Appears while receiving a signal or when the **squelch** is open.

14 FREQUENCY READOUT

Displays the operating frequency.

1 PANEL DESCRIPTION

■ Function display (Continued)

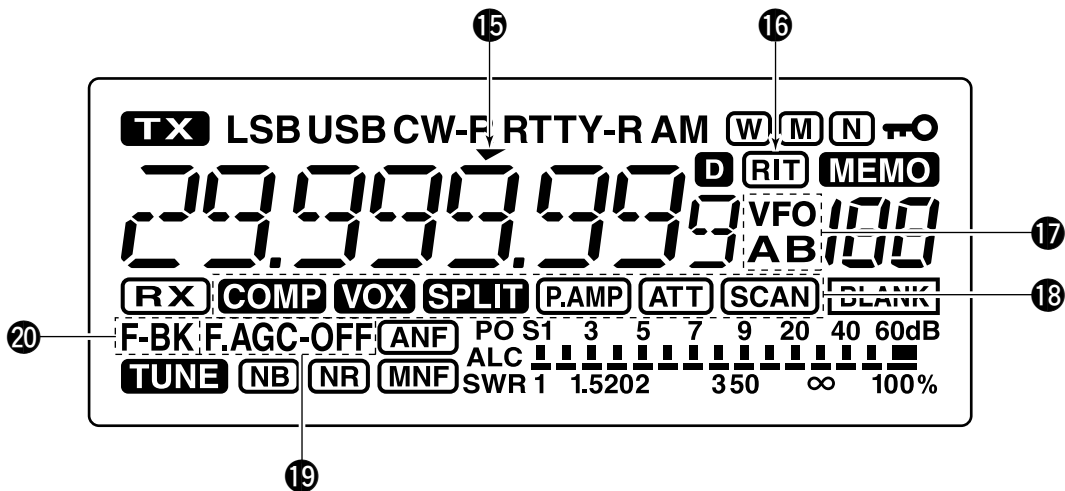

15 QUICK TUNING STEP ICON

Appears when the Quick tuning function is selected.
(p. 3-7, 3-8)

16 RIT ICON (p. 5-2)

Appears when the RIT function is ON.

17 VFO ICONS (p. 3-2)

“VFO A” or “VFO B” appears when the VFO mode is selected.

18 FUNCTION ICONS

- ➔ “COMP” appears when the speech compressor is ON in the SSB mode.
- ➔ “VOX” appears when the VOX function is ON.
- ➔ “SPLIT” appears when the Split function is ON.
- ➔ “P.AMP” appears when preamp is ON.
- ➔ “ATT” appears when the attenuator is ON.
- ➔ “SCAN” appears during a scan.
 - Blinks when the scan is paused.

19 AGC ICONS (p. 5-3)

Displays the selected AGC time constant.
• “F.AGC” for AGC fast; “AGC-OFF” for AGC OFF; no icon for AGC slow.

20 BREAK-IN ICONS

- ➔ “BK” appears when the Semi break-in function is ON. (p. 6-4)
- ➔ “F-BK” appears when the Full break-in function is ON. (p. 6-5)

■ Rear panel

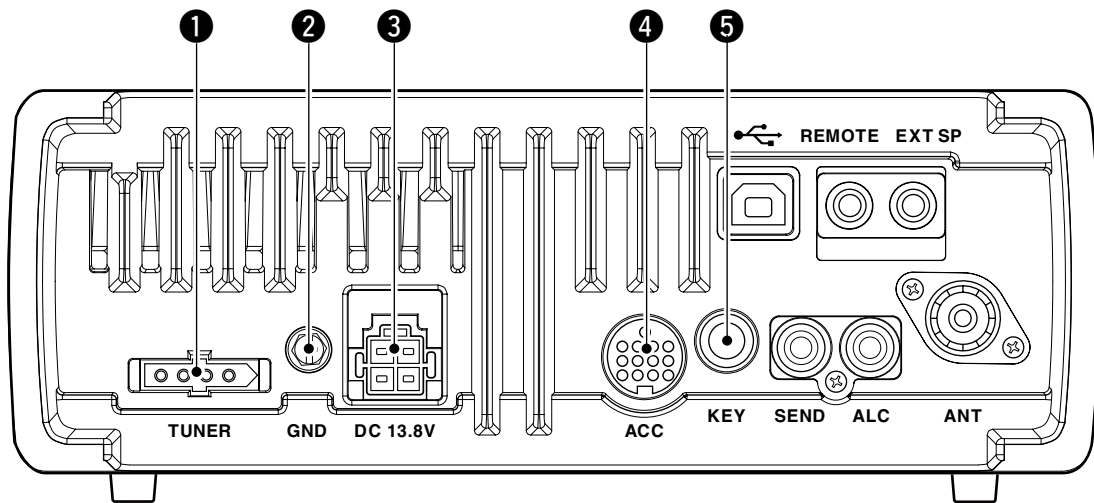

1 TUNER CONTROL SOCKET [TUNER] (p. 2-6)
Accepts the control cable from an optional **antenna tuner**.

2 GROUND TERMINAL [GND] (p. 2-2, 2-3)
Connects to a ground to prevent electrical shocks, TVI, BCI and other problems.

3 DC POWER SOCKET [DC 13.8V] (p. 2-5)
Accepts 13.8 V DC through the supplied DC power cable.

Rear panel view

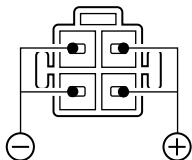

5 ELECTRONIC KEYSER JACK [KEY]
Accepts a key or paddle connector for the internal electronic keyer.
• The keyer type selection between the internal electronic keyer and straight key operation can be made in the Set mode.

When connecting a straight key

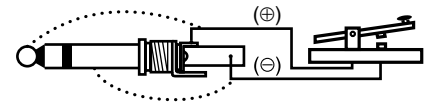

When connecting a paddle

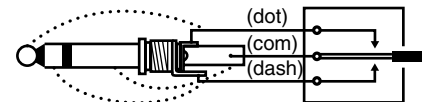

▨ If you use an external electronic keyer, make sure the output voltage of the keyer is less than 0.4 V when keying the transmitter.

4 ACCESSORY SOCKET [ACC]
Enables connection to external equipment such as a **TNC** for data communications, a linear amplifier or an automatic antenna tuner, and so on.
• See below for socket wiring information.

1 PANEL DESCRIPTION

■ Rear panel (Continued)

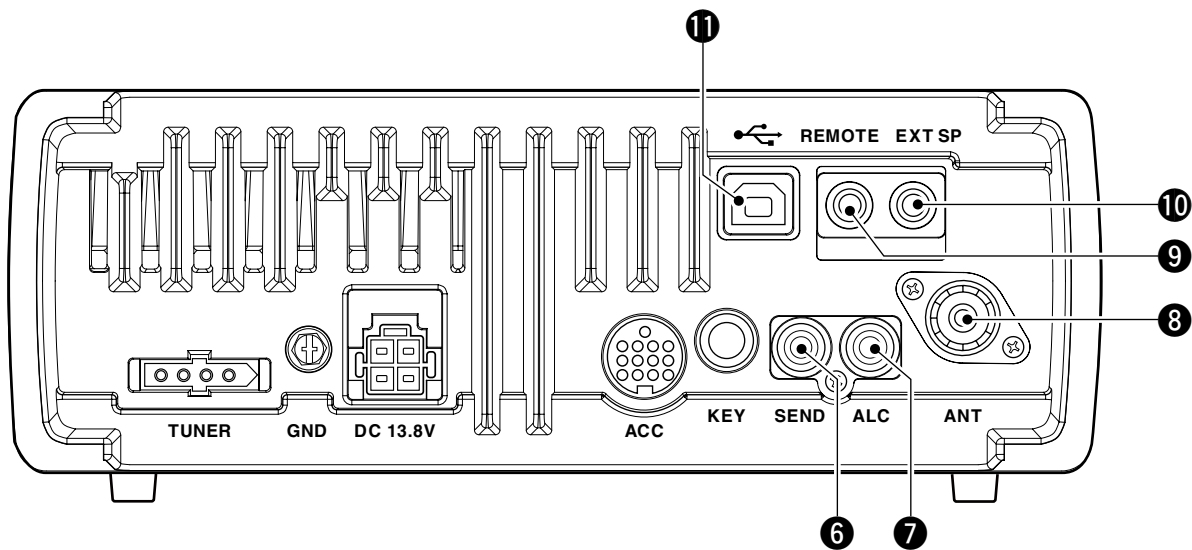

- 6 SEND CONTROL JACK [SEND]** (p. 2-7)
Goes to ground while transmitting to control external equipment such as a linear amplifier.
• Maximum control level: 16 V DC/0.5 A

- 7 ALC INPUT JACK [ALC]** (p. 2-7)
Connects to the **ALC** output jack of a non-Icom linear amplifier.

- 8 ANTENNA CONNECTOR [ANT]** (p. 2-3)
Accepts a PL-259 connector and a 50 Ω coaxial cable from an **antenna tuner** or an antenna.

- 9 CI-V REMOTE CONTROL JACK [REMOTE]**
(pp. 2-4, 11-2)
➔ Designed for use with a PC for remote control of the transceiver functions.
➔ Used for transceiver operation with another Icom **CI-V** transceiver or receiver.

- 10 EXTERNAL SPEAKER JACK [EXT SP]**
(p. 2-4)
Connects a 4–8 Ω external speaker.
• When an external speaker is connected, the internal speaker is disabled.

- 11 USB JACK []**
Connects a USB cable for transceiver **modulation** input (p. 2-9), the transceiver operation with a PC, and the received audio sent to the PC.

CAUTION:
The USB driver must be installed. Please read the USB driver installation guide before installing the USB driver into your PC that is connected to the IC-7200 with the USB cable (third party).

About the USB driver:

The USB driver and the installation guide can be downloaded from our website.

➔ <http://www.icom.co.jp/world/>

The following items are required:

PC

- Microsoft® Windows® 7/XP*/2000 or Microsoft® Windows Vista® installed
- *The USB driver is not supported for Microsoft® Windows® XP (64 bit).
- With USB port

Other items

- USB cable (third party's)
- PC software

About the modulation input:

Select "U" (USB) in the Set mode item 'Modulation input (Data OFF)' or 'Modulation input (Data ON)'. And the modulation input level from USB jack can be set in the Set mode item 'USB Level.' (p. 10-11, 10-12)

1 PANEL DESCRIPTION

■ Rear panel (Continued)

◇ ACC socket information

• ACC socket

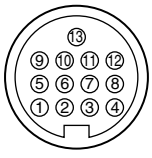
ACC	PIN No.	NAME	DESCRIPTION	SPECIFICATIONS	
 <p>Rear panel view</p> <p>① brown ⑧ gray ② red ⑨ white ③ orange ⑩ black ④ yellow ⑪ pink ⑤ green ⑫ light blue ⑥ blue ⑬ light blue ⑦ purple ⑬ green</p> <p>Color refers to the cable strands of the supplied cable.</p>	1	NC (8 V*)	*If the Band Voltage modification is performed, regulated 8 V output. (p. 12-2)	— Output voltage : 8 V ± 0.3 V Output current : Less than 10 mA	
	2	GND	Connects to ground.	—	
	3	SEND	Input/output pin. Grounded when transmits.	An external equipment controls the transceiver. When this pin goes low, the transceiver transmits. The transceiver outputs a low signal to control external equipment.	Input voltage (High) : 2.0 V to 20.0 V Input voltage (Low) : -0.5 V to 0.8 V Current flow : Max. 20 mA Output voltage (Low) : Less than 0.1 V Current flow : Max. 200 mA
	4	START	Data line for the optional AT-180.	—	
	5	NC (BAND*)	*If the Band Voltage modification is performed, band voltage output. (p. 12-2)	— Output voltage : 0 to 8.0 V	
	6	ALC	ALC voltage input.	Control voltage : -4 V to 0 V Input impedance : More than 3.3 kΩ	
	7	NC	—	—	
	8	13.8 V	13.8 V output when power is ON.	Output current : Max. 1 A	
	9	KEY	Key line for the optional AT-180.	—	
	10	FSKK	Controls RTTY keying	"High" level : More than 2.4 V "Low" level : Less than 0.6 V Output current : Less than 2 mA	
	11	MOD	Modulator input.	Input impedance : 10 kΩ Input level : Approx. 100 mV rms	
	12	AF	AF detector output. Fixed level, regardless of the [AF] control position.	Output impedance : 4.7 kΩ Output level : 100–300 mV rms	
	13	SQLS	Squelch output. Grounded when squelch opens.	SQL open : Less than 0.3 V/5 mA SQL closed : More than 6.0 V/100 μA	

• When connecting the ACC conversion cable (OPC-599)

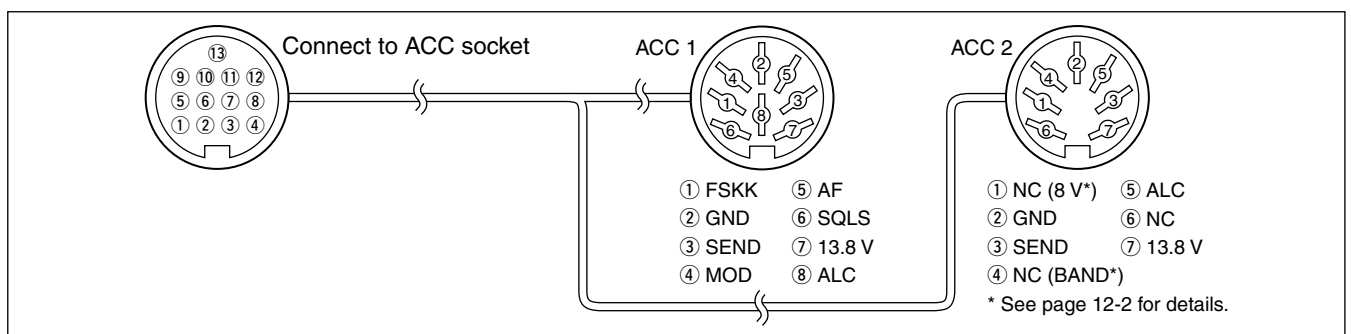

When the SEND terminal controls the inductive load (such as a relay), a counter-electromotive force can cause the transceiver's malfunction or damage. To prevent this, we recommend adding a switching diode, such as an "1SS133," on the load side of the circuit to the counter-electromotive force absorption. When the diode is added, a switching delay of the relay may occur. Be sure to check its switching action before operation.

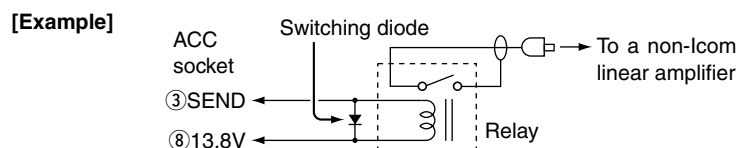

Microphones

◇ SM-50 (Option)

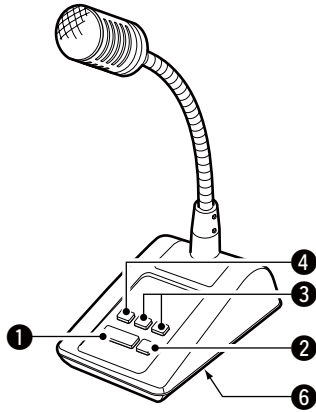

◇ SM-30 (Option)

TOP VIEW

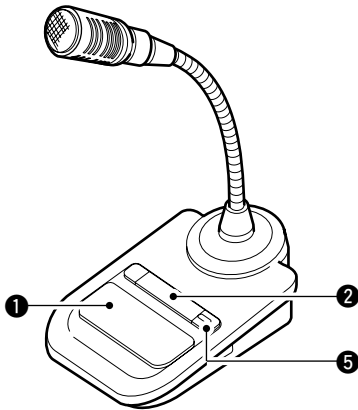

BOTTOM VIEW

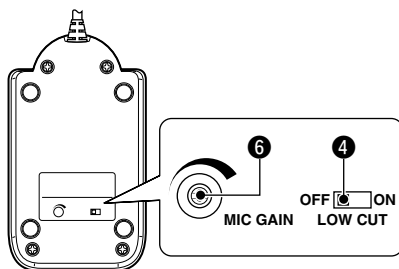

◇ HM-36

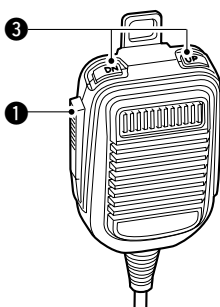

1 PTT SWITCH

Hold down to transmit; release to receive.

2 PTT LOCK SWITCH

(Only for the SM-50 and SM-30)

Push to lock the PTT switch in the transmit mode.

3 UP/DOWN SWITCHES [UP]/[DN]

Change the selected readout frequency or memory channel.

- Holding down continuously changes the frequency or memory channel number.

- While holding down **[RIT]***, the transmit readout frequency can be controlled while in the **split** frequency mode.

* Only when the XFC (transmit frequency check) function is ON. (p. 10-11)

- The [UP]/[DN] switch can simulate a key paddle. Pre-set in the Set mode (U/D KEY; Mic Up/Down Keyer). (p. 10-15)

4 LOW CUT SWITCH

(Only for the SM-50 and SM-30)

Push (SM-50)/Slide (SM-30) to cut out the low frequency components of input voice signals.

5 PTT LOCK INDICATOR [LOCK]

(Only for the SM-30)

Lights red when the PTT lock switch (3) is ON.

6 MIC GAIN VOLUME [MIC GAIN]

(Only for the SM-50 and SM-30)

Rotate to adjust the microphone output level.

- Use this control as an addition to the microphone gain setting of the connected transceiver.

Rotating the control too far clockwise may result in an output level that is too high and transmit signal distortion.

1 PANEL DESCRIPTION

■ Microphones (Continued)

• MICROPHONE CONNECTOR

(Transceiver view)

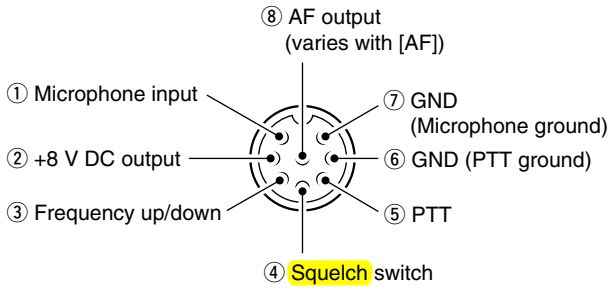

[MIC] PIN NO.	FUNCTION	DESCRIPTION
②	+8 V DC output	Max. 10 mA
③	Frequency up	Ground
	Frequency down	Ground through 470 Ω
④	Squelch open	"LOW" level
	Squelch close	"HIGH" level

CAUTION: DO NOT short pin 2 to ground as this can damage the internal 8 V regulator. DC voltage is applied to pin 1 for microphone operation. Use caution when using a non-Icom microphone.

- Unpacking..... 2-2
- Selecting a location 2-2
- Grounding..... 2-2
- Connecting an antenna 2-2
- Basic connections 2-3
- Optional connections 2-4
- Power supply connections 2-5
- Connecting the DC Power Supply 2-5
- Battery connections..... 2-6
- External antenna tuners 2-6
- Connecting a linear amplifier..... 2-7
- Connecting a CW keyer..... 2-8
- Connecting a PC/TNC for RTTY..... 2-9
 - ◇ Connections for RTTY (FSK)..... 2-9
 - ◇ Connections for RTTY (AFSK)..... 2-9
- Connecting a PC/TNC for SSTV or PSK31 2-10
 - ◇ Connecting to the [ACC] socket..... 2-10
 - ◇ Connecting to the [MIC] connector 2-10
 - ◇ Connecting to the [USB] jack..... 2-10

■ Unpacking

After unpacking, immediately report any damage to the delivering carrier or dealer. Keep the shipping cartons.

For a description and a diagram of accessory equipment included with the IC-7200, see 'Supplied accessories' on page i of the printed manual.

■ Selecting a location

Select a location for the transceiver that allows adequate air circulation is free from extreme heat, cold, or vibrations, and away from TV sets, TV antenna elements, radios and other electromagnetic sources.

The base of the transceiver has an adjustable stand for desktop use. Set the stand to one of two angles, depending on your operating conditions.

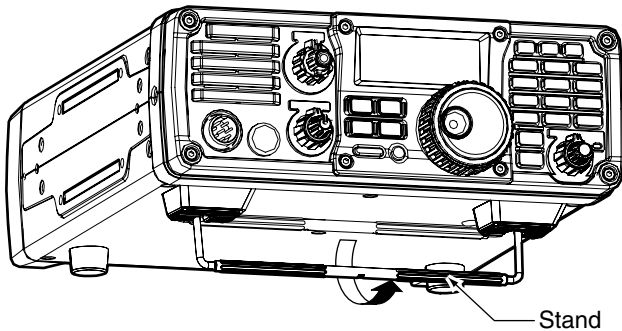

■ Grounding

To prevent electrical shock, television interference (TVI), broadcast interference (BCI) and other problems, ground the transceiver through the GROUND terminal on the rear panel.

For best results, connect a copper or copper-plated ground rod driven into the earth. Make the distance between the [GND] terminal and ground as short and straight as possible.

WARNING! NEVER connect the [GND] terminal to a gas or electric conduit, since the connection could cause an explosion or electric shock.

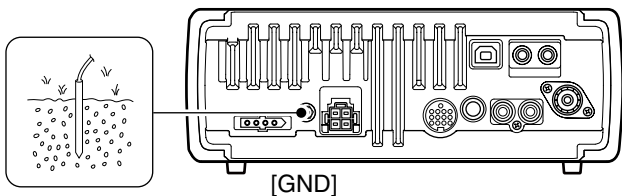

■ Connecting an antenna

For radio communications, the antenna is of critical importance for output power and **sensitivity**. Use well-matched 50 Ω antennas and coaxial feedline. An **SWR** (standing wave ratio) of 1.5:1 or lower is recommended when transmitting.

CAUTION: Protect your transceiver from lightning by using a lightning arrestor.

PL-259 CONNECTOR INSTALLATION EXAMPLE

- ① Slide the coupling ring down. Strip the cable jacket and tin.
- ② Strip the cable and tin the center conductor.
- ③ Slide the connector body on and solder it.
- ④ Screw the coupling ring onto the connector body.

30 mm (1.2 in) 10 mm (0.4 in) 1-2 mm (0.04-0.08 in)

Antenna SWR

Each antenna is tuned for a specified frequency range and the SWR may increase out-of-range. When the SWR is higher than approximately 2.0:1, the transceiver's power drops to protect the final transistors. In this case, an optional **antenna tuner** is useful to match the transceiver and antenna. Low SWR allows full power for transmitting, even when using the antenna tuner. The IC-7200 has an SWR meter to continuously monitor the antenna SWR.

Basic connections

• Front panel

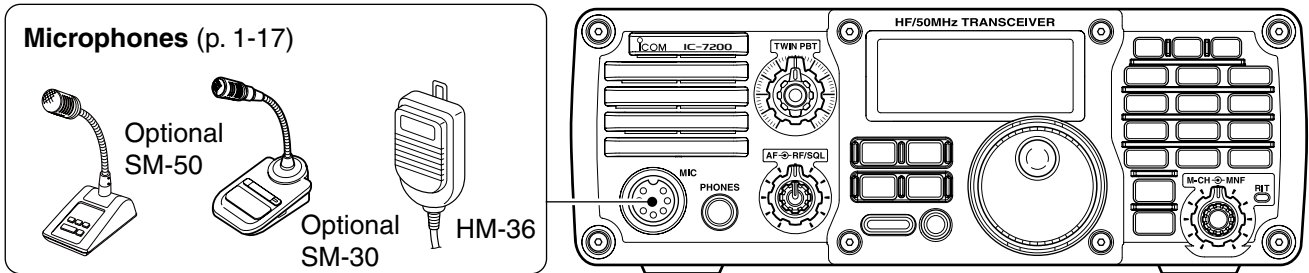

• Rear panel

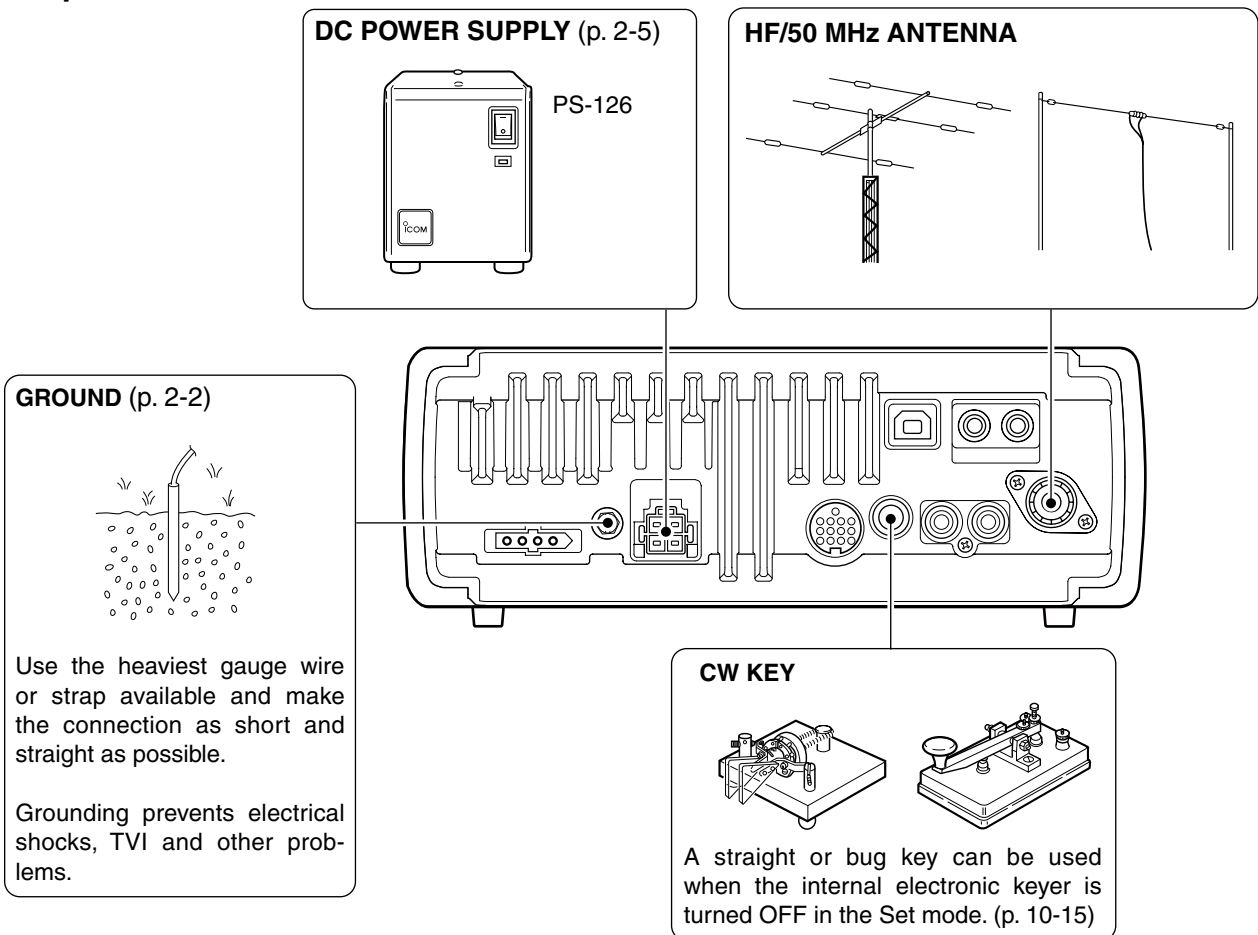

■ Optional connections

• Front panel

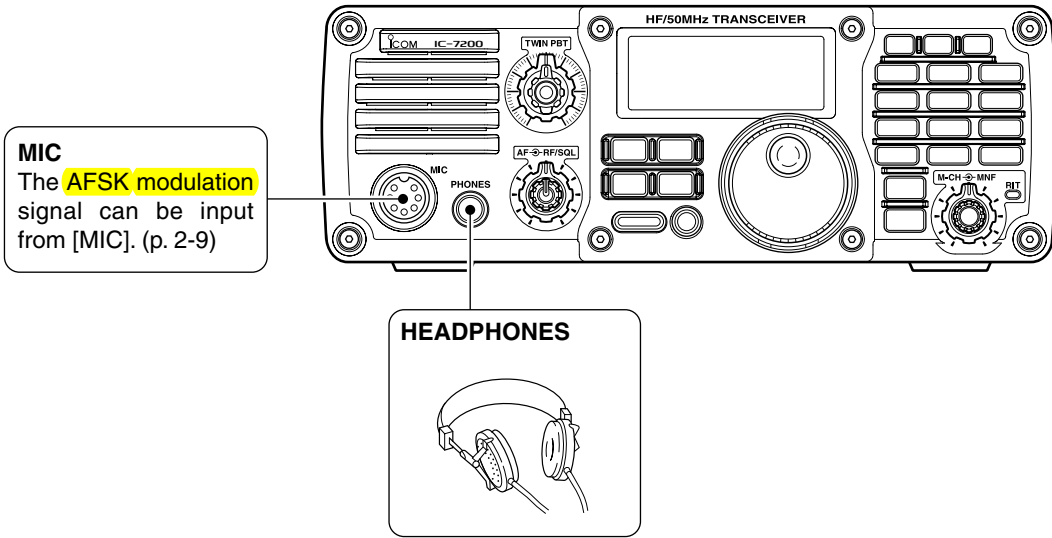

• Rear panel

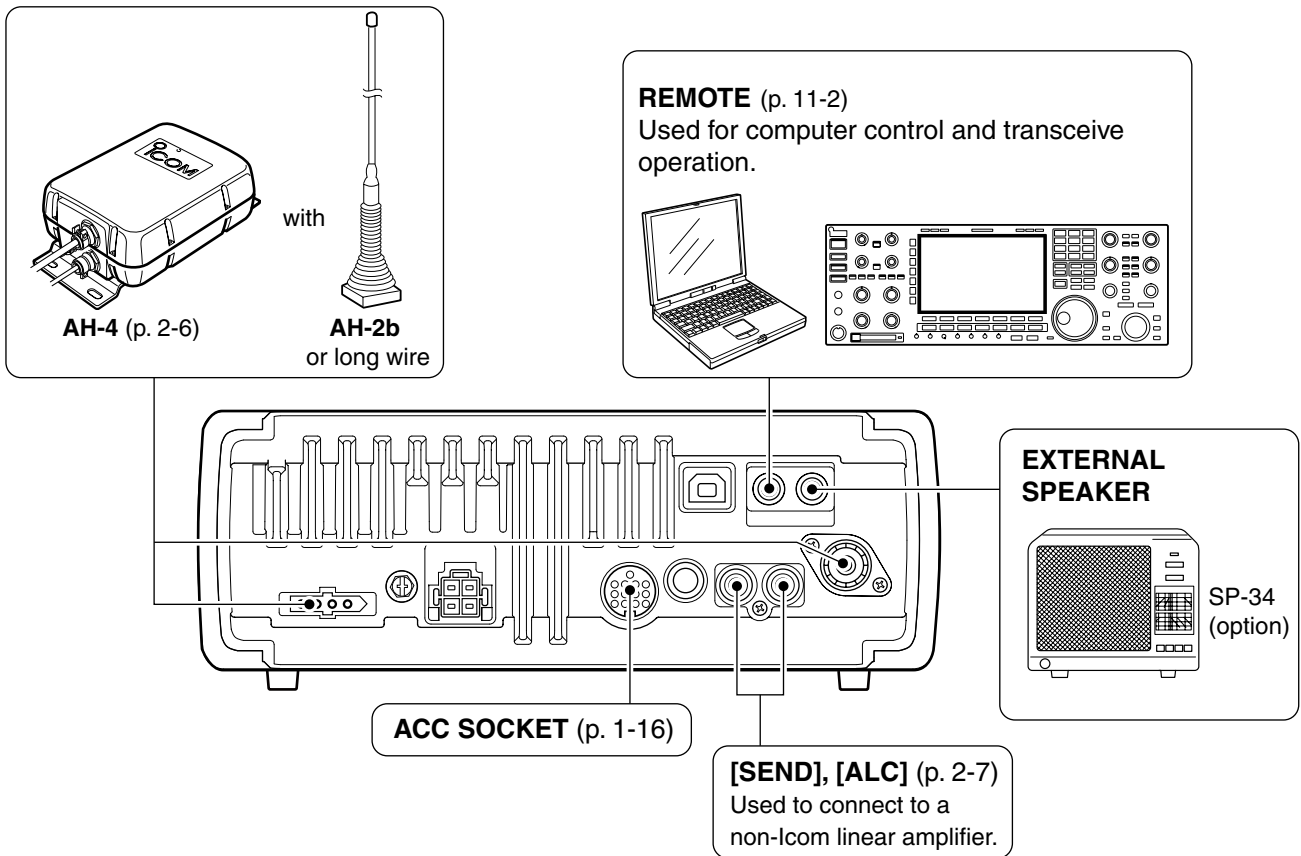

■ Power supply connections

Use a DC power supply with at least a 22 A capacity when operating the transceiver with AC power. Refer to the diagrams below.

CAUTION: Before connecting the DC power cable, check the following important items. Make sure:

- The  switch is OFF.
- Output voltage of the power source is 12–15 V.
- DC power cable polarity is correct.
 Red : Positive ⊕ terminal
 Black : Negative ⊖ terminal

■ Connecting the DC Power Supply

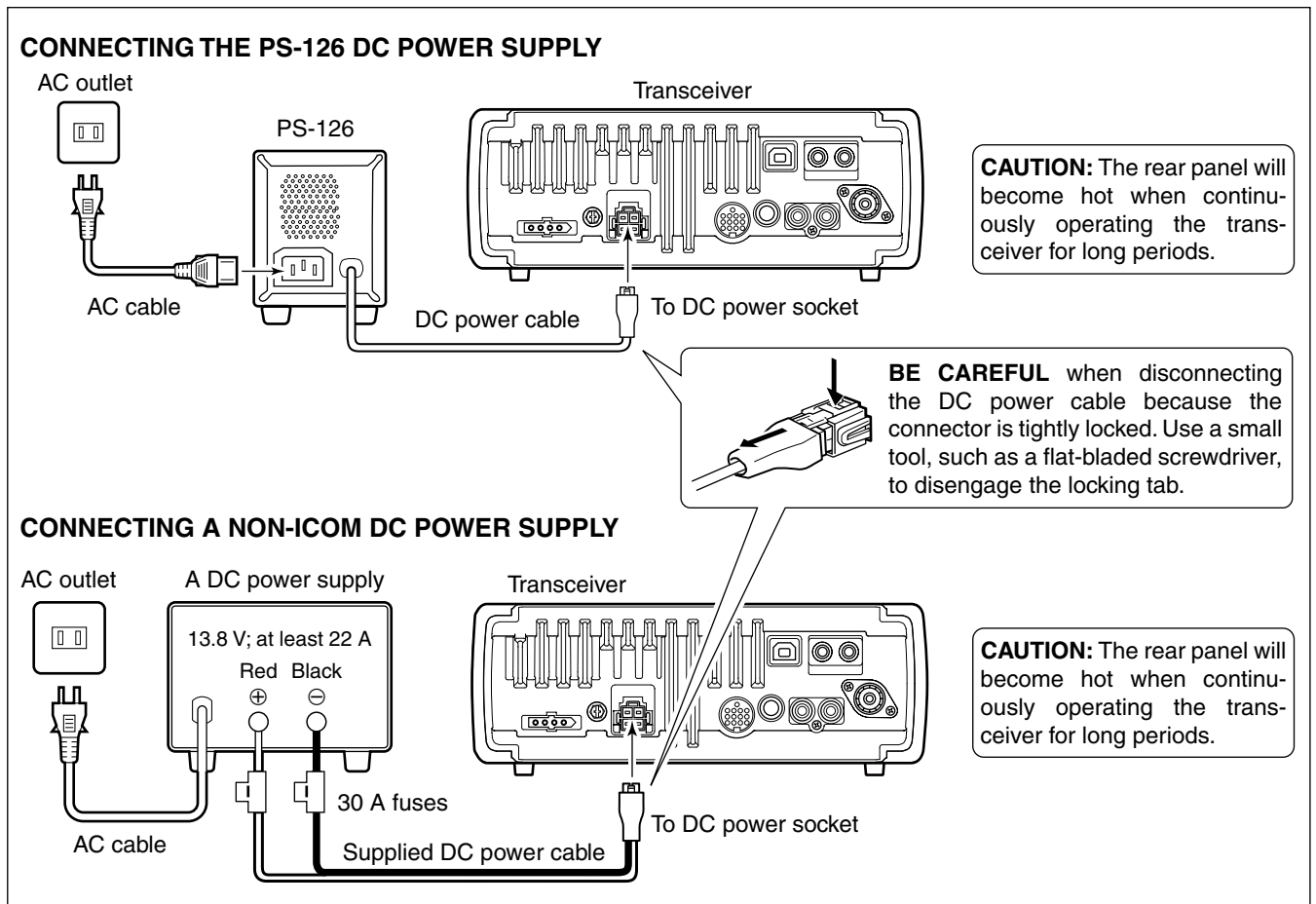

Battery connections

- **⚠ WARNING! NEVER** connect to a battery without supplying a DC fuse, otherwise a fire hazard could occur.
- **NEVER** connect the transceiver to a 24 V battery.

The transceiver may not receive well on some frequencies when installed in a hybrid vehicle, or any type of electric vehicle (fuel cell vehicle). This is because vehicle's electric components such as the inverter system generate a lot of electric noise.

- **DO NOT** use a cigarette lighter socket as a power source when operating in a vehicle. The plug may cause voltage drops and ignition noise may be superimposed onto transmit or receive audio.
- Use a rubber grommet when passing the DC power cable through a metal plate to prevent a short circuit.

The IC-7200 is not certified for vehicle installation in European countries.

CONNECTING A VEHICLE BATTERY

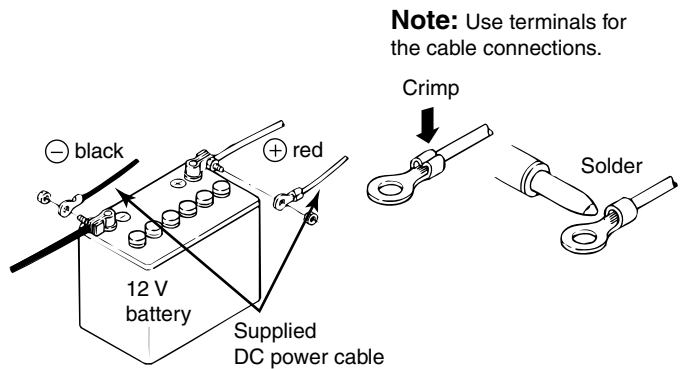
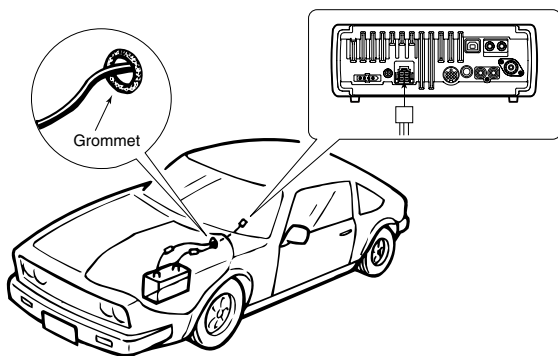

External antenna tuners

CONNECTING an AH-4

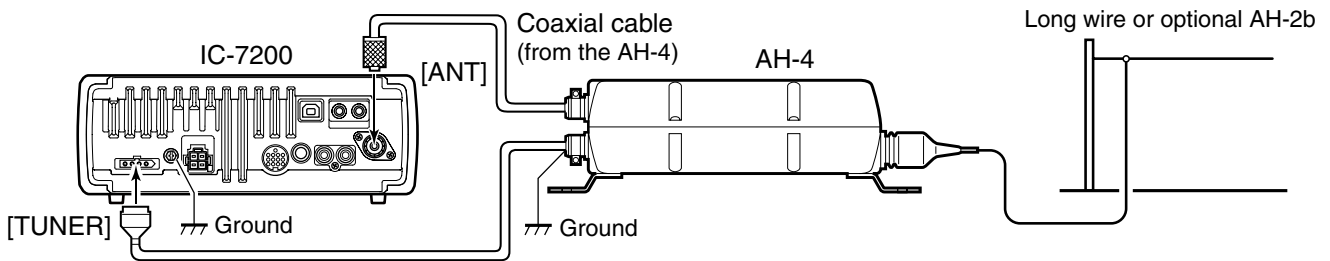

CONNECTING an AT-180

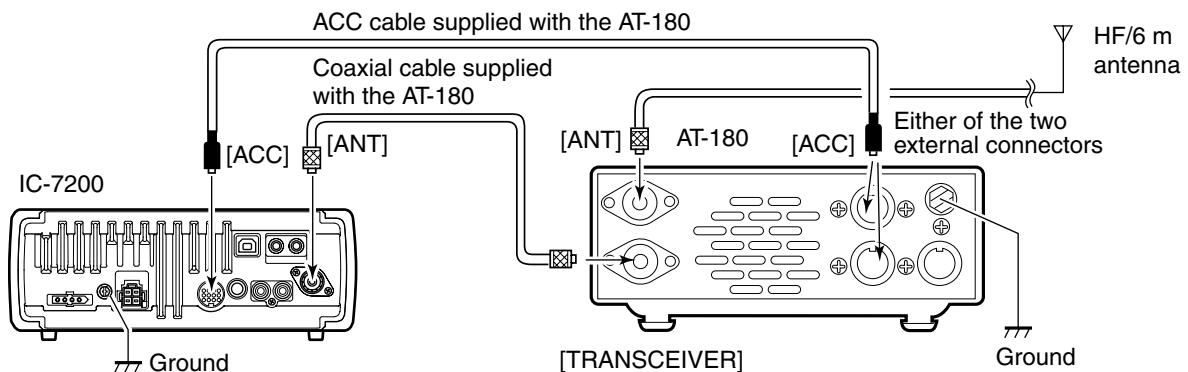

- Turn the IC-7200's power OFF when connecting the AT-180, otherwise, the CPU may malfunction and the AT-180 may not function properly.

■ Connecting a linear amplifier

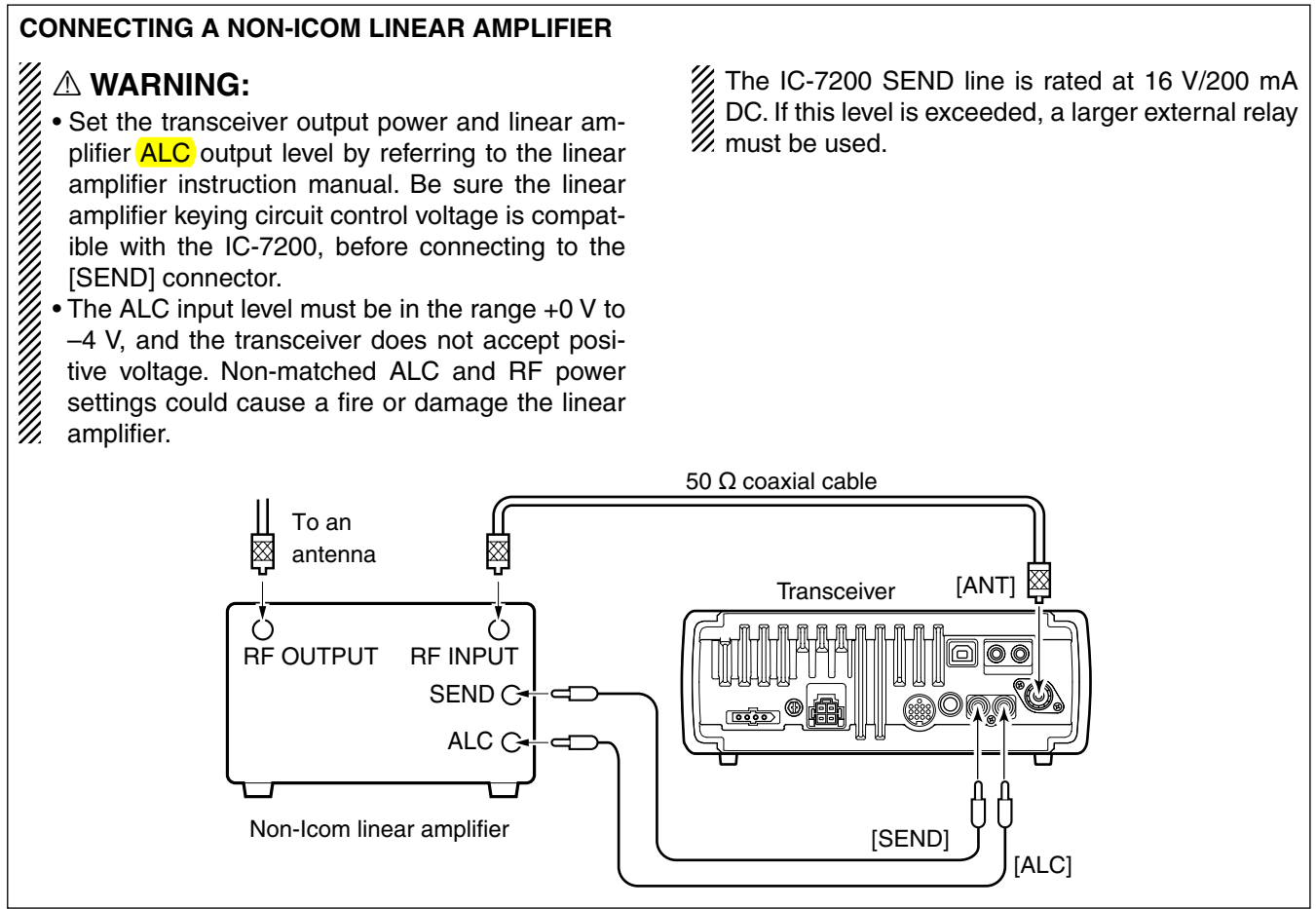
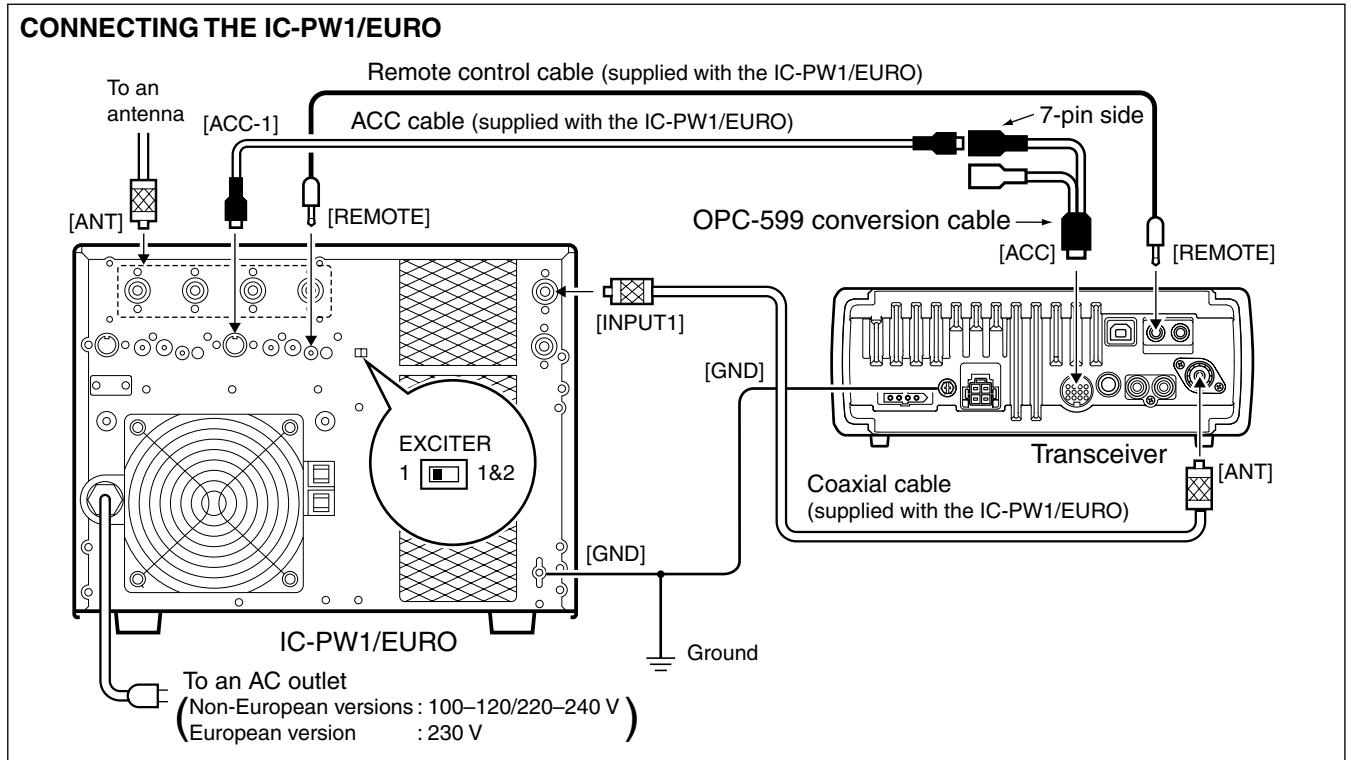

■ Connecting a CW keyer

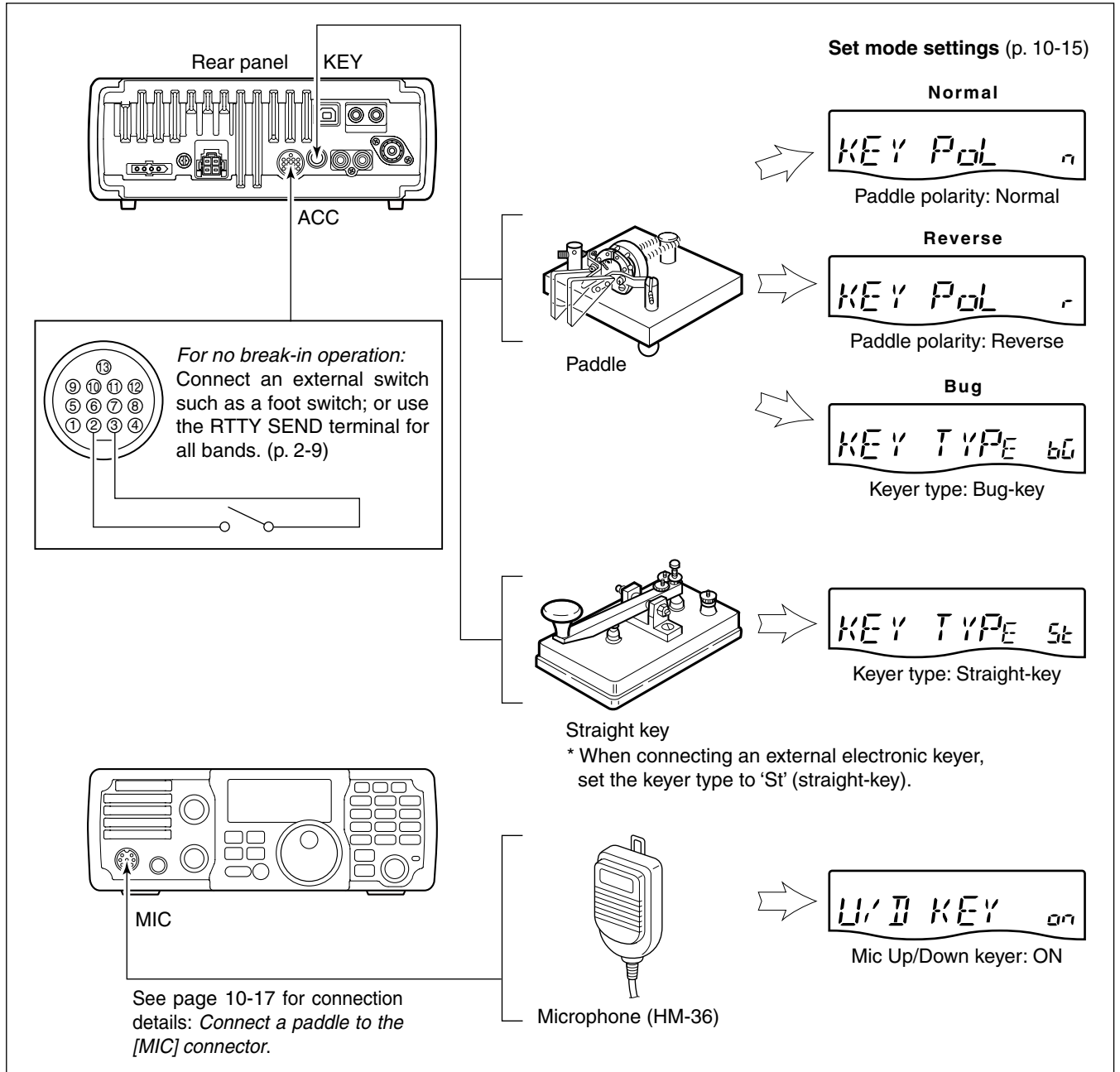

■ Connecting a PC/TNC for RTTY

◇ Connections for RTTY (FSK)

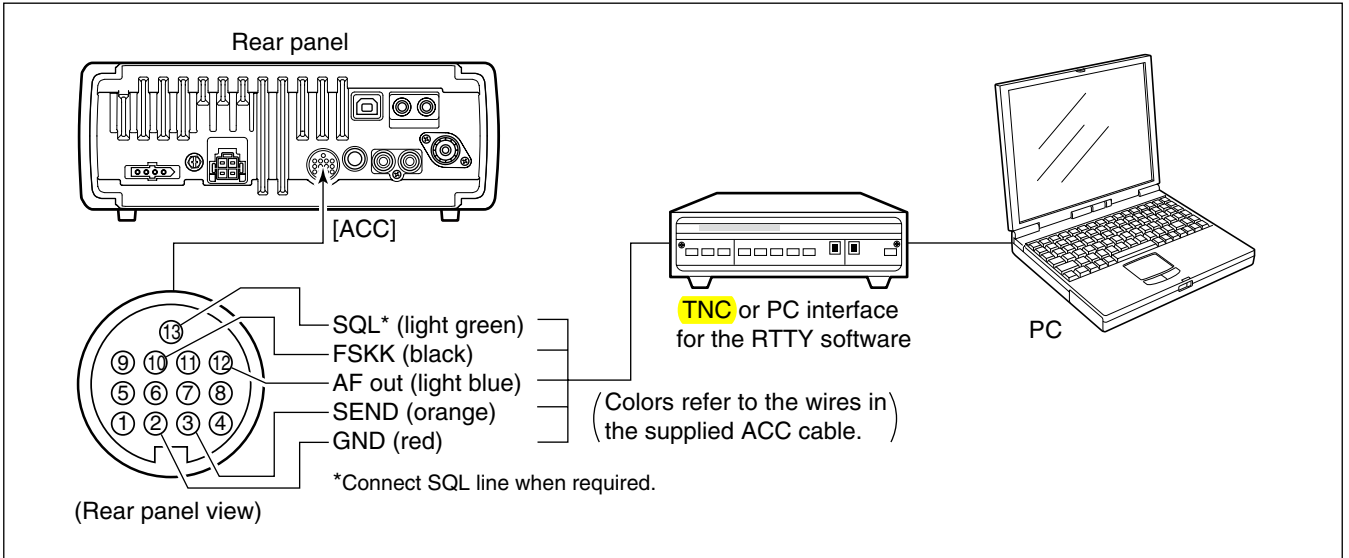

◇ Connections for RTTY (AFSK)

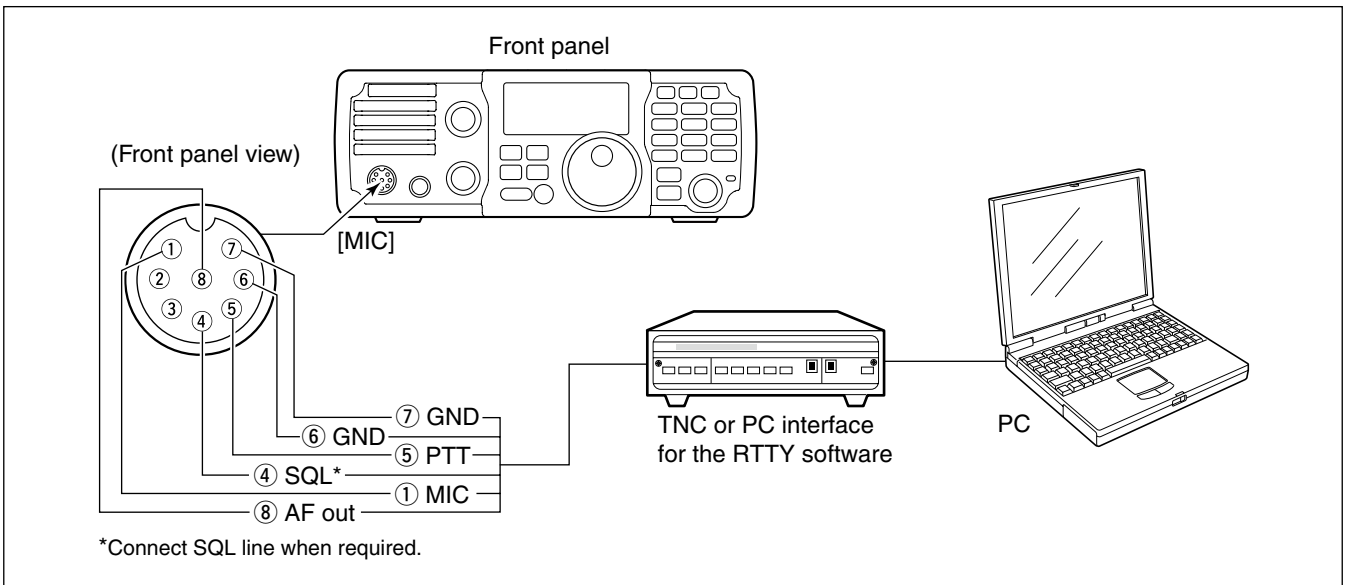

■ Connecting a PC/TNC for **SSTV** or PSK31

◇ Connecting to the [ACC] socket

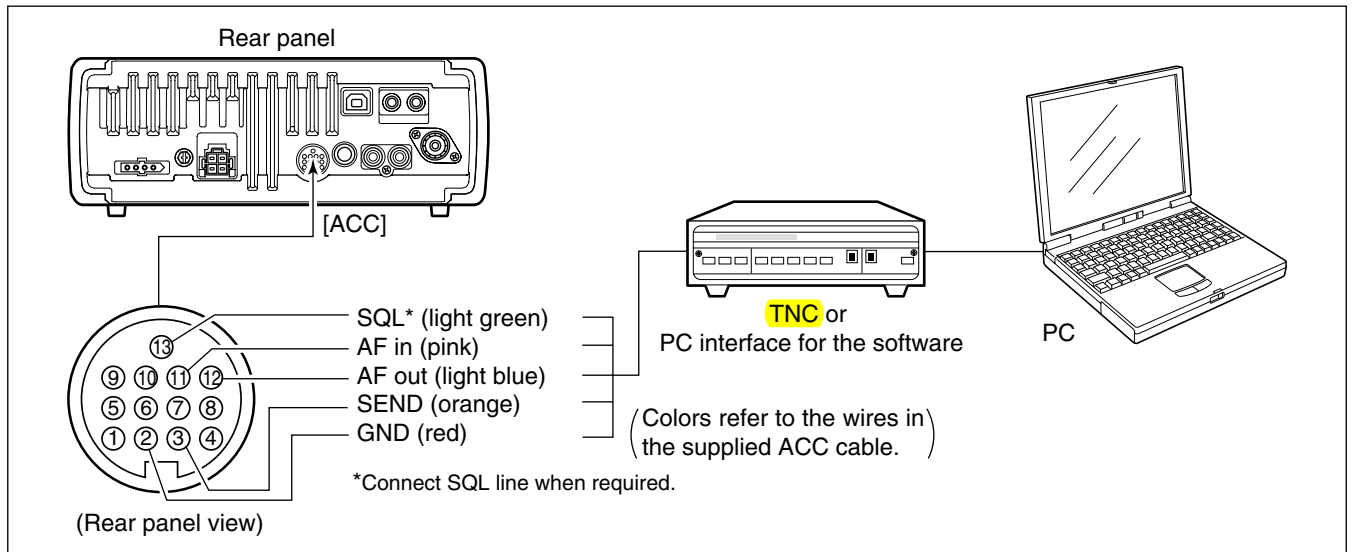

◇ Connecting to the [MIC] connector

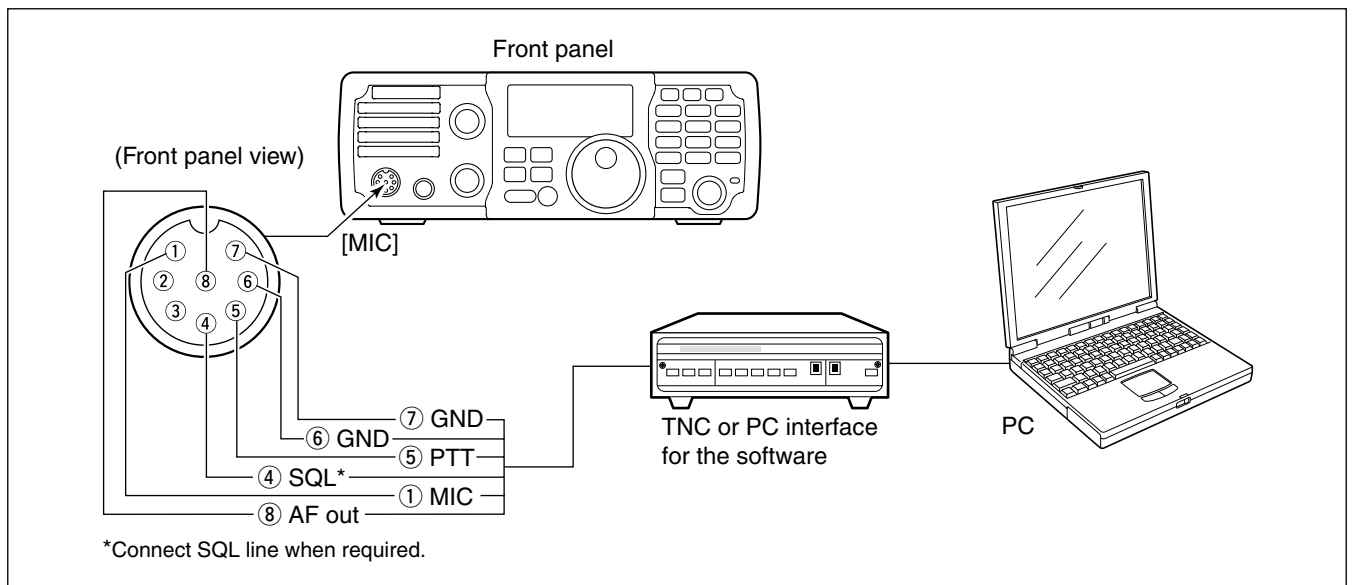

◇ Connecting to the [USB] jack

Connect an USB cable (third party's) between the transceiver's USB jack and PC. (p. 1-15)

The USB driver and the installation guide can be downloaded from our website.

➡ <http://www.icom.co.jp/world/>

- Understanding the VFO 3-2
- VFO operation 3-2
 - ◇ Selecting the VFO A or B..... 3-2
 - ◇ Equalizing the VFOs 3-2
- Selecting the VFO and memory modes..... 3-3
 - ◇ Understanding the VFO mode and the memory modes..... 3-3
- Selecting an operating band..... 3-4
 - ◇ Using the band stacking register 3-4
- Setting the operating frequency..... 3-5
 - ◇ Using the main dial 3-5
 - ◇ Entering a frequency from the keypad..... 3-6
 - ◇ Quick tuning function 3-7
 - ◇ Selecting 'kHz' step..... 3-7
 - ◇ Selecting the 1 Hz and 10 Hz tuning steps..... 3-8
 - ◇ TS switch flow chart 3-8
 - ◇ Selecting the Auto tuning step 3-9
 - ◇ Using the $\frac{1}{4}$ tuning function (SSB data/CW/RTTY only) 3-9
 - ◇ Setting the Band edge warning beep..... 3-10
 - ◇ About the 5 MHz band operation (USA version only) .. 3-10
- Selecting the operating mode..... 3-11
- Adjusting the audio volume 3-11
- Locking the Dial 3-12
- Using the RF gain and Squelch control..... 3-12
- Selecting the Meter function 3-13
- Using the Voice synthesizer function 3-13
- Basic transmit operation 3-14
 - ◇ Transmitting 3-14
 - ◇ Setting the Output power and Microphone gain 3-14

■ Understanding the VFO

VFO is an abbreviation of Variable Frequency Oscillator. The IC-7200 VFOs can store frequencies and operating modes.

You can set a desired frequency in the VFOs with the keypad or the memory copy function. (p. 7-5)

You can also change the frequency with **[DIAL]** and select an operating mode with **[MODE]** or call up previously accessed frequencies and modes with the **band** stacking register. (p. 3-4)

The IC-7200 has two VFOs, VFO A and VFO B, especially suited for **split** frequency operation. You can use the desired VFO to select a frequency and operating mode.

■ VFO operation

◇ Selecting the VFO A or B

➔ Push **[A/B =]** to select either VFO A or VFO B.

◇ Equalizing the VFOs

➔ Hold down **[A/B =]** for 1 second to set the undisplayed VFO frequency and mode to the displayed VFO frequency and mode.

- 3 beeps sound when the VFO equalization is completed.

✓ **CONVENIENT**
Use the two VFOs as quick memories
 When you find a new station, but you wish to continue searching, the two VFO systems can be used for quick memory storage.

- ① Hold down **[A/B =]** for 1 second to store the displayed frequency into the undisplayed VFO.
- ② Continue searching for stations.
- ③ Push **[A/B =]** to retrieve the stored frequency.
- ④ To continue searching for a station, push **[A/B =]** again.

The frequency and mode of VFO A and VFO B are equalized.

■ Selecting the VFO and memory modes

➔ Push  to toggle between the VFO and the memory modes.

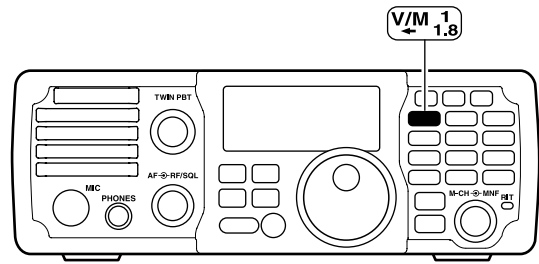

◇ Understanding the VFO mode and the memory modes

VFO MODE

Each VFO display shows a frequency and operating mode. If the frequency or mode is changed, the VFO automatically memorizes the new frequency or mode.

If another VFO or memory channel is selected, when the original VFO is selected again, the last used frequency and mode of the selected VFO appears.

[EXAMPLE]

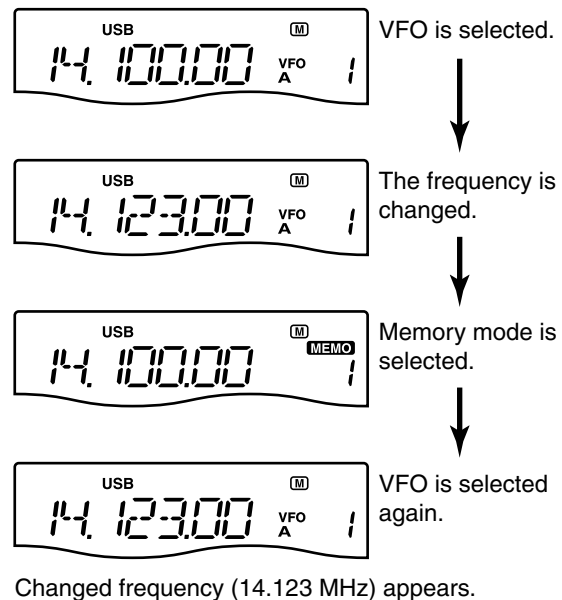

MEMORY MODE (pp. 7-2-7-6)

Each memory channel shows a frequency and operating mode like a VFO. Even if the frequency or mode is changed, the memory channel does not memorize the new frequency or operating mode.

Even if the frequency and mode are changed in the memory, then another memory or VFO is selected, when the first memory is selected again, its original programmed frequency and mode appear.

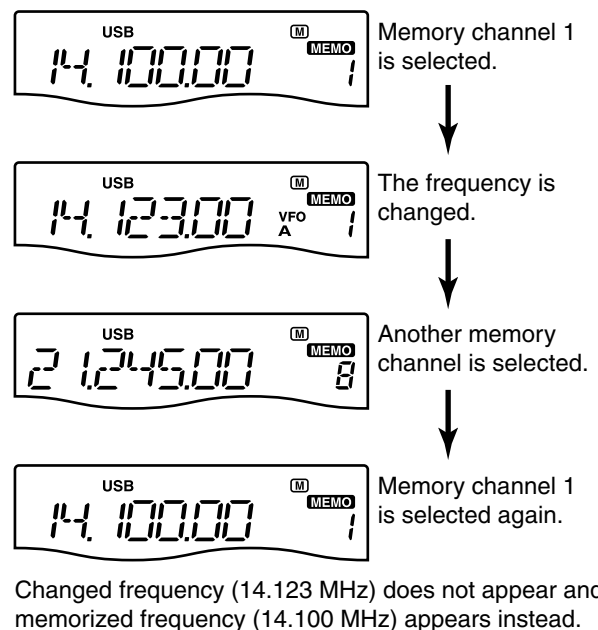

■ Selecting an operating band

The transceiver has a **band** stacking register. This function automatically memorizes the last operating frequency and mode used on a particular band. This is convenient for contest operation.

See the table below for a list of the bands available and the default settings for each register.

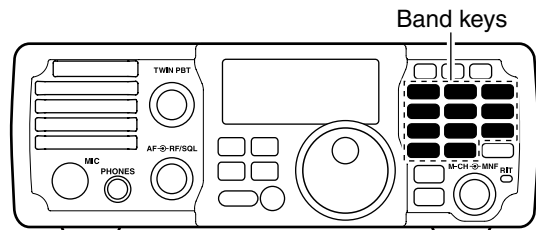

BAND	REGISTER	BAND	REGISTER
1.8 MHz	1.900000 MHz CW	21 MHz	21.200000 MHz USB
3.5 MHz	3.550000 MHz LSB	24 MHz	24.950000 MHz USB
7 MHz	7.050000 MHz LSB	28 MHz	28.500000 MHz USB
10 MHz	10.120000 MHz CW	50 MHz	50.100000 MHz USB
14 MHz	14.100000 MHz USB	General	15.000000 MHz USB
18 MHz	18.100000 MHz USB		

◇ Using the band stacking register

Example: Selecting the 14 MHz band

- ① Hold down **F-INP ENT BAND** for 1 second to enter the band selection mode.
- ② Push **5/14** to select 14 MHz band.
 - The last operated frequency and mode are selected.
- ③ Push **MODE** to select an operating mode; rotate **[DIAL]** to select an operating frequency.

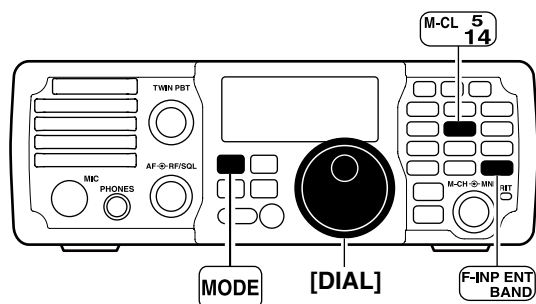
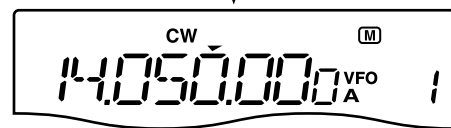

■ Setting the operating frequency

The transceiver has several tuning methods for convenient frequency tuning.

◇ Using the main dial

① After holding down **F-INP ENT BAND** for 1 second, push the desired band key to select the corresponding **band**.

- When you push **GENE**, the general coverage receiver mode is selected.

② Rotate **[DIAL]** to set the desired frequency.



21 MHz band is selected.

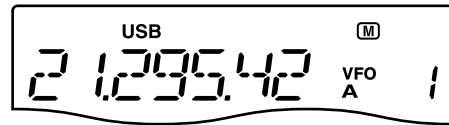

NOTE: If the dial lock function is ON, “**TR-O**” (lock icon) appears, and **[DIAL]** is disabled.

➔ Hold down **SPCH TR-O** for 1 second to turn the dial lock function ON or OFF. (see p. 3-12 for details)

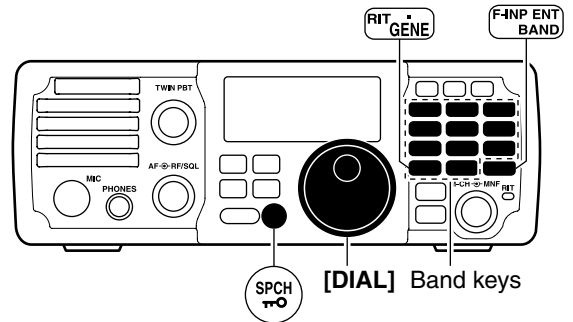

3 BASIC OPERATION

■ Frequency setting (Continued)

◇ Entering a frequency from the keypad

The transceiver has a keypad for direct frequency entry, as described below.

- ① Push **F-INP ENT BAND**.
- ② Input the desired frequency with the numeric keys on the keypad.
 - Push **GENE** to input “.” (decimal point) between the MHz digits and kHz digits.
- ③ Push **F-INP ENT BAND** to set the input frequency.
 - To cancel the input, push **M-CH/RIT SET** (or any key except a keypad key.)

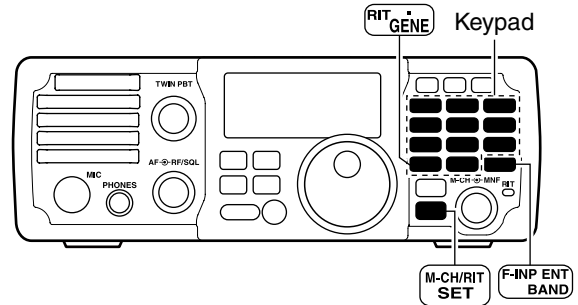

[EXAMPLE]

• 14.025 MHz

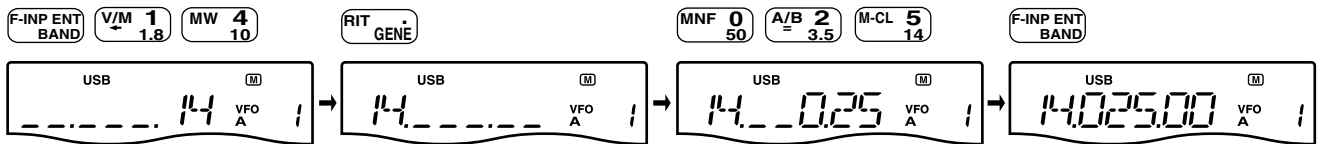

• 706 kHz

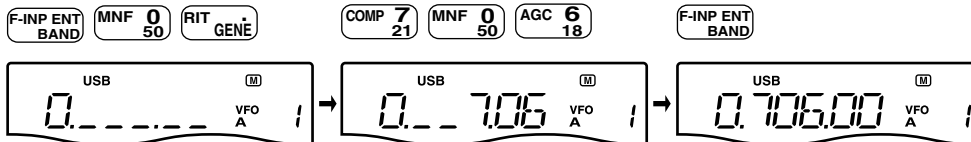

• 21.280 MHz → 21.245 MHz

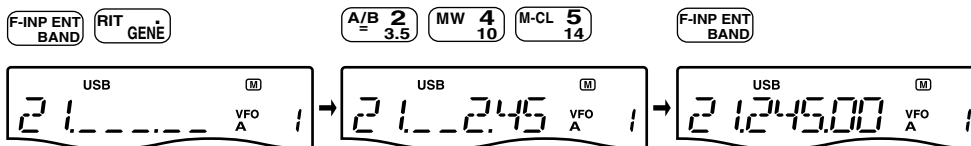

3 BASIC OPERATION

■ Frequency setting (Continued)

◇ Quick tuning function

The operating frequency can be changed in steps of 0.1, 1, 5, 9 or 10 kHz selectable for quick tuning.

- 1 Push **[TS]** to turn ON the Quick tuning function.
 - “▼” appears.
- 2 Rotate **[DIAL]** to change the frequency in programmed kHz steps.
- 3 Push **[TS]** again to turn OFF the Quick tuning function.
 - “▼” disappears.
- 4 Rotate **[DIAL]** for normal tuning, if desired.

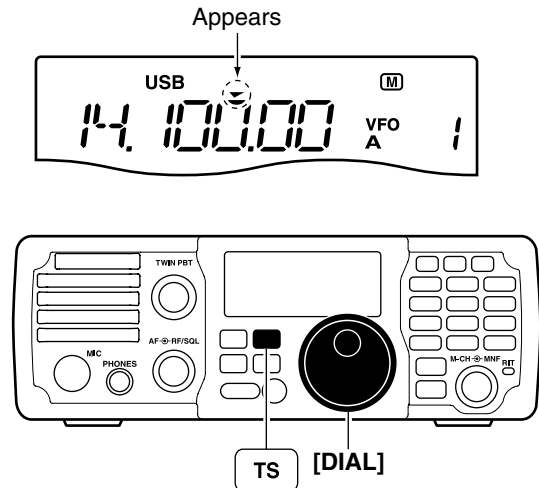

◇ Selecting 'kHz' step

When the Quick tuning function is selected, the frequency can be changed in the selected 'kHz' steps.

- 0.1, 1, 5, 9 or 10 kHz are selectable.

- 1 Push **[TS]** to turn ON the Quick tuning function.
 - “▼” appears.
- 2 Hold down **[TS]** for 1 second to enter the **tuning step Set mode**.
- 3 Rotate **[DIAL]** to select the desired tuning step of 0.1, 1, 5, 9 or 10 kHz.
- 4 Push **[TS]** to exit the tuning step Set mode.
- 5 Rotate **[DIAL]** to change the frequency according to the set tuning step.
- 6 Push **[TS]** to turn OFF the Quick tuning function.
 - “▼” disappears.

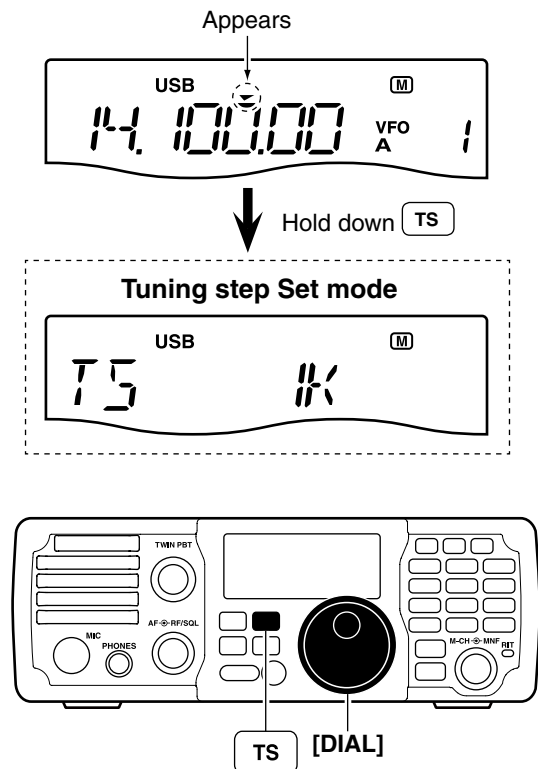

3 BASIC OPERATION

■ Frequency setting (Continued)

◇ Selecting the 1 Hz and 10 Hz tuning steps

When the Quick **tuning step** icon, “▼,” disappears, rotating **[DIAL]** changes the frequency in increments of 1 or 10 Hz.

NOTE: The frequency is changed in 50 Hz steps when the [UP]/[DN] switches of the microphone are used for the frequency setting (when the Quick tuning function is not selected, “▼” disappears.)

➔ Hold down **[TS]** for 1 second to toggle between the 1 Hz and 10 Hz step settings.

- When the 1 Hz step is selected, the 1 Hz digit appears in the frequency display; when the 10 Hz step is selected, the 1 Hz digit disappears from the frequency display.
- Rotating **[DIAL]** changes the frequency in 1 Hz or 10 Hz tuning step.

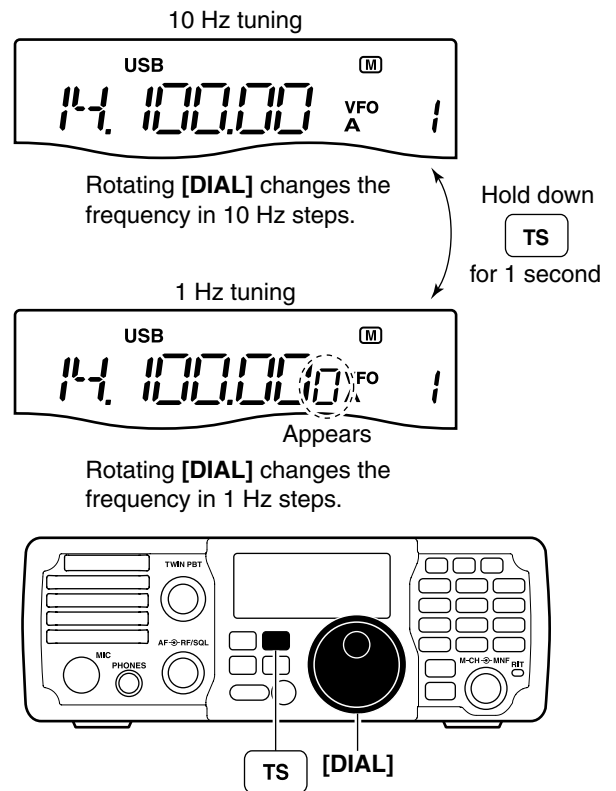

◇ **[TS]** switch flow chart

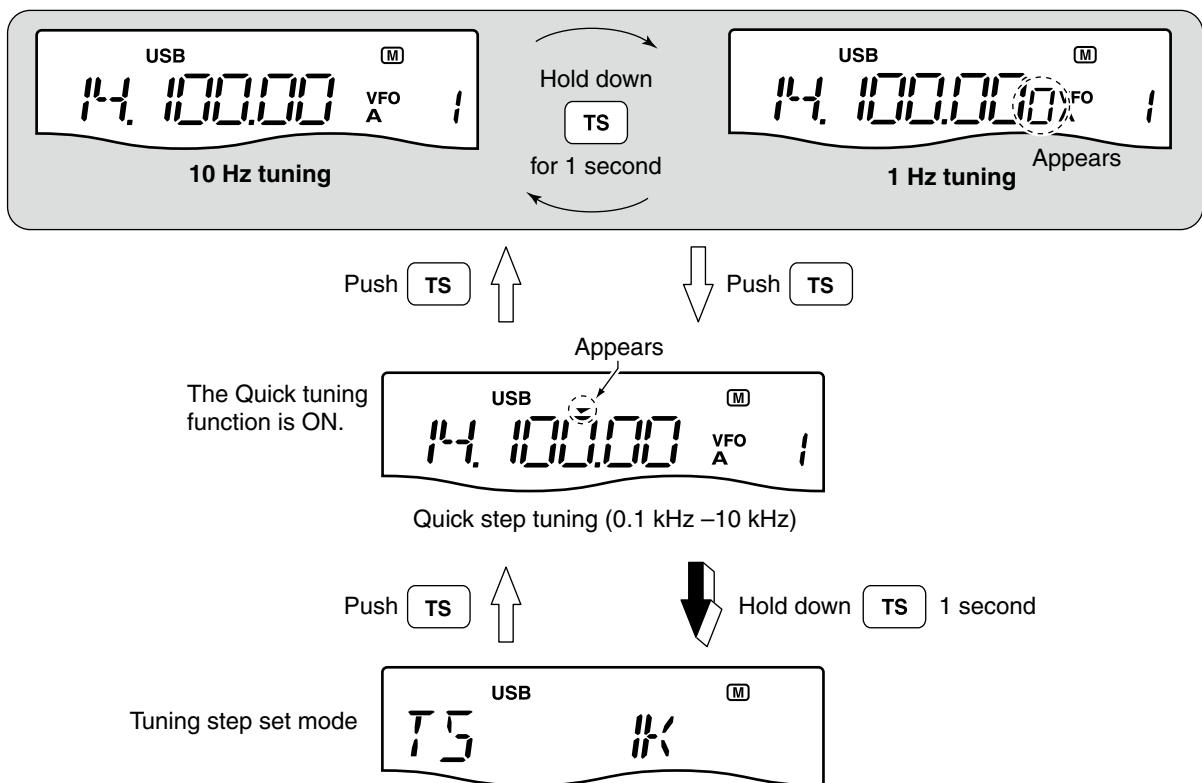

3 BASIC OPERATION

■ Frequency setting (Continued)

◇ Selecting the Auto tuning step

When rotating the tuning dial rapidly, the tuning speed accelerates automatically if selected.

- ① Hold down **M-CH/RIT SET** for 1 second twice to enter the Set mode.
- ② Rotate **[M-CH]** to select "AUTo TS."
- ③ Rotate **[DIAL]** to select the desired tuning speed between HI (High), Lo (Low) and oF (OFF).
 - HI: Approximately 5 times faster when the tuning step is set to 1 kHz or smaller steps; approximately 2 times faster when the tuning step is set to 5 kHz or larger steps.
 - Lo: Approximately 2 times faster
 - oF: Auto tuning step is turned OFF
 - Hold down **M-CL** for 1 second to select a default option or value.
- ④ Push **M-CH/RIT SET** to exit the Set mode.

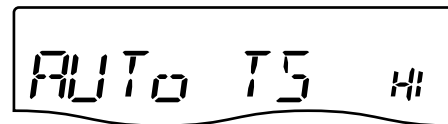

When "HI" is selected (default)

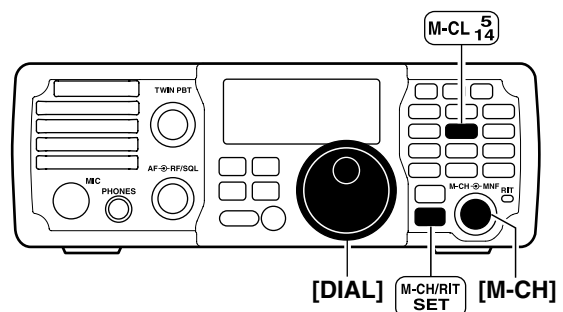

◇ Using the 1/4 tuning function (SSB data/CW/RTTY only)

While operating in SSB data/CW/RTTY, the 1/4 tuning function can be used for critical tuning. Dial sensitivity is reduced to 1/4 of normal when the 1/4 function is in use.

- ① Hold down **M-CH/RIT SET** for 1 second twice to enter the Set mode.
- ② Rotate **[M-CH]** to select "DIAL 1/4."
- ③ Rotate **[DIAL]** to select the 1/4 tuning function ON or OFF.
 - Hold down **M-CL** for 1 second to select a default option or value.
- ④ Push **M-CH/RIT SET** to exit the Set mode.

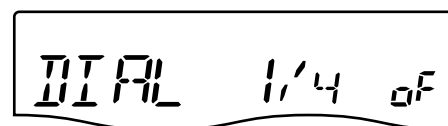

When "OFF" is selected (default)

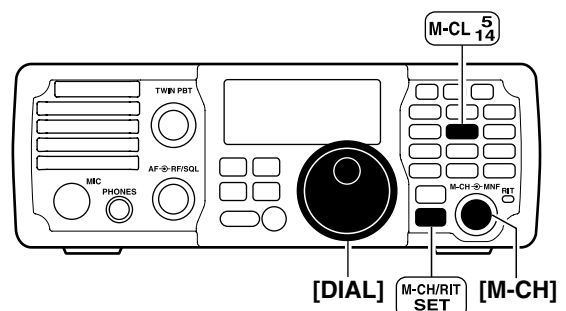

/// **NOTE:** This function is only selectable when the Quick tuning function is OFF. (p. 3-7)

3 BASIC OPERATION

■ Frequency setting (Continued)

◇ Setting the Band edge warning beep

When selecting a frequency that is outside of a **band's** specified frequency range, a warning beep sounds. The beep function can be turned OFF in the Set mode, if desired.

- ① Hold down **M-CH/RIT SET** for 1 second twice to enter the Set mode.
- ② Rotate **[M-CH]** to select "BAND BEP."
- ③ Rotate **[DIAL]** to turn the band edge warning beep function ON or OFF.
 - Hold down **M-CL** for 1 second to select a default option or value.
- ④ Push **M-CH/RIT SET** to exit the Set mode.

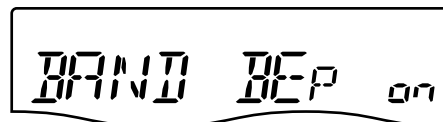

When "ON" is selected (default)

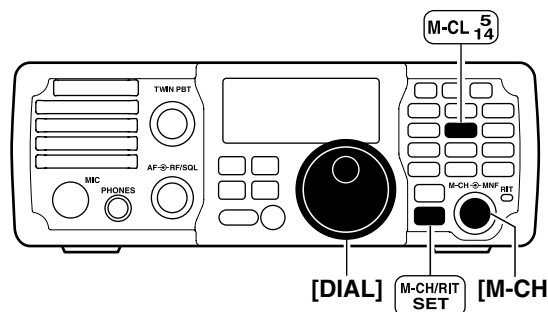

◇ About the 5 MHz band operation (USA version only)

Operation on the 5 MHz frequency band is allowed on 5 discrete frequencies and must adhere to the following:

- The USB, USB Data and CW modes
- Maximum of 100 watts ERP (Effective Radiated Power)
- 2.8 kHz **bandwidth** (maximum)

It is your responsibility to set all controls so that transmission in this frequency band meets the stringent conditions under which amateur operations may use these frequencies.

NOTE: We recommend that you store these frequencies, modes and **filter** settings into memory channels, for easy recall.

To assist you in operating within the rules specified by the FCC, transmission is illegal on any frequencies other than the five shown in the tables to the right.

• For the USB and USB Data modes

The FCC specifies center frequencies on the 5 MHz frequency band. However, the transceiver displays **carrier** frequency. Therefore, tune the transceiver to 1.5 kHz below the specified FCC channel center frequency.

Transceiver Displayed Frequency	FCC Channel Center Frequency
5.33050 MHz	5.33200 MHz
5.34650 MHz	5.34800 MHz
5.35700 MHz	5.35850 MHz
5.37150 MHz	5.37300 MHz
5.40350 MHz	5.40500 MHz

• For the CW mode

The transceiver displays the center frequency. Therefore, tune the transceiver to the specified FCC channel frequency when you operate in these mode.

Transceiver Displayed Frequency	FCC Channel Center Frequency
5.33200 MHz	5.33200 MHz
5.34800 MHz	5.34800 MHz
5.35850 MHz	5.35850 MHz
5.37300 MHz	5.37300 MHz
5.40500 MHz	5.40500 MHz

■ Selecting the operating mode

The following modes are selectable in the IC-7200: SSB (USB/LSB), SSB data (USB data/LSB data), CW, CW-R (CW Reverse), RTTY, RTTY-R (RTTY Reverse), AM and AM data modes.

- ➔ Push **MODE** one or more times to select the desired operation mode.
 - The selected mode icon is displayed on the display.
- ➔ In the SSB mode, hold down **MODE** for 1 second to toggle between USB and LSB.
- ➔ In the CW mode, hold down **MODE** for 1 second to toggle between CW and CW Reverse.
- ➔ In the RTTY mode, hold down **MODE** for 1 second to toggle between RTTY and RTTY Reverse.
- ➔ SSB data (USB data/LSB data) or AM data mode can be selected in the Quick Set mode.

- 1 Push **MODE** to select the SSB or AM mode.
 - After the SSB mode is selected, hold down **MODE** for 1 second to toggle between the USB and LSB modes.
- 2 Hold down **M-CH/RIT SET** for 1 second to enter the Quick Set mode.
- 3 Rotate **[M-CH]** to select "DATA" to set the data mode.
- 4 Rotate **[DIAL]** to turn the data mode ON or OFF.
 - "D" appears when the data mode is turned ON.
- 5 Push **M-CH/RIT SET** to exit the Quick Set mode.

NOTE: If a desired operating mode cannot be selected, it may be disabled in the Set mode. (p. 10-16)

OPERATING MODE SELECTION

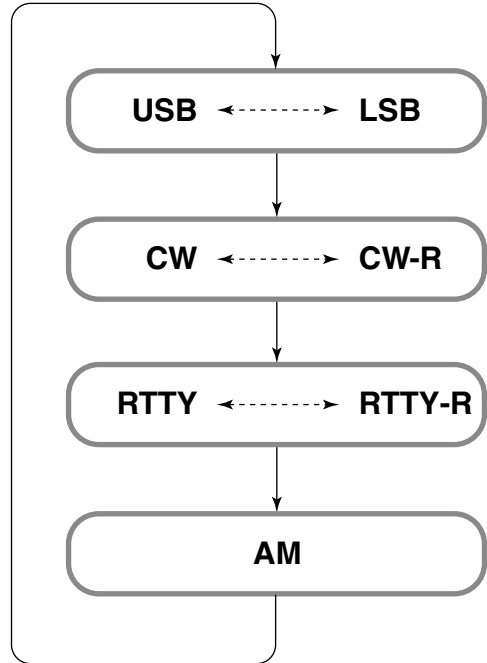

- ➔ Hold down **MODE** for 1 second
- ➔ Push **MODE**

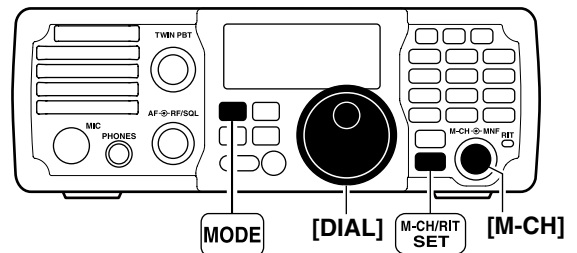

■ Adjusting the audio volume

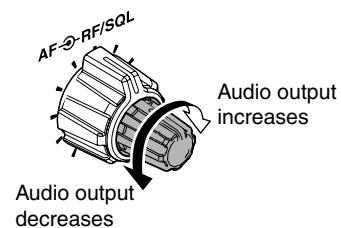
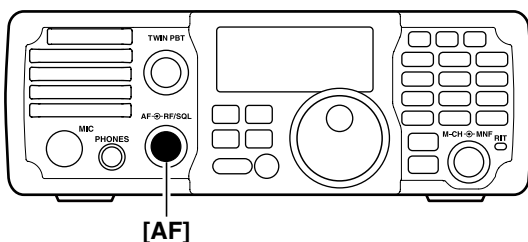

Rotate the **[AF]** control clockwise to increase the audio output level; counterclockwise to decrease it.

- Set a suitable audio level.



■ Locking the Dial

The dial lock function prevents accidental changes by [DIAL] being rotated.

- ➔ Hold down  for 1 second to turn the dial lock function ON or OFF.
 - “” appears when the dial lock function is ON.

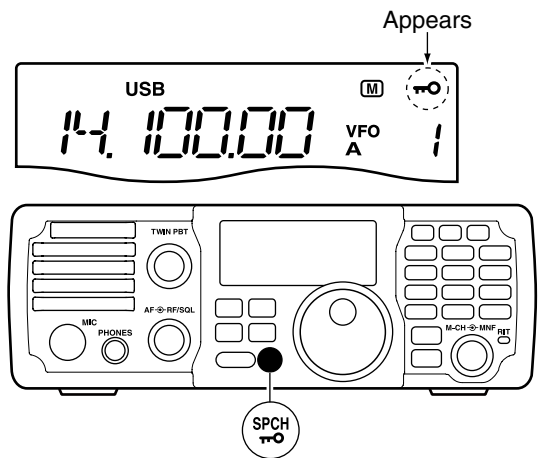

■ Using the RF gain and Squelch control

The [RF/SQL] control adjusts the RF gain and squelch threshold level. The squelch stops noise output from the speaker (closed position) when no signal is received.

- The 12 o'clock position is recommended for any setting of the [RF/SQL] control.
- The [RF/SQL] control can be set as the RF gain control only (squelch is fixed open) or squelch control (RF gain is fixed at maximum) in the Set mode (p. 10-10).

MODE	SET MODE SETTING		
	AUTO	SQL	RF + SQL
SSB, CW RTTY	RF GAIN	SQL	RF GAIN + SQL
AM	SQL	SQL	RF GAIN + SQL

○ **Adjusting the RF gain** (Receive **sensitivity**)
Normally, the [RF/SQL] control is set to the 12 o'clock position.

Rotate the [RF/SQL] control to the 11 o'clock position for maximum sensitivity.

- Rotate the [RF/SQL] control clockwise to increase the receiver sensitivity, counterclockwise to decrease it.
- The S-meter indicates receive sensitivity.

○ **Adjusting the squelch** (Removing non-signal noise)
Rotate the [RF/SQL] control to the 1 o'clock position to invoke the S-meter squelch— this allows you to set the minimum signal level needed to open the squelch.

- A segment appears in the S-meter to indicate the S-meter squelch level.

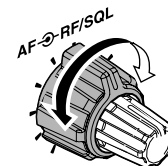
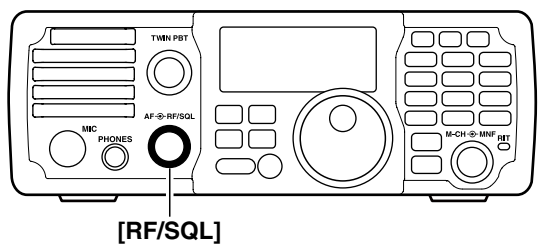

• When functioning as an RF GAIN/SQL control

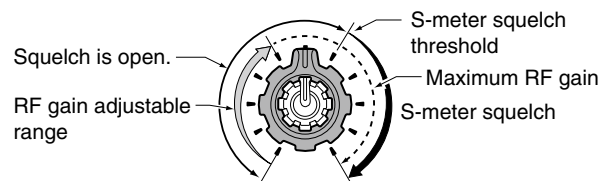

• When functioning as an RF GAIN control

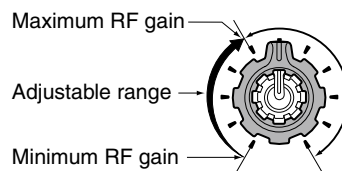

• When functioning as a SQL control

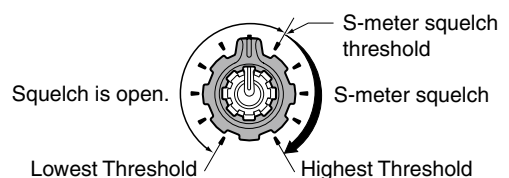

■ Selecting the Meter function

The transceiver has 3 transmit meter functions for your convenience. Select the desired meter between RF power (PO), **ALC** and **SWR**.

- ➔ Hold down **ANF METER** for 1 second to toggle between RF power (PO), SWR and ALC.
 - The display indication changes as shown in the table.

DISPLAY INDICATION	MEASUREMENT
PO	Displays the relative RF output power.
SWR	Displays the SWR on the transmission line.
ALC	Displays the ALC level. When the meter movement shows the input signal level exceeds the allowable level, the ALC limits the RF power. In such cases, reduce the MIC gain setting (see page 3-14) in the Quick Set mode.

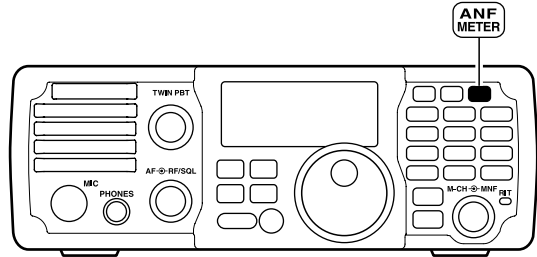

■ Using the Voice synthesizer function

The IC-7200 has a voice synthesizer. This function announces the S-meter level, operating frequency and mode in a clear, electronically generated voice, in English or Japanese.

/// **NOTE:** The S-meter level's announcement can be turned OFF. (p. 10-12)

- ① Select the desired function parameters, such as Audio level, speed, language, contents, in the Set mode. (p. 10-12)
- ② Push **SPCH** to announce the selected contents.
 - Push again to stop the announcement.

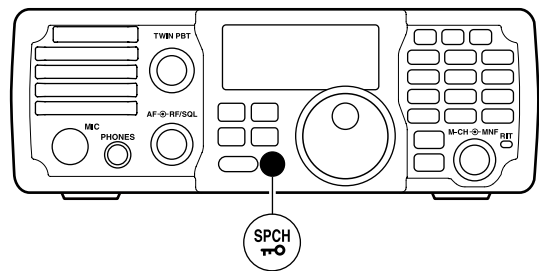

Basic transmit operation

Before transmitting, monitor your selected operating frequency to make sure transmitting won't cause interference to other stations on the same frequency.

It's good Amateur practice to listen first. On the HF bands, even if nothing is heard, ask "is the frequency in use" once or twice, before you begin operating on that frequency.

Transmitting

- ① Push [PTT] (microphone) to transmit.
 - "TX" appears.
- ② Release [PTT] to return to receive.
 - "TX" disappears.

Appears while transmitting



Setting the Output power and Microphone gain

If a linear amplifier is connected, such as the IC-PW1/EURO, set the output power using the ALC meter to the ALC zone (see "Microphone gain setting" below.) The ALC meter reading should be within this zone, otherwise the linear amplifier will not work properly.

Output power setting

- ① Hold down [M-CH/RIT SET] for 1 second to enter the Quick Set mode.
- ② Rotate [M-CH] to select "RF POWER."
- ③ Rotate [DIAL] to select the desired output level.
 - Output power is displayed in 101 steps (Low, 1–100.)
- ④ Push [M-CH/RIT SET] to exit the Quick Set mode.

Available power

SSB/CW/RTTY : 2–100 W
 AM : 1–25 W* (*Carrier power)

Microphone gain setting

Microphone gain must be adjusted properly so that your signal does not distort when transmitted.

- ① Select the SSB or AM mode.
- ② Hold down [ANF METER] for 1 second one or more times to select the ALC meter.
- ③ Hold down [M-CH/RIT SET] for 1 second to enter the Quick Set mode.
- ④ Rotate [M-CH] to select "MIC GAIN."
- ⑤ Push [PTT] to transmit.
 - Speak into the microphone at your normal voice level.
- ⑥ While speaking into the microphone, rotate [DIAL] so that the ALC meter reading stays within the ALC zone.
 - Microphone gain is adjusted in 1% steps (0% to 100%).
- ⑦ Release [PTT] to receive.
- ⑧ Push [M-CH/RIT SET] to exit the Quick Set mode.

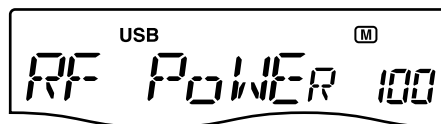
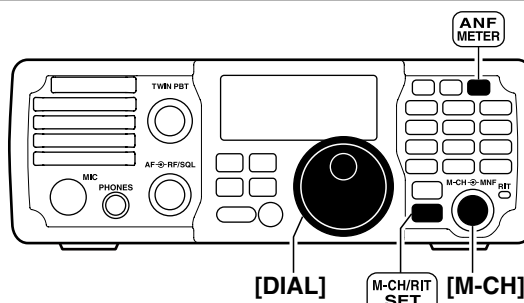

When maximum output power "100" is selected (default)



When "50" is selected (default)

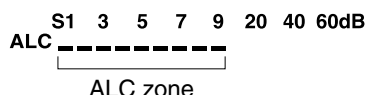

- Operating in the SSB mode..... 4-2
 - ◇ Convenient functions for receiving 4-2
 - ◇ Convenient functions for transmit..... 4-4
- Operating in the CW mode 4-5
 - ◇ Convenient functions for receiving 4-6
 - ◇ Convenient functions for transmit..... 4-7
 - ◇ Selecting the CW-R (CW reverse) mode 4-8
 - ◇ Adjusting the CW tone pitch control..... 4-8
 - ◇ Adjusting the CW side tone 4-9
 - ◇ Setting Keying speed 4-9
- Operating in the RTTY (FSK) mode 4-10
 - ◇ Convenient functions for receiving 4-10
 - ◇ Selecting the RTTY-R (RTTY reverse) mode 4-12
 - ◇ Selecting the Twin peak filter 4-12
 - ◇ RTTY decode Set mode 4-13
- Operating in the AM mode..... 4-14
 - ◇ Convenient functions for receiving 4-14
 - ◇ Convenient functions for transmit..... 4-15
- Operating in the Data mode (SSTV/PSK31) 4-16

■ Operating in the SSB mode

- ① Hold down **F-INP ENT BAND** for 1 second, then push a band key to select the desired **band**.
- ② Push **MODE** to select the SSB mode.
 - Hold down **MODE** for 1 second to toggle between the LSB and USB modes.
 - Below 10 MHz LSB is automatically selected; above 10 MHz USB is automatically selected.
- ③ Rotate **[DIAL]** to tune in a desired signal.
 - The S-meter displays the received signal strength.
- ④ Rotate the **[AF]** control to set audio to a comfortable listening level.
- ⑤ Push **[PTT]** to transmit.
 - **TX** appears.
- ⑥ Speak into the microphone at your normal voice level.
 - Adjust 'MIC Gain' at this step, if necessary. (p. 10-4)
- ⑦ Release **[PTT]** to receive.

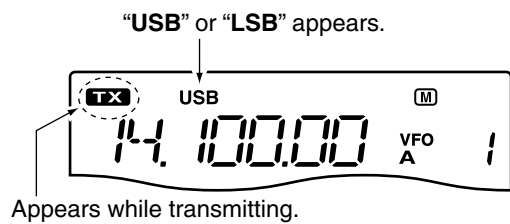
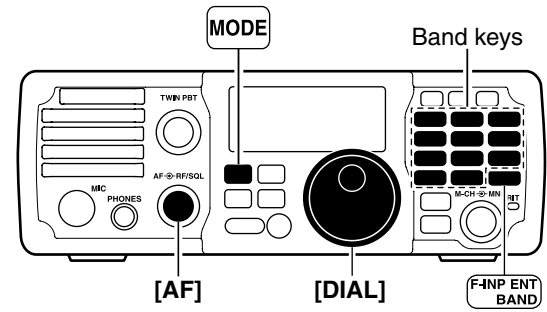

◇ Convenient functions for receiving

- **Preamp and attenuator** (p. 5-3)
 - ➔ Push **P.AMP ATT** to turn the preamp ON or OFF.
 - **P.AMP** appears when the preamp is ON.
 - ➔ Hold down **P.AMP ATT** for 1 second to turn ON the attenuator.
 - **ATT** appears when the attenuator is ON.
 - Push **P.AMP ATT** to turn OFF the attenuator.
- **Twin PBT (passband tuning)** (p. 5-4)
 - ➔ Rotate **[TWIN PBT]** (controls–inner/outer).

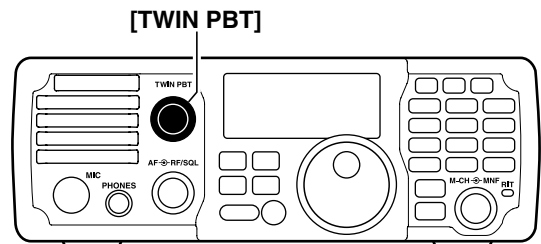
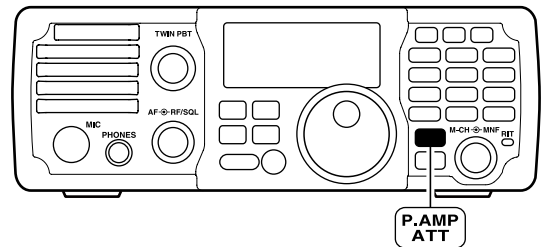

- Operating in the SSB mode
- ◇ Convenient functions for receiving (Continued)

• **AGC (auto gain control)** (p. 5-3)

- ➔ Push **[AGC]** once or twice to set the **AGC** time constant to fast or slow.
 - “**F.AGC**” appears when the fast time constant is selected, and no icon appears when the slow time constant is selected.
- ➔ Hold down **[AGC]** for 1 second to turn the AGC function OFF.
 - “**AGC-OFF**” appears.

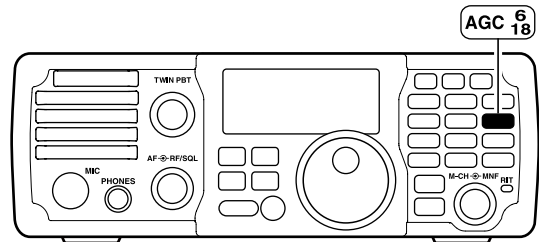

• **Noise blanker** (p. 5-7)

- ➔ Push **[NB]** to turn the **noise blanker** ON or OFF.
 - “**[NB]**” appears when the noise blanker is ON.
- ➔ Hold down **[NB]** for 1 second to enter the noise blanker Set mode. Rotate **[M-CH]** to select the item, then rotate **[DIAL]** to adjust the threshold level, or the blank width.

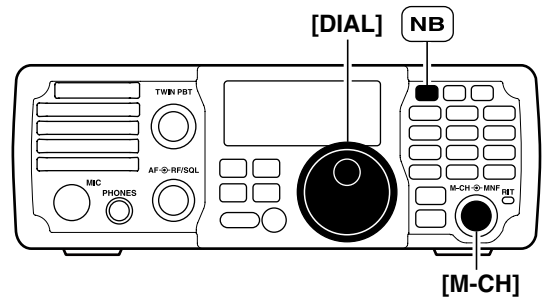

• **Noise reduction** (p. 5-8)

- ➔ Push **[NR]** to turn the **noise reduction** ON or OFF.
 - “**[NR]**” appears when the noise reduction is ON.
- ➔ Hold down **[NR]** for 1 second to enter the noise reduction level Set mode, then rotate **[DIAL]** to adjust the noise reduction level.

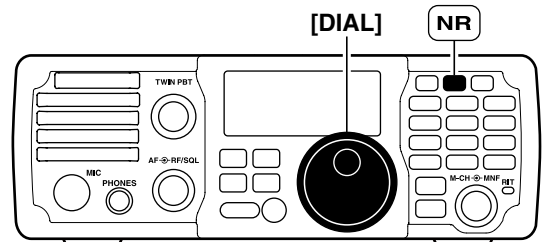

• **Manual notch filter** (p. 5-10)

- ➔ Push **[MNF]** to turn the manual **notch filter** ON or OFF.
 - “**[MNF]**” appears when the manual notch filter is ON.
- ➔ Hold down **[MNF]** for 1 second to enter the manual notch filter Set mode, then rotate **[DIAL]** to select the narrow, mid or wide filter width.

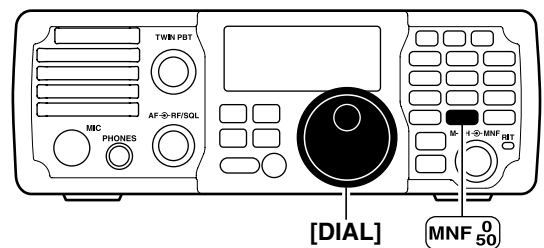

• **Auto notch filter** (p. 5-9)

- ➔ Push **[ANF METER]** to turn the auto notch filter ON or OFF.
 - “**[ANF]**” appears when the auto notch filter is ON.

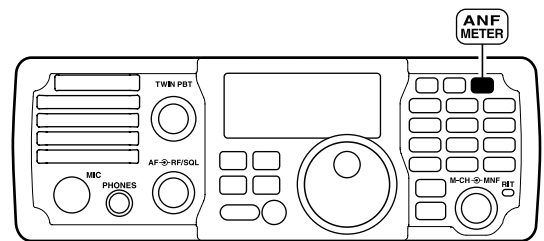

■ Operating in the SSB mode (Continued)

◇ Convenient functions for transmit

• **VOX (voice operated transmit)** (p. 6-2)

- ➔ Push **VOX** to turn the **VOX** function ON or OFF.
 - “**VOX**” appears when the VOX function is ON.
- ➔ Hold down **VOX** for 1 second to enter the VOX Set mode, then rotate **[DIAL]** to adjust the VOX gain, anti VOX gain and VOX delay.
 - Rotate **[M-CH]** to select an item.

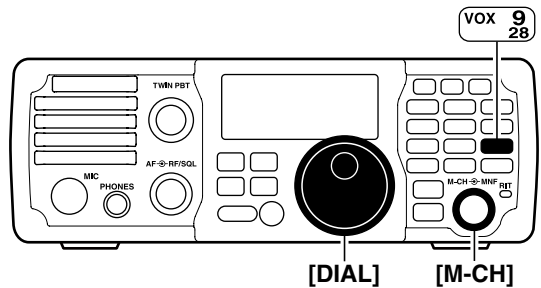

• **Speech compressor** (p. 6-6)

- ➔ Push **COMP** to turn the speech compressor ON or OFF.
 - “**COMP**” appears when the speech compressor is ON.
- ➔ Hold down **COMP** for 1 second to enter the compression level Set mode, then rotate **[DIAL]** to adjust the compression level.

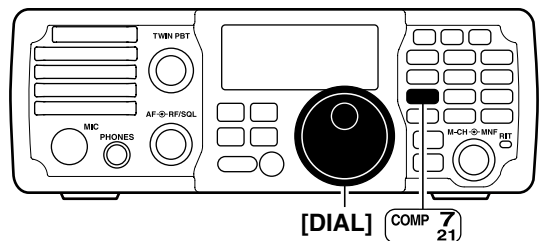

■ Operating in the CW mode

- ① Connect a paddle, straight key or external electronic keyer as described on page 2-8.
- ② Hold down **F-INP ENT BAND** for 1 second, then push a band key to select the desired **band**.
- ③ Push **MODE** to select the CW mode.
 - Hold down **MODE** for 1 second to toggle between the CW and CW-R modes.
- ④ Rotate **[DIAL]** to tune in a desired signal.
 - The S-meter displays the received signal strength when a signal is received.
- ⑤ Rotate the **[AF]** control to set the audio to a comfortable listening level.
- ⑥ Set CW break-in mode and the CW delay time in the Set mode.

- ① Hold down **M-CH/RIT SET** for 1 second twice to enter the Set mode.
- ② Rotate **[M-CH]** to select “BK-IN” to set the CW break-in mode.
- ③ Rotate **[DIAL]** to select full break-in, semi break-in or OFF.
 - FL : full break-in
 - SE : semi break-in
 - OF : break-in OFF
- ④ Rotate **[M-CH]** to select “BK-DELAY” to select the CW delay time when the semi break-in mode is selected in step ③.
- ⑤ Rotate **[DIAL]** to set the desired delay time.
- ⑥ Continue to set the keyer settings in the Set mode, if necessary. (p. 10-15)
- ⑦ Push **M-CH/RIT SET** to exit the Set mode.

- ⑦ Key to transmit, using the paddle, straight key or external electronic keyer to send your CW signals.
 - “TX” appears.
 - The Po meter displays the transmit output power.
- ⑧ Stop keying to receive.

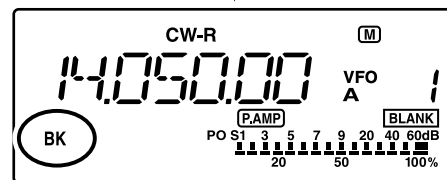
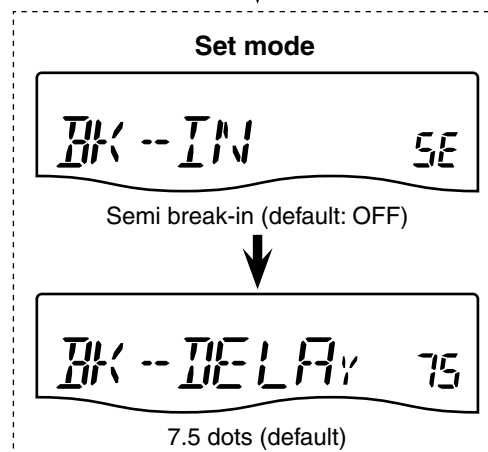
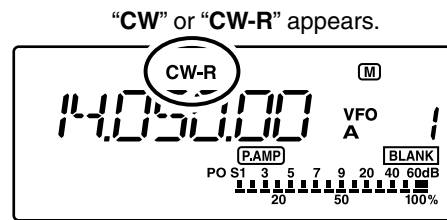

Appears when semi break-in is selected.

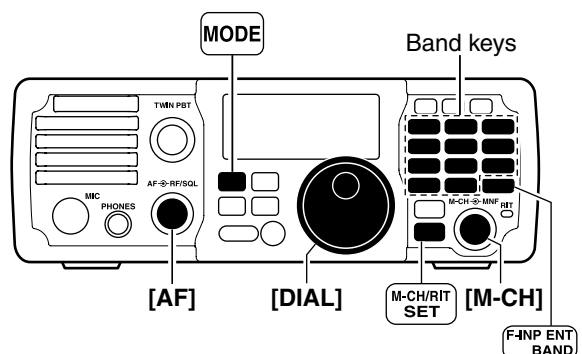
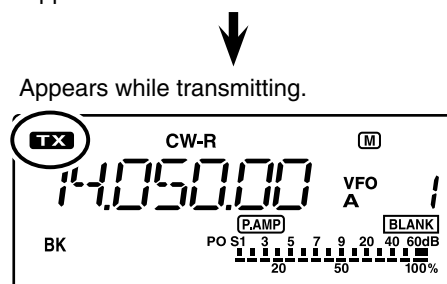

■ Operating in the CW mode (Continued)

◇ Convenient functions for receiving

• **Preamp and attenuator** (p. 5-3)

- ➔ Push **P.AMP ATT** to turn the preamp ON or OFF.
 - “**P.AMP**” appears when the preamp is ON.
- ➔ Hold down **P.AMP ATT** for 1 second to turn ON the attenuator.
 - “**ATT**” appears when the attenuator is ON.
 - Push **P.AMP ATT** to turn OFF the attenuator.

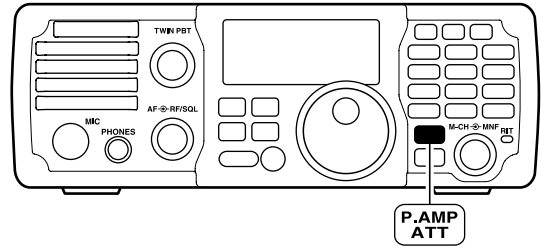

• **Twin PBT (passband tuning)** (p. 5-4)

- ➔ Rotate **TWIN PBT** (controls–inner/outer).

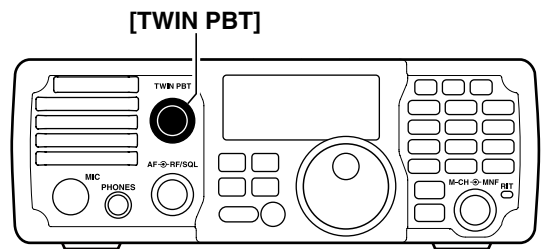

• **AGC (auto gain control)** (p. 5-3)

- ➔ Push **AGC** once or twice to set the **AGC** time constant to fast or slow.
 - “**F.AGC**” appears when the fast time constant is selected, and no icon appears when the slow time constant is selected.
- ➔ Hold down **AGC** for 1 second to turn OFF the AGC function.
 - “**AGC-OFF**” appears.

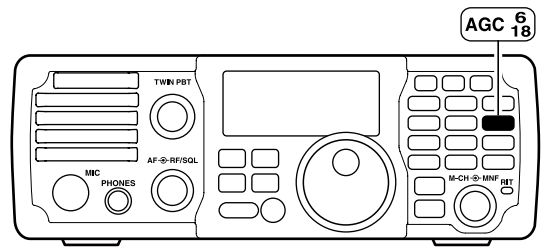

• **Noise blanker** (p. 5-7)

- ➔ Push **NB** to turn the **noise blanker** ON or OFF.
 - “**NB**” appears when the noise blanker is ON.
- ➔ Hold down **NB** for 1 second to enter the noise blanker Set mode. Rotate **[M-CH]** to select the item, then rotate **[DIAL]** to adjust the threshold level, or the blank width.

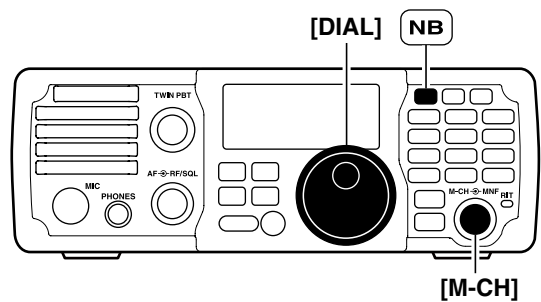

• **Noise reduction** (p. 5-8)

- ➔ Push **NR** to turn the **noise reduction** ON or OFF.
 - “**NR**” appears when the noise reduction is ON.
- ➔ Hold down **NR** for 1 second to enter the noise reduction level Set mode, then rotate **[DIAL]** to adjust the noise reduction level.

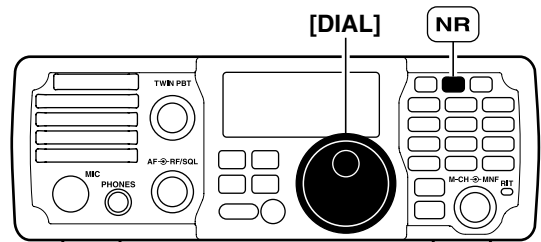

■ Operating in the CW mode
 ◇ Convenient functions for receiving (Continued)

• **Manual notch filter** (p. 5-10)

- ➔ Push **[MNF]** to turn the manual **notch filter** ON or OFF.
 - “**[MNF]**” appears when the manual notch filter is ON.
- ➔ Hold down **[MNF]** for 1 second to enter the manual notch filter Set mode, then rotate **[DIAL]** to select the narrow, mid or wide filter width.

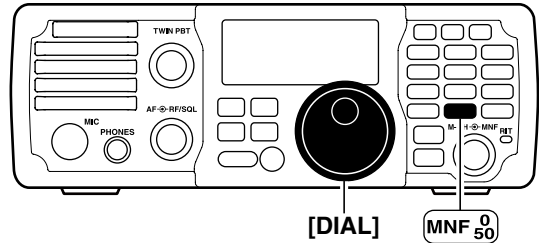

• **¼ function** (p. 10-13)

- ① Hold down **[M-CH/RIT SET]** for 1 second twice to enter the Set mode.
- ② Rotate **[M-CH]** to select “**DIAL ¼**”.
- ③ Rotate **[DIAL]** to turn the ¼ function ON or OFF.
- ④ Push **[M-CH/RIT SET]** to exit the Set mode.

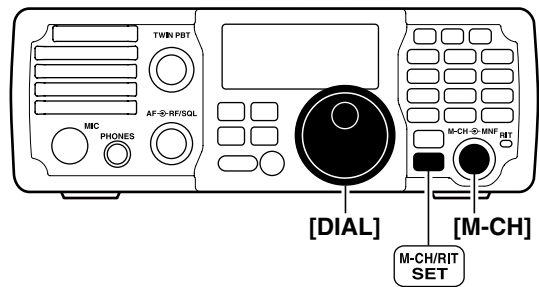

• **CW tone pitch control** (p. 10-5)

- ① Hold down **[M-CH/RIT SET]** for 1 second to enter the Quick Set mode.
- ② Rotate **[M-CH]** to select “**CW PITCH**”.
- ③ Rotate **[DIAL]** to set the desired CW tone pitch to between 300 to 900 Hz, in 10 Hz steps.
- ④ Push **[M-CH/RIT SET]** to exit the Quick Set mode.

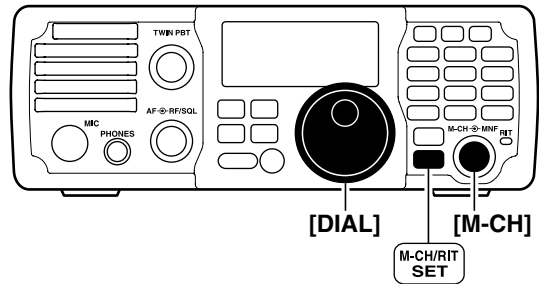

◇ **Convenient functions for transmit**

• **Break-in function** (p. 6-4)

- ① Hold down **[M-CH/RIT SET]** for 1 second twice to enter the Set mode.
- ② Rotate **[M-CH]** to select “**BK-IN**”.
- ③ Rotate **[DIAL]** to set the CW break-in to full break-in, semi break-in or OFF.
 - FL : Full break-in
 - SE : Semi break-in
 - OF : Break-in OFF
- ④ Push **[M-CH/RIT SET]** to exit the Set mode.

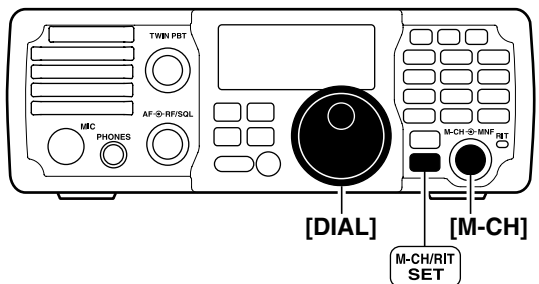

• **Keying speed setting** (p. 10-5)

- ① Hold down **[M-CH/RIT SET]** for 1 second to enter the Quick Set mode.
- ② Rotate **[M-CH]** to select “**KEY SPD**”.
- ③ Rotate **[DIAL]** to set the CW key speed to between 6 and 60 wpm.
- ④ Push **[M-CH/RIT SET]** to exit the Quick Set mode.

■ Operating in the CW mode (Continued)

◇ **Selecting the CW-R (CW reverse) mode**

The CW-R (CW Reverse) mode receives CW signals on the reverse sideband like that of the LSB and USB modes.

Use when interference is near the desired signal and when you want to shift the tone of the interfering signal.

- ① Push **MODE** one or more times to select the CW mode.
- ② Hold down **MODE** for 1 second to select the CW or CW-R mode.
 - Check the interfering tone.

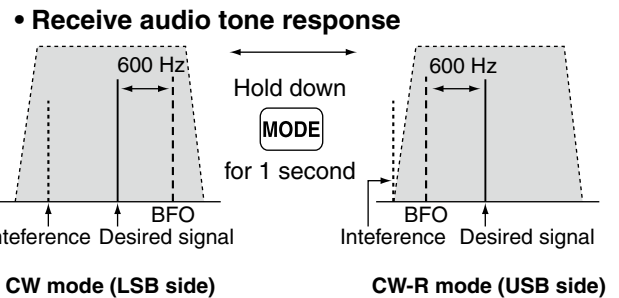
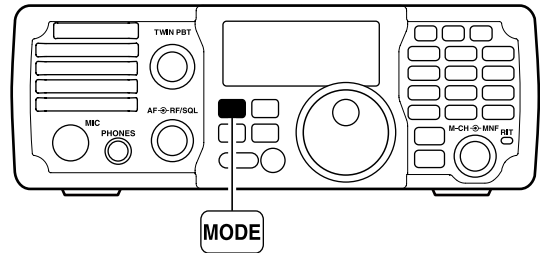

◇ **Adjusting the CW tone pitch control**

The received CW tone pitch and monitored CW tone pitch can be adjusted to between 300 and 900 Hz, without changing the operating frequency.

- ① When the CW or CW-R mode is selected, hold down **M-CH/RIT SET** for 1 second to enter the Quick Set mode.
- ② Rotate **[M-CH]** to select “**CW PITCH**”, then rotate **[DIAL]** to adjust to the desired tone pitch.
 - The CW tone pitch is adjusted to between 300 and 900 Hz, in 10 Hz steps.
- ③ Push **M-CH/RIT SET** to exit the Quick Set mode.

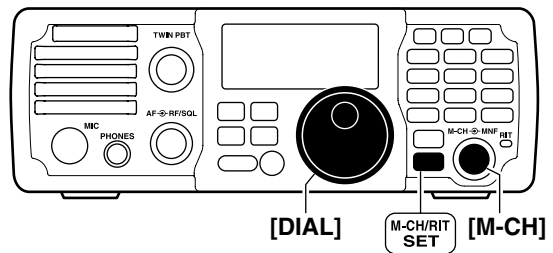

This shows the default setting for the CW tone pitch control (600 Hz).

■ Operating in the CW mode (Continued)

◇ Adjusting the CW side tone

When the transceiver is in receive, and the break-in function is OFF, you can listen to the tone of your CW signal without actually transmitting. (pp. 6-4, 6-5)

You can also use the CW sidetone to practice CW sending, but be sure to turn OFF the Break-in function.

- ① When the CW or CW-R mode is selected, hold down **M-CH/RIT SET** for 1 second to enter the Quick Set mode.
- ② Rotate **[M-CH]** to select "SIDE LVL", then rotate **[DIAL]** to adjust the side tone level.
 - Adjust the side tone level to between 0% and 100%, in 1% steps.
- ③ Push **M-CH/RIT SET** to exit the Quick Set mode.

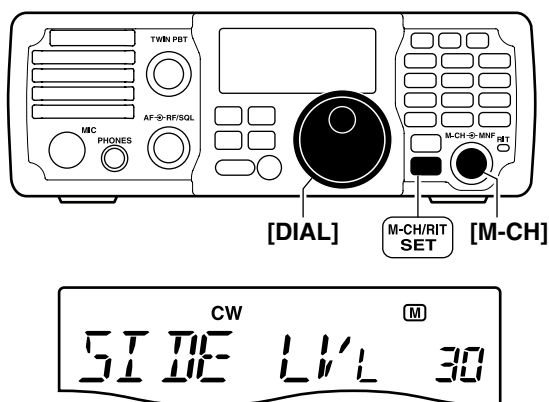

◇ Setting Keying speed

The transceiver's internal electronic keyer speed can be set to between 6 and 60 words per minute (wpm).

- ① When the CW or CW-R mode is selected, hold down **M-CH/RIT SET** for 1 second to enter the Quick Set mode.
- ② Rotate **[M-CH]** to select "KEY SPD", then rotate **[DIAL]** to set the keying speed.
- ③ Push **M-CH/RIT SET** to exit the Quick Set mode.

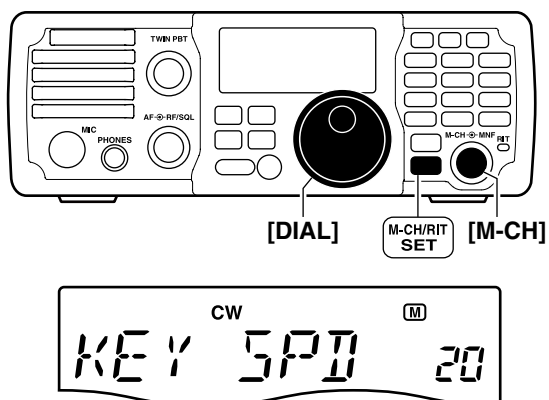

■ Operating in the RTTY (FSK) mode

When using your PC, RTTY terminal or **TNC**, consult the manual that comes with the equipment.

- ① Hold down **F-INP ENT BAND** for 1 second, then push a band key to select the desired **band**.
- ② Push **MODE** to select the RTTY mode.
 - Hold down **MODE** for 1 second to toggle between the RTTY and RTTY-R modes.
- ③ Rotate **[DIAL]** to tune in a desired signal.
 - The S-meter displays received signal strength.
 - If the received signal cannot be demodulated, try selecting the opposite mode (RTTY or RTTY-R).
- ④ Transmit a SEND signal from your PC or terminal.
 - **TX** appears.
 - The PO meter displays the transmitted output power.
- ⑤ Use the PC or TNC (TU) to transmit RTTY (FSK) signals.

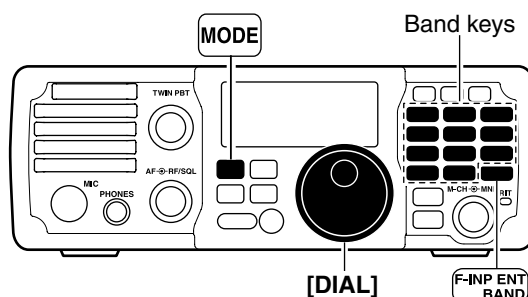

Appears while transmitting.
 “RTTY” or “RTTY-R” appears.



◇ Convenient functions for receiving

- **Preamp and attenuator** (p. 5-3)
 - ➔ Push **P.AMP ATT** to turn the preamp ON or OFF.
 - “P.AMP” appears when the preamp is ON.
 - ➔ Hold down **P.AMP ATT** for 1 second to turn ON the attenuator.
 - “ATT” appears when the attenuator is ON.
 - Push **P.AMP ATT** to turn OFF the attenuator.

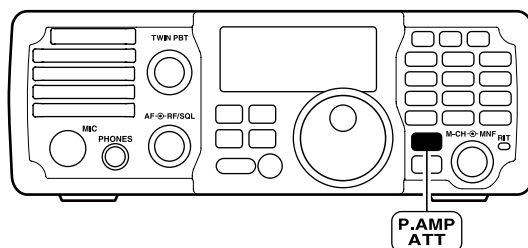

- **Twin PBT (passband tuning)** (p. 5-4)
 - ➔ Rotate **[TWIN PBT]** (controls–inner/outer).

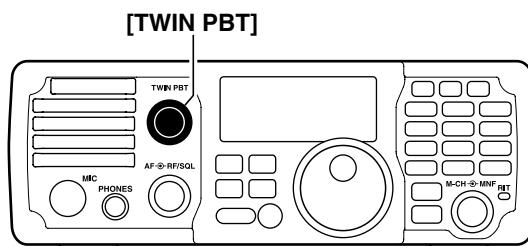

- Operating in the RTTY (FSK) mode
- ◇ Convenient functions for receiving (Continued)

• **AGC (auto gain control)** (p. 5-3)

- ➔ Push **[AGC]** once or twice to set the **AGC** time constant to fast or slow.
 - “**F.AGC**” appears when the fast time constant is selected, and no icon appears when the slow time constant is selected.
- ➔ Hold down **[AGC]** for 1 second to turn OFF the AGC function.
 - “**AGC-OFF**” appears.

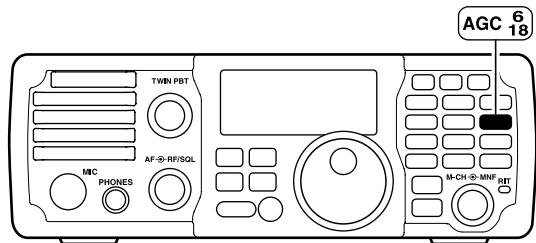

• **Noise blanker** (p. 5-7)

- ➔ Push **[NB]** to turn the **noise blanker** ON or OFF.
 - “**NB**” appears when the noise blanker is ON.
- ➔ Hold down **[NB]** for 1 second to enter the noise blanker Set mode. Rotate **[M-CH]** to select the item, then rotate **[DIAL]** to adjust the threshold level, or the blank width.

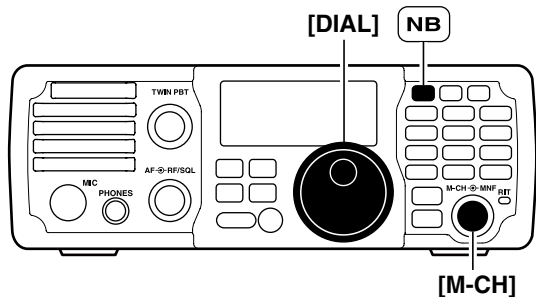

• **Noise reduction** (p. 5-8)

- ➔ Push **[NR]** to turn the **noise reduction** ON or OFF.
 - “**NR**” appears when the noise reduction is ON.
- ➔ Hold down **[NR]** for 1 second to enter the noise reduction level Set mode, then rotate **[DIAL]** to adjust the noise reduction level.

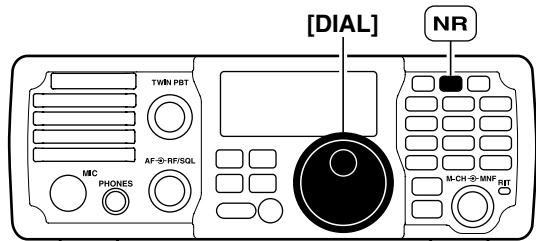

• **Manual notch filter** (p. 5-10)

- ➔ Push **[MNF]** to turn the manual **notch filter** ON or OFF.
 - “**MNF**” appears when the manual notch filter is ON.
- ➔ Hold down **[MNF]** for 1 second to enter the manual notch filter Set mode, then rotate **[DIAL]** to select the narrow, mid or wide filter width.

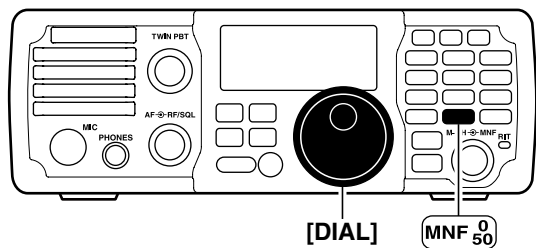

• **¼ function** (p. 10-13)

- ① Hold down **[M-CH/RIT SET]** for 1 second twice to enter the Set mode.
- ② Rotate **[M-CH]** to select “**DIAL ¼**”.
- ③ Rotate **[DIAL]** to turn the ¼ function ON or OFF.
- ④ Push **[M-CH/RIT SET]** to exit the Set mode.

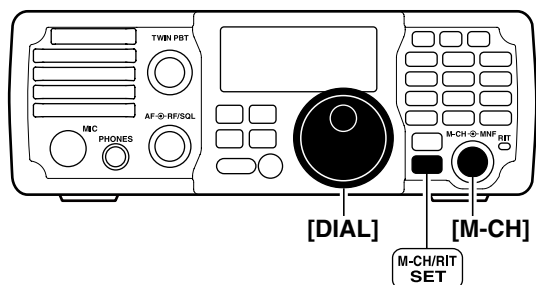

■ Operating in the RTTY (FSK) mode (Continued)

◇ **Selecting the RTTY-R (RTTY reverse) mode**

Received characters are occasionally garbled when the receive signal's MARK and SPACE are reversed. This reversal can be caused by incorrect **TNC** connections, settings, commands, and so on.

To receive a reversed RTTY signal correctly, select the RTTY-R (RTTY reverse) mode.

- ① Push **MODE** to select RTTY mode.
- ② Hold down **MODE** for 1 second to toggle between the RTTY and RTTY-R modes.

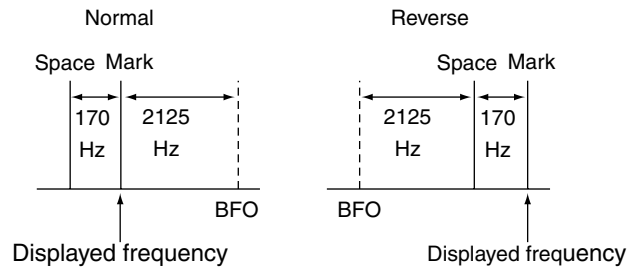
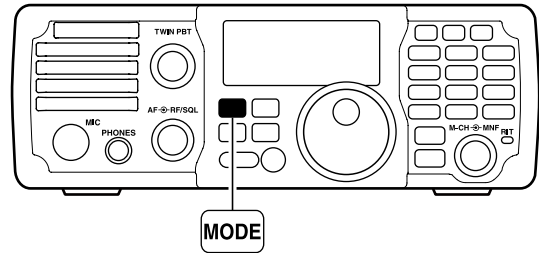

◇ **Selecting the Twin peak filter**

The twin peak **filter** changes the receive frequency response by boosting two particular frequencies (2125 and 2295 Hz) for better copying of desired RTTY signals.

- ① Push **MODE** to select RTTY mode.
 - Hold down **MODE** for 1 second to toggle between the RTTY and RTTY-R modes.
- ② Hold down **M-CH/RIT SET** for 1 second to enter the Quick Set mode.
- ③ Rotate **[M-CH]** to select "TPF", then rotate **[DIAL]** to turn the twin peak filter function ON or OFF.
 - The received audio volume may become greater when the twin peak filter is ON.
- ④ Push **M-CH/RIT SET** to exit the Quick Set mode.

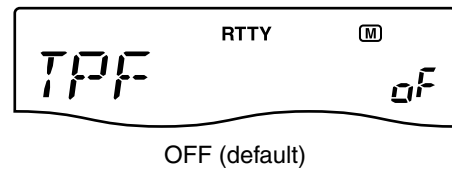
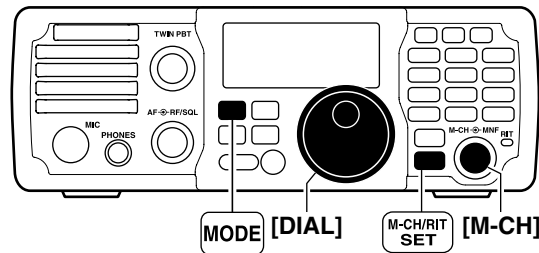

■ Operating in the RTTY (FSK) mode (Continued)

◇ RTTY decode Set mode

Set the RTTY key polarity, shift width and mark tone.

- ① When RTTY (RTTY-R) mode is selected, hold down **M-CH/RIT SET** for 1 second to enter the Quick Set mode.
- ② Rotate **[M-CH]** to select the desired set item.
- ③ Rotate **[DIAL]** to adjust the desired value or option.
 - Hold down **M-CL** for 1 second to return to the default value.
- ④ Push **M-CH/RIT SET** to exit the Quick Set mode.

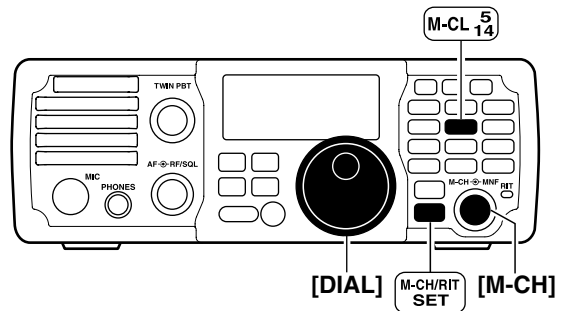

RTTY mark tone (RTTY mode)
 This item selects the RTTY mark frequency. Select 1275, 1615 or 2125 Hz.

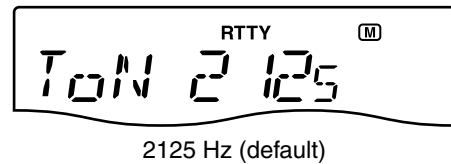

RTTY shift width (RTTY mode)
 This item adjusts the RTTY shift width. There are 4 selectable values: 170, 200, 425 and 850 Hz.

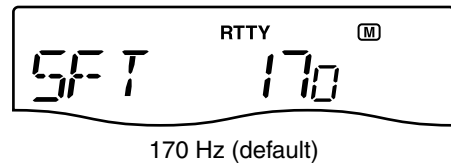

RTTY key polarity (RTTY mode)
 This item selects the RTTY keying polarity. Normal or reverse keying polarity can be selected. When reverse polarity is selected, Mark and Space are reversed.
 n (normal) : Key open/close = Mark/Space
 r (reverse) : Key open/close = Space/Mark

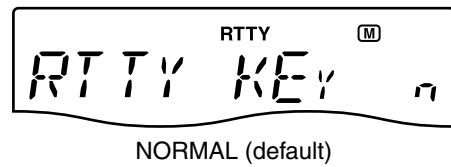

■ Operating in the AM mode

- ① Hold down **F-INP ENT BAND** for 1 second, then push a band key to select the desired **band**.
- ② Push **MODE** to select AM mode.
- ③ Rotate **[DIAL]** to tune in a desired signal.
 - The S-meter displays received signal strength.
 - The default **tuning step** for the AM mode is 1 kHz; this can be changed in the tuning step program mode. (p. 3-7)
- ④ Rotate the **[AF]** control to set audio to a comfortable listening level.
- ⑤ Push **[PTT]** to transmit.
 - **TX** appears.
- ⑥ Speak into the microphone at your normal voice level.
 - Adjust 'MIC Gain,' if necessary. (p. 10-4)
- ⑦ Release **[PTT]** to receive.

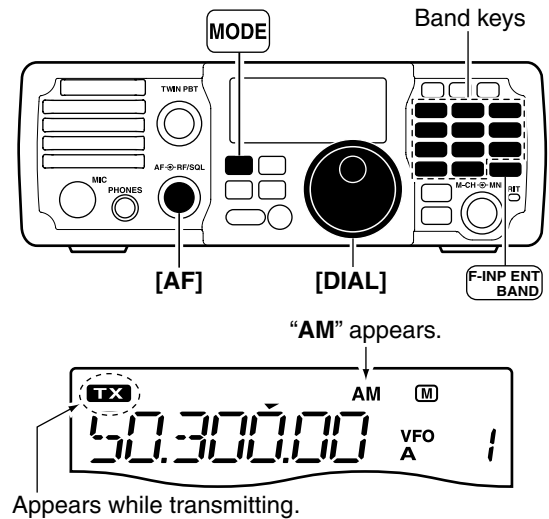

◇ Convenient functions for receiving

- **Preamp and attenuator** (p. 5-3)
 - ➔ Push **P.AMP ATT** to turn the preamp ON or OFF.
 - **P.AMP** appears when the preamp is ON.
 - ➔ Hold down **P.AMP ATT** for 1 second to turn ON the attenuator.
 - **ATT** appears when the attenuator is ON.
 - Push **P.AMP ATT** to turn OFF the attenuator.
- **Twin PBT (passband tuning)** (p. 5-4)
 - ➔ Rotate **[TWIN PBT]** (controls-inner/outer).
- **AGC (auto gain control)** (p. 5-3)
 - ➔ Push **AGC** once or twice to set the **AGC** time constant to fast or slow.
 - **F.AGC** appears when the fast time constant is selected, and no icon appears when the slow time constant is selected.
 - ➔ Hold down **AGC** for 1 second to turn the AGC function OFF.
 - **AGC-OFF** appears.

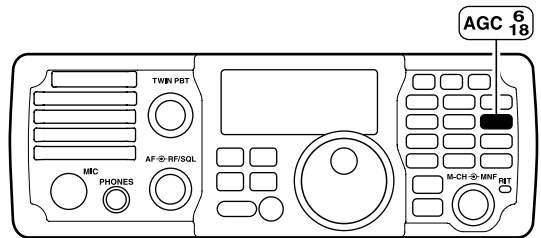
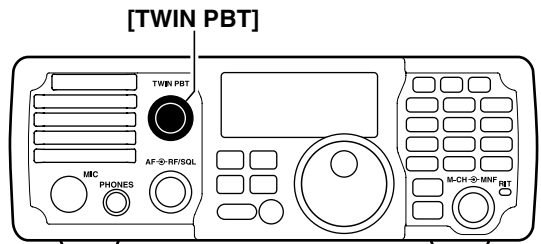
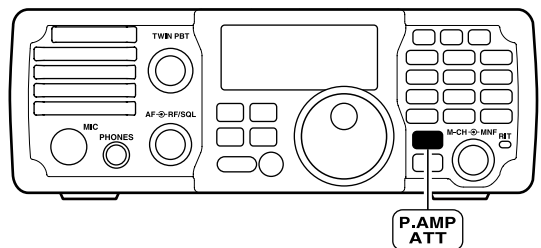

■ Operating in the AM mode

◇ Convenient functions for receiving (Continued)

• **Noise blanker** (p. 5-7)

- ➔ Push **[NB]** to turn the **noise blanker** ON or OFF.
 - “**[NB]**” appears when the noise blanker is ON.
- ➔ Hold down **[NB]** for 1 second to enter the noise blanker Set mode. Rotate **[M-CH]** to select the item, then rotate **[DIAL]** to adjust the threshold level, or the blank width.

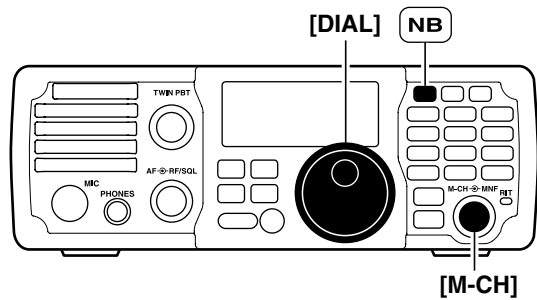

• **Noise reduction** (p. 5-8)

- ➔ Push **[NR]** to turn the **noise reduction** ON or OFF.
 - “**[NR]**” appears when the noise reduction is ON.
- ➔ Hold down **[NR]** for 1 second to enter the noise reduction level Set mode, then rotate **[DIAL]** to adjust the noise reduction level.

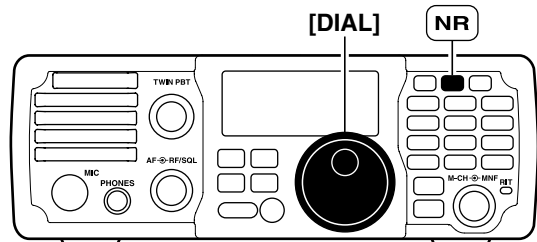

• **Manual notch filter** (p. 5-10)

- ➔ Push **[MNF]** to turn the manual **notch filter** ON or OFF.
 - “**[MNF]**” appears when the manual notch filter is ON.
- ➔ Hold down **[MNF]** for 1 second to enter the manual notch filter Set mode, then rotate **[DIAL]** to select the narrow, mid or wide filter width.

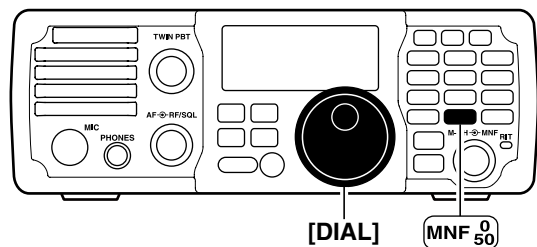

• **Auto notch filter** (p. 5-9)

- ➔ Push **[ANF METER]** to turn the auto notch filter ON or OFF.
 - “**[ANF]**” appears when the auto notch filter is ON.

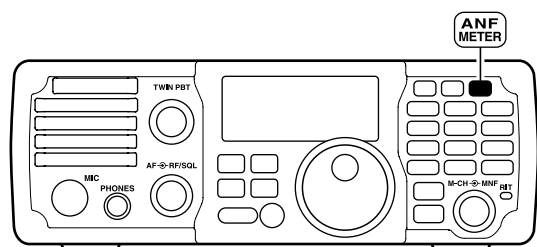

◇ Convenient functions for transmit

• **VOX (voice operated transmit)** (p. 6-2)

- ➔ Push **[VOX]** to turn the **VOX** function ON or OFF.
 - “**[VOX]**” appears when the VOX function is ON.
- ➔ Hold down **[VOX]** for 1 second to enter the VOX Set mode. Rotate **[M-CH]** to select the item, then rotate **[DIAL]** to adjust the VOX gain, anti VOX gain or VOX delay.

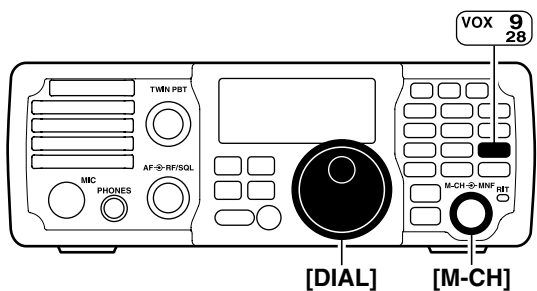

■ Operating in the Data mode (SSTV/PSK31)

When operating **SSTV** or PSK31 with your PC, refer to the software manual.

- ① Connect your PC to the transceiver. (p. 2-10)
- ② Hold down **F-INP ENT BAND** for 1 second, then push a band key to select the desired **band**.
- ③ Push **MODE** to select the SSB or AM mode.
 - After the SSB mode is selected, hold down **MODE** for 1 second to toggle between the USB and LSB modes.
- ④ Turn ON the data mode in the Quick Set mode.

- ① Hold down **M-CH/RIT SET** for 1 second to enter the Quick Set mode.
- ② Rotate **[M-CH]** to select "DATA" to set the data mode.
- ③ Rotate **[DIAL]** to select the data mode ON or OFF.
 - "D" appears when the data mode is turned ON.
- ④ Push **M-CH/RIT SET** to exit the Quick Set mode.

- ⑤ Rotate **[DIAL]** to tune in a desired signal until it is decoded correctly.
 - The S-meter displays the received signal strength.
 - Also use the tuning indicator of the software.
 - In the SSB data mode, the ¼ tuning function can be used for critical tuning.
- ⑥ Use the PC (software) to transmit.
 - When operating in the SSB data mode, adjust the AF output level from PC so that the **ALC** meter reading stays within the ALC zone.

NOTE: When the data mode is selected, the audio input from the **[ACC]** connector* is used for transmission instead of the **[MIC]** connector. The speech compressor is turned OFF in the SSB data mode.
 * The desired connector can be selected in the Set mode. (p. 10-11)

✓ For your information

The **carrier** point frequency is displayed when the SSB data mode is selected. See the diagram below for the tone-pair example.

- **Example**— LSB/LSB data mode
 Mark freq.: 2125 Hz
 Shift freq.: 200 Hz

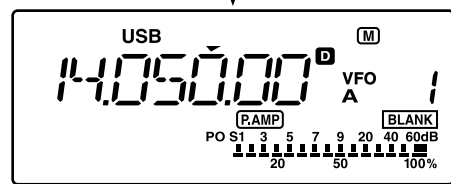
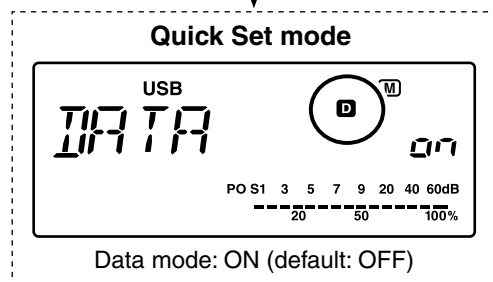
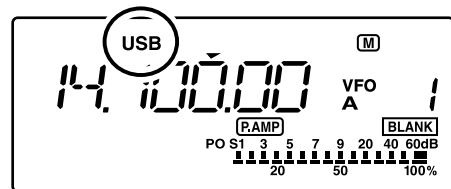
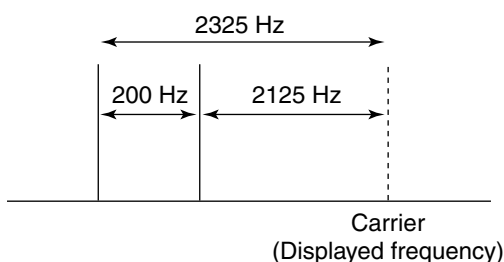

Appears while transmitting.

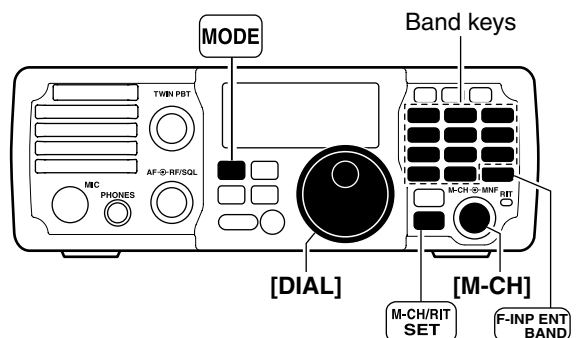
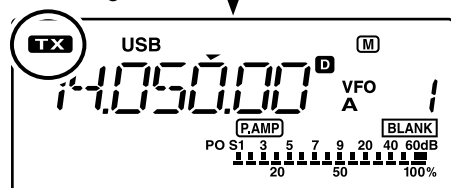

■ Using the RIT function.....	5-2
■ Selecting the preamp and attenuator	5-3
■ AGC function	5-3
◇ AGC time constant selection.....	5-3
■ Adjusting the Twin PBT operation.....	5-4
■ Selecting the IF filter	5-5
◇ IF filter selection.....	5-5
◇ Setting the passband filter width.....	5-6
◇ Selecting IF filter shape (SSB/CW only)	5-6
■ Activating the Noise blanker	5-7
◇ Setting the noise blanker level and width.....	5-7
■ Activating the Noise reduction function	5-8
◇ Setting the noise reduction level	5-8
■ Activating the Notch filters	5-9
◇ Auto notch filter	5-9
◇ Manual notch filter	5-10
◇ Setting the Manual notch filter	5-10

■ Using the RIT function

The RIT (Receive Incremental Tuning) function compensates for stations transmitting off-frequency, or when you prefer to listen to slightly different sounding voice characteristics.

The RIT shifts the receive frequency up to ± 9.999 kHz in 1 Hz steps (10 Hz steps when cancelling the 1 Hz step readout) without shifting the transmit frequency.

- ① Push **[RIT]** to turn ON the RIT function.
 - “**[RIT]**” and the frequency shift are displayed.
 - The frequency shift is displayed for approximately 1 second, then returns to the operating frequency.
 - The RIT control indicator lights orange.
 - If the RIT control indicator does not light, push **[M-CH/RIT SET]**. (See below for details)
- ② Rotate the **[M-CH]** control to compensate for off-frequency stations.
 - The transmit frequency is not shifted.
 - The frequency shift is displayed for approximately 1 second when rotating the **[M-CH]** control.
- ③ To cancel the RIT, push **[RIT]** again.
 - “**[RIT]**” disappears.
 - The RIT control indicator goes out.

/// About the **[M-CH]** control:

The **[M-CH]** control can be used for selecting the memory channel and also adjusting the RIT frequency shift. Pushing **[M-CH/RIT SET]** toggles the **[M-CH]** control as the M-CH selector or the RIT controller.

RIT controller: RIT control indicator lights orange.
 M-CH selector: RIT control indicator goes out.

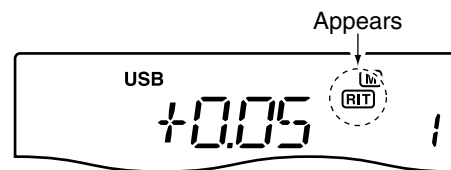
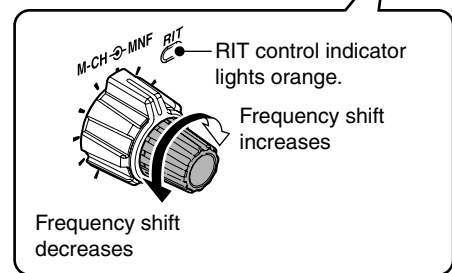
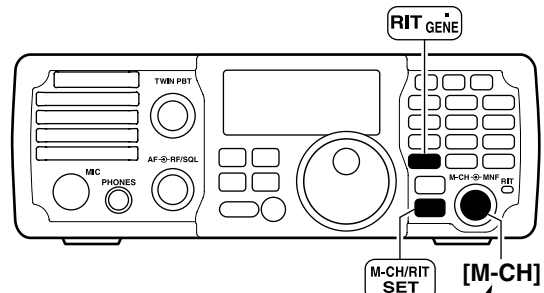

• RIT monitor function

When the XFC (transmit frequency check function) is ON (p. 10-11), the transmit frequency can be monitored while holding down **[RIT]**. (RIT is temporarily cancelled.)

• Calculate function

The frequency shift of the RIT function can be added/subtracted to the displayed frequency.

When the RIT function is ON, hold down **[RIT]*** for 1 second.

- The RIT shift is automatically reset.

* Available only when the XFC (transmit frequency check function) is turned OFF. (p. 10-11)

■ Selecting the preamp and attenuator

The preamp amplifies received signals in the receiver input (front end) circuit to improve the S/N ratio and **sensitivity**. Turn this function ON when receiving weak signals.

The attenuator prevents very strong signals near the desired frequency, such as nearby broadcast stations or very strong amateur signals, from causing distortion of a desired signal.

- ➔ Push **P.AMP** **ATT** to turn the preamp ON or OFF; hold down for 1 second to turn the attenuator ON.
 - “**P.AMP**” appears when the preamp is ON.
- ➔ Hold down **P.AMP** **ATT** for 1 second to turn ON the attenuator. Push **P.AMP** **ATT** turn OFF the attenuator.
 - “**ATT**” appears when the 20 dB attenuator is ON.

NOTE: Only one of these functions can be activated at a time.

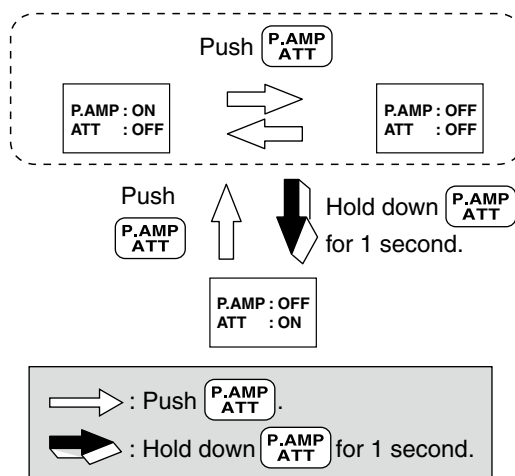
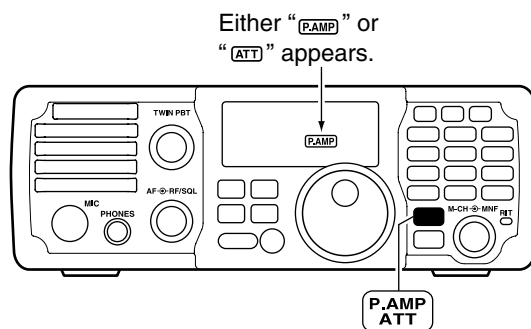

■ AGC function

The **AGC** (automatic gain control) controls receiver gain to produce a constant audio output level, even when the received signal strength varies due to fading, and so on.

◇ AGC time constant selection

- ① Push **MODE** several times to select the desired mode.
- ② Push **AGC** once or twice to select AGC fast or AGC slow.
 - “**F.AGC**” appears when AGC fast is selected, and no icon appears when AGC slow is selected.
- ③ Hold down **AGC** for 1 second to turn the AGC OFF.
 - “**AGC-OFF**” appears when AGC OFF is selected.

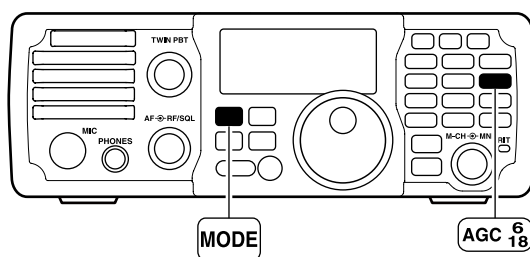

■ Adjusting the Twin PBT operation

The Twin PBT (Passband Tuning) function electronically narrows the IF passband width by shifting the IF frequency slightly outside of the IF filter passband to reject interference. This transceiver uses the DSP circuit for the PBT function.

By rotating both [TWIN PBT] controls (inner/outer; PBT1 and PBT2) with the same position, PBT functions as an IF shift control.

The limit of the variable range depends on the passband width and mode. The limit of the variable range is half of the passband width, and PBT is adjustable in 200 Hz (AM) or 50 Hz (other models) steps.

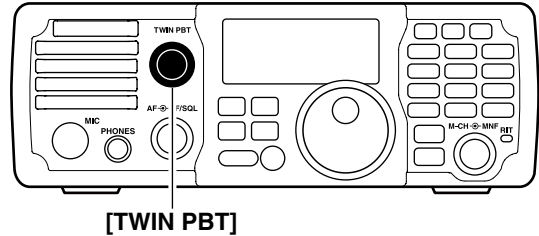

- The [TWIN PBT] controls should normally be set to the center positions (PBT shift is zero) when there is no interference.
- When PBT is used, the audio tone may change.
- While rotating the [TWIN PBT] controls, noise may occur. This comes from the DSP unit and does not indicate an equipment malfunction.

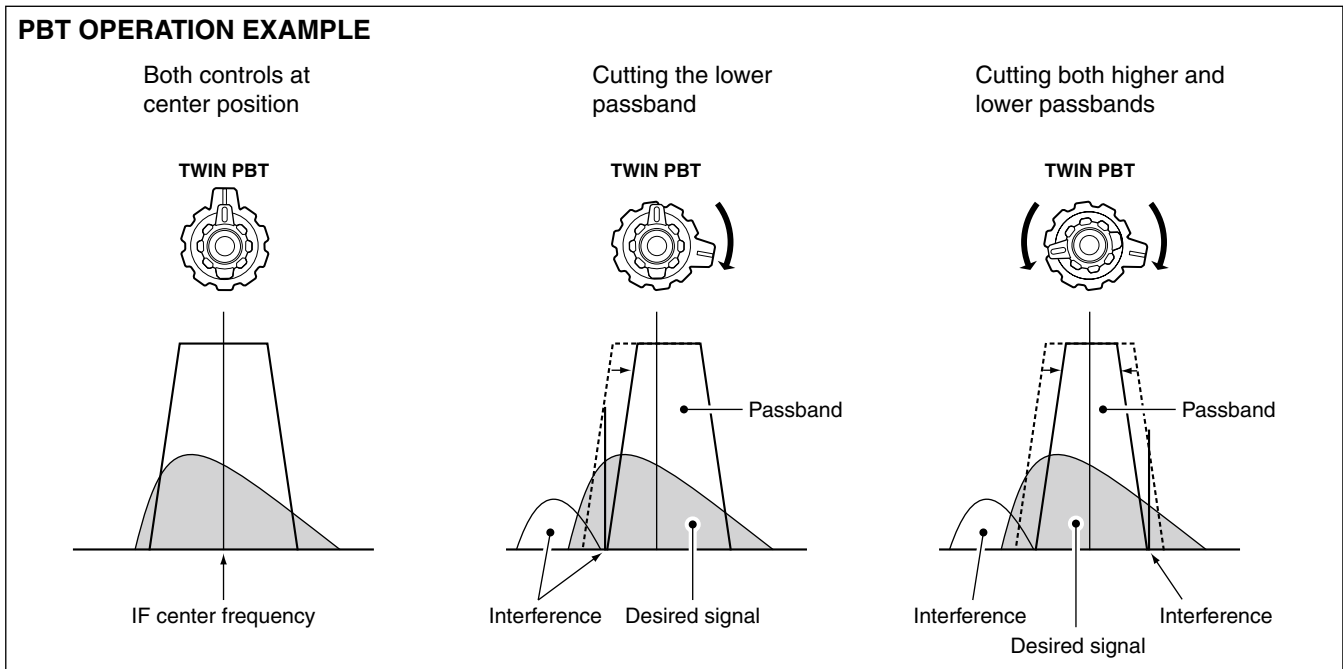

■ Selecting the IF filter

The transceiver has 3 passband **IF filter** widths for each mode.

For the SSB and CW modes, set the passband width to between 50 and 3600 Hz, in 50 or 100 Hz steps. A total of 41 passband widths can be set.

For the RTTY mode, set the passband width to between 50 and 2700 Hz, in 50 or 100 Hz steps. A total of 32 passband widths can be set.

For the AM mode, set the passband width to between 200 and 8000 Hz in 200 Hz steps. A total of 40 passband widths can be set.

▨ The filter selection is automatically memorized in each mode.

◇ IF filter selection

- ① Push **MODE** several times to select the desired mode.
- ② Push **FILTER** several times to set the IF filter to Wide, Mid or Narrow.
 - The selected IF filter icon (“**W**”, “**M**” or “**N**”) appears in the LCD.

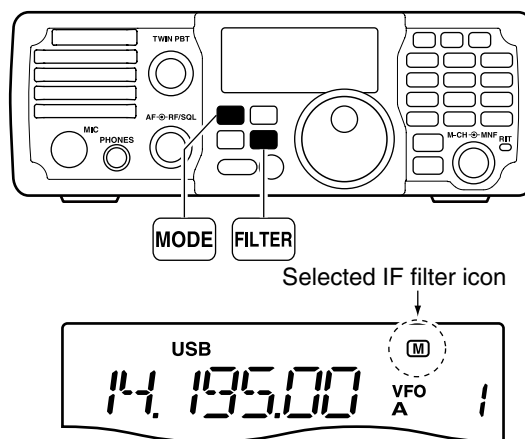

5 FUNCTIONS FOR RECEIVE

■ IF filter selection (Continued)

◇ Setting the passband filter width

- ① Push **[MODE]** several times to select the desired operating mode.
- ② Hold down **[FILTER]** for 1 second to enter filter Set mode.
- ③ Rotate **[M-CH]** to select "FIL."
- ④ Push **[FILTER]** several times to select the desired **IF filter**.
- ⑤ Rotate **[DIAL]** to set the desired passband width.
 - The passband width can be set within the range shown in the table at the lower right.
 - Hold down **[M-CL]** for 1 second to return to the default value.
- ⑥ Repeat steps ④ and ⑤ if desired.
- ⑦ Hold down **[FILTER]** for 1 second to exit the filter Set mode.

When the IF passband width is set to minimum by the **[TWIN PBT]** controls (when one control is maximum counterclockwise, and the other one is maximum clockwise; p. 5-4), sound may not come from the speaker, depending on the IF filter passband width setting. This is not a transceiver malfunction.

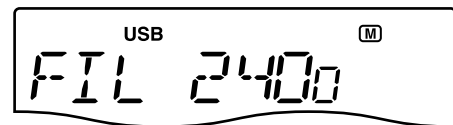
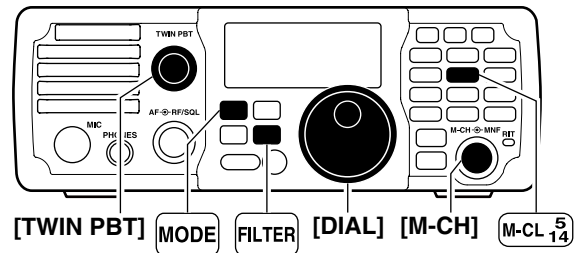

Mode	Filter	Default	Range (Steps)
SSB	Wide	3000 Hz	50–500 Hz (50 Hz)/ 600–3600 Hz (100 Hz)
	Mid	2400 Hz	
	Narrow	1800 Hz	
SSB Data/ CW	Wide	1200 Hz	50–500 Hz (50 Hz)/ 600–3600 Hz (100 Hz)
	Mid	500 Hz	
	Narrow	250 Hz	
RTTY	Wide	2400 Hz	50–500 Hz (50 Hz)/ 600–2700 Hz (100 Hz)
	Mid	500 Hz	
	Narrow	250 Hz	
AM/ AM Data	Wide	8000 Hz	200–8000 Hz (200 Hz)
	Mid	6000 Hz	
	Narrow	3000 Hz	

◇ Selecting IF filter shape (SSB/CW only)

Select a soft or sharp **DSP** filter shape for SSB and CW.

- ① Push **[MODE]** several times to select the SSB or CW mode.
- ② Hold down **[FILTER]** for 1 second to enter the filter Set mode.
- ③ Rotate **[M-CH]** to select "SHAPE."
- ④ Push **[FILTER]** several times to select the desired IF filter between Wide, Mid and Narrow.
- ⑤ Rotate **[DIAL]** to set the desired filter shape of each filter to either soft or sharp.
 - Hold down **[M-CL]** for 1 second to return to the default value.
- ⑥ Hold down **[FILTER]** for 1 second to exit the filter Set mode.

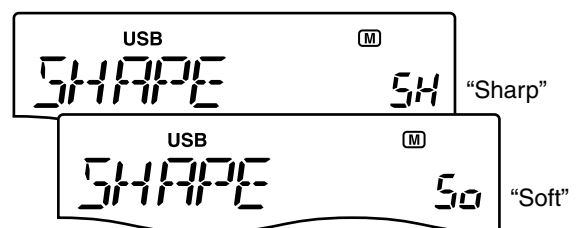
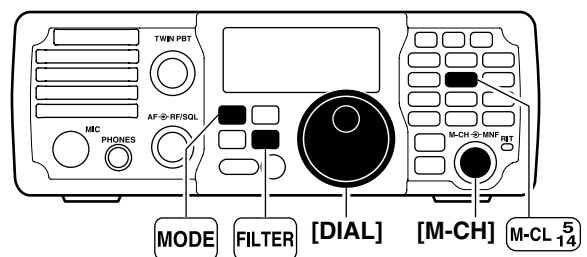

■ Activating the Noise blanker

The **noise blanker** eliminates pulse-type noise such as from car ignition systems.

- ➔ Push **[NB]** to turn the noise blanker ON or OFF.
- “**[NB]**” appears when the NB function is ON.

When using the noise blanker, received signals may be distorted if they are excessively strong, or the noise type is other than a pulse type. Nearby strong signals can also cause the noise blanker to create distortion. Turn OFF the noise blanker function, or adjust the noise blanker level to a shallower setting in this case. (see below)

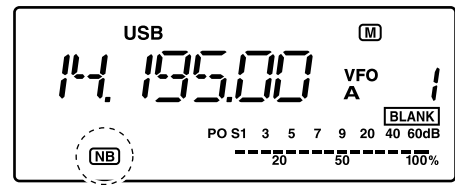
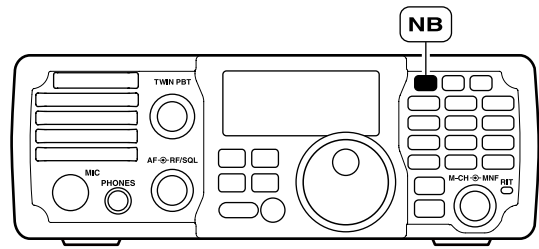

Appears

◇ Setting the noise blanker level and width

- ① Hold down **[NB]** for 1 second to enter the noise blanker Set mode.
 - The noise blanker is turned ON and “**[NB]**” appears.
- ② Rotate **[M-CH]** to select the item.
- ③ Rotate **[DIAL]** to adjust the level and/or width.
 - Hold down **[M-CL]** for 1 second to return to the default value.
- ④ Push **[NB]** to exit the noise blanker Set mode.

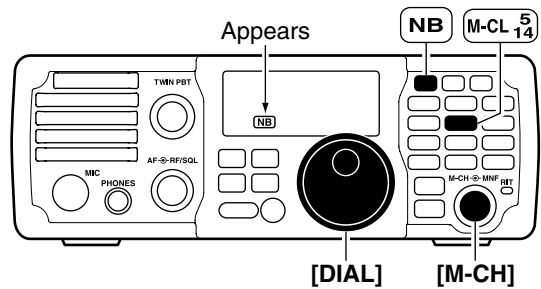

Appears

[DIAL] [M-CH]

NB LEVEL

Adjusts the noise blanker attenuation level between 0% and 100%, in 1% steps.

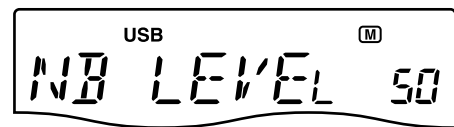

50% (default)

NB WIDTH

Adjusts the noise blanker blank width to match the pulse width. The blank width can be adjusted from 1% to 100%, in 1% steps.



50% (default)

■ Activating the Noise reduction function

The **Noise reduction** function enhances desired signals in the presence of noise by using the **DSP** circuit to remove random noise. The amount of enhancement is adjustable.

- ➔ Push **[NR]** to turn the noise reduction ON or OFF.
 - “**[NR]**” appears when the NR function is ON.

▨ The noise reduction level can result in audio signal masking. Set the noise reduction level for maximum readability, as shown to the lower right.

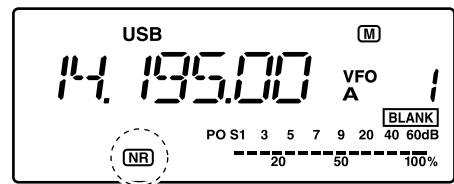
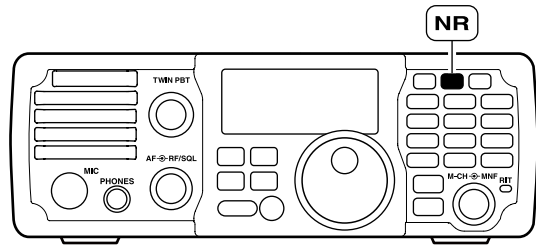

Appears

Noise reduction is OFF
NR Level 0

Noise components

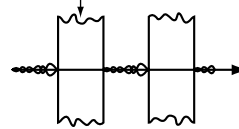

Noise reduction is ON
NR Level 4 (default)

Desired signal (CW)

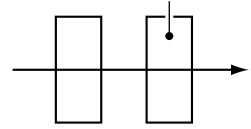

◇ Setting the noise reduction level

- ① Hold down **[NR]** for 1 second to enter the noise reduction level Set mode.
 - Noise reduction is turned ON and “**[NR]**” appears.
- ② Rotate **[DIAL]** to set the noise reduction level to between 0 and 15, in one unit steps.
 - Hold down **[M-CL]** for 1 second to return to the default value.
- ③ Push **[NR]** to exit the noise reduction Set mode.

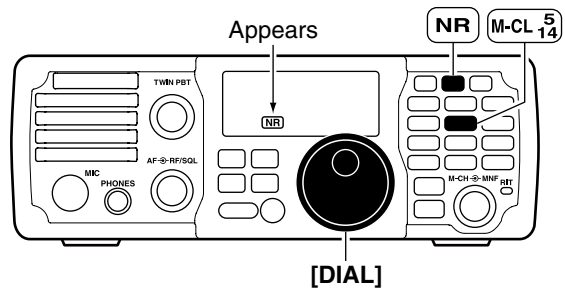

[DIAL]

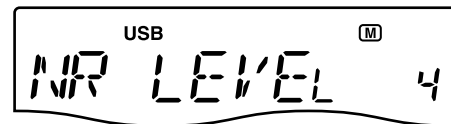

4 (default)

■ Activating the Notch filters

This transceiver has auto and manual **notch filter** functions.

The auto notch filter automatically attenuates beat tones, tuning signals, changing frequency, and so on, even if they are shifting.

The manual notch filter can be set to attenuate a frequency by rotating the **[MNF]** control.

➔ Push **[ANF METER]** to turn the auto notch filter ON or OFF.

- “**[ANF]**” appears when the auto notch filter is ON.
- The auto notch filter can be used in the SSB and AM modes.

➔ Push **[MNF]** to turn the manual notch filter ON or OFF.

- “**[MNF]**” appears when the manual notch filter is ON.
- In the SSB or AM modes, either the auto or manual notch filter can be turned ON. These functions are selected by pushing **[ANF METER]** or **[MNF]**.
- The manual notch filter setting is described on page 5-10.

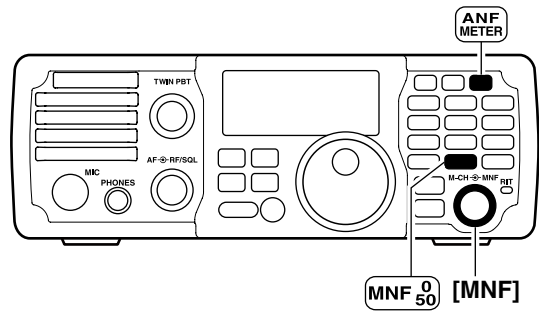

◇ Auto notch filter

The auto notch filter can be used in SSB and AM modes.

➔ Push **[ANF METER]** to turn the automatic notch filter ON or OFF.

- “**[ANF]**” appears when the auto notch filter is ON.

Auto notch OFF

Auto notch ON

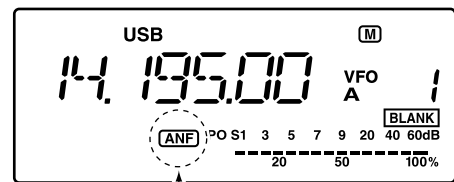
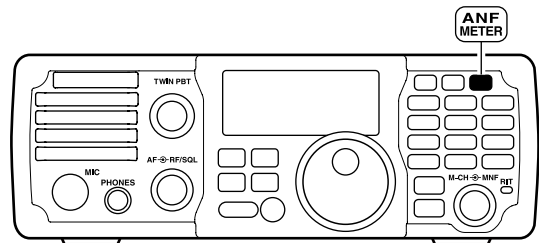
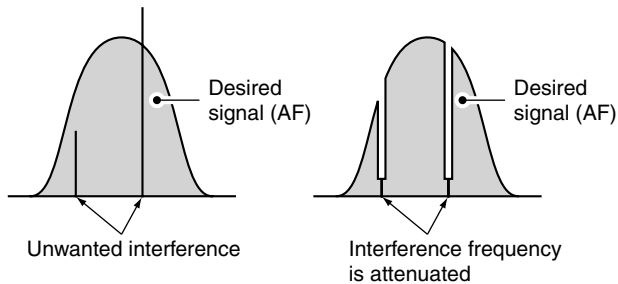

Appears

■ Notch function (Continued)

◇ Manual notch filter

- ➔ Push **[MNF]** to turn the manual notch filter ON or OFF.
 - “**[MNF]**” appears when the manual notch filter is ON.
 - Rotate the **[MNF]** control to manually select an interfering signal to attenuate.
 - Set the width of the manual notch filtering in the manual notch filter Set mode. (The setting is described below.)

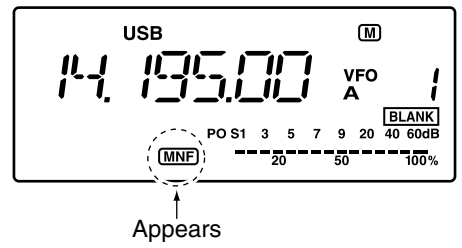
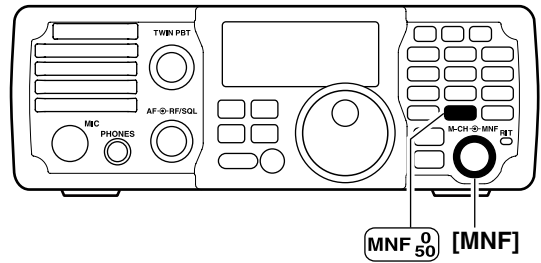

Appears

◇ Setting the Manual notch filter

- ① Hold down **[MNF]** for 1 second to enter the manual notch filter Set mode.
 - The manual notch filter is ON and “**[MNF]**” appears.
- ② Rotate **[DIAL]** to select the narrow, mid or wide filter width.
 - Hold down **[M-CL]** for 1 second to return to the default value.
- ③ Push **[MNF]** to exit the manual notch filter Set mode.

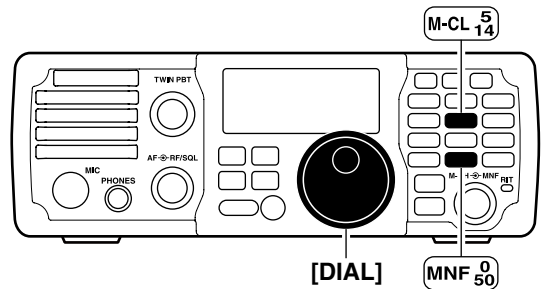

Mid (default)

⚡ While adjusting the manual notch filter, noise may be heard. This comes from the **DSP** unit and does not indicate an equipment malfunction.

■ VOX function.....	6-2
◇ VOX Set mode	6-3
■ Break-in function	6-4
◇ Semi break-in operation.....	6-4
◇ Full break-in operation	6-5
■ Speech compressor	6-6
◇ Setting the compression level	6-7
■ Split frequency operation.....	6-8
◇ Using the Quick split function	6-10
◇ Split lock function.....	6-11
■ Measuring SWR	6-11

■ VOX function

The **VOX** (Voice-Operated Transmission) function uses your voice to switch between transmit and receive. This function provides for hands-free operation or to input log entries into your computer, and so on, while operating.

- ① Push **MODE** to select a phone mode (SSB or AM).
 - When the SSB mode is selected, hold down **MODE** for 1 second to toggle between the USB and LSB modes.
- ② Push **VOX** to turn the VOX function ON or OFF.
 - "**VOX**" appears when the VOX function is ON.

The VOX gain, ANTI-VOX and VOX delay can be set in the VOX Set mode. (See page 6-3)

Appears when the USB mode is selected.

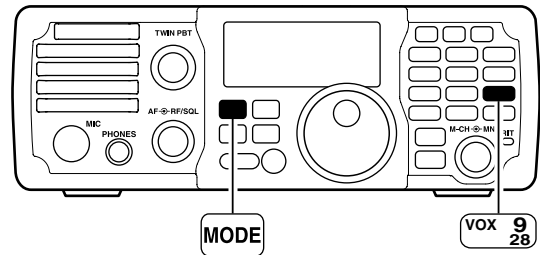
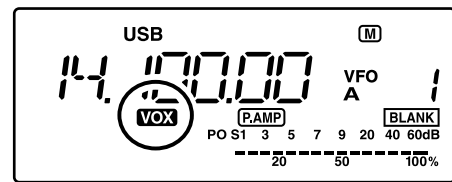
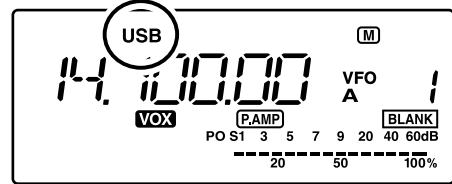

6 FUNCTIONS FOR TRANSMIT

■ VOX function (Continued)

◇ VOX Set mode

- ① Hold down **[VOX]** for 1 second to enter the **VOX** Set mode.
- ② Rotate **[M-CH]** to select “**VoX GAIN.**”
- ③ While speaking into the microphone at your normal voice level, rotate **[DIAL]** to the point where the transceiver continuously transmits.
- ④ Rotate **[M-CH]** to select “**ANTI-Vox.**”
- ⑤ During receive, rotate **[DIAL]** to adjust the anti-VOX gain to the point where the transceiver does not switch to transmit due to received audio from the speaker, or background noise.
- ⑥ Rotate **[M-CH]** to select “**VoX DELY.**”
- ⑦ Rotate **[DIAL]** to adjust the VOX delay for a convenient interval before returning to receive.
- ⑧ Push **[vox]** to exit the VOX Set mode.

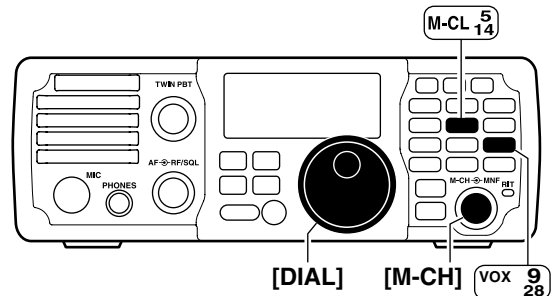

VOX GAIN

Adjusts the VOX gain for the VOX (Voice-Operated Transmission) function. Higher values make the VOX function more sensitive to your voice.

- Hold down **[M-CL]** for 1 second to return to the default value.

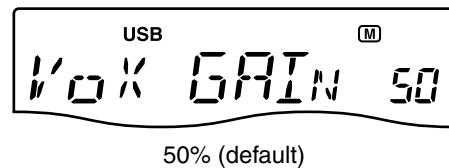

ANTI-VOX

Adjusts the ANTI-VOX gain for the VOX (Voice-Operated Transmission) function. Higher values make the VOX function less sensitive to receiver output audio from a speaker or headphones.

- Hold down **[M-CL]** for 1 second to return to the default value.

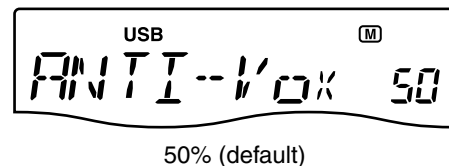

VOX DELAY

This item adjusts the VOX (Voice-Operated Transmission) delay time. VOX Delay is the amount of time the transmitter stays on after you stop speaking. Adjust the delay time between 0 and 2.0 seconds, in 0.1 second steps.

- Hold down **[M-CL]** for 1 second to return to the default value.

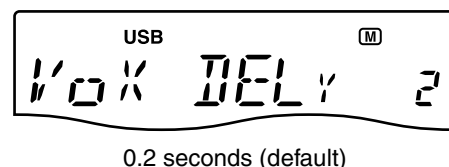

■ Break-in function

The break-in function is used in the CW mode to automatically switch the transceiver between transmit and receive when keying. The IC-7200 is capable of full break-in or semi break-in. Break-in operation is also referred to as QSK.

◇ Semi break-in operation

During semi break-in operation, the transceiver immediately transmits when keying, then automatically returns to receive after a pre-set delay time has passed after you stop keying. This is similar to the **VOX** operation for voice.

- ① Push **MODE** to select CW or CW-R mode.
 - Hold down **MODE** for 1 second to toggle between the CW and CW-R modes.
- ② Set the semi break-in mode to ON and the CW delay time in the Set mode. (See below)

- ① Hold down **M-CH/RIT SET** for 1 second twice to enter the Set mode.
- ② Rotate **[M-CH]** to select **"BK-IN"** to select the CW break-in mode.
- ③ Rotate **[DIAL]** to select **"SE."**
 - FL : Full break-in
 - SE : Semi break-in
 - OF : Break-in OFF
- ④ Rotate **[M-CH]** to select **"BK-DELAY"** to select the CW delay time.
- ⑤ Rotate **[DIAL]** to set the desired delay time.
 - The delay time is selectable from 0.2 to 13.0 (dots) in 0.1 (dots) steps.
- ⑥ Push **M-CH/RIT SET** to exit the Set mode.

- ③ **"BK"** appears on the LCD.

When using a paddle, set **"KEY SPD"** in the Quick Set mode to adjust the keying speed. (p. 10-5)



Semi break-in operation



7.5 dots

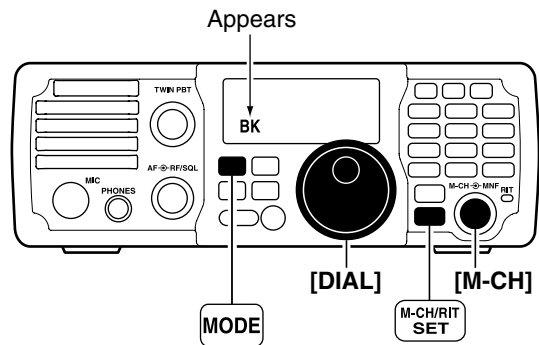

6 FUNCTIONS FOR TRANSMIT

■ Break-in function (Continued)

◇ Full break-in operation

In full break-in, the transceiver automatically switches to receive between keying dots and dashes so that the operator can hear activity on the frequency.

- ① Push **MODE** to select the CW or CW-R mode.
 - Hold down **MODE** for 1 second to toggle between the CW and CW-R modes.
- ② Set the full break-in mode to ON in the Set mode.
(See below)

- ① Hold down **M-CH/RIT SET** for 1 second twice to enter the Set mode.
- ② Rotate **[M-CH]** to select “**BK-IN**” to set the CW break-in mode.
- ③ Rotate **[DIAL]** to select “**FL**.”
 - FL : Full break-in
 - SE : Semi break-in
 - OF : Break-in OFF
- ④ Push **M-CH/RIT SET** to exit the Set mode.

- ③ “**F-BK**” appears on the LCD.

/// When using a paddle, set “**KEY SPD**” in the Quick Set mode to adjust the keying speed. (p. 10-5)



Full break-in operation

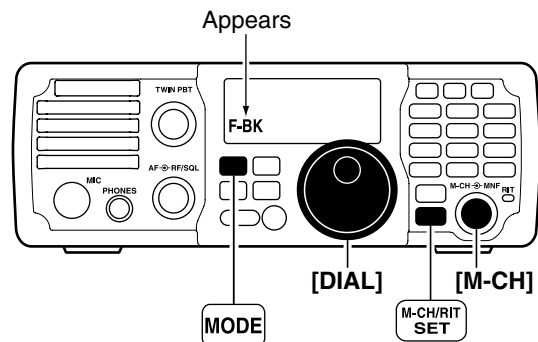

■ Speech compressor

The IC-7200 has a built-in, low distortion speech compressor circuit. This circuit increases your average talk power in the SSB mode, and is especially useful for DX-ing or noisy conditions when the receiving station is having difficulty copying your signal.

- ① Push **MODE** to select the SSB mode.
 - Hold down **MODE** for 1 second to toggle between the USB and LSB modes.
- ② Push **COMP** to turn the speech compressor function ON or OFF.
 - **COMP** appears when the speech compressor function is ON.

When using the speech compressor, set the compression level in the speech compression level Set mode, as described on page 6-7.

Appears when the USB mode is selected.

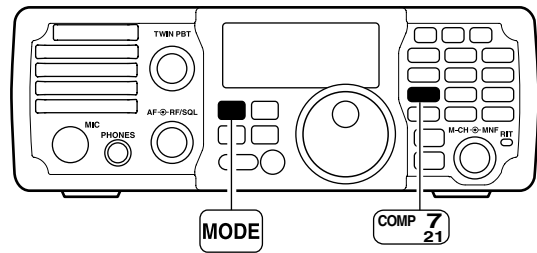
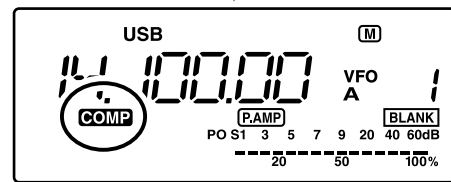
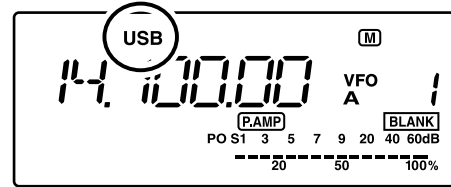

■ Speech compressor

◇ Setting the compression level

• Setting the microphone gain

- ① Push **MODE** to select SSB mode.
 - Hold down **MODE** for 1 second to toggle between the USB and LSB modes.
- ② Push **COMP** to turn OFF the speech compressor function, if it is ON.
 - “**COMP**” disappears.
- ③ Hold down **ANF METER** for 1 second several times to select **ALC** meter.
 - “**ALC**” appears.
- ④ Adjust the MIC gain in the Quick Set mode. (See below)

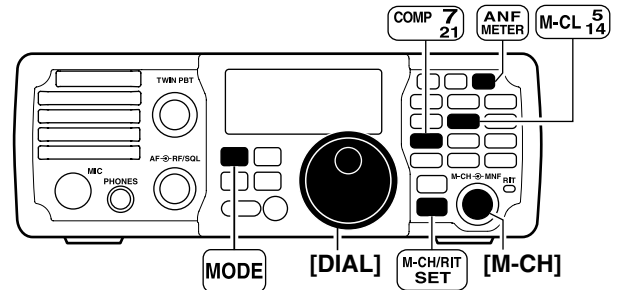

- ① Hold down **M-CH/RIT SET** for 1 second to enter the Quick Set mode.
- ② Rotate **[M-CH]** to select “**MIC GAIN**” to set the microphone gain.
- ③ While transmitting, speak at a normal voice level and rotate **[DIAL]** to adjust the microphone gain so that the ALC meter reads within the ALC zone, whether you speak softly or loudly.
 - Hold down **M-CL** for 1 second to return to the default value.
- ④ Push **M-CH/RIT SET** to exit the Quick Set mode.

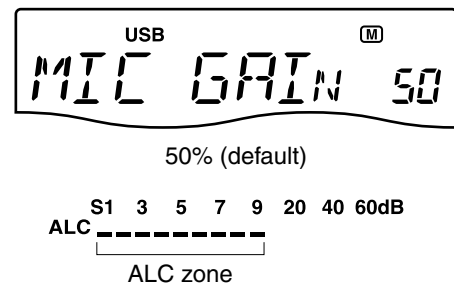

• Setting the compression level

- ① Hold down **ANF METER** for 1 second several times to select ALC meter.
 - “**ALC**” appears.
- ② Hold down **COMP** for 1 second to enter the speech compression level Set mode.
 - The speech compressor function is set to ON and “**COMP**” appears.
 - ▨ You can enter the speech compression level Set mode before selecting ALC meter in step ①.
- ③ While transmitting, speak at a normal voice level and rotate **[DIAL]** to adjust the speech compression level so that the ALC meter reads within the ALC zone, whether you speak softly or loudly.
 - Adjust the level to between 0 and 10, in one unit steps.
 - Hold down **M-CL** for 1 second to return to the default value.
- ④ Push **COMP** to exit the speech compression level Set mode.
- ⑤ Push **COMP** to turn the speech compressor function OFF when it is not necessary.
 - “**COMP**” disappears.

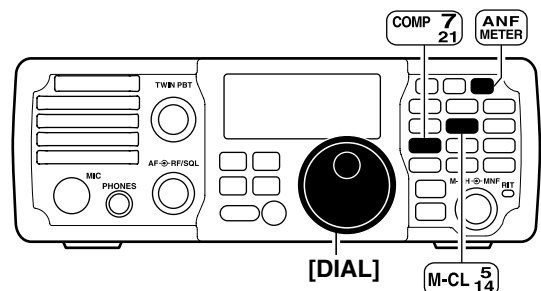
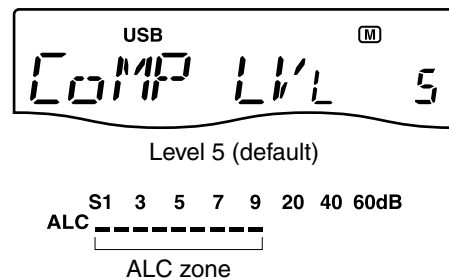

▨ **NOTE:** If the ALC meter peaks above the ALC zone, your voice may be distorted.

Split frequency operation

Split frequency operation allows you to transmit and receive in the same mode on two different frequencies, in the same **band**. The split frequency operation uses both VFO A and VFO B.

▨ The transmit and receive frequencies must be in the same band

Example: Setting 7.0620 MHz for receiving and 7.0750 MHz for transmitting.

- ① Push **A/B** to select VFO A.
 - “VFO A” appears.
- ② Set the frequency to 7.0620 MHz and mode to LSB. (pp. 3-5, 3-11)
- ③ Push **SPLIT** to turn ON the split function.
 - “**SPLIT**” appears.
- ④ Hold down **A/B** for 1 second to equalize the undisplayed VFO B frequency and operating mode with the displayed VFO A.
- ⑤ Push **A/B** to select VFO B.
 - “VFO B” appears.
- ⑥ Set the frequency to 7.0750 MHz (LSB). (p. 3-5)
- ⑦ Push **A/B** to return to the VFO A.
- ⑧ Now you can receive on 7.0620 MHz and transmit on 7.0750 MHz.

▨ To swap the transmit and receive frequencies, push **A/B** to toggle VFO A and VFO B.

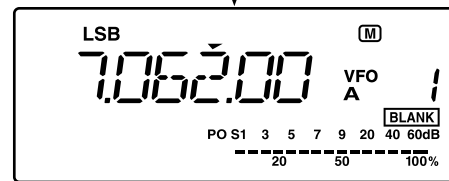
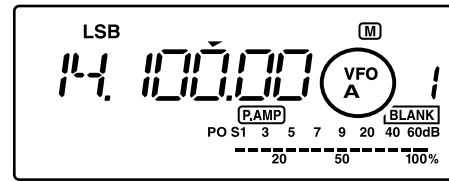

7.0620 MHz (LSB)

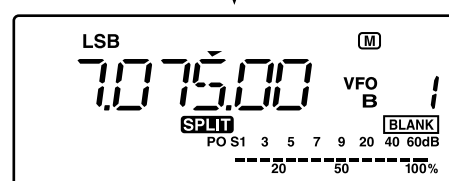
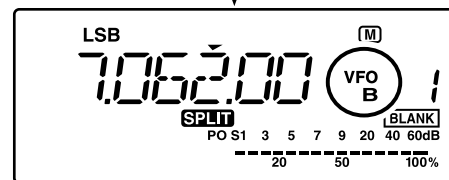
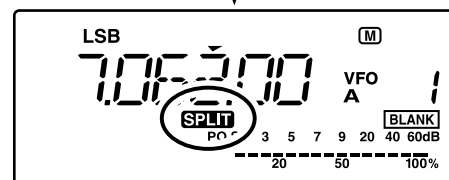

7.0750 MHz (LSB)

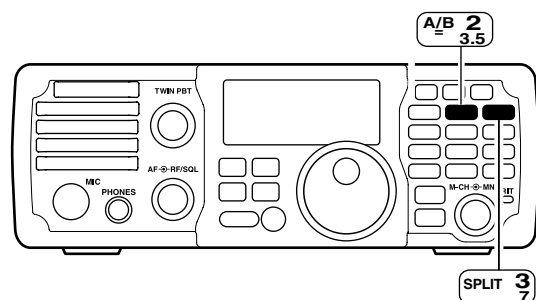

■ Split frequency operation (Continued)

CONVENIENT!

○ QUICK SPLIT FUNCTION (p. 6-10)

When you hold down **[SPLIT]** for 1 second, the **split** function is set to ON, and the **band,** frequency and mode of the undisplayed VFO is set the same as those of the displayed VFO. (This operation is same as steps ③ and ④ described on page 5-8.)

This shortens the time needed to start split frequency operation.

The Quick split function is set to ON by default, but can be turned OFF in the Set mode. (p. 10-10)

○ XFC FUNCTION (p. 10-11)

When the XFC (transmit frequency check) function is ON, the transmit frequency can be changed (this operation is the same as steps ⑤ and ⑥ to the left.)

NOTE: When the XFC function is ON, the RIT calculation function is disabled. (p. 5-2)

① Set the XFC (transmit frequency check) function to ON in the Set mode.

- ① Hold down **[M-CH/RIT SET]** for 1 second twice to enter the Set mode.
- ② Rotate **[M-CH]** to select "XFC."
- ③ Rotate **[DIAL]** to select ON.
- ④ Push **[M-CH/RIT SET]** to exit the Set mode.

② While holding down **[RIT]**, the transmit frequency is displayed. Rotate **[DIAL]** to set the transmit frequency.

- Also, the transmit frequency can be monitored while holding down **[RIT]**.

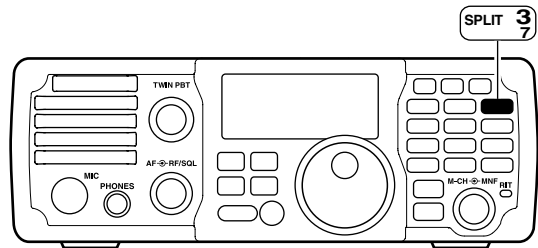

XFC function is ON

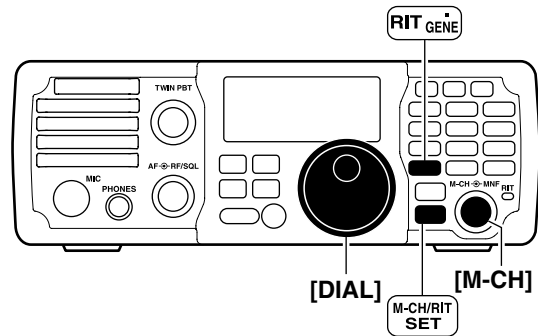

6 FUNCTIONS FOR TRANSMIT

■ Split frequency operation (Continued)

◇ Using the Quick split function

When you find a DX station that is operating **Split**, an important consideration is how to set the split frequency.

When you hold down **[SPLIT]** for 1 second, the split function is set to ON, and the **band**, frequency and mode of the undisplayed VFO is set the same as those of the displayed VFO.

This shortens the time needed to start split frequency operation.

Quick split operation is turned ON by default but can be turned OFF in the Set mode. (p. 10-10)

The following is an example of setting 7.0620 MHz for receiving and 7.0750 MHz for transmitting.

- ① Select VFO A.
 - Pushing **[A/B]** toggles VFO A and VFO B.
- ② Set the frequency to 7.0620 MHz and mode to LSB. (pp. 3-5, 3-11)
- ③ Hold down **[SPLIT]** for 1 second to turn ON the split function and equalize the undisplayed VFO B band, frequency and operating mode with the displayed VFO A.
 - **"SPLIT"** appears on the LCD.
- ④ Set the XFC (transmit frequency check) function ON in the Set mode. (pp. 5-9, 10-11)
 - The default setting is OFF.
- ⑤ While holding down **[RIT]**, rotate **[DIAL]** to set the transmit frequency to 7.0750 MHz.
- ⑥ Now you can receive on 7.0620 MHz and transmit on 7.0750 MHz.

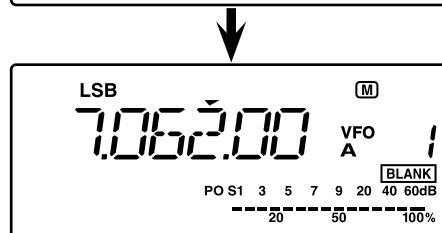
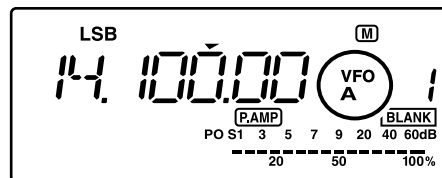

7.0620 MHz (LSB)

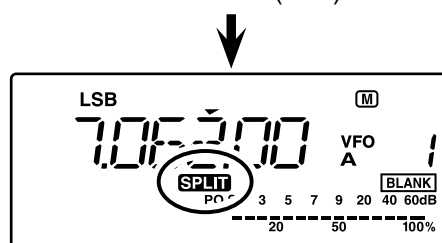

Set mode

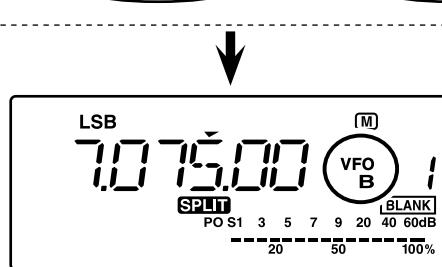

Set the transmit frequency to 7.0750 MHz.

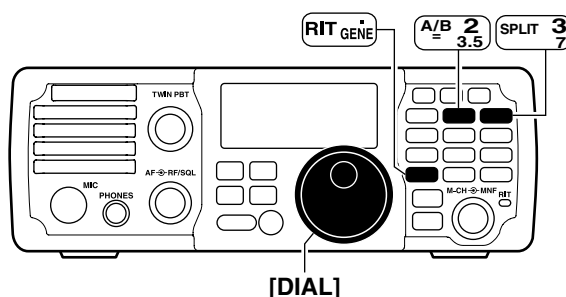

■ Split frequency operation (Continued)

◇ Split lock function

Accidentally releasing **[RIT]** while rotating **[DIAL]** changes the receive frequency. To prevent this, use both the **split** lock and dial lock functions to change the transmit frequency only. The split lock function cancels the dial lock function while holding down **[RIT]** during split frequency operation.

The dial lock's effectiveness during split frequency operation can be selected in the Set mode for both receive and transmit frequencies; or only the receive frequency. (p. 10-10)

When the split lock function is ON, the transmit frequency cannot be adjusted by rotating **[DIAL]** while transmitting, even if the lock function is not ON.

① Set the split lock function ON in the Set mode.

- ① Hold down **[M-CH/RIT SET]** for 1 second twice to enter the Set mode.
- ② Rotate **[M-CH]** to select "SPLIT LK."
- ③ Rotate **[DIAL]** to select ON.
- ④ Push **[M-CH/RIT SET]** to exit the Set mode.

② During split operation, hold down **[SPCH]** for 1 second to turn ON the dial lock function.
 • "TO" appears.

③ While holding down **[RIT]***, the transmit frequency and mode are displayed. And Rotate **[DIAL]** to set the transmit frequency.

*XFC function should be turned ON first. (p. 10-11)



OFF (default)

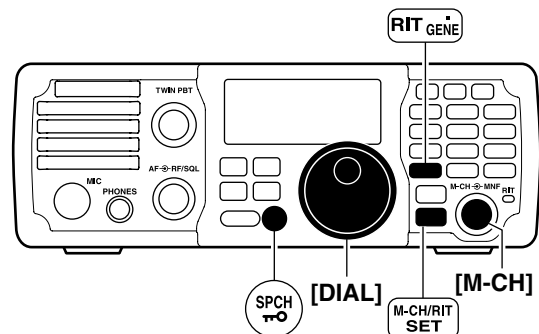

■ Measuring SWR

The IC-7200 has a built-in circuit for measuring antenna **SWR**—no external equipment is necessary.

- ① Push **[MODE]** one or more times to select the RTTY mode.
- ② Rotate **[DIAL]** to the desired operating frequency.
- ③ Set the output power to 30 W or more. (p. 3-14, 10-4)
- ④ Hold down **[ANF METER]** for 1 second one or more times to select the SWR meter.
- ⑤ Push **[PTT]** to transmit, then read the actual SWR on the meter.
 - ≤ 1.5 well-matched antenna
 - > 1.5 may indicate your antenna is out of its well-matched frequency range. If over 2.0, check antenna and cable connections.

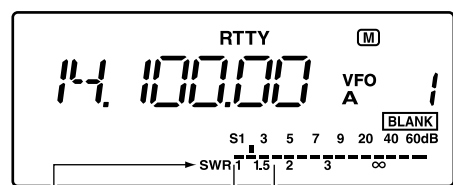
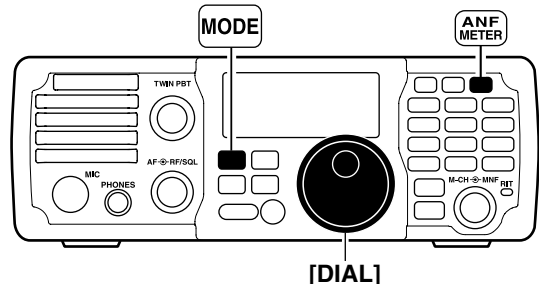

Appears The best match is in this range.

- About the Memory channels..... 7-2
- Selecting Memory channels 7-2
- Programming memory channels 7-3
 - ◇ Programming in VFO mode 7-3
 - ◇ Programming in memory mode 7-4
- Copying a frequency..... 7-5
 - ◇ Copying in the memory mode..... 7-5
- Clearing a memory 7-6

About the Memory channels

The transceiver has 201 memory channels, including 2 scan edge channels.

The Memory mode is very useful to quickly select often-used frequencies.

All 201 memory channels are tuneable, which means the programmed frequency can be tuned temporarily by rotating [DIAL], even in the memory mode.

MEMORY CHANNEL	MEMORY CHANNEL NUMBER	CAPABILITY	COPY TO VFO	OVER-WRITING	CLEAR
Regular memory channels	1-199	Independent transmit and receive frequencies and mode in each memory channel.	Yes	Yes	Yes
Scan edge memory channels	P1, P2	One frequency and mode in each memory channel to use as scan edges for a programmed scan.	Yes	Yes	No

Selecting Memory channels

- Push to select the Memory mode.
 - "MEMO" appears.
- Rotate [M-CH] to select the desired memory channel.
 - If the RIT control indicator lights orange, push to turn OFF the RIT and set the [M-CH] control to memory channel control. (See details below.)
 - All memory channels, including blank channels, can be selected.
 - Pushing [UP]/[DN] on the microphone also selects the memory channels. Only programmed memory channels are selectable using the microphone buttons.

About the [M-CH] control:

When the RIT control indicator lights orange, the memory channels cannot be selected by rotating the [M-CH] control because the [M-CH] control acts as the RIT control.

In this case, push to set the [M-CH] control to memory channel control (RIT control indicator goes out).

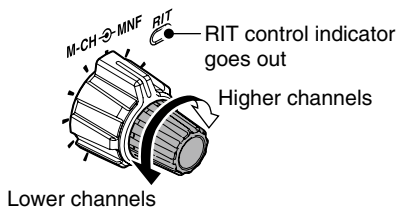

[EXAMPLE]: Selecting memory channel 17.

VFO mode

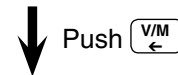

Memory mode

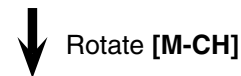

Channel 17 is selected.

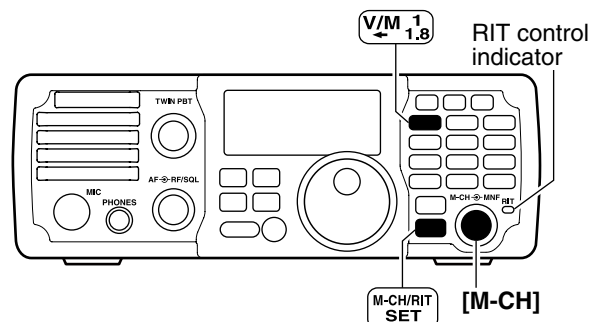

■ Programming memory channels

You can program the Memory channels in either the VFO mode or in the Memory mode.

◇ Programming in VFO mode

- ① Push **V/M** to select the VFO mode.
- ② Rotate **[DIAL]** to set the desired frequency, and then push **MODE** to set the operating mode.
- ③ Rotate **[M-CH]** to select the desired memory channel.
 - If the RIT control indicator lights orange, push **M-CH/RIT SET** (p. 7-2)
 - "**BLANK**" appears if the selected memory channel is a blank channel (one without any stored data.)

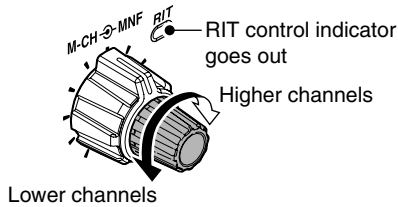

- ④ Hold down **MW** for 1 second to write the displayed frequency and operating mode into the selected memory channel.
 - 3 beeps sound when memory writing is completed.

[EXAMPLE]: Programming 7.088 MHz/LSB into channel 12.

VFO mode

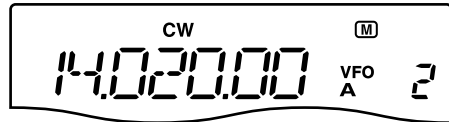

7.088 MHz/LSB



Rotate **[M-CH]**



Hold down **MW**



7.088 MHz/LSB are programmed into channel 12.

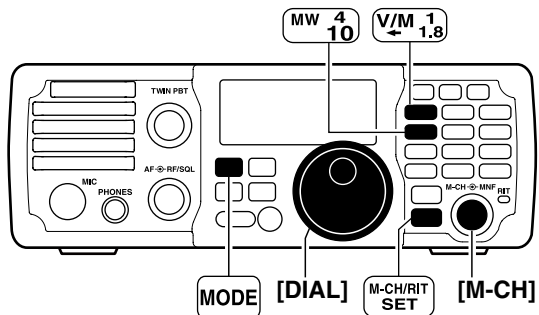

■ Memory programming (Continued)

◇ Programming in memory mode

- ① Push **[V/M]** to select the Memory mode.
- ② Rotate **[M-CH]** to select the desired memory channel.
 - If the RIT control indicator lights orange, push **[M-CH/RIT SET]**. (p. 7-2)
 - Memory channel contents appear in the display.

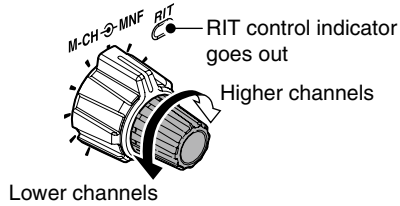

- ③ Rotate **[DIAL]** to set the desired frequency, and then push **[MODE]** to set the operating mode.
 - To program a blank channel, directly enter the frequency with the keypad. (p. 3-6)
- ④ Hold down **[MW]** for 1 second to write the displayed frequency and operating mode into the memory channel.
 - 3 beeps sound when memory writing is completed.

[EXAMPLE]: Programming 21.280 MHz/USB into channel 18.

Memory mode



↓ Rotate **[M-CH]**



Current frequency and mode in channel 18.

↓



New frequency and mode entered

↓

Hold down **[MW]** to write new data into channel 18.



21.280 MHz/USB are now in channel 18.

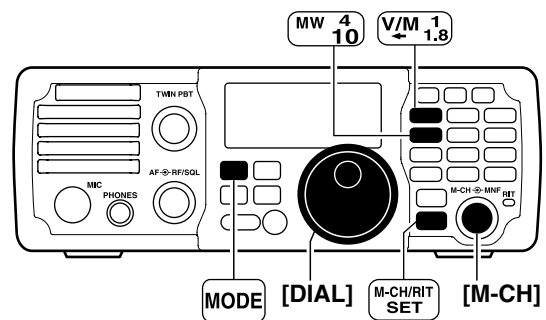

■ Copying a frequency

You can copy the frequency and operating mode in a memory channel to the VFO.

◇ Copying in the memory mode

This is useful for copying a memory channel's contents (frequency and operating mode) to a VFO while in the Memory mode.

This is useful when searching for signals around a memory channel frequency.

NOTE: While in the VFO mode, hold down **[V/M]** for 1 second to copy the selected memory channel's frequency and operating mode to the selected VFO.

When you have changed the frequency or operating mode in the selected memory channel:

- The displayed frequency and mode are copied.
- The programmed frequency and mode in the memory channel are not copied, and remain in the memory channel.

- 1 Push **[V/M]** to select the memory mode.
- 2 Rotate **[M-CH]** to select the desired memory channel you want to copy.
 - If the RIT control indicator lights orange, push **[M-CH/RIT SET]** (p. 7-2)
 - Set the frequency or operating mode if required.
 - "[BLANK]" appears if the selected memory channel is a blank channel. In this case copying is not possible.

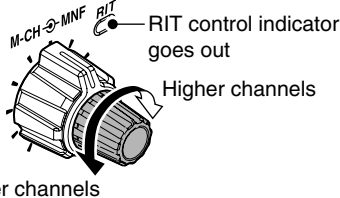

- 3 Hold down **[V/M]** for 1 second to copy the frequency and operating mode.
 - 3 beeps sound when the copying is completed.
 - The displayed frequency and operating mode are copied.
- 4 To return to the VFO mode, push **[V/M]**.
 - The copied frequency and operating mode appear in the display.

You can return to the VFO mode before copying the frequency and operating mode in step ③.

[EXAMPLE]: Copying the contents of memory
 Operating frequency : 14.020 MHz/CW
 Contents of memory 16 : 14.018 MHz/CW

Memory mode

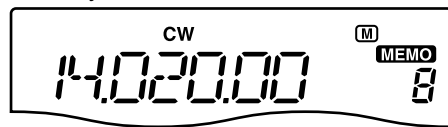

Rotate **[M-CH]**



Hold down **[V/M]**



Push **[V/M]**

VFO mode



14.018 MHz/CW are copied to the channel 18

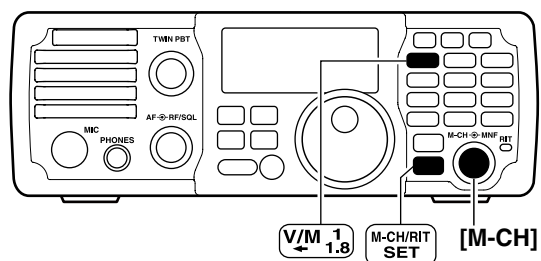

■ Clearing a memory

Any memory channels can be cleared. The cleared memory channels become blank channels.

- ① Push **V/M** to select the Memory mode.
- ② Rotate **[M-CH]** to select the desired memory channel to be cleared.
 - If the RIT control indicator lights orange, push **M-CH/RIT SET**. (p. 7-2)
- ③ Hold down **M-CL** for 1 second to clear the channel.
 - The programmed frequency and operating mode disappear and “**BLANK**” appears.
 - 3 beeps sound when memory clearing is completed.
- ④ To return to the VFO mode, push **V/M**.

NOTE: Be careful!— the contents of cleared memories CANNOT be recalled.

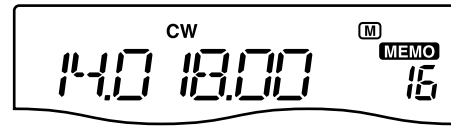

↓ Rotate **[M-CH]**



↓ Hold down **M-CL**

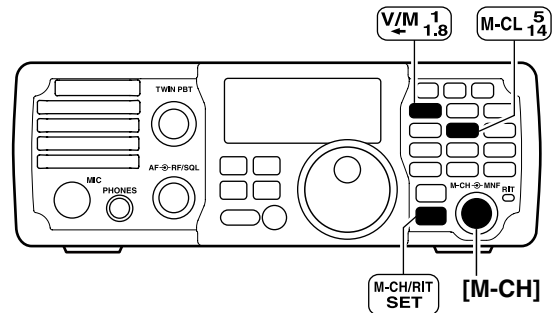

- Scan types..... 8-2
- Preparation..... 8-2
- Scan edges programming 8-3
- Scanning between programmed channels (VFO mode) .. 8-4
- Scanning Memory channels (Memory mode) 8-5

■ Scan types

Scanning automatically searches for signals and makes it easier to locate new stations for contact or listening purposes. The IC-7200 has two **scan** types; Programmed scan and Memory scan.

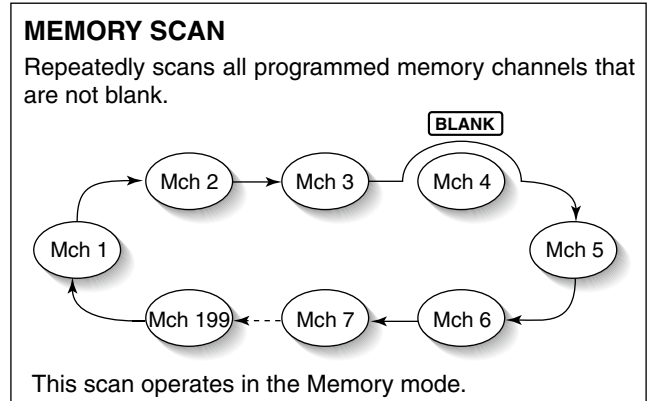
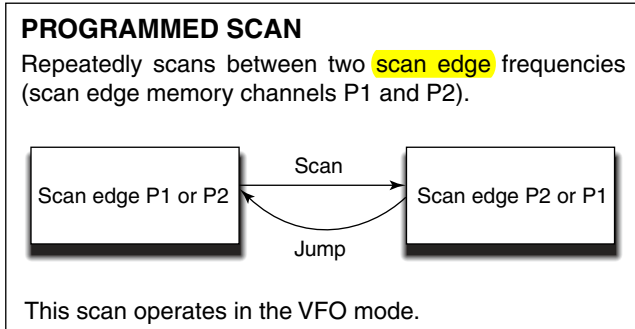

■ Preparation

• Channels

For a programmed scan:

Program scan edge frequencies into scan edge memory channels P1 and P2. (p. 8-3)

For a memory scan:

Program two or more memory channels other than scan edge memory channels.

• Scan resume ON/OFF

In the Set mode you can select the scan to resume or cancel when a signal is detected.

Scan resume must be set to ON or OFF before starting a scan. See page 10-13 for ON/OFF setting and scan resume details.

• Scan speed

You can select High or Low scan speeds in the Set mode. See page 10-13 for details.

• Squelch status

○ Scan starts with the squelch open

For a programmed scan:

When the **tuning step** is 1 kHz or less:

The scan continues until it is manually stopped by pushing **[SCAN]**, and does not pause*, even if signals are detected.

* The scan pauses when the **squelch** is closed and then opens (Scan resumes after 10 seconds has passed when the scan resume is ON; The scan is cancelled when resume is OFF).

When the tuning step is more than 5 kHz:

The scan pauses on each step when the scan resume is ON; not applicable when resume is OFF.

For a memory scan:

The scan pauses on each channel when the scan resume is ON; not applicable when it is OFF.

○ Scan starts with squelch closed

The scan stops when a signal is detected.

If you set scan resume ON in the Set mode, the scan pauses for 10 seconds when detecting a signal, then resumes. When a signal disappears while the scan is paused, scanning resumes 2 seconds later.

NOTE: If the **[RF/SQL]** control function is set to "AUTO," the squelch is always open in the SSB, CW and RTTY modes. (pp. 1-7, 3-12, 10-10)

■ Scan edges programming

Memory channels P1 and P2 are the Program **Scan Edge** channels. They are used to program the upper and lower frequency edges for the programmed **scan**. (p. 8-4)

Factory default frequency and operating modes are programmed into the Scan Edge channels.

If both upper and lower **band** edges are programmed with the same frequency, a programmed scan cannot start.

[EXAMPLE]: Programming 14.00000 MHz into P1 and 14.35000 MHz into P2.

- ① Push **[V/M]** to select the VFO mode.
- ② Rotate **[M-CH]** to select scan edge P1.
 - If the RIT control indicator lights orange, push **[M-CH/RIT SET]**. (p. 7-2)
- ③ Set 14.00000 MHz as the lower frequency.
- ④ Hold down **[MW]** for 1 second to write 14.00000 MHz into scan edge P1.
 - 3 beeps sound when memory writing is completed.
- ⑤ Rotate **[M-CH]** to select scan edge P2.
- ⑥ Set 14.35000 MHz as the upper frequency.
- ⑦ Hold down **[MW]** for 1 second to write 14.35000 MHz into scan edge P2.
 - 3 beeps sound when memory writing is completed.
- ⑧ When a programmed scan is started, it will search for signals between 14.00000 MHz and 14.35000 MHz. (p. 8-4)

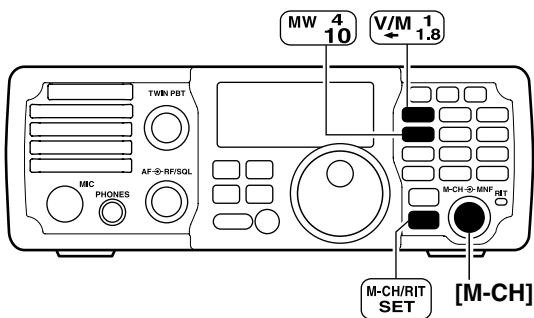

VFO mode



↓ Rotate **[M-CH]**

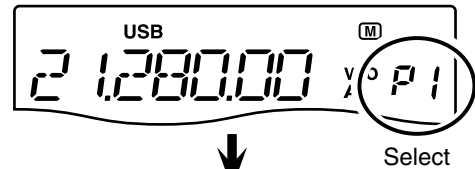

Select



The lower frequency is set.

↓ Hold down **[MW]** to write the lower frequency into P1.



↓ Rotate **[M-CH]**



Select



The upper frequency is set.

↓ Hold down **[MW]** to write the upper frequency into P2.



■ Scanning between programmed channels (VFO mode)

A programmed **scan** searches for signals between **scan edge** memory channels P1 and P2.

The default frequencies for these memories are 0.500000 MHz and 29.99999 MHz.

See page 8-3 for scan edges programming.

- ① Push **V/M** to select the VFO mode.
- ② Push **MODE** to select the desired operating mode.
 - The operating mode can be changed while scanning.
- ③ Push **TS** to select a **tuning step**.
 - The tuning step cannot be changed while scanning.
 - (The programmed tuning function can be turned ON or OFF while scanning.)
- ④ Set the **[RF/SQL]** control open or closed.
 - See the page 8-2 for **squelch** status details.
- ⑤ Push **SCAN** to start the scan.
 - “**SCAN**” appears while scanning.
- ⑥ When the scan detects a signal, the scan either ignores it, pauses or the scan stops, depending on the resume setting and the squelch status.
- ⑦ To cancel the scan, push **SCAN**.

NOTE: If the same frequencies are programmed into both scan edge memory channels P1 and P2, the programmed scan cannot start.

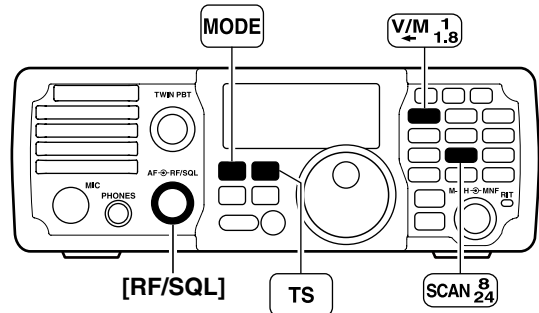
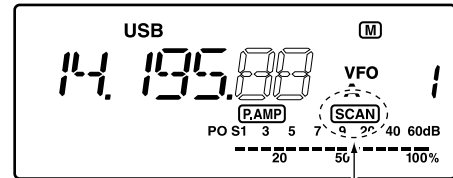

■ Scanning Memory channels (Memory mode)

A Memory **scan** searches for signals through memory channels 1 to 199. Blank (unprogrammed) memory channels are skipped.

- ① Push **V/M** to select the Memory mode.
- ② Close the **squelch** with the **[RF/SQL]** control.
- ③ Push **SCAN** to start the scan.
 - “**SCAN**” appears while scanning.
- ④ When the scan detects a signal, the scan either stops or pauses, depending on the resume setting.
- ⑤ To cancel the scan, push **SCAN**.
 - Rotating **[DIAL]** during scan also cancels the scan.

/// **NOTE:** Two or more different memory channels must be programmed for a memory scan to start.

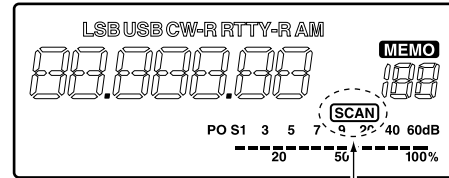

Appears

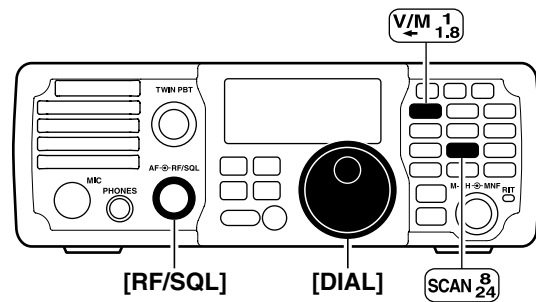

ANTENNA TUNER OPERATION

Section 9

- About the optional AT-180 AUTOMATIC ANTENNA TUNER... 9-2
 - ◇ Automatic tuning 9-2
 - ◇ Manual tuning 9-2
- Setting the AT-180 internal switches..... 9-3
- About the optional AH-4 AUTOMATIC ANTENNA TUNER 9-4
 - ◇ Operating the AH-4..... 9-4

■ About the optional AT-180 AUTOMATIC ANTENNA TUNER

The AT-180 automatic **antenna tuner** automatically matches the IC-7200 to your antenna. Once the tuner matches the antenna, the variable capacitor settings are memorized as a preset point for each frequency range (100 kHz steps). Therefore, when you change the frequency range, the variable capacitors are automatically preset to the memorized point.

NOTE:

- The AT-180 can match both the HF and 50 MHz **bands**. However, operation is different for the bands.
- When connecting the AT-180, the IC-7200's output power should be more than 10 W. Otherwise, the AT-180 may not tune correctly. The AT-180's minimum operating input power is 8 W.

CAUTION: NEVER transmit with the tuner ON if no antenna is connected. This will damage both the transceiver and antenna tuner.

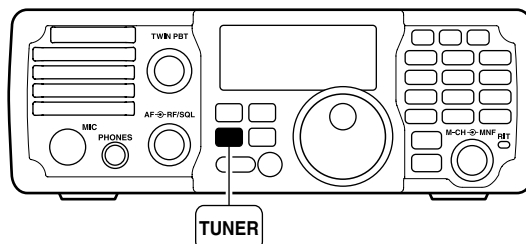

◇ Automatic tuning

• For the HF band:

Push **TUNER** to turn ON the tuner. The antenna is automatically tuned during transmit if the antenna **SWR** is higher than 1.5:1.

- When the tuner is ON, "**TUNE**" appears.

• For the 50 MHz band:

Hold down **TUNER** for 1 second to tune the antenna. If "**TUNE**" blinks slowly while transmitting, hold down **TUNER** for 1 second again to retune the antenna.

◇ Manual tuning

During SSB operation on the HF bands at low voice levels, the AT-180 may not tune correctly. In such cases, manual tuning is helpful.

Hold down **TUNER** for 1 second to start manual tuning.

- When the CW mode is selected, a side tone is emitted, and "**TUNE**" blinks; then, the previous mode is selected.

If the tuner cannot reduce the SWR to less than 1.5:1 after 20 seconds of tuning, "**TUNE**" disappears. In this case, check the following:

- the antenna connection and feedline
- the antenna SWR (p. 3-13; meter function, p. 6-11; Measuring SWR)

Through inhibit (HF bands only)

The AT-180 has a through inhibit setting. When selecting this setting, the tuner can be used at poor SWR's. In this case, automatic tuning in the HF bands activates only when the SWR exceeds 3:1. Therefore, manual tuning is necessary each time you change the frequency. Although termed "through inhibit," the tuner will be set to the "through" configuration if the SWR is higher than 3:1 after tuning.

CONVENIENT

• Tuner sensitive setting (HF bands only)

If you require critical tuning at any time during transmission, select the tuner sensitive setting. See page 9-3 for selection details.

• Automatic tuner start (HF bands only)

If you want to turn OFF the tuner when the VSWR is 1.5:1 or less, use "automatic tuner on" and turn OFF the tuner. See page 10-11 for automatic tuner function.

• PTT tune function

The AT-180 tunes when [PTT] is pushed after the frequency is changed (more than 1%) if the AT-180 is turned ON. This function removes the "hold down **TUNER**" operation and activates with the first transmission on the new frequency. (p. 10-11)

Turn this function ON in the Set mode.

■ Setting the AT-180 internal switches

The optional AT-180 has 3 operating configurations for HF **band** operation. Select a suitable configurations for your antenna system.

- ① Remove the top cover of the AT-180.
- ② Set the tuner switches to the desired positions according to the table below.

SW	Position	Operation
S1	A (default)	The tuner operating mode is set by S2 described below.
	B	THROUGH INHIBIT The tuner tunes the antenna even when the antenna has poor SWR (up to VSWR 3:1 after tuning). In this case, manual tuning is necessary each time you change the frequency although the tuner automatically starts tuning when the VSWR is higher than 3:1. This setting is called "through inhibit," however, the tuner is set to "through" if the VSWR is higher than 3:1 after tuning.
S2	C	TUNER SENSITIVE SETTING The tuner tunes each time you transmit (except SSB mode). Therefore, the lowest SWR is obtained at any given time. For SSB mode, the same SETTING as the "D" position.
	D (default)	NORMAL The tuner tunes when the SWR is higher than 1.5:1. Therefore, the tuner activates only when tuning is necessary.

• Specifications for the AT-180

- Frequency coverage : 1.8–54 MHz
- Input impedance : 50 Ω
- Maximum input power : 120 W
- Minimum tuning power : 8 W
- Matching impedance range : 16.7–150 Ω (HF band)
20–125 Ω (50 MHz band)
- Tuning accuracy : Less than SWR 1.5:1
- Insertion loss : Less than 1.0 dB (after tuning)
- Power supply requirements: 13.8 V DC/1 A (supplied from the transceiver's ACC socket)
- Dimensions (mm/in) : 167(W) × 58.6(H) × 225(D)
6.6(W) × 2.3(H) × 8.9(D)
- Weight (approx.) : 2.3 kg; 5.1 lb
- Supplied accessories : Coaxial cable (1 m),
ACC cable (DIN 13 pins)

• AT-180 inside top cover

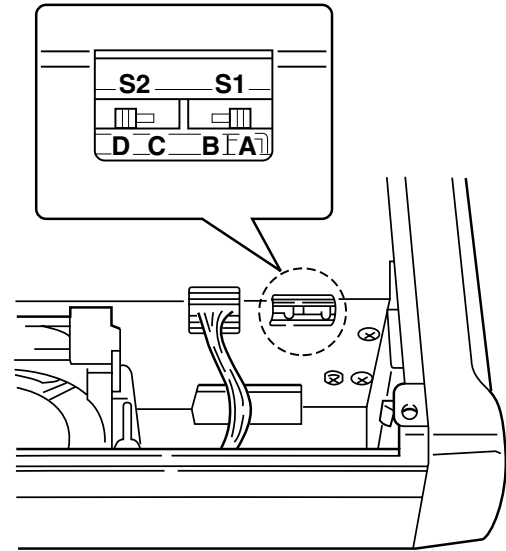

• Connector information for the ACC(2) socket

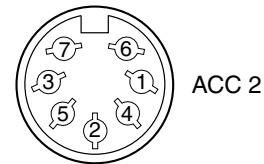

PIN NO./NAME	DESCRIPTION
① NC (8 V*)	(*If the Band Voltage modification is performed, regulated 8 V output. (p. 12-2)) (10 mA max.)
② GND	Connects to ground.
③ SEND	Input/output pin. Goes to ground when transmitting (20 mA max). When grounded, transmits.
④ NC (BAND*)	(*If the Band Voltage modification is performed, band voltage output. (p. 12-2))
⑤ ALC	ALC output voltage (–4 to 0 V).
⑥ NC	No connection.
⑦ 13.8 V	13.8 V output when power is ON (1 A max).

■ About the optional AH-4 AUTOMATIC ANTENNA TUNER

The AH-4 matches the IC-7200 to a long wire antenna more than 7 m/23 ft long (3.5 MHz and above).

- See page 2-4, 2-6 for connection.
- See the AH-4 instruction manual for AH-4 installation and antenna connection details.

AH-4 setting example:

For mobile operation

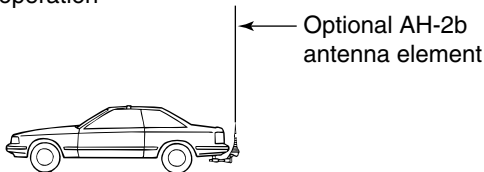

For outdoor operation

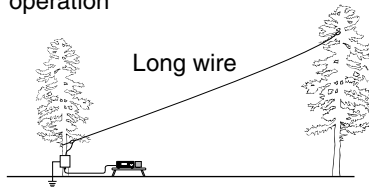

⚠ DANGER HIGH VOLTAGE!
NEVER touch the antenna element while tuning or transmitting.

NEVER operate the AH-4 without an antenna connected. The tuner and transceiver will be damaged.

NEVER operate the AH-4 when it is ungrounded.

Transmitting before tuning may damage the transceiver. Note that the AH-4 cannot tune when using a $\frac{1}{2}\lambda$ long wire or on a multiple of that frequency.

◇ Operating the AH-4

Tuning is required for each frequency. **Be sure** to retune the antenna before transmitting when you change the frequency—even slightly.

- ① Set a desired frequency in an HF band.
 - The AH-4 will not operate on frequencies outside of the ham bands.
- ② Hold down **TUNER** for 1 second.
 - "TUNE" blinks while tuning.
- ③ "TUNE" is still ON after the tuning is completed.
 - When the connected wire cannot be tuned, "TUNE" goes out, the AH-4 is bypassed and the antenna wire is directly connected.
- ④ Push **TUNER** to manually bypass the AH-4.
 - "TUNE" goes out.

CONVENIENT

- **PTT tune function** (p. 10-11)
 The AH-4 always tunes when [PTT] is pushed after the frequency is changed (more than 1%). This function replaces the "hold down **TUNER**" operation and is activated on the first transmission on the new frequency.
 Turn ON this function in the Set mode.

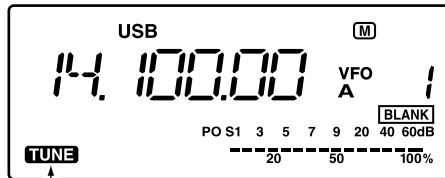

Appears when the antenna tuner is ON.
 Blinks while tuning.

- About the Set Mode..... 10-2
 - ◇ Using the Quick Set mode 10-2
 - ◇ Using the Set mode 10-3
- Items in the Quick Set mode 10-4
- Items in the Set mode 10-7
 - ◇ Connect a paddle to the [MIC] connector 10-17

■ About the Set Mode

The Set mode is for programming infrequently changed values or functions.

The IC-7200 has 2 separate Set modes: the **Quick Set mode** and the **Set mode**.

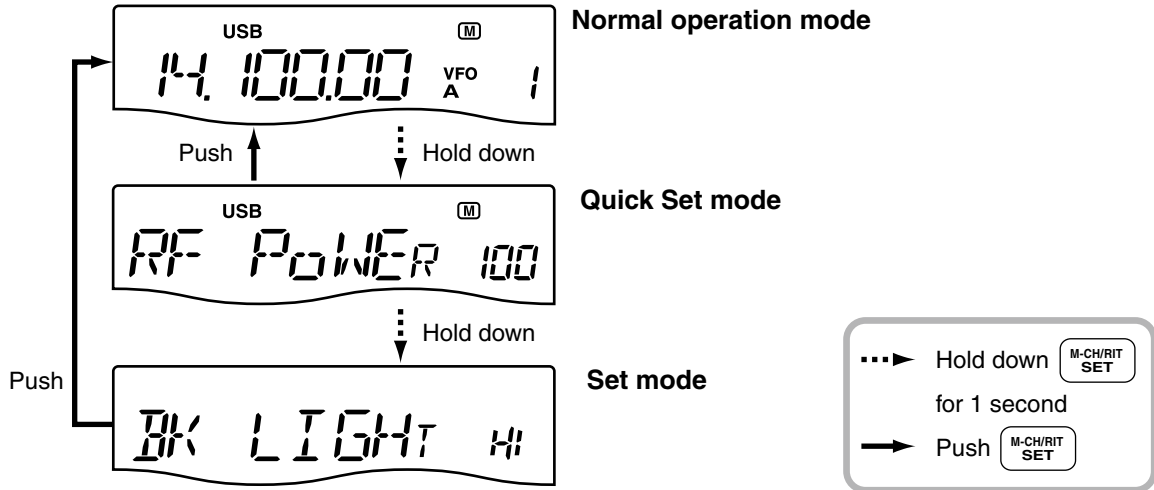

◇ Using the Quick Set mode

- ① Hold down **M-CH/RITE SET** for 1 second to enter the Quick Set mode.
- ② Rotate **[M-CH]** to select the desired item.
- ③ Set the desired option or value using **[DIAL]**.
 - Hold down **M-CL** for 1 second to select the default option or value.
- ④ Repeat ② and ③ to set other items.
- ⑤ Push **M-CH/RITE SET** to exit the Quick Set mode.

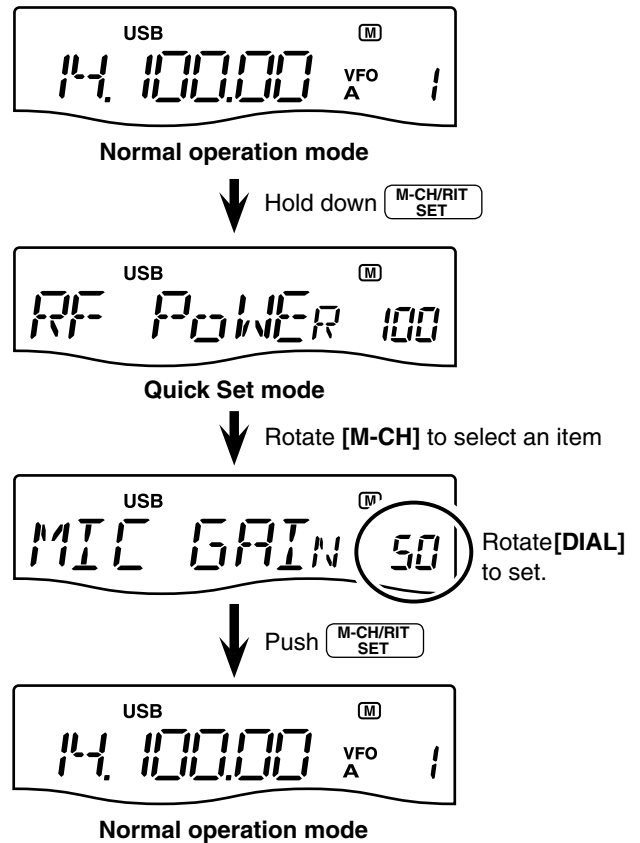
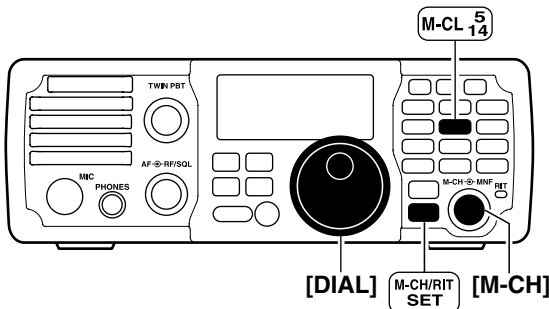

◇ Using the Set mode

- ① Hold down **M-CH/RIT SET** for 1 second to enter the Quick Set mode.
- ② Hold down **M-CH/RIT SET** for 1 second again to enter the Set mode.
- ③ Rotate **[M-CH]** to select the desired item.
- ④ Set the desired option or value using **[DIAL]**.
 - Hold down **[M-CL]** for 1 second to select the default option or value.
- ⑤ Repeat ③ and ④ to set other items.
- ⑥ Push **M-CH/RIT SET** to exit the Set mode.

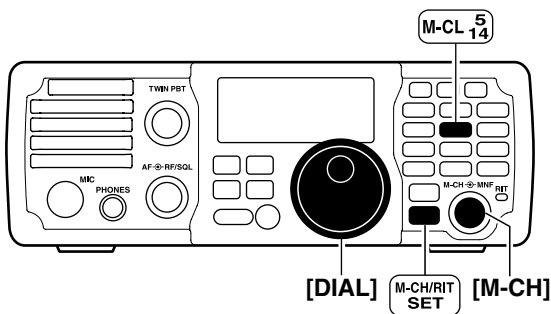

Normal operation mode

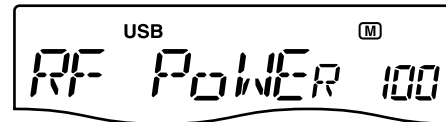
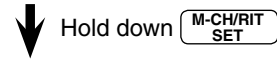

Quick Set mode

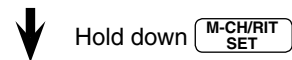

Set mode

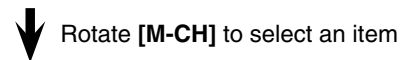

Rotate [DIAL] to set.



Normal operation mode

■ Items in the Quick Set mode

Item	Range or Value (Default is shown in bold)	Descriptions	Operating Mode	Refer
RF POWER	L (Low) and 1 to 100% , in 1% steps	Adjusts the RF output power.	All	p. 10-4
MIC GAIN	0 ~ 50 ~ 100%, in 1% steps	Adjusts the microphone gain.	SSB/AM	
DATA MODE	on or oF	Turn the data mode ON or OFF.	SSB/AM	p. 10-5
KEY SPEED	6 ~ 20 ~ 60* wpm (words per minute). * 39, 43, 45, 47, 49, 51, 53, 55, 56, 58 and 59 cannot be selected.	Adjusts the CW key speed.	CW	
CW TONE PITCH	300 ~ 600 ~ 900 Hz, in 10 Hz steps	Adjusts the CW receive tone pitch.	CW	
SIDE TONE LEVEL	0 ~ 30 ~ 100%, in 1% steps	Adjusts the CW side tone level.	CW	
SIDE TONE LIMIT	on or oF	Turn the CW side tones output level limiting capability ON or OFF.	CW	
TWIN PEAK FILTER	on or oF NOTE: The RTTY mark frequency (2125 Hz) and shift width (170 Hz) are automatically set when the twin peak filter is ON.	Turn the twin peak filter ON or OFF.	RTTY	p. 10-6
RTTY MARK TONE	1275, 1615 or 2125 Hz	Sets the RTTY mark frequency.	RTTY	
RTTY SHIFT	170 , 200, 425 or 850 Hz	Sets the RTTY shift width.	RTTY	
RTTY KEY POLARITY	n (Normal) or r (Reverse)	Sets the RTTY keying polarity.	RTTY	

RF power (all modes)
Adjusts the RF output power to between L (Low), and 1% to 100%, in 1% steps.

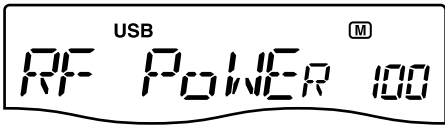

100% (default)

Mic gain (SSB/AM modes)
Adjusts microphone gain to between 0% and 100%, in 1% steps.



50% (default)

10 SET MODE

■ Items in the Quick Set mode (Continued)

Data mode (SSB/AM modes)

Turn the data mode ON or OFF.

When the data mode is turned ON, the audio, input from the [ACC] connector, the [MIC] connector, or the [USB] connector, is used depending on the selection in the Set Mode. (p. 10-11)

The speech compressor function is automatically turned OFF.

on : Data mode operation is enabled.

("D" appears.)

oF : Data mode operation is disabled.

("D" disappears.)

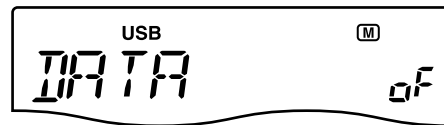

OFF (default)

Key speed (CW mode)

Adjusts the CW key speed to between 6 and 60* wpm (words per minute).

* 39, 43, 45, 47, 49, 51, 53, 55, 56, 58 and 59 cannot be selected.

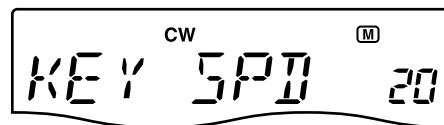

20 WPM (default)

CW tone pitch (CW mode)

Adjusts the CW receive tone pitch to between 300 and 900 Hz, in 10 Hz steps.



600 Hz (default)

Side tone level (CW mode)

Adjusts the CW side tone level to between 0% and 100%, in 1% steps.

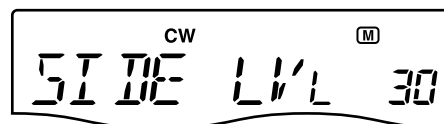

30% (default)

Side tone level limit (CW mode)

Turn the CW side tones output level limiting capability ON or OFF.

When this item is set to ON, the CW side tone is linked to the [AF] control until rotation of the [AF] control reaches the specified level—further rotation will not increase the volume of the CW side tones.

on : The CW side tone level is limited with the [AF] control.

oF : The CW side tone level is linked to the [AF] control.

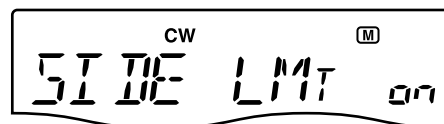

ON (default)

10 SET MODE

■ Items in the Quick Set mode (Continued)

Twin peak filter (RTTY mode)

Turn the twin peak filter ON or OFF.

on : The Twin peak filter is ON.

oF : The Twin peak filter is OFF.

/// **NOTE:** The RTTY mark frequency (2125 Hz) and shift width (170 Hz) are automatically set when the twin peak filter is ON.

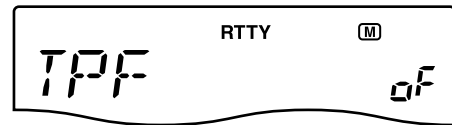

OFF (default)

RTTY mark tone (RTTY mode)

Sets the RTTY mark frequency to 1275, 1615 or 2125 Hz.

/// **NOTE:** 2125 Hz is automatically set when the twin peak filter is ON.



2125 Hz (default)

RTTY shift width (RTTY mode)

Sets the RTTY shift width to 170, 200, 425 or 850 Hz.

/// **NOTE:** 170 Hz is automatically set when the twin peak filter is ON.



170 Hz (default)

RTTY key polarity (RTTY mode)

Sets the RTTY keying polarity to normal or reverse.

When reverse polarity is selected, Mark and Space are reversed.

n (normal) : Key open/close = Mark/Space

r (reverse) : Key open/close = Space/Mark

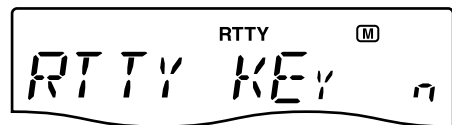

NORMAL (default)

■ Items in the Set mode

Item	Range or Value (Default is shown in bold)	Descriptions	Refer
LCD BACKLIGHT	HI (High), Lo (Low) or oF (Off)	Sets the brightness of the LCD.	p. 10-9
BEEP	on or oF	Turns the Confirmation beep ON or OFF.	
BAND EDGE BEEP	on or oF	Turns the Band edge beep ON or OFF.	
BEEP LEVEL	0 ~ 50 ~ 100%, in 1% steps	Sets the maximum volume level for the confirmation beep and band edge beep tones	
BEEP LEVEL LIMIT	on or oF	Turns the beep tones output level limiting ON or OFF.	
RF/SQL CONTROL	rS (RF+SQL), Sq (SQL) or At (AUTO)	Selects the RF/SQL Control function.	p. 10-10
METER PEAK HOLD	on or oF	Turns the meter peak hold function ON or OFF.	
QUICK SPLIT	on or oF	Turns the Quick split function ON or OFF.	
SPLIT LOCK	on or oF	Turns the Split Lock function ON or OFF.	
XFC	on or oF	Turns the XFC (transmit frequency check) function ON or OFF.	p. 10-11
AUTO TUNE	on or oF	Turns the Auto tune function ON or OFF.	
PTT TUNE	on or oF	Turns the PTT Tune function ON or OFF.	
MODULATION INPUT (DATA OFF)	M (MIC), A (ACC), MA (MIC/ACC) or U (USB)	Selects the desired connector(s) for modulation input when the SSB data/AM data mode is not in use.	
MODULATION INPUT (DATA ON)	M (MIC), A (ACC), MA (MIC/ACC) or U (USB)	Selects the desired connector(s) for modulation input when the SSB data/AM data mode is in use.	
USB LEVEL	0 ~ 50 ~ 100%, in 1% steps	Sets the input modulation level of the USB jack.	p. 10-12
SPEECH LEVEL	0 ~ 50 ~ 100%, in 1% steps	Sets the volume level of the speech function.	
SPEECH LANGUAGE	En (English) or JP (Japanese)	Selects English or Japanese as the language of the speech function.	
SPEECH SPEED	HI (faster) or Lo (slower)	Selects the speech speed.	
SPEECH S-LEVEL	on or oF	Turns the S-Level Speech announcement function ON or OFF.	
SPEECH [MODE] KEY	on or oF	Turns the Speech [MODE] key function ON or OFF.	
SCAN SPEED	HI (faster) or Lo (slower)	Sets the rate at which channels or frequencies are scanned during scanning.	
SCAN RESUME	on or oF	Turns the Scan resume function ON or OFF.	
MAIN DIAL AUTO TS	HI (Fastest), Lo (Faster) or oF (OFF)	Set the Main Dial automatic tuning speed when rotating [DIAL] rapidly.	
DIAL 1/4	on or oF	Turn the 1/4-speed tuning function ON or OFF in the CW, RTTY and SSB data modes.	

10 SET MODE

■ Items in the Set mode (Continued)

Item	Range or Value (Default is shown in bold)	Descriptions	Refer
MIC UP/DOWN SPEED	HI (faster) or Lo (slower)	Sets the rate at which frequencies are scanned when the microphone [UP]/[DN] keys are held down.	p. 10-13
SSB/CW SYNCHRONOUS TUNING	on or oF	Turns the displayed frequency shift function ON or OFF.	p. 10-14
CW NORMAL SIDE	L (LSB) or U (USB)	Select the carrier point of CW mode between LSB and USB.	
BREAK-IN	oF (OFF), SE (Semi) or FL (Full)	Selects the CW break-in type.	
BREAK-IN DELAY	0.2 ~ 7.5 ~ 13.0 (dots), in 0.1 dots steps	Sets the break-in delay time for CW semi break-in operation.	
DOT/DASH RATIO	1:1:2.8 ~ 1:1:3.0 ~ 1:1:4.5, in 0.1 unit steps.	Sets the internal electronic keyer dot/dash ratio.	p. 10-15
PADDLE POLARITY	n (Normal) or r (Reverse)	Sets the paddle polarity.	
KEYER TYPE	EL (ELEC-KEY), bG (BUG-KEY) or St (Straight key)	Selects the keyer type for the [KEY] connector on the rear panel.	
MIC UP/DOWN KEYER	on or oF	Sets the activation of the microphone [UP]/[DN] switches as a paddle.	p. 10-16
MODE SELECT (SSB)	on or oF	Turns the SSB (LSB/USB) mode selection ON or OFF.	
MODE SELECT (CW)	on or oF	Turns the CW/CW-R mode selection ON or OFF.	
MODE SELECT (RTTY)	on or oF	Turns the RTTY/RTTY-R mode selection ON or OFF.	
MODE SELECT (AM)	on or oF	Turns the AM mode selection ON or OFF.	
CI-V BAUD RATE	300, 1200, 4800, 9600, 19200 bps or Auto .	Sets the CI-V data transfer rate.	
CI-V ADDRESS	76h	Sets the CI-V address.	p. 10-17
CI-V TRANSCEIVE	on or oF	Turn the CI-V Transceive function ON or OFF.	
REFERENCE FREQUENCY ADJUSTMENT	0 ~ 100%, in 1% steps (Default setting is different for each transceiver.)	Sets the internal reference signal frequency.	

10 SET MODE

■ Items in the Set mode (Continued)

LCD Backlight

Set the brightness of the LCD to HI (High), Lo (Low) or oF (Off).

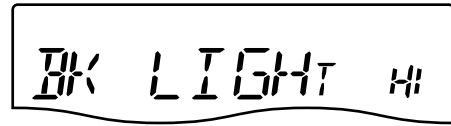

High (default)

Beep

A beep sounds each time a key is pushed. This function can be turned OFF for silent operation.

on : The Confirmation beep is ON.

oF : The Confirmation beep is OFF.



ON (default)

The volume level can be set in "Beep Level," as described below.

Band Edge Beep

A beep sounds when an operating frequency enters or exits an amateur **band**. This function is independent from the "Beep" setting as described above.

on : The Band edge beep is ON.

oF : The Band edge beep is OFF.



ON (default)

The volume level can be set in "Beep Level," as described below.

Beep Level

Set the maximum volume level for the confirmation beep and band edge beep tones to between 0% and 100%, in 1% steps.

When beep tones are set to OFF, this setting has no effect.

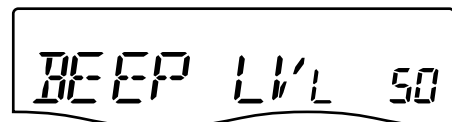

50% (default)

Beep Level Limit

Turn the beep tones output level limiting ON or OFF for the confirmation and band edge beep tones.

When this item is set to ON, the beep tones are linked to the [AF] control until rotation of the [AF] control reaches to the specified level—further rotation will not increase the volume of the beep tones.

on : The Beep level is limited with the [AF] control.

oF : The Beep level is linked to the [AF] control.

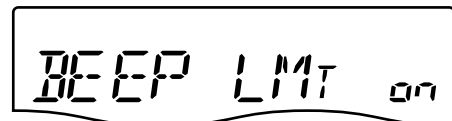

ON (default)

10 SET MODE

■ Items in the Set mode (Continued)

RF/SQL Control

Set as the RF/squelch control, the squelch control only (RF gain is fixed at maximum) or Auto (RF gain control in SSB, CW and RTTY; squelch control in AM).

See pages 1-7, 3-12 for details.

rS (RF+SQL) : The [RF/SQL] control is set as the RF/squelch control.

Sq (SQL) : The [RF/SQL] control is set as the squelch control.

At (AUTO) : The [RF/SQL] control is set as the RF gain control in SSB, CW and RTTY; squelch control in AM.



RF + SQL (default)

Meter Peak Hold

Turn the meter peak hold function ON or OFF.

on : The highest activated segment of the meter remains visible for 0.5 seconds.

oF : The meter functions normally.

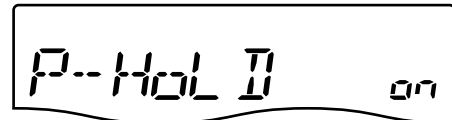

ON (default)

Quick Split

Turn the Quick split function ON or OFF.

When this item is set to ON, hold down **SPLIT** for 1 second. to set the undisplayed VFO frequency and operating mode to the same as the displayed VFO frequency and operating mode.

See pages 6-9 and 6-10 for details.

on : The quick split function is ON.

oF : The quick split function is OFF.

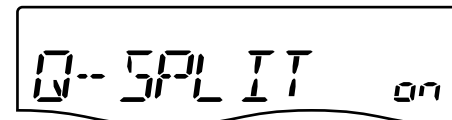

ON (default)

Split Lock

Turn the Split Lock function ON or OFF.

When this item is set to ON, the transmit frequency can be adjusted by rotating **[DIAL]** while holding down **[RIT]***, even if the lock function is turned ON.

* The transmit frequency check function ("XFC"; as described on page 10-11) must be turned ON first.

See page 6-8 for split frequency operation details.

NOTE: When the split lock function is ON, the transmit frequency cannot be adjusted by rotating **[DIAL]** while holding down **[PTT]**, even if the lock function is not turned ON.

on : The split lock function is ON.

oF : The split lock function is OFF.



OFF (default)

10 SET MODE

■ Items in the Set mode (Continued)

XFC

Turn the XFC (transmit frequency check) function ON or OFF.

on : The transmit frequency can be monitored while holding down **[RIT]**.

oF : The transmit frequency check function is OFF.

NOTE: When the XFC function is ON, the RIT calculation function is disabled. (p. 5-2)

The LCD display shows the text "XFC" on the left and "oF" on the right, indicating the XFC function is turned off.

OFF (default)

Auto Tune

Turns the Auto tune function ON or OFF. The AT-180 antenna tuner has an automatic start capability which starts tuning if the **SWR** is higher than 1.5:1.

on : The automatic tune starts even when the tuner is turned OFF during HF **band** operation.

oF : The tuner remains OFF even when the SWR is poor (1.5:1).

The LCD display shows the text "AT-TUNE" on the left and "oF" on the right, indicating the Auto Tune function is turned off.

OFF (default)

PTT Tune

Turns the PTT Tune function ON or OFF. Tuning of the antenna tuner can be automatically started at the moment [PTT] is pushed after the operating frequency is changed more than 1% from the last-tuned frequency. When an AT-180 antenna tuner is connected, the tuner function must be turned ON first.

on : Tuning starts when [PTT] is pushed on a new frequency.

oF : Tuning starts only when **[TUNER]** is pushed.

The LCD display shows the text "PTT TUNE" on the left and "oF" on the right, indicating the PTT Tune function is turned off.

OFF (default)

Modulation input (Data OFF)

Selects the desired connector(s) for **modulation** input when the SSB data/AM data mode is not in use.

M (MIC) : Use the signals from [MIC].

A (ACC) : Use the signals from [ACC] (pin11).

M A (MIC/ACC) : Use the signals from [MIC] and [ACC] (pin11).

U (USB) : Use the signals from [USB].

The LCD display shows the text "Mod U" on the left and "M A" on the right, indicating the modulation input is set to MIC/ACC.

MIC/ACC (default)

Modulation input (Data ON)

Selects the desired connector(s) for modulation input when the SSB data/AM data mode is in use.

M (MIC) : Use the signals from [MIC].

A (ACC) : Use the signals from [ACC] (pin11).

M A (MIC/ACC) : Use the signals from [MIC] and [ACC] (pin11).

U (USB) : Use the signals from [USB].

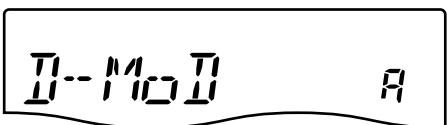
The LCD display shows the text "U-Mod" on the left and "A" on the right, indicating the modulation input is set to ACC.

ACC (default)

10 SET MODE

■ Items in the Set mode (Continued)

USB Level

Sets the input **modulation** level of the USB jack to between 0% to 100% in 1% steps.

The LCD display shows the text "USB LVL" followed by "50" on the right side.

50% (default)

Speech Level

Adjusts the volume level of the speech function to between 0% and 100%, in 1% steps.

The LCD display shows the text "SP LVL" followed by "50" on the right side.

50% (default)

Speech Language

Selects English or Japanese as the language of the speech function.

En : English

JP : Japanese

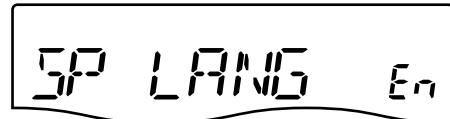
The LCD display shows the text "SP LANG" followed by "En" on the right side.

English (default)

Speech Speed

Selects HI (faster) or Lo (slower) as the speech speed.

HI: Faster announcement

Lo: Slower announcement

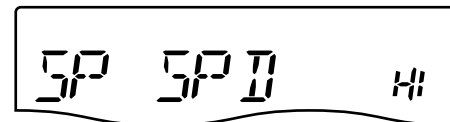
The LCD display shows the text "SP SPD" followed by "HI" on the right side.

High (default)

Speech S-level

The received signal level, frequency and mode can be announced by the voice synthesizer. The signal level announcement can be turned OFF if desired.

When "oF" is selected, the signal level is not announced.

on : The signal level is announced.

oF : The signal level is not announced.

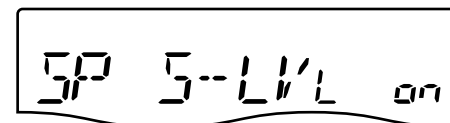
The LCD display shows the text "SP S-LVL" followed by "on" on the right side.

ON (default)

Speech [MODE] Key

Selects whether the operating mode is announced with the speech synthesizer when **[MODE]** is pushed.

When "on" is selected, the operating mode is announced when you push **[MODE]**.

on : The operating mode is announced when pushing **[MODE]**.

oF : The operating mode is not announced when pushing **[MODE]**.

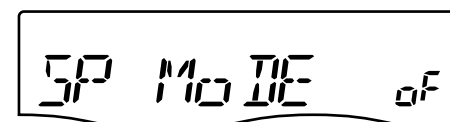
The LCD display shows the text "SP MODE" followed by "oF" on the right side.

OFF (default)

10 SET MODE

■ Items in the Set mode (Continued)

Scan Speed

Sets the speed at which channels or frequencies are scanned during scanning.

High and low can be selected.

HI: Fast scan

Lo: Slow scan

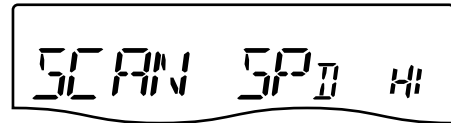
The LCD display shows the text "SCAN SPD HI" in a digital font. The "HI" is positioned to the right of "SPD".

High (default)

Scan Resume

This item turns the scan resume function ON or OFF.

on : Scan resumes 10 seconds after stopping on a signal (or 2 seconds after a signal disappears).

oF : Scan does not resume after stopping on a signal.

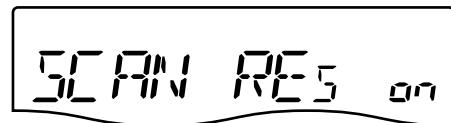
The LCD display shows the text "SCAN RES on" in a digital font. The "on" is positioned to the right of "RES".

ON (default)

Main Dial Auto TS

Sets the auto tuning step function so that when rotating [DIAL] rapidly, the tuning step rate adapts as selected.

Set to HI (Fastest) or Lo (Faster) tuning speed, or to oF (OFF).

HI : Approximately 5 times faster when the tuning step is set to 1 kHz or smaller steps; approximately 2 times faster when the tuning step is set to 5 kHz or larger steps.

Lo : Approximately 2 times faster

oF : Auto tuning step is turned OFF.

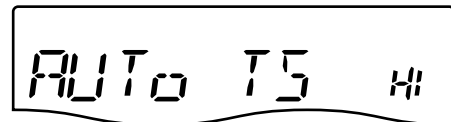
The LCD display shows the text "AUTO TS HI" in a digital font. The "HI" is positioned to the right of "TS".

High (default)

Dial ¼

Turn the ¼-speed tuning function ON or OFF in the CW, RTTY and SSB data modes.

on : The ¼-speed tuning function is ON for critical tuning. While operating in the CW/RTTY/SSB data mode, the dial sensitivity is reduced to ¼ of normal.

oF : The ¼-speed tuning function is OFF.

The LCD display shows the text "DIAL 1/4 oF" in a digital font. The "1/4" is positioned between "DIAL" and "oF".

OFF (default)

/// **NOTE:** This function is only usable when the Quick tuning function is OFF (p. 3-7).

Mic Up/Down Speed

Sets the rate at which frequencies are scanned when the microphone [UP]/[DN] keys are used.

HI: High speed (50 tuning steps/second)

Lo: Low speed (25 tuning steps/second)

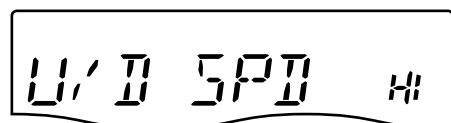
The LCD display shows the text "U/D SPD HI" in a digital font. The "HI" is positioned to the right of "SPD".

High (default)

10 SET MODE

■ Items in the Set mode (Continued)

SSB/CW Synchronous Tuning

Turns the displayed frequency shift function ON or OFF.

When this function is set to ON, the received signal will remain the same even when the operating mode is changed between SSB and CW.

The amount of frequency shift will change according to the CW tone pitch setting.

on : The displayed frequency shifts when the operating mode is changed between SSB and CW.

oF : The displayed frequency does not shift.

The LCD display shows the text "SYNC TUN oF" in a digital font. The characters are arranged in a single line, with "oF" at the far right.

OFF (default)

CW Normal Side

Select the **carrier** point of the CW mode between LSB and USB.

L (LSB) : LSB is the normal mode.

U (USB) : USB is the normal mode.

The LCD display shows the text "CW NORM L" in a digital font. The characters are arranged in a single line, with "L" at the far right.

LSB (default)

Break-In

Selects the CW break-in type.

Full break-in (QSK) activates the receiver between transmitted dots and dashes. This is useful when operating contests, when "fast responses" are common.

Semi break-in keeps the receiver quiet between dots and dashes, and automatically returns to receive after a pre-set time after you stop keying.

When break-in is turned off, the key or paddle can generate side tones, selectable in the Quick Set mode, but will not transmit.

oF : No break-in operation

SE (Semi) : Semi break-in operation

FL (Full) : Full break-in operation

The LCD display shows the text "BK -- IN oF" in a digital font. The characters are arranged in a single line, with "oF" at the far right.

OFF (default)

Break-In Delay

Adjusts break-in delay time for CW semi break-in operation between 0.2 and 13.0 (dots), in 0.1 (dot) steps.

The LCD display shows the text "BK -- DELAY 75" in a digital font. The characters are arranged in a single line, with "75" at the far right.

7.5 dots (default)

10 SET MODE

■ Items in the Set mode (Continued)

Dot/Dash Ratio

Sets the internal electronic keyer dot/dash ratio between 1:1:2.8 and 1:1:4.5, in 0.1 unit steps.

Keying weight example: Morse code "K"

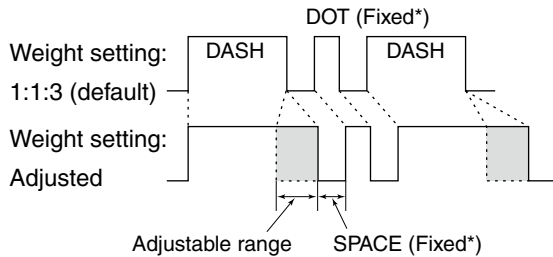

*SPACE and DOT length can be adjusted only with the "Key speed" in the Quick Set mode.

KEY RAT 30

1:1:3.0 (default)

Paddle Polarity

Sets the paddle polarity.

n : Normal polarity
r : Reverse polarity

KEY Pol n

Normal (default)

Keyer Type

Selects the keyer type for the [KEY] connector on the rear panel.

EL : The internal electronic keyer is selected.
bG : The internal electronic keyer is set for a BUG key.
St : The internal electronic keyer is turned OFF, and a straight key or external electronic keyer can be used.

KEY TYPE EL

ELEC-KEY (default)

Mic Up/Down Keyer

Sets the microphone [UP]/[DN] switches to be used as a paddle.

on : [UP]/[DN] switches can be used as a paddle for CW mode operation.
oF : [UP]/[DN] switches cannot be used as a paddle for CW mode operation.

U/D KEY oF

OFF (default)

NOTE: When "ON" is selected, the frequency and memory channel cannot be changed using the [UP]/[DN] switches.

See page 2-3 for the CW paddle connection to the MIC connector.

10 SET MODE

■ Items in the Set mode (Continued)

Mode Select (SSB)

Disables the selection of the SSB (LSB/USB) modes, to simplify operation.

For example, if you are operating mobile and plan on using only the AM mode, set all other modes (SSB, CW, RTTY) to OFF, thereby making selection of AM quick and easy.

on : The SSB modes are selectable.

oF : The SSB modes are disabled.

The LCD display shows the text 'MODE SSB on' in a digital font. The 'on' is smaller than the other text.

ON (default)

Mode Select (CW)

Disables the selection of the CW/CW-R modes, to simplify operation.

on : The CW modes are selectable.

oF : The CW modes are disabled.

The LCD display shows the text 'MODE CW on' in a digital font. The 'on' is smaller than the other text.

ON (default)

Mode Select (RTTY)

Disables the selection of the RTTY/RTTY-R modes, to simplify operation.

on : The RTTY modes are selectable.

oF : The RTTY modes are disabled.

The LCD display shows the text 'MODE RTY on' in a digital font. The 'on' is smaller than the other text.

ON (default)

Mode Select (AM)

Disables the selection of the AM mode, to simplify operation.

on : The AM mode is selectable.

oF : The AM mode is disabled.

The LCD display shows the text 'MODE AM on' in a digital font. The 'on' is smaller than the other text.

ON (default)

CI-V Baud Rate

Sets the **CI-V** data transfer rate to 300, 1200, 4800, 9600, 19200 bps or Auto.

When Auto is selected, the baud rate is automatically set according to the controller or remote controller.

The LCD display shows the text 'CI-V BAUD At' in a digital font. The 'At' is smaller than the other text.

Auto (default)

CI-V Address

To distinguish equipment, each CI-V transceiver has its own Icom standard address in hexadecimal code.

The IC-7200's address is 76h.

When 2 or more IC-7200s are connected to an optional CT-17 CI-V LEVEL CONVERTER, rotate [DIAL] to select a different address for each IC-7200 in the range 01h to 7Fh.

76: Set address to 76h

The LCD display shows the text 'CI-V ADDR 76' in a digital font. The '76' is smaller than the other text.

76h (default)

10 SET MODE

■ Items in the Set mode (Continued)

CI-V Transceive

“Transceive” operation is possible with the IC-7200 connected to other Icom HF transceivers or receivers through a CT-17.

When “ON” is selected, changing the frequency, operating mode, and so on, on the IC-7200, automatically changes those of the other transceivers or receivers, and vice versa.

on : Transceive is ON.

oF : Transceive is OFF.

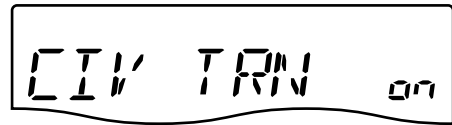

ON (default)

Reference Frequency Adjustment

Adjusts the internal reference signal frequency between 0% and 100%, in 1% steps, during frequency calibration.

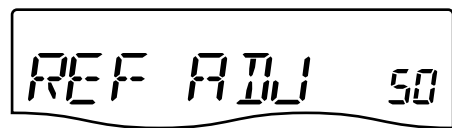

NOTE: Default setting is different for each transceiver.

◇ Connect a paddle to the [MIC] connector

Connect a CW paddle as shown to the right to operate an electronic keyer from the [MIC] connector.

- Be sure to set the “Paddle Polarity,” “Keyer Type” and “Mic Up/Down Keyer” in the Set mode. (p. 10-15)
- Connect a straight key to the “DOT” side.
- Push both “DOT” and “DASH” to turn ON the squeeze operation.

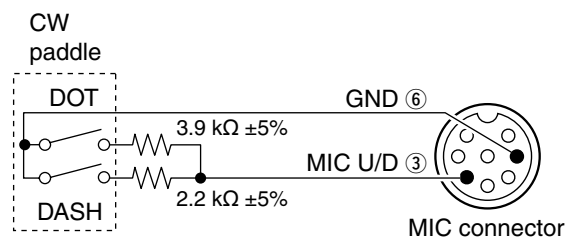

- Controlling the radio with CI-V..... 11-2
 - ◇ CI-V connection example..... 11-2
 - ◇ Data format 11-2
 - ◇ Command table 11-3
 - ◇ Band stacking register 11-5
 - ◇ Data mode with filter width setting 11-5
 - ◇ Memory content setting 11-6

■ Controlling the radio with CI-V

◇ CI-V connection example

The transceiver can be connected through an optional CT-17 CI-V LEVEL CONVERTER to a personal computer equipped with an RS-232C port. The Icom Communication interface-V (CI-V) controls the following functions of the transceiver.

Up to four Icom CI-V transceivers or receivers can be connected to a personal computer equipped with an RS-232C port. See page 10-16, 10-17 to set the CI-V option in the Set mode.

◇ Data format

The CI-V system can be operated using the following data formats. Data formats differ according to command numbers. A data area is added for some commands.

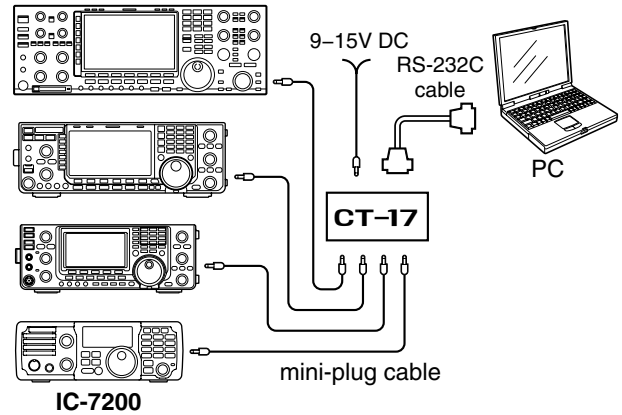

CONTROLLER TO IC-7200

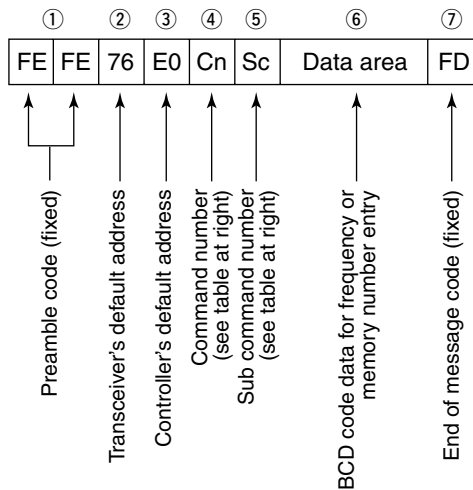

OK MESSAGE TO CONTROLLER

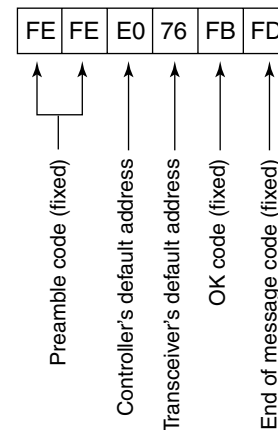

IC-7200 TO CONTROLLER

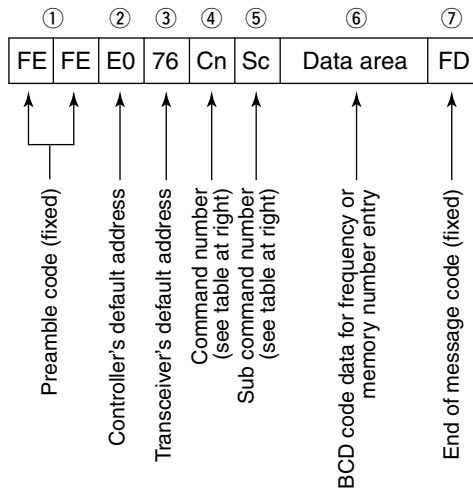

NG MESSAGE TO CONTROLLER

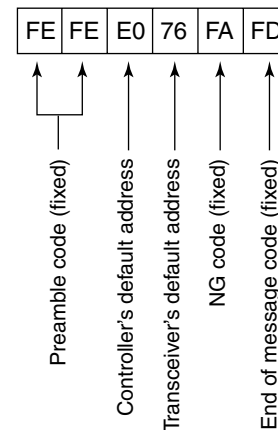

11 CONTROL COMMAND

■ Controlling the radio with CI-V (Continued)

◇ Command table

Cmd.	Sub cmd.	Data	Description
00	—	—	Send frequency data. (for transceiver operation)
01	00	—	Select LSB mode (for transceiver operation)
	01	—	Select USB mode (for transceiver operation)
	02	—	Select AM mode (for transceiver operation)
	03	—	Select CW mode (for transceiver operation)
	04	—	Select RTTY mode (for transceiver operation)
	07	—	Select CW-R mode (for transceiver operation)
	08	—	Select RTTY-R mode (for transceiver operation)
02	—	—	Read band edge frequencies
03	—	—	Read operating frequency
04	—	—	Read operating mode
05	—	—	Set operating frequency
06	00	—	Select LSB mode
	01	—	Select USB mode
	02	—	Select AM mode
	03	—	Select CW mode
	04	—	Select RTTY mode
	07	—	Select CW-R mode
	08	—	Select RTTY-R mode
07	—	—	Select VFO mode
	00	—	Select VFO A
	01	—	Select VFO B
	A0	—	Equalize VFO A and VFO B
B0	—	Exchange VFO A and VFO B	
08	—	—	Select memory mode
	0001–0201*	—	Select memory channel *P1=0200, P2=0201
09	—	—	Memory write
0A	—	—	Memory to VFO
0B	—	—	Memory clear
0E	00	—	Scan stop
	01	—	Programmed/memory scan start
	02	—	Programmed scan start
	22	—	Memory scan start
	D0	—	Set scan resume OFF
	D3	—	Set scan resume ON
0F	00	—	Turn the split function OFF
	01	—	Turn the split function ON
10	00	—	Select 10 Hz (or 1 Hz) tuning steps
	01	—	Select 100 Hz tuning steps
	02	—	Select 1 kHz tuning step
	03	—	Select 5 kHz tuning steps
	04	—	Select 9 kHz tuning steps
	05	—	Select 10 kHz tuning steps
11	—	0	Send/read attenuator OFF.
	—	20	Send/read attenuator ON (20 dB).
13	00	—	Announce with voice synthesizer
	01	—	(00=all data 01=frequency and S-meter; 02=receive mode)
	02	—	

Cmd.	Sub cmd.	Data	Description
14	01	0 to 255	Send/read [AF] level setting (0=max. CCW to 255=max. CW)
	02	0 to 255	Send/read [RF] level setting (0=max. CCW to 255=11 o'clock)
	03	0 to 255	Send/read [SQL] level setting (0=11 o'clock to 255=max. CW)
	06	0 to 255	Send/read NR level setting (0=0% to 255=100%)
	07	0 to 255	Send/read Inside [PBT] setting (0= max. CCW, 128=center, 255=max. CW)
	08	0 to 255	Send/read Outside [PBT] setting (0= max. CCW, 128=center, 255=max. CW)
	09	0 to 255	Send/read CW Tone Pitch setting (0=300 Hz to 255=900 Hz (5 Hz steps))
	0A	0 to 255	Send/read RF power setting (0=minimum to 255=100%)
	0B	0 to 255	Send/read MIC gain setting (0=0% to 255=100%)
	0C	0 to 255	Send/read Key speed level setting (0=6 wpm to 255=60 wpm)
	0D	0 to 255	Send/read [MNF] setting (0=max. CCW, 128=center, 255=max. CW)
	0E	0 to 255	Send/read COMP level setting (0=0 to 255=10)
	0F	0 to 255	Send/read Break-IN delay setting (0=2.0 d to 255=13.0 dots)
	12	0 to 255	Send/read NB level setting (0=0% to 255=100%)
	16	0 to 255	Send/read VOX gain setting (0=0% to 255=100%)
	17	0 to 255	Send/read Anti VOX gain setting (0=0% to 255=100%)
	15	01	—
02		—	Read S-meter level
11		—	Read RF power meter
12		—	Read SWR meter
13		—	Read ALC meter
16	02	0	Send/read Preamp OFF
	1	1	Send/read Preamp ON
	12	0	Send/read AGC OFF
	1	1	Send/read AGC Fast
	2	1	Send/read AGC Slow
	22	0	Send/read Noise Blanker OFF
	1	1	Send/read Noise Blanker ON
	40	0	Send/read Noise Reduction OFF
	1	1	Send/read Noise Reduction ON
	41	0	Send/read Auto Notch function OFF
	1	1	Send/read Auto Notch function ON
	44	0	Send/read Speech compressor OFF
	1	1	Send/read Speech compressor ON
	46	0	Send/read VOX function OFF
	1	1	Send/read VOX function ON
47	0	Send/read Break-IN function OFF	
1	1	Send/read Semi Break-IN function ON	
2	1	Send/read Full Break-IN function ON	
48	0	Send/read Manual Notch function OFF	
1	1	Send/read Manual Notch function ON	
4F	0	Send/read Twin Peak Filter OFF	
1	1	Send/read Twin Peak Filter ON	
50	0	Send/read Dial lock function OFF	
1	1	Send/read Dial lock function ON	
19	00	—	Read the transceiver ID
1A	00	See p. 11-6	Send/read memory contents
	01	See p. 11-5	Send/read band stacking register contents

11 CONTROL COMMAND

■ Controlling the radio with CI-V

◇ Command table (Continued)

Cmd.	Sub cmd.	Data	Description
1A	02	0 to 40	Send/read the selected filter width (SSB, CW, RTTY: 0=50 Hz to 40/31=3600/2700 Hz; AM: 0=200 Hz to 39=8 kHz)
		0301	0 to 255
	0302	0 to 255	Send/read MIC gain setting (0=0% to 255=100%)
	0303	0 to 255	Send/read Key speed level setting (0=6 wpm to 255=60 wpm)
	0304	0 to 120	Send/read CW Tone Pitch setting (0=300 Hz to 120=900 Hz; 5 Hz steps)
	0305	0 to 255	Send/read CW side tone setting (0=0% to 255=100%)
	0306	0	Send/read CW side tone level limit OFF
		1	Send/read CW side tone level limit ON
	0307	0	Send/read Twin Peak filter OFF
		1	Send/read Twin Peak filter ON
	0308	0	Send/read RTTY mark frequency 1275 Hz
		1	Send/read RTTY mark frequency 1615 Hz
		2	Send/read RTTY mark frequency 2125 Hz
	0309	0	Send/read RTTY shift width 170 Hz
		1	Send/read RTTY shift width 200 Hz
		2	Send/read RTTY shift width 425 Hz
		3	Send/read RTTY shift width 850 Hz
	0310	0	Send/read RTTY keying polarity Normal
		1	Send/read RTTY keying polarity Reverse
	0311	0	Send/read LCD brightness OFF
		1	Send/read LCD brightness Dark
		2	Send/read LCD brightness Bright
	0312	0	Send/read confirmation beep OFF
		1	Send/read confirmation beep ON
	0313	0	Send/read Band edge beep OFF
		1	Send/read Band edge beep ON
	0314	0 to 255	Send/read beep gain (0=0% to 255=100%)
		0	Send/read Beep gain limit OFF
	0315	1	Send/read Beep gain limit ON
		0316	0
	0316	1	Send/read SQL selection for [RF/SQL]
		2	Send/read RF+SQL selection for [RF/SQL]
	0317	0	Send/read Meter peak hold function OFF
		1	Send/read Meter peak hold function ON
	0318	0	Send/read Quick Split function OFF
		1	Send/read Quick Split function ON
	0319	0	Send/read Split Lock function OFF
		1	Send/read Split Lock function ON
	0320	0	Send/read transmit frequency monitor function with [RIT] key OFF
		1	Send/read transmit frequency monitor function with [RIT] key ON
	0321	0	Send/read Tuner Auto Start OFF
		1	Send/read Tuner Auto Start ON
0322	0	Send/read PTT Tune Start OFF	
	1	Send/read PTT Tune Start ON	

Cmd.	Sub cmd.	Data	Description
1A	0323	0	Send/read MIC selection for MOD input connector during DATA OFF
		1	Send/read ACC selection for MOD input connector during DATA OFF
		2	Send/read MIC+ACC selection for MOD input connector during DATA OFF
	0324	3	Send/read USB selection for MOD input connector during DATA OFF
		0	Send/read MIC selection for MOD input connector during DATA ON
		1	Send/read ACC selection for MOD input connector during DATA ON
	0325	2	Send/read MIC+ACC selection for MOD input connector during DATA ON
		3	Send/read USB selection for MOD input connector during DATA ON
		0326	0 to 255
	0327	0 to 255	Send/read speech level (0=0% to 255=100%)
		0	Send/read speech language English
	0328	1	Send/read speech language Japanese
		0	Send/read speech speed Slow
	0329	1	Send/read speech speed Fast
		0	Send/read S-level speech function OFF
	0330	1	Send/read S-level speech function ON
		0	Send/read speech capability with [MODE] key operation OFF
	0331	1	Send/read speech capability with [MODE] key operation ON
		0	Send/read Scan speed Slow
	0332	1	Send/read Scan speed Fast
		0	Send/read Scan Resume function OFF
	0333	1	Send/read Scan Resume function ON
		0	Send/read Main Dial Auto TS function OFF
	0334	1	Send/read Main Dial Auto TS Low
		2	Send/read Main Dial Auto TS High
	0335	0	Send/read 1/4 dial speed function OFF
		1	Send/read 1/4 dial speed function ON
	0336	0	Send/read mic. UP/DOWN speed Low
		1	Send/read mic. UP/DOWN speed High
	0337	0	Send/read SSB/CW synchronous tuning function OFF
		1	Send/read SSB/CW synchronous tuning function ON
	0338	0	Send/read LSB selection for the CW carrier point
		1	Send/read USB selection for the CW carrier point
	0339	0	Send/read Break-IN function OFF
		1	Send/read Semi Break-IN function ON
		2	Send/read Full Break-IN function ON
	0340	20 to 130	Send/read break-in delay time set (20=2.0 d to 130=13.0 dots)
		28 to 45	Send/read CW keyer dot/dash ratio (28=1:1:2.8 to 45=1:1:4.5)
	0341	0	Send/read CW paddle polarity Normal
		1	Send/read CW paddle polarity Reverse
	0342	0	Send/read CW keyer type Straight
		1	Send/read CW keyer type Bug-key
2		Send/read CW keyer type ELEC Key	

11 CONTROL COMMAND

■ Controlling the radio with CI-V

◇ Command table (Continued)

Cmd.	Sub cmd.	Data	Description
1A	0343	0	Send/read MIC UP/DOWN keyer (HM-36) OFF
		1	Send/read MIC UP/DOWN keyer (HM-36) ON
	0344	0	Send/read SSB mode selection OFF (inhibition)
		1	Send/read SSB mode selection ON (selectable)
	0345	0	Send/read CW mode selection OFF (inhibition)
		1	Send/read CW mode selection ON (selectable)
	0346	0	Send/read RTTY mode selection OFF (inhibition)
		1	Send/read RTTY mode selection ON (selectable)
	0347	0	Send/read AM mode selection OFF (inhibition)
		1	Send/read AM mode selection ON (selectable)
	0348	0	Send/read CI-V transceive function OFF
		1	Send/read CI-V transceive function ON
	0349	0 to 255	Send/read reference frequency set (0=0% to 255=100%)
	0350	0 to 255	Send/read noise blanker level set (0=0% to 255=100%)
	0351	0 to 255	Send/read noise blanker width set (0=0% to 255=100%)
	0352	0 to 15	Send/read NR level set (0=0 to 15=15)
	0353	0 to 255	Send/read VOX gain set (0=0% to 255=100%)
	0354	0 to 255	Send/read Anti-VOX gain set (0=0%, 255=100%)
	0355	0 to 20	Send/read VOX delay set (0=0.0 sec. to 20=2.0 sec.)
	0356	0 to 10	Send/read speech compressor level (0=0 to 10=10)
	04	—	Send/read DATA mode with filter set (see to the right for detail)
	05	0	Send/read Sharp selection for DSP filter shape
		1	Send/read Soft selection for DSP filter shape
	06	0	Send/read manual notch width Wide
		1	Send/read manual notch width Mid
		2	Send/read manual notch width Narrow
1C	00	0	Send/read the transceiver's status RX
		1	Send/read the transceiver's status TX
	01	0	Antenna tuner OFF (through)
		1	Send/read Antenna tuner ON
		2	Send/read Manual tuning selection

◇ Band stacking register

Command: 1A 01

To send or read the desired **band** stacking register's contents, a combination of the frequency band and the register codes ("01" is fixed as the register code) as follows are used.

For example, when sending/reading the contents in the 21 MHz band, the code "0701" is used.

• Frequency band codes

CODE	BAND	FREQUENCY RANGE
01	1.8 MHz	1.800000 – 1.999999
02	3.5 MHz	3.400000 – 4.099999
03	7 MHz	6.900000 – 7.499999
04	10 MHz	9.900000 – 10.499999
05	14 MHz	13.900000 – 14.499999
06	18 MHz	17.900000 – 18.499999
07	21 MHz	20.900000 – 21.499999
08	24 MHz	24.400000 – 25.099999
09	28 MHz	28.000000 – 29.999999
10	50 MHz	50.000000 – 54.000000
11	General	Other than above

◇ Data mode with filter width setting

Command: 1A 04

The following data sequence is used when sending or reading the data mode with filter width setting.

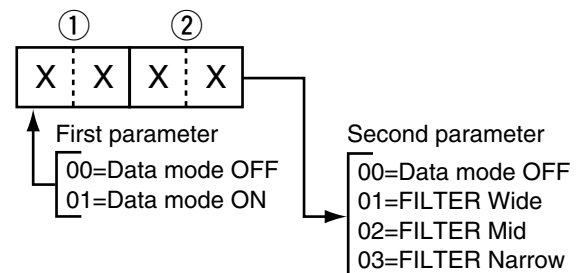

11 CONTROL COMMAND

◇ Memory content setting

Command: 1A 00

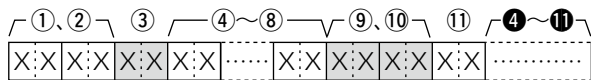

①, ② Memory channel number

- 0001–0199 : Memory channel 1 to 199
- 0200 : Programmed **scan edge** P1
- 0201 : Programmed scan edge P2

③ Split setting

- 00: **Split** OFF
- 10: Split ON

When the program channel is selected, both settings should be “00.”

④–⑧ Operating frequency setting

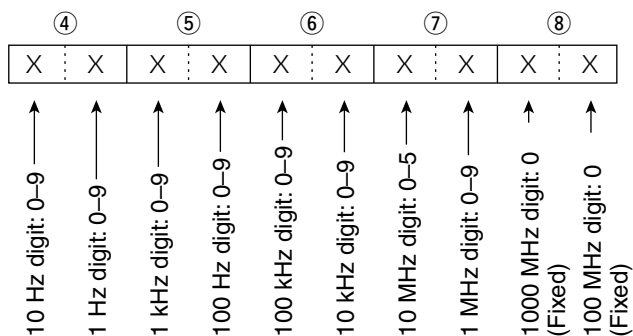

⑨, ⑩ Operating mode setting

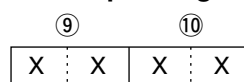

⑨ Operating mode		⑩ Filter setting	
00: LSB	03: CW	08: RTTY-R	01: Wide
01: USB	04: RTTY		02: Mid
02: AM	07: CW-R		03: Narrow

⑪ Data mode setting

- 1 byte data (XX)
- 00: Data mode OFF
- 10: Data mode ON

NOTE:

- The same data as ④–⑪ are stored in ④–⑪.
- When the Split function is ON, the data of ④–⑪ is used for transmit.
- Even if the Split function is OFF, enter the data into ④–⑪ to match your transceiver. We recommend that you set the same data as ④–⑪.

INFORMATION **Section 12**

■ Band voltage modification 12-2

■ Band voltage modification

If you want to connect an external unit that can be controlled by the band voltage from the [ACC] connector, the modification is shown to the right.

The band voltage is on pin 5 of [ACC] connector after modification (①) is completed, or the regulated 8 V is on pin 1 of [ACC] connector after modification (②) is completed.

Performing this modification is the customer's responsibility. Icom does not guarantee this modification's result.

CAUTION: Disconnect the DC power cable from the transceiver before working on the transceiver.

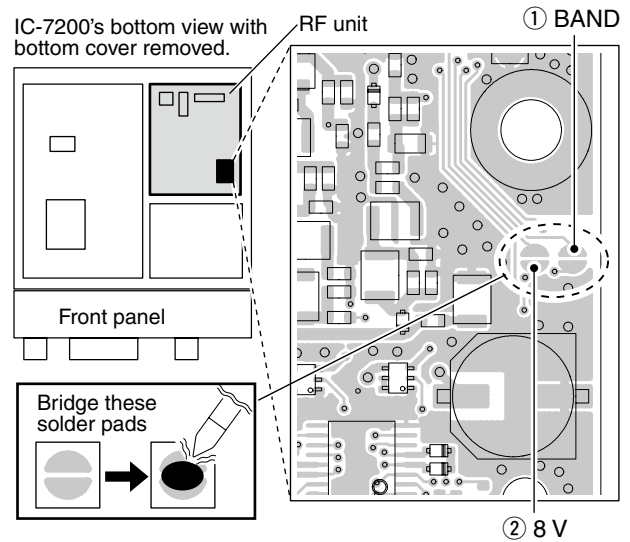

• Band voltage generator circuit

The circuit below is just for reference.

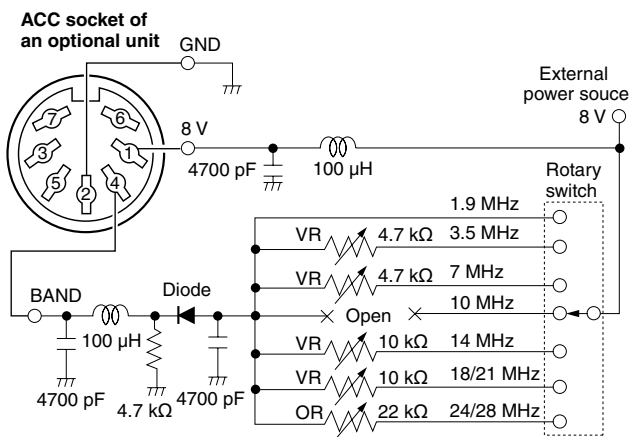

The following band voltage table is for reference only. Please adjust and check with the actual operating results.

BAND	VOLTAGE
1.9 MHz	Non-adjustment
3.5 MHz	6.1 V
7 MHz	5.1 V
10 MHz	Non-adjustment
14 MHz	4.1 V
18/21 MHz	3.1 V
24/28 MHz	2.1 V

INDEX

A

AM mode operation	4-14
Convenient functions for receiving	4-14
Convenient functions for transmit	4-15
Antenna tuner	
AH-4 AUTOMATIC ANTENNA TUNER	9-4
AT-180 AUTOMATIC ANTENNA TUNER	9-2
Auto Tune	10-11
PTT Tune	10-11
Setting the internal switches	9-3
Automatic tuning	9-2
Manual tuning	9-2
ACC socket information	1-16
Audio	
Modulation input (Data OFF)	10-11
Modulation input (Data ON)	10-11
Volume adjusting	3-11
AGC function	5-3
Time constant selection	5-3
Attenuator	5-3

B

Band	
Operating band selection	3-4
Band stacking register	3-4
Backlight	
LCD Backlight	10-9
Beep	10-9
Band Edge Beep	3-10, 10-9
Beep Level	10-9
Beep Level Limit	10-9
Break-in	
Type	10-14
Delay time	10-14
Full break-in operation	6-5
Semi break-in operation	6-4

C

CI-V	
Address	10-16
Band stacking register	11-5
Baud Rate	10-16
Connection example	11-2
Command table	11-3
Controlling the radio	11-2
Data mode with filter width setting	11-5
Data format	11-2
Memory content setting	11-6
Transceive	10-17
Connections	
Antenna connections	2-2
Basic connections	2-3
Battery connections	2-6
CW keyer connections	2-8
DC Power Supply connections	2-5
External antenna tuners connections	2-6
Grounding	2-2
Linear amplifier connections	2-7
Optional connections	2-4
Paddle connection to the [MIC] connector ...	10-17
PC/TNC for RTTY connections	2-9
PC/TNC for SSTV or PSK31 connections	2-10
Power supply connections	2-5
Selecting a location	2-2
Unpacking	2-2
CW mode operation	4-5
Convenient functions for receiving	4-6
Convenient functions for transmit	4-7
CW Normal Side	10-14
CW-R (CW reverse) mode selection	4-8
CW tone pitch	4-8, 10-5
CW side tone level	4-9, 10-5
CW side tone level limit	10-5

D

Data mode	4-16
Data mode Select	10-5
Dial lock	3-12
Dial $\frac{1}{4}$ tuning function	3-9, 10-13
Display	
Function display	1-12
LCD Backlight	10-9

INDEX

F

Frequency	
Operating frequency setting	3-5
Using the keypad	3-6
Using the main dial.....	3-5
5 MHz band operation (USA version only).....	3-10
Front panel	1-2
Keypad.....	1-9
Function display	1-12

I

IF filter	
Selection	5-5
IF filter shape (SSB/CW only)	5-6
Passband filter width	5-6

K

Keyer	
Dot/Dash Ratio	10-15
Key speed	4-9, 10-5
Mic Up/Down Keyer	10-15
Paddle Polarity	10-15
Type	10-15
Keypad	1-9

L

LCD Backlight	10-9
---------------------	------

M

Measuring SWR	6-11
Memory mode	3-3
Memory channels	7-2
Clearing	7-6
Copying	7-5
Programming in memory mode	7-4
Programming in VFO mode	7-3
Selecting	7-2
Meter function	3-13
Meter Peak Hold.....	10-10
Microphones	1-17
Gain	10-4
Mic Up/Down Speed	10-13
HM-36	1-17
SM-30 (Option)	1-17
SM-50 (Option)	1-17
Mode	
Operating mode selection.....	3-11
AM mode operation	4-14
Mode Select (AM)	10-16
CW mode operation	4-5
Mode Select (CW)	10-16
Data mode operation	4-16
Data mode Select	10-5
RTTY (FSK) mode operation	4-10
Mode Select (RTTY)	10-16
SSB mode operation	4-2
Mode Select (SSB)	10-16
Modulation input (Data OFF)	10-11
Modulation input (Data ON)	10-11

N

Noise blanker	
Activating	5-7
Level setting	5-7
Width setting	5-7
Noise reduction function	
Activating	5-8
Level setting	5-8
Notch filters	5-9
Auto notch filter	5-9
Manual notch filter	5-10
Manual notch filter width setting	5-10

INDEX

O

Operating band selection 3-4
 Using the band stacking register 3-4

Operating frequency setting 3-5
 5 MHz band operation (USA version only)..... 3-10
 Using the keypad 3-6
 Using the main dial 3-5

Operating mode selection 3-11
 AM mode operation 4-14
 Mode Select (AM) 10-16

 CW mode operation 4-5
 Mode Select (CW) 10-16

 Data mode operation 4-16
 Data mode Select 10-5

 RTTY (FSK) mode operation 4-10
 Mode Select (RTTY) 10-16

 SSB mode operation 4-2
 Mode Select (SSB)..... 10-16

P

PBT
 Twin PBT operation 5-4

Preamp selection 5-3

R

Rear panel 1-14
 ACC socket information..... 1-16

Reference Frequency Adjustment 10-17

RF/SQL Control 10-10

RF gain adjustment 3-12

RIT function 5-2

RTTY (FSK) mode operation 4-10
 Convenient functions for receiving 4-10
 RTTY decode Set mode 4-13
 RTTY-R (RTTY reverse) mode selection 4-12
 RTTY key polarity 10-6
 RTTY mark tone 10-6
 RTTY shift width 10-6

S

Scan
 Memory scan 8-5
 Preparation 8-2
 Programmed scan 8-4
 Scan edges programming..... 8-3
 Resume 10-13
 Speed 10-13
 Types 8-2

Set Mode 10-2
 Items in the Set mode 10-7
 Items in the Quick Set mode 10-4
 Using the Set mode 10-3
 Using the Quick Set mode 10-2

Speech
 Compressor 6-6
 Compression level 6-7
 Language 10-12
 Level 10-12
 Speech [MODE] Key 10-12
 Speech S-level 10-12
 Speed 10-12

Split frequency operation 6-8
 Quick Split 6-9, 6-10, 10-10
 XFC 6-9, 10-11
 Split Lock 6-11, 10-10

Squelch adjustment 3-12

SSB/CW Synchronous Tuning 10-14

SSB mode operation 4-2
 Convenient functions for receiving 4-2
 Convenient functions for transmit 4-4

SWR
 Measuring SWR 6-11

INDEX

T

Transmitting	3-14
Output power setting	3-14, 10-4
Microphone gain setting	3-14, 10-4
Tuning step	
1 Hz and 10 Hz tuning steps selection	3-8
Auto tuning step selection.....	3-9, 10-13
'kHz' step selection	3-7
Quick tuning function.....	3-7
[TS] switch flow chart.....	3-8
Twin PBT operation	5-4
Twin peak filter	10-6
Selecting the Twin peak filter	4-12

U

USB	
Modulation input (Data OFF)	10-11
Modulation input (Data ON)	10-11
USB Level	10-12

V

VFO mode	3-3
Operation.....	3-2
Equalizing the VFOs	3-2
Selecting	3-3
VFO A/B	3-2
Voice synthesizer function	3-13
VOX function	6-2
VOX Set mode	6-3

Count on us!

