

ICOM

INSTRUCTION MANUAL

144MHz FM TRANSCEIVER

IC-228A

IC-228E

IC-228H



Icom Inc.

FOREWORD

Thank you for purchasing the **IC-228A/E/H 144MHz FM TRANSCEIVER**. The IC-228A/E/H is compact and easy to operate with high output power and the latest technology.

Please read this instruction manual thoroughly before operating the transceiver and feel free to contact your nearest Icom Dealer or Service Center if you require assistance or information regarding the operation of your new transceiver.

UNPACKING

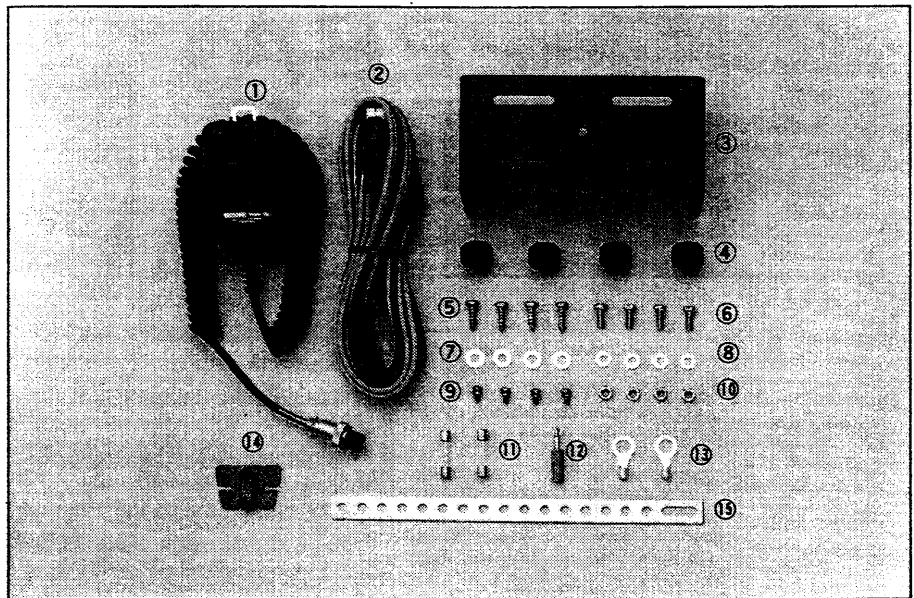

①	Microphone * ¹	1
②	DC cable	1
③	Mounting bracket* ²	1
④	Mounting bracket knobs	4
⑤	Self-tapping screws (A0 5 x 16)	4
⑥	Screws (M5 x 12)	4
⑦	Flat washers (M5)	4
⑧	Flat washers (M4)	4
⑨	Set screws (A) 4 x 8	4
⑩	Nuts (M5)	4
⑪	Fuses (15A)	2
⑫	External speaker plug	1
⑬	Cable lugs	2
⑭	Microphone hanger	1
⑮	Support bracket	1

*¹ HM-14 for IC-228A/H (U.S.A. version)
HM-12 for IC-228A/H (Australia, Asia versions)
HM-15 for IC-228E/H (Europe, Italy versions)

*² Style differs from IC-228A/E.

TABLE OF CONTENTS

1	PRECAUTIONS	1
2	FEATURES	2
3	PANEL DESCRIPTION	3
3-1	FRONT PANEL	3
3-2	FUNCTION DISPLAY	5
3-3	REAR PANEL	6
3-4	MICROPHONE	6
4	INSTALLATION	7
5	MODE CONSTRUCTION	10
6	BASIC OPERATIONS	11
6-1	FREQUENCY SETTING	11
6-2	RECEIVING	11
6-3	TRANSMITTING	12
6-4	REPEATER OPERATION	13
7	FUNCTION OPERATIONS	14
7-1	CALL CHANNEL MODE	14
7-2	MEMORY MODE	15
7-3	SCAN FUNCTION	17
7-4	PRIORITY WATCH	20
8	SET MODE	22
8-1	SET MODE CONSTRUCTION	22
8-2	SUBAUDIBLE TONE FREQUENCY	23
8-3	OFFSET FREQUENCY	24
8-4	TUNING STEP	24
8-5	PROGRAMMED SCAN EDGES	25
8-6	BEEP TONE ON/OFF	26
8-7	DIMMER CONTROL	26
9	OPTIONAL TONE SQUELCH UNIT	27
9-1	UT-40 INSTALLATION	27
9-2	POCKET BEEP FUNCTION	28
9-3	TONE SQUELCH FUNCTION	29
10	MAINTENANCE	30
10-1	TROUBLESHOOTING	30
10-2	CPU RESETTING	31
10-3	MISCELLANEOUS MAINTENANCE	32
11	INSIDE VIEWS	33
12	SPECIFICATIONS	35
13	OPTIONS	36
	SCHEMATIC/BLOCK DIAGRAM	SEPARATE

1 PRECAUTIONS

Before using the transceiver, read all instructions carefully and completely.

SAVE THESE INSTRUCTIONS – This instruction manual contains important safety and operating instructions for the IC-228A/E/H.

NEVER connect the transceiver to an AC outlet. This will ruin the transceiver.

NEVER connect more than 16V DC power supplies or batteries to the transceiver. Check the source before connecting the power cable.

NEVER allow children to touch the transceiver during operation.

NEVER use or store the transceiver in places with temperatures below -10°C ($+14^{\circ}\text{F}$) or over $+60^{\circ}\text{C}$ ($+140^{\circ}\text{F}$).

NEVER expose the transceiver to rain, snow or any liquids.

DO NOT place the transceiver in excessively humid environments.

AVOID placing the transceiver in direct sunlight, such as on the dashboard.

AVOID using the transceiver in excessively dusty environments.

BE CAREFUL! The heatsink may become hot when operating the transceiver continuously for long periods.

FEATURES 2

- **COMPACT AND HIGH OUTPUT POWER**

Many conventional functions included in a compact body, and 45W* of powerful output on any frequency in the 2m band. (*IC-228A/E : 25W)

- **SIMPLE PANEL DESIGN**

Front panel layout is extremely simple even with many functions available. Because of the convenient SET mode programs tone, offset, tuning step, scan edge, etc., for a simple design.

- **20 MEMORY CHANNELS PLUS A CALL CHANNEL**

The transceiver is equipped with a total of 20 memory channels and a call channel. Each memory channel can independently memorize an operating frequency and all information required to work a repeater.

- **PROGRAMMED SCAN AND MEMORY SCAN**

Two scans, the Programmed Scan and the Memory Scan, are provided on the transceiver. In addition, the Memory Skip function can be programmed in each memory channel to skip your unnecessary memory channel during Memory Scan.

- **PRIORITY WATCH**

During VFO mode operation, the Priority Watch watches memory channels in sequence, a memory channel or the call channel every 5sec. You can wait for a call from station while in contact with other station.

- **POCKET BEEP FUNCTION**

The convenient Pocket Beep function lets you know with a 30sec. beep and "SQL" flashing on the FUNCTION DISPLAY when subaudible tones identical to your own pre-programmed ones arrive at the transceiver. The Pocket Beep function requires an optional UT-40 TONE SQUELCH UNIT.

- **MONITOR FUNCTION**

The Monitor function opens the squelch (also Tone Squelch when the UT-40 is installed) without rotating the [SQL/MONITOR] CONTROL back and forth at the squelch threshold level. Only you push the control.

3 PANEL DESCRIPTION

3-1 FRONT PANEL

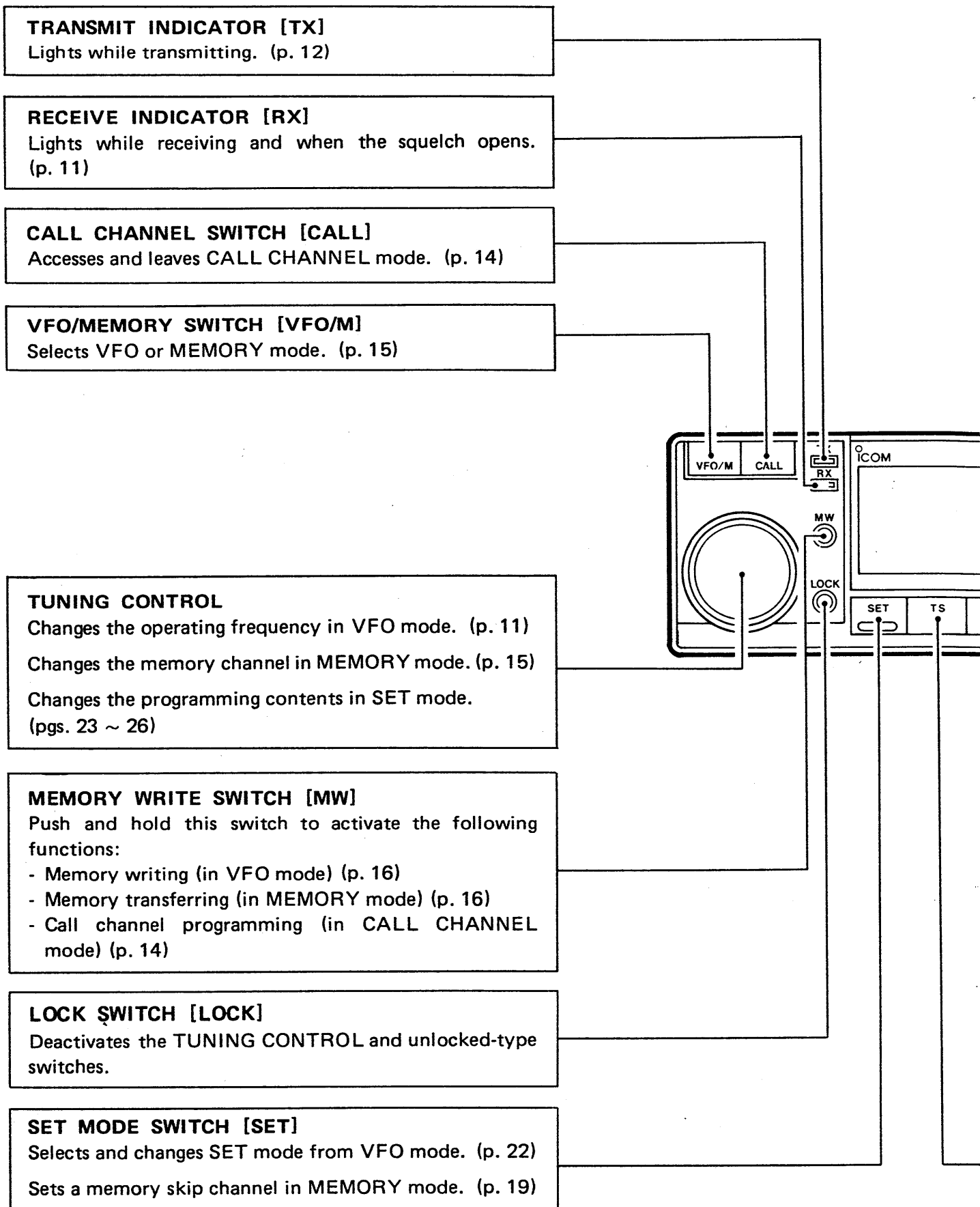

PANEL DESCRIPTION 3

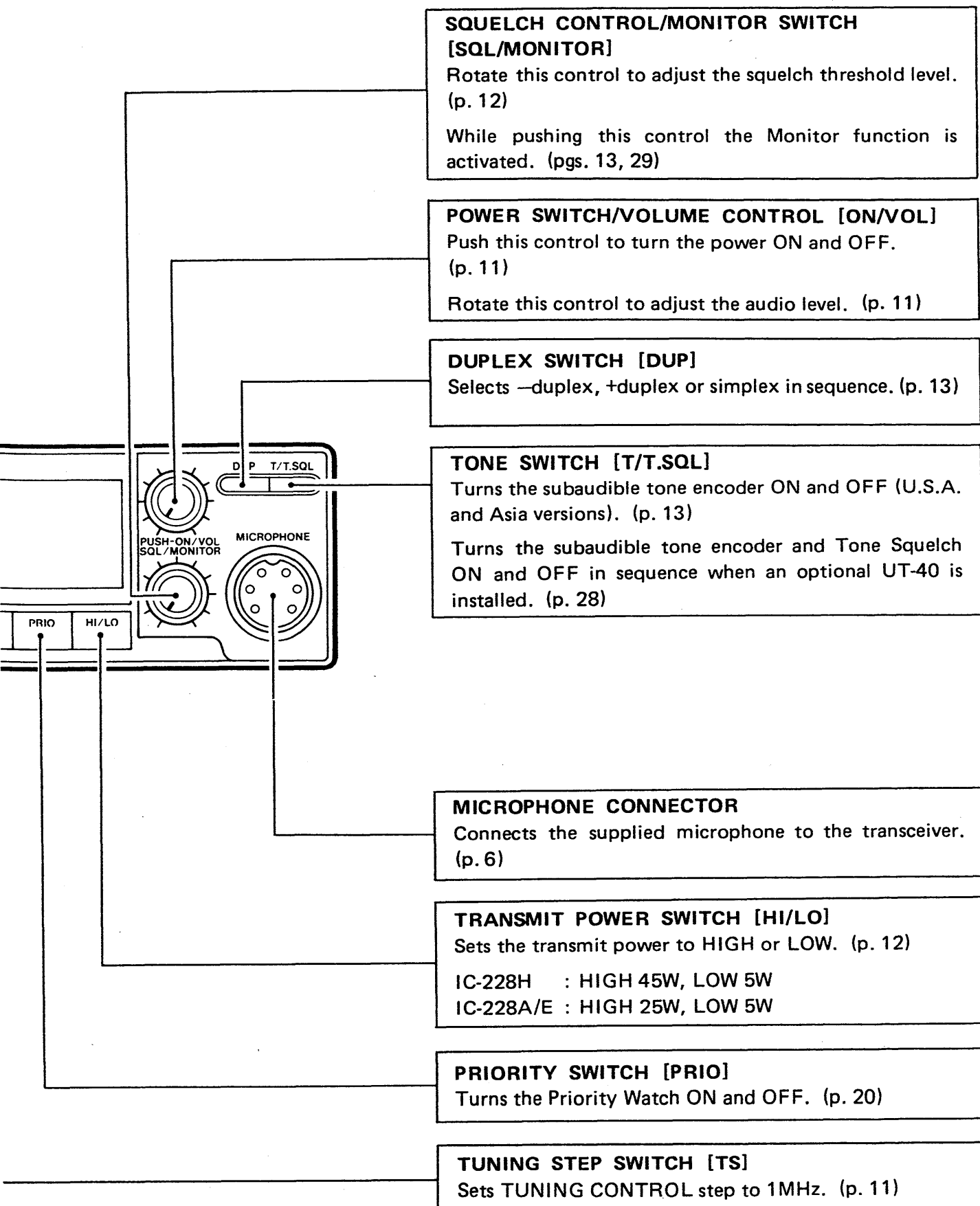

3 PANEL DESCRIPTION

3-2 FUNCTION DISPLAY

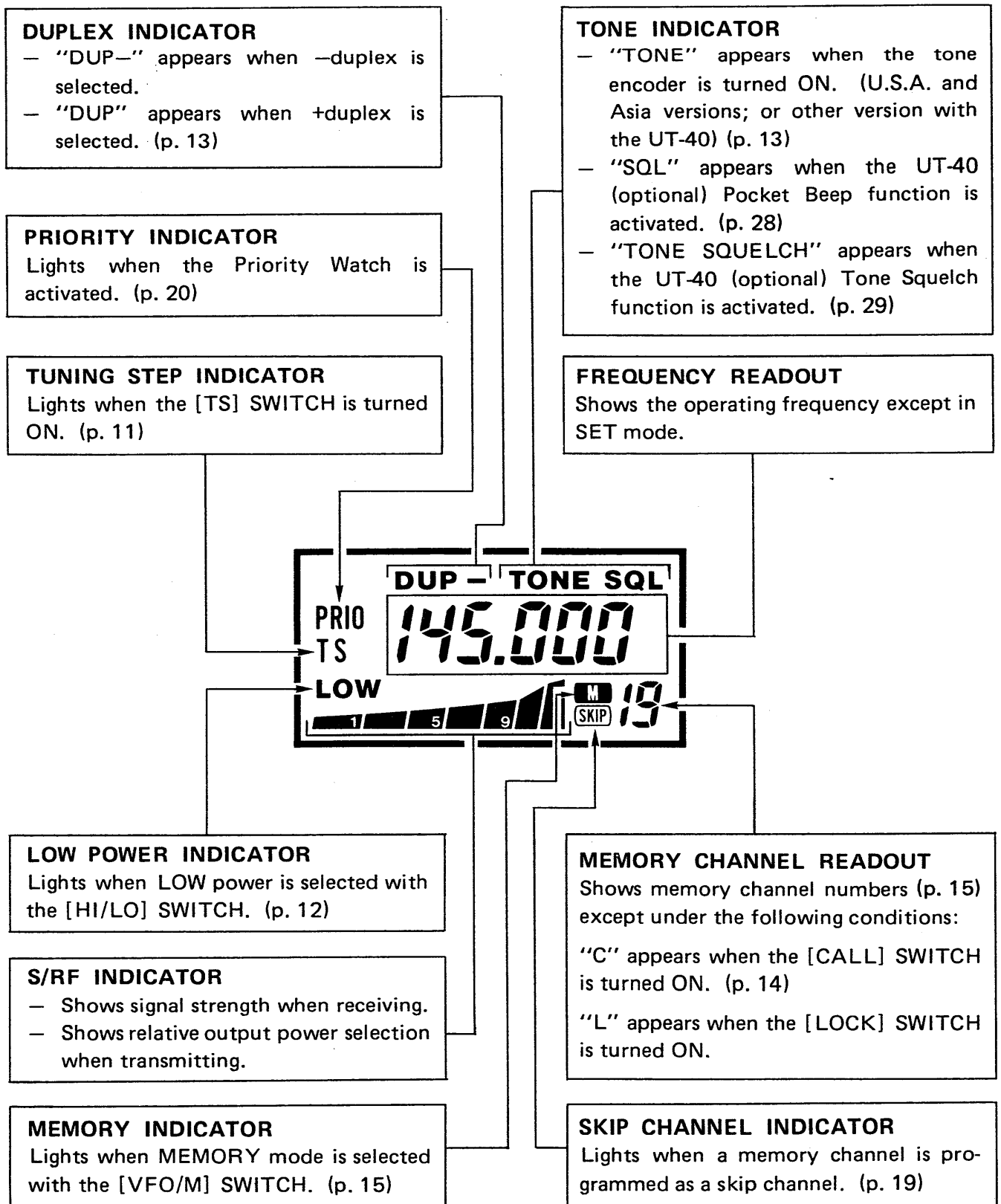

3-3 REAR PANEL

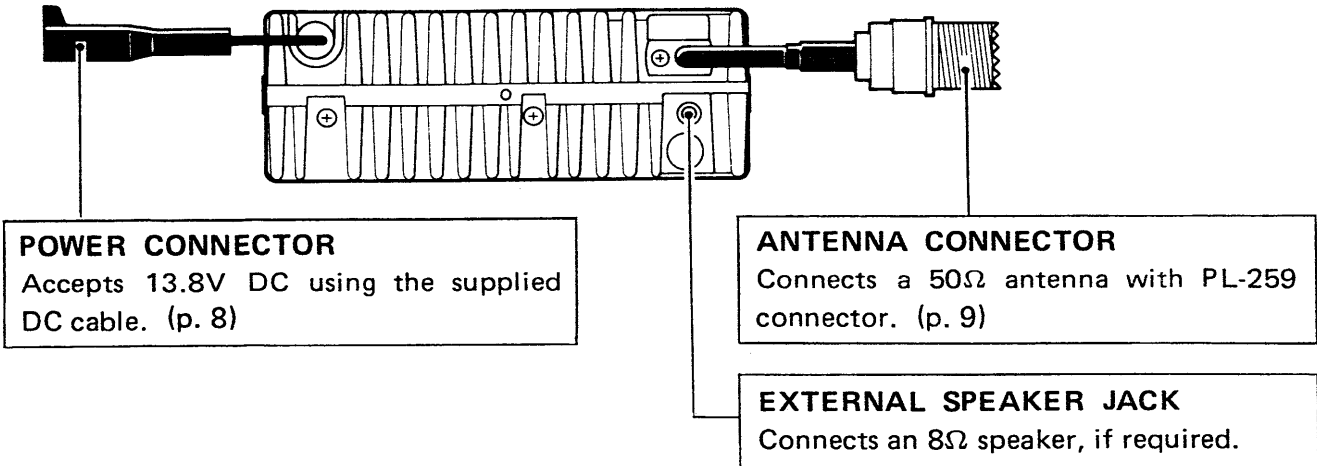

3-4 MICROPHONE

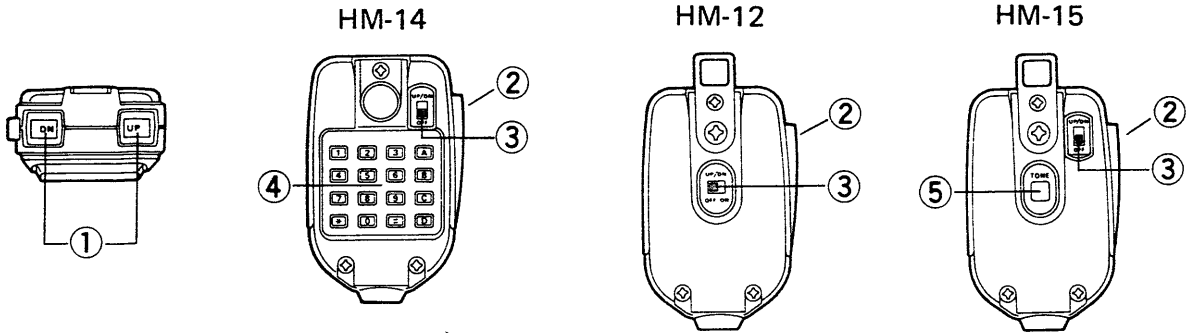

① UP/DOWN SWITCHES
Push either of these switches to change the operating frequency or memory channel.

Push and hold either of these switches to start scanning.

② PTT SWITCH
Push to transmit.

③ UP/DOWN ON/OFF SWITCH
Prevents accidental changes of the [UP] and [DN] SWITCHES.

④ DTMF KEYPAD (HM-14 only)
Produces DTMF signals while transmitting.

⑤ TONE CALL SWITCH (HM-15 only)
Transmits a 1750Hz tone signal.

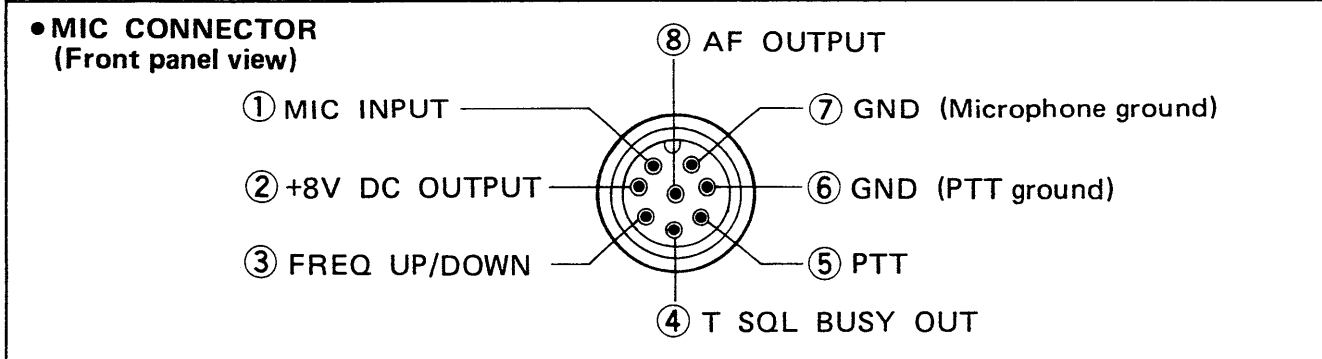

4 INSTALLATION

(1) LOCATION

Select a location for the transceiver that does not interfere with your driving in any way. We recommend the locations shown in the diagrams below.

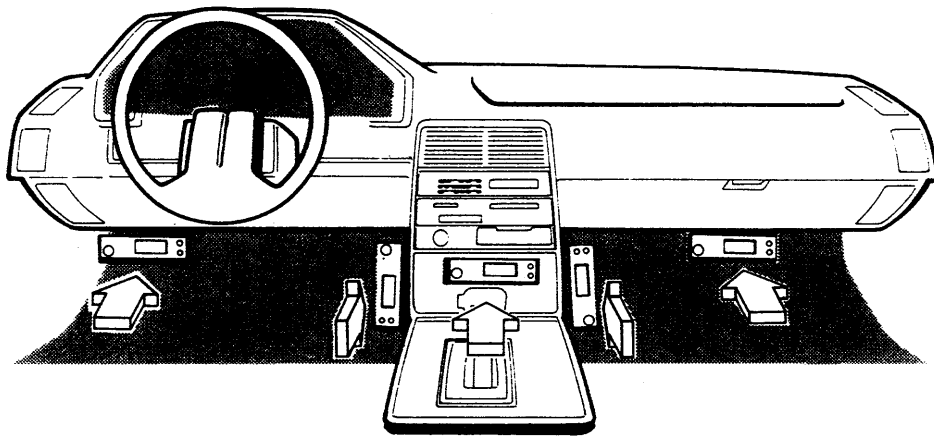

LOCATION

NEVER place the transceiver in direct sunlight.

NOTES:

DO NOT place the transceiver where hot or cold air blows directly on it.

DO NOT place the transceiver where normal operation of the vehicle may be hindered.

(2) MOUNTING

Securely mount the transceiver with the supplied mounting bracket to minimize vibrations.

● MOUNTING THE TRANSCEIVER

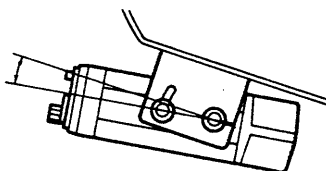
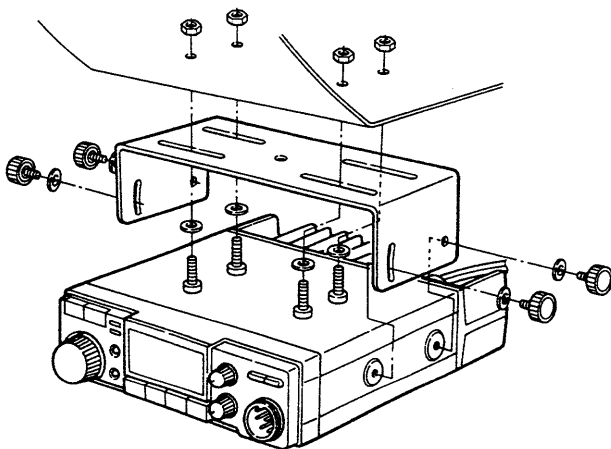

Adjust installation angle for good visibility.

1) Drill four holes where the transceiver will be mounted.

● approx. 5.5 ~ 6mm for using nuts.
approx. 2 ~ 3mm for using self-tapping screws.

2) Tighten the screws using the supplied nuts and washers.

3) If the mounting location is not flat, use the supplied support bracket.

4) Adjust the angle for the clearest view of the FUNCTION DISPLAY.

5) Make sure all screws or nuts are tightened.

(3) BATTERY CONNECTION

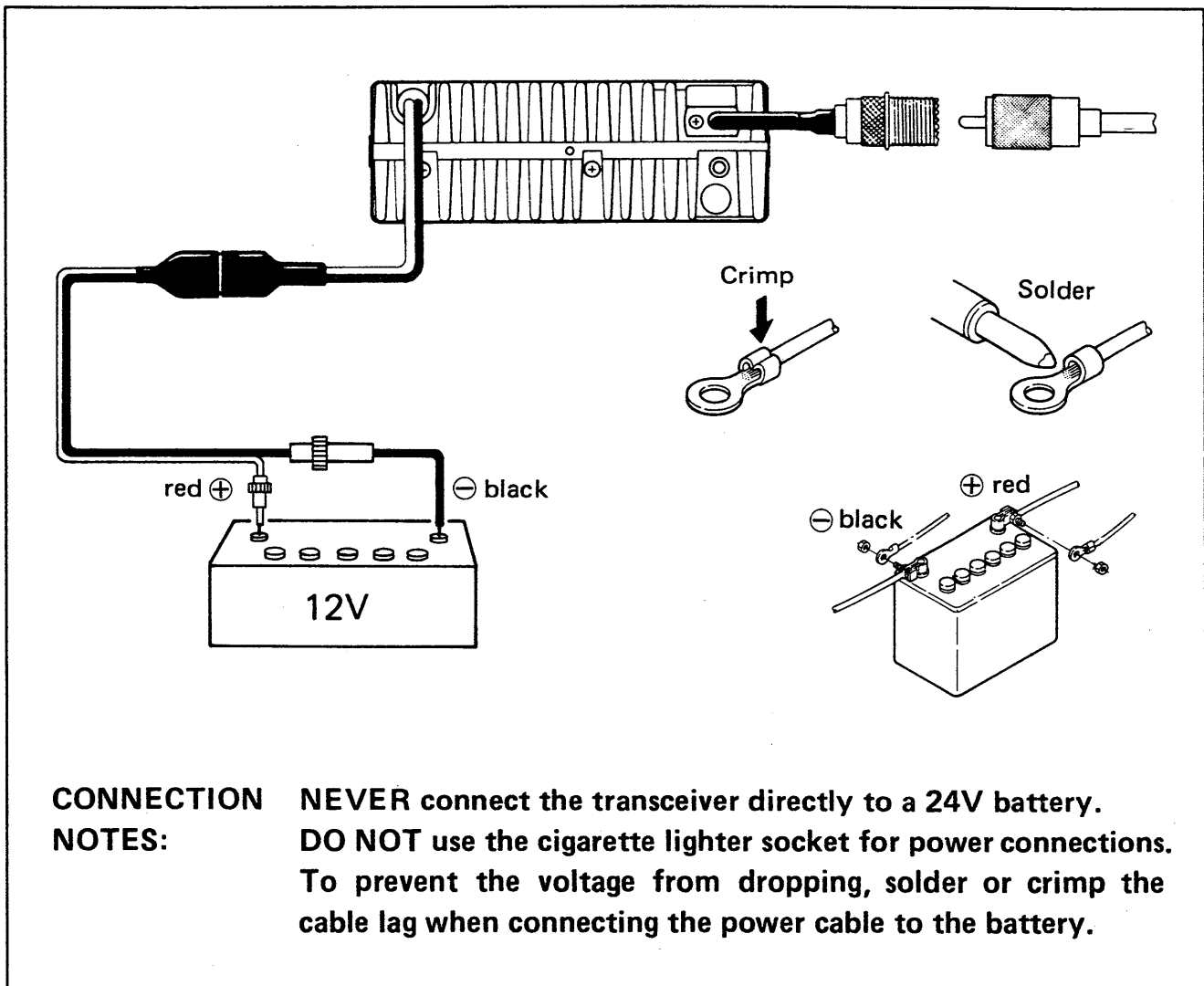

(4) EXTERNAL POWER SUPPLY

Use a 13.8V DC power supply with more than 10A for the IC-228H and more than 7A for the IC-228A/E, if required. The following power supplies are available from Icom. See p. 36 for photos.

IC-PS30 : 25A capacity for the IC-228H

PS-45 : 8A capacity for the IC-228A/E

(OPC-102 cable must be purchased separately.)

When using the transceiver as a base station, be sure a ground terminal of the power supply is grounded. Use the heaviest gauge wire or strap available and make the connection as short as possible.

4 INSTALLATION

(5) ANTENNA LOCATION

To obtain maximum performance from the transceiver, select a high-quality antenna and a good location.

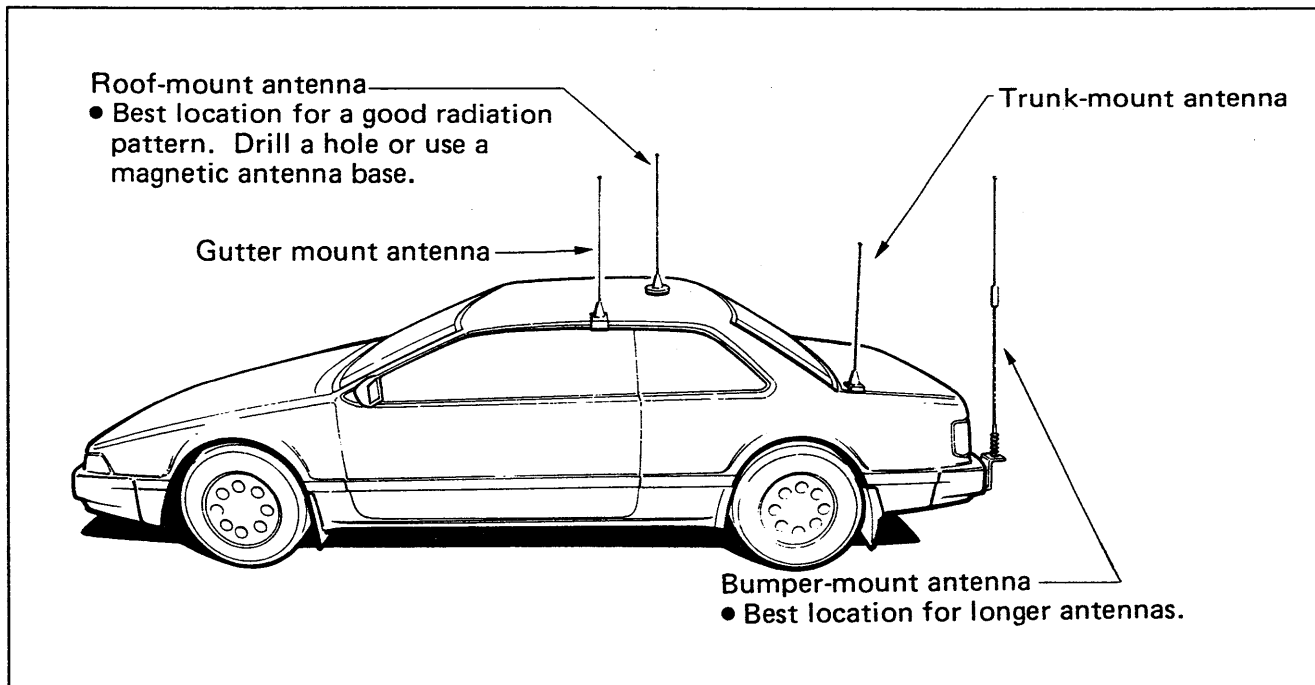

(6) ANTENNA CONNECTOR

A PL-259 type antenna connector is used for the transceiver.

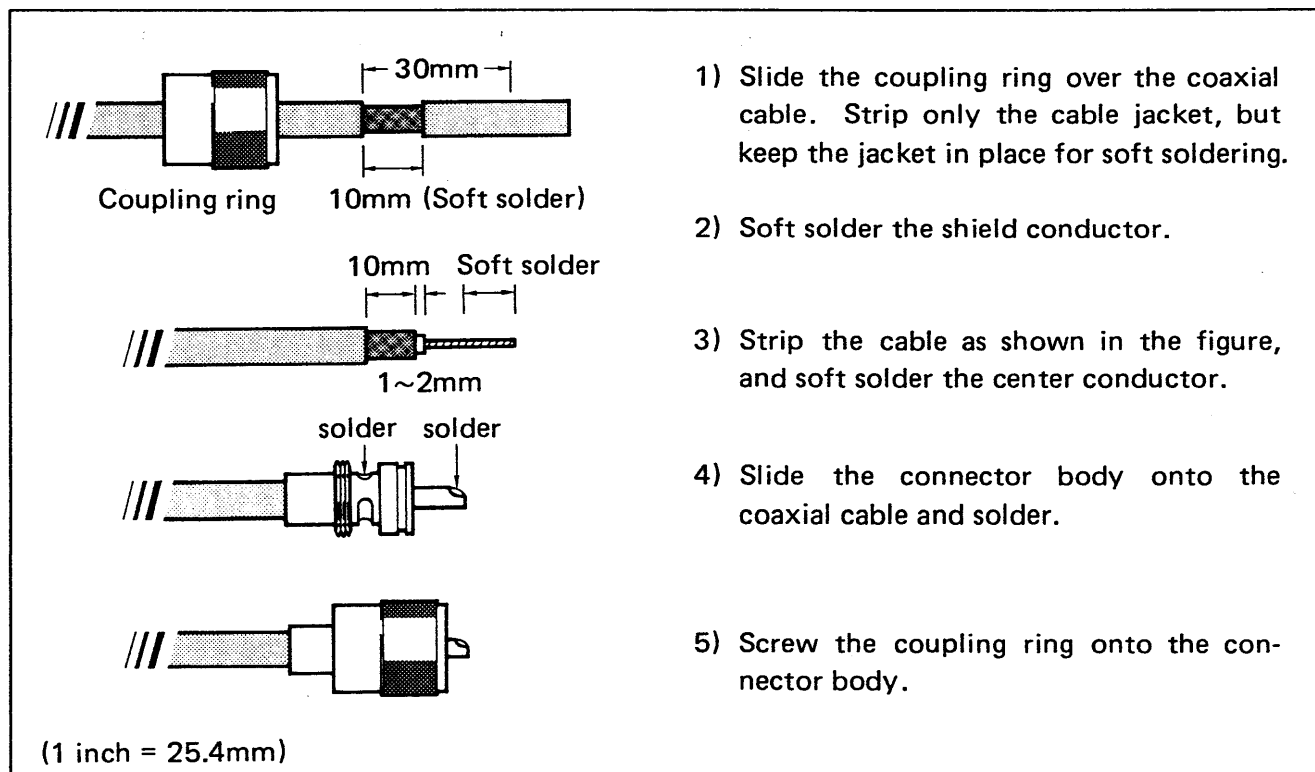

MODE CONSTRUCTION 5

The transceiver has 4 different modes for versatile, multi-function operations.

(1) VFO MODE



This mode is used for normal operations over the entire band.

(2) MEMORY MODE



This mode is used for operating the transceiver using memory channel contents. You can use 20 memory channels for programming (i.e., repeater frequencies, your group frequency, etc.).

(3) CALL CHANNEL MODE

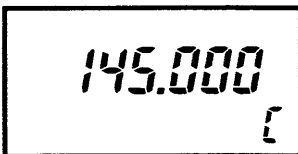

This mode provides a one touch calling channel independent from MEMORY mode. You can program the most often used frequency into this channel.

(4) SET MODE

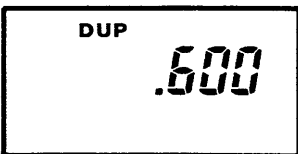

This mode is used for programming a subaudible tone frequency (U.S.A. and Asia versions), offset frequency, tuning step, programmed scan edge, beep tone ON/OFF and dimmer.

MODE CONSTRUCTION CHART

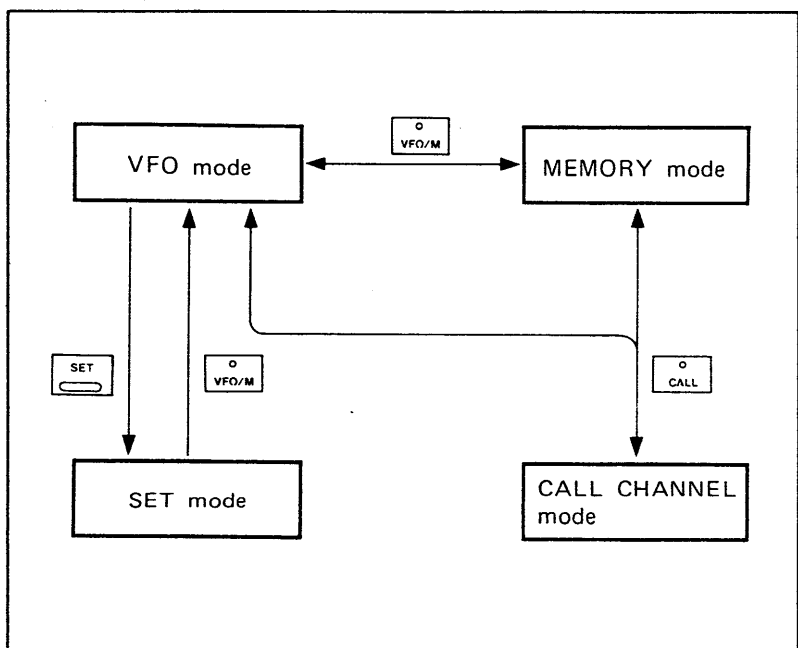

6 BASIC OPERATIONS

6-1 FREQUENCY SETTING

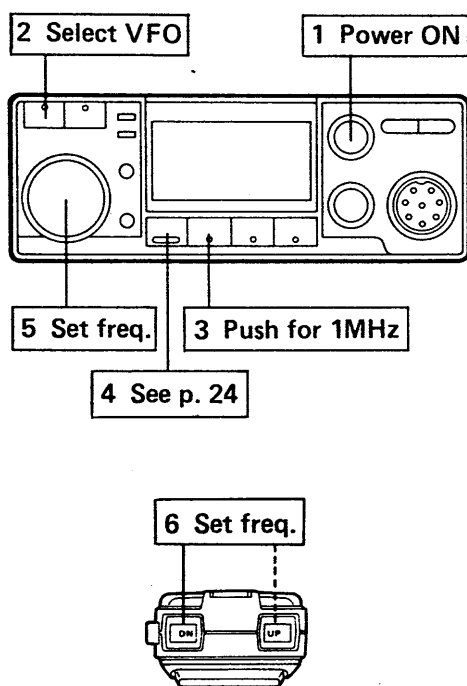

The transceiver has the following tuning steps selected by TUNING CONTROL rotation:

IC-228A/H : 5, 10, 15, 20, 25kHz and 1MHz
(with TS)

IC-228E/H : 12.5, 25kHz and 1MHz (with TS)

- The tuning step is programmed in SET mode. The minimum step, 5 and 12.5kHz can be changed by resetting the CPU.

1) Push [ON/VOL] to turn the power ON.

2) When MEMORY mode is selected ("M" appears on the FUNCTION DISPLAY), push [VFO/M] to select VFO mode.

3) Select the tuning step, 1MHz or programmed step with [TS].

- "TS" appears when the 1MHz step is selected. "TS" does not appear when the programmed step is selected.

4) To select the programmed tuning step, refer to Section 8 - 4 TUNING STEP (p. 24).

5) Rotate the TUNING CONTROL to select the desired frequency.

6) The microphone [UP] and [DN] SWITCHES also change the frequency.

- [UP] and [DN] change the frequency in the programmed tuning step, even if [TS] is turned ON.

6-2 RECEIVING

1) Turn the power ON and rotate [SQL/MONITOR] maximum counterclockwise.

- The [RX] INDICATOR lights and audio is emitted from the speaker.

2) Rotate [ON/VOL] to the desired audio level.

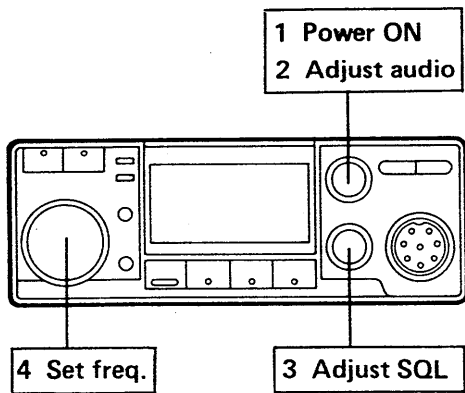

- 3) Rotate [SQL/MONITOR] to the squelch threshold point.
- 4) Set the desired frequency.
 - When a signal is received, audio is emitted from the speaker and the S/RF INDICATOR shows the relative signal strength.
- 5) Push [SQL/MONITOR] to open the squelch, if desired.

6-3 TRANSMITTING

CAUTION: Transmitting without an antenna may damage the transceiver.

NOTE: To prevent interference, listen on the frequency before transmitting.

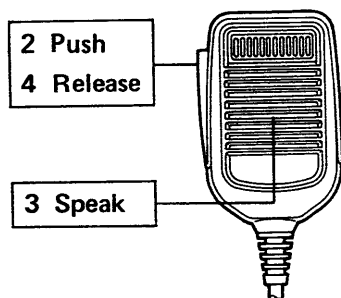
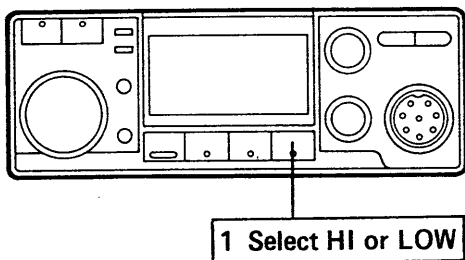

- 1) If "DUP—" or "DUP" appears on the FUNCTION DISPLAY, push [DUP] until it disappears.
- 2) Push [HI/LO] to select the output power.

• IC-228H	• IC-228A/E
HIGH : 45W	HIGH : 25W
LOW : 5W	LOW : 5W

 - "LOW" appears when LOW power is selected.
- 3) Push the [PTT] SWITCH on the microphone to transmit.
 - The [TX] INDICATOR lights and the S/RF INDICATOR shows relative output power selection.
- 4) Speak into the microphone using your normal voice level.
 - Do not hold the microphone too closely to your mouth or speak loudly. This may distort the signal.
- 5) Release [PTT] for receiving.

6 BASIC OPERATIONS

6-4 REPEATER OPERATION

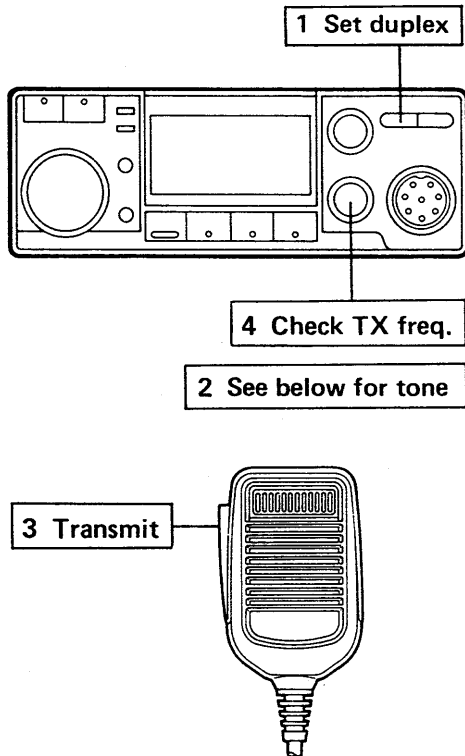

When working a repeater, set the transceiver to duplex. Most repeaters can be accessed only with a tone.

1) Push [DUP] once for -duplex or twice for +duplex.

- Either of the following indicators appear on the FUNCTION DISPLAY.

“DUP-” : Transmit freq.

= Receive freq. - Offset freq.

“DUP” : Transmit freq.

= Receive freq. + Offset freq.

- Offset frequency programming is described on p. 24.

2) Transmit a tone to access the repeater, if required. See below.

3) Push the [PTT] SWITCH on the microphone to transmit.

- The transmit frequency automatically shifts with the offset frequency.

4) To check the transmit frequency while receiving, push the [SQL/MONITOR] CONTROL.

- The squelch opens. (Optional Tone Squelch also opens.)

• Subaudible tone

Push [T/T.SQL] to turn a subaudible tone ON and OFF. See p. 23 for tone frequency programming.

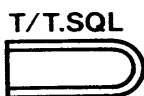

“TONE” appears on the FUNCTION DISPLAY.
(U.S.A. and Asia versions)

• DTMF tone

Push and hold the [PTT] SWITCH and then push the required number on the microphone back panel.



• 1750Hz tone

Push and hold the [TONE] SWITCH on the microphone for 1 ~ 3sec. (approx.) to transmit a 1750Hz tone.

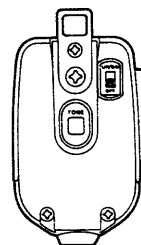

FUNCTION OPERATIONS 7

7-1 CALL CHANNEL MODE

The transceiver has an independent CALL CHANNEL mode which provides easy access to your most often used frequency.

The CALL CHANNEL mode can be accessed from any mode.

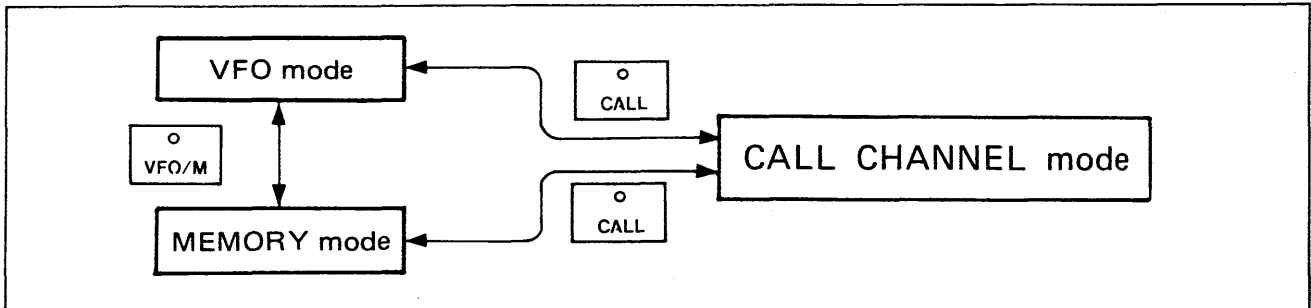

(1) CALL CHANNEL READING

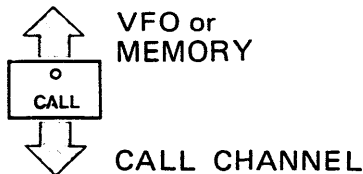
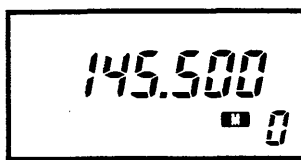

1) Push [CALL] to access CALL CHANNEL mode.

- "C" appears in place of the memory channel number.
- The TUNING CONTROL is deactivated.

2) Push [CALL] again to return to the previous mode.

- [VFO/M] also leaves CALL CHANNEL mode.

(2) CALL CHANNEL PROGRAMMING

In CALL CHANNEL mode

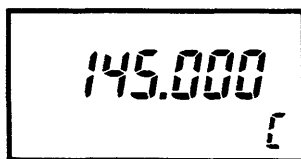

Push and hold

1) Push [VFO/M] to access VFO mode.

- Be sure "M" and "C" disappear from the FUNCTION DISPLAY.

2) Select the required contents to be programmed (operating frequency, repeater information, etc.).

- See pgs. 11 and 13 for selection.

3) Push [CALL] to access CALL CHANNEL mode.

4) Push and hold [MW] until three beeps are emitted from the speaker.

7 FUNCTION OPERATIONS

7-2 MEMORY MODE

The transceiver has 20 memory channels. Each memory channel independently stores a frequency, duplex condition, offset frequency, subaudible tone frequency (U.S.A. and Asia versions) and the Memory Skip function.

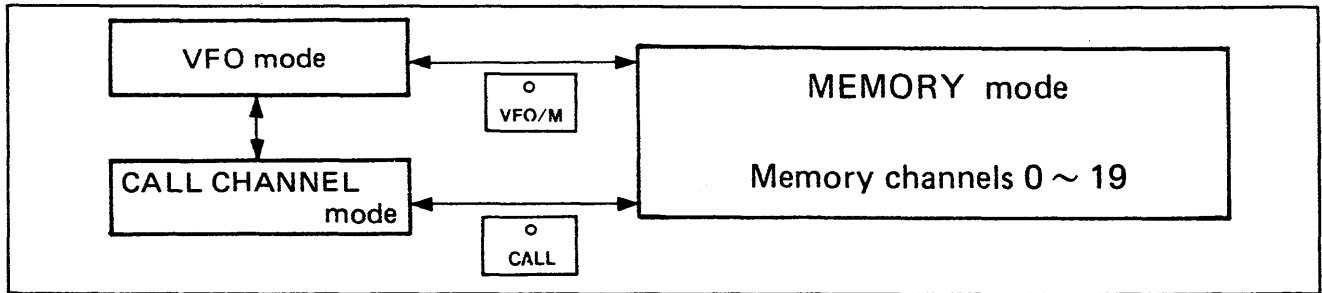

(1) MEMORY CHANNEL

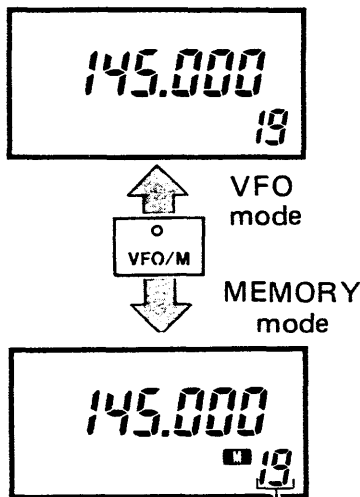

With TUNING CONTROL
or [UP] / [DN]

1) Push [VFO/M] to select MEMORY mode.

- "M" appears on the FUNCTION DISPLAY.

2) Rotate the TUNING CONTROL to select the desired memory channel.

- The microphone [UP] and [DN] SWITCHES also change the memory channel.

3) Push [VFO/M] again to return to VFO mode.

(2) MEMORY WRITING

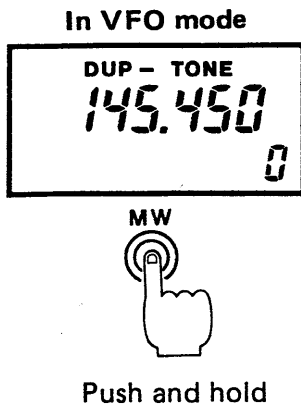

- 1) Select the desired memory channel to be programmed. See (1) MEMORY CHANNEL (p. 15).
- 2) Push [VFO/M] to select VFO mode.
 - "M" disappears from the FUNCTION DISPLAY.
- 3) Select the required contents to be programmed (operating frequency, repeater information, etc.).
 - See pgs. 11 and 13 for selection.
- 4) Push and hold [MW] until three beeps are emitted from the speaker.
 - Memory writing has been completed. To check the contents, push [VFO/M].

(3) MEMORY TRANSFERRING

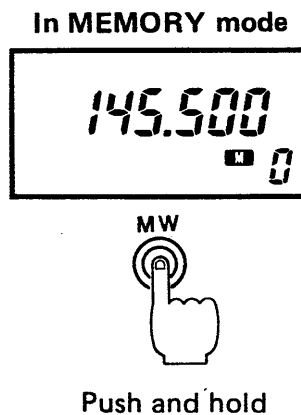

Copy and transfer the displayed memory contents into VFO mode. This function is useful for searching for signals around the memory channel frequency.

The memory channel contents are not erased.

- 1) Select the desired memory channel to be transferred. See (1) MEMORY CHANNEL (p. 15).
- 2) Push and hold [MW] until three beeps are emitted from the speaker.
 - The transceiver automatically changes to VFO mode.

7 FUNCTION OPERATIONS

7-3 SCAN FUNCTION

The transceiver has two scans, the Programmed Scan and the Memory Scan to automatically search for a signal.

(1) PROGRAMMED SCAN

The Programmed Scan scans all frequencies between two frequency edges. Refer to Section 8 - 5 PROGRAMMED SCAN EDGES (p. 25).

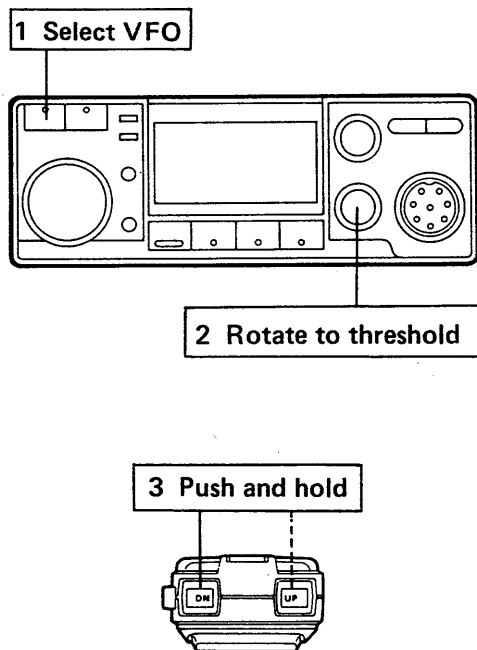
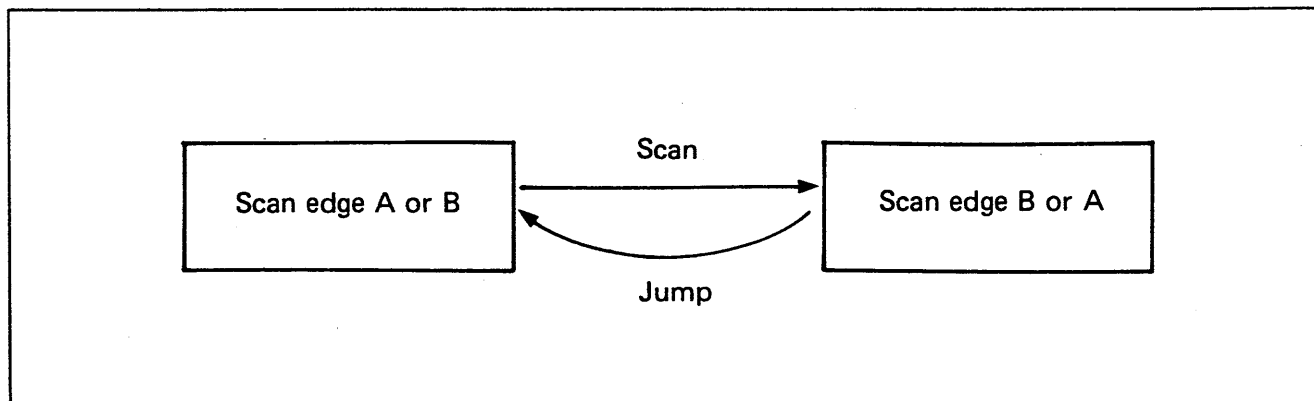

- 1) Select VFO mode with [VFO/M].
- 2) Rotate and adjust [SQL/MONITOR] to the squelch threshold point.
 - The [RX] INDICATOR goes out.
- 3) Push and hold [UP] or [DN] on the microphone for 0.5sec. (approx.) to start the Programmed Scan.
 - [UP] : starts upward scan.
 - [DN] : starts downward scan.
 - The decimal point blinks during scanning.
- 4) When a signal is received, scanning stops.
 - After 15sec., scanning resumes.
 - 2sec. after signal disappears, scanning starts again.
- 5) To cancel the scanning, push [UP] or [DN] on the microphone.
 - TUNING CONTROL, [VFO/M] or [CALL] also cancels the scanning.

(2) MEMORY SCAN

The Memory Scan scans all memory channels in succession. To skip certain memory channels, refer to (3) MEMORY SKIP FUNCTION on the next page.

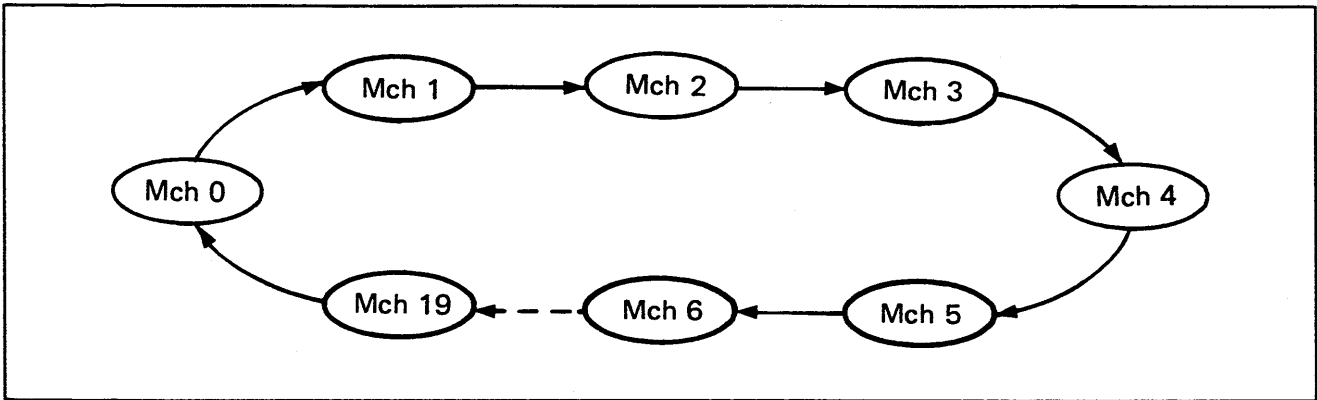

1 Select MEMORY

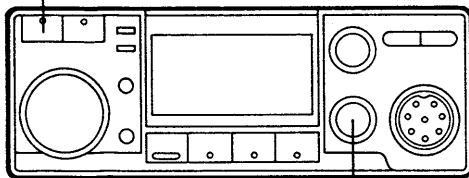

2 Rotate to threshold

3 Push and hold

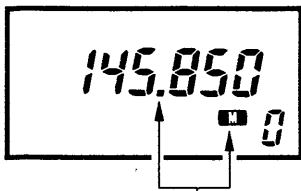
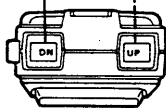

Blinks during scanning

- 1) Select MEMORY mode with [VFO/M].
- 2) Rotate and adjust [SQL/MONITOR] to the squelch threshold point.
 - The [RX] INDICATOR goes out.
- 3) Push and hold [UP] or [DN] on the microphone for 0.5sec. (approx.) to start the Memory Scan.
 - [UP] : starts the upward memory scan.
 - [DN] : starts the downward memory scan.
 - The decimal point and "M" blink during scanning.
- 4) When a signal is received, scanning stops.
 - After 15sec., scanning resumes.
 - 2sec. after signal disappears, scanning resumes.
- 5) To cancel the scanning, push [UP] or [DN] on the microphone.
 - TUNING CONTROL, [VFO/M] or [CALL] also cancels the scanning.

7 FUNCTION OPERATIONS

(3) MEMORY SKIP FUNCTION

The Memory Skip function programs memory channels to be skipped during the Memory Scan.

The Memory Skip function can also be used for the Priority Watch. See p. 21, VFO ↔ MEMORY CHANGING.

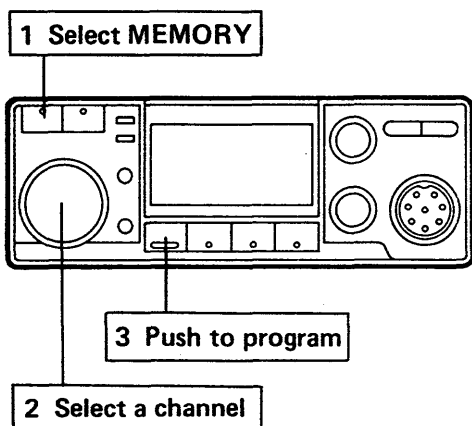
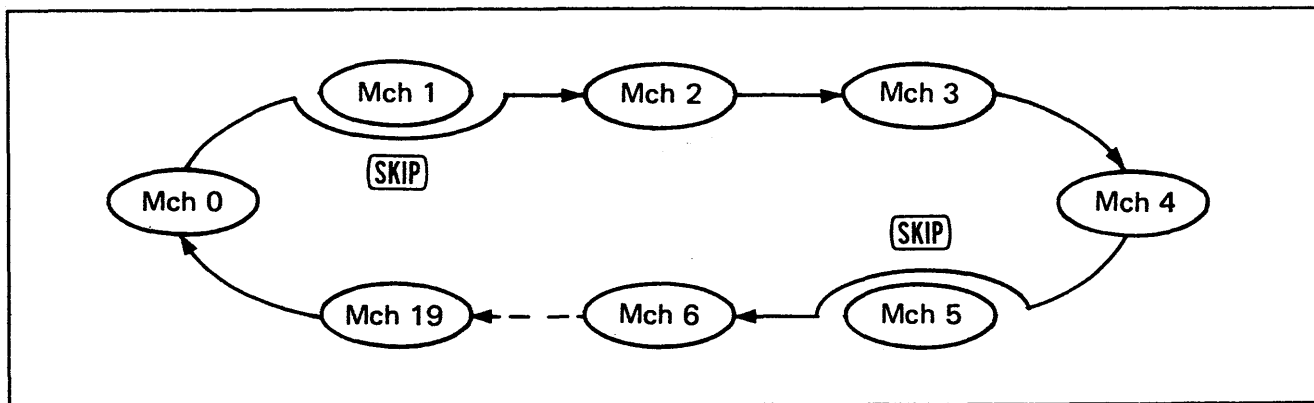

Programmed
as a skip channel

- 1) Select MEMORY mode with [VFO/M].
 - "M" appears on the FUNCTION DISPLAY.
- 2) Select the memory channel to be skipped with the TUNING CONTROL.
- 3) Push [SET] to program the selected memory channel as the skip channel.
 - "SKIP" appears on the FUNCTION DISPLAY.
- 4) Push [SET] again to cancel the programmed skip channel.
 - "SKIP" disappears from the FUNCTION DISPLAY.

7-4 PRIORITY WATCH

The Priority Watch watches memory channels in sequence, a memory channel or the call channel during VFO operation. A memory or call channel is watched once every 5sec.

(1) VFO ↔ MEMORY OR CALL CHANNEL

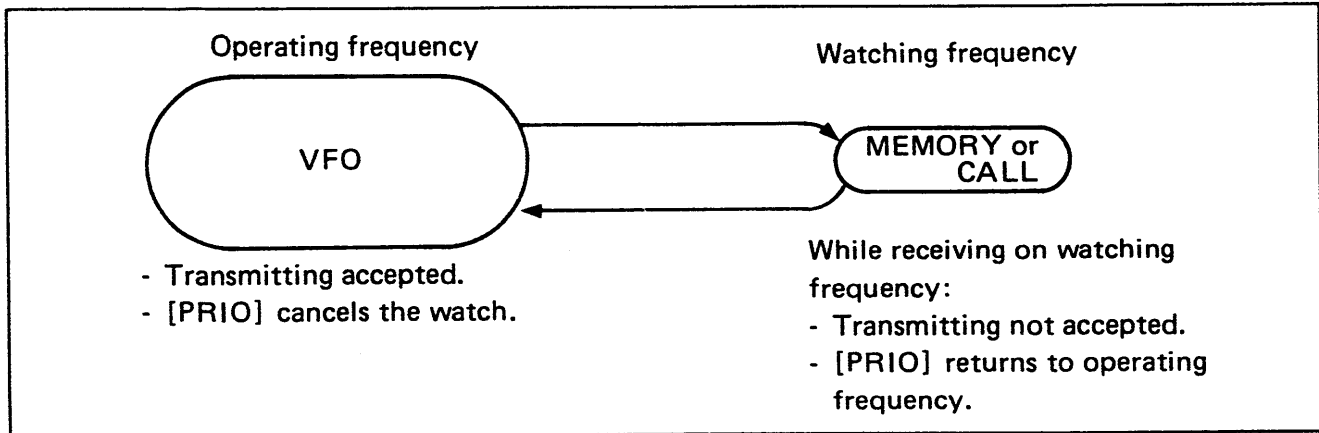

1) Select VFO mode with [VFO/M]. Then set the desired operating frequency.

2) Push [VFO/M] or [CALL], then select the desired watching frequency in a memory channel or the call channel.

3) Push [PRIO] to start the Priority Watch.

- "PRIO" appears on the FUNCTION DISPLAY and the transceiver returns to VFO mode.

4) When a signal is received on the VFO frequency, the Priority Watch continues.

5) When a signal is received on the watching frequency (memory or call channel), the Priority Watch stops on the watching frequency for 15sec.

- If you want to transmit on the watching frequency, push [VFO/M] or [CALL]. The Priority Watch is canceled.

6) To cancel the Priority Watch, push [PRIO] again while the operating frequency is displayed.

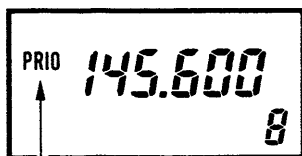
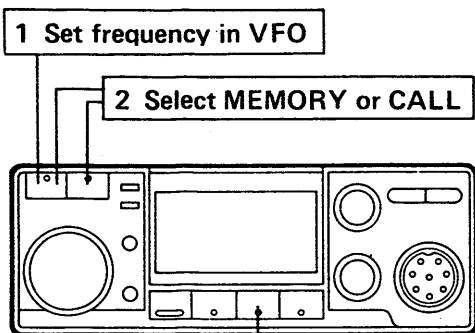

"PRIO" appears

7 FUNCTION OPERATIONS

(2) VFO ↔ MEMORY CHANNEL CHANGING

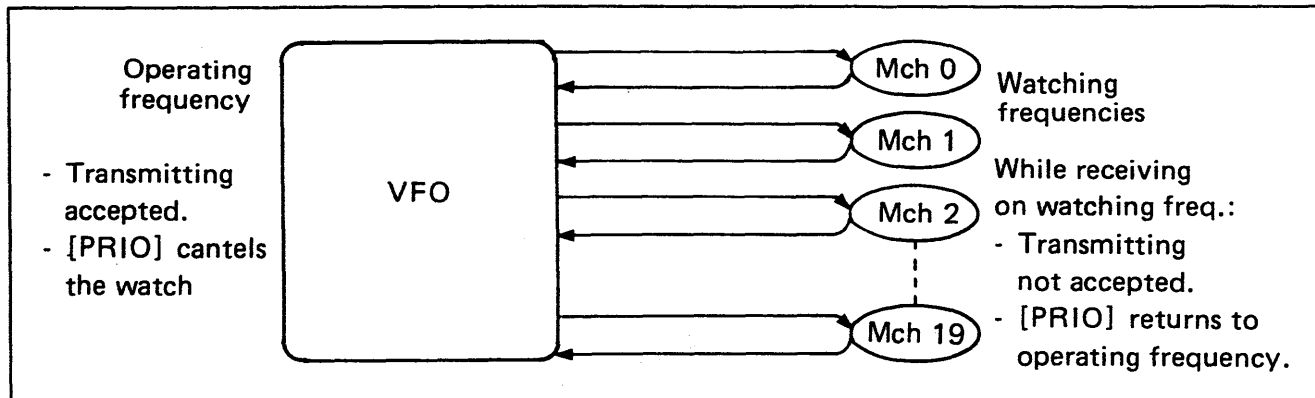

1) Select VFO mode with [VFO/M]. Then set the desired operating frequency.

2) Push [VFO/M] to access MEMORY mode.

3) Push and hold the microphone [UP] or [DN] SWITCH to start the Memory Scan.

- Use with the Memory Skip function to skip channels you do not want to watch. (p. 19)

4) Push [PRIO] to start the Priority Watch.

- The transceiver returns to VFO mode, and "PRIO" appears on the FUNCTION DISPLAY.

5) Each time of the transceiver watches the memory channel, the memory channel changes.

6) When a signal is received on the VFO frequency, the Priority Watch continues.

7) When a signal is received on the memory channel, the Priority Watch stops on the memory channel for 15sec.

- If you want to transmit on the memory channel, push [VFO/M]. The Priority Watch is canceled.

8) To cancel the Priority Watch, push [PRIO] again while the operating frequency is displayed.

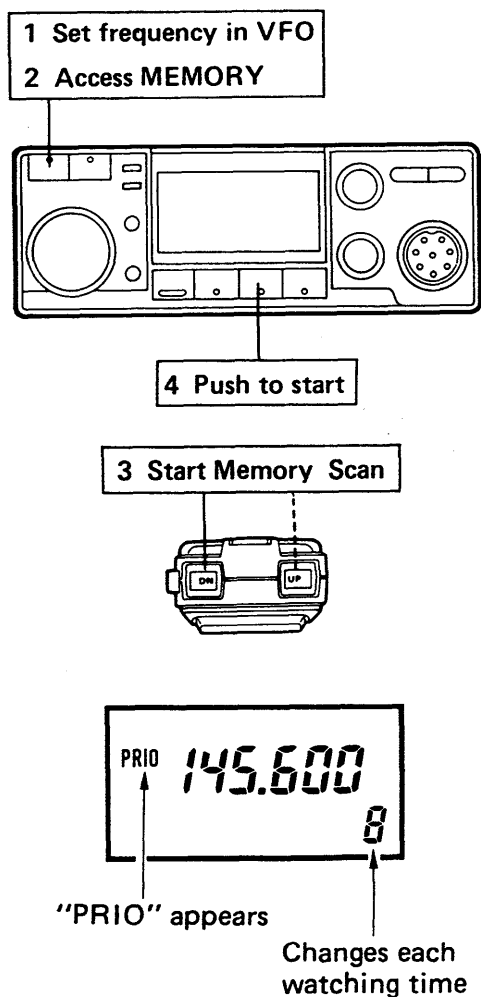

8-1 SET MODE CONSTRUCTION

Push [SET] during VFO mode to access SET mode. The transceiver begins the display again in the place in the cycle where it last stopped.

Contents as shown in the chart below are programmed in SET mode.

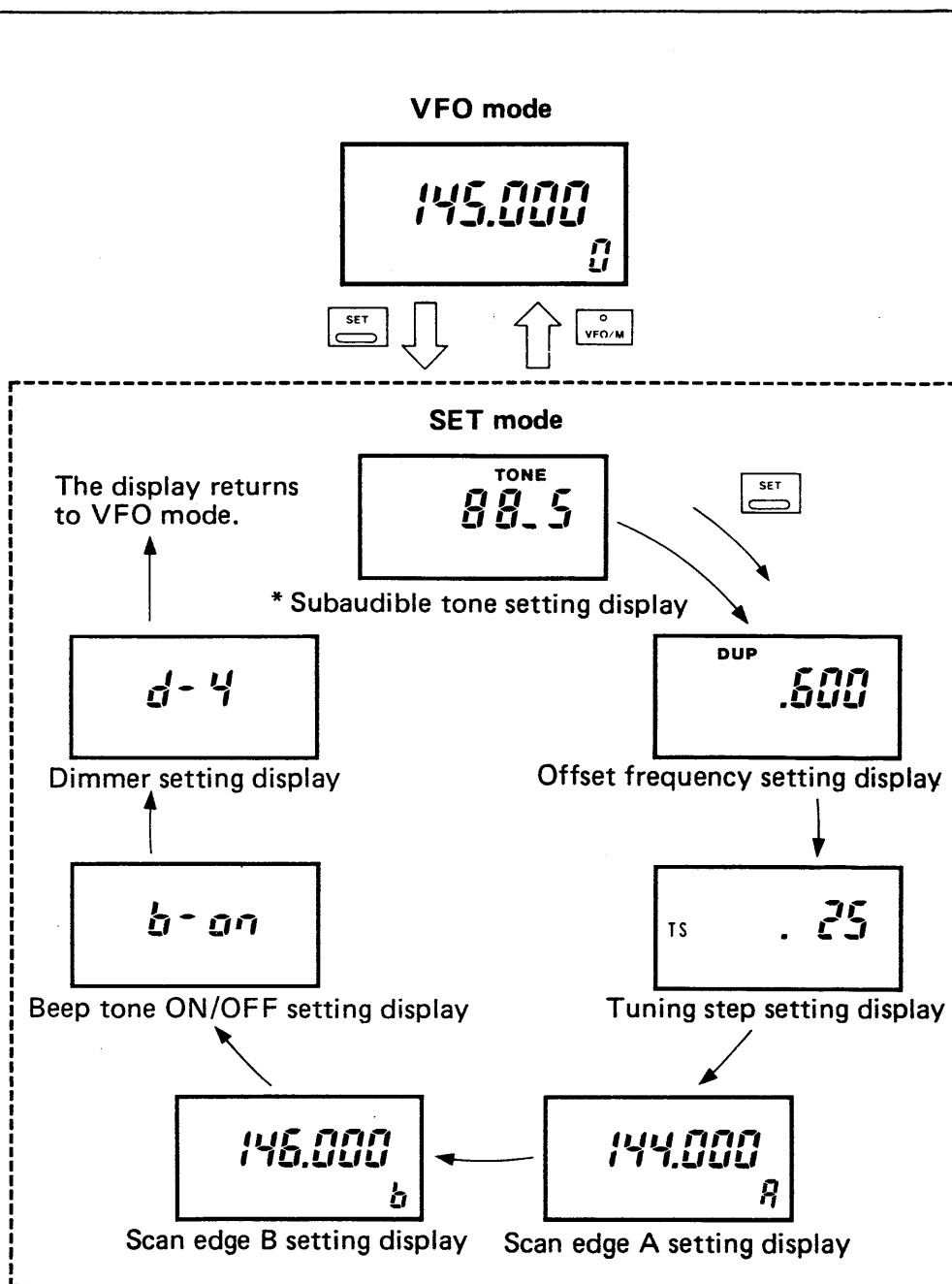

The subaudible tone frequency and offset frequency can be independently programmed in a memory channel.

* Only appears in the IC-228A/H (U.S.A. and Asia versions). The UT-40 TONE SQUELCH UNIT is required in other versions.

8 SET MODE

8-2 SUBAUDIBLE TONE FREQUENCY



The subaudible tone setting display shows 88.5Hz tone.

See pgs. 13 and 28 for operation information.

NOTE - This display only appears in the IC 228A/H (U.S.A. and Asia versions). The optional UT-40 is required in other versions.

Select one of 38 subaudible tone encoder frequencies for repeater operation (only U.S.A. and Asia versions).

When the UT-40 is installed, 37 CTCSS tone encoder/decoder frequencies are selected (all versions).

- 1) Select VFO mode with [VFO/M].
- 2) Push [SET] to access SET mode.
- 3) To select the subaudible tone setting display, push [SET] several times until "TONE" flashes on the FUNCTION DISPLAY.
- 4) Rotate the TUNING CONTROL to select the desired tone frequency.
- 5) To access the next SET mode display, push [SET]; or to return to VFO mode, push [VFO/M].

8-3 OFFSET FREQUENCY



The offset frequency setting display shows 600kHz (0.6MHz) offset.

See p. 13 for operation information.

When duplex operation is selected, the transceiver functions with this offset frequency.

- 1) Select VFO mode with [VFO/M].
- 2) Push [SET] to access SET mode.
- 3) To select the offset frequency setting display, push [SET] several times until "DUP" flashes on the FUNCTION DISPLAY.
- 4) Rotate the TUNING CONTROL to select the desired offset frequency.
 - The [TS] SWITCH can be used to select the offset frequency.
- 5) To access the next SET mode display, push [SET]; or to return to VFO mode, push [VFO/M].

8-4 TUNING STEP

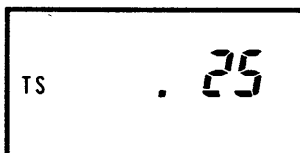

The tuning step setting display shows 25kHz step.

The transceiver changes the frequency with programmable tuning steps when [TS] is turned OFF.

The minimum tuning step, 5kHz (IC-228A/H) and 12.5kHz (IC-228E/H) can be set by CPU resetting (p. 31)

- 1) Select VFO mode with [VFO/M].
- 2) Push [SET] to access SET mode.
- 3) To select the tuning step setting display, push [SET] several times until "TS" flashes on the FUNCTION DISPLAY.
- 4) Rotate the TUNING CONTROL to select the desired tuning step.
- 5) To access the next SET mode display, push [SET]; or to return to VFO mode, push [VFO/M].

8 SET MODE

8-5 PROGRAMMED SCAN EDGES

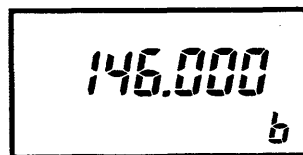
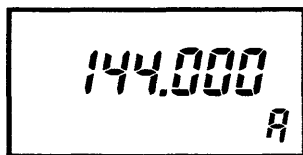

Scan edge setting displays

See p. 17 for operation.

The purpose of the Programmed Scan is to scan a particular section of the band. Programmed scan edges can be programmed in the following way:

- 1) Select VFO mode with [VFO/M].
- 2) Push [SET] to access SET mode.
- 3) To select the scan edge A setting display, push [SET] several times until "A" flashes on the FUNCTION DISPLAY's memory channel readout.
- 4) Rotate the TUNING CONTROL to select the upper or lower scan edge.
 - The [TS] SWITCH can be used to select the scan edge A frequency.
- 5) Push [SET] to access the scan edge B setting display.
 - "b" flashes on the FUNCTION DISPLAY's memory channel readout.
- 6) Rotate the TUNING CONTROL to select the other side of the scan edge.
 - Use [TS], if desired.
- 7) To access the next SET mode display, push [SET]; or to return to VFO mode, push [VFO/M].

8-6 BEEP TONE ON/OFF

A beep tone is emitted each time a switch is pushed. If you do not require beep tones, they can be eliminated in the following way:

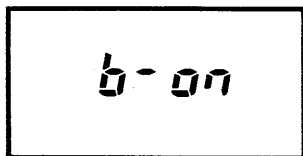

The beep tone ON/OFF setting display shows that the beep tones are ON.

- 1) Select VFO mode with [VFO/M].
- 2) Push [SET] to access SET mode.
- 3) To select the beep tone ON/OFF setting display, push [SET] several times until "b-on" or "b-oFF" appears on the FUNCTION DISPLAY.
- 4) Rotate the TUNING CONTROL to select the beep ON ("b-on") or OFF ("b-oFF").
- 5) To access the next SET mode display, push [SET]; or to return to VFO mode, push [VFO/M].

8-7 DIMMER CONTROL

The backlight of the FUNCTION DISPLAY can be dimmed to suit your needs.

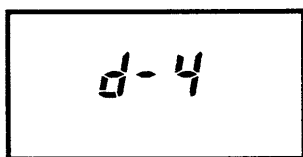

The dimmer setting display shows brightest display.

- 1) Select VFO mode with [VFO/M].
- 2) Push [SET] to access SET mode.
- 3) To select the dimmer setting display, push [SET] several times until one of "d-1" ~ "d-4" appears on the FUNCTION DISPLAY.
- 4) Rotate the TUNING CONTROL to select the desired backlight intensity.
 - "d-1" : dark
 - "d-4" : bright
- 5) To return to VFO mode, push [VFO/M].

9 OPTIONAL TONE SQUELCH UNIT

The optional UT-40 TONE SQUELCH UNIT provides the Pocket Beep and Tone Squelch functions.

9-1 UT-40 INSTALLATION

CAUTION: Disconnect the power cable before opening the transceiver's cover.

- 1) Turn the power OFF and disconnect the power cable from the transceiver.
- 2) Remove 2 screws from the bottom cover (speaker side).
- 3) Open the bottom cover slowly (a little tight) and disconnect the speaker connector.
 - **BE CAREFUL!** Do not cut the speaker cord.
- 4) Connect the 10-pin plug to the connector on the UT-40.
- 5) Remove the protective paper from the back of the UT-40 to expose the adhesive strip, and attach the unit as shown in the diagram below.
- 6) Replace the bottom cover and 2 screws.

• Open the bottom cover.

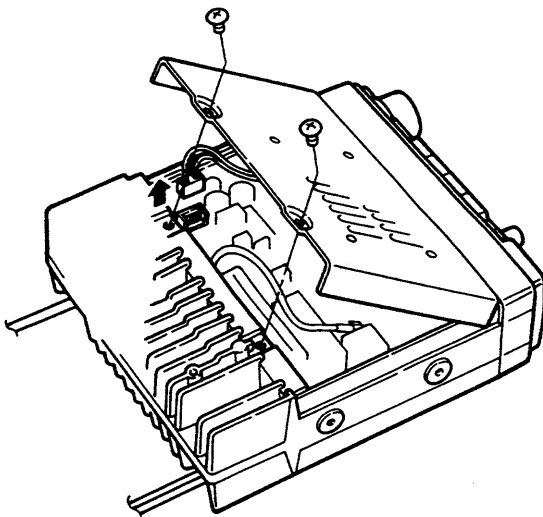

• Install the UT-40.

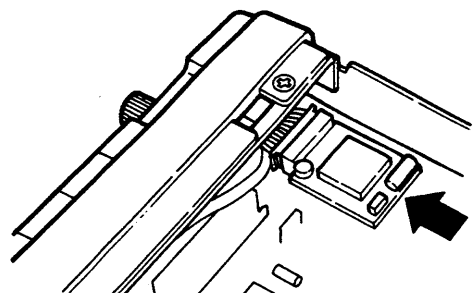

9-2 POCKET BEEP FUNCTION

The Pocket Beep function alerts you using 30sec. beep tones and "SQL" flashing when a call is received with same subaudible tone programmed in your transceiver.

This function is very convenient for times when you are temporarily away from the transceiver.

To set a tone frequency, see p. 23. Install the UT-40 (sold separately) for operating this function.

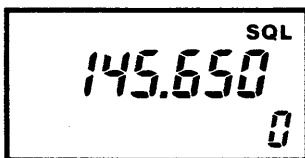
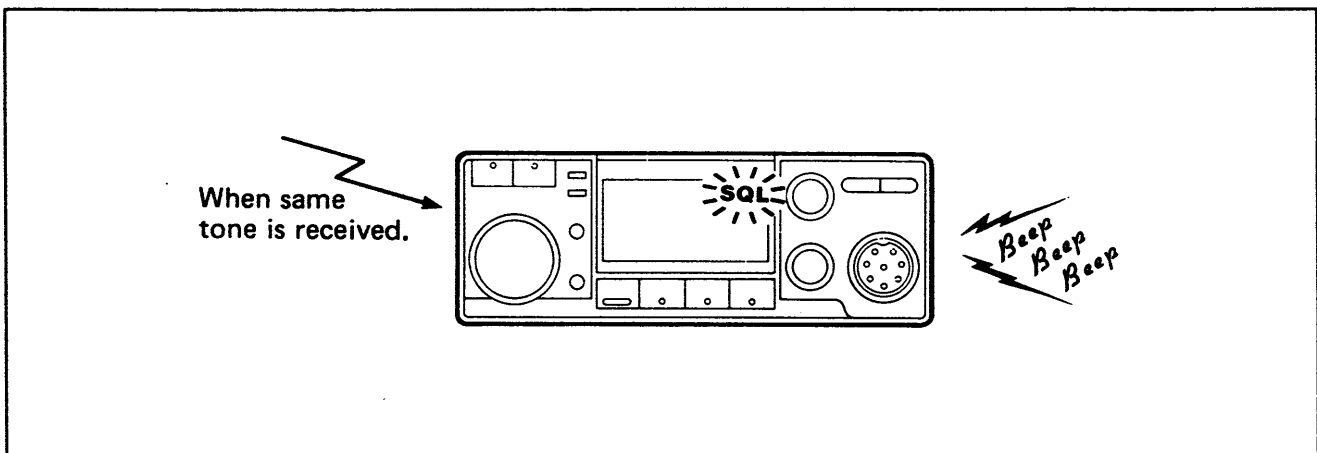

- 1) Push [T/T.SQL] 2 times when the FUNCTION DISPLAY does not show "TONE" and "SQL."
 - "SQL" appears on the FUNCTION DISPLAY.
- 2) When a signal with same tone programmed is received, 30sec. beeps are emitted and "SQL" flashes on the FUNCTION DISPLAY.
- 3) Push any switch to stop the beeps.
 - The transceiver selects the Tone Squelch function.

NOTE: Some repeaters filter subaudible tones: the tone is not sent to other station, making Pocket Beep inoperation.

9 OPTIONAL TONE SQUELCH UNIT

9-3 TONE SQUELCH FUNCTION

The Tone Squelch function allows you to receive a signal only with the same subaudible tone programmed in your transceiver.

To set a tone frequency, see p. 23. Install the UT-40 (sold separately) for operating this function.

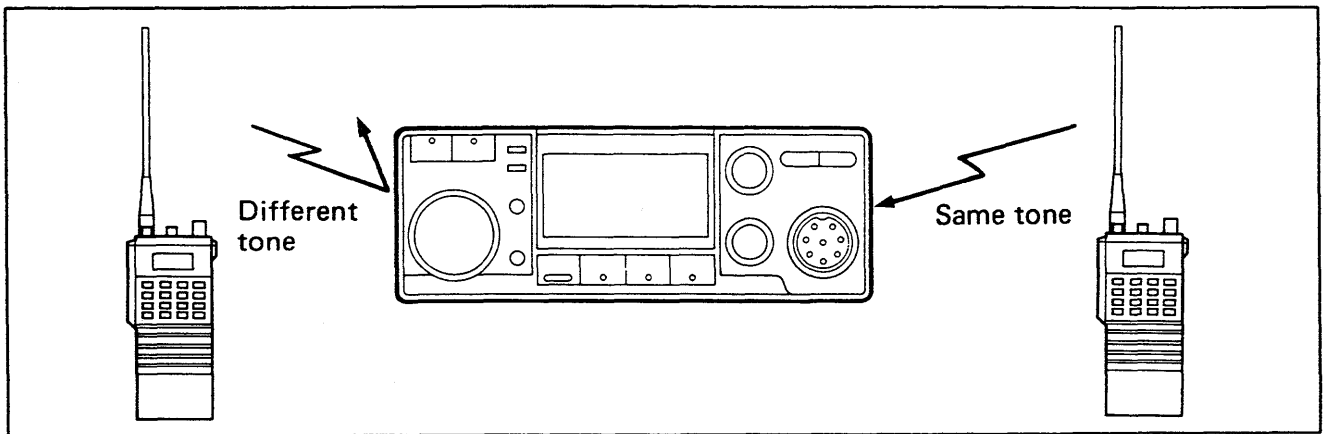

- 1) Push [T/T.SQL] 3 times when the FUNCTION DISPLAY does not show "TONE" and "SQL."
 - "TONE SQL" appears on the FUNCTION DISPLAY.
- 2) When a signal with the same tone programmed is received, the squelch opens and the receiving signal can be heard.
- 3) When a signal with a different tone is received, the [RX] INDICATOR lights. However, the squelch does not open.
 - To listen the receiving signal, push [SQL/MONITOR] to activate the Monitor function.
 - When duplex is selected, the Monitor function receives on the transmit frequency.
- 4) Push [T/T.SQL] again to turn the Tone Squelch function OFF.

10-1 TROUBLESHOOTING

PROBLEM	POSSIBLE CAUSE	SOLUTION	REF
1. Power does not come ON.	<ul style="list-style-type: none"> • Polarity of the power connection is reversed. • Blown fuse. 	<ul style="list-style-type: none"> • Reconnect the power cable observing the proper polarity. • Check the cause, then replace the fuse. 	<p>p. 8</p> <p>p. 32</p>
2. No sound comes from the speaker.	<ul style="list-style-type: none"> • [SQL/MONITOR] is turned too far clockwise. • The optional Tone Squelch is turned ON, if the UT-40 is installed. 	<ul style="list-style-type: none"> • Set [SQL/MONITOR] at the threshold point. • Turn OFF the Tone Squelch function. 	<p>p. 11</p> <p>p. 29</p>
3. Sensitivity is low and only strong signals are audible.	<ul style="list-style-type: none"> • Antenna feedline or the soldering of antenna connector is cut or short circuited. 	<ul style="list-style-type: none"> • Check, and if necessary, replace the feedline; or solder the antenna connector again. 	<p>p. 9</p>
4. No contact possible with another station.	<ul style="list-style-type: none"> • The transceiver is set to duplex. 	<ul style="list-style-type: none"> • Set to simplex. 	<p>p. 12</p>
5. Repeater can not be accessed.	<ul style="list-style-type: none"> • Wrong offset frequency is programmed. • Wrong subaudible tone frequency is programmed. 	<ul style="list-style-type: none"> • Correct the offset frequency. • Correct the subaudible tone frequency. <p>Be sure the offset and subaudible tone frequencies are independently programmed on each memory channel.</p>	<p>p. 24</p> <p>p. 23</p>
6. Frequency can not be set.	<ul style="list-style-type: none"> • The [LOCK] SWITCH is turned ON. • CALL CHANNEL mode is selected. 	<ul style="list-style-type: none"> • Turn OFF [LOCK]. • Push [CALL] to leave CALL CHANNEL mode. 	<p>p. 3</p> <p>p. 14</p>
7. Scan does not operate.	<ul style="list-style-type: none"> • Squelch is open. • Scan edge A equals B. • All memory channels are programmed as the skip channel. 	<ul style="list-style-type: none"> • Set the squelch threshold point. • Reset scan edges. • Cancel the Memory Skip function in the desired channel. 	<p>p. 17</p> <p>p. 25</p> <p>p. 19</p>
8. All programmed memories have been erased.	<ul style="list-style-type: none"> • Data error occurred in the CPU RAM because of the following problems: <ul style="list-style-type: none"> - The backup battery is empty. - The CPU has been damaged by static. 	<ul style="list-style-type: none"> • Replace the backup battery. <p>Reset the CPU.</p>	<p>p. 32</p> <p>p. 31</p>

10 MAINTENANCE

10-2 CPU RESETTING

NOTE: Resetting the CPU erases all information written into memory channels.

(1) AUTOMATIC RESET

The transceiver resets the CPU itself when the power is ON under the following conditions:

- the backup battery is empty.
- data error occurred in the CPU RAM stage caused by static, etc.

(2) MANUAL RESET

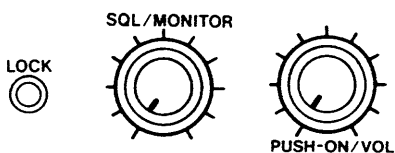

1) Turn the power OFF.

2) While pushing and holding [SQL/MONITOR] and [LOCK], turn the power ON.

(3) MINIMUM TUNING STEP SELECTION

When changing the minimum tuning step to 5kHz and 12.5kHz in following way, frequency and tone data are erased. However, beep tone and dimmer data will be retained.

• 5kHz → 12.5kHz

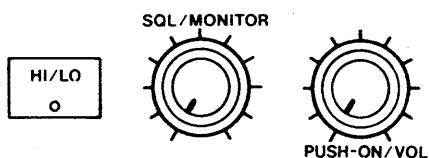

1) Turn the power OFF.

2) While pushing and holding [SQL/MONITOR] and [HI/LO], turn the power ON.

• 12.5kHz → 5kHz

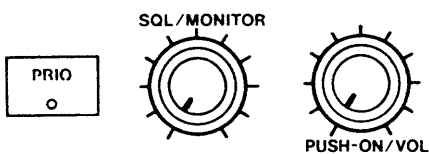

1) Turn the power OFF.

2) While pushing and holding [SQL/MONITOR] and [PRIO], turn the power ON.

10-3 MISCELLANEOUS MAINTENANCE

■ BACKUP BATTERY

The transceiver has a lithium backup battery installed. The usual life of the battery is more than 5 years. If the battery is exhausted, the transceiver operates normally but channel information in memory channels is not retained each time of the power is turned ON.

NOTE: Backup battery replacement must be done by an authorized Icom Dealer or Service Center.

■ FUSE REPLACEMENT

Locate the cause of a blown fuse before replacing it and operating the transceiver, if possible.

- DC line fuse : 15A (all versions)

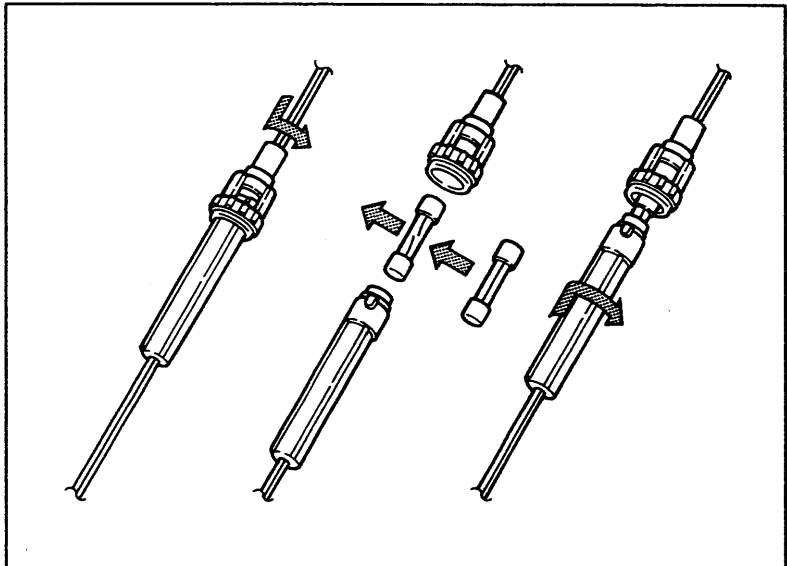

1 INSIDE VIEWS

TOP VIEW (MAIN UNIT)

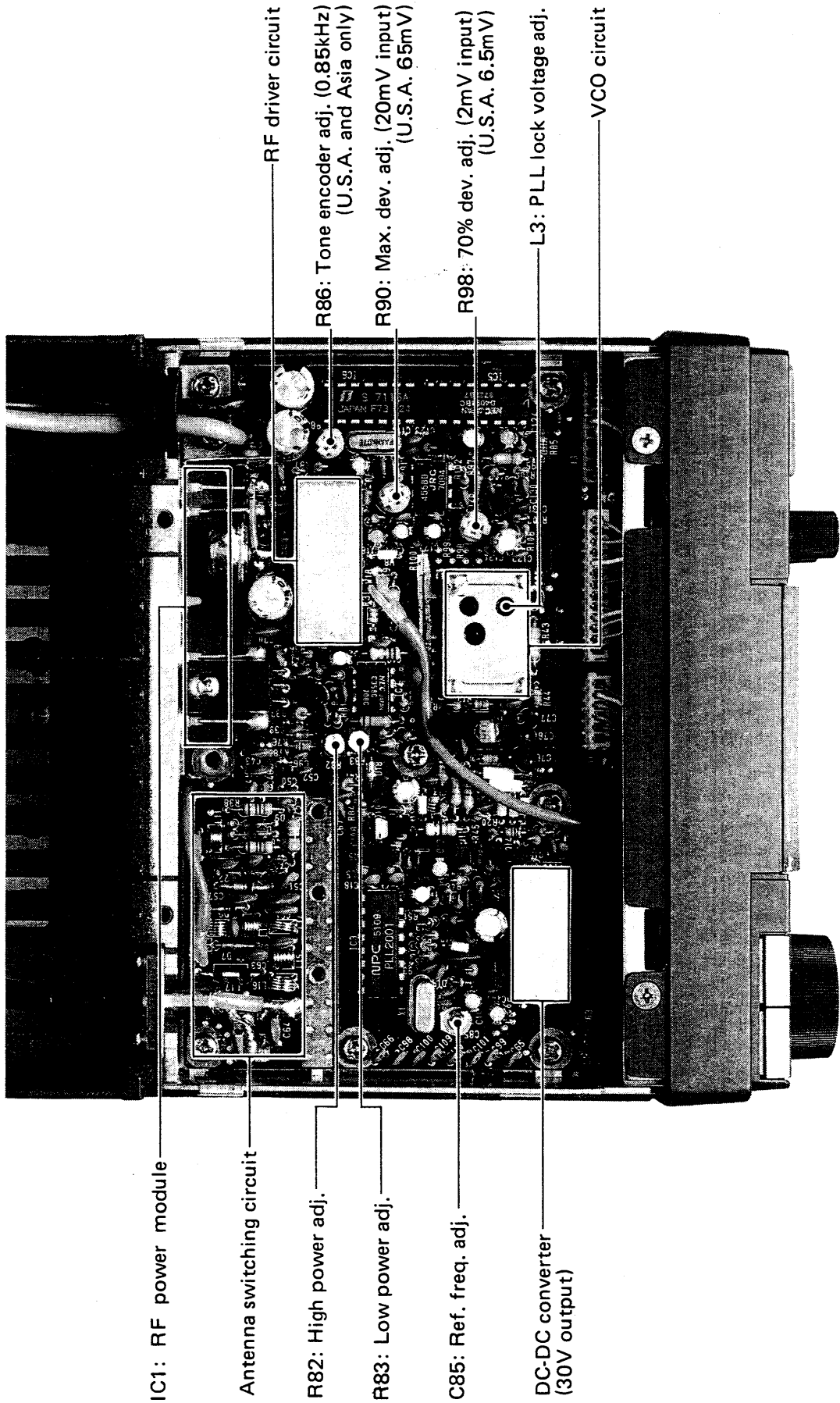

■ BOTTOM VIEW (RX UNIT)

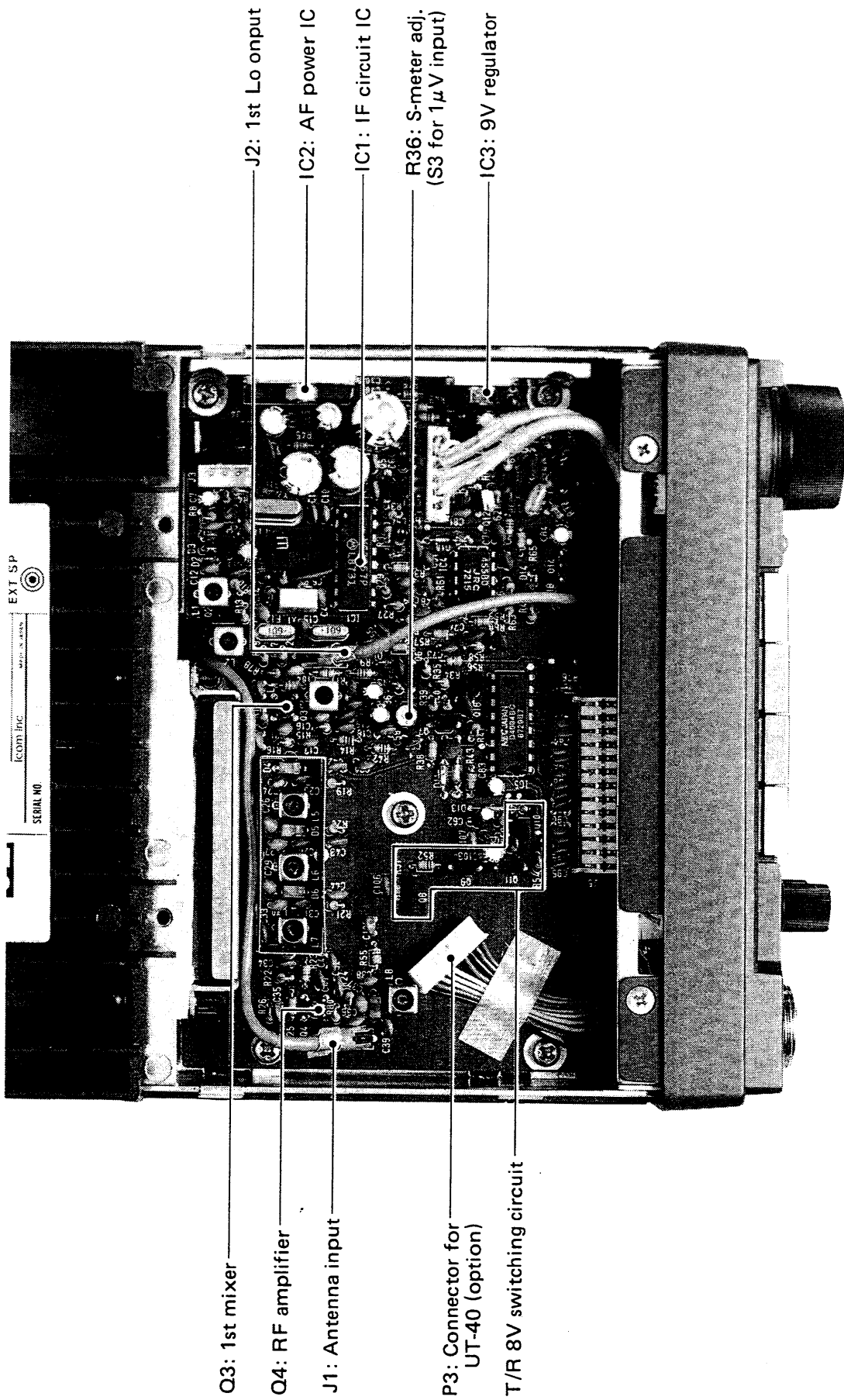

Above photos show IC-228H U.S.A. version

12 SPECIFICATIONS

■ GENERAL

● Frequency coverage :

MODEL	VERSION	RECEIVER	TRANSMITTER
IC-228A/H	U.S.A.	138.00 ~ 174.00MHz*	140.00 ~ 150.00MHz*
IC-228A/H	Australia	144.00 ~ 148.00MHz	144.00 ~ 148.00MHz
IC-228A/H	Asia	138.00 ~ 174.00MHz*	140.00 ~ 150.00MHz*
IC-228E/H	Europe	144.00 ~ 146.00MHz	144.00 ~ 146.00MHz
IC-228E/H	Italy	140.00 ~ 150.00MHz*	140.00 ~ 150.00MHz*

* Specifications apply to 144.00 ~ 148.00MHz only.

- Mode : F3 (FM)
- Selectable tuning steps : 5, 10, 15, 20 and 25kHz (U.S.A. Australia, Asia versions)
(Initial) 12.5 and 25kHz (Europe, Italy versions)
- Memory channels : 20 plus a call channel
- Antenna impedance : 50Ω
- Power supply requirement : 13.8V DC ±15% (negative ground)
- Current drain (IC-228H) : Receive 450mA (standby)
800mA (max. audio output)
Transmit 3.5A (LOW)
9.5A (HIGH)
- Current drain (IC-228A/E) : Receive 450mA (standby)
800mA (max. audio output)
Transmit 3.0A (LOW)
6.0A (HIGH)
- Usable temperature range : -10°C ~ +60°C (14°F ~ 140°F)
- Frequency stability : ±10ppm (-10°C ~ +60°C)
- Dimensions : IC-228H 140(W) x 50(H) x 159(D) mm
5.5(W) x 2.0(H) x 6.3(D) inches
IC-228A/E 140(W) x 50(H) x 137(D) mm
5.5(W) x 2.0(H) x 5.4(D) inches
(Projections not included)
- Weight : IC-228H 1.1kg (2.4lbs) IC-228A/E 0.85kg (1.9lbs)

■ TRANSMITTER

- Output power : IC-228H 45W (HIGH), 5W (LOW)
IC-228A/E 25W (HIGH), 5W (LOW)
- Modulation system : Variable reactance frequency modulation
- Max. frequency deviation : ±5kHz
- Spurious emission : Less than -60dB
- Microphone impedance : 600Ω

■ RECEIVER

- Receiver system : Double-conversion superheterodyne
- Intermediate frequency : 1st 17.2MHz 2nd 455kHz
- Sensitivity : 0.18μV for 12dB SINAD
- Selectivity : More than 15kHz/-6dB Less than 30kHz/-60dB
- Audio output power : More than 2.4W at 10% distortion with an 8Ω load.
- Audio output impedance : 8Ω

All stated specifications are subject to change without notice or obligation.

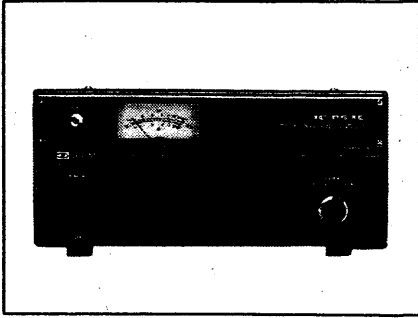

IC-PS30
AC POWER SUPPLY
13.8V 25A

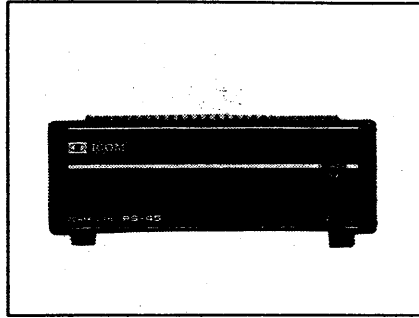

PS-45
AC POWER SUPPLY
13.8V 8A
The OPC-102 cable must be purchased separately to connect the IC-228A/E with the PS-45.

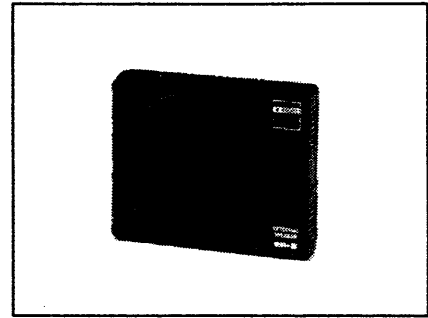

SP-8
EXTERNAL SPEAKER

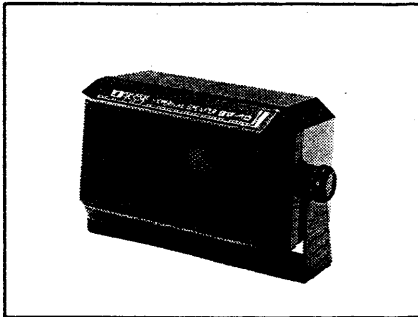

SP-10
EXTERNAL SPEAKER

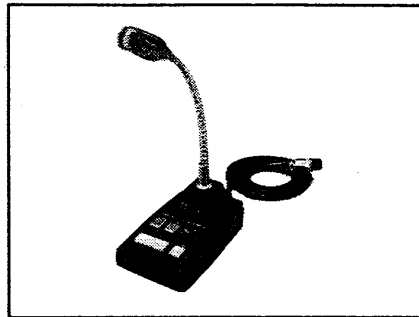

SM-8
DESK MICROPHONE

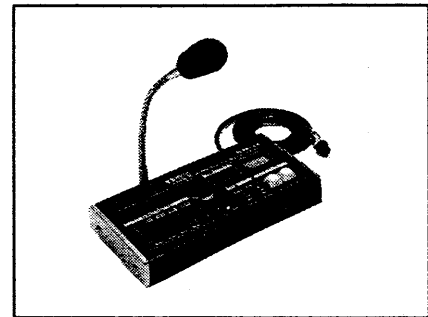

SM-10
COMPRESSOR/GRAPHIC
EQUALIZER DESK TOP
MICROPHONE

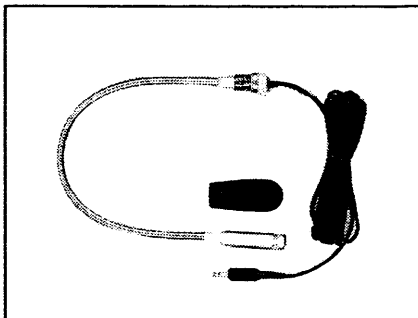

HS-15
FLEXIBLE MOBILE
MICROPHONE

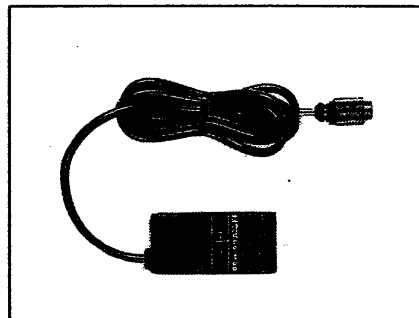

HS-15SB
SWITCHBOX FOR
HS-15

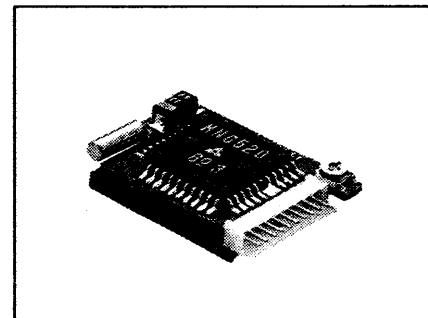

UT-40
TONE SQUELCH UNIT

HM-16	SPEAKER-MICROPHONE
HM-17	SPEAKER-MICROPHONE (Tone call switch included)
WR-200	SWR & POWER METER (1.8 ~ 150MHz, max. 200W)

Count on us!

