



DRAKE

OPERATOR'S MANUAL



MODEL SSR-1
COMMUNICATIONS RECEIVER

R. L. DRAKE COMPANY Miamisburg, Ohio U. S. A.



LIMITED WARRANTY

R. L. DRAKE COMPANY warrants to the original purchaser that this product shall be free from defects in material (except tubes and RF output transistors) or workmanship for ninety (90) days from the date of original purchase.

During the warranty period the R. L. DRAKE COMPANY or an authorized Drake service facility will provide free of charge both parts (except tubes and RF output transistors) and labor necessary to correct defects in material or workmanship.

To obtain such warranty service, the original purchaser must:

- (1) Complete and send in the Warranty Registration Card.*
- (2) Notify R. L. DRAKE COMPANY or its nearest authorized service facility, as soon as possible after discovery of a possible defect, of:
 - (a) The model number and serial number, if any;*
 - (b) The identity of the seller and the approximate date of purchase;*
 - (c) A detailed description of the problem, including details on the electrical connection to associated equipment and the list of such equipment.**
- (3) Deliver the product to the R. L. DRAKE COMPANY or the nearest authorized service facility, or ship the same in its original container or equivalent, fully insured and shipping charges prepaid.*

Correct maintenance, repair and use are important to obtain proper performance from this product. Therefore, carefully read the Instruction Manual. This warranty does not apply to any defect that R. L. DRAKE COMPANY determines is due to:

- (1) Improper maintenance or repair, including the installation of parts or accessories that do not conform to the quality and specifications of the original parts.*
- (2) Misuse, abuse, neglect or improper installation.*
- (3) Accidental or intentional damage.*

All implied warranties, if any, terminate ninety (90) days from the date of the original purchase.

The foregoing constitutes R. L. DRAKE COMPANY'S entire obligation with respect to this product, and the original purchaser and any user or owner shall have no other remedy and no claim for incidental or consequential damages. Some states do not allow limitations on how long an implied warranty lasts or do not allow the exclusion or limitation of incidental or consequential damages, so the above limitation and exclusion may not apply to you.

This warranty gives specific legal rights and you may also have other rights which vary from state to state.

R. L. DRAKE COMPANY
540 Richard Street • Miamisburg, Ohio 45342





INTRODUCTION

The SSR-1 Receiver provides precision tuning over the short wave spectrum of 0.5 to 30 MHz with capability of reception of AM (amplitude modulated), CW (continuous wave) and SSB (upper and lower single side band) signals.

A synthesized/drift cancelling 1st mixer injection system giving 30 tunable ranges from 0.5 to 30 MHz is derived from a single 10 MHz crystal oscillator providing frequency stability necessary for SSB operation.

A stable low frequency VFO tunes each of the 30 - one MHz ranges with a dial accuracy of better than 5 kHz which is sufficient to locate and identify a station whose frequency is known.

Separate detectors (product and diode) are used to provide for best performance whether listening to SSB or AM signals. Narrow band selectivity for SSB and wide band selectivity for AM reception is provided.

The SSR-1 has a built in telescopic antenna or may be connected to an external antenna for better results. The sensitivity of the receiver is such that it operates near the thermal limit and when using the telescopic antenna the performance reaches external noise limits.

A manual tuned preselector provides for maximum sensitivity and maximum interference rejection.

Solid state circuitry is utilized throughout the receiver design allowing efficient operation from the built in battery supply or from an external DC or AC power source.

The SSR-1 will bring you many hours of enjoyment when you discover the quality, ease of operation and usage possible with your receiver. The more serious or international radio listener will obtain maximum enjoyment from the SSR-1 with help from more detailed manuals such as the "World Radio TV Handbook" and "Short Wave Listener's Handbook".

AVAILABLE ACCESSORIES

1. Headphones
2. DC Power Cord
3. World Radio-TV Handbook
4. Short Wave Listener's Handbook

The above accessories are available from the
R. L. DRAKE COMPANY
540 RICHARD STREET
MIAMISBURG, OHIO 45320

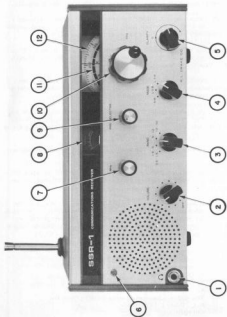

FIG. 1

FRONT PANEL CONTROLS & INDICATORS

1. **PHONE JACK.** For car phone reception or external speaker (8 ohms). Insertion of phones or speaker jack disconnects internal speaker.
2. **OFF - VOLUME.** Turns radio on and off and adjust audio output level.
3. **BAND.** Selects the proper range of received frequency.
4. **MODE.** Selects mode of reception. AM (amplitude modulation), USB (upper single side band) and LSB (lower single side band). CW (continuous wave) may be received on either USB or LSB position. The mode selector selects the proper detector (product detector for SSB and diode detector for AM) and IF selectivity filter.
5. **CLARIFY.** Provides ultra fine frequency adjustment (approximately ± 3 kHz range). This control is used primarily on SSB and CW signals for setting the pitch or sound accurately after the station has been roughly tuned in. It should be in the center position before any tuning is commenced.
6. **PILOT LAMP SWITCH.** On AC operation the pilot lamps are always lighted. The pilot lamps are normally extinguished on battery operation to conserve battery life. Pushing this momentary action switch turns on the pilot lamps.
7. **MHz.** Tunes the MHz range of the received frequency. This control tunes the smaller inner dial (11) and is adjusted for the center of the desired MHz range.
8. **SIGNAL METER.** Indicates relative RF input signal level.
9. **PRE-SELECTOR.** Adjusts receiver RF tuned circuits for proper reception of signal. This control is tuned for maximum signal or noise at the selected frequency.
10. **kHz.** Tunes the kHz range of the receiver. This control turns the large outer dial (12) and is adjusted for the proper frequency as displayed on the graduations. This dial has a graduated scale from 000 to 1000 and is read as 0 to 1000 kHz or .000 to 1.000 MHz.
11. & 12. **FREQUENCY DISPLAY.** Indicates tuned frequency as explained in paragraph 7 and 10. The inner dial indicates MHz range and the outer dial indicates kHz reading. As an example: 5.750 MHz.



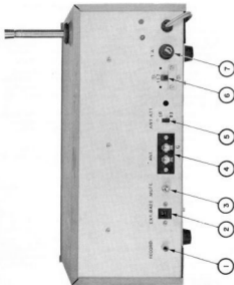

FIG. 2

REAR PANEL CONNECTIONS

1. **RECORD.** Audio output is provided at this jack for tape recorder or other usage. The output is approximately 60 mw RMS at 5000 ohms.
2. **EXTERNAL BATTERY.** Has jack input for operating the SSR-1 from an external 12 volt DC source. Insertion of plug automatically disconnects the internal battery supply. When the AC line cord is plugged in the external battery supply is automatically disconnected. Contact your dealer for proper plug for connecting external battery supply.
3. **MUTE JACK.** A shorted phono connector is normally installed in the MUTE jack. When the shorted connector is removed, the SSR-1 will be muted. This function is used when operating the receiver with a communications type transmitter, (Amateur, CB, etc.)
4. **ANTENNA TERMINAL STRIP.** Has external antenna connection, 75 ohm unbalanced input. See antenna information.
5. **ANTENNA ATTENUATOR.** Local - DX switch provides 20 dB attenuation to received signal when in local position. In most instances the switch should be in the DX position. Switch to LD position when a strong received signal causes interference with other stations. This switch functions only on the external antenna.
6. **POWER SELECT.** Selects proper line voltage operation 117 V AC or 240 V AC.

CAUTION

Switch must be in position that agrees with line voltage. Removal of two (2) screws and locking bar allows selection of proper voltage. Locking bar should always be in place to prevent accidental switch movement.

7. **FUSE.** 1 Ampere.



OPERATING PROCEDURE

The SSR-1 will operate from its internal battery supply, external 12 V DC supply or from a 117 volt or 240 volt AC line. The receivers are wired at the factory for 117 volt and 240 volt operation. Proper voltage is obtained by the switch at the rear panel (see 6 Fig. 2). This switch is locked in either the 117 V or 234 V position and can be changed by removing the two (2) screws holding the lock bar and putting the switch in the desired position.

CAUTION

Check to insure radio supply voltage wiring agrees with line voltage before plugging in line cord. NOTE: With the line plug inserted in the AC supply the radio operates from the AC supply, unplugging the line cord will automatically switch the radio to battery operation. To install batteries remove the finger screws and slide cover off toward rear. Install 6 type 'D' dry cells, carefully noting the proper direction to point each cell.

TURN ON. Turn the SSR-1 on by turning the volume control (2 in Figure 1) clockwise. This control also adjusts the volume and is used to adjust for the desired sound level.

MODE SELECTION. The reception mode AM, CW or SSB is selected by control 4 shown in Figure 1. Select AM position for standard broadcast stations and either USB or LSB for single side band transmission. CW signals are received on either USB or LSB position.

FREQUENCY TUNING. Frequency selection is obtained by operating controls 3, 5, 7, and 10 shown in Figure 1.

- a. Turn clarify control (5) to 0.
- b. Select band switch (3) portion to encompass desired frequency.
- c. Turn MHz control (7) to select desired MHz range as read on smaller dial (11).
- d. Tune kHz control (10) to read proper frequency in kHz as read on the larger dial (12).

Following this procedure will properly select the desired frequency of reception and by adjusting the pre-selector (9) for maximum signal or noise will tune the receiver for proper reception. Fine adjustment of the MHz control (7) will sometimes increase the sensitivity. When the desired station is heard fine adjustment of the kHz knob (10) may be used to tune in the station for proper reception. The clarify control (5) may be used for fine tuning a station for good reception. (This control is usually used for proper tuning of SSB or CW signals and is not necessary for AM reception.)

EXAMPLE

Desired signal is AM at a frequency of 1,350 MHz.

1. Turn receiver on. Adjust Volume Control (2) clockwise.
2. Set Mode Control (3) to AM.
3. Set Clarify Control (5) to 0.
4. Set Band Control (3) to 0.5 - 1.5 position.
5. Set MHz Control (7) to read in center of 1 range shown by small dial (11).



6. Tune kHz Control (10) to read 350 on large dial (12) (350 kHz is the same as .350 MHz.)



7. Tune Pre-Selector Control (9) for maximum output signal or noise.
8. Fine adjust MHz Control (7) to obtain maximum signal or noise.
9. Fine tune kHz control (10) for proper sound of signal.
10. Desired output level is adjusted by turning Volume Control (2) clockwise for increased volume.

EXAMPLE

Desired signal is USB at 7,235 MHz.

1. Turn receiver on. Volume Control (2) clockwise.
2. Set Mode Switch (4) to USB.
3. Set Clarify Control (5) to 0.
4. Set Band Control (3) to 5 - 12 position.
5. Set MHz Control (7) to read in center of 7 range shown by small dial (11).
6. Tune kHz Control (10) to read 235 on large dial (12).



7. Tune Pre-Selector Control (9) for maximum output signal or noise.

8. Fine adjust MHz Control (7) to obtain maximum signal or noise.
9. Fine adjust kHz Control (10) for proper sound of signal.
10. Finer adjustment may be made in sound of signal by tuning clarifier control (5).

LSB signals and CW signals are tuned in same manner as described for USB signals. CW signals may be received on either the USB or LSB position of the mode switch (4).

ANTENNAS

BUILT-IN ANTENNA

The SSR-1 has a built-in telescoping antenna which is connected at all times and becomes effective when it is extended to its full length. When the built-in antenna is not in use it should be retracted to its shortest length.

EXTERNAL ANTENNAS

For optimum performance, the SSR-1 should be used with a good external antenna. There are provisions at the rear of the chassis (see 4 in Fig. 2) for connecting an external antenna for improved reception. A ground terminal is provided for use in circumstances where advantageous.

For general frequency coverage, a long wire antenna 50 to 100 feet long and located as high as possible will give good results. For this purpose, an R. L. Drake Company long wire antenna kit MODEL AN-5 is available from your dealer.

A fundamental form of antenna is a wire whose length is approximately equal to half the signal wavelength. This is known as a dipole antenna. The following formula can be used for simple dipole antennas for reception up to 30 MHz.

$$\text{Wire Length (feet)} = \frac{468}{\text{Freq. (MHz)}}$$

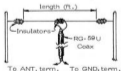

Typical Dipole Antenna. (Erect as High as Possible.)

Further improvement in reception can be realized with the use of more sophisticated antennas. Detailed description of antenna systems may be found in the A.R.R.L. (Amateur Radio Relay League) handbook available at most outlets handling communications equipment such as your SSR-1.

The section on operating hints shows a couple of multi-band antennas that cover popular short wave and amateur bands.



SPECIFICATIONS

Frequency Coverage: 0.5 to 30 MHz in 30 ranges each tunable over 1 MHz range with a dial having 10 kHz graduations.

Reception Modes: CW, USB, LSB, AM.

Sensitivity: At least 10 dB S+N/N under the following conditions:

<u>MODE</u>	<u>FREQ.</u>	<u>INPUT LEVEL*</u>
SSB	0.5 - 2 MHz	1.0 μ V
	2 - 30 MHz	0.3 μ V
AM	0.5 - 2 MHz	3.0 μ V
	2 - 30 MHz	1.0 μ V

(AM: 1000 Hz @ 30% modulation.)

*These voltages are 1/2 the open circuit signal generator voltage, i.e., the voltage read on the meter of a HP Model 606 Generator.

Output: Capable of 200 mw output on SSB at 2 MHz with input signal of 0.5 μ V and 2 Watts output with 5 μ V input.

Audio Distortion: Less than 5% @ 2 Watts.

Calibration Accuracy: Within 5 kHz at all frequencies.

Selectivity:

	<u>BANDWIDTH</u>
<u>MODE</u>	<u>-6 dB</u>
SSB	3 kHz \pm 25%
AM	5.5 kHz \pm 25%

Image Rejection: Greater than 50 dB

IF Rejection: \geq Greater than 50 dB @ f_{sig} below 20 MHz.
Greater than 40 dB @ f_{sig} above 20 MHz.

Antenna: Self contained telescopic whip antenna. External connection to terminal strip. (75 ohm input impedance - unbalanced.)

Audio Output Provisions: Internal 8 Ohm speaker and phone jack on front panel that disables speaker when plugged in.

Muting Provisions: External mute jack (RCA type) that provides normal reception with closed circuit and mute with open circuit connections.

Power Supply: 8 type "D" (1.5 V) dry cell batteries. Tapped transformer to provide operation from 117 V \pm 15% or 240 V \pm 10%-20%, 50-60 Hz source with automatic switch over to batteries when AC line is disconnected.

Current Consumption:	Less than 100 ma quiescent at 12 V DC.
Dial Lights:	Momentary push button to light when on battery operation. Always on for AC operation.
Clarifier:	Tunes minimum of ± 2 kHz and maximum of ± 5 kHz.
Size:	13 in. (33 cm) wide, 11 in. (28 cm) deep, 5.5 in. (14 cm) high.
Weight:	14 lbs. (6.4 kg)

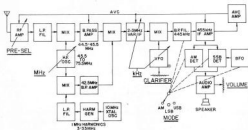

FIG. 3 SSR-1 BLOCK DIAGRAM

OPERATING NOTES

The following information will be helpful in expanding the use of the SSR-1. Listed are frequencies used by various organizations, mode of operation operating hints, typical antennas, etc.

Short Wave Listening (AM Transmissions)

In general most broadcast stations transmit AM (amplitude modulated) signals on the following bands:

<u>MHz Band</u>	<u>Meter Band</u>	<u>Kilohertz</u>
.5-1	187 - 571	525 - 1600
2	120	2300 - 2494
3	90	3200 - 3400
3-9	75	3900 - 4000
4	60	4750 - 5000
5	49	5950 - 6200
7	41	7100 - 7300
9	31	8500 - 9775
11	25	11700 - 11975
15	19	15100 - 15450
17	16	17700 - 17900
21	13	21450 - 21750
25	11	25000 - 26100

Frequencies are normally referred to as kilohertz or megahertz. Kilohertz is equal to 1000 cycles per second and megahertz is equal to 1000 kilohertz. Sometimes frequency is referred to in meters which is a measure of the wave length. Many modern communications receivers are calibrated only in frequency with no markings in meters.

Formulas equating frequency and wavelength are as follows:

$$\text{Wavelength (m)} = \frac{300000}{\text{Frequency (kHz)}} \quad , \quad \text{Frequency (kHz)} = \frac{300000}{\text{Wavelength (m)}}$$

Single Side Band Signals

SSB signals of interest to the general listener occur primarily on the amateur bands and marine bands. The signals found on the Marine bands are either USB or CW while those on the Amateur band may be USB, LSB or CW (occasionally AM). The charts below show frequencies and modes normally used.

<u>Amateur Bands</u>		
<u>Meter Band</u>	<u>Frequency (MHz)</u>	<u>Mode</u>
160	1.8 - 2.0	LSB, CW
80	3.5 - 4.0	LSB, CW
40	7.0 - 7.3 7.3	LSB, CW
20	14.0 - 14.35 14.35	USB, CW
15	21.0 - 21.45	USB, CW
10	28.0 - 29.7	USB, CW

Marine Bands

<u>MHz Band</u>	<u>Frequency (MHz)</u>
4	4,063 - 4,438
6	6,20 - 6,525
8	8,195 - 8,815
12	12,33 - 13,20
16	16,46 - 16,917
22	22,0 - 22,72
25	25,01 - 26,16

Marine services may use USB, CW or AM below 4 MHz.

A very popular communications group is the Citizen Band "Class D" operators. They may use either AM or USB. In the United States they operate between 26,965 and 27,255 and are allocated in 23 discrete channels (typically 10 kHz apart).

Time Signals

Radio time signals from various government agencies are continuously receivable in most parts of the world. WWV from the United States broadcasts on 2,5, 5, 10, 15, 20 and 25 MHz. Time stations from England may be heard on 9,35, 12,79 and 13,555 MHz.

The user will notice a continuous unmodulated signal at each exact multiple of 1 MHz. This is a short coming of this type of receiver design and is not practical to eliminate without making it too expensive for its intended use.

Simple Multiple Band Antennas

The following antennas may be used effectively for reception of several bands. These should be erected as high as possible and connected to the receiver antenna terminals at rear panel by RG-59/U coax cable.

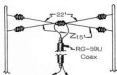

Simple dipole antenna to cover 9, 11, 15 and 17 MHz international broadcast band.

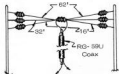

Simple dipole antenna to cover 80, 40, 20 and 15 meter amateur band.

SPURIOUS SIGNALS

Occasionally the adjustment of the MHz control (7) will cause a small "birdie" (interfering signal) to appear at the output. This "birdie" may be eliminated by slight adjustment of the MHz control until the "birdie" disappears. The user will notice a continuous unmodulated signal at each exact multiple of 1 MHz. This is caused by the receiver's internal oscillator and is a shortcoming of the design of this type receiver that would be prohibitively expensive to eliminate. These internal signals are useful in calibration of the internal oscillator by setting its frequency against a time signal. This is performed at the factory. Their signals are also useful to check the accuracy of the KHz dial. With the antenna down and in the USB Mode adjust the clarifier for a zero tone with the KHz dial set at 000 or 1000.

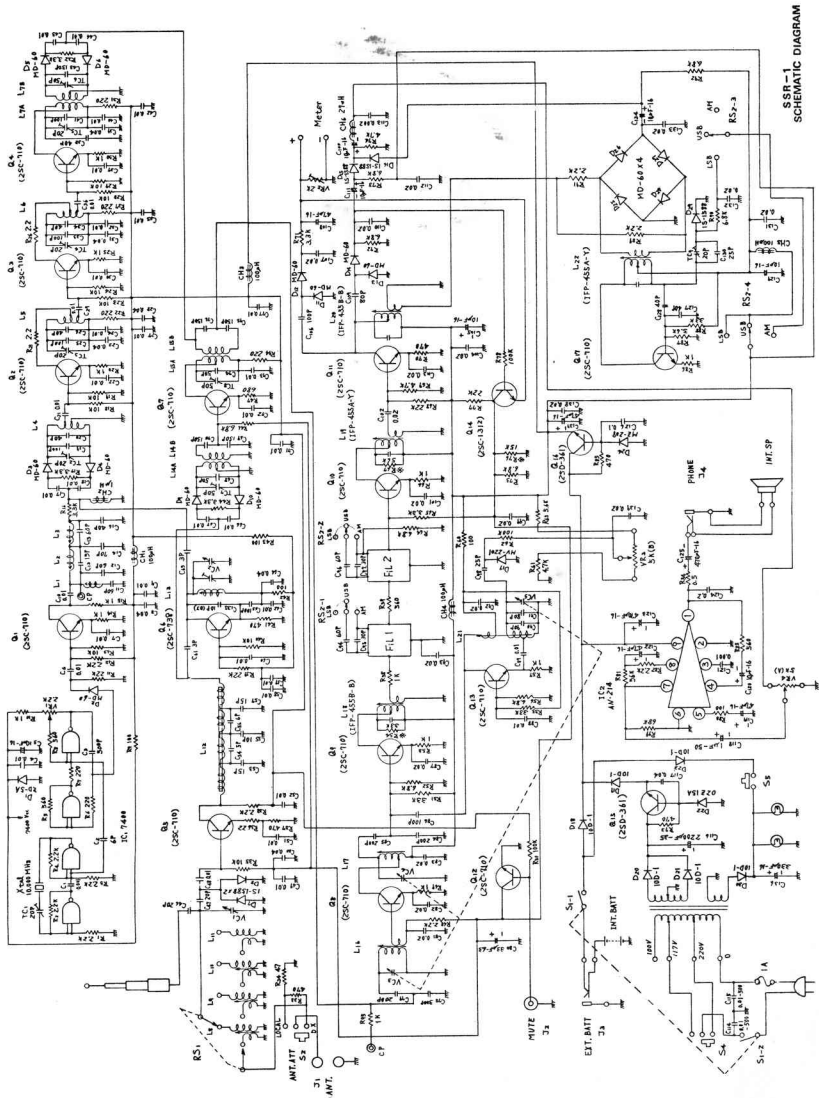



DRAKE AMATEUR PRODUCTS

- R-4C** Receiver, covers the 160 meter through 10 meter amateur bands and up to fifteen additional 500 kHz ranges. It has 8-pole crystal filter selectivity with passband tuning and transceiver with the T-4XC with excellent sensitivity.
- T-4XC** Transmitter, covers the 160 through 10 meter amateur bands and most other frequencies between 1.5 and 30 MHz. It has 8-pole crystal filters for sideband selection. It may be used to transceive with the R-4C.
- TR-4C** Transceiver, 300 Watt high frequency single-sideband unit covers the 80 meter through 10 meter amateur bands. Includes AM and CW modes, a linear, permeability-tuned VFO and two 8-pole crystal lattice filters.
- L-4B** Linear Amplifier, built for continuous duty at full capacity, 2000 Watts PEP on SSB, 1000 Watts on AM, CW and RTTY. Covers the 80 meter through 10 meter bands.
- C-4** Station Console, matches Drake's T-4XC, R-4C and TR-4C.
- MN-4** Antenna Matching Network, matches 50 Ohm transmitter output to coax antenna feedline with VSWR up to 3:1. An integral Wattmeter reads forward power in Watts and VSWR directly. 200 Watts continuous duty output.
- MN-2000** Antenna Matching Network. Same as MN-4 except: 1000 Watts continuous duty output (2000 Watts PEP) and 3 antenna connectors switch-selectable from front panel.
- W-4** Wattmeter, reads forward and reflected power directly in Watts (VSWR from nomograph). Range: 200 and 2000 Watts full scale, 1.8 to 34 MHz.
- WV-4** Wattmeter, reads forward and reflected power directly in Watts (VSWR from nomograph). Range: 100 and 1000 Watts full scale, 20 to 200 MHz.
- TR-22C** Transceiver, 2 meter VHF-FM, portable. Twelve channels, self-contained batteries and attached microphone.
- RCS-4** Remote Coax Switch, provides remote selection of up to five antennas, using only one main feedline. Allows grounding of unused antennas. Motor driven switches controlled from station located console.
- SSR-1** General Coverage Receiver, 0.5-30 MHz continuous. All solid state.

For information on any of our products, please feel free to write our Sales Department, 340 Richard Street, Miamisburg, Ohio 45342 or call direct, 513-866-2421.

