

# OWNER'S MANUAL

# TRC-430 40CH MOBILE CB TRANSCEIVER

Please read before using this equipment

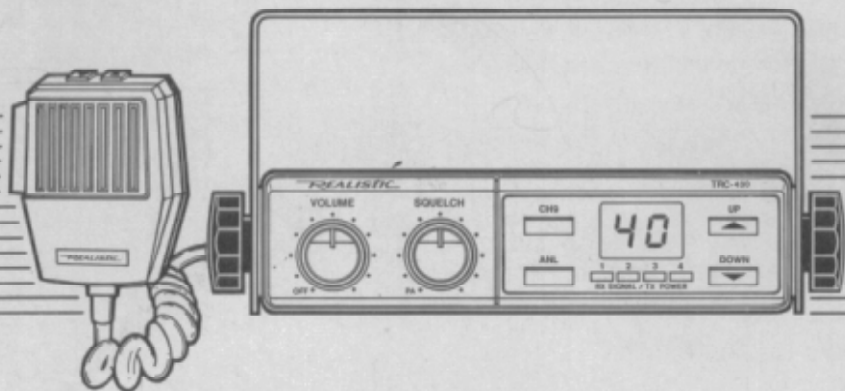

21-1514

**REALISTIC**<sup>®</sup>

---

You can operate your Realistic® TRC-430 Mobile 40-Channel CB Transceiver in your vehicle or as a base station in your home. With the right accessories, the TRC-430 also becomes a public address system.

The built-in 40-channel PLL (phase locked loop) frequency synthesizer uses a precise frequency reference crystal for reliable and exact tuning. Because of Radio Shack®'s rigid design and manufacturing standards, the TRC-430 is sure to provide you with years of reliable service.

## FEATURES

- Two ceramic filters for superior selectivity and freedom from adjacent channel interference.
- Large digital channel display.
- Built-in automatic modulation control.
- Hysteresis-type squelch circuit to compensate for signal fading and eliminate signal chopping in the receive mode.
- Remote speaker terminal.

- Dynamic communications microphone with locking connector and remote channel buttons.
- Automatic noise-limiting circuit.
- RF output power and signal strength meter.
- Instant Channel 9 (emergency) access.
- Universal mounting bracket.

### DOC LICENSE (CANADA)

Before transmitting with your Transceiver, you must obtain a Department of Communications (DOC) General Radio Service license. We provide such an application form with your unit. Complete the form and mail it with the appropriate fee to the address on the form.

DOC Approval Number: \_\_\_\_\_

**NOTE:** Units manufactured for sale and use in Canada are not identical to units type accepted by the FCC. Canadian models have been approved by DOC and are to be used only in Canada.

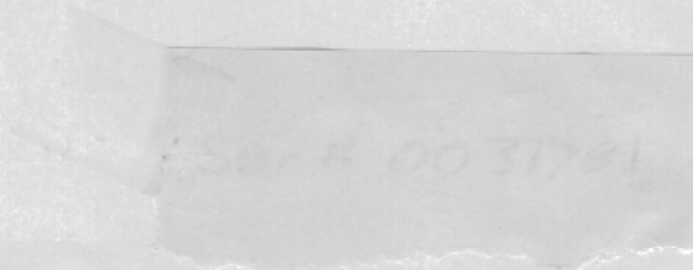

Copyright 1988, InterTAN Canada Ltd.  
All Rights Reserved.

Realistic and Radio Shack are registered trademarks of Tandy Corporation.

# CONTROL LOCATIONS

HOA JAT 201

## FRONT PANEL

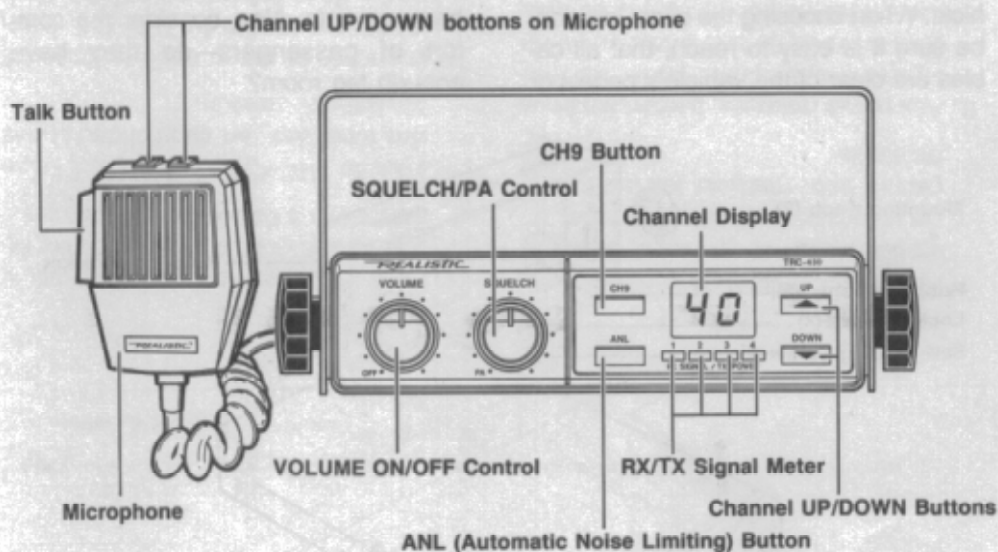

## REAR PANEL

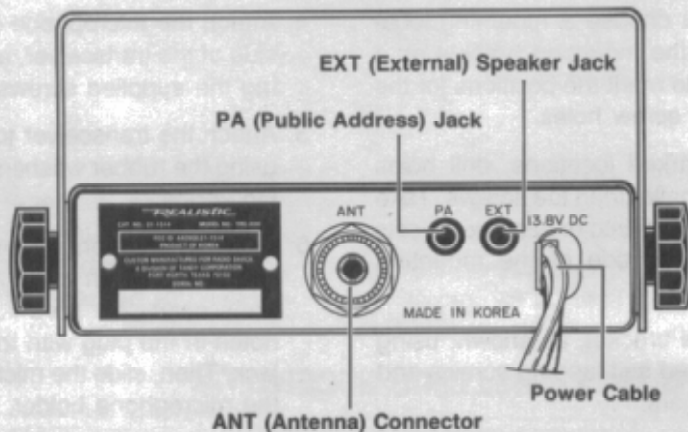

# INSTALLATION

## MOUNTING THE TRANSCEIVER

The most common mounting location for this CB is under the dashboard of a vehicle. When choosing the exact location, be sure it is easy to reach, that all cables are clear of the vehicle's pedals or

other moving parts, and that the transceiver is not directly in the path of the heating vents. Also, consider the comfort of passengers—do they have enough leg room?

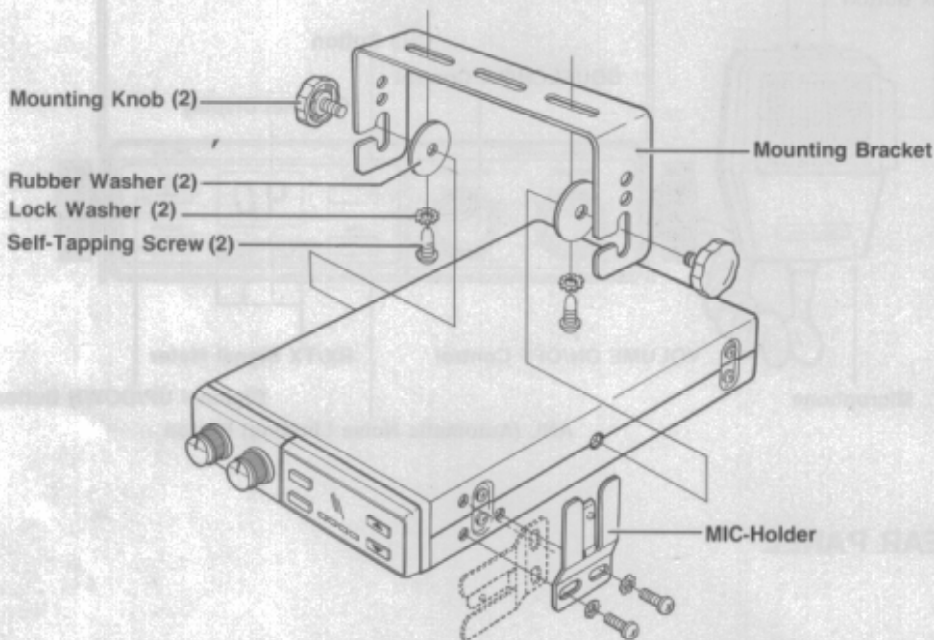

1. Once you choose a mounting location, use the mounting bracket as a template to mark the positions for the mounting screw holes.
2. In the marked locations, drill holes slightly smaller than the screws. Take care not to drill into or damage objects on the back side of the mounting surface.
3. Attach the bracket, as shown, using the supplied self-tapping screws and lock washers.
4. Attach the microphone holder to the side of the transceiver, as shown, using the supplied screws.
5. Attach the transceiver to the bracket using the rubber washers and mounting knobs.
6. Plug the microphone into the microphone jack on the side of the transceiver—be sure to match the notch in the plug with the one in the jack. Then, slide the microphone onto the microphone holder.

---

## INSTALLING THE ANTENNA

There are many different types of CB antennas for use with mobile CB radio. Each type has benefits, and you should choose the one that best meets your needs and personal preference. Some of the most popular types are shown and briefly described on the following two pages.

### Gutter or Trunk-Lid Antennas—

These types of antennas clamp onto your vehicle, so you don't have to drill holes to mount them. Their coverage patterns are slightly directional (toward the side of the vehicle they are mounted on). The gutter antenna has a slightly better range than the trunk-lid antenna simply because it is usually mounted higher on the vehicle.

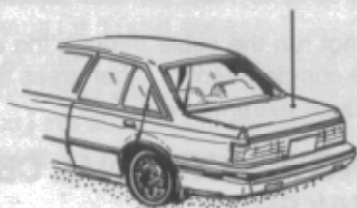

**Magnetic Antenna**—As the name implies, this type of antenna has a strong magnet that attaches the antenna to your vehicle. You can attach a magnetic antenna to any flat metal surface. A magnetic antenna is great for temporary installations, but you can use it for perma-

nent installation, too. Its greatest benefit is that you can mount it at the center of the vehicle's roof (the best place for optimum performance) without drilling holes.

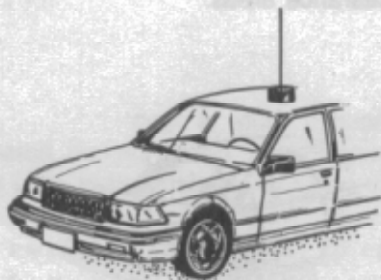

**Roof Antenna**—This type of antenna radiates the signal equally in all directions and provides optimum range because it is usually at the highest point on the vehicle. In spite of these facts, the roof antenna is not preferred because you must drill a hole in the roof of your vehicle to mount it.



**Bumper Antenna**—This type of antenna is a 102-inch,  $\frac{1}{4}$ -wave antenna that clamps onto your bumper. Its signals pattern is slightly directional (toward the side of the vehicle it is mounted on). Because of its length, this type of antenna usually provides excellent performance, but the length can also be a problem in low-clearance areas.



**Combination AM/FM/CB Antenna**—This type of antenna provides signals for your AM/FM radio as well as the CB. Some people prefer this type of antenna because it eliminates the need for an extra antenna on their vehicle. The performance of this type of antenna is adequate but is not as good as a “dedicated” CB antenna.

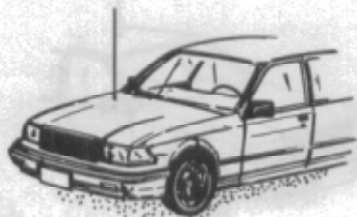

Other general considerations for antenna installation are:

- Mount the antenna as high possible on the vehicle.
- Mount the antenna as far as possible from other radio antennas.
- For optimum performance, the antenna should be vertical during CB operation.

Once you choose an antenna, mount it following the instructions that come with the antenna. Then, route the cable to the transceiver's location and connect the cable to the ANT terminal on the back of the transceiver. Observe the following precautions when routing the antenna cable:

- Avoid sharp edges or moving parts that might damage the cable.
- Do not run the cable next to power cables or other radio antenna cables.
- Do not run the cable through the engine compartment or other areas that produce extreme heat.

## USING AN EXTERNAL CB SPEAKER

You can connect an external CB speaker to the TRC-430 if the transceiver is mounted so that the internal speaker is difficult to hear. Use an 8-ohm speaker with a  $\frac{1}{8}$ -inch plug, such as Radio Shack Cat. No. 21-549. Insert the plug into the EXT jack on the back of the transceiver.

## CONNECTING POWER

**Caution:** The TRC-430 is designed for connection to a 12-volt, negative ground power system in your vehicle. This is the most common type of electrical system for vehicles, but determine the type of

electrical system your vehicle has before you make the power connections. The red, white, and black wires provided with your CB are for power connections.

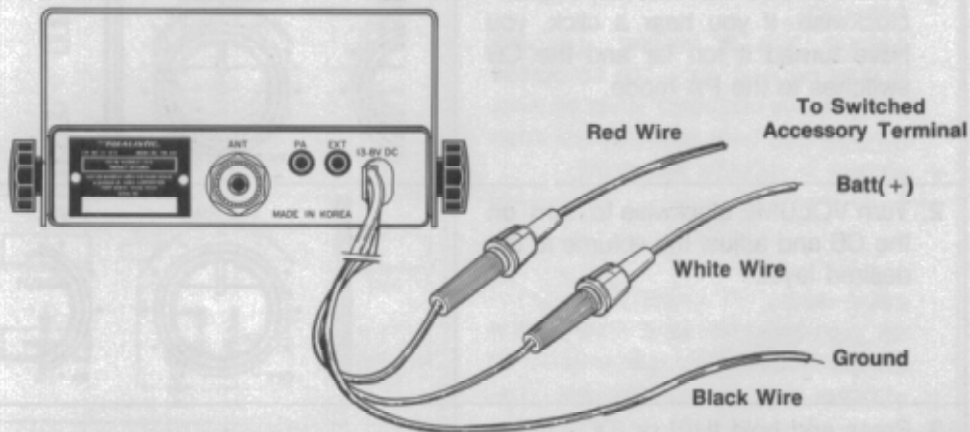

1. Connect the red wire (with in-line fuse holder) to a fuse box terminal that provides power only when the ignition is set to ON or ACC.
2. Connect the white wire (with in-line fuse holder) to a fuse box terminal that provides power at all times, regardless of the ignition setting.

3. Connect the black wire to a metal part of the vehicle's frame (chassis ground).

**Note:** Modern vehicles have many non-metallic parts. If you connect the black wire to one of these parts or if one of these parts insulates the black wire from the vehicle's chassis, the CB will not work.

## WARNING

**Do not open up the Transceiver to make any internal adjustments.**

A C.B. unit is set up to transmit a regulated signal on an assigned frequency. It is against the law to alter or adjust the settings inside the unit to exceed these limitations. Any adjustments to a C.B. rig must be made by a qualified technician using the proper test equipment.



### TO BE SAFE AND SURE:

1. You should never open up the case of your Transceiver.
2. Never change or replace anything in your Transceiver.

## OPERATION

**Caution:** Do not attempt to use your CB unless a suitable antenna is connected to it. See "Installing the Antenna."

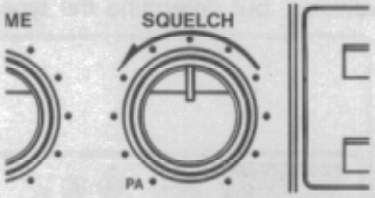
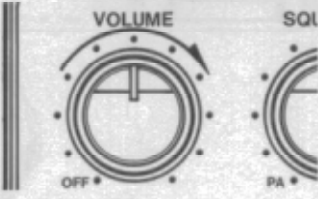
### RECEIVING

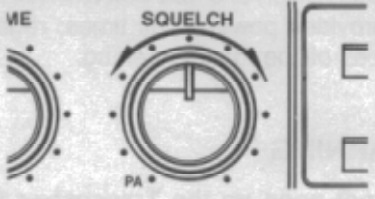
<p>1. Turn SQUELCH almost fully counter-clockwise. If you hear a click, you have turned it too far and the CB switches to the PA mode.</p>	
<p>2. Turn VOLUME clockwise to turn on the CB and adjust the volume to the desired level.</p>	
<p>3. Press and hold [UP] or [DOWN] on the microphone (or on the transceiver) until the desired channel appears on the display.</p>	
<p>4. Adjust SQUELCH so that you hear normal voice transmissions but do not hear background noise when voice transmissions are not present. See "Setting the SQUELCH Control."</p>	



## TRANSMITTING

SETTING THE SQUELCH

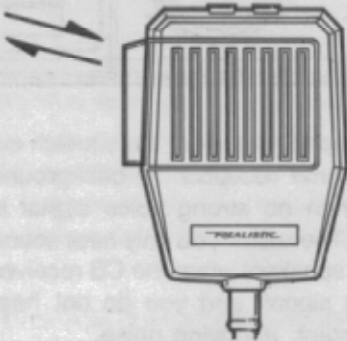
<p>1. Press and hold [UP] or [DOWN] on the microphone (or on the transmitter) until the desired channel appears on the display.</p>	
<p>2. Press the talk button on the microphone, and hold the microphone 2 or 3 inches from your mouth as you speak in a normal voice.</p>	
<p>3. Release the button to receive.</p>	

### Using the CH9 Button

For emergencies, press the red [CH9] button to the *in* position. This immediately switches the transceiver to Channel 9, which is reserved for reporting emergencies. In most areas, Channel 9 is monitored 24 hours a day by CB clubs or government agencies.

To return to normal operation, press [CH9] again to release it to the *out* position.

### Using the ANL Circuit

Your TRC-430 has a built-in noise limiting circuit. To activate this circuit, press [ANL] to the *in* position. To deactivate the circuit, press [ANL] again to release it to the *out* position.

### Using the RX/TX Meter

The meter indicates the strength of the signal you are receiving (RX) or the signal you are transmitting (TX), depending on the current operation mode of your CB. A built-in AMC (automatic modulation control) circuit prevents your transmitter signal from over-modulating and distorting.

## SETTING THE SQUELCH CONTROL

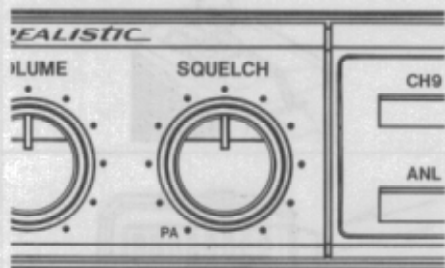

When properly adjusted, the squelch circuit prevents reception of background noise when no strong voice signal is present. Therefore, you only hear sound from the speakers when the CB receives a strong signal, and you do not hear the constant, annoying noise.

For normal operation, adjust the SQUELCH control so that you do not hear anything unless a strong voice signal is present.

To receive very weak signals, set the SQUELCH control as far counter-clockwise as it will go without *clicking* to the PA mode. With this setting, you hear all the background noise but you also hear weak voice signals that you would not hear with a normal SQUELCH setting.

## USING THE PA AMPLIFIER

Your TRC-430 has a built-in PA (public address) amplifier. You can use it, along with an optional PA speaker, to turn your CB into a mobile public address system. To use the PA amplifier:

1. Connect an external PA speaker to the PA jack on the back of the transceiver. The speaker should be at least 6 feet from the transceiver.

**Note:** The PA speaker jack is separated from the external speaker for the CB.

2. Rotate the SQUELCH control counter-clockwise until it clicks into the PA position.
3. Press and hold the microphone's talk button, and hold the microphone 2 or 3 inches from your mouth as you speak in a normal voice.
4. Adjust the VOLUME control for the desired level. If you hear high-pitched squeals, reduce the VOLUME setting until the squeal stops.

## CB COURTESY

Remember these hints when using your CB:

- Wait for a pause in transmission before asking for a break.
- If you do not receive an answer after two calls to a station, sign off and allow others to use the channel. Try again later.
- Do not hold down the talk button ("dead key") when you are not talking.
- Assist callers with directions, road conditions, or other requested information.

## USING THE TRC-430 AS A BASE STATION

Although the TRC-430 is designed for mobile use, you can also use it as a CB base station. For this type of installation, you need:

- 12-volt DC power supply (such as Cat. No. 22-120).
- Base station antenna (such as Cat. No. 21-967).
- External 8-ohm speaker (such as Cat. No. 21-549).

Mount the antenna and speaker as described in their instruction manuals

and connect them to the proper jacks on the back of the TRC-430 transceiver.

Connect the red and white power cables to the positive (+) terminal of your power supply. Connect the black wire to the negative (-) terminal of the power supply.

Operation of the CB is the same whether it is installed as a base station or as a mobile unit.

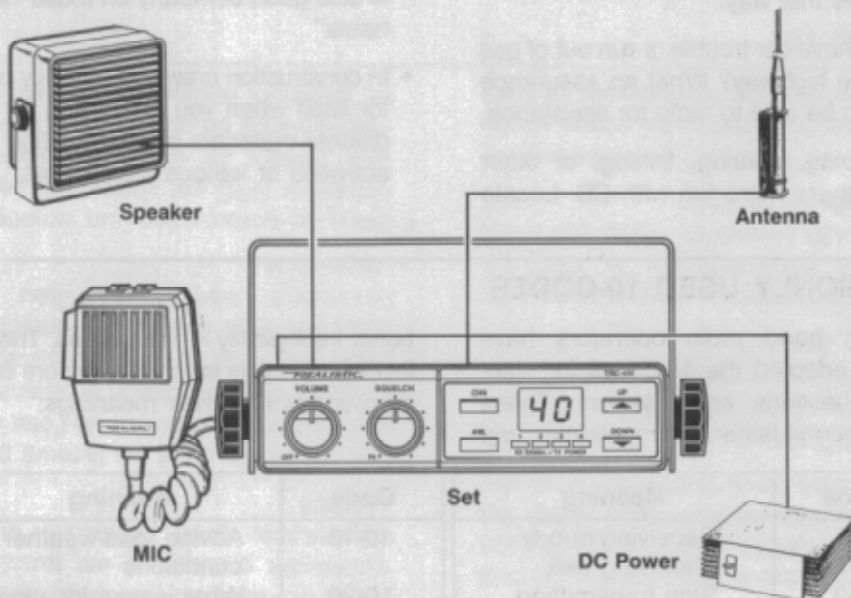

**Warning:** When installing or removing CB base station antennas, use extreme caution. If the antenna starts to fall, let it go. It could contact overhead power lines. If it does, contact with the antenna, mast, cable, or guy wires can cause electrocution and death. Call the power company to remove the antenna. DO NOT attempt to do so yourself.

## COMMON USES FOR A CB RADIO

### Personal Uses:

- Keep in touch with home while driving to work, to the store, or to a social activity. Let your family know you are tied up in traffic or that you will stop by the market on the way home.
- If you are a two-car (or more) family, CB units are great for communicating with members of your family while they are in their cars.
- Contact friends and neighbors—find out “what’s happening” or plan a get-together. You can even meet new friends this way.
- Ever have car trouble or run out of gas on the highway? What an assurance it is to be able to radio for assistance.
- Camping, hunting, fishing, or other sports are more fun with CB. Locate

a buddy or find out “what’s cooking back at camp”.

- Use the PA amplifier for calling companions on outings, at truck stops, and so on.

### Business Uses:

- For security policemen, a 2-way radio is more than a convenience; it is a must for both safety and efficiency.
- Truckdrivers and deliverymen learn road and traffic conditions and obtain assistance in locating destinations. CB is also good company on those “long hauls”.
- In construction crews, CB quickly pays for itself when you are calling for additional materials or coordinating the activities of various work crews.

## COMMONLY USED 10-CODES

Citizens band radio operators have largely adopted the 10-codes for standard questions and answers. These codes permit faster communication and

better intelligibility in noisy areas. The following table lists some of the more common codes and their meanings.

Code	Meaning	Code	Meaning
10-1	Receiving poorly	10-13	Advise road/weather conditions
10-2	Receiving well	10-20	What is your location!
10-3	Stop transmitting	10-33	Emergency traffic
10-4	OK	10-36	Correct time
10-7	Out of service	10-41	Switch to channel
10-8	In service	10-62	Cannot understand
10-9	Repeat		
10-10	Standing by		

Because your CB transceiver is exceptionally quiet, any noise you hear is probably from an external source in your vehicle—the ignition, another radio, spark plugs, and so forth.

To solve the problem you must go to the source of the noise. You can determine the source of the noise by turning off the engine and operating the CB with the ignition set to ACC. If most or all of the noise goes away, the problem is in your vehicle's ignition or electrical system. Here are a few hints to help you reduce or eliminate such noise:

- Make all CB power and antenna wire as short as possible.
- Do not route the power wires next to antenna wires.

- Be sure that the ground connection (black wire) is secure.
- Replace old ignition wires with new, high-voltage, noise-suppression wires.
- Install noise suppressors on your spark plugs, or install new spark plugs that have built-in suppressors.
- If problems persist, check your alternator/generator and regulator gauges. Noise from these sources can be reduced or eliminated using bypass capacitors at the various output voltage points.

Your local Radio Shack store has a wide selection of noise-suppression accessories.

## MAINTENANCE AND PROBLEM SOLVING

---

Your transceiver is a fine example of electronic engineering and construction.

The following suggestions will help you care for your CB so that you can enjoy it for years. If at any time you suspect that your unit is not performing as it should, refer to the following and see if you can eliminate the problem. If the problem persists, take the unit to your local Radio Shack store. Our personnel can assist you and arrange for service if needed.

Keep the transceiver dry. If it does get wet, wipe it off immediately. Water contains minerals that can corrode electronic circuits.

1. If you experience trouble while receiving.
  - Check the VOLUME On/Off switch setting.
  - Be sure SQUELCH is adjusted properly. Is it over-squelched?
  - Check if the unit is switched to an operating channel.
  - Check if the microphone is securely connected.
  - Check for a good antenna connection.
2. If you experience trouble while transmitting.
  - Check if the transmission cable is securely connected to the antenna connector.
  - Check if the antenna is fully extended for proper operation.
  - Are all connections secure and free of corrosion?
  - Be sure you are fully pressing the talk button on the microphone.
  - Be sure the microphone connector is firmly pressed into its jack.
3. If the transceiver is completely inoperative.
  - Check the DC power cord and in-line fuse.
  - Replace the fuse with an identical 2 amp fuse only.
  - Check connection of the white wire and the in-line fuse. (Replace fuse with an identical 1-amp type).

If these checks don't solve the trouble, do NOT attempt repairs or adjustments yourself. The unit should only be serviced by a qualified radio technician. Whenever possible, return the unit to the store from which it was purchased.

# SPECIFICATIONS

---

## Receiver

Frequency Coverage	: All 40 CB Channels 26.965 to 27.405 MHz
Sensitivity	: 0.7 $\mu$ V or better for 10dB (S + N)/N
Adjacent Channel Rejection	: 60dB (at 10kHz)
Intermediate Frequency	: 1st IF = 10.695 MHz, 2nd IF = 455 kHz
Audio Output	: 4 watts (max)
Frequency Response	: 450—2500 Hz
Cross Modulation	: 50dB (or better)
Squelch	: Adjustable from 0.6 $\mu$ V to 1mV

## Transmitter

Frequency Coverage	: All 40 CB Channels (class D) 26.965 to 27.405 MHz
Power Output	: 4 watts (maximum 5 watts input power)
Emission	: A3E
Modulation Capabilities	: +90%, -90%
Spurious Radiation	: Less than -65dB
Frequency Tolerance	: Better than 0.002%
Antenna Impedance	: 50 ohms
Current Drain (13.8 volt supply)	: 1000mA (no modulation) 1500mA (full modulation)

**RADIO SHACK CANADA LIMITED WARRANTY**

This product is warranted against defects for ninety (90) days from the date of purchase from Radio Shack company-owned stores and authorized Radio Shack dealers. Within this period Radio Shack will repair the product without charge for parts and labour. Simply bring your Radio Shack sales slip as proof-of-purchase date to any Canadian Radio Shack store. Warranty does not cover transportation costs. Nor does it cover a product subjected to misuse or accidental damage.

EXCEPT AS PROVIDED HEREIN, RADIO SHACK MAKES NO WARRANTIES, EXPRESS OR IMPLIED, INCLUDING WARRANTIES OF MERCHANTABILITY AND FITNESS FOR A PARTICULAR PURPOSE.

This warranty applies to products purchased from Radio Shack Canada. This gives you specific legal rights and you may have other rights which will vary from province to province.

**WE SERVICE WHAT WE SELL**

RADIO SHACK DIVISION, INTERTAN CANADA LTD

**CUSTOM MANUFACTURED FOR  
RADIO SHACK DIVISION, InterTAN CANADA LTD.  
BARRIE, ONTARIO, L4M 4W5**