

**MIDLAND**  
precision series   
keeping you way out front.



# 6001

## OWNER'S MANUAL

40-channel single-sideband CB transceiver.

## **Midland 6001**

**Precision Series™ 40-channel single-sideband citizens band transceiver.**

For your protection, the spaces below are provided for you to record the FCC Data and Serial Number of this product. Both are located on the identification plate attached to the rear cabinet panel. After recording these numbers, keep this record for future reference. *When contacting Midland for service or parts information, the FCC Data Number and Serial Number must be referred to in order to expedite your request.*

FCC Data: \_\_\_\_\_

Serial Number: \_\_\_\_\_

# Welcome to the world of Midland Precision Series Single-Sideband CB.

Congratulations. You've just graduated to the state of the art in mobile CB privacy, power, clarity and operating convenience.

A major advance in the history of personal communications, single-sideband CB, in effect, triples the number of bands on which you can communicate.

SSB splits each channel into three (an upper and lower sideband, in addition to standard AM), to give you the greatest degree of privacy available in CB.

In the years ahead, you can expect to realize — time and time again — the real reasons and meaning of the front-running position Midland holds among CBers everywhere.

And you'll come to know that Midland Power is more than just a slogan, but the heading of a long list of hearable, seeable benefits.

Like controls designed and located for maximum convenience and ease of operation.

And like the assurance that comes from knowing the nationwide Midland service network goes with you everywhere you take and use your Midland SSB.

As your Midland SSB experience unfolds and grows, we hope you'll remember that CB Radio is only one kind of electronic excellence available under the Midland nameplate.

Remember that the same dependability, range and clarity engineered into your SSB are also built into a long, versatile line of Midland car stereo receivers, tape players and accessories.

Including widely-acclaimed, exclusive Midland Micro-Precision™ AM/FM/MPX electronic tuning. The one that's so microprecise, it seeks out and locks exactly on the station signal.

And keep your eyes and ears on the popular line of Midland television sets. The color and black-and-white sets that give you the quality features you want at some of the most attractive prices in the industry.

# Contents

Midland 6001 features	Pages 5-6
Installation Instructions	Page 7
Accessories included	Page 7
Location selection	Page 7
Mechanical mounting	Page 8
Power wiring	Page 8
Microphone hanger	Page 9
Optional remote speaker	Page 9
Optional Public Address Speaker	Page 9
Antennas	Page 10
Selection (minimum requirements)	Page 10
Effect of location on performance	Page 10
Installation	Page 10
Tuning	Page 10
Operating instructions	Page 11
Operating controls, connectors:	
Functions and uses	Pages 12-13
FCC requirements	Page 14
Forms included and how to use	Page 14
General CB information	Page 14
Channel 9 usage	Page 15
10-Code usage	Page 15
Channel frequency chart	Page 16
Range	Page 16
Noise	Page 16
Trouble-shooting aids	Page 17
Noise suppression	Page 17
Common problems and solutions (chart)	Page 18
Technical specifications	Page 18
Written specifications	Page 18
Circuit diagram	Pages 19-20-21



# Midland 6001

Precision Series™ 40-channel  
single-sideband mobile  
CB transceiver.

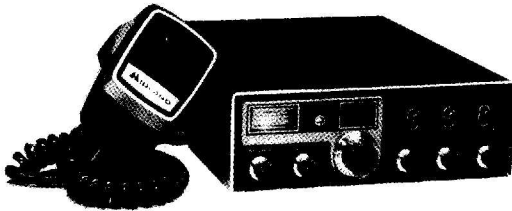

## Features:

Your new Midland mobile CB is engineered to give you the most convenient operation possible.

No other design aspect has been given more attention than the time- and motion-saving features built into your new radio, microphone and mounting system.

You'll find and enjoy the benefits of this attention to detail all across the control panel — including the panel itself.

Also, all corners, knobs and other protuberances are machine-radiused to cushion impacts and prevent snags.

Not the cheapest way to finish a hardworking piece of equipment, but we think it's the best.

**Green-color LED digital channel readout.** Green is the most easily seen and readable color an electronic display can have. Gentle on your eyes, it focuses instantly to the eye, as traditional red-color readouts can't.

For added ease and convenience, your Midland LED readout is coupled with an analog numbered dial, to tell you which way is "up" and which way is "down" the channel spectrum.

**High-visibility, black-on-white meters.** Think about it. If white letters on a black background were easiest to read, all newspapers, magazines and books would be printed that way — as are many other CB meters on the market.

Midland meters are meant to be seen and read. Instantly. So your new

Midland CB has a high-visibility black-on-light green meter that won't have you squinting as you drive 55 miles an hour down a sun-glaring or darkened highway.

**Exclusive beveled touch-control knobs.** Your Squelch, AF Gain, RF Gain and other control knobs are angled and notched. This way you can control exact settings at a finger touch.

In other words, you don't have to take your eyes off the road to make corrections. You can do it quickly, just by "feel."

You'll also note that all your most frequently-used controls are located on the driver's side of the panel, for quick, convenient access.

And that the panel itself is designed to prevent glare.

**Anatomically-designed microphone.** The product of a long, costly design program, your new Midland CB mike is shaped to specifically and precisely fit the configuration of your hand.

Comfortable to hold, this design makes Midland microphone operation a natural, motion-saving convenience.

**Adjustable mounting bracket.** This design makes it easy to mount and remove your new CB for the safety and security of both your car and radio.

The tilt/pivot adjustable feature lets you position your CB at any angle or height that's most convenient and comfortable for you.

# Midland Precision Series 6001 Mobile CB Operating Controls.



# How to install your Midland mobile CB.

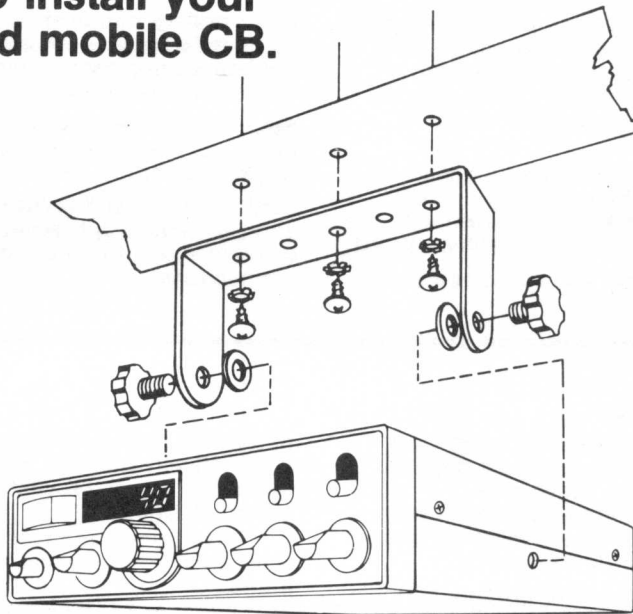

This transceiver may be installed in any **12-volt negative or positive ground-system** car or truck. Most current U.S. and foreign vehicles use a negative system, but some older models and some newer large trucks may have a positive ground.

**Check the requirements for your vehicle before you begin installation.**

Generally, you have a **negative-ground** system if the minus (-) battery terminal is connected to the motor block. Contact your dealer in the event you are unable to determine your vehicle's polarity system.

## **Installation and operating accessories furnished with your Midland Mobile CB:**

1. Adjustable mounting bracket system.
2. Microphone bracket system.
3. All main-unit and microphone mounting hardware needed for normal installation.
4. DC power cord with plug.
5. Plug-in microphone with coil cord.

6. FCC Form 505.
7. FCC Part 95, Subpart D.
8. FCC Form 555-B.
9. Owner's Manual.
10. Customer Registration Card.

## **Where to locate your CB transceiver.**

Your new Midland CB is designed to be installed under the dash of your vehicle.

Safety and convenience are the primary considerations in deciding exactly where to locate your radio.

The transceiver is designed with most-often-used controls nearest the driver. Still, make sure other controls are easily reached.

**Caution: Be sure that the unit is located so that it does not interfere with the driver or impair access to any controls. Connecting cables must be routed and secured in such a manner as not to interfere with the operation of the brake, accelerator or other controls. Interference from either the unit or connecting cables may contribute to the loss of control of the vehicle.**

## Mechanical mounting.

**Step 1:** Heeding the preceding caution, use the mounting bracket as a template for marking the location of screwholes under your dash. Use an awl, nail or other pointed object to mark the metal.

**Step 2:** Drill a 1/8" hole for each screwhole in the mounting bracket. Attach the bracket to the dash with the 3/8" Phillips machine screws provided.

**Extreme caution should be exercised**

**when drilling into dash to avoid damage to under-dash electronic ignition, cruise control, instrument and/or accessory wiring.**

**Step 3:** Attach removable 3-pin, plug-in DC cord to 3-pin polarized DC jack on the rear of the transceiver.

**Step 4:** Locate and secure the radio into the mounting bracket, allowing working space for later power connections.

## Power wiring.

**Step 1:** If you have not determined whether your vehicle has a negative or positive ground, do so now.

Then disconnect the leads from the battery to prevent short circuits that can occur during wiring.

**Step 2:** With **negative ground**, connect the red wire — the one with in-line fuse holder — to either the (a) fuse block, (b) cigarette lighter or (c) directly to the positive post on your battery.

(Usually, the fuse block is the most convenient connecting point. It is also possible to connect to the Accessory terminal on the fuse block

or ignition switch, so that your CB automatically goes off when the ignition goes off, preventing accidental battery drainage.)

Then tightly connect the black wire directly to the vehicle's metal frame.

With a **positive ground**, reverse the wires, connecting the red/fuse-holder wire to the frame, the black wire to your DC power source. A light or meter can be a good aid in locating a suitable power source and ground.

In either case, a good, direct metal-to-metal ground is essential for optimum performance.

### CAR'S MOTOR BLOCK OR FIRE WALL GROUND

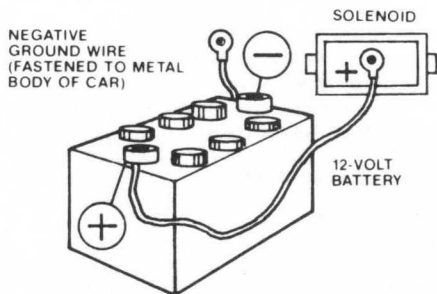

EXAMPLE OF  
NEG. GROUND 12-V DC CAR BATT  
CONNECTION ILLUSTRATION  
MOST CARS & TRUCKS ARE  
THIS TYPE

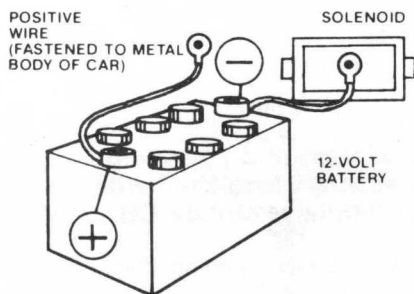

EXAMPLE OF  
POS. GROUND 12-V DC CAR BATT  
CONNECTION ILLUSTRATION FEW  
18-WHEELERS & OLDER CARS

## Mounting the main unit.

**Step 1:** Loosen the retaining knobs on each side of the mounting bracket to give enough space for the unit to slide between the two bracket arms.

**Step 2:** Position the main unit between the bracket arms in line with the retaining knobs. Set the tilt angle for operating comfort and accessibility.

**Step 3:** Tighten the retaining knobs.

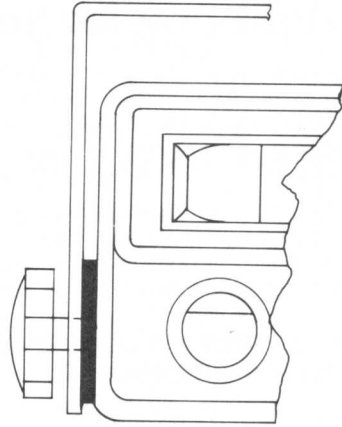
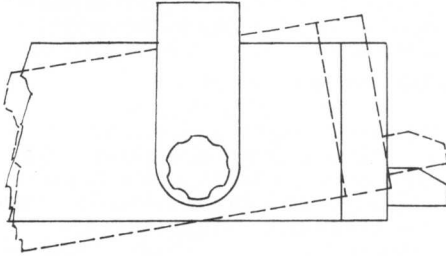

---

## Installation of microphone hanger.

Mounting holes are provided on the side of the transceiver for the microphone hanger bracket. Alternately, the bracket can be attached to the vehicle dash.

## Connecting optional remote speaker.

Locate the "EXT" jack on the main unit rear panel. Firmly insert and seat the speaker wire plug into the jack.

When connected, the external speaker will override and "blank out" the in-unit speaker standard with your Midland Mobile CB.

## Connecting optional Public Address speaker.

Locate the "PA" jack on the main unit back panel. Firmly insert and seat the speaker wire plug into the jack.

Directions for mounting the optional Public Address speaker are included, along with mounting hardware, with the speaker.

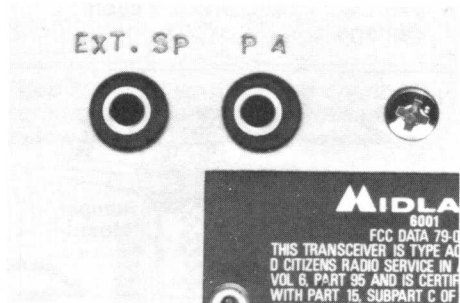



# Antennas: How to select, position, install and tune the right one for you.

Basically, you have two types of mobile CB antennas — full-length whip and loaded whip — and a variety of types of mounts (depending on where you locate your antenna) to choose from.

Midland markets a broad line of high-performance antennas. The dealer who sold you your Midland CB can advise which type is best for you.

## Where you locate your antenna does make a difference.

Some general rules for antenna location that can aid CB performance:

1. Put your mount as high on the vehicle as possible.
2. The higher the proportion of antenna length that is above the roof, the better.
3. If possible, mount the antenna in the center of whatever surface you choose.
4. Keep antenna cables away from noise sources, such as the ignition system, gauges, etc.
5. Make sure you have a solid metal-to-metal ground.
6. Exercise care to prevent cable damage.

Essentially, you have five location choices: the roof, gutter, rear deck, front cowl or rear bumper.

Where you decide to locate your antenna will determine the type of antenna you install. Again, consult your Midland CB Dealer for advice and guidance, and measure your needs against the attributes of the various Midland antenna models he carries.

## Antenna installation.

Follow the manufacturer's installation instructions carefully.

**Warning: Never operate your CB radio without attaching an antenna or with a broken antenna cable. This can result in damage to transmitter circuitry.**

## Tuning your antenna.

Some antennas are factory tuned. However, performance can usually be improved by slightly lengthening or shortening its length, using a Standing Wave Ratio (SWR) meter. For the exact procedures to be used, refer to the antenna manufacturer's installation manual.

You can buy an SWR meter separately or have your antenna checked by your Midland CB Dealer's service department.

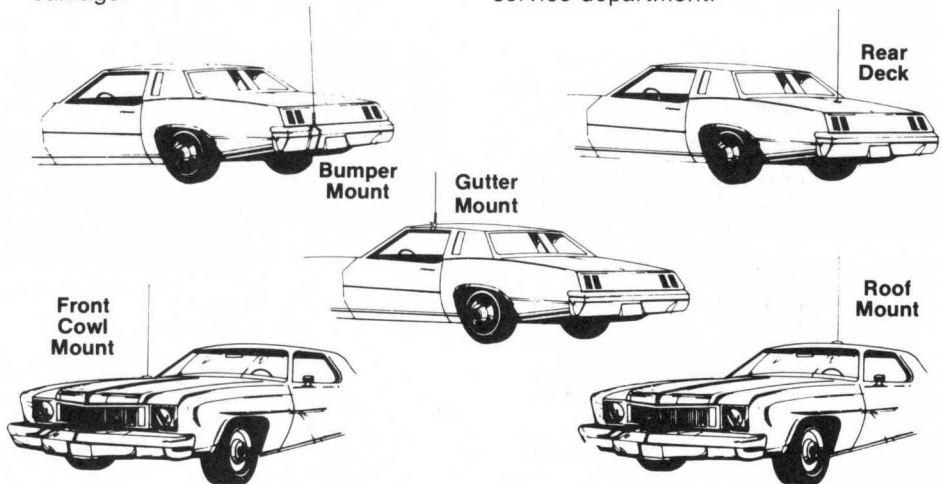

# Midland 6001: Operating Instructions.

Having properly installed and wired your CB and antenna, you are now ready for the eight steps designed to get you into effective, satisfactory operation:

**Step 1:** Insert the plug from the microphone into the microphone jack on the side panel, and screw on securely.

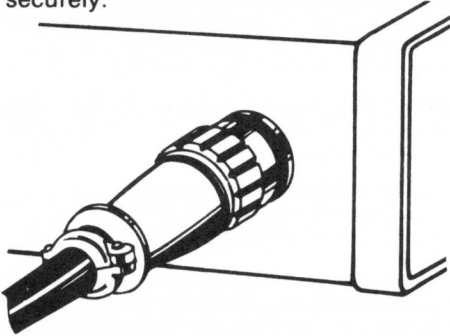

**Step 2:** Make sure your antenna is securely connected to the antenna connector.

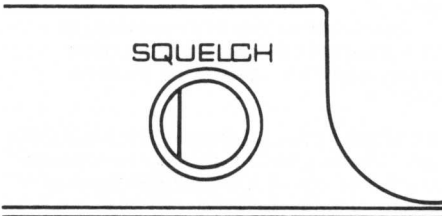

**Step 3:** Make sure the Squelch Control is in the 9:00 position.

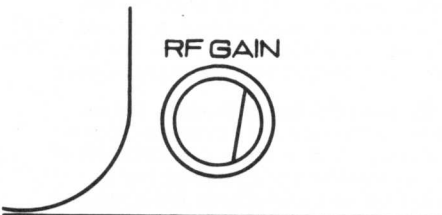

**Step 4:** Make sure the RF Gain Control is fully clockwise.

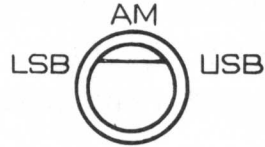

**Step 5:** Select the desired mode of operation, USB, AM or LSB, using the selector switch.

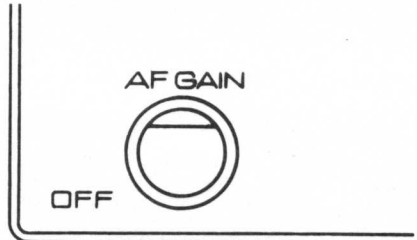

**Step 6:** Turn the power on and adjust the Audio Frequency (AF) Gain Control for a satisfactory sound level.

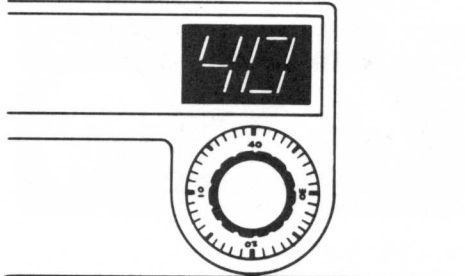

**Step 7:** Select your desired channel by turning the Channel Selector dial below the LED digital indicator.



**Step 8:** To transmit, press the push-to-talk bar on the microphone. To receive, release the bar.

# Operating controls, connectors: Their functions and uses.



Starting at the upper left (driver's side) corner of your Midland 6001 and moving counter-clockwise:

**S/RF Power Meter.** This new high-visibility, black-on-light green meter is used two ways. (1) When receiving, it gives the relative strength of incoming signals. (2) When transmitting, it shows RF (Radio Frequency) power output.

**4-pin/Screw-type Microphone Connector.** Securely links your microphone to the main unit during use, yet allows quick disconnection when out of service.

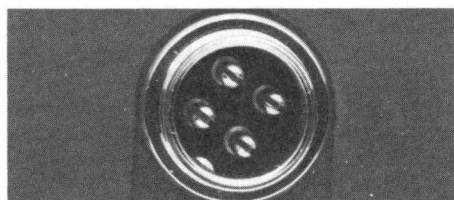

**Off/AF Gain Control.** Turns your CB on and adjusts the Audio Frequency (volume) level for comfortable reception.

**Squelch Control.** Turned clockwise, it quiets the receiver when signals are not being received and allows a quiet standby operation.

The Squelch Control functions only in the receive mode and does not affect receiver volume when signals are being received.

To adjust, when no signals are present, rotate the Squelch Control clockwise until the receiver is quieted. Incoming signals will automatically release the squelch action.

Careful adjustment is necessary as a setting too far clockwise will not allow weaker signals to release the squelch action.



**LED Digital Channel Display.** Illuminated in easy-to-read green, it displays the channel selected by use of the analog-numbered selector dial just below.



**RF (Radio Frequency) Gain Control.** Controls the reception sensitivity (range) of your CB. To decrease RF gain — to reduce interference, for example, in congested urban areas — turn the knob counter-clockwise; to increase turn clockwise. The RF Gain Control affects reception only. It will not affect transmitter output power.

**LSB-AM-USB Mode Selector Switch.** Selects the mode of transmission and reception. Either the upper sideband or lower sideband of a channel can be selected, or conventional AM operation.

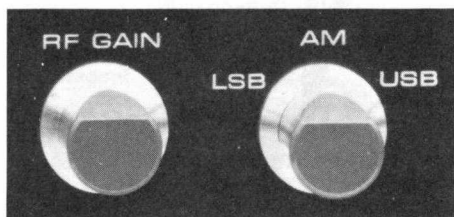

**Clarifier Control.** "Fine-tunes" signals received on either the upper or lower sideband.

**CB/PA Switch.** An optional PA speaker may be attached to your transceiver through the PA output jack on the back panel. This allows you to communicate with pedestrians or other vehicles through your CB microphone. The CB/PA switch changes your CB speaker system from a CB function, using the internal main-unit speaker, to a Public Address function using an external speaker.

**NB/ANL Switch.** In the NB (Noise Blanker) & ANL (Automatic Noise Limiter) setting, it reduces electrical impulse noises, such as those caused by engine ignition systems, atmospheric noise and other electrical interference. The "Off" setting is used when neither problem exists.

**Hi-Lo Tone Control.** Controls the tonal quality of received signals in accordance with the user's preference.

**Dual red/green TX/RX Indicator.** When red, it indicates the unit is transmitting and acts as a warning when the microphone push-to-talk bar is accidentally keyed. When green, it indicates your transceiver is in the "receive" mode.

**External Speaker Jack.** Allows you to attach an external speaker that will override the unit's internal speaker. Connection is made through the External Speaker Jack on the back panel.

**PA Jack.** An optional PA speaker may be attached to your transceiver through the PA output jack on the back panel. This allows you to communicate with pedestrians or other vehicles through your CB microphone.

**Microphone Push-to-Talk Bar.** Simply push this bar to transmit; release when receiving.

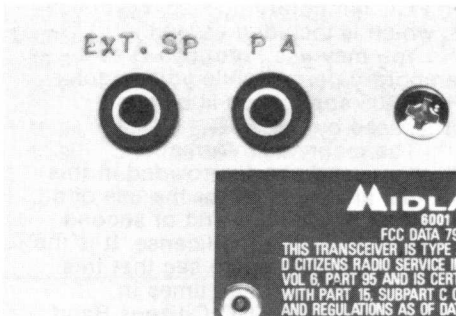
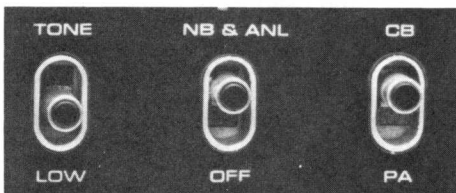
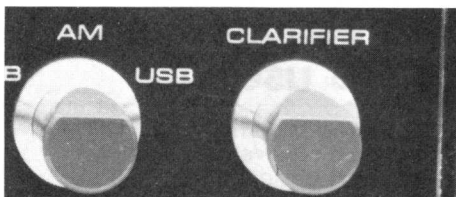

# FCC requirements for CB users.

Your new Midland Mobile CB is a combination receiver/transmitter (transceiver) designed and built for licensed Class D operation on any of the 40 frequencies designated for citizens band use by the Federal Communications Commission.

You are required to have or have ordered a current copy of Part 95, Subpart D, of the FCC rules and regulations (a current copy as of the date of manufacture is included with your new CB) prior to operation of this unit.

You are also required to complete FCC Form 505 (also included with your CB) and submit it to the **FCC, Gettysburg, PA 17326** in order to obtain your license to operate this unit.

(Disregard the above paragraph if you have a current CB license less than 5 years old.)

FCC regulations will be violated if you transmit with this unit without complying with procedures explained on FCC temporary license, Form 555-B, which is included as well.

You may use Form 555-B as a temporary permit while your regular Form 505 application is being processed by the FCC.

The technical information, diagrams and charts provided in this manual are supplied for the use of a qualified holder of a first or second class radio-telephone license. It is the user's responsibility to see that this unit is operating at all times in accordance with FCC Citizens Band Radio Service regulations.

If you install your own transceiver, do not attempt to make any transmitter or receiver tuning adjustments. These adjustments are prohibited by the FCC unless you hold a first or second class radio-telephone license. A Citizens Band or Amateur license is not sufficient.

When service is performed by an authorized and licensed person, care must be taken that only authorized replacement parts are used in order not to void the type acceptance or certification of this model.

Midland International Corporation hereby certifies that this unit has been designed, manufactured, FCC type accepted and certified in accordance with Part 95 and Part 15, Subpart C, of the current FCC rules and regulations as of the date of manufacture.

## General CB information.

In 1958, The Federal Communications Commission approved the use of 23 channels by duly licensed Citizens Band radio operators. The authorization was expanded to 40 channels in 1977.

A simple, basic means of communication, CB requires no more skill or knowledge than the operation of a standard AM or FM receiver.

Still, there are certain facts, procedures and "rules of the road" you'll need to know in order to make the most of your CB experience.

**Make it "short and sweet."** When using your CB, get on and off the air as quickly as possible. Never use profanity — which is against the law and subject to heavy penalties. Follow the FCC rules outlined in Part 95.

**Use Channel 9 in emergencies only.** Emergency channel 9 is designated for this purpose and this purpose alone.

The FCC has given public safety agencies various "call signs" including "0911" numbers, coinciding with the "911" phone numbers these agencies use in telephone communications.

The call signs for state-level agencies use 3 letters and 4 numbers, with the second and third letters being the official Post Office state abbreviation, e.g., "KS" for "Kansas."

**Why and how to use the "10 Code."** Developed over the years by official agencies in order to save time and provide precise, clear messages, the "10-Code" has become a popular tool for CBers.



The table below lists some of the more common codes and their meanings.

<b>Code</b>	<b>Meaning</b>
10-1	Receiving poorly.
10-2	Receiving well.
10-3	Stop transmitting.
10-4	OK, message received.
10-5	Relay message.
10-6	Busy, stand by.
10-7	Out of service; leaving the air.
10-8	In service, subject to call.
10-9	Repeat message.
10-10	Transmission completed, standing by.
10-11	Talking too fast.
10-12	Visitors present.
10-13	Advise weather/road conditions.
10-16	Make pickup at.
10-17	Urgent business.
10-18	Anything for us?
10-19	Nothing for you; return to base.
10-20	My location is.
10-21	Call by telephone.
10-22	Report in person to.
10-23	Stand by.
10-24	Completed last assignment.
10-25	Can you contact?
10-26	Disregard last information.
10-27	I am moving to Channel.
10-28	Identify your station.
10-29	Time is up for contact.
10-30	Does not conform to FCC rules.
10-32	I will give you a radio check.
10-33	Emergency traffic.
10-34	Trouble at this station.
10-35	Confidential information.
10-36	Correct time is.
10-37	Wrecker needed at.
10-38	Ambulance needed at.
10-39	Your message delivered.
10-41	Please turn to Channel.
10-42	Traffic accident at.
10-43	Traffic tie-up at.
10-44	I have a message for you.
10-45	All units within range report.
10-50	Break channel.
10-60	What is next message number?
10-62	Unable to copy; use phone.
10-63	Network directed to.
10-64	Network clear.
10-65	Awaiting your next message/assignment.
10-67	All units comply.
10-70	Fire at.
10-71	Proceed with transmission in sequence.
10-77	Negative contact.
10-81	Reserve hotel room at.
10-82	Reserve room for.
10-84	My telephone number is.
10-85	My address is.
10-91	Talk closer to mike.
10-93	Check my frequency on this channel.
10-94	Please give me a long count.
10-99	Mission completed; all units secure.
10-200	Police needed at.

### **Musts and mustn'ts of CB usage.**

**You must** identify your official licensed call sign at the finish of every conversation.

**You mustn't** carry on a conversation with another station for more than 5 minutes at a time without taking a 1-minute break, to give others use of the channel.

**You mustn't** blast others off the air by overpowering them with illegal transmitter power or illegally high antennas.

**You mustn't** use CB to promote illegal activities.

**You mustn't** use profanity.

**You mustn't** play music on your CB.

**You mustn't** use your CB to sell merchandise or commercial services.

## Frequency-channel number chart.

Frequency	Channel
26.965 MHz _____	1
26.975 MHz _____	2
26.985 MHz _____	3
27.005 MHz _____	4
27.015 MHz _____	5
27.025 MHz _____	6
27.035 MHz _____	7
27.055 MHz _____	8
27.065 MHz _____	9
27.075 MHz _____	10
27.085 MHz _____	11
27.105 MHz _____	12
27.115 MHz _____	13
27.125 MHz _____	14
27.135 MHz _____	15
27.155 MHz _____	16
27.165 MHz _____	17
27.175 MHz _____	18
27.185 MHz _____	19
27.205 MHz _____	20
27.215 MHz _____	21
27.225 MHz _____	22
27.255 MHz _____	23
27.235 MHz _____	24
27.245 MHz _____	25
27.265 MHz _____	26
27.275 MHz _____	27
27.285 MHz _____	28
27.295 MHz _____	29
27.305 MHz _____	30
27.315 MHz _____	31
27.325 MHz _____	32
27.335 MHz _____	33
27.345 MHz _____	34
27.355 MHz _____	35
27.365 MHz _____	36
27.375 MHz _____	37
27.385 MHz _____	38
27.395 MHz _____	39
27.405 MHz _____	40

## Factors affecting effective CB range.

Essentially, they're the same influences that optimize or limit AM, FM and other kinds of performance in moving vehicles:

**Terrain:** Hills and valleys naturally interrupt and shorten CB signals.

**Weather.** You can expect that CB range will be reduced — perhaps drastically — in times of atmospheric disturbance, such as in a thunderstorm or heavy snow. Sunspots, too, are known to adversely affect CB performance.

**Obstructions.** Inside a tunnel, covered parking garage or viaduct, CB transmitting/receiving capability may be cut off altogether.

In short, you can expect to maintain maximum transmitting/receiving performance in flat, open country in stable (not necessarily clear) weather conditions.

Should effective range be limited in these conditions, check to see that your CB is connected properly and your antenna adjusted correctly. It may be necessary to consult your Midland CB Dealer's service department.

### What causes noise?

If you have an abnormal noise problem, the chances are your vehicle itself is the cause.

A CB receiver is a very sensitive instrument, able to pick up small noise signals and amplify them — particularly if the source of these signals is within a few feet of your CB.

Any noise that comes from your CB almost certainly comes from outside the unit itself. Devices have been designed into your Midland CB (a noise blanker or an automatic noise limiter, for example) to minimize this kind of distraction.

### Trouble-shooting aids.

Frequently, there are simple, quick actions you can take to eliminate or minimize such problems as interference and noise.

## Noise suppression.

A very common source of excessive noise is the ignition system of a CB owner's vehicle. If you suspect this is true, simply turn off the ignition and set the key in the accessories (ACC) position.

This way you'll provide power to the transceiver, minus any ignition interference that might exist. If the noise goes away, you know instantly that the ignition system is the culprit.

Still, there are a number of places in the ignition system where noise can originate.

**Sparkplugs** and sparkplug wires are probably the worst noise producers. To eliminate this kind of noise, you can take any of four simple measures: (1) Install resistive sparkplug suppressors, (2) resistor sparkplugs or (3) resistance-wire cabling, between plugs and the distributor and also between the distributor and ignition coil. (4) Replace old plugs and sparkplug wiring and properly tune the engine. This generally cures most noise.

Many cars come suppressor-cable equipped. If yours didn't (consult your vehicle owners manual or dealer service department to be sure), you can get it at any auto supply store and, given a moderate amount of mechanical skill, install it yourself.

**Caution: Do not undertake any ignition-system repairs or modifications without either professional help or some automotive service experience.**

**Generator-brush sparking** can create an annoying "whine." It's caused by a dirty commutator, and is eliminated by polishing its surface with fine-grade emery cloth, and cleaning grooves with a small, sharp tool.

**Voltage regulators** can cause a "hashy" sound in your CB when relay contacts jitter open and closed when the battery is fully charged. To eliminate this noise, mount coaxial feedthrough capacitors at the battery and armature terminals on the regulator box.

**Alternator slip rings** should also be kept clean and good brush contact maintained to minimize CB noise.

In addition, single-contact alternator regulator boxes need a coaxial capacitor at the ignition terminal. Double-contact units should have a second capacitor at the battery terminal. Shielding between the regulator and alternator may be needed as well. Be sure to ground the shield at both ends.

Infrequent, though real, noise generators like your car's heater fan, turn signals, electric windows and windshield-wiper motors can also be silenced with a coaxial capacitor (consult your serviceman).

**Wheels and tires** can also cause CB noise. Wheel noise is eliminated by putting static-collector springs between the wheel spindle bolt and grease retainer cup. Tire static can be quieted with antistatic powder applied inside each wheel.

**Antenna corona-discharge noise** — most frequently occurring with sharp-pointed "whip" models — can happen just before or during electrical storms. The only cure is for the storm to blow over or pass.

## SOLUTIONS:

### COMMON CB PROBLEMS:

	Check CB-PA switch.	Check power cable connection.	Check 2-amp fuse.	Check Squelch adjustment.	Check on/off switch.	Change to active channel.	Check antenna channel.	Fully depress push-to-talk bar.	Check microphone connection.	Check metal-to-metal ground connection.	Check antenna cable and SWR adjustment.	Check RF gain control.
No sound or channel light.	•	•		•					•			
Channel light but no sound.	•			•		•		•	•			•
No voice reception.			•		•							•
Poor reception.						•			•	•	•	
Transmission problems.						•	•	•	•	•		
Unclear reception.						•			•	•	•	
Poor PA Audio Frequency.	•											
Inoperative channel selector.	•											

**Caution:** The 2-amp fuse included with this unit is an important safety feature which must not be circumvented. Removal of this fuse or the use of a fuse greater than 2 amps may result in overheating and/or fire and consequential damage to the unit or vehicle. If a replacement 2-amp fuse burns out, have the unit inspected and repaired by a qualified service technician.

## Midland 6001 Mobile CB Transceiver: Technical Specifications.

### General Construction.

- Three-pin polarized jack for DC power.
- Four-pin screw connector for microphone.
- No mechanical relays. All switching is solid state using diodes and transistors for high reliability.
- Transmitter output stage is protected from mismatch, no-load or short-circuit conditions.
- Input power is suitably filtered and bypassed to deter alternator "whine" on transmit or receive.

### Electrical Specifications.

#### General:

Voltage ..... 13.8 V. Positive/  
Negative Ground  
Operating Range:  
10 V to 16 V

Frequency Stability ..... ±0.005%

Temperature Range ..... -30° to +50°C  
(Per FCC Part 15)

Humidity ..... 5-90%

Vibration ..... EIA Standard RS-424

Shock ..... EIA Standard RS-424

#### Receiver (AM):

Sensitivity  
Less than 0.7  $\mu$ v for 10 dB SN +N to N

Automatic Gain Control Figure of Merit  
80 dB.

Audio Squelch Sensitivity.  
Threshold Less than 10 dB SN+N to N  
Tight: 100  $\mu$ v minimum. 500  $\mu$ v  
maximum.

#### Adjacent Channel Selectivity and

Desensitization  
60 dB (Two-generator method)

Spurious Response Attenuation.  
60 dB (excluding image at 50 dB)

Audio Power Output  
3 W @ 10% distortion (load impedance  
8 ohms resistive).

Audio Frequency Response (1 KHz, 0 dB  
reference).  
300 Hz @ -5 dB.  
1000 Hz @ 0 dB  
2000 Hz @ -3 dB.

Hum and Noise, Squelched.  
-45 dB.

Noise Limiting  
Provided with Switchable ANL.

S Meter Sensitivity at "S-9".  
100  $\mu$ v.

RF Gain Range  
30 dB

Antenna Input Impedance.  
50 ohms, unbalanced.

#### Transmitter (AM):

Carrier Power, No Modulation.  
4 W maximum, 3.6 minimum

Conducted Spurious Emissions.  
-65 dB

Radiated Spurious Emissions.  
(Complies with FCC Part 95)

Audio Frequency Harmonic Distortion.  
10% maximum @ 80%

#### Audio Frequency Response (1 KHz, 0 dB

reference).  
300 Hz @ -5 dB  
1000 Hz @ 0 dB  
3000 Hz @ -5 dB.

Hum and Noise.  
-40 dB.

Output Impedance  
50 ohms, unbalanced.

Output Protection.  
Withstands for 5 minutes all VSWR  
around Smith Chart at 20:1 without  
damage or failure.

Output Stability.  
Does not exceed FCC Limits For  
Spurious Emissions when operated  
into a mismatch load with 5:1 VSWR at  
any point on the Smith Chart.

**Controls:** Off/AF gain control Squelch  
control. RF gain control. CB/PA switch.  
Hi/Lo Tone switch. NB+ ANL-Off switch.  
S/RF/PWR Meter. Green color  
Numerical LED Channel indicator  
Rotary Analog-Numerical Channel  
selector Tx/Rx indicator. Mode Selector.  
Clarifier.

#### Jacks and Connections: 4-pin/screw-type

Microphone Connector, 50-ohm  
antenna. 8-ohm external speaker. PA  
speaker.

**Accessories Included:** 500-ohm push-to-talk  
microphone with coil cord and screw-  
on 4-pin connector. Microphone clip.  
Mounting bracket and hardware.  
Owners manual. FCC forms 505,  
555-B, Part 95

# Parts Layout. Main PC Board.

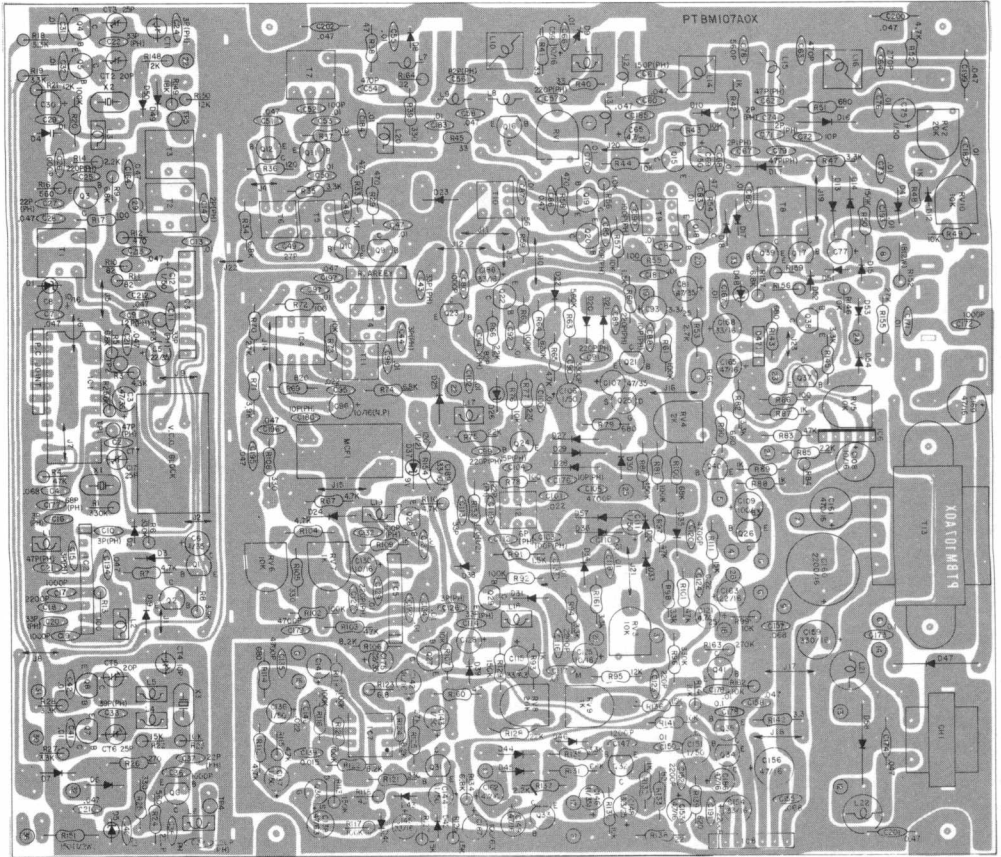

Component side.

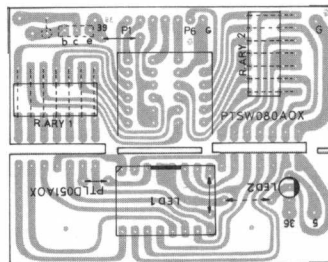



# Parts Layout. Main PC Board.

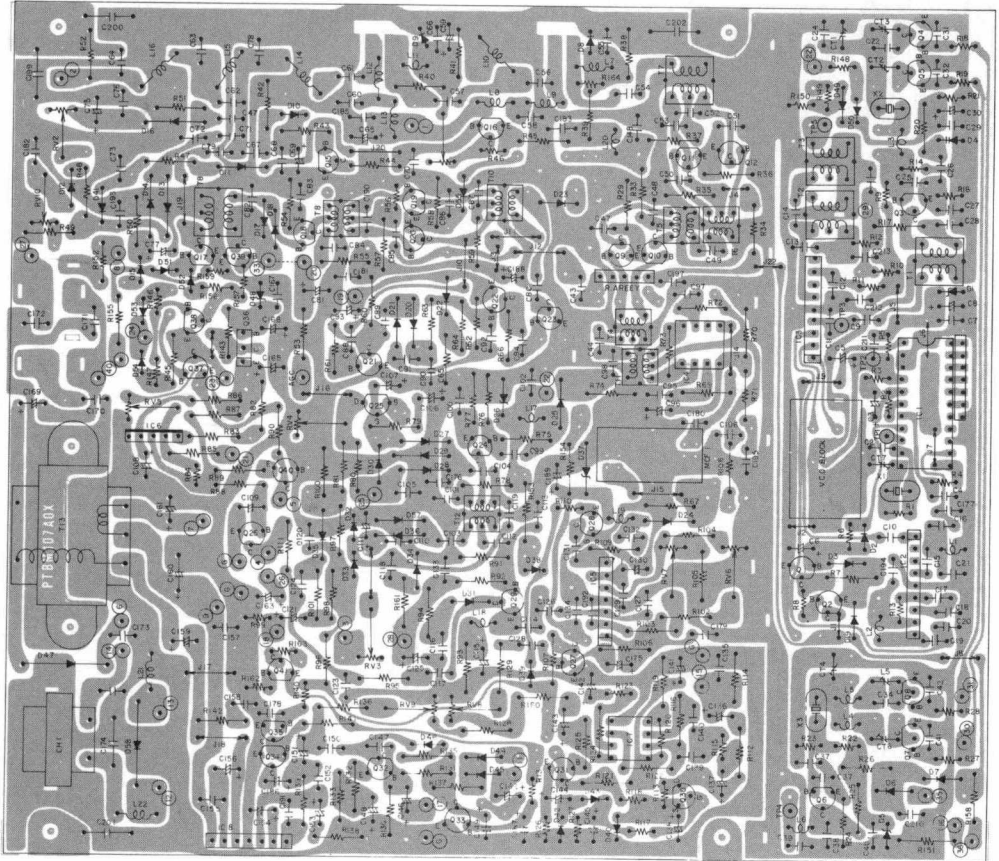

Pattern side.

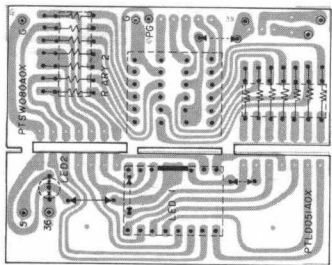



# The Midland tradition of electronic excellence.

Outstanding CB performance and dependability are only two ways Midland electronic excellence will brighten your life.

The same expertise, skill and dedication that's engineered into your Midland CB also go into every product in the long, versatile line of Midland car stereo receivers, tape players and accessories.

Including widely-acclaimed, exclusive Midland MicroPrecision™ AM/FM/MPX electronic tuning. The 100% electronic signal-search system that locates and locks on stations with microprocessor precision.

And keep your eyes and ears on the popular line of Midland television sets.

The color and black-and-white sets that give you the quality and features you want at some of the most attractive prices in the industry.

