

Excalibur[®]

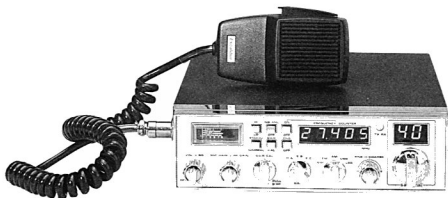

侍

samurai

OWNER'S MANUAL

4000 Channels All-Mode AM/FM/USB/LSB/CW

Built in Frequency Counter

Mobile Transceiver with Roger Beep

TABLE OF CONTENTS

	Page
Specifications	2
Installation	
Location	4
Mounting the Connection	4
Ignition Noise Interference	5
Antenna	5
Tuning the Antenna for Optimum SWR	6
Extend Speaker	7
Operation	
Control Functions	8
Front Panel	8
Rear Panel	10
Press-To-Talk Microphone	11
Operating Procedure to Receive	11
Operating Procedure to Transmit	11
Receiving SSB signals	11
Operating Procedure to CW MODE	13
Roger Beep	13
Alternate Microphones and Installation	14
A Few Rules That Should Be Obeyed	17
Frequency Range and Schematic Diagram	

Specifications

GENERAL

Channels	800FM,800AM,800LSB,800USB, 800CW.
Frequency Range	Low Band: A. 25.615 to 26.065 MHz B. 26.065 to 26.515 MHz C. 26.515 to 26.965 MHz High Band: D. 26.965 to 27.415 MHz E. 27.415 to 27.865 MHz F. 27.865 to 28.315 MHz
Frequency Control	Phase Lock Loop (PLL) synthesizer.
Frequency Tolerance	0.005%.
Frequency Stability	0.001%.
Operating Temperature Range	-30°C to +50°C.
Microphone	Plug-in dynamic; with push-to-talk switch and coiled cord.
Input Voltage	13.8V DC nominal, 15.9V max., 11.7V min. (positive or negative ground). <i>Transmit:</i> AM full mod., 2.2A. SSB 12 watts PEP output, 2A. <i>Receiver:</i> Squelched, 0.3 A. Maximum audio output, 0.7A.
Size	2-3/8"(H) x 7-7/8"(W) x 9-1/4"(D).
Weight	5 lbs.
Antenna Connector	UHF, SO239.
Meter (3-in-1)	Illuminated; indicates relative output power, received signal strength, and SWR.

TRANSMITTER

Power Output	AM/FM/CW, 5 watts. SSB, 12 watts, PEP.
Modulation	High-and low-level Class B, Amplitude Modulation: AM. Variable capacitance Frequency Modulation: FM.
Intermodulation Distortion	SSB: 3rd order, more than -25 dB. 5th order, more than -35 dB.
SSB Carrier Suppression	55 dB
Unwanted Sideband	50 dB

Frequency Response	AM and FM: 450 to 2500 Hz.
Output Impedance	50 ohms, unbalanced.
Output Indicators	Meter shows relative RF output power and SWR. Transmit LED glows red when transmitter is in operation.

RECEIVER

Sensitivity	SSB/CW: 0.25 μ V for 10 dB (S+N)/N at greater than 1/2-watt of audio output. AM: 0.5 μ V for 10 dB (S+N)/N at greater than 1/2-watt of audio output. FM: 1.0 μ V for 20 dB (S+N)/N at greater than 1/2-watt of audio output.
Selectivity	AM/FM: 6 dB @3 KHz, 50 dB @9 KHz. SSB/CW: 6 dB @2.1 KHz, 60 dB @3.3 KHz.
Image Rejection	More than 65 dB.
IF Frequency	AM/FM: 10.695 MHz 1st IF, 455 KHz 2nd IF SSB/CW: 10.695 MHz.
Adjacent-Channel Rejection	60 dB AM/FM & 70 dB SSB/CW.
RF Gain Control	45 dB adjustable for optimum signal reception.
Automatic Gain Control (AGC)	Less than 10 dB change in audio output for inputs from 10 to 100,000 microvolts.
Squelch	Adjustable; threshold less than 0.5 μ V.
ANL	Switchable.
Noise Blanker	RF type, effective on AM/FM and SSB/CW.
Clarifier Range	Coarse (TX/RX) \pm 7 KHz. Fine (RX) \pm 1 KHz.
Audio Output Power	4 watts into 8 ohms.
Frequency Response	300 to 2800 Hz.
Built-in Speaker	8 ohms, round.
External Speaker (Not Supplied)	8 ohms; disables internal speaker when connected.

Installation

LOCATION

Plan the location of the transceiver and microphone bracket before starting the installation. Select a location that is convenient for operation and does not interfere with the driver or passengers in the vehicle. In automobiles, the transceiver is usually mounted below the dash panel, with the microphone bracket beside it.

MOUNTING THE CONNECTION

The **侍 samurai** is supplied with a universal mounting bracket. When mounting the bracket and radio to your car, make sure it is mechanically strong. Also provide a good electrical connection to the chassis of the vehicle. Proceed as follows to mount the transceiver:

1. After you have determined the most convenient location in your vehicle, hold the **侍 samurai** with mounting bracket in the exact location desired. If nothing will interfere with mounting it in the desired position, remove the mounting bolts. Before drilling the holes, make sure nothing will interfere with the installation of the mounting bolts.
2. Connect the antenna cable plug to the standard receptacle on the rear panel. Most CB antennas are terminated with a type PL-259 plug and mate with the receptacle.
3. Connect the red DC power input wire (with the fuse) to +13.8V DC. This wire extends from the rear panel. In automobile installation, +13.8V DC is usually obtained from the accessory contact on the ignition switch. This prevents the set being left on accidentally when the driver leaves the car and also permits operating the unit without the engine running. Locate the accessory contact on most ignition switches by tracing the power wire from the AM broadcast receiver in the car.
4. Connect the black lead to -13.8V DC. This is usually the chassis of the car. Any convenient location with good electrical contact (remove paint) may be used.
5. Mount the microphone bracket on the right side of the transceiver or near the transceiver, using two screws supplied. When mounting in an automobile, place the bracket under the dash so the microphone is readily accessible.

IGNITION NOISE INTERFERENCE

Use of a mobile receiver at low signal levels is normally limited by the presence of electrical noise. The primary source of noise in automobile installations is from the generator and ignition system in the vehicle. Under most operating conditions, when signal level is adequate, the background noise does not present a serious problem. Also, when extremely low level signals are being received, the transceiver may be operated with vehicle engine turned off. The unit requires very little current and therefore will not significantly discharge the vehicle battery.

Even though the 侍 **samurai** has ANL and NB controls, in some installations ignition interference may be high enough to make good communications impossible. The electrical noise may come from several sources. Many possibilities exist and variations between vehicles require different solutions to reduce the noise.

ANTENNA

A vertically polarized, quarter-wavelength whip antenna provides the most reliable operation and greatest range. Shorter, loaded-type whip antennas are more attractive, compact and adequate for applications where the maximum possible distance is not required. Also, the loaded whips do not present the problems of height imposed by a full quarter-wavelength whip.

Mobile whip antennas utilize the metal body of the vehicle as a ground plane. When mounted at a corner of the vehicle they are slightly directional, in the direction of the body of the vehicle. For all practical purpose, however, the radiation pattern is nondirectional. The slight directional characteristic will be observed only at extreme distances. A standard antenna connector (type SO 239) is provided on the transceiver for easy connection to a standard PL 259 cable termination.

If the transceiver is not mounted on a metal surface, it is necessary to run a separate ground wire from the unit to a good metal electrical ground in the vehicle. When installed in a boat, the transceiver will not operate at maximum efficiency without a ground plate, unless the vessel has a steel hull.

Before installing the transceiver in a boat, consult your dealer for information regarding an adequate grounding system and prevention of electrolysis between fittings in the hull and water.

TUNING THE ANTENNA FOR OPTIMUM SWR

Since there is such a wide variety of base and mobile antennas, this section will strictly concern itself to the various types of mobile adjustable antennas.

Because the antenna length is directly related to the channel frequency, it must be tuned to resonate optimally all 800 channels of the transceiver. Channel 1 requires a longer antenna than Channel 800 because it is lower in frequency.

Due to the various methods of adjusting antennas for proper SWR we have chosen what we think is the optimum method:

A. Antennas with adjustment screws (set screws).

1. Start with the antenna extended and tighten the set screw lightly enough so that the antenna can be lightly tapped with your finger for easy adjustment.
2. Set your 侍 **samurai** to Channel 21. @ Low band B or Hi band E. Press the PTT (push-to-talk) switch, and tap the antenna (making it shorter). The SWR meter will show a lower reading each time the antenna is tapped. By continuing to shorten the antenna you will notice the SWR reading will reach a low print and then start rising again. This means that you have passed the optimum point for Channel 21. Extend the antenna a short distance and again follow the procedure above.

When the lowest point has been reached, switch to Channel @ Low band A or Hi band D and then to Channel 40 @ Low band C or Hi band F and compare SWR readings. They should be almost equal.

B. Antennas which must be cut to proper length.

1. Follow the same procedure as above, but adjust the length by cutting in $1/8''$ increments until a good match is obtained.
2. *Be very careful not to cut too much at one time, as one it is cut, it can no longer be lengthed.*
3. The whip is easily cut by filing a notch all the way around and breaking the piece off with pliers.

NOTE

THE PROPER SETTING IS ACHIEVED WHEN THE SWR IS 1.5 OR BELOW, AND WHEN IT HAS THE SAME READING FOR CHANNELS LOW BAND A1 AND HI BAND F40.

If you are having difficulties in adjusting your antenna, check the following:

- A. All doors must be closed when adjusting the antenna.
- B. Make sure the antenna base is grounded.
- C. Check your coaxial cable routing (it may be pinched when routed into the car).

- D. Try a different location on your car (keeping in mind the radiation pattern you wish).
- E. Is the antenna perfectly vertical?
- F. Try a different location in your neighborhood. Stay away from large metal objects when adjusting (metal telephone or light posts, fences, etc.)

—NOTE—

The 侍 **samurai** will operate into an SWR of 2 to 1 indefinitely and sustain an SWR of 20:1 for a maximum of 5 minutes at rated operating conditions.

External Speaker

The external speaker jack (EXT. SPK.) on the rear panel is used for remote receiver monitoring. The external speaker should have 8 ohms impedance and be able to handle at least 4 watts. When the external speaker is plugged in, the internal speaker is disconnected.

Operation

CONTROL FUNCTIONS

There are Fifteen controls and four indicators on the front panel of your 侍 samurai.

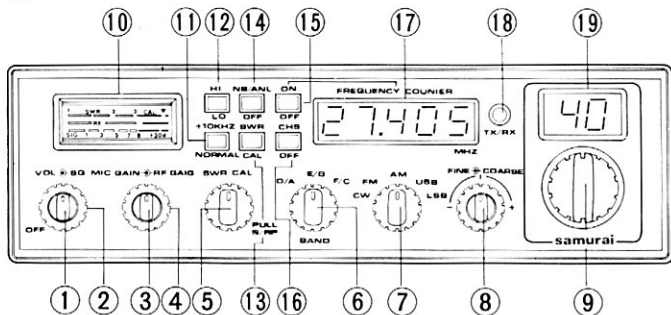

FRONT PANEL

- 1. OFF/ON/VOLUME (inner dual concentric).** Turn clockwise to apply power to the unit and to set the desired listening level. During normal CB operation, the VOLUME control is used to adjust the output level obtained either at the transceiver speaker or the external speaker, if used.
- 2. SQUELCH (outer dual concentric).** This control is used to cut off or eliminate receiver background noise in the absence of an incoming signal. For maximum receiver sensitivity it is desired that the control be adjusted only to the point where the receiver background noise or ambient background noise is eliminated. Turn fully counterclockwise then slowly clockwise until the receiver noise disappears. Any signal to be received must now be slightly stronger than the average received noise. Further clockwise rotation will increase the threshold level which a signal must overcome in order to be heard. Only strong signals will be heard at a maximum clockwise setting.
- 3. MIC GAIN (inner dual concentric).** Adjusts the microphone gain in the transmit and PA modes. This controls the gain to the extent that full talk power is available several inches away from the microphone.
- 4. RF GAIN CONTROL (outer dual concentric).** Use to reduce the gain of the RF amplifier under strong signal conditions.
- 5. SWR CAL CONTROL (dual concentric)/S-RF SWITCH.** In order for you to achieve maximum radiated power and the longest range, it is important that your antenna be in good condition, properly adjusted and matched to your transceiver. The built-in SWR (standing wave ratio) meter last you

easily measure your antenna condition. To operate this function, connect your antenna to the transceiver antenna output connector. Select a channel near the middle of the band such as 21 or the channel you plan to use most frequently. Turn the power on and set the meter function switch to the CAL position. Press and hold the microphone push-to-talk button and using the SWR CAL control, adjust the meter to read the CAL position indicated on the meter face. Then, without releasing the microphone button, switch the meter function switch to the SWR position and read the SWR indicated. The lower the figure, the better with 1 being ideal. Generally speaking, readings up to 3 are acceptable, but over 3 indicates that you are losing radiated power and antenna adjustment may be advisable.

Pull knob in the S/Rf position, the meter swings proportionally to the strength of the received signal. When transmitting, the meter indicates relative RF output power.

6. **BAND SELECTOR.** This switch selects A, B, C, D, E or F band of operation.
7. **MODE (CW/FM/AM/USB/LSB) SWITCH.** This switch is used to select CW, FM, AM, LSB or USB mode of operation. Unless the station with which communication is desired is equipped with SSB, the AM or FM mode is normally used. The mode selector switch changes the mode of operation of both transmitter and receiver simultaneously. Turn to "Receiving SSB signals" for a further explanation of single sideband.
8. **CLARIFIER.** Allows variation of the receiver operating frequencies above and below the assigned frequency. Although this control is intended primarily to tune in SSB/CW signals, it may be used to optimize AM/FM signals as described in the Operating Procedure paragraphs. Coarse operates both TX/RX but Fine only in RX.
9. **CHANNEL SELECTOR.** This switch selects any one of the forty Citizens Band channels desired. The selected channel appears on the LED readout directly above the Channel Selector knob.
10. **METER.** This meter indicates received signal strength, transmitter RF output power and SWR level.
11. **+10KHz FREQUENCY SHIFT SWITCH.** When switch is pressed the frequency is shifted 10KHz up. On following channels. A channel can be used by setting this switch to +10KHz position

Normal	+10KHz
3	3A
7	7A
11	11A
15	15A
19	19A

12. **BAND SWITCH-HI/LOW.** This switch is used to select High band and or Low band Frequency Range.

13. **SWR/CAL SWITCH.** When in the "CAL" position, the SWR meter can be calibrated by adjusting the "SWR CAL" control to the "CAL" mark on the meter face.
When in the "SWR" position, the standing wave ratio is measured.
14. **OFF-NB/ANL SWITCH.** In the NB/ANL position, the RF noise blanker is activated and automatic noise limiter in the audio circuits is also activated. The RF noise blanker is very effective for repetitive impulse noise such as ignition interference.
15. **COUNTER SWITCH-ON/OFF.** Depressing this switch causes the receiver or transmitter frequency to be displayed on the frequency counter.
16. **CHANNEL 9 SWITCH.** Channel 9 has been reserved emergency communications involving the immediate safety of life of individuals or immediate protection of property. Channel 9 may also be used to render assistance to a motorist.
17. **FREQUENCY COUNTER.** The frequency counter indicates the of the selected channel you wish to operate on.
18. **RECEIVER/TRANSMIT INDICATOR.** The receiver/transmit LED indicator is located next to the channel indicator. When in receive, the LED will be green. When in transmit the LED will be red.
19. **CHANNEL INDICATOR.** Numbered LED indicates the selected channel you wish to operate on. LED indicates "9" when CH-9 is switched on.

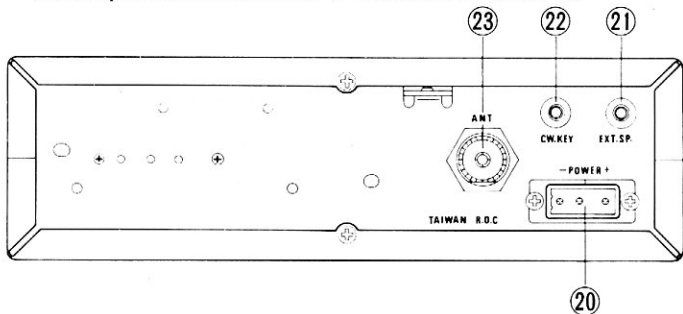

REAR PANEL

20. **POWER.** Accepts 13.8V DC power cable with built-in fuse (4 amp.) to be connected.
21. **EXT SP.** Accepts 4 to 8 ohm, 5 watt external speaker to be connected. When external speaker is connected to this jack, the built-in speaker is automatically disconnected.
22. **CW KEY.** This jack is for Morse code operation; To operate, connect a CW Key to this jack and place the CW/AM/USB/LSB switch in the CW position.
23. **ANTENNA.** Accepts 50 ohm coaxial cable with a type PL-259 plug to be connected.

PRESS-TO-TALK MICROPHONE

The receiver and transmitter are controlled by the press-to-talk switch on the microphone. Press the switch and the transmitter is activated, release switch to receive. When transmitting, hold the microphone two inches from the mouth and speak clearly in a normal "voice". The radios come complete with low-impedance (500 ohm) dynamic microphone. For installation instructions on other microphones, see next section, "ALTERNATE MICROPHONES AND INSTALLATION."

OPERATING PROCEDURE TO RECEIVE

1. Be sure that power source, microphone and antenna are connected to the proper connectors before going to the next step.
2. Turn unit on by tuning VOLUME control clockwise on 侍 samurai.
3. Set the VOLUME for a comfortable listening level.
4. Set the MODE switch to the desire mode.
5. Listen to the background noise from the speaker. Turn the SQUELCH control slowly clockwise until the noise JUST disappears (no signal should be present). Leave the control at this setting. The SQUELCH is now properly adjusted. The receiver will remain quiet until a signal is actually received. Do not advance the control too far, or some of the weaker signals will not be heard.
6. Set the CHANNEL selector switch to the desired channel.
7. Set the RF gain control fully clockwise for maximum RF gain.
8. Adjust the CLARIFIER control to clarify the SSB/CW signals or to optimize AM/FM signals.

OPERATING PROCEDURE TO TRANSMIT

1. Select the desired channel of transmission.
2. Set the MIC GAIN control fully clockwise.
3. If the channel is clear, depress the push-to-talk switch on the microphone and speak in a normal voice.

RECEIVING SSB SIGNALS

There are four types of signals presently used for communications in the Citizens Band: FM, AM, USB, and LSB. When the MODE switch on your unit is placed in the AM position, only standard double-sideband and in FM position, only frequency deviation, full carrier signals will be detected. An SSB signal may be recognized while in the AM or FM mode by its characteristic "Donald Duck" sound and the inability of the AM or FM detector to produce an intelligible output. The USB and LSB modes will detect upper sideband and lower sideband respectively, and standard AM signals.

SSB reception differs from standard AM reception in that SSB receiver does not require a carrier or opposite sideband to produce an intelligible signal. A single-sideband transmitted signal consists only of the upper or the lower sideband and no carrier is transmitted. The elimination of the carrier from the AM signal helps to eliminate the biggest cause of whistles and tones heard on channels which make even moderately strong AM signals unreadable. Also; SSB takes only half of an AM channel, therefore two SSB conversations will fit into each channel, expanding the 800 AM channels to 1600 SSB channels. The reduction in channel space required also helps in the receiver because only *half* of the noise and interference can be received with 100% of the SSB signal.

An SSB signal may be received only when the listening receiver is functioning in the same mode. In other words, an upper sideband signal (USB) may be made intelligible *only* if the receiver is functioning in the USB position.

If a lower sideband (LSB) signal is heard when the receiver is in the USB mode, no amount of tuning will make the signal intelligible. The reason for this may be understood if you consider that when modulation is applied to the transmitter's microphone in the USB mode, the transmitter's output frequency is increased whereas in the LSB mode the transmitter's output frequency is decreased. The result in listening to the receiver is that when the MODE switch is in the proper position (either USB or LSB), a true reproduction of single tone of modulation will result, and if the tone is increased in frequency (such as a low-pitched whistle a high-pitched whistle) you will hear the increase in the output tone of the receiver. If the incorrect mode is selected, an increase in tone of a whistle applied to the transmitter will cause a decrease in the resultant tone from the receiver.

Thus when a voice is used in place of a whistle or tone, in the proper listening mode the voice will be received correctly whereas in the incorrect mode, the voice will be translated backwards and cannot be made intelligible by the voice lock control. When listening to an AM transmission, a correct sideband is heard in either mode since both upper and lower sideband are received.

Once the desired SSB mode has been selected, frequency adjustment may be necessary in order to make the incoming signal intelligible, the CLARIFIER control allows the operator to vary frequency above and below the exact-center frequency of the received signal. If the sound of the incoming signal is high or low pitched, adjust the operation of the CLARIFIER. Consider it as performing the same function as a phonograph speed control. When the speed is set to high, voices will be high-pitched and if set too low, voices will be low-pitched. Also, there is only *one* correct speed that will make a particular record produce the same sound that was recorded. If the record is played on a turntable that rotated in the wrong direction (opposite sideband) no amount of speed control (CLARIFIER) will produce an intelligible sound.

An AM signal received while listening in one of the SSB modes will produce a steady tone (carrier) in addition to the intelligence, unless the SSB receiver is tuned to exactly the same frequency by the CLARIFIER control. For simplicity it is recommended that the AM modes be used to listen to AM signals.

OPERATING PROCEDURE TO CW(CARRIER WAVE) MODE

This is communicated by MORSE-CODE. This can be advantageously used especially while channels in busy or communication in long distance.

- 1. TRANSMIT.** Press CW KEY by MORSE-CODE switching Selector to CW MODE and connections CW KEY or CW KEY JACK. Your 侍 samurai transceiver is automatically changed from RX to TX when CW KEY is in (MARK) and keeping the transmitting condition without being transmitted MORSE-CODE during 0.15-second even if CW KEY is in (SPACE). And, thereafter the unit is set in RX condition automatically. Be sure that the CODE transmitted from your station is heard as monitor sound from internal speaker (see Fig. 1).

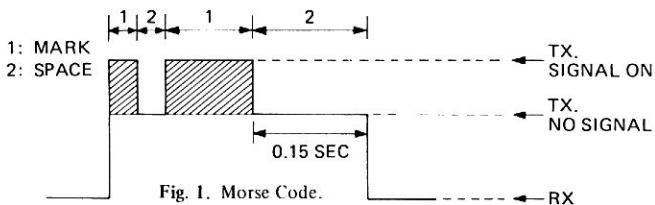

*CAUTION: 1. MARK when CW KEY is closed.
2. SPACE when CW KEY is opened.

- 2. RECEIVE.** Adjust FINE CONTROL of CLARIFIER for your desired sound when your transceiver is received MORSE-CODE Signal.

ROGER BEEP

When your transceiver is on normal operation your radio automatically transmits the audio sign at the end of your transmission. The listener can note easily that your transmission is over through the sign. Please note that this ROGER BEEP transmits 0.15-second at the moment PRESS-TO-TALK SWITCH KNOB is off.

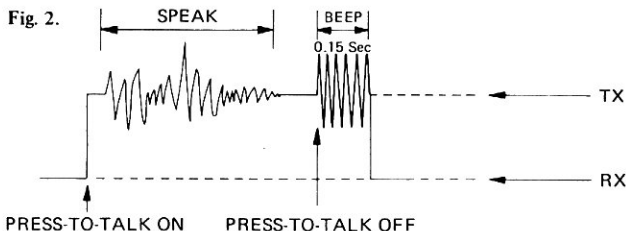

ALTERNATE MICROPHONES AND INSTALLATION

For best results, the user should select a low-impedance dynamic type microphone or a transistorized microphone. Transistorized type microphones have a low output impedance characteristic. The microphones must be provided with a four-lead cable. The audio conductor and its shielded lead comprise two of the leads. The fourth lead is for receive control, and third is for transmit control. The microphone should provide the functions shown in schematic below.

4 WIRE MIC CABLE

Pin Number	Mic Cable Lead
1	Audio Shield
2	Audio Lead
3	Transmit Control
4	Receive Control

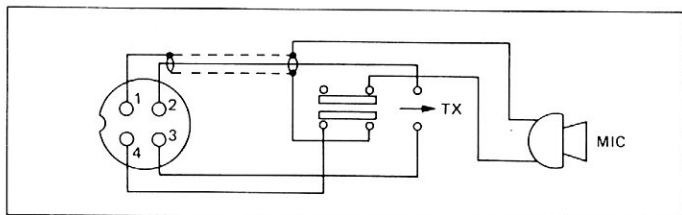

Fig. 3. 侍 samurai microphone schematic.

If the microphone to be used is provided with pre-cut leads, they must be revised as follows.

1. Cut leads so that they extend $7/16$ " beyond the plastic insulating jacket of the microphone cable.
2. All leads should be cut to the same length. Strip the ends of each wire $1/8$ " and tin the exposed wire.

Before beginning the actual wiring read carefully, the circuit and wiring information provided with the microphone you select. Use the minimum heat required in soldering the connections. Keep the exposed wire lengths to a minimum to avoid shorting when the microphone plug is reassembled.

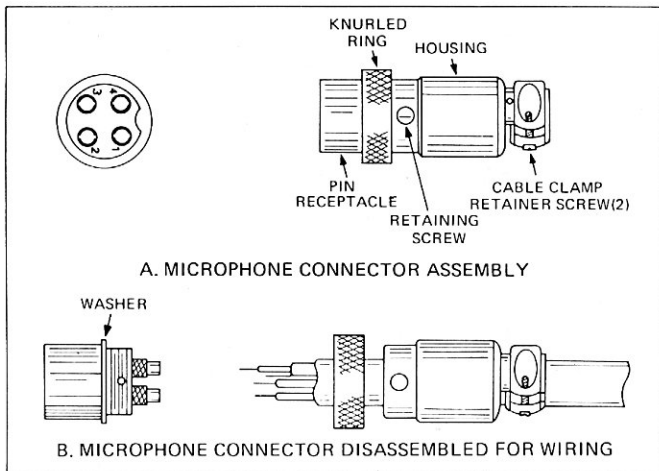

Fig. 4. Microphone plug wiring.

1. Remove the retaining screw.
2. Unscrew the housing from the pin receptacle body.
3. Loosen the two cable clamp retainer screws.
4. Feed the microphone cable through the housing, knurled ring and washer as shown Fig. 4.
5. The wires must now be soldered to the pins as indicated in the above wiring tables. If a vise or clamping tool is available it should be used to hold the pin receptacle body during the soldering operation, so that both hands are free to perform the soldering. If a vise or clamping tool is not available, the pin receptacle body can be held in a stationary position by inserting it into the microphone jack of the front panel. The numbers of the pins of the microphone plug are shown in Fig. 5, as viewed from the back of the plug. Before soldering the wire to the pins, pre-tin the wire receptacle of each pin of the plug.

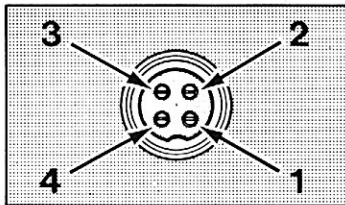

Fig. 5. Microphone plug pin numbers viewed from rear of pin receptacle.

Be sure that the housing and the knurled ring of Fig. 3 are pushed back onto the microphone cable before starting to solder. If the washer is not captive to the pin receptacle body, make sure that it is placed on the threaded portion of the pin receptacle body before soldering.

If the microphone jack is used to hold the pin receptacle during the soldering operation, best results are obtained when the connections to pins 1 and 3 are made first and then the connections to pins 2 and 4. Use a minimum amount of solder and be careful to prevent excessive solder accumulation on pins, which could cause a short between the pin and the microphone plug housing.

6. When all soldering connections to the pins of the microphone plug are complete, push the knurled ring and the housing forward and screw the housing onto the threaded portion of the pin receptacle body. Note the location of the screw clearance hole in the plug housing with respect to the threaded hole in the pin receptacle body. When the housing is completely threaded into the pin receptacle body, a final fraction of a turn either clockwise or counterclockwise may be required to align the screw hole with the threaded hole in the pin receptacle body. When these are aligned, the retaining screw is then screwed into the place to secure the housing to the pin receptacle body.
7. The two cable clamp retainer screws should now be tightened to secure the housing to the microphone cord. If the cutting directions have been carefully followed, the cable clamp should secure to the insulating jacket of the microphone cable.
8. Upon completion of the microphone plug wiring, connect and secure the microphone plug in the transceiver.

A FEW RULES THAT SHOULD BE OBEYED

1. You must identify your official licensed call sign at the beginning and end of every conversation.
2. You are not allowed to carry on a conversation with another station for more than five minutes at a time without taking a one-minute break, to give others a chance to use the channel.
3. You are not allowed to blast others off the air by over-powering them with illegally amplified transmitter power, or illegally high antennas.
4. You can't use CB to promote illegal activities.
5. You are not allowed to use profanity.
6. You may not play music in your CB.
7. You may not use your CB to sell merchandise or professional services.

CHANNEL INFORMATION

Chan nel	ANTENNA FREQUENCY (MHz)											
	A BAND		B BAND		C BAND		D BAND		E BAND		F BAND	
	Nor mal	+10 KHz	Nor mal	+10 KHz	Nor mal	+10 KHz	Nor mal	+10 KHz	Nor mal	+10 KHz	Nor mal	+10 KHz
1	25.615	25.625	26.065	26.075	26.515	26.525	26.965	26.975	27.415	27.425	27.865	27.875
2	25.625	25.635	26.075	26.085	26.525	26.535	26.975	26.985	27.425	27.435	27.875	27.885
3	25.635	25.645 (3A)	26.085	26.095 (3A)	26.535	26.545 (3A)	26.985	26.995 (3A)	27.435	27.445 (3A)	27.885	27.895 (3A)
4	25.655	25.665	26.105	26.115	26.555	26.565	27.005	27.015	27.455	27.465	27.905	27.915
5	25.665	25.675	26.115	26.125	26.565	26.575	27.015	27.025	27.465	27.475	27.915	27.925
6	25.675	25.685	26.125	26.135	26.575	26.585	27.025	27.035	27.475	27.485	27.925	27.935
7	25.685	25.695 (7A)	26.135	26.145 (7A)	26.585	26.595 (7A)	27.035	27.045 (7A)	27.485	27.495 (7A)	27.935	27.945 (7A)
8	25.705	25.715	26.155	26.165	26.605	26.615	27.055	27.065	27.505	27.515	27.955	27.965
9	25.715	25.725	26.165	26.175	26.615	26.625	27.065	27.075	27.515	27.525	27.965	27.975
10	25.725	25.735	26.175	26.185	26.625	26.635	27.075	27.085	27.525	27.535	27.975	27.985
11	25.735	25.745 (11A)	26.185	26.195 (11A)	26.635	26.645 (11A)	27.085	27.095 (11A)	27.535	27.545 (11A)	27.985	27.995 (11A)
12	25.755	25.765	26.205	26.215	26.655	26.665	27.105	27.115	27.555	27.565	28.005	28.015
13	25.765	25.775	26.215	26.225	26.665	26.675	27.115	27.125	27.565	27.575	28.015	28.025
14	25.775	25.785	26.225	26.235	26.675	26.685	27.125	27.135	27.575	27.585	28.025	28.035
15	25.785	25.795 (15A)	26.235	26.245 (15A)	26.685	26.695 (15A)	27.135	27.145 (15A)	27.585	27.595 (15A)	28.035	28.045 (15A)
16	25.805	25.815	26.255	26.265	26.705	26.715	27.155	27.165	27.605	27.615	28.055	28.065
17	25.815	25.825	26.265	26.275	26.715	26.725	27.165	27.175	27.615	27.625	28.065	28.075
18	25.825	25.835	26.275	26.285	26.725	26.735	27.175	27.185	27.625	27.635	28.075	28.085
19	25.835	25.845 (19A)	26.285	26.295 (19A)	26.735	26.745 (19A)	27.185	27.195 (19A)	27.635	27.645 (19A)	28.085	28.095 (19A)
20	25.855	25.865	26.305	26.315	26.755	26.765	27.205	27.215	27.655	27.665	28.105	28.115
21	25.865	25.875	26.315	26.325	26.765	26.775	27.215	27.225	27.665	27.675	28.115	28.125
22	25.875	25.885	26.325	26.335	26.775	26.785	27.225	27.235	27.675	27.685	28.125	28.135
23	25.905	25.915	26.355	26.365	26.805	26.815	27.255	27.265	27.705	27.715	28.155	28.165
24	25.885	25.895	26.335	26.345	26.785	26.795	27.235	27.245	27.685	27.695	28.135	28.145
25	25.895	25.905	26.345	26.355	26.795	26.805	27.245	27.255	27.695	27.705	28.145	28.155
26	25.915	25.925	26.365	26.375	26.815	26.825	27.265	27.275	27.715	27.725	28.165	28.175
27	25.925	25.935	26.375	26.385	26.825	26.835	27.275	27.285	27.725	27.735	28.175	28.185
28	25.935	25.945	26.385	26.395	26.835	26.845	27.285	27.295	27.735	27.745	28.185	28.195
29	25.945	25.955	26.395	26.405	26.845	26.855	27.295	27.305	27.745	27.755	28.195	28.205
30	25.955	25.965	26.405	26.415	26.855	26.865	27.305	27.315	27.755	27.765	28.205	28.215
31	25.965	25.975	26.415	26.425	26.865	26.875	27.315	27.325	27.765	27.775	28.215	28.225
32	25.975	25.985	26.425	26.435	26.875	26.885	27.325	27.335	27.775	27.785	28.225	28.235
33	25.985	25.995	26.435	26.445	26.885	26.895	27.335	27.345	27.785	27.795	28.235	28.245
34	25.995	26.005	26.445	26.455	26.895	26.905	27.345	27.355	27.795	27.805	28.245	28.255
35	26.005	26.015	26.455	26.465	26.905	26.915	27.355	27.365	27.805	27.815	28.255	28.265
36	36.015	26.025	26.465	26.475	26.915	26.925	27.365	27.375	27.815	27.825	28.265	28.275
37	26.025	26.035	26.475	26.485	26.925	26.935	27.375	27.385	27.825	27.835	28.275	28.285
38	26.035	26.045	26.485	26.495	26.935	26.945	27.385	27.395	27.835	27.845	28.285	28.295
39	26.045	26.055	26.495	26.505	26.945	26.955	27.395	27.405	27.845	27.855	28.295	28.305
40	26.055	26.065	26.505	26.515	26.955	26.965	27.405	27.415	27.855	27.865	28.305	28.315

Exclusively manufactured
for Excalibur in JAPAN

Printed in Taiwan
AT2100010B