

**Uniden®**

**UBC800XLT**  
**OWNER'S MANUAL**

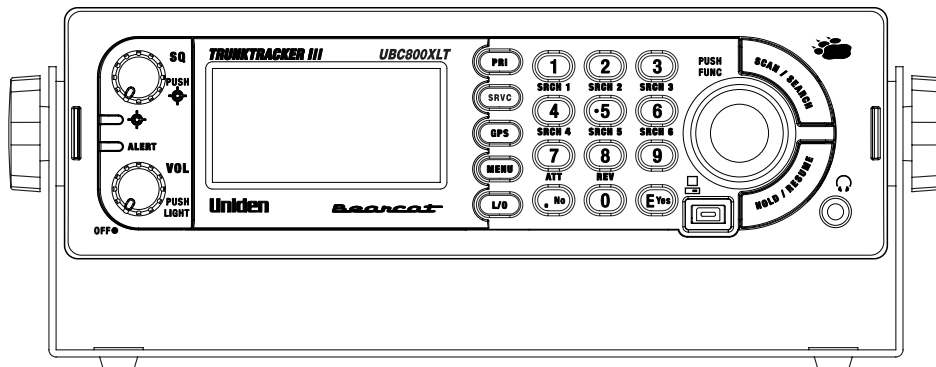

**OWNER'S MANUAL**

## Precautions

Before use this scanner, please read and observe the following.

### **EARPHONE WARNING!**

Be sure to use only a mono earphone with this scanner. You can also use an optional 32 ohms stereo headset. Use of an incorrect earphone or stereo headset might be potentially hazardous to your hearing. The output of the phone jack is monaural, but you will hear it in both headphones of a stereo headset.

Set the volume to a comfortable audio level coming from the speaker before plugging in the mono earphone or a stereo headset of the proper impedance (32 ohms). Otherwise, you might experience some discomfort or possible hearing damage if the volume suddenly becomes too loud because of the volume control or squelch control setting. This might be particularly true of the type of earphone that is placed in the ear canal.

### **WARNING!**

Uniden **does not** represent this unit to be waterproof. To reduce the risk of fire or electrical shock, **do not** expose this unit to rain or moisture.

DPL<sup>®</sup>, Digital Private Line<sup>®</sup>, Motorola<sup>®</sup>, PL<sup>®</sup>, PRIVACY PLUS<sup>®</sup>, Private Line<sup>®</sup>, SMARTNET<sup>®</sup>, and SMARTZONE<sup>®</sup> are registered trademarks of Motorola, Inc.

LTR<sup>®</sup> is a registered trademark of E.F. Johnson Co.

EDACS<sup>®</sup> is a registered trademark of M/A-COM Private Radio Systems Inc.

Uniden<sup>®</sup> and Bearcat<sup>®</sup> are registered trademarks of Uniden America Corporation.

Trunk Tracker<sup>™</sup>, Trunk Tracking<sup>™</sup>, and Close Call<sup>™</sup> are proprietary trademarks of Uniden America Corporation.

Other trademarks used throughout this manual are the property of their respective holders.

## ***Power Related Issues***

**Important:** To prevent memory from being corrupted, do not unplug the AC adapter during the time the memory is accessed for programming or auto store.

### **Notes:**

- If when you connect the AC adapter the **[VOL] /Power Switch** is **ON**, the scanner may not power on. Should this occur, simply turn the control **OFF**, then **ON** again.
- If the scanner loses power (as when you turn off your car's ignition with the scanner's power switch on), it can lose some system settings such as display color and backlight. To ensure that such settings persist, either change the setting using the scanner's menu or power the scanner off then back on using the power switch after making such setting changes. When you turn off the scanner using the power switch, the scanner remembers the last settings and mode. When you turn power back on, it resumes the previous mode.

## **Precautions**

3

# Table of Contents

<b>Precautions</b> .....	<b>2</b>
Power Related Issues .....	3
<b>Table of Contents</b> .....	<b>4</b>
<b>Introduction</b> .....	<b>9</b>
<b>FEATURE SUMMARY</b> .....	<b>10</b>
BAND COVERAGE .....	10
Feature Highlights.....	13
General .....	13
GPS.....	15
Search.....	15
Auto Store .....	16
Priority .....	16
PC Control and Cloning .....	16
Memory Storage Limits.....	17
Search Lockout Limits .....	17
About This Manual.....	17
Using the Scroll Control .....	17
How the Scanner's Controls Are Represented in This Manual .....	18
Entering Text Within A Menu Option.....	18
<b>Understanding Scanning and the UBC800XL</b> .....	<b>19</b>
Understanding the Scanner's Memory .....	19
Understanding Quick Keys .....	19
What is Scanning?.....	20
What is Searching?.....	20
What is CTCSS/DCS? .....	20
Conventional Scanning.....	21
Simplex Operation .....	21
Repeater Operation .....	22
What is Trunk Tracking?.....	22
Trunked Scanning.....	23
Types of Trunking Systems .....	23
Motorola Trunking .....	23
EDACS Trunking.....	24
LTR Trunking .....	25
Startup Configuration.....	26
Setup/Operation .....	26
Multi-Site Trunking.....	26
I-Call (Motorola/EDACS).....	26
Where To Get More Information.....	27
Information On The Internet.....	27

<b>Included With Your Scanner .....</b>	<b>28</b>
<b>Setting Up Your Scanner .....</b>	<b>29</b>
Base Station .....	29
Setting Up an Audio Recording Device or Computer Recording .....	31
Vehicle Installation.....	31
Mounting Using the Bracket.....	31
Mounting Using the DIN-E Sleeve (Optional hardware).....	32
Removing the Scanner from the DIN-E Sleeve.....	34
Mounting Using ISO Technique .....	34
Removing the Display Sticker .....	35
Connecting an Optional Antenna.....	35
Connecting an Earphone/Headphone .....	35
Connecting an Extension Speaker .....	36
<b>Controls, Keys, and Functions .....</b>	<b>37</b>
<b>A Look At The Display .....</b>	<b>42</b>
<b>Operation .....</b>	<b>43</b>
Turning On the Scanner and Setting the Squelch .....	43
Startup Key Operation .....	43
Conventional .....	43
Trunked .....	43
Search Range .....	43
Scanning Systems.....	44
Selecting Systems to Scan.....	45
Selecting System Channel Groups.....	45
Locking/Unlocking Systems.....	45
Locking/Unlocking Channels .....	46
ID Scan/ID Search Mode.....	46
Holding On a System.....	46
Holding On a Channel .....	47
Quickly Storing an ID During ID Search .....	47
Quick-Storing Channels or Talk Group ID's (TGID) .....	47
Trunking Activity Indicators.....	48
Toggling the Display Mode .....	49
<b>Using the Menu .....</b>	<b>50</b>
<b>Programming General Settings .....</b>	<b>51</b>
Setting and Using the Backlight.....	51
Setting the Dimmer .....	51
Adjusting the Key Beep .....	52
Setting the Audio AGC .....	52
Setting the Display Orientation .....	52
Adjusting the Display Contrast .....	52
Setting the GPS Format .....	53
Setting the Position Format.....	53
Setting the Time Format.....	53
Setting the Time Zone.....	53
Setting the Distance Units.....	54
Setting the Serial Port Speed .....	54

**Table of Contents**

Displaying Scanner Information .....	55
Viewing Memory Used .....	55
Viewing the Firmware Version .....	55
Initializing the Scanner's Memory .....	55
Connecting Your Scanner to a Personal Computer.....	55
Volume/Squelch with PC Control .....	56
Wired Cloning .....	56
<b>Programming Your Scanner.....</b>	<b>58</b>
System Settings .....	59
System Options.....	59
Site Settings .....	61
Channel Settings.....	62
Programming Conventional Systems .....	62
Programming Trunked Radio Systems .....	63
Programming System Settings .....	63
Editing the System Name.....	63
Specifying the Correct System Type.....	64
Programming System Options .....	64
Programming Sites .....	71
Programming Channel Groups .....	77
Setting Up a Channel Group .....	77
Editing a Channel Group Name .....	77
Setting the Group Quick Key.....	78
Editing Channels .....	78
Locking Out Channel Groups.....	78
Deleting Channel Groups.....	79
Programming Channels .....	79
Creating a Channel .....	79
Editing the Channel Name (Alpha Tag) .....	79
Editing Frequencies .....	80
Editing the Talk Group ID.....	80
Selecting CTCSS/DCS Tones.....	81
Quick CTCSS/DCS Save .....	81
Setting Channel Modulation Method .....	82
Setting Channel Attenuation .....	82
Setting Channel Priority .....	83
Setting Channel Alert .....	83
Setting Channel Record .....	84
<b>Searching and Storing .....</b>	<b>86</b>
Service Search .....	86
Quick Search .....	87
Custom Search .....	87
Editing a Custom Search Range .....	88
Search With Scan .....	90
Set Delay Time .....	91
Set Attenuator.....	91
Set Record.....	91
Assigning a Search Range to a Search Key.....	91

Saving a Found Channel (Quick Save) .....	92
Auto Search and Store .....	92
Selecting a System to use for Storing .....	92
Conventional Search and Store .....	92
Trunked Search and Store .....	93
<b>Using the Close Call Feature .....</b>	<b>94</b>
Setting Close Call Options .....	94
Close Call Hits .....	96
Close Call Hits with Scan .....	97
<b>Search and Close Call Options .....</b>	<b>98</b>
Managing Locked-Out Frequencies .....	98
Unlocking All Frequencies .....	99
Reviewing Locked-Out Frequencies .....	99
Searching for Subaudible Tones .....	99
Screening Out Broadcast Sources .....	99
Setting the Maximum Auto Store Value .....	100
Setting the Modulation Type .....	101
Setting Attenuation .....	101
Setting Data Skip .....	101
Setting the Delay Time .....	102
Setting the Search Frequency Step .....	102
Setting Air Band Step .....	103
Setting Record .....	103
Priority Scan .....	103
<b>Fire Tone-Out .....</b>	<b>105</b>
Setting Tone-Out Standby .....	105
Setting Up Tone-Out .....	105
Tone-Out Multi-Channel Monitoring .....	107
Set Record .....	107
<b>Using the UBC800XLT with a GPS .....</b>	<b>108</b>
Device Compatibility .....	108
Connecting Your Scanner to a GPS Device .....	108
Initial Scanner/GPS Operation .....	108
Location-Based (GPS) Scanning .....	109
Non-Radio Location Based GPS Features .....	109
Setting the Options .....	111
Deleting a Location .....	111
For POI Only .....	112
For Dangerous Xing, and Dangerous Road Only .....	112
GPS Review Location Mode .....	113
<b>Care and Maintenance .....</b>	<b>115</b>
General Use .....	115
Location .....	115
Cleaning .....	115
Birdies .....	115

<b>Troubleshooting</b> .....	<b>116</b>
<b>Other Specifications</b> .....	<b>119</b>
<b>Reference</b> .....	<b>120</b>
Preset Fleet Maps .....	120
User Defined Fleet Maps .....	122
Type I Programming Information .....	122
Size Code Restrictions .....	123
CTCSS Frequencies .....	124
DCS Codes .....	124
<b>Appendix</b> .....	<b>125</b>
<b>SERVICE SEARCH RANGES</b> .....	<b>125</b>
Air .....	125
Marine .....	125
CB AM Radio .....	126
CB FM Radio .....	132
PMR .....	137
LPD .....	138
<b>Index</b> .....	<b>139</b>
<b>Declaration of Conformity</b> .....	<b>143</b>



## Introduction

Your UBC800XLT scanner is a state-of-the-art scanner radio with Trunk Tracker III™ and automatic scanning capabilities. You can store in the dynamic memory conventional frequencies such as police, fire/emergency, marine, air, amateur, and other communications. You can store and scan services that use Trunked Radio Systems and so much more. You can use the scanner's Scroll Control to quickly select channels and frequencies, and you can automatically program channels in a system using the Auto Store feature. Use your scanner to monitor:

- Analog trunked systems (unencrypted only)
- Police and fire departments (including rescue and paramedics)
- Business/Industrial radio and utilities
- Marine and amateur (ham radio) bands
- Air band
- Railroad

These table list the frequency ranges, default frequency step and default mode (AM or FM).

To select a band plan from 1,2 and 3;

1. Make sure the power is turned off.
2. While holding down 1,2 or 3 (corresponding number of the band plan) and Function knob, turn on the scanner.

# FEATURE SUMMARY

## BAND COVERAGE

< Band Plan 1 >

Frequency (MHz)		Modulation	Step (kHz)	Remark
Lower Edge	Upper Edge			
25.0000	29.9950	FM	5	
30.0000	79.9875	FM	12.5	
80.0000	82.9900	FM	10	
83.0000	87.2875	FM	12.5	
87.3000	107.9500	FMB	50	
108.0000	136.9875	AM	12.5	AIR BAND
108.0000	136.9916		/ 8.33	
137.0000	137.9950	FM	5	
138.0000	157.9875	FM	12.5	
158.0000	160.5900	FM	10	
160.6000	162.5875	FM	12.5	
162.6000	173.9900	FM	10	
174.0000	215.9500	WFM	50	
216.0000	224.9950	FM	5	
225.0000	399.9750	AM	25	
400.0000	405.9875	FM	12.5	
406.0000	439.9937	FM	6.25	
440.0000	465.9950	FM	5	
466.0000	469.9900	FM	10	
470.0000	512.0000	FM	6.25	
806.0000	960.0000	FM	12.5	
1240.0000	1300.0000	FM	12.5	

< Band Plan 2 >

Frequency (MHz)		Modulation	Step (kHz)	Remark
Lower Edge	Upper Edge			
25.0000	49.9950	FM	5	
50.0000	84.0100	FM	5	
84.0150	87.2950	FM	20 with 15kHz Offset	
87.3000	107.9500	FMB	50	
108.0000	136.9875	AM	12.5 / 8.33	AIR BAND
108.0000	136.9916			
137.0000	143.9950	FM	5	
144.0000	145.9875	FM	12.5	
146.0000	155.9900	FM	10	
156.0000	157.4250	FM	12.5	
157.4375	160.5875	FM	12.5	
160.6000	162.0250	FM	12.5	
162.0300	173.9900	FM	10	
174.0000	215.9500	WFM	50	
216.0000	224.9950	FM	5	
225.0000	399.9750	AM	25	
400.0000	405.9875	FM	12.5	
406.0000	439.9937	FM	6.25	
440.0000	449.9937	FM	6.25	
450.0000	469.9900	FM	10	
470.0000	512.0000	FM	6.25	
806.0000	960.0000	FM	12.5	
1240.0000	1300.0000	FM	12.5	

FEATURE SUMMARY

< Band Plan 3 >

Frequency (MHz)		Modulation	Step (kHz)	Remark
Lower Edge	Upper Edge			
25.0000	29.9950	FM	5	
30.0000	79.9937	FM	6.25	
80.0000	82.9937	FM	6.25	
83.0000	87.2937	FM	6.25	
87.3000	107.9500	FMB	50	
108.0000	136.9875	AM	12.5	AIR BAND
108.0000	136.9916		/ 8.33	
137.0000	137.9950	FM	5	
138.0000	157.9937	FM	6.25	
158.0000	160.5937	FM	6.25	
160.6000	162.5937	FM	6.25	
162.6000	173.9937	FM	6.25	
174.0000	215.9500	WFM	50	
216.0000	224.9950	FM	5	
225.0000	399.9750	AM	25	
400.0000	405.9875	FM	12.5	
406.0000	439.9937	FM	6.25	
440.0000	465.9937	FM	6.25	
466.0000	469.9937	FM	6.25	
470.0000	512.0000	FM	6.25	
806.0000	960.0000	FM	12.5	
1240.0000	1300.0000	FM	12.5	

- These Frequency Ranges suit to initial step setting. Step setting will change them.
- These Modulations are initial settings. They can be selected from AM / FM / NFM / WFM / FMB / AUTO.
- These Steps are initial settings.  
Steps can be selected from 5 / 6.25 / 8.33 / 10 / 12.5 / 15 / 20 / 25 / 50 / 100 / AUTO (kHz).
- If "AUTO" is selected for Modulation or Step, the scanner works with the modulation or step of this table.
- If the Step is set to 15 kHz, inputable frequencies are xxx.x000, xxx.x150, xxx.x300, xxx.x450, xxx.x600, xxx.x750, and xxx.x900. For example, the next frequency of 400.0900 MHz is 400.1000 MHz.
- If the Step is set to 8.33kHz, inputable frequencies are xxx.x000, xxx.x083, xxx.x166, xxx.x250, xxx.x333, xxx.x416, xxx.x500, xxx.x583, xxx.x666, xxx.x750, xxx.x833, and xxx.x916.  
For example, the next frequency of 100.0916 MHz is 100.1000 MHz.

## Feature Highlights

### General

**DIN-E and ISO Vehicle Mountable** — using an included DIN-E sleeve or a standard ISO technique, the scanner can be easily mounted in most vehicles.

**Close Call™ RF Capture Technology** — Instantly detects and tunes to nearby transmissions with no additional programming. See “Using the Close Call Feature” on Page 94 for more information.

**Close Call Do-Not-Disturb** — Checks for Close Call activity in between channel reception so active channels are not interrupted.

**Close Call Temporary Store** — Temporarily stores and scans the last 10 Close Call hits so that you can continue to monitor activity on those frequencies, even after you are out of Close Call detection range.

**Dynamically Allocated Channel Memory** — Your scanner’s 6,000 channels are organized so that it more closely matches how radio systems actually work, making it easier to program and use your scanner and determine how much memory you have used and how much you have left.

**100 Quick Keys** — You can set the scanner so you can quickly select systems and groups by using the keypad. This makes it easy to listen to or quickly lock out those systems or groups you don’t want to scan.

**6 Service Searches** — Frequencies are preset in separate Air, Marine, CB AM Radio, CB FM Radio, PMR and LPD, to make it easy to search for specific transmissions.

**“Soft” Search Keys** — Lets you quickly search specified ranges.

**Channel Lockout** — You can lock out any system, group, frequency, or channel while scanning. If you lock out a system or group, any channels belonging to that system or group are also locked out.

**Frequency Lockout** — You can lock out up to 500 frequencies (250 permanently locked out + 250 temporarily locked out). The scanner skips locked-out frequencies while using the Close Call™ feature or while searching.

**CTCSS and DCS Squelch Modes** — Prevent interference from stations not using the tone code you select.

**Audio AGC** — Helps automatically balance the volume level between different radio systems.

### FEATURE SUMMARY

**Fire Tone-Out Standby** — Lets you set the scanner to alert you if a two-tone sequential page is transmitted. You can set up to 10 settings (transmit frequency, tone frequencies) then select one for standby monitoring. Up to ten tone-outs on the same RF setting can be scanned at one time.

**Broadcast Screen** — Lets you input up to 10 frequency ranges that the scanner will ignore during Close Call™ or search operation.

**Scan/Search Delay** — The scanner pauses at the end of a transmission to wait for a reply. You can set the delay time for each system you scan, and while searching and using the Close Call™ feature.

**Attenuator** — Reduces the input strength of strong signals by about 20 dB.

**Channel Alert** — Alerts you when there is activity on any channel you specify using your choice of nine unique alert tones.

**Memory Check** — Lets you see at a glance how much total memory is left.

**Search with Scan Operation** — Lets you include selected service searches or custom search ranges during normal scan operation.

**Custom Alerts** — For each alert in the scanner (such as channel alert, Close Call alert, emergency alert), you can select from 9 different tone patterns and also set the alert volume level independently from the main volume level.

**Automatic Channel Step** — Accepts frequencies on any valid channel step, even if it does not fall within the band plan's default step.

**Frequency Step** — Lets you select a frequency step (5, 6.25, 8.33, 10, 12.5, 15, 20, 25, 50 or 100 kHz) for manual mode and search mode.

**Text Tagging** — You can name each system, group, channel, talk group ID and custom search range using up to 16 characters per name.

**Data Skip** — Allows your scanner to skip unwanted data transmissions and reduces the effect of birdies.

**Duplicate Frequency Alert** — Alerts you if you try to enter a duplicate name or frequency already stored in a system.

**Memory Backup** — If power is lost or disconnected, the scanner retains the frequencies you programmed in its memory.

**Temporary Lockout** — Makes it easy to temporarily lock out a system, channel, or frequency. The lockout is cleared when you turn power off, then back on so you don't have to remember to unlock the channels later.

**Startup Configuration** — Lets you easily manage multiple configurations for your scanner.

**Single-Handed Function Control Operation** — You can tap the Function/Scroll Control to enable the Function mode. It reverts to normal mode in about 3 seconds from your last press if no other action occurs.

**Record Output Jack** — Using the appropriate cable and audio recording device with signal control, you can record live audio of designated channels.

**Display and Keypad Backlight** — Makes the display and keypad easy to see in dim light using three levels plus off.

**Vehicle Power Connection (Orange Wire)** — Lets you connect to your vehicle's dimmer circuit to also dim the scanner's display with the vehicle's dimmer control.

**Trunk Tracker III™ Operation** — Follows unencrypted conversations on analog Motorola, EDACS, EDACS SCAT, and LTR trunked radio systems, including systems in VHF, UHF, 800 MHz, and 900 MHz bands. The scanner can scan both conventional and trunked systems at the same time.

**Multi-Site Trunking** — Lets you share system channels across multiple sites to more efficiently use the scanner's memory and more easily select sites to monitor.

**Control Channel Only Scanning** — If the scanner is set to scan a Motorola system, you can set it so it scans using only control channel data. You do not have to program voice channel frequencies into memory in this mode as long as all possible control channels are programmed.

## GPS

**Location Based Scanning** — If you connect a GPS unit to the scanner it can automatically enable and disable systems based on the Location Information (longitude, latitude, Range) that you provide.

**GPS Non-Radio Based Features** — The scanner alerts you to Dangerous Intersections, Speed Alerts, and Points of Interest that you program into the scanner.

**GPS Display Mode** — Lets you display extended GPS information such as Distance to a POI, Direction to a POI, Time to a POI, Speed, Position, and more.

## Search

**Service Search** — Lets you quickly select and search the scanner's preprogrammed frequencies.

## FEATURE SUMMARY

**Custom Search** — Lets you program up to 10 custom search ranges. You can search any of these ranges simultaneously.

**CTCSS/DCS Search** — Lets the scanner search for CTCSS or DCS tones or codes on any channel or during a search. The scanner can identify up to 50 CTCSS tones and 104 DCS codes.

**Quick Search** — Lets you search from the currently-tuned frequency if you are searching a conventional system.

## ***Auto Store***

**Frequency AutoStore** — Automatically stores all active frequencies into the selected conventional system.

**Talk Group ID AutoStore** — Automatically stores all new talk group ID's into a channel group you select.

## ***Priority***

**Priority Scan** — Priority channels let you keep track of activity on your most important conventional channel(s) while monitoring transmissions on other channels.

**Priority Plus** — You can set the scanner so it scans only the priority channels.

## ***PC Control and Cloning***

**PC Control** — You can transfer programming data to and from your scanner and your personal computer, and control the scanner using a computer. This helps you find frequencies listed on the Internet and load them into the scanner. PC control and programming software will be available at <http://www.butelsoftware.com/>.

**Clone Mode** — You can clone all programmed data, including the contents of the scanner's memory, menu settings, and other parameters from one UBC800XLT scanner to another UBC800XLT scanner.



## Memory Storage Limits

Systems	Sites	Sites per Systems	Groups per System	Total Channels
500	1000	256	20	6000

Channels per Conventional Systems	Channels per Trunked Systems	Trunked Frequencies per Site*
1000	250	750-1000

\* depending on the number of TGID in the system.

## Search Lockout Limits

Frequencies	Temporary L/O Frequencies	Permanent L/O Frequencies	Skipped	Review
500	250	250	Search Mode Close Call Mode	Menu Mode

## About This Manual

The screen displays used in this manual are representations of what might appear when you use your scanner. Since what you see depends on the frequencies and user IDs for your area and the settings you select, you might notice some differences between what is in this manual and what appears on your scanner.





To get the most from this manual, review the contents to become familiar with the basic functions available. If you are new to scanning or trunk tracking, start with the following short introduction to scanning and follow-up with the enclosed reprinted article on Programming provided with the courtesy of *Popular Communications* magazine.

### Using the Scroll Control

The **Scroll Control** is a dual purpose control. It also lets you switch to secondary function operations. When used in this manner, you see  in this manual. Located prominently on the right of the UBC800XLT's front panel, the knob/switch lets you easily control channel selection, plus Normal and Function Modes, as well as how most of the information appears on the display.

**To adjust menu settings, change channels in Hold mode, and resume scanning:** Simply turn the **Scroll Control**.



## FEATURE SUMMARY

To use  tap the **Scroll Control**. This action is written in shorthand as  which is fully explained in the next section. When you tap the control  appears and remains in the upper left corner of the display for 3 seconds. During this time, press any button to access the button's second function. Or, press and hold the Scroll Control for 2 seconds. The scanner beeps, and the function is "latched" so that it does not return to normal mode until you tap the Scroll Control again.  flashes at approximately 1 second intervals.



If you select Function while scanning, the UBC800XLT continues to scan, but holds on the current system until the function operation is cancelled.

### ***How the Scanner's Controls Are Represented in This Manual***

To help navigate the scanner's menus, the steps shown in this manual show the displays you see and the keys you press or control you operate to get a desired result. We use a form of shorthand symbols to save space.

The following example shows you how to use the scanner's menu to edit an existing system name. It shows you the key to press in brackets **[MENU]** to select a menu option and the option you see on the LCD in Boldface Courier type (**Program System**) when you press **[MENU]**. It also instructs you to turn the **Scroll Control** (shown as ) to view a series of choices then *press* or *tap* the **Scroll Control** (the shorthand action shown as ) to *enter* a choice such as **Edit Name**.

**[MENU]** → **Program System** → 

 Select the system → 

**Edit Name** →  Then, edit the system name.

### ***Entering Text Within A Menu Option***

To enter a letter, turn the **Scroll Control** () until the letter, numeral or other character you want appears. To move the cursor to the left, press **[4]**. To move the cursor to the right, press **[6]**.

To clear a character, press **[.No]** twice. To clear all characters, press **[.No]** three times.

To accept an entry, press  or press **[EYES]**.

To cancel an entry, press **[MENU]**.

## Understanding Scanning and the UBC800XLT

This section provides you with additional background on how scanning works and how your scanner provides that feature. You don't really need to know all of this to use your scanner, but some further background knowledge will help you get the most from your UBC800XLT.

### Understanding the Scanner's Memory

Your scanner's memory is organized in an architecture called *Dynamic Allocated Channel* memory. This type of memory is organized differently and more efficiently than the bank/channel architecture used by traditional scanners. Dynamic Allocated design matches how radio systems actually work much more closely, making it easier to program and use your scanner and determine how much memory you have used and how much you have left.

Instead of being organized into separate banks and channels, your scanner's memory is contained in a *pool*. You simply use as much memory as you need in the pool to store as many frequencies, and talk group ID's as desired. No memory space is wasted, and you can tell at a glance how much memory you have used and how much remains.

With a traditional scanner, when you program it to track a trunked system, you must first program the frequencies. Since you can only program one trunking system per bank in a traditional scanner, if there were (for example) 30 frequencies, the remaining channels in the bank are not used and therefore wasted. Also, since some trunked systems might have hundreds of talk groups, you would have had to enter those types of systems into multiple banks in order to monitor and track all the ID's.

### Understanding Quick Keys

Traditional "Banked" scanners let you select and deselect banks by pressing a single digit on the keypad. The UBC800XLT uses a similar method to turn on and off scanning sites and systems. When you program a system or site, you assign a quick key (System/Site Quick Key, or SQK) from 0 to 99. You can use the same quick key for multiple systems, so that the systems are turned on and off together. To turn a system/site on or off, just press the digit corresponding to the assigned SQK. For two-digit SQK's, first press **[.No]**, then enter the two-digit SQK.

The UBC800XLT lets you assign another quick key to a group of channels within a system. This group quick key (GQK) can be from 0-9. To turn on and off channel groups, you press **⏏** while the scanner is scanning the system containing the

channels, then press the GQK within 2 seconds. Systems can have up to 20 channel groups, and multiple channel groups can be assigned to the same GQK.

## What is Scanning?

Unlike standard AM or FM radio stations, most two-way communications do not transmit continuously. Your UBC800XLT scans programmed channels until it finds an active frequency, then stops on that frequency and remains on that channel as long as the transmission continues. When the transmission ends, the scanning cycle resumes until the scanner receives another transmission.

## What is Searching?

The UBC800XLT can search each of its 6 service search ranges and up to 10 custom search ranges to find active frequencies. This is different from scanning because you are searching for frequencies that have not been programmed into the scanner's channels. You set the upper and the lower values of the range and then the scanner searches for any active frequency within the limits you specify. When the scanner finds an active frequency, it stops on that frequency as long as the transmission lasts. If you think the frequency is interesting, you can program it into the scanner's memory. If not, you can continue to search.



## What is CTCSS/DCS?



Your scanner can monitor systems using a Continuous Tone Coded Squelch System (CTCSS) and Digital Coded Squelch (DCS) system, which allow squelch to open only when the tone you have programmed with a specific frequency is received along with a transmission.

CTCSS and DCS are sub-audible tone signaling systems sometimes referred to as PL or DPL (Motorola's trademarked terms for Private Line and Digital Private Line respectively). CTCSS and DCS are used only for FM signals and are usually associated with both amateur and commercial two-way frequencies. These systems make use of a special sub-audible tone that accompanies a transmitted signal.

CTCSS and DCS are used for many purposes. In many cases, CTCSS and DCS are used to restrict access to a commercial repeater, so that only those units which transmit the correct tone along with their signal can "talk" to the repeater.

CTCSS and DCS are also used in areas that receive interference where there are several stations with output frequencies close to each other. When this occurs, you might hear multiple communications on the same frequency. The stations might

even interfere with each other to the point where it is impossible to clearly receive any of the stations. A scanner, such as your UBC800XLT, equipped with CTCSS and DCS, can code each received frequency with a specific sub-audible CTCSS or DCS frequency or code. Then, when you receive multiple signals, you only hear the transmission with the CTCSS or DCS tone you programmed. If you do not receive the correct tone with a signal, the scanner's squelch remains closed and you hear nothing.

The tables showing the available CTCSS frequencies and DCS codes are found in the Reference Section of this manual.

## Conventional Scanning

Conventional scanning is a relatively simple concept. Each group of users in a conventional system is assigned a single frequency (for simplex systems) or two frequencies (for repeater systems). Any time one of them transmits, their transmission always goes out on the same frequency. Up until the late 1980s, this was the primary way that radio systems operated.

Even today, there are many 2-way radio users who operate using a conventional system:

- Aircraft
- Amateur radio
- LPD/PMR users
- Broadcast AM/FM/TV stations
- Many business radio users

When you want to store a conventional system, all you need to know are the frequencies they operate on. When you are scanning a conventional system, the scanner stops very briefly on each channel to see if there is activity. If there isn't, the scanner quickly moves to the next channel. If there is, then the scanner pauses on the transmission until it is over.

## Simplex Operation

Simplex systems use a single frequency for both transmit and receive. Most radios using this type of operation are limited to line-of-sight operation. This type of radio is frequently used at construction job sites, and with inexpensive consumer radios such as LPD/PMR radios. The range is typically 1-15 miles, depending upon the terrain and many other factors.

## Repeater Operation

Repeater systems use two frequencies: one transmits from the radio to a central repeater; the other transmits from the repeater to other radios in the system. With a repeater-based system, the repeater is located on top of a tall building or on a radio tower that provides great visibility to the area of operation. When a user transmits (on an input frequency), the signal is picked up by the repeater and retransmitted (on an output frequency). The user's radios always listen for activity on the output frequency and transmit on the input frequency. Since the repeater is located very high, there is a very large line of sight.

Typical repeater systems provide coverage out to about a 25-mile radius from the repeater location.

## What is Trunk Tracking?

Your UBC800XLT is designed to track the following types of trunking systems.

- Motorola Type I, Type II, Type III hybrid, SMARTNET, and PRIVACYPLUS analog trunking systems, which are extensively used in 800 MHz communication systems.
- LTR trunking systems
- EDACS SCAT trunking systems
- EDACS trunking systems

When tracking these types of systems, you might want to remember that your scanner can track more than one trunking system at a time and scan conventional and trunked systems at the same time.

Conventional scanning is a simple concept. You enter a frequency used by someone you want to monitor into your scanner's memory. For example, the police in your area might transmit on 460.500 MHz, the fire department on 154.445 MHz, the highway department on 37.900 MHz, etc. So when your scanner stops on a frequency, you usually know who it is, and more importantly, you can stop on a channel and listen to an entire conversation. This type of scanning is easy and fun.

However, as the demand for public communications has increased, many public radio users do not have enough frequencies to meet their needs, creating a serious problem. Trunking radio systems help solve this problem.

## Trunked Scanning

While conventional scanning worked great while there were only a few groups wanting to use the frequencies, with the advent of smaller, lower-cost radios more and more agencies and businesses wanted to take advantage of the utility of 2-way radio. As a result, the bands that were used most became full, so new users were not able to take advantage of the technology as quickly as they wanted.

Trunking solved this frequency shortage by allowing multiple groups to use the same set of frequencies in a very efficient way. While each type of trunking system operates a little differently (see the next few sections), they all work on the same basic premise: even in a system with a lot of users, only a few users are ever transmitting at any one time.

Instead of being assigned a frequency, as with conventional systems, each group is assigned a talk group ID. A central computer controls the frequency each group operates on. This frequency selection is made each time a user transmits. So, while on a conventional system queries, replies, and follow-ups are all on a single frequency, they could each be on completely different frequencies on a trunked system. This semi-random frequency assignment made monitoring such a system impossible prior to Uniden's invention of the TrunkTracker scanner.

Not only does your UBC800XLT scan channels like a conventional scanner, it actually follows the users of a trunked radio system. Once you know and program a talk group's ID (TGID), you won't miss any of the action.

If you are a new scanner enthusiast, you might want to read the first part of this manual and use your scanner in conventional mode before you begin trunk tracking. Understanding scanning fundamentals and terminology will make trunk tracking much easier. If you are already an experienced scanner operator, you can review the programming worksheets and their associated pages on the Uniden website.

## Types of Trunking Systems

Trunking systems divide a few frequencies among many different users, but the way that each system does this is slightly different. This section describes some of the technical data behind Motorola, EDACS, and LTR trunked radio systems.

### *Motorola Trunking*

While there are different types of Motorola trunking systems, they all use the same basic trunking method. The system consists of one control channel (or as many as 4 per system but only one is active at any one time), plus one or more voice

channels (typically 10, 20, or 28 total channels). When a user presses Push To Talk (PTT) to transmit, their radio first sends the person's talk group information to the control channel. The computer then assigns that talk group to a specific voice channel and transmits that data over the control channel. All radios in that talk group switch over to the assigned voice channel and the user can begin speaking. This all typically takes place in about a second. The person transmitting hears a beep from their radio when the channel is assigned. Then it is OK to start talking.

The systems in use are:

**Motorola Type I** — the radios send the radio ID, the fleet and subfleet talk group ID to the control channel each time they transmit. To program a Type I system, you need to know the system's *fleet map*. The most common fleet maps are included in the Reference section in this manual. You can also find fleet map resources on the web such as at <http://www.radioreference.com>.

**Motorola Type II** — the radios only send the radio ID and radio channel code to the control channel. The central computer keeps a database of radio ID's and which talk group is assigned to which channel code for each radio, so with this system the user's radio sends only about  $\frac{1}{3}$  the data as a Type I system with each transmission. Type II systems do not use Fleet-subfleet talk groups; instead they use a 5-digit ID for each talk group.

**Type III Hybrid** — these systems support a mix of both Type I and Type II users. Like Type I systems, you must know the system's fleet map to ensure proper tracking.

### **EDACS Trunking**

EDACS trunking works in much the same way as Motorola trunking with a couple of major differences. In an EDACS system, each frequency used by the system is assigned a Logical Channel Number (LCN) so that less data needs to be transmitted by the control channel. Talk groups are assigned in an Agency-Fleet-Subfleet (AFS) hierarchy. There is one variation of EDACS called SCAT that your UBC800XLT can monitor.

**Logical Channel Numbers** — each frequency used by the system is assigned an LCN. This information is programmed into each user radio. When a user presses PTT, their radio sends their AFS information to the control channel. The computer then assigns that talk group to a channel and sends the LCN so that all other radios in that talk group will switch to the correct channel. To program an EDACS system in your scanner, you will need to know both the frequencies used by the system and the LCN for each frequency.



**Agency-Fleet-Subfleet** — talk group ID's for EDACS systems are assigned in a way that makes it easy to see at a glance the affiliation of the user. Each radio is assigned a 2-digit agency identifier from 00 — 15. For example, 01 might be used by the police, 02 by the ambulance service, 03 by the fire department, and so on. Each agency is then subdivided up to 16 times to provide fleet identification, and then 8 more times to identify subfleets.

For example, the complete AFS for the Police Department West District's dispatch channel might be 01-062. 01 identifies the agency as the police department, 06 identifies the fleet as the West district, and 2 identifies the subfleet as the dispatch channel. While these assignments are somewhat arbitrary and vary from system to system, there are many resources on the web for finding the assignments for most systems. Because of the logical hierarchy of the AFS system, your UBC800XLT lets you assign wildcard ID's that let you, for example, use only one ID memory to identify all units in either an agency or a fleet.

**EDACS SCAT** — (Single Channel Autonomous Trunking) systems operate on a single channel and alternate control data with analog voice traffic. While your UBC800XLT cannot track ID's in this system, it can eliminate the control data so that all you hear is the voice transmissions when you monitor this type of system.

### ***LTR Trunking***

LTR (Logic Trunked Radio) systems are trunking systems used primarily by business or private communications service providers, such as taxicabs, delivery trucks, and repair services. These systems encode all control information as digital sub audible data that accompanies each transmission, so there is no separate control channel. Users on an LTR system are assigned to specific talk groups, which are identified by the radio as six digit numbers.

These numbers are in the form AHHUUU, where:

- A = Area code (0 or 1)
- H = Home repeater (01 through 20)
- U = User ID (000 through 254)

When the scanner receives a transmission on a channel set to the LTR mode, it first decodes the LTR data included with the transmission. In the ID search mode, the scanner stops on the transmission and displays the talk group ID on the display. In the ID scan mode, the scanner only stops on the transmission if the LTR data matches a talk group ID that you have stored in the talk group ID list and have not locked out. LTR systems are frequently programmed so that each radio has a unique user ID.

## Startup Configuration

### Setup/Operation

The Startup Configuration option lets you quickly and automatically lock and unlock systems based on your desired configuration. Simply hold down a number button while powering on the scanner or while the opening screens are displayed. Systems assigned to that number are automatically unlocked and systems assigned to other numbers are automatically locked. Systems that are not assigned to any startup configuration are left unchanged.

You could use this feature to give you quick, single-press Quick Key access to your favorite systems even when you travel to other locations. For example, if you program your scanner as follows:

System/Site Quick Key	Configuration 1	Configuration 2
1	Fort Worth	Phoenix
2	Tarrant County	Mesa
3	Arlington	Mariposa Cnty

When you are in the Fort Worth area, press **[1]** while turning on the scanner. System Quick Keys **[1]**, **[2]**, and **[3]** then allow you to select between the local systems. When you travel to the Phoenix area, hold **[2]** while turning on the scanner. Now, the Fort Worth systems are locked out and System Quick Keys **[1]**, **[2]**, and **[3]** allow selection between the Phoenix-area systems.

### Multi-Site Trunking

Some systems covering a very large geographic area use multiple antenna sites that each operate on different frequencies, but that use the same Talk Group ID's for traffic. When programming such a system, you program each site's frequencies and other settings into the system, then program the channels into channel groups within that system. Each site can have its own quick key, so you can turn each individual site on or off while you scan. Since all sites share all the channels within the system, multi-site trunking is much more efficient than programming each site as a separate system.

### I-Call (Motorola/EDACS)

I-calls are direct unit-to-unit transmissions that are not heard by other system users. Your UBC800XLT can receive I-call transmissions. See "Setting I-Call

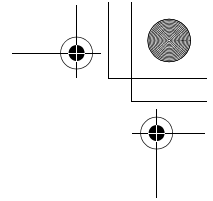
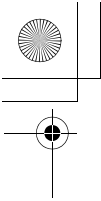

(Motorola and EDACS Systems Only)” on Page 68 for more information about monitoring I-call transmissions.

## Where To Get More Information

By itself, this manual only provides part of what you need to know to have fun scanning — how to program and use the scanner. Other sources provide additional information.

### *Information On The Internet*

The Internet is a great source for current frequencies and information about scanning. Many web sites have lists of frequencies for your area. You can use a search engine to find and use them.

Make a list of the agencies you want to listen to, then look up the frequencies and systems used by those agencies.

*www.butelsoftware.com* — Programming software.

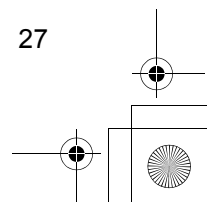
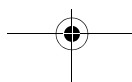
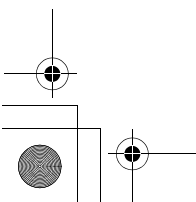
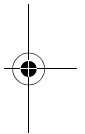
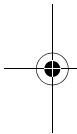

## Included With Your Scanner



UBC800XLT  
Scanner



AC Adapter  
(P/N AD-968)



Cigarette Lighter  
Adapter Power Cord



Three Wire DC (with Orange Wire –  
See Step6 on Page 33) Power Cord

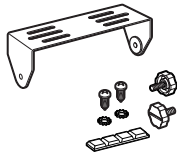

Mounting Bracket  
and Hardware



Push-on type  
Telescopic Antenna



Remote PC to Scanner  
Cable (scanner plug to  
Front PC Connector)

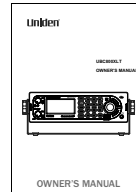

Owner's Manual and  
Other Printed Material

## Setting Up Your Scanner

These guidelines will help you install and set up your new scanner:

The UBC800XLT can be placed on a convenient surface in your home as a base station, and connected to a standard outlet. You must use either the supplied antenna or an electrically correct outdoor antenna, properly and safely mounted at your chosen site.

The scanner is also designed to accommodate the DIN-E and ISO-DIN automotive mounting configurations. A DIN-E sleeve is not supplied (optional hardware).

The unit can also be placed above or beneath the dash of your vehicle using the supplied bracket and mounting hardware.

- If your scanner receives interference or electrical noise, move the scanner or its antenna away from the source.
- To improve the scanner's reception, use an optional external antenna designed for multi-band coverage. (You can purchase this type of antenna at a local electronics store). If the optional antenna has no cable, use 50-75 ohms coaxial cable for lead-in. A mating plug might be necessary for the optional antennas.
- Use an optional mono earphone or mono headset with proper impedance (32 ohms) for private listening. Read the precautions on the inside front cover of this Owners Manual.
- Do not use the scanner in high-moisture environments such as the kitchen or bathroom.
- Avoid placing the scanner in direct sunlight or near heating elements or vents.

### Base Station

This is the simplest approach to let you get started quickly. Decide on a location that is convenient to a nearby wall outlet, has desk space to let you complete your programming worksheets, will safely allow the indoor antenna to be extended, or near a window to use an outdoor antenna.

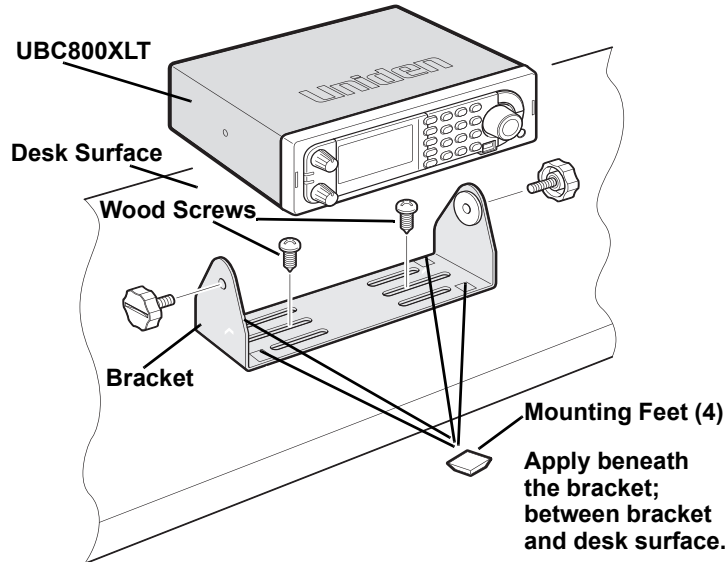

To secure the radio, by means of the mounting bracket, to a surface, follow the steps below:

1. Attach the four protective rubber feet to the mounting bracket when you casually use the scanner on a flat surface. Should you desire to permanently mount the scanner, remove the feet and use wood screws through the bracket as described in Steps 2 and 3.
2. Use the bracket as a template to mark positions for the two mounting screws.
3. At the marked positions, drill holes slightly smaller than the screws.
4. Align the bracket with the threaded holes on the sides of the radio case so the bracket is beneath the radio. Secure the bracket using the two threaded knobs. Never overtighten the knobs.

Once the radio is positioned, connect it to a source of AC power using the supplied **13.8V, 750 mA** AC adapter. Insert the barrel of the AC adapter to the jack on the rear, upper right side of the radio marked  $\text{DC } 13.8\text{V}$ .

**WARNING!**

Use only the Uniden-supplied AC adapter with this scanner.

Insert the connector of the supplied indoor telescoping antenna to the **BNC Antenna Connector** and apply moderate pressure to secure it.

## Setting Up an Audio Recording Device or Computer Recording

It is best if you plan ahead when you initiate the basic setup of the scanner if you include the components to record incoming reception. You need only an audio recording device which can be controlled by a Voice Operated module (VOX) either externally or from within the unit and the correct connecting cable.

The **REC** jack on the rear apron provides a constant-level audio output which is not affected by the setting of the volume control. Use a mono or stereo cable that ends in a 3.5mm plug for the scanner. The recorder might have its own requirements as to the proper plug. Check the recorder's instructions to be sure.

Connect the cable to an external or internal VOX control so that the recorder activates when audio is present.

You can also connect the cable to the appropriate input jack on your PC so that with controlling software, you can record to your hard disc.

In order for the function to operate, you must set the channel to record. You must also set the system's record option to either **All Channel**, which will record all channels regardless of any channel's setting, or **Marked Channel** which only lets recording occur if you have selected record for that channel. Which you choose will depend on various factors.

## Vehicle Installation

You can mount your scanner in your vehicle, using either the supplied bracket or the DIN-E sleeve (optional hardware).

### *Mounting Using the Bracket*

With the bracket removed from the radio, use the holes in the bracket as a template to initially mark the location you plan to use in your vehicle. Be absolutely certain of what might be behind the mounting surface before making any holes, be it above, or below, or in front of your dash, armrest console, or other location. If you drill carelessly, expensive damage can result. If in doubt, consult your vehicle dealer's service department or a qualified professional installer.

**Important:** AVOID AIRBAG DEPLOYMENT ZONES. Ignoring this installation concern may result in bodily harm and the inability of the airbag to perform properly.

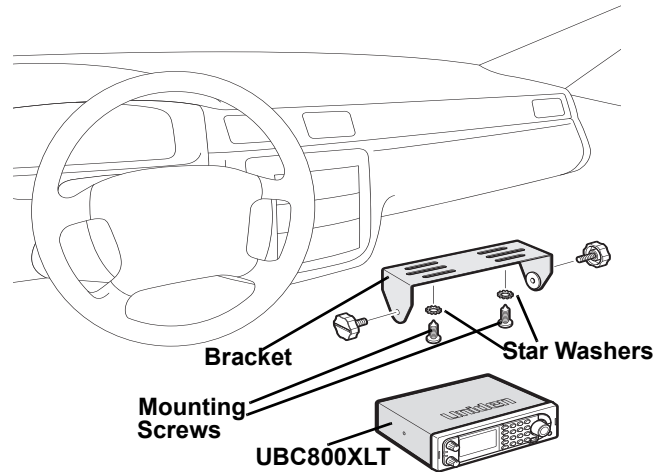

1. Using appropriate screws or other hardware, secure the bracket.
2. Insert the scanner and insert the bracket knobs to lock the scanner in position.
3. Attach the Cigarette Lighter Power Cord to the rear of the scanner and plug the adapter end into a dash mounted 12V DC socket.
4. Attach a suitable mounted mobile antenna to the antenna jack on the back of the scanner.

### ***Mounting Using the DIN-E Sleeve (Optional hardware)***

If you are unsure about how to install your scanner in your vehicle using the DIN-E sleeve, consult your automobile manufacturer, dealer, or a qualified installer. Before installing, confirm that your scanner fits in the desired mounting area and you have all the necessary materials to complete the task. Your scanner requires a 2 x 7-1/8 x 5-5/16 inch (50 x 180 x 135 mm) mounting area. Allow an additional 2-3/8 inch (60 mm) space behind the unit for connectors and wires.



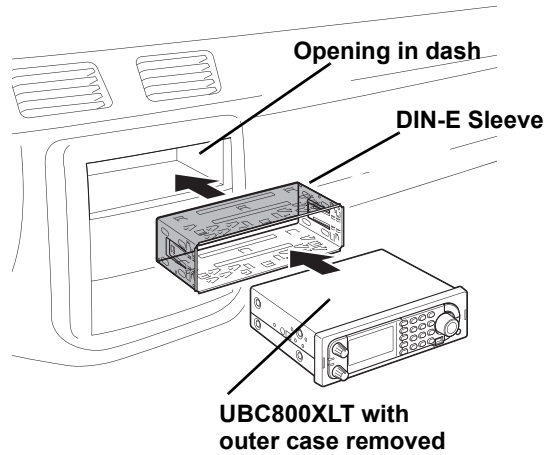

1. Remove the bracket if previously attached.
2. Remove the four Philips screws on the rear that secure the outer metal case and pull off the case with care.
3. Install the DIN sleeve into the opening in your dashboard, lip facing out.
4. Push out the top and bottom tabs to hold the sleeve firmly in place.
5. Before inserting the scanner in the sleeve, attach the cable from the previously mounted antenna. Attach the DC Power leads. RED goes to a positive (+) connection on your fuse block while BLACK connects to the vehicle's chassis ground (-).
6. Connect the ORANGE lead to one side of the headlamp switch so that when you activate the headlights, the scanner's LCD backlight dimmer level changes intensity. Be sure all the connections are routed away from any potentially pinching or slicing sheet metal.
7. Slowly slide the scanner into the sleeve until it locks in place.
8. To remove the unit, see "Removing the Scanner from the DIN-E Sleeve" on Page 34.

**Note:** if you plan to connect a GPS unit or external speaker at a later time, expect to remove the unit for ease of making those connections.

## Setting Up Your Scanner

## ***Removing the Scanner from the DIN-E Sleeve***

If you plan to connect other devices or wires to the radio, such as a GPS unit, at a later time, you should plan to remove the scanner from the DIN-E sleeve. This is easily done using the Removal Keys.

Fully insert both Removal Keys into the slots on the left and the right edges of the radio's dress panel. You cannot remove the radio if only one key is available. Press in fully and the radio will unlock from the sleeve making withdrawal from the sleeve possible. Store the keys in a safe place for future use.

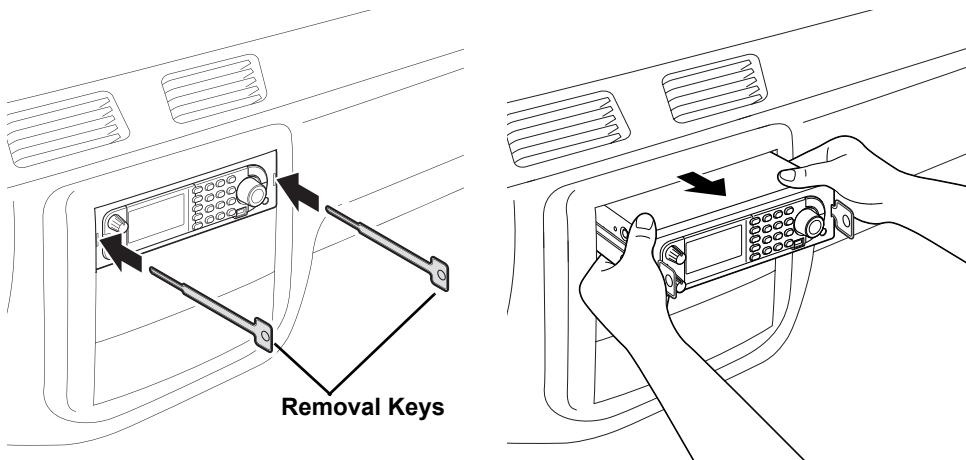

## ***Mounting Using ISO Technique***

Some vehicles can take advantage of another approach to mounting a radio in a vehicle, called the ISO technique. However, this technique requires a very detailed and thorough knowledge of the technique. Therefore, we strongly suggest that if you have any doubt about your experience and abilities, please consult with a professional installer who is familiar with the ISO approach to radio installation.

To begin the process, it is first necessary to remove the scanner's outer metal sleeve from the inner chassis. Unthread the four screws in the rear of the unit. Slide the cover toward the rear and off. Once the sleeve is removed, you will see threaded, metric machine screw holes on either side of the chassis cabinet. Uniden does not supply these screws. Their diameter, length, and screw type should be chosen by a qualified installer based on the internal vehicle bracket which will be used in securing the scanner chassis.

Once the original radio is removed from the vehicle dash and the fit of the scanner is correct, be sure to connect all the power, audio, antenna, and any other cables or wires, to the scanner before the scanner is secured.

The following illustration is a typical example of the ISO technique and the general side mounting screw holes often encountered. It does not actually represent your vehicle or your vehicle's mounting bracket. Only a professional installer will be able to determine the best and correct approach.

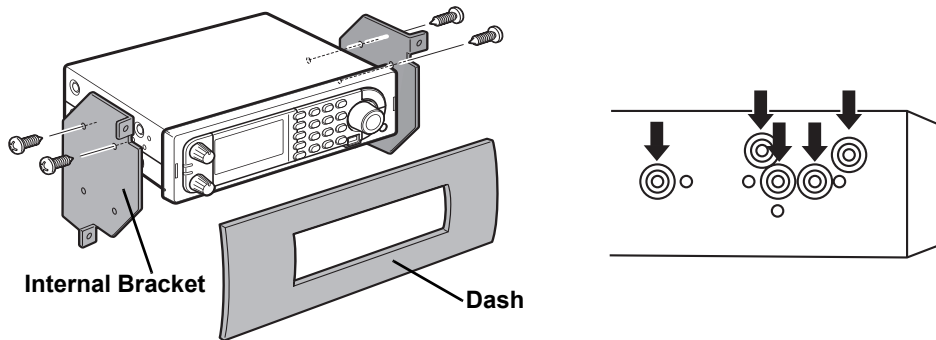

### **Removing the Display Sticker**

Before you use the scanner for the first time, remove the protective plastic film over the display.

### **Connecting an Optional Antenna**

The scanner's BNC connector makes it easy to connect a variety of optional antennas, including an external mobile antenna or outdoor base station antenna.

**Note:** Always use 50- or 75-ohm, RG-58, or RG-8, BNC terminated coaxial cable to connect an outdoor antenna. If the antenna is over 50 feet from the scanner, use RG-8 low-loss dielectric coaxial cable. Cable loss increases with higher frequency.

### **Connecting an Earphone/Headphone**

For private listening, you can plug a 1/8-inch (3.5 mm) mini-plug earphone or headphones (not supplied) into the headphone jack on the front of your scanner. This automatically disconnects the internal speaker. See "Earphone Warning" at the front of the manual for important information about using an earphone/headphone.

## **Setting Up Your Scanner**

**WARNING!**

Never connect anything other than the recommended amplified extension speaker to the scanner's headphone jack. Damage to the scanner might occur.

## Connecting an Extension Speaker

In a noisy area, an optional amplified extension speaker, positioned in the right place, might provide more comfortable listening. Plug the speaker cable's  $\frac{1}{8}$ -inch (3.5-mm) mini-plug into your scanner's back-panel **Ext. Sp. Jack**.

**WARNING!**

Never connect any part of the headphone jack to the antenna jack or connect the radio to an installation where the antenna and audio connection are grounded. This might also damage the scanner.

## Controls, Keys, and Functions

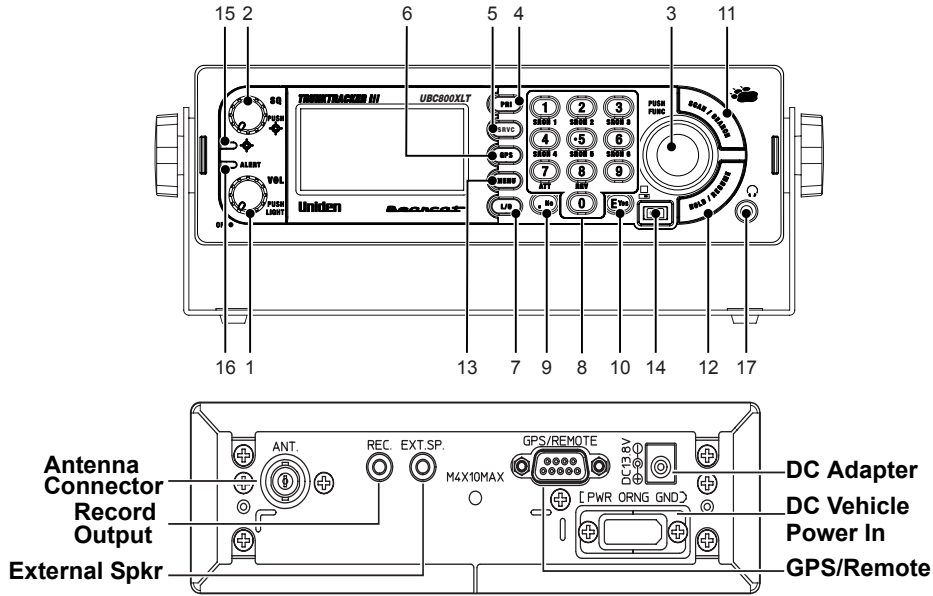





The knobs and keys on the UBC800XLT produce several different actions. You can, for example, rotate the knobs as well as press them to achieve a different result. Pressing a key briefly can produce one result while pressing and holding, gives a different result.

Many controls and keys behave differently depending on the mode your radio is in when you use them. Carefully examine the following table to separate those actions.

**Note:** “Press” means press and release briefly. “Press and hold” means press and hold down for at least 2-seconds. **●** means **Tap or Press** the **Scroll Control** to put the scanner into Function mode then press the key under discussion.

Control/Key	Label	Mode	Action	Result
[Power/VOL]	1	All	Rotate	Power ON — Volume Increase or decrease
		All	Press	Backlight enabled and intensity changes: Low - Medium-High -Off

Control/Key	Label	Mode	Action	Result
Squelch	2	All	Rotate	Sets the Squelch Level to permit strong signals to be heard with no background noise or lower strength signals with some background noise
			Press	Toggle: Close Call DND-CC Pri-OFF
			Press & Hold	Turns on Close Call Only Mode
			 + Press	Toggles to Tone-Out stand by mode
Scroll Control and Function 	3	All	Rotate	Turn to change scanning or searching direction.
		Scan or Custom Search	Scroll Control + Rotate	Turn to select System or Search Range
		Hold	Rotate	Turn to Select channel or frequency
		Menu	Rotate	Turn to scroll to menu item-Tap to select current option
			Press	Use as the <Enter> key for menu choices
		Name Edit	Rotate	Turn to select alpha/numeric entry for names
		Monitor	Rotate	Turn to resume scanning or searching
		GPS	 + Rotate	Turn to operate alphabet skip
Function	Press/Tap	Switches to Function Mode; To latch Function Mode, press and hold <b>[Func]</b>		
<b>[PRI]</b>	4	Scan	Press	Toggle Priority Mode (On-Plus On-Off)
<b>[SRVC]</b>	5	All	Press	Open Service Search Select menu
<b>[GPS]</b>	6	All	Press	Changes to GPS Mode
		GPS	Press & Hold	Stores current GPS data
			 + Press	Change GPS Display

Control/Key	Label	Mode	Action	Result
[L/O]	7	Scan Search Hold	Press	Temporarily locks out a system channel, a search frequency, or location data. Cancelled when Power is turned off.
			Press 2X	Permanently locks out system channel, a search frequency, or location data. Remains locked after power cycle.
		Menu	Press	Exit the menu.
		Scan/ Scan Hold	Press & Hold	Enables System Quick Key and Group Quick Key in the current system. Unlocks System, Group and Channel in the current system.
			☐ + Press & Hold	Enables all System quick Keys and group Quick Keys and unlocks all systems, groups, channels, and search ranges.
		Search Search Hold Close Call Only Close Call Hold	Press & Hold	Unlocks all frequencies of Global Lockout List.
[0] to [9]	8	Scan	Press	Enable/Disable selected System/Site Quick Keys
		Custom Search	Press	Turn on and off each custom search number
		All Hold Close Call Tone-Out	Press	Directly enter frequencies or Talk Group IDs
		Scan	☐ + Press	Enable/Disable Group Quick Key
		Other than Scan or GPS	☐ + Press [1] to [6]	[1] to [6] to start check of set search range
		Other than Scan or GPS	☐ + Press [7]	[7/ATT] to toggle attenuator setting
		All	☐ + [0]	Switches to Display Mode- Mode 1 default
		Scan/Scan Hold	☐ + [.No]	Enables Trunking activity Indicators
		[4] move left [6] move right	Editing Name	Press

### Controls, Keys, and Functions

Control/Key	Label	Mode	Action	Result
[.No]	9	All	Press	Cancel error or warning messages
		Hold Close Call Only Tone-Out	Press	Enter [.No] For frequency
			Press	Enter “.” or “!” for TGID
			Press 2X	Delete current character in name edit
			Press 3X	Clear all letters in name edit
			Press	Enter “.” or “!” for Direct Entry
		Scan Scan Hold	☐ + Press	Toggle Active Channel Display On or Off
Scan	Press	Starts two-digit of (SQK) System/Site Quick Key		
[Eyes]	10	MENU	Press	Use as the <Enter> key for menu choices
		Scan Scan Hold	Press	Edit the channel data for active channel
		Search Search Hold Close Call Close Call Hold	Press	Saves the active frequency
		Tone-Out Standby	Press	Switches to Tone Out edit Menu to change Tone Out Settings
[SCAN/SEARCH]	11	Scan Hold	Press	Start Scanning
		Other than Scan or Scan Hold or GPS	Press	Instant switch to Scan Mode
		Search Hold	☐ + Press	Toggle to resume searching
		GPS	Press	Toggle to scanner LCD
		Trunking Scan	☐ + Press	Toggle ID Search and ID Scan.
[HOLD/RESUME]	12	Scan Search Close Call Only	Press	Toggles HOLD on or off; In Close Call mode, error tone sounds if no frequency is detected.



Control/Key	Label	Mode	Action	Result
[MENU]	13	Scan Scan Hold GPS	☐ + Press	Initiates edit menu for current system, current search range, or current location data
		Menu	Press	Back up one level in the menu.
		All	Press	Use with Scroll Control to select menu settings
Front Serial Port	14	Clone & PC connector	Connect Supplied Cable	Connect supplied serial cable to use wired clone mode or create/edit settings with the optional software.
Close Call Indicator	15		Lights	Lights to indicate a Close Call hit.
Alert Indicator	16		Lights	Lights for various alerts like Non-Radio Location Based GPS Features.
Headphone Jack	17	All	Insert	Use 1/8-inch audio plug to listen privately.

## A Look At The Display

The display has indicators that show the scanner's current operating status. The display information helps you understand how your scanner operates.

The LCD screens shown here are only a few of many that you will see while in different modes. The ones we show here are more common and will assist you to get started.

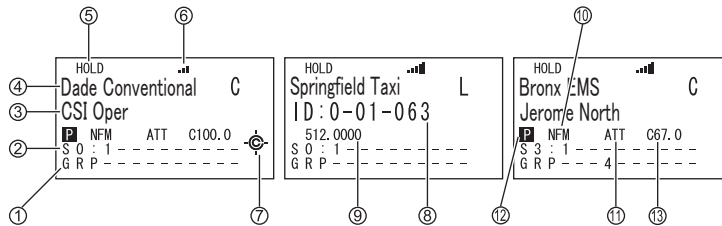

- |                                       |   |
|---------------------------------------|---|
| 1. Group Quick Key                    | 8. Talk group ID Number                   |
| 2. System + Site Quick key            | 9. Talk group Frequency                   |
| 3. Channel Name                       | 10. Modulation Type (Narrowband FM shown) |
| 4. System Name/<br>Channel Group Name | 11. Attenuation enabled                   |
| 5. Hold indicator                     | 12. Priority ON                           |
| 6. Signal Strength indicator          | 13. CTCSS or DCS Indicator                |
| 7. Close Call enabled                 |   |

## Operation

### Turning On the Scanner and Setting the Squelch

To turn the scanner on, rotate **[VOL]** clockwise. Turn the knob to a comfortable sound level.

Rotate the squelch control **[SQ]** clockwise until you either hear a broadcast or noise just stops. The control is now set for strong signals. If you desire to hear a weaker signal, turn it counter clockwise from that point until you hear background noise once more.

### Startup Key Operation

You can setup a Startup Key Configuration so that the scanner can change the lockout for each system or each site by pressing an assigned key while you power up the scanner or an opening screen is displayed. Navigate to Set Startup Key there are differences in the menu structure for Trunked and Conventional systems.

#### *Conventional*

[MENU] → ⤴ Program System →   
 Select the conventional system →   
 ⤴ Edit Sys Option →   
 ⤴ Set Startup Key →  for each system.













#### *Trunked*

[MENU] → ⤴ Program System →   
 Select the trunked system →   
 ⤴ Edit Site →   
 ⤴ Select the site →   
 ⤴ Set Startup Key →  for each system or site.

#### *Search Range*

[MENU] → ⤴ Search for... →   
 ⤴ Edit Service →   
 ⤴ Select a Service Range →   
 ⤴ Search with Scan →   
 ⤴ Set Startup Key →

OR



**[MENU]** →  **Search for...** →   
 **Edit Custom** →   
 **Select a Custom Range** →   
 **Search with Scan** →   
 **Set Startup Key** → 

Assign all the systems/sites that you want to scan at the same time to the same startup key [0] to [9]. You can only assign a site/system to one startup key. To leave a system unassigned, press [.No].

## Scanning Systems

To begin scanning preprogrammed or programmed systems, press **[SCAN/SEARCH]**. The UBC800XLT scans all unlocked systems in all programmed and activated quick-key groups and any searches unlocked for search with scan.

To enable or disable systems or sites for scanning, press the site/system's System/Site Quick Key while scanning.

### Notes:

- If no systems are programmed, or all systems are locked out, **Nothing to Scan** appears. Program a system or select a system to scan.
- When scanning multiple systems, the UBC800XLT scans systems according to the assigned quick key. Systems assigned to quick key 1 are scanned first, then 2, 3, 4, etc. Systems not assigned to a quick key are scanned last, then unlocked searches. Within a quick key, systems are scanned in the order they were assigned.
- Within a system, channels are scanned according to the assigned channel group, with the same priority as described above for systems.
- The UBC800XLT scans a system for the duration you set using the System Hold Time option (see "Setting the System Hold Time" on Page 65). For trunked systems, the scanner moves to the next system after the hold time expires, the current transmission ends, and the channel delay expires. Conventional systems operate similarly, but all unlocked channels are scanned at least one time regardless of the hold time setting.
- Each search range is searched for the amount of time you set using the "Set Hold Time" option. See "Setting the System Hold Time" on Page 65 for more information.

## Selecting Systems to Scan

To select systems to scan, press **Scan** then press the quick key assigned to the system or systems you want to scan. For quick keys **[0] - [9]**, press the quick key's number. For quick keys 10-99, press **[.No]** then press the quick key's 2-digit number. To stop scanning the system(s), press **[.No]** (if the quick key is a 2-digit quick key) then the number button or buttons again.



The Sx: (system) indicators on the display show the systems that are currently selected.

To select or lock out a system that is not assigned to a key, press  then rotate the Scroll Control until the desired system is selected. Then, press **[L/O]** within 2 seconds to either lock out or unlock the system.

## Selecting System Channel Groups

Within a system, you can assign groups of channels to a group quick key (see "Setting the Group Quick Key" on Page 78).

Follow these steps to activate or deactivate a channel group within a system while scanning.

1. Tap  then turn the **Scroll Control** to switch to the Function Mode. Then  to select the system that has the channel group you want to enable or disable.
2. While **F** still appears on the display, press the number key corresponding to the channel group you want to activate or deactivate.

## Locking/Unlocking Systems





Follow these steps to lock out a system so that it does not scan even if its quick key is selected.

1. Tap  to switch to the Function Mode then rotate the control to select the desired system.
2. Press **[L/O]** to temporarily lock out the system. **Temporary L/O** appears. Or, quickly press **[L/O]** twice to permanently lockout the system. **Locked Out** appears.
3. To unlock temporarily locked out systems, turn power off and then back on. To unlock permanently locked out systems, repeat Steps 1 and 2. **System Unlocked** appears.

## Locking/Unlocking Channels

If the scanner has stopped on a channel press **[L/O]** once to temporarily lock it out or quickly press **[L/O]** twice to permanently lock it out. Cycling power off/on automatically unlocks temporarily locked-out channels.

To lockout a channel when the scanner has not stopped on the channel, or to unlock a permanently locked-out channel.

1. Press **[HOLD/RESUME]** to hold on a channel.
2. Tap  to switch to the Function Mode, then rotate the control  to select the system where the channel is stored.
3. Tap  or wait 2 seconds, then rotate the **Scroll Control**  to select the channel you want to lock or unlock.
4. Press **[L/O]** to temporarily lock or unlock the current the channel. Double-tap L/O to permanently lockout the current channel.

## ID Scan/ID Search Mode



While you are scanning a trunked system, the scanner can be in either ID Scan or ID Search mode:

- ID Scan — the scanner only stops on talk group ID's (TGID) that you have programmed into the system that are unlocked.
- ID Search — the scanner stops on any unlocked talk group that becomes active.

To toggle between ID Scan and ID Search, press  then press **[SCAN/SEARCH]** while the scanner is scanning the system.

If the scanner does not scan the system long enough for you to easily do this, press  and rotate the **Scroll Control** to select the changed system. Then, press **[SCAN/SEARCH]** within 2 seconds.

## Holding On a System

To temporarily hold on a system, tap . To hold on a different system, tap  then rotate the control to select the system. Normal scanning resumes 2 seconds after your last selection.

To permanently hold on a site or system, press and hold the **Scroll Control** for 2 seconds. **F** flashes in the display's upper left corner. The scanner continues to

scan only the current system. To hold on a different site or system, rotate the **Scroll Control**  to select the new site or system then press **[EYES]**.

## Holding On a Channel

To hold on a channel, press **[HOLD/RESUME]** while the channel is active. To select a different channel, turn the **Scroll Control**. If you scroll past the beginning or end of the current system, the scanner selects channels in the previous or next system. To resume scanning, press **[SCAN/SEARCH]**.

## Quickly Storing an ID During ID Search

To quickly store an active talk group ID during ID search, press **[EYES]**. You see: **Quick TGID Save?**

To save the ID into a channel, press **[EYES]**. Otherwise, press **[.No]**. If you press **[EYES]**, the scanner stores the ID into a channel group called **Qck Save Grp** in the current system.

## Quick-Storing Channels or Talk Group ID's (TGID)

1. Hold on an existing channel in any system.
2. Enter the frequency or talk group ID you want to store (press **[.No]** twice to enter hyphens in talk group ID's).
3. To quick-store the channel or talk group ID, press **[EYES]**. Otherwise, press **[.No]**.

If you enter a frequency then press **[EYES]**, the scanner stores it in the **Qck Save Grp** group in a system called **Qck Save Cnv Sys**. These groups are created if they do not exist. Then, the scanner prompts you to save other channel settings.

If you enter a talk group ID then press **[EYES]**, the scanner stores it into a channel group named **Qck Save Grp** in the current system. If the talk group ID's format is not the type used by the current system, the scanner displays an error message and does not save the talk group ID.

If you pressed **[.No]** in Step 3, the scanner prompts you to select the system and the group where you want to store the frequency or talk group ID.

**Note:** The scanner will warn you if you try to store two channels in the same system that have the same frequency or Talk Group ID or if you try to store two systems with the same name.

## Trunking Activity Indicators

To get a visual indication of the activity on trunking systems, press **[HOLD/RESUME]** to hold on any channel. Then tap  and then press **[.No]** The scanner replaces the third line on the display with trunking activity indicators. When the scanner is monitoring on EDACS or Motorola system, the activity indicators will show which system frequencies have activity.

**Note:** For Motorola systems you must program all system frequencies (control and voice frequencies) for this feature to work.

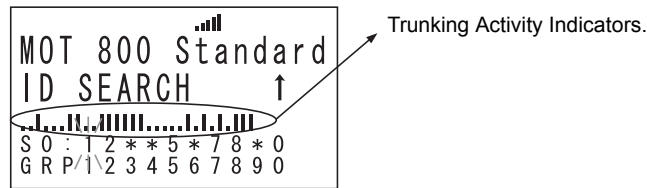



## Toggling the Display Mode

To change the display so the channel and frequency or Talk Group ID appear instead of extended channel information, hold on any channel then press **[M] + [0]**. The scanner displays **Display Mode 2**. To return to Mode 1, press **[M] + [0]**

Mode1 indicates the **channel data** under the Channel Name.

Mode2 indicates the **frequencies** under the Channel Name for Conventional systems or the TGID number for Trunked systems.

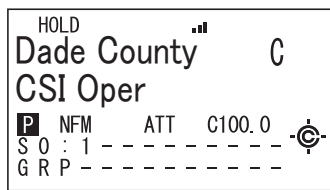

Channel Name Display Mode 1

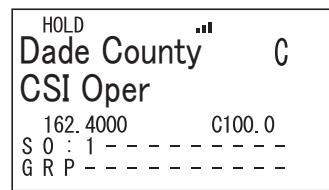

Channel Name Display Mode 2

## Using the Menu

The UBC800XLT incorporates an effective menu system that lets you make all the necessary setting options required to program the scanner and effectively use the many features. To use the menu, press **[MENU]**.

You immediately see the screen display the menu title at the top and three of ten menu options beneath. Using the Multifunction Scroll Control, you can rotate the control left or right to quickly review all ten listings.

The depth of each menu selection is extensive. For the purpose of this manual, the following chart indicates the primary menu selection, the purpose of that selection, and a reference to the page or pages that provide the details associated with the option.

Menu Item	Let's You...	For Detail, See...
Program System	Select options related to setting up a new system or editing one already programmed.	See "Scanner Programming" reprint.
Program Location	Choose GPS related locations for data to alert, confirm location, and provide you with an audible warning if desired.	
Srch/CloCall Opt	Lets you adjust settings that affect the scanner during search and Close Call operation	See "Search and Close Call Options" on Page 98
Search for...	Choose and search programmed ranges of desired services	See "Searching and Storing" on Page 86
Close Call	Setup the radio to receive, and let you hear, nearby strong stations.	See "Using the Close Call Feature" on Page 94
Set Priority	Lets you scan a conventional system and check for designated priority channels.	See "Priority Scan" on Page 103
Tone-Out for...	Select up to 10 Tone-Out settings or Standby	See "Fire Tone-Out" on Page 105
Wired Clone	Copy data directly from one UBC800XLT to another UBC800XLT.	See "Wired Cloning" on Page 56
Settings	Choose settings for miscellaneous but convenient options.	See the respective pages for each option:

## Programming General Settings

This section covers your scanners general settings.

### Setting and Using the Backlight

The LCD has a backlight that can be set with three levels of intensity plus **OFF**.

To make your selection, press **[VOL]**. Each time you press the control, the backlight cycles in the following order.

OFF — Low Intensity — Medium Intensity — High Intensity





When you stop at the desired level, the scanner remembers your setting the next time you turn on the scanner.

You can also set the backlight using the menu.

### Setting the Dimmer

If you connect the orange wire to a wire in your car that changes state when you turn on the headlights, the scanner can automatically dim the display when you turn on the headlights.

Tapping **[VOL]** overrides the menu setting and cycles through all backlight settings.

**[MENU]** →  **Settings** →   
 **Set Backlight** → 



**Auto** — Use this setting if you have connected the scanner to your vehicle's headlights using the orange wire. If you have connected the wire, the scanner automatically dims the backlight when you turn on the headlights. After selecting this option, select either:

+ **Polarity** — If the headlight wire is connected to +12V when the headlights are on.

- **Polarity** — If the headlight wire is connected to vehicle ground when the headlights are on.

**Manual** — Use this setting to manually set the dimmer level to **High**, **Middle**, **Low**, or **Off**. To guide you in your selection, at each setting the display shows what you can expect to see.

## Adjusting the Key Beep



[MENU] → ⤴ Settings →   
⤴ Adjust Key Beep → 

**Auto** — the scanner automatically sets the key beep to match the master volume setting level you select.

**Level 1 - 15** — the scanner lets you manually select one of fifteen key beep levels. As you turn the **Scroll Control**, the beep gets louder. Press  when you reach the desired level.

**off** — the scanner turns the key beep off.

## Setting the Audio AGC

[MENU] → ⤴ Settings →   
⤴ Set Audio AGC → 

This setting helps balance the audio level you hear as you listen to different radio sources so you can hear them at a similar volume. Use this setting if you listen to an audio source that has natural changes in audio level for which you want to compensate.



You can set the mode to be on or off.

⤴ to select either **on** or **off**.

**on** — AGC is enable.

**off** — AGC is disable.

## Setting the Display Orientation

[MENU] → ⤴ Settings →   
⤴ Set Upside-down → 

This setting controls the orientation of the display. If you set Upside-down to **on**, the scanner inverts the display text and graphics.

## Adjusting the Display Contrast

There are 15 contrast levels. As you scroll from level 1 to 15 you see the contrast change. Press the **Scroll Control** to lock the desired level until the time you desire to change it.

[MENU] → ⤴ Settings →   
Adjust Contrast →   
⤴ Select a level Level 1 to Level 15 →

## Setting the GPS Format

[MENU] → ⤴ Settings →   
⤴ Set GPS Format →

These settings control how the scanner handles GPS input when you are using the location-based functions.

## Setting the Position Format

[MENU] → ⤴ Settings →   
⤴ Set GPS Format →   
⤴ Set Pos Format →

This setting controls the format used for entering GPS coordinates into the scanner.

DMS: DDD° MM' SS.ss — Enter the location in Degree, Minute, Second format.

DEG: DDD.dddddd — Enter the location in Degree and fraction format.

## Setting the Time Format

[MENU] → ⤴ Settings →   
⤴ Set GPS Format →   
⤴ Set Time Format →

This setting controls the format used for displaying the time on the GPS data screens.

12H — the scanner displays time in 12-hour format using am for mornings and pm for evening times.

24H — the scanner displays time in 24-hour format using 0 for midnight and 23 for 11 pm.

## Setting the Time Zone

[MENU] → ⤴ Settings →   
⤴ Set GPS Format →   
⤴ Set Time Zone →

## Programming General Settings

This setting controls the format used for adjusting Universal time to local time. Set your local time's offset from UTC (formally known as GMT).

### Setting the Distance Units

[MENU] → ⤴ Settings →   
⤴ Set GPS Format →   
⤴ Set Unit →

This setting controls the distance units shown in the GPS data screens and used for entering distance for POI's

**mile** — The scanner uses miles.

**km** — The scanner uses kilometers.

The selection items of the location range and the speed also changes by this selection.

### Setting the Serial Port Speed

[MENU] → ⤴ Settings →   
⤴ Set Serial Port →   
⤴ Set Baud Rate →   
⤴ Set Front Port Or Set Rear Port →

Use this setting to control the data rate used for the front and back panel serial ports. You typically set the front port to match the speed used to communicate with your PC (default 115200 bps) and the back port to the speed used to communicate with an attached GPS (default 4800 bps). Note that the back port is male. You may need a gender changer and a null modem adapter to use a typical DB9 serial cable from the rear port.

For Serial Port Speed (Baud Rate), select from

- 4800 bps
- 9600 bps
- 19200 bps
- 38400 bps
- 57600 bps
- 115200 bps
- OFF

## Displaying Scanner Information

### Viewing Memory Used

[MENU] → ↻ Settings → [ENTER]  
 ↻ See Scanner Info → [ENTER]  
 ↻ % Memory Used → [ENTER]

The scanner displays the percent of memory that is used and the number and the percent of systems, sites and channels that are created.

Press any key to return to the previous menu, then press any key to exit the menu.

### Viewing the Firmware Version

[MENU] → ↻ Settings → [ENTER]  
 ↻ See Scanner Info → [ENTER]  
 ↻ Firmware Version → [ENTER]

Press any key to return to the previous menu, then press any key.

## Initializing the Scanner's Memory

**Warning:** This clears data **you** have entered. You cannot restore user programmed data that has been deleted. You can, at a last step, restore only the original factory data.

1. To initialize the scanner's memory, turn off the scanner.
2. While pressing [2], [9], and [HOLD] at the same time, turn on power.

At that point anything you have programmed is gone.

## Connecting Your Scanner to a Personal Computer

You can connect your scanner, by means of the supplied cable, to a personal computer to download data from the computer to the memory of the scanner. Before you proceed, you must first set the scanner's communications speed as described in the previous section.

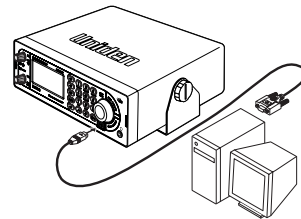

## Programming General Settings

**Important:** Start with a high baud rate setting. If, during transfer, you get an error message, reduce the setting and start again until you get reliable, complete transfer of data.

### **Volume/Squelch with PC Control**

If you use a PC to control the scanner, and you change the scanner's volume or squelch setting using the PC, the scanner ignores the front-panel control's current setting. However, if you later change the volume or squelch setting using the front-panel control, the scanner uses the control's setting (i.e. the scanner pays attention to the last method used).

### **Wired Cloning**

Using the scanner in a cloning setup lets you transfer programmed data directly from a *source* or **master** UBC800XLT to a *target* or **slave** UBC800XLT. Wired cloning between other models to the UBC800XLT is not possible.

**[MENU]** → **Wired Clone** → **Master/Slave**

**Master or Slave** (select one as the master and one as the slave)

To clone (transfer) data directly from one UBC800XLT scanner to another UBC800XLT scanner, you must first connect the scanners to each other using the included connection cables and a DB9 null modem adapter and for the rear port, a DB9 gender changer (neither included), available at most computer stores. Then you must set one scanner as the source and the other as the target.

Connected as shown, and with both ports correctly selected, no other hardware is needed.

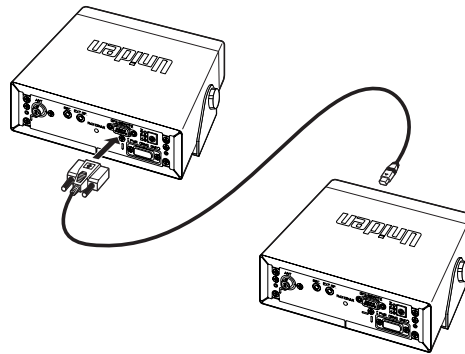

1. Select the Front Port for the Master. Select the Rear Port for the Slave or vice versa.
2. Plug the 9-pin serial connector into the unit designated as the Rear Port.
3. Plug the smaller connector into the front port of the unit designated as Front Port.



4. When you are ready to clone the scanner, press **[SCAN/SEARCH]** on the slave scanner **first**, then **[SCAN/SEARCH]** on the master scanner. The master scanner checks the connection between the two scanners, then transfers its data to the slave scanner.

```
Clone Master  
=== >
```

```
Clone Slave  
=== <
```

5. When the transfer is complete, **Complete** appears on both scanners. If the transfer did not work, **Error** appears on the master scanner. Readjust the baud rate to a lower setting and try again.

## Programming Your Scanner

1. Plan the system.
2. Program the system into your scanner according to the plan you prepared in Step 1.

### General Notes

You can store up to 6000 channels in up to 500 systems.

Each trunking system can have up to 256 sites and up to 250 trunked channels (TGID). Each conventional system can have up to 1000 channels.

Your scanner can have up to a total of 1000 sites. Each system can have up to 20 channel groups.

The following table provides you the information to successfully perform various steps connected with programming each of the systems: Conventional, Motorola, EDACS, and LTR. Some operations are common to all of the systems while some are specific to a given system. Use the following table to quickly locate the step you want or need to perform (where required), the reference page for that step, and to which system or systems it applies.

## System Settings

System Settings	CNV	MOTOROLA		EDACS		LTR	See Pages
		TYPE I	TYPE II	Wide /Narrow	SCAT		
Edit Name	•	•	•	•	•	•	P. 63
Edit Sys Option	•	•	•	•	•	•	P. 64
Edit Site		•	•	•	•	•	P. 71
Edit Group	•	•	•	•		•	P. 77
Copy System	•	•	•	•	•	•	P. 71
Delete System	•	•	•	•	•	•	P. 71

## System Options

System Option Settings	CNV	MOTOROLA		EDACS		LTR	See Pages
		TYPE I	TYPE II	WIDE/ NARROW	SCAT		
Set Quick Key	•						P. 64
Set Startup Key	•						P. 65
Set Lockout	•						P. 65
Set Hold Time	•						P. 65
ID Scan/Search		•	•	•		•	P. 66
Set Delay Time	•	•	•	•	•	•	P. 66
Set Data Skip	•						P. 66
Set LocationInfo	•						P. 66
Edit Fleet Map		•					P. 67
Set Status Bit		•	•				P. 67
Set End Code		•	•				P. 68

System Option Settings	CNV	MOTOROLA		EDACS		LTR	See Pages
		TYPE I	TYPE II	WIDE/ NARROW	SCAT		
Set I-Call		•	•	•			P. 68
Emergency Alert		•	•	•			P. 68
EDCS ID Format				•			P. 69
Set Record	•	•	•	•	•	•	P. 69
Rvw ID:Srch L/O		•	•	•		•	P. 70
Clr All L/O IDs		•	•	•		•	P. 70

## Site Settings

Site Setting	MOTOROLA TYPE I		MOTOROLA TYPE II					EDACS			L T R
	800MHz Standard	800MHz Splinter	800MHz Standard	800MHz Splinter	900MHz Band	VHF Band	UHF Band	WIDE	NARROW	SCAT	
Edit Name	•	•	•	•	•	•	•	•	•		
Set Quick Key	•	•	•	•	•	•	•	•	•	•	•
Set Startup Key	•	•	•	•	•	•	•	•	•	•	•
Set Frequencies	•	•	•	•	•	•	•	•	•	•	•
Set Modulation	•	•	•	•	•	•	•				•
Set Attenuator	•	•	•	•	•	•	•	•	•	•	•
Set Lockout	•	•	•	•	•	•	•	•	•	•	•
Set Hold Time	•	•	•	•	•	•	•	•	•	•	•
Edit Band Plan						•	•				
Set C-Ch Only	•	•	•	•	•	•	•				
Set LocationInfo	•	•	•	•	•	•	•	•	•	•	•
Delete Site	•	•	•	•	•	•	•	•	•		
New Site	•	•	•	•	•	•	•	•	•		

## Channel Settings

Channel Setting	CNV	MOT TYPE I	MOT TYPE II	EDACS	LTR
Edit Name	•	•	•	•	•
Edit Frequency	•				
Edit TGID		•	•	•	•
Set CTCSS/DCS	•				
Set Modulation	•				
Set Attenuator	•				
Set Priority	•				
Set Alert	•	•	•	•	•
Set Record	•	•	•	•	•
Set Lockout	•	•	•	•	•
Copy Channel	•	•	•	•	•
Delete Channel	•	•	•	•	•
New Channel	•	•	•	•	•

## Programming Conventional Systems

[MENU] → Program System →

New System →

Conventional →

Confirm? Yes="E" / No="."

The scanner creates an empty conventional system with a default name of **System n C**. Note that "n" is a number that increments as you add new systems. The c on the right side of the display indicates that this is a conventional system. After creating the system:

1. Set system-level settings that apply to conventional systems in "Programming System Settings."
2. Create one or more channel groups with channels as described in "Programming Channel Groups."

## Programming Trunked Radio Systems

[MENU] → Program System →   
 ↻ New System → 

Then, select the system type:

**MOT TYPE 1** — Motorola Type I systems

**MOT TYPE 2** — Motorola Type II systems

**EDCS WIDE/NARROW** — EDACS Wide and Narrow systems

**EDCS SCAT** — EDACS SCAT systems

**LT** — LTR Systems

The scanner creates an empty system with a default name of **System n x**. Note that “n” is a number that increments as you add new systems. The “x” on the right side of the display is M for Motorola system, E for EDACS systems, and L for LTR systems. After creating the system:

1. Set the system-level settings in “Programming System Settings” that apply to the type of system you selected.
2. Set up at least one site for the system as described in “Programming Sites” on “Programming Sites” on Page 71.
3. To scan specific channels, create one or more channel groups with channels as described in “Programming Channel Groups.”

## Programming System Settings

Throughout the following sections, you will notice a heading on the right, such as **MECLS** in the next section. This helps designate the system types to which the section applies. In this section, the instructions apply to **M** (Motorola), **E** (EDACS Wide/Narrow), **C** (Conventional), **L** (LTR), and **S** (EDACS SCAT).

### Editing the System Name

**MECLS**

Each system name can be up to 16 characters. Abbreviate as necessary to fit. For Motorola and EDACS Wide/Narrow systems, the system name only appears in the scanner menu’s Program System listings. It is not shown during scanning. For other systems, the system name alternates with the Channel group when the scanner stops on a channel.

The default system names include the following letter in the 16th position to indicate the system type: **M** = Motorola; **E** = EDACS; **L** = LTR; **c** = Conventional;



## Programming Your Scanner

## Specifying the Correct System Type

In order for trunk tracking to work properly, you have to specify the correct system type when you create the system. Here are some tips for selecting the correct type:

- Use online resources, such as the *www.radioreference.com* database, to identify the system type.
- EDACS Wide is the same as EDAC Standard.
- EDACS Networked sites are EDACS Narrow

Following these steps to change the system name.

[MENU] → Program System →   
 ↻ Select the system →   
 ↻ Edit Name → 

To enter a letter, turn the **Scroll Control** until the character you want appears. To enter a decimal point, press [.No]. To move the cursor to the left, press [4]. To move the cursor to the right, press [6].

To clear a character, press [.No] twice. To clear all characters, press [.No] 3 times.





To accept an entry, press [EYES] or 

## Programming System Options

MELCS

### Editing the System Quick Key

C

[MENU] → Program System →   
 ↻ Select a conventional system →   
 ↻ Edit Sys Option →   
 ↻ Set Quick Key → 

After selecting this option, select any number from 0-99 to assign the system to a quick key or press [.No] to assign the system to no quick key, then press 

#### Notes:

- Access single-digit system/site Quick Keys by pressing the single digit on the keypad during scanning. Access two-digit system Quick Keys by pressing [.No] then both digits.
- You can assign as many systems to the same quick key as you want.
- To be scanned, a system's Quick Key must be activated and the system must be unlocked.



## Setting the Startup Key

- [MENU] → Program System →
- ↻ Select a conventional system →
- ↻ Edit Sys Option →
- ↻ Set Startup Key →

Select a startup key from 0-9 or select **[.No]** for no startup key.

### Notes:

- To unlock the system at startup, press and hold the selected startup key while you apply power. If you do not press the startup key at the time you turn on power, you can still act while the opening screens are displayed.
- The system Quick Key is also enabled.
- If you press a different key at startup, the system is locked out.
- If you do not assign the system a startup key, the system is not affected by any key press during startup.

## Setting the System Lockout

- [MENU] → Program System →
- ↻ Select a conventional system →
- ↻ Edit Sys Option →
- ↻ Set Lockout →

**Unlocked** — The system is scanned when its quick key is enabled.

**Temporary L/O** — The system is not scanned, even if its quick key is enabled. Cycling power removes the lockout.

**Lockout** — The system is not scanned, even if its quick key is enabled. You must manually unlock the system.

## Setting the System Hold Time

- [MENU] → Program System →
- ↻ Select a conventional system →
- ↻ Edit Sys Option →
- ↻ Set Hold Time →

Set how long the scanner will remain scanning on this system before moving to the next system (up to 255 seconds). Note that the scanner will scan all unlocked channels at least one time, regardless of the system hold time setting.

## Programming Your Scanner

## Setting ID Scan/ID Search

MEL

- [MENU] → Program System →
- ↻ Select a system →
- ↻ Edit Sys Option →
- ↻ ID Scan/Search →

Sets whether the scanner only stops on talk groups you have programmed in (ID Scan) or whether the scanner stops on any unlocked channel (ID Search).

## Setting Channel Delay Time

MELCS

- [MENU] → Program System →
- ↻ Select a system →
- ↻ Edit Sys Option →
- ↻ Set Delay Time →

This setting controls how many seconds the scanner waits after a transmission ends before resuming scanning. Enter a value from [1] to [5] or off, then press.

### Notes:

- The default setting is 2 seconds for each system.
- This setting applies to all channels within the system.

## Setting Data Skip

C

- [MENU] → Program System →
- ↻ Select a Conventional system →
- ↻ Edit Sys Option →
- ↻ Set Data Skip →

This setting controls whether the scanner automatically skips channels it identifies as data. This includes channels with either no audio or a constant-level audio source. If turned on, the scanner resumes scanning as soon as it detects the data signal.

## Setting Location Information

C

- [MENU] → Program System →
- ↻ Select a Conventional system →
- ↻ Edit Sys Option →
- ↻ Set LocationInfo →

This setting control whether the system is automatically enabled and disabled when you connect a GPS to the scanner.

**Set Latitude** — Enter the system's latitude using the format you selected in the system settings.

**Set Longitude** — Enter the system's longitude using the format you selected in the system settings.

**Set Range** — Set the system's range using the units you selected in the system settings.

**Set GPS Enable** — L/O status is automatically controlled by receiving data from GPS.

### Setting the Fleet Map

**M (Type I Only)**

- [MENU] → Program System →
- ↻ Select a Motorola Type I system →
- ↻ Edit Sys Option →
- ↻ Edit Fleet Map →

**Preset** — select from the 16 most common fleet maps

**Custom** — allows you to enter a custom fleet map. Enter the size code (0 to 14) for each block. Press  to select.

For Motorola Type I and Type III Hybrid systems, you must enter a system fleet map in order for the scanner to properly track and display talk group ID's. The fleet map is usually included in the same resource that provided system frequencies and talk group ID lists.

**Note:** If you don't know the fleet map for your Motorola Type I system, check the Internet such as [www.radioreference.com](http://www.radioreference.com) or the other websites we reference.

### Setting the Status Bit

**M**

- [MENU] → Program System →
- ↻ Select a Motorola Type I or II system →
- ↻ Edit Sys Option →
- ↻ Set Status Bit →

**Ignore** — the scanner rounds all received ID's down to the next interval of 16. The default setting is **Ignore**.





**Yes** — the scanner treats all received ID's as unique ID's.

## Programming Your Scanner

**Note:** Motorola analog systems use talk group ID's in multiples of 16. ID numbers that fall between these ID's indicate special status flags for the system. This setting determines how the scanner will handle ID's that are not multiples of 16. Select your setting then press .

### Setting End Code Operation

**M**

[MENU] → Program System →   
 ↻ Select a Motorola Type I or II system →   
 ↻ Edit Sys Option →   
 ↻ Set End Code → 

This setting determines how the scanner handles the transmission end code sent by most Motorola systems. Select your setting then press .





**Yes** — the scanner immediately returns to the control channel when it detects the end code.

**Ignore** — the scanner does not return to the control channel until the carrier drops.

**Note:** The default setting is **Yes**.

### Setting I-Call Operation

**ME**

[MENU] → Program System →   
 ↻ Select a Motorola Type I, II or EDACS Wide/Narrow system →   
 ↻ Edit Sys Option →   
 ↻ Set I-Call → 

This setting determines how your scanner treats I-calls while ID Searching.

**on** — the scanner tracks I-calls.



**off** — the scanner ignores I-calls. The default setting is **off**.

**only** — the scanner only tracks I-calls and ignores other radio traffic on the system. Press  to select.

**Note:** To set the I-Call to a wildcard receive condition, press [.No] + [0].

### Setting the Emergency Alert Option

**ME**

[MENU] → Program System →   
 ↻ Select a Motorola Type I, II or EDACS Wide/Narrow system → 

- ↻ **Edit Sys Option** →
- ↻ **Emergency Alert** →

**off** — the scanner does not alert you to emergency transmissions.

**Alert 1 - 9** — the scanner sounds an alert beep to notify you of the emergency transmission. The default alert is **off**. You can choose any of 9 different beep types. Once you choose an alert tone, next:

- ↻ → **Set Level** →

**Auto** — the scanner automatically sets the emergency alert beep to the master volume level.

**Level 1 - 15** — the scanner adjusts the volume you hear to the level you select.

## Setting the EDACS ID Format

**E**

- [MENU] → **Program System** →
- ↻ **Select an EDACS Wide/Narrow system** →
- ↻ **Edit Sys Option** →
- ↻ **EDCS ID Format** →

EDACS Talk Group ID's are commonly provided in one of two formats: **AFS** and **Decimal**. This setting determines how you enter EDACS ID's and how the scanner displays them.

**AFS Format** — the scanner uses AFS format for Talk Group ID's

**Decimal Format** — the scanner uses decimal format for Talk Group ID's

**Note:** The scanner defaults to AFS (agency, fleet, subfleet) format - the format used in most EDACS systems.

## Setting the System Record Option

**MELCS**

- [MENU] → **Program System** →
- ↻ **Select a system** →
- ↻ **Edit Sys Option** →
- ↻ **Set Record** →

This setting controls how the scanner handles the record option for channels in the system.

**All Channel** — The scanner sends the audio for all channels in the system to the **REC** jack, regardless of the channel's record option setting.

## Programming Your Scanner

**Marked Channel** — The scanner only sends the audio for channels that have the Record option turned on to the **REC** jack.

**off** — The scanner does not send any audio from any channel in the system to the **REC** jack, even if the record option is turned on for a channel.

**Note:** In order for the function to work, you must set the channel to record. You must also set the system's record option to either **All Channel** (which will record all channels regardless of the channel's record setting) or **Marked Channel** (which only records the channels you've set to record).

### Reviewing ID Search Lockouts

**MEL**

- [MENU] → Program System →
- ↻ Select a trunked system →
- ↻ Edit Sys Option →
- ↻ Rvw ID: Srch L/O →

The scanner displays each ID you have locked out in ID Search mode and gives you the option to unlock the ID. To unlock an ID, rotate the scroll to select the locked out ID, then press [EYES]. If no ID's are locked out, the scanner displays "Nothing Locked / Press Any Key."

### Clearing All Locked Out ID's

**MEL**

- [MENU] → Program System →
- ↻ Select a trunked system →
- ↻ Edit Sys Option →
- ↻ Clr All L/O IDs →

To quickly unlock all IDs in the system, answer "Y" to "Confirm? Unlock All (Y/N)."

### Editing Sites

**MESL**

Use this option to enter and edit site information for the current system. See "Programming Sites" on Page 71 for instructions for each site option. Note that you must program at least one site for each trunked system in order for your scanner to scan the system.

### Editing Channel Groups

**MECL**

Use this option to enter and edit channel groups and channel information. See "Programming Channel Groups" for instructions for each channel group and channel option. Note that you must program at least one channel group and one channel for each conventional system in your scanner. You do not have to enter

channel group information for trunked systems, but doing so makes it easier to follow specific talk groups.

## Copying Systems

**MECSL**

Occasionally you might want to copy and rename a system to highlight one group over another.

One system might be called City - Fire and the same system City - PD with adjustments to data within.

This lets you quickly locate the desired set of data.

To copy a system including all settings, groups, and channels:

[MENU] → Program System →

↻ Select the existing system →

↻ Copy System →

New Sys Name?

Enter your new name using the **Scroll Control** and [4] and [6] to traverse the display and enter characters. Press when finished.

## Deleting Systems

**MECSL**

[MENU] → Program System →

↻ Select the existing system →

↻ Delete System →

Confirm Delete?

Yes="E" / No= "."

**Important:** Deleted systems cannot be restored. You must re-enter them.

## Programming Sites

**MESL**

This section covers settings that apply to trunked radio site. You must program at least one site for each trunked radio system. When you program multiple sites, all sites share the same channel groups and channels within the system.

**Note:** You can only program one site in an EDACS SCAT and LTR system.

## Setting the Site Name

**ME**

Each site name can be up to 16 characters. Abbreviate as necessary to fit. The site name alternates with the Channel group when the scanner stops on a channel.

The default site names include the following letter in the 16th position to indicate the system type:

- MS1: Motorola 800 MHz Type I Standard**
- MS2: Motorola 800 MHz Type II Standard**
- MP1: Motorola 800 MHz Type I Splinter**
- MP2: Motorola 800 MHz Type II Splinter**
- M92: Motorola 900 MHz**
- MV2: Motorola VHF**
- MU2: Motorola UHF**
- EDW: EDACS Wide**
- EDN: EDACS Narrow**

Follow these steps to change the system name.

- [MENU] → Program System →**
- ↻ Select a trunked system →**
- ↻ Edit Site →**
- ↻ Select a Site →**
- ↻ Edit Name →**

To enter a letter, turn the **Scroll Control** until the character you want appears. To enter a decimal point, press **[.No]**. To move the cursor to the left, press **[4]**. To move the cursor to the right, press **[6]**.

To clear a character, press **[.No]** twice. To clear all characters, press **[.No]** 3 times.

To accept an entry, press **[YES]** or **[OK]**.

### Setting the Site Quick Key

### MESL

- [MENU] → Program System →**
- ↻ Select a trunked system →**
- ↻ Edit Site →**
- ↻ Select a Site →**
- ↻ Set Quick Key →**

After selecting this option, select any number from 0-99 to assign the system to a quick key or press **[.No]** to assign the system to no quick key, then press **[OK]**.



**Notes:**

- Access single-digit system/site Quick Keys by pressing the single digit on the keypad during scanning. Access two-digit system Quick Keys by pressing **[.No]** then both digits.
- You can assign as many systems to the same quick key as you want.
- To be scanned, a system/site's Quick Key must be activated and the system must be unlocked.

**Setting the Site Startup Key**

**MESL**

- [MENU] → Program System →
- ↪ Select a trunked system →
- ↪ Edit Site →
- ↪ Select a Site →
- ↪ Set Startup Key →

Select a startup key from **[0]** to **[9]** or select **[.No]** for no startup key.

**Notes:**

- To unlock the system at startup, press and hold the selected startup key while you turn on the scanner.
- The system/site's Quick Key is enabled when it is unlocked.
- If you press a different key at startup, the system is locked out.
- If you do not assign the system a startup key, the system is not affected by any key press during startup.

**Setting Site Frequencies**

**MESL**





- [MENU] → Program System →
- ↪ Select a trunked system →
- ↪ Edit Site →
- ↪ Select the site →
- ↪ Set Frequencies →
- ↪ New Frequency (or select an existing frequency) →

Input a system frequency using the number keys and **[.No]** key, then press . If you are entering frequencies for an LTR or EDACS system, the scanner also prompts you to enter the LCN for the frequency you just entered. Obtain LCN's (logical channel numbers) from the same source as the other system information. To enter additional frequencies, press **[MENU]**, then ↪ to select **New Frequency**. Then repeat the above.

**Note:** If you select Control Channel Only mode (see “Setting Control-Channel Only (Motorola Systems Only)” on Page 76), you only need to enter the frequency(s) that can be assigned as the control channel. Most frequency lists usually indicate which of the frequencies are the control channel frequencies. Otherwise, you must enter all of the frequencies.

## Setting Site Modulation

**ML**

[MENU] → Program System →   
 ↻ Select a trunked system →   
 ↻ Edit Site →   
 ↻ Select a Site →   
 ↻ Set Modulation → 

**Auto** — the scanner uses the default modulation for the frequency band.

**NFM** — the scanner uses narrowband FM for the frequency band.

**FM** — the scanner uses FM (frequency modulation) for the frequency band.





**Note:** The default setting is **Auto**.

This setting controls the modulation method used for the frequency band. In most cases, if you leave this set to **Auto**, the scanner automatically selects the correct modulation type for the system you are programming.

## Setting Site Attenuation

**MESL**

Enable Attenuation if you are near strong signal sources. Attenuation can help reduce interference and desensitization that strong signals create. You can also turn this setting on or off by holding on a trunked system, then pressing  + [7].



[MENU] → Program System →   
 ↻ Select a trunked system →   
 ↻ Edit Site →   
 ↻ Select a Site →   
 ↻ Set Attenuator → 

**off** — the attenuator is off.

**on** — site frequencies are attenuated by about 20 dB.

## Setting Site Lockout

**MESL**

[MENU] → Program System →   
 ↻ Select a trunked system → 

- ↻ **Edit Site** →
- ↻ **Select a site** →
- ↻ **Set Lockout** →
- ↻ **Select from the following choices then press**

**Unlocked** — the system is scanned when its quick key is enabled.

**Temporary L/O** — the system is locked for this session.

**Lockout** — the system is not scanned.

### Setting Site Hold Time

### MESL

- [MENU] → **Program System** →
- ↻ **Select a trunked system** →
- ↻ **Edit Site** →
- ↻ **Select a site** →
- ↻ **Set Hold Time** →

This setting controls how many seconds the scanner looks at a site before moving to the next unlocked site or system. Using the number keypad, enter a value from 0-255, then press to save the setting.

#### Notes:

- If the scanner cannot detect a control channel on an EDACS or Motorola system, it immediately moves to the next site or system. The scanner always scans LTR or SCAT systems for at least 1 second to check for current activity.
- If you select 0 and the control channel is received, the scanner stays on the system for a minimal time (only long enough to check current system activity).
- The default setting is 2 seconds for each system.
- The scanner moves to the next system after the hold time expires, any current transmission ends, and the channel delay time expires.

### Editing the Band Plan

### M (VHF and UHF only)

In order for the scanner to scan Motorola VHF and UHF sites, you must enter parameters that allow the scanner to determine the frequencies in use by the system. This information is normally available at the same source where the other system information is found.

- [MENU] → **Program System** →
- ↻ **Select a trunked system** →
- ↻ **Edit Site** →

### Programming Your Scanner

- ↻ Select a site →
- ↻ Edit Band Plan →

You can enter up to 3 band plans. Select the plan to enter or edit, then follow the prompts to enter the Base Frequency, Channel Step, and Channel Offset for the site.

## Setting Control-Channel Only Mode

M

- [MENU] → Program System →
- ↻ Select a trunked system →
- ↻ Edit Site (current) →
- ↻ Select site →
- ↻ Set C-Ch Only →

This setting determines the frequencies you need to enter for Motorola systems. Select your setting, then press .

**on** — You only need to enter control channel frequencies.

**off** — You must enter all voice and control channel frequencies.

**Note:** The scanner defaults to **on**.

## Setting Site Location Information

MESL

- [MENU] → Program System →
- ↻ Select a trunked system →
- ↻ Edit Site (current) →
- ↻ Select a site →
- ↻ Set LocationInfo →

This setting control whether the system is automatically enabled and disabled when you connect a GPS to the scanner.

**Set Latitude** — Enter the system's latitude using the format you selected in the system settings.





**Set Longitude** — Enter the system's longitude using the format you selected in the system settings.

**Set Range** — Set the system's range using the units you selected in the system settings.

**Set GPS Enable** — Depending on the data received from the GPS, the L/O status of the site is automatically controlled.

## Deleting Sites

ME

[MENU] → Program System →   
 ↻ Select a trunked system →   
 ↻ Edit Site →   
 ↻ Select a site →   
 ↻ Delete Site →   
 Confirm Delete?  
 Yes="E" / No= ". "





**Important:** Deleted sites cannot be restored. You must re-enter them.

## Programming Channel Groups

MECL

### Setting Up a Channel Group





MECL

[MENU] → Program System →   
 ↻ Select a system →   
 ↻ Edit Group →   
 ↻ New Group → 

The scanner creates a group with a default name of **Group n**. **n** increments by one for each new group you create within a system.

### Editing a Channel Group Name

MECL

[MENU] → Program System →   
 ↻ Select a system →   
 ↻ Edit Group →   
 ↻ Select a New Group →   
 ↻ Edit Name → 

Follow these steps to enter/edit the group name.

1. The current name displays with the first character of the name highlighted.
2. Rotate the **Scroll Control** to select a new first letter. Press **[6]** to move one character to the right. Repeat the **Scroll Control** action to change the character. To move one character to the left, press **[4]**.
3. Repeat Step 2 until you have entered the system name. Then press  to accept the setting.

#### Notes:

- Each group name can be up to 16 characters. Abbreviate as necessary to fit.

- The group and system (for conventional, SCAT, and LTR systems) or site (for Motorola and EDACS systems) name alternate in the top line of the display when the scanner stops on a channel.
- Press **[.No]** twice to delete the current character.
- Press **[.No]** three times to clear the entire alpha tag.

### **Setting the Group Quick Key**

To assign a Quick Key to a Group, follow these steps.

- [MENU]** → **Program System** →
- ↻ **Select a system** →
- ↻ **Edit Group** →
- ↻ **Select the Group** →
- ↻ **Set Quick Key** →

Select a desired quick key for this Group.

### **Editing Channels**

**MECL**

Once you create a channel group, store channels in that group. See “Programming Channels” on Page 79 for specific channel options.

### **Locking Out Channel Groups**

**MECL**

- [MENU]** → **Program System** →
- ↻ **Select an existing system** →
- ↻ **Edit Group** →
- ↻ **Select an existing group** →
- ↻ **Set Lockout** →

This setting determines whether the scanner will scan this group of channels. Select your setting, then press .

**Lockout** — the group is not scanned.

**Temporary L/O** — the group is not scanned for this session. The L/O is cancelled when you cycle power.

**Unlocked** — the group is scanned. The default setting is **Unlocked**.

## ***Deleting Channel Groups***

**MECL**

[MENU] → Program System →   
 ↻ Select a system →   
 ↻ Edit Group →   
 ↻ Select a channel group →   
 ↻ Delete Group →   
 Confirm Delete?  
 Yes="E" / No= ". "

**Important:** Deleted channel groups cannot be restored. You must re-enter them.

## **Programming Channels**

**MECL**

### ***Creating a Channel***

**MECL**

[MENU] → Program System →   
 ↻ Select a system →   
 ↻ Edit Group →   
 ↻ Select a channel group →   
 ↻ Edit Channel →

Select an existing channel to edit or "New Channel" to create a new channel. When you create a new channel you are prompted to enter the frequency (for conventional systems) or Talk Group ID (for Trunked systems). Enter the information for the channel, then press  to proceed to setting additional channel options.

### ***Editing the Channel Name (Alpha Tag)***

**MECL**

[MENU] → Program System →   
 ↻ Select a system →   
 ↻ Edit Group →   
 ↻ Select the channel group →   
 ↻ Edit Channel →   
 ↻ Select the channel →   
 ↻ Edit Name →

Follow these steps to enter/edit the channel name.

1. The current name displays with the first character of the name highlighted.
2. Rotate the **Scroll Control** to select a new first letter.
3. Press **[6]** to move one character to the right.

4. Repeat the **Scroll Control** action to change the character. To move one character to the left, press **[4]**. Press **[.No]** twice to delete the current character. Press **[.No]** three times to clear the entire alpha tag.
5. Repeat Step 2 until you have entered the desired name. Then press **[OK]** to accept the setting.

**Notes:**

- Each channel name can be up to 16 characters. Abbreviate as necessary to fit.
- The channel name appears on the second line of the display when the radio scans or stops on a channel.
- If you do not enter a channel name, the scanner displays the frequency (for conventional systems) or the talk group ID (for trunked systems) when it stops on a channel.

**Editing Frequencies**

**C**

- [MENU]** → **Program System** → **[OK]**
- ↻ **Select a conventional system** → **[OK]**
- ↻ **Edit Group** → **[OK]**
- ↻ **Select a channel group** → **[OK]**
- ↻ **Edit Channel** → **[OK]**
- ↻ **Select the channel** → **[OK]**
- Edit Frequency** → **[OK]**

Use the **[0]** to **[9]** and **[.No]** keys to enter or modify a frequency. When you press the first place key, the cursor automatically moves one character to the right. You can also ↻, clockwise or counter-clockwise to highlight any digit.

**Editing the Talk Group ID**

**MEL**

- [MENU]** → **Program System** → **[OK]**
- ↻ **Select a trunked system** → **[OK]**
- ↻ **Edit Group** → **[OK]**
- ↻ **Select a channel group** → **[OK]**
- ↻ **Edit Channel** → **[OK]**
- ↻ **Select the channel** → **[OK]**
- ↻ **Edit TGID** → **[OK]**

To edit the Talk Group ID, enter the Talk Group ID you want using the number keys. Then press **[OK]**.



## Selecting CTCSS/DCS Tones

C

To program a channel with a CTCSS or DCS setting, your conventional system audio must be set to Analog Only first.

- [MENU] → Program System →
- ↪ Select the system →
- ↪ Edit Group →
- ↪ Select the channel group →
- ↪ Edit Channel →
- ↪ Select the channel →
- ↪ set CTCSS/DCS →

At this point you can scroll to CTCSS or DCS and select the subaudible frequency in the CTCSS range or the DCS code.

- ↪ CTCSS or DCS →

This setting controls how a sub audible CTCSS or DCS is used for the channel. Select your setting, then press .

**off** — any signal opens squelch. The default setting is **off**.

**Search** — the scanner searches for and displays any CTCSS or DCS tone that accompanies the transmission.

**CTCSS** — the scanner only opens squelch if the CTCSS tone you select is also present with the signal. The scanner then prompts you to enter or scroll to the desired tone.

**DCS** — the scanner only opens squelch if the DCS tone you select is also present with the signal. The scanner then prompts you to enter or scroll to the desired tone.

**Set Lockout** — the scanner does not stop on the channel if the tone you select is present. The scanner prompts you to select a CTCSS or DCS tone.

### Quick CTCSS/DCS Save

If you set a channel to CTCSS/DCS Search and the scanner detects a tone, when you press [EYES], the first option is **Save found CTCSS/DCS?**

## Setting Channel Modulation Method

C

- [MENU] → Program System →
- ↻ Select the conventional system →
- ↻ Edit Group →
- ↻ Select a channel group →
- ↻ Edit Channel →
- ↻ Select the Channel →
- ↻ Set Modulation →

**Auto** — the scanner uses the default modulation for the channel. The default setting is **Auto**.

**AM** — the scanner uses AM (amplitude modulation) for the channel.

**NFM** — the scanner uses narrowband FM for the channel.

**FM** — the scanner uses FM (frequency modulation) for the channel.

**WFM** — the scanner uses wideband FM for the channel.

**WFM (Broadcast)** — the scanner uses FM Broadcast for the channel.

This setting controls the modulation method used for the channel. In most cases, if you leave this set to **Auto**, the scanner automatically selects the correct modulation type for the channel you are programming.

## Setting Channel Attenuation

C

- [MENU] → Program System →
- ↻ Select a conventional system →
- ↻ Edit Group (existing site) →
- ↻ Select a channel group →
- ↻ Edit Channel →
- ↻ Select a channel →
- ↻ Set Attenuator →

This setting controls whether the scanner attenuates signals on this channel. Select your setting, then press .

**on** — the channel is attenuated by about 20 dB.

**off** — the channel is not attenuated. The default setting is **off**.

You can also toggle this setting by holding on the channel and pressing then **[7]** within 2 seconds.

## Setting Channel Priority

- [MENU] → Program System →
- ↻ Select a conventional system →
- ↻ Edit Group →
- ↻ Select a channel group →
- ↻ Edit Channel →
- ↻ Select the channel →
- ↻ Set Priority →

This setting controls whether the scanner treats the channel as a priority channel while scanning. Select **on** or **off**, then press

**on** — when you turn on the Priority feature, the channel will be scanned every 2 seconds.

**off** — the channel will not be treated with priority. The default setting is **off**.

## Setting Channel Alert

**MECL**

- [MENU] → Program System →
- ↻ Select a system →
- ↻ Edit Group →
- ↻ Select a channel group →
- ↻ Edit Channel →
- ↻ Select the channel →
- ↻ Set Alert →

**off** — the scanner does not alert you when the channel becomes active.

**Alert 1 - 9** — the scanner sounds an alert beep to notify you that the channel has become active. You can choose any of 9 different beep types. Once you choose an alert tone, then:

- ↻ → Set Level →

**Auto** — the scanner automatically sets the channel alert beep to match the master volume level.

**Level 1 - 15** — the scanner adjusts the volume of the beep to the level you select.

## Setting Channel Record

MECL

- [MENU] → Program System →
- ↻ Select a system →
- ↻ Edit Group →
- ↻ Select a channel group →
- ↻ Edit Channel →
- ↻ Select a channel →
- ↻ Set Record →

**on** — the scanner outputs the signal.

**off** — the scanner does not output any audio.

**Note:** In order for the function to work, you must set the channel to record. You must also set the system's record option to either **All Channel** (which will record all channels regardless of the channel's record setting) or **Marked Channel** (which only records the channels you've set to record).

## Setting Lockout

MECL

- [MENU] → Program System →
- ↻ Select a system →
- ↻ Edit Group →
- ↻ Select a channel group →
- ↻ Edit Channel →
- ↻ Select a channel →
- ↻ Set Lockout →

**Unlocked** — the channel is scanned when its quick key is enabled.

**Temporary L/O** — the channel is locked for this session.

**Lockout** — the channel is not scanned.

## Copying a Channel

MECL

- [MENU] → Program System →
- ↻ Select a system →
- ↻ Edit Group →
- ↻ Select a channel group →
- ↻ Edit Channel →

- ↻ Select a channel →
- ↻ Copy Channel →

You see **Copy Channel Copied to Buffer.**

Press **[MENU]** to return to one level before You see **Paste Channel** as the last list item. At this point you can paste that channel information to another group or compatible system.

### Deleting a Channel

**MECL**

- [MENU]** → Program System →
- ↻ Select a system →
- ↻ Edit Group →
- ↻ Select a channel group →
- ↻ Edit Channel →
- ↻ Select a channel →
- ↻ Delete Channel →

You see **Confirm Delete? Yes= "E" / No= "."**

Select one to delete the channel or to cancel.

## Searching and Storing

### Service Search

Service Search lets you select and search the scanner's preprogrammed search ranges. During service search, the scanner searches starting with the lowest frequency in the search range you select to the highest frequency in the range. There are three ways to do this.

#### [SRVC]

↻ → Select the service search range → 

or

[MENU] → ↻ Search for ... → 

↻ Service Search → 

↻ Select the service search range → 

The other approach is:

 + [SCAN/SEARCH] →

Quick Search? Yes="E" / No="."

Press [No] then to select **Service Search** → 

The following search ranges appear as you scroll ↻

Air  
 Marine  
 CB AM Radio  
 CB FM Radio  
 PMR  
 LPD

The scanner searches the service you selected, stopping on any transmission it finds and displaying the frequency. Turn the Scroll Control to change the search direction. An arrow appears, showing the current search direction.

To pause searching, press [HOLD/RESUME]. To resume searching, press  + [SCAN/SEARCH]. Or, press [HOLD/RESUME].

To lock out a frequency found while searching, press [L/O] one time to temporarily lock it out (**Temporary L/O** appears) or twice to permanently lock it out (**Locked Out** appears).

See the Appendix pages for all Service Search Frequencies.

**Notes:**

- If all frequencies in the search range you selected are locked out, **All Locked!** appears and the scanner does not search the range.
- If the service range you select uses channels (such as CB Radio or Marine), the scanner displays the service channel number.

**Quick Search**

Quick Search lets you search from the currently-tuned frequency if you are scanning a conventional system or sets the system to ID search if you are scanning a trunked system.

If you are on a conventional system or channel, press **[M] + [SCAN/SEARCH]** to start quick search. **Quick Search? Yes = "Y" / No = "N"** appears. Press **[HOLD/RESUME]** to go to quick search hold.

Press **[EYES]** to start quick search or **[.No]** to go to the search menu.

**Custom Search**

Custom Search lets you program and search 10 custom search ranges. You can search any of these ranges simultaneously and select each custom search range you set. During custom search, the scanner searches starting with the lowest frequency in the search range you select to the highest frequency in the range. There are two methods to begin a custom search.

**Default Search Range**

- Custom 1 : 25.0000 - 87.2875 MHz (Plan 1)  
: 25.0000 - 87.2950 MHz (Plan 2)  
: 25.0000 - 87.2937 MHz (Plan 3)
- Custom 2 : 87.3000 - 107.9500 MHz
- Custom 3 : 108.0000 - 136.9875 MHz
- Custom 4 : 137.0000 - 173.9900 MHz (Plan 1,2)  
: 137.0000 - 173.9937 MHz (Plan3)
- Custom 5 : 174.0000 - 215.9500 MHz
- Custom 6 : 216.0000 - 224.9950 MHz
- Custom 7 : 225.000 - 399.9750 MHz
- Custom 8 : 400.0000 - 512.0000 MHz
- Custom 9 : 806.0000 - 960.0000 MHz
- Custom 10 : 1240.0000 - 1300.0000 MHz

**Searching and Storing**

**Notes:**

- Search ranges are preset. These ranges can be edited. See “Editing a Custom Search Range” on Page 88 to change the range.
- You cannot turn off all custom search ranges.

[MENU] → ⤴ Search for ... → ⏏  
 ⤴ Custom Search ... → ⏏

The other approach is:

⏏ + [SCAN/SEARCH] →

Quick Search? Yes="E" / No="."

Press [.No] then ⤴ to Custom Search → ⏏

The scanner starts custom search of the custom search range you selected, stopping on any transmission it finds and displaying the frequency. Turn the Scroll Control to change the search direction. An arrow appears, showing the current search direction.

To turn search ranges on or off, press [0] and [1] - [9]. To hold searching, press [HOLD/RESUME]. To resume searching, press [HOLD/RESUME].

To lock out a frequency found while searching, press [L/O]. There are two different results based on the number of times you press [L/O].

Press [L/O] 1 time: **Temporary L/O** appears

Press [L/O] 2 times: **Locked Out** appears and the scanner resumes custom search.

If you turn off the active custom search range, the scanner skips to the next custom search range and continues searching.

**Note:** If all frequencies in all active custom search ranges are locked out, **All Locked!** appears and the scanner does not stop.

**Editing a Custom Search Range**

You can edit up to 10 custom search ranges. The names of the custom search ranges appear on the display. The default custom search range names appear as **Custom 1**, **Custom 2**, and so on.

[MENU] → ⤴ Search for ... → ⏏  
 ⤴ Edit Custom → ⏏  
 ⤴ Custom 1, Custom 2 to Custom 10. → ⏏



Another approach is

**☐** + **[SCAN/SEARCH]** →

**Quick Search? Yes="E" / No="."**

Press **[.No]** then **↶** to **Edit Custom** → **☐**

At this point you can edit each of the settings that comprise a custom search.

**Edit Name** — lets you edit the custom search range's name.

**Edit Srch Limit** — lets you view and select the frequency ranges to search. The scanner prompts you to enter the upper and lower search limits.

**Set Delay Time** — lets you set the amount of time the scanner will delay before continuing to search after a transmission ends.

**Set Modulation** — lets you set the custom search range's modulation type.

**Set Attenuator** — lets you set whether the scanner will attenuate reception by 20 dB during search.

**Set Data Skip** — lets you set whether the scanner will skip data transmissions during search.

**Set Step** — lets you set the custom search range's step (the gap between frequencies).

**Set C-Ch Only** — lets you search for a Motorola control channel. If it finds one, the scanner scans the system.

**Set Record** — if during your listening to the selected service, if a transmission is received, choosing **on** will send an audio signal to the connected audio recording device.

**Search with Scan** — sets whether the scanner includes the custom search during scanning. If unlocked, the scanner first scans all selected systems, then searches the selected service searches for the selected hold time (0-255 seconds).

Within this menu item are the following settable options

**Set Quick Key** — lets you assign a Quick Key for the custom search range.

**Set Startup Key** — lets you decide which custom search range should be unlocked and scanned at power up

## Searching and Storing



**Set Lockout** — lets you lock the custom search range for this session or permanently as with any other L/O action.

**Set Hold Time** — sets how long (seconds) the custom search range is checked before the scanner moves to the next programmed entry.

## Search With Scan

When you press **[SCAN/SEARCH]** the UBC800XLT starts a scan of those sites, channels, etc you have manually programmed or the Uniden preprogrammed data for your metropolitan area that are unlocked and have their System Quick key enabled.



In addition to this scan you can search any of the preprogrammed service or custom search ranges.



While scanning, press . Rotate the **Scroll Control** until you reach the desired service or custom search range. Press **[L/O]** to unlock it. You can also assign a System Quick Key to the search to make it easy to quickly enable/disable the search range for search and scan. The Search with Scan Hold time determines how long the scanner stays on a search before moving on. The default is 2 seconds.  to set the Search with Scan settings.

## Editing a Service Search

You can change the way service search works for each service. There are also two methods to reach the point of editing.

### Method One

**[MENU]** →  **Search for ...** → 

 **Edit Service** → 



 Select a service range:

**Air, Marine, CB AM Radio, CB FM Radio, PMR, LPD** → 

### Method Two

 + **[SCAN/SEARCH]** →

**Quick Search? Yes="E" / No="."**

Press **[.No]** then  to **Edit Service** → 

At this point you can edit each of the settings that comprise each custom search range.

The following show you how to set the various option settings associated with a Service. For each, your starting operation is

[MENU] → ↻ Search for ... → ●  
 ↻ Edit Service → ●  
 ↻ Select a service range:

## Set Delay Time

Choose a delay time to set how long the scanner stays on a transmission after it ends.

↻ to select a value from **1 sec**, **2 sec**, **3 sec**, **4 sec**, **5 sec**, and **Off**. → ●

## Set Attenuator

Choose to attenuate all frequencies by about 20 dB.

↻ to select to choose an attenuation for all frequencies in the range. → ●

**on** — the frequencies are attenuated.

**off** — the frequencies are not attenuated.

## Set Record

↻ to enable real time audio output from **REC** to an audio recording device.

**on** — the scanner outputs the signal. Then press ● to select.

**off** — the scanner does not output any audio. Then press ● to select.

## Assigning a Search Range to a Search Key

You can assign any of the Service or Custom Searches to the six Search keys for quick access to your favorite searches.

[MENU] → ↻ Search for ... → ●  
 ↻ Set Search Key → ●  
 ↻ Select the key to assign → ●  
 ↻ Select a search range → ●

Now, to access that search, hold on any channel, then press ● and the number key **[1]** to **[6]** corresponding to the search range.

The default settings are:

- SRCH 1: 25.000~87.2875MHz (Plan1)  
25.000~87.2950MHz (Plan2)  
25.000~87.2937MHz (Plan3)
- SRCH 2: 87.3000~107.950MHz
- SRCH 3: 108.000~136.9875MHz
- SRCH 4: 137.000~173.9900MHz (Plan1,2)  
137.000~173.9937MHz (Plan3)
- SRCH 5: 174.000~215.9500MHz
- SRCH 6: 216.000~224.995MHz

## Saving a Found Channel (Quick Save)

If you hold on a channel or receive a desired channel, you can save it by pressing **[EYES]** instead of using Direct Entry. The alpha data is also stored.

If a GPS unit is attached, the longitude and latitude data is saved and becomes the name of that channel. For example, if the position is **32°57'33.60 N** latitude and **97°05'34.18 W** longitude, the name saved is **3257.33-09705.34**.

## Auto Search and Store

Your scanner's Auto Store feature lets you search for new frequencies in custom search ranges or within a service search range on a conventional system, or new talk group ID's on a trunked system.

### Selecting a System to use for Storing

To store frequencies or talk group ID's you find during Auto Store, you must first select a system where the frequencies or talk group ID's will be stored.

- [MENU]** → **↻ Search for ...** → **Ⓚ**
- ↻ Search and Store** → **Ⓚ**
- ↻ Select the system for storing the frequencies or talk group IDs** → **Ⓚ**

If no system is selected, **No System Stored** appears. If you have already stored too many channels or channel groups, **Over Limit** appears.

### Conventional Search and Store

You can store frequencies into the system you selected in "Selecting a System" above. Otherwise, the scanner stores frequencies in a new group it creates.

Follow the steps in the preceding section but be sure to select a Conventional System. A search option appears that lets you choose from a **Custom Search** to the other service search ranges previously mentioned (Air, Marine...etc).

Turn the **Scroll Control** until the search range you want appears, then press  to select it. One of the search ranges appears.

If frequencies in your selected search range are all locked out, **All Locked!** appears and the scanner does not store any frequencies.

When you select a search range, the scanner looks for active frequencies within that range. The top line of the display alternates between the system name and the search range name while **SEARCH AND STORE** appears beneath it. The second line changes to **Memory Check** when the scanner detects a transmission while it is checking to see if the frequency has already been stored.

When the scanner finds an active transmission, it checks to see if the frequency has already been stored in the system. If it has already been stored, the scanner continues to search. If the frequency has not been stored, it stores the frequency into a group named **Found Channels**, then resumes searching. The scanner creates this group if it doesn't already exist.

### **Trunked Search and Store**

You can store talk group ID's into the system you selected in "Selecting a System". Otherwise, the scanner stores talk group ID's in a new group it creates.

**Note:** Trunked system search and store does not work if an EDACS SCAT system is selected, a system with no frequency is selected, the quick key to which the system belongs is turned off, and the group you selected to store found talk group ID's contains more talk group ID's than the maximum set in Max Auto Store.

To store a trunked system, follow the beginning steps in Selecting A System above. When you select a Trunked System and press  the scanner enters TGID Search and Store mode.

When you select a trunked system, the scanner looks for active talk group ID's within that range and **ID SEARCH AND STORE** appears and scrolls across the display's lower line while the system/site name appears on the display's upper line. When the scanner finds an active talk group ID, it checks if the talk group ID has already been stored in the site. If it has, the scanner continues to search. If the talk group ID has not been stored, it stores the talk group ID into a group named **Found Channels**, then resumes searching. The scanner creates this group if it does not already exist.

## **Searching and Storing**

## Using the Close Call Feature

Your scanner's Close Call™ feature lets you set the scanner so it detects, displays the frequency and lets you hear a nearby strong radio transmission. You can set the scanner so the Close Call feature works “in the background” while you are scanning other frequencies, turn off normal scanning while the Close Call feature is working, or turn off the Close Call feature and use the scanner normally. You can set the scanner so it alerts you when the Close Call feature finds a frequency. You can also set the frequency band where you want the scanner to look for transmissions.

To toggle Close Call mode, press **[SQ/☉]**. When the feature is on, **CC DND(☉)** or **CC Pri(☉)** and their indicating icons appear on the display. Using CC Priority, normal operation is briefly interrupted about every 2 seconds.

### Notes:

- The Close Call feature works well for locating the source of strong local transmissions such as mobile and handheld two-way radios in areas with no other strong transmission sources. Several factors affect Close Call performance, however. Performance is increased with higher transmit power, receive antenna tuned to the target band, and a low background RF level. Other than the antenna, you have no control over these factors, but they explain why performance might vary by both location and time.
- The Close Call feature cannot detect satellite dishes or any transmitter with a frequency above or below the frequency ranges listed under the Set CC Bands: option on Page 96.
- The Close Call feature works better with some types of transmissions than others. It might not correctly display frequency information for transmitters using a highly directional antenna (such as an amateur radio beam antenna) or if there are many transmitters operating at the same time in the same area.
- The “Close Call” mode can detect frequencies on the default band step only.



## Setting Close Call Options

**[MENU]** → **☰** **Close Call** → **☑**

Next, turn the Scroll Control **☰** to select an option.

**Close Call Only** — Lets you set the scanner only for Close Call searching. The scanner does not scan frequencies or channels when this option is turned on. To select this option, press **☑**.

**CC Auto Store** — Lets you select whether the scanner automatically stores Close Call hits into channels. If you turn this option on, the scanner starts Close Call mode and stores any Close Call hits, up to the maximum you specified in the **Max Auto Store** setting. If the scanner stores more hits than this setting, it stops auto store operation.

Turn the Scroll Control  to display an option, then press .

**Set CC Mode** — Lets you select the Close Call mode. If you set **CC Pri**, then every 2 seconds the scanner switches the filter settings to the ones set by the **CC Bands** option. This does not occur with **CC DND**.

**off** — Close Call is turned off for all modes.

**CC DND (Do Not Disturb)** — The scanner checks for a Close Call hit every 2 seconds only if the scanner is not currently stopped on a transmission. If the scanner is on a transmission the scanner waits until the signal ends to perform a Close Call check. This prevents breaks in audio during Close Call checks.

**CC Pri (Priority)** — Checks for a Close Call hit every 2 seconds.

**Set CC Override** — Lets you select how the Close Call feature works with other scanning activities. If you turn this option off, when the scanner detects a Close Call signal, **CC Found! Press Func Key** appear for the time you set in **Set CC Pause**. Press  when this appears to jump to and hold on the frequency.

If this option is turned on, the scanner overrides the current channel and goes to the Close Call hit. The scanner displays **CC Found! Press Any Key**. When you press a key, the frequency appears.

**Set CC Alert** — Lets you select how the scanner alerts you when it receives a Close Call signal. You can select from these options.

**Select Beep** — The scanner beeps when it receives a Close Call signal. You can set the beep alert in the following manner.

**off** — the scanner does not beep

**Alert 1-9** — The scanner sounds a specialized beep to notify you of a Close Call hit. When you select an alert type, the scanner automatically enters the setting of the Alert volume level. Each alert has a unique one or sound pattern.

**Set CC Pause** — Lets you select how long the scanner waits after a hit before it returns to the previous operation. Your options are:

**3/5/10/15/30/45/60 sec.**

## Using the Close Call Feature

**Infinite** — The scanner stops and requires you to manually select another operation to enable its return.

**Set CC Bands** — Lets you select the Close Call band settings. You can turn the following bands on or off.

**VHF Low 1** : On/Off: 25.0000 - 53.9875 MHz Plan1  
                   : 25.0000 - 53.9950 MHz Plan2  
                   : 25.0000 - 53.9937 MHz Plan3

**VHF Low 2** : On/Off: 54.0000 - 107.9500 MHz



**Air Band** : On/Off : 108.0000 - 136.9875 MHz Air 12.5k  
                   : 108.0000 - 136.9916 MHz Air 8.33k

**VHF High 1** : On/Off : 137.0000 - 224.9950 MHz

**VHF High 2** : On/Off : 225.0000 - 319.9750 MHz

**UHF** : On/Off : 320.0000 - 512.0000 MHz

**800MHz+** : On/Off : 806.0000 - 1300.0000 MHz

Use the **Scroll Control**  to select a band, press , then use the **Scroll Control** to select **on** or **off** and press . Turning off undesired bands speeds up Close Call operation (works for all frequencies listed above).

## Close Call Hits

When the scanner detects a Close Call hit, it alerts you according to the Override and Alert settings in the previous section.

While listening to a Close Call hit, you can press **[HOLD/RESUME]** to hold on the hit frequency, press **[EYES]** to quickly save the frequency into memory, press **[L/O]** to lock out the frequency from Close Call and Search operation, or wait for the transmission to end. If you are in Close Call Only or Close Call Override mode, and you do not press any key, the scanner returns to its previous operation after the transmission ends and the set delay time expires.



If you are holding on the frequency, press **[HOLD/RESUME]** again to resume the previous operation.



Close Call Hits are just the last 10 hits received in Close Call mode. The hits go away when you cycle power (if you want to store it “permanently” press **[EYES]** when the scanner is on the frequency; the scanner then stores the frequency into the “Close Call” system which does show up in the systems list).



## Close Call Hits with Scan

The scanner automatically stores and scans the last 10 Close Call hits received. You can assign a Quick Key to this special scan. This lets you continue to hear transmissions detected with the Close Call feature, even after you are no longer close enough to receive it as a Close Call hit. Follow these steps to set up the option.

[MENU] →  Close Call → 

 Hits with Scan → 

 Set Quick Key or Set Lockout or Set Hold Time → 

Set the available option as you would for other menu items.

This special channel group is automatically cleared whenever you cycle the scanner's power. To permanently save one of the channels, press [EYES] when the scanner is stopped on one of the frequencies. To keep the scanner from repeatedly stopping on an annoyance hit, press [L/O] when the scanner stops on the frequency.

## Using the Close Call Feature

## Search and Close Call Options

The settings in this section affect custom searches, service searches, and Close Call operation. The following table shows what options are available for various search modes.

Setting	Service Search <sup>1</sup>	Custom Search <sup>1</sup>	Quick Search	Search and Store	Close Call	CC Auto Store	CC Hits System
Freq. Lockouts	•	•	•	•	•	•	
Broadcast Screen		•	•	• <sup>2</sup>	•	•	
CTCSS/DCS Search	•	•	•	•	•	•	
Max Auto Store				•		•	
Set Delay Time			•		•		•
Set Modulation			•		•	•	
Set Attenuator			•		•	•	
Set Data Skip	•		•	• <sup>3</sup>	•	•	•
Set Step			•				
Air Band Step	•	•	•	•	•	•	
Set Record			•		•		•

1 — Valid only for searching a range using Search with Scan.

2 — Valid only for storing a frequency from Search and Store.

3 — Valid only for storing a frequency from Service Search.

### Managing Locked-Out Frequencies

While searching or during Close Call operation, if you press [L/O] while the scanner is stopped on a frequency, that frequency is locked out of these modes. The temporary L/O frequency limit is 250. The permanent L/O frequency number limit is up to 250.

## Unlocking All Frequencies

[MENU] → ⤴ Srch/CloCall Opt → Ⓚ  
 ⤴ Freq Lockouts → Ⓚ  
 ⤴ Unlock All → Ⓚ

The scanner prompts you to confirm the change in lockout status. To confirm the change of all locked-out frequencies, press Ⓚ. If no frequencies are locked, you see **Nothing Locked Press Any Key**. Otherwise, to cancel, press [MENU].

## Reviewing Locked-Out Frequencies

[MENU] → ⤴ Srch/CloCall Opt → Ⓚ  
 ⤴ Freq Lockouts → Ⓚ  
 ⤴ Rvw Search L/O → Ⓚ

The scanner displays the first locked-out frequency and prompts you to unlock the frequency. Press Ⓚ to unlock the frequency. Or, rotate the Scroll Control or press to select a different frequency. If there are no frequencies to review, you see **Nothing Locked Press Any Key**. Otherwise, to cancel, press [MENU] to backstep.

## Searching for Subaudible Tones

[MENU] → ⤴ Srch/CloCall Opt → Ⓚ  
 ⤴ CTCSS/DCS Search → Ⓚ  
 ⤴ On or Off → Ⓚ

This setting controls whether the scanner will search for a subaudible tone when it stops on a transmission during search or Close Call operation.

**on** — The scanner searches for and displays any subaudible tone found.

**off** — The scanner does not search for subaudible tones.

**Note:** This feature does not operate when the scanner is in AM/WFM/FMB modulation mode.

## Screening Out Broadcast Sources

[MENU] → ⤴ Srch/CloCall Opt → Ⓚ  
 ⤴ Broadcast Screen → Ⓚ

This setting determines whether the scanner automatically ignores transmissions found during Custom Search, Quick Search, or Close Call operation that are on common broadcasts, paging systems, and other annoyance radio sources.

**Note:** Broadcast screening does not work in All service search ranges.

**Set All Band On** — turns on broadcast screen on each band.

**Set All Band Off** — turns off broadcast screen on each band.

**Set Each Band** — lets you set broadcast screen only on **specific** bands you select. **On** or **Off** appears next to each option. Turn the **Scroll Control** to select an option then press  to change the setting.

**Band 1-10** — select the custom band where you want to screen out broadcast sources.

**Program Band** — brings you to a menu setting to let you program a custom frequency range for broadcast screen. Turn the **Scroll Control** to select an option then press  to change the following setting.

To set the custom range of a band, select one and press  to set the limit.



**Band 1-10** — select the group where you want to screen out broadcast sources.

**Set Lower Limit**— enter the lower limit of the frequency range, then press  to set it.

**Set Upper Limit** — enter the upper limit of the frequency range, then press  to set it.

To set the custom range of a band, select one and press  to set the limit.

## Setting the Maximum Auto Store Value

[MENU] →  Srch/CloCall Opt → 

 Max Auto Store → 

This value sets how many hits the scanner will automatically store when it is in either Search and Store or Close Call Auto Store mode. Use the number keys to enter a value from 1 - 256, then press . The default value is 100.

When the scanner exceeds the maximum number of hits you set, it stops the auto-store operation.

## Setting the Modulation Type

This setting controls the modulation method used to receive frequencies during Quick Search and Close Call operations. In most cases, if you leave this set to **Auto**, the scanner automatically selects the correct modulation type for the system you are programming.

[MENU] → ⤴ Srch/CloCall Opt →

⤴ Set Modulation →

**Auto** — the scanner uses the default modulation for the frequency band. The default setting is **Auto**.

**AM** — the scanner uses AM (amplitude modulation) for the frequency band.

**NFM** — the scanner uses narrowband FM for the frequency band.

**FM** — the scanner uses FM (frequency modulation) for the frequency band.

**WFM** — the scanner uses wideband FM for the frequency band.

**WFM (Broadcast)** — the scanner uses FM Broadcast for the frequency band.

## Setting Attenuation

Turn on this setting if you are near other strong signal sources. Attenuation sometimes helps to reduce interference and desensitization that strong signals create.

[MENU] → ⤴ Srch/CloCall Opt →

⤴ Set Attenuator →

This setting controls the attenuator for Quick Search and Close Call operation. Select your setting, then press .

**on** — Reception is attenuated by about 20 dB.

**off** — Attenuation is off.

## Setting Data Skip

[MENU] → ⤴ Srch/CloCall Opt →

⤴ Set Data Skip →

This setting controls how the scanner behaves when it stops on a channel that has a data signal.

## Search and Close Call Options





**On** — the scanner stops briefly on the channel, but then immediately resumes scanning automatically.

**off** — the scanner remains on the channel until the transmission stops. The default setting is **off**.

**Note:** If you are trying to test the Close Call feature with a nearby transmitter (such as a CB) and you do not talk into the transmitter, the scanner detects this unmodulated carrier as data and skips the frequency when Data Skip is on. Turn the feature off or talk into the transmitter to modulate the carrier.

This setting is ignored for AM/WFM/FMB channels.

### Setting the Delay Time

[MENU] →  Srch/CloCall Opt →   
 Set Delay Time → 

This setting determines how long the scanner waits after a transmission ends before resuming Quick Search or Close Call operation.

**1-5 sec** — The scanner waits the set amount of time after the transmission ends before resuming. The default setting is 2 sec.

**off** — The scanner resumes immediately when the transmission ends.

### Setting the Search Frequency Step

[MENU] →  Srch/CloCall Opt →   
 Set Step → 





This setting lets you select the frequency step used during Quick Search.

**Auto** — The step is based on the band (see the table at the front of the manual). This is also the default setting.

5.0 kHz, 6.25kHz,  
8.33kHz, 10.0 kHz,  
12.5 kHz, 15.0 kHz,  
20.0 kHz, 25.0 kHz,  
50.0 kHz, 100.0 kHz

The scanner uses the selected step.

## Setting Air Band Step





[MENU] →  Srch/CloCall Opt →   
 Air Band Step → 

Select Air Band Step

8.33kHz  
 12.5kHz

## Setting Record

You can set the **REC** jack to provide an audio signal to a sound recording device (tape, PC, flash memory) for live recording of transmissions. This also lets you record Quick Search and Close Call transmissions.

[MENU] →  Srch/CloCall Opt →   
 Set Record → 

**on** — enables an output to an audio recorder at the **REC** (record output) jack.

**off** — disables an audio signal at the output jack.

## Priority Scan

If you activate a Priority Scan while scanning, the radio interrupts its scan every two seconds to check the priority channel (P-Ch). **PRI** appears on the screen.

There are two ways to set Priority Scan.

1. Press [**PRI**] to set one of the following Priority Scan levels in Scan / Scan Hold mode.

**off** — Normal scanning. The scanner provides no special treatment for Priority Channels.

**on** — The scanner scans all unlocked channels and also checks those designated as Priority. While scanning the scanner interrupts every 2 seconds and checks the priority channels in each unlocked conventional system. Priority channels in lower priority key numbered systems (starting from 1) have highest priority. **PRI** appears when you select this mode.

## Search and Close Call Options

**Plus On** — The scanner only scans priority channels in unlocked conventional systems. **PRI** flashes when you select this mode.

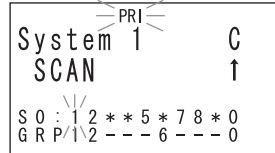

2. You can choose how the scanner treats Priority Channels using the Menu options.

**[MENU]** → **U** set Priority → **Q**  
**U** Choose Off, On, or Plus On → **Q**



## Fire Tone-Out

Your scanner can be set to respond to fire tone-outs, a system comprised of standardized two-tone sequential paging, short one-tone paging, and long group tone paging. You can save up to 10 settings. When you select a setting in standby mode, the scanner also monitors for any other setting that uses the same transmit frequency, modulation, and attenuation settings. To quickly switch to Fire Tone-Out mode, press **[M]** and then **[SQ]**.

You need tone-out setup information from the agency you wish to monitor. Check with your local agency or on-line resources.

### Setting Tone-Out Standby

**[MENU]** → **[T]** Tone-Out for... → **[M]**  
**[T]** Tone-Out Standby → **[M]**

Turn the **Scroll Control** **[T]** to select which of the ten tone-outs to monitor. Or, press **[M]** then **[SQ]** to quickly switch to Tone-Out Standby, then rotate scroll to select the settings to monitor. All tone-outs that have the same frequency, modulation, and attenuation setting as the one you select, are also monitored.

In standby mode, the display cycles through all monitored tone-out settings. Regardless of the current display, the scanner always alerts on any received tone-out that matches a stored setting.

If you press **[HOLD/RESUME]** while in standby mode, the scanner temporarily exits the mode and you hear all transmissions on that frequency. No alerts sound, even if a tone-out matches one you have stored. Press **[HOLD/RESUME]** again to return to standby mode.

### Setting Up Tone-Out

**[MENU]** → **[T]** Tone-Out for... → **[M]**  
**[T]** Tone-Out Setup → **[M]**

Scroll to select the tone-out (1 - 10) you want to program, then press **[M]**. Then you can scroll to any of the following settings and press **[M]** to select and modify the selected settings:

**Edit Name** — Sets the name for the selected tone-out setting.

**Set Frequency** — Sets the tone-out's RF frequency parameters. Then select:

### Fire Tone-Out

- **Edit Frequency** — Enter the desired frequency that the scanner should monitor for the tone-out.
- **Set Modulation** — Set the modulation type for the paging signal. Next choose the modulation setting:
  - **Auto** — The scanner uses the default modulation for the frequency band. If the default modulation is AM, WFM, or FMB, the modulation operates as FM.
  - **NFM** — The scanner uses NFM modulation.
  - **FM** — The scanner uses FM for the frequency band. This is the default setting.
- **Set Attenuator** — Press  then turn the **Scroll Control** to select **On** or **Off**.

**Set Tone** — Sets the audio tone frequency for the page. Then choose the Tone setting.

- **Edit Tone A** — Set the audio frequency for Tone A
- **Edit Tone B** — Set the audio frequency for Tone B

**Notes:**

- For two-tone pages, enter a value for A and B.
- For one-tone pages using short tones of less than 3.75 seconds, enter the tone value for A, and 0 (zero) for B.
- For long-tone pages, such as group pages of more than 3.75 seconds, enter 0 (zero) for A and the tone value for B.

**Set Delay Time** — Sets the time the scanner remains in monitor mode after the scanner receives a page and the carrier drops.

- **1-5 sec** — the scanner resumes standby mode after the carrier drops and the selected time expires.
- **Infinite** — you must press **[HOLD/RESUME]** after a page to resume standby mode.
- **off** — the scanner resumes standby as soon as the carrier drops after a page.

**Set Alert** — Sets the alert the scanner uses when it receives an alert.

- **Alert 1 - 9** — scroll to select the alert tone pattern, The scanner sounds each alert as you scroll to its numbered value.
- **off** — the scanner does not sound an alert.

After you select an alert pattern, the scanner prompts for the alert level for a received alert. Level options 1 to 15 sets a fixed audio level independent of the main volume setting. **AUTO** uses the main volume setting for the alerts.

## Tone-Out Multi-Channel Monitoring

The scanner can check multiple tone combination pages for channels whose settings are the same. To achieve this, set the channel to the same frequency, modulation, and attenuator. For example, the scanner checks tone combinations for channel 1 to channel 4 for the following settings.

	Frequency (MHz)	Modulation	Attenuator	Tone A (Hz)	Tone B (Hz)
Ch 1	137.0000	Auto (FM)	Off	1000.0	2000.0
Ch 2	137.0000	Auto (FM)	Off	2200.0	3200.0
Ch 3	137.0000	Auto (FM)	Off	1500.0	2500.0
Ch 4	137.0000	FM	Off	1800.0	2800.0
Ch 5	137.0000	NFM	Off	2000.0	3000.0
Ch 6	138.0000	Auto (FM)	Off	1000.0	2000.0

Although set to Auto, if the band default is anything other than FM or NFM, modulation will always be FM.

If you switch to Tone-Out Standby Mode for Multi-Channel Monitoring, the display switches every 2 seconds to show the FM frequency it is checking. However, it is, at the same time, checking all frequencies for Tones. If one is detected, it switches to Tone-Out Hold mode.

## Set Record

**U** to enable real time audio output from **REC** to an audio recording device.

**on** — the scanner outputs the signal to **REC**. Press **OK** to select.

**off** — the scanner does not output any audio. Press **OK** to select this option.

## Fire Tone-Out

## Using the UBC800XLT with a GPS

The scanner lets you connect a compatible GPS device to it to provide two very convenient operation features:

- automatically locks and unlocks systems and sites based on data you input. This fine-tunes the scanning operation and makes it that much enjoyable.
- provides you with valuable displayed information and audio alerts for Points of Interest, Dangerous Roads, and Dangerous Crossings. The GPS works in close coordination with your scanner.

### Device Compatibility

The GPS must have serial output, and capable of outputting standard NMEA sentences GGA and RMC. (See "NMEA-0183 ver.3.01" which can be found on the web.)

### Connecting Your Scanner to a GPS Device

To use the location-based features of the scanner, you must connect a GPS to the unit. Use the cable provided by the GPS manufacturer. Make sure that their cable terminates in a female, 9-pin serial connector. Insert that plug into the male, 9-pin socket on the back of the scanner labeled **REMOTE/GPS**. Once the GPS is connected, refer to the following sections dealing with inputting selections to enable location based feature operation.

### Initial Scanner/GPS Operation

When the scanner first starts receiving a signal from the GPS, it briefly displays **GPS CONNECTED** and silently locks and unlocks all radio system and sites whose quick key is enabled according to your current location. If you have a lot of data programmed, it might take the scanner a couple of minutes to complete the process. Once the scanner completes the initial GPS review, if you move into or out of an area covered by a radio site, the scanner beeps and displays the name of the system and whether it is being locked or unlocked.

**Note:** The GPS function temporarily locks out sites and systems when you move out of their range. If you cycle power, all systems are unlocked until the scanner reacquires the GPS signal and completes the initial GPS review.

## Location-Based (GPS) Scanning

The UBC800XLT can make use of data transmitted from an attached GPS unit that lets the radio automatically enable and disable systems based on the geographic information you provide such as:

Latitude (the center of the range)

Longitude (the center of the range)

Range (the radius of a circle around the latitude and longitude coordinates selected from 0.5, 1.0, 2.0, 3.0, 5.0, 10.0, 20.0, 25.0, 50.0, 75.0 and 100.0 km (0.5, 1.0, 2.0, 3.0, 5.0, 10.0, 20.0, 30.0, 50.0, 75.0 and 100.0 miles)

You set the longitude and latitude to approximate the center of a geographic entity such as your local city and set the range to encircle that center point. By doing so you set aside reception of an adjacent city that otherwise might be undesirably received from one extremity of your city.

In addition, all geopolitical areas are not perfect circles. Therefore you can accommodate these variations by entering multiple sites for the system, even though the system actually has one site, and use different location settings for each of those additional sites.

See the programming section for specific steps required to apply location data to a radio system.

## Non-Radio Location Based GPS Features

When connected to a GPS, you can program specific location information which will trigger an alert from the scanner. The following geographically based values are typical of the use you might find valuable while traveling. Use the menu to input the necessary data to enable each.

- Dangerous Xing — Stores location, and direction of travel. If you are in range, traveling in a direction that will take you to that Point, the radio sounds an alert at 1.0km, 0.5km and 0.1km or (1.0mile, 0.50mile and 0.10mile) from the point.
- Dangerous Road — Stores location, direction of travel, and speed. If you are traveling at a speed greater than that specified and if you are within range of the set location, the scanner sounds an alert at 1.0km, 0.5km, and 0.1km or (1.0mile, 0.50mile and 0.10mile) from the point.
- Points of Interest (POI) — Stores location and range. If you approach the set location, the radio sounds an alert.

In general, an alert based on location is comprised of the following data:

- Latitude
- Longitude
- Speed (optional setting)
- Name (optional setting)
- Alert Type and Sound level (optional setting)
- Direction (optional setting)

There are four setting conditions that can be set to result in alerts:

- A speed setting greater than zero with no direction entered. This results in an alert based only on speed in any direction.
- A speed setting greater than zero with a specific direction entered. This triggers an alert when the speed is exceeded but only in the specified direction.
- Speed is equal to zero and a direction is entered along with a location. This setting is used for a dangerous intersection alert.
- Speed is set to zero and no direction is entered but only location. This is a point of interest alert.

By pressing & holding **[GPS]**, you can select a location type and store current location data.

The following table shows the attributes available for each category. Note that some options are different for a specific location type. Refer to the information that follows to set those specific attributes.

Menu Option	POI	Dangerous Xing	Dangerous Road
New Location	•	•	•
Edit Name	•	•	•
Set Type (edit)	•	•	•
Set Alert Beep	•		
Set Alert Volume		•	•
Set Location Info	•	•	•
Set Heading		•	•

Menu Option	POI	Dangerous Xing	Dangerous Road
Set Range	•		
Set Speed Limit		•	•
Set Lockout	•	•	•
Delete Location	•	•	•

## Setting the Options

[MENU] → ⤴ Program Location → Ⓚ

⤴ Select a location type (POI, Dangerous Xing, or Dangerous Road). → Ⓚ

⤴ New Location → Ⓚ

The scanner assigns a sequentially created number to the location.

⤴ Edit Name → Ⓚ

Use the Scroll Control and Ⓚ to give the New Location a name. You could, for example, enter the name of the place or the Route Number.

⤴ Set Type → Ⓚ At this level you have an opportunity to reassign or edit the location type you first selected and set the location to either one of the other types or change the data in an existing location.

This option also lets you associate a new Alert Tone to POI. Dangerous Xing and Dangerous Road each have unique Alert Tones that cannot be changed. You can still set a different volume level with the new Alert Tone for all three types.

⤴ Set LocationInfo → Ⓚ Input the latitude and then longitude.

⤴ Set Lockout → Ⓚ As you near your target location, an alert sounds at 1.0km, 0.5km, and 0.1km or (1.0mile, 0.50mile and 0.10mile). If you hear the first and prefer to not hear any others that occasion, simply press [L/O] to disable the operation while keeping all the data for another time. You can use the menu Lockout option as well. When you set the location system to **Temporary L/O** and move away more than four miles and then come back again, **L/O** status is automatically canceled. If you turn off the switch, the scanner is unlocked.

## Deleting a Location

If you have programmed a location that you no longer want, you can delete it as follows.

[MENU] → Program Location →

↪ Select a location such as **Dangerous Xing** →

↪ Select Location to be deleted →

↪ Delete Location →

↪ Confirm Delete? Yes="E" / No="." →

Make your choice to either delete the location or to cancel your action.

### **For POI Only**

↪ Set Alert Beep → Choose **off** so no tone sounds or one of the alert melodies **Alert 1** to **Alert 4**.

Once you make a Tone selection you are then asked to assign a volume level to that selection.

Set Alert Volume → Select from 15 sound levels, plus Auto. As you rotate the **Scroll Control** the Alert tone you set is played louder and louder. Press to select a volume level. You can also select **Auto**, a level that is the same setting as your master volume control.

↪ Set Range → Input how far away the alert sounds for the site (only available for POI's)

### **For Dangerous Xing, and Dangerous Road Only**

The Alert Tone is fixed.

↪ Set Alert Volume → Select from 15 sound levels, plus Auto and Off. As you rotate the **Scroll Control** the Alert tone is played louder and louder. Press to select a volume level. You can also select no sound (Off) or Auto, a level that is the same setting as your master volume control setting.

For Dangerous Xing and Dangerous Road sites there are two additional settings:

↪ Set Heading → You can input the compass direction to the site from your present location or, you can select **All Range**.

For example: If the **Dangerous Road** location is toward the Northeast and you are driving in that direction, then choose **NE (45°)**

If you know you will be driving a course which is not a fairly straight line to that site, choose **All Range** which will trigger the alert regardless of direction as long as the other requirements (range, speed) are met.

If you travel in a Northeast direction and do not travel either side of a northeast line by up to 22 degrees, the alert system will function.

↪ Set Speed Limit → Choose from 0 ~ 160km/h in 10km/h steps or 0 ~ 80mile/h in 5mile/h steps.



## GPS Display Mode

If you press **[GPS]**, the scanner switches to a GPS display mode. In this mode, you can see location information as well as information about your position relative to the selected POI. The third line of the screen shows **OFF** if no POI is selected.

Rotate the **Scroll Control** to select different POI's.

Press **[OK]** + **[GPS]** to toggle the Display mode in order.

<b>SW</b> 01:23P
39 mph 544 ft
<b>OFF</b>
SCAN ↑

GPS DATA Display

<b>SW</b> 1h 10m
15.03 mi
<b>HOME</b>
SCAN ↑

ETA Display

<b>SW</b> 13:23
15.03 mi
<b>HOME</b>
SCAN ↑

Clock Display

<b>SW</b> 166 m
24.19 km
<b>HOME</b>
SCAN ↑

Elevation Display

<b>SW</b> 62 kmh
24.19 km
<b>HOME</b>
SCAN ↑

Speed Display

N 32°57' 33.60
W 97°05' 34.18
<b>HOME</b>
SCAN ↑

Location Display

## GPS Review Location Mode

If you have programmed data for a Point of Interest, Dangerous Crossing, and a Dangerous Road, you can review each set on a screen dedicated to showing just that data.

Press **[EYES]** in GPS Mode.

**Important:** While you are in normal GPS mode or Scan Mode and you press and hold **[GPS]** for 2 seconds, location data at that point is stored. The scanner opens a dialog to store your current location. The default name is T YYMMDD hhmms that indicates the date and time you stored the location point.

The data is put into memory and you are given the opportunity to designate the location as POI, Dangerous Xing, or Dangerous Road.

However, if you are in Review Mode and press and hold **[GPS]**, the data of the new point will overwrite the currently displayed data.

The some of the following keys have a somewhat different function while in GPS Review Mode.

### Using the UBC800XLT with a GPS

**[GPS]** — Press and Hold: overwrites and stores current location data.

**[MENU]** — returns to GPS Mode.

**[L/O]** — changes the status of the currently displayed location data.

**[L/O]** — press and hold to unlock all locations of the current type (POI, DXG, or DRD)

**Unlocked All TTTs?** and **Yes="E" / No="."** is displayed. **TTT** shows the location type as POI, DXG or DRD.

**[L/O]** — press and hold in Function Mode unlocks all locations of all types.

**Unlocked All Location?** and **Yes="E" / No="."** is displayed.

**[.No]** — returns to GPS Mode.

**[EYES]** — lets you edit a location details.

**[SCAN/SEARCH]** — enter scan mode.

**[HOLD/RESUME]** — enter Scan Hold mode.

**[ ]** — enter Function Mode.

**[ ]** — select a programmed location from all stored locations. The location data is stored in the order POI, Dangerous Xing, and Dangerous Road. Then, within each category, the data is stored by the programmed name.

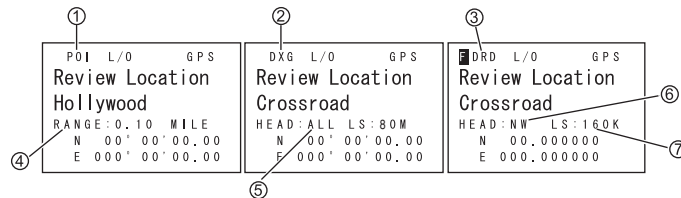

1. POI — Indicates a Point of Interest location.
2. DXG — Indicates a Dangerous Crossing location.
3. DRD — Indicates a Dangerous Road location.
4. Range — Indicates the programmed distance to your POI.
5. Head — Indicates the selected heading to the designated Dangerous Crossing from **any** direction.
6. Head — Indicates the selected heading to the designated Dangerous Road from a set direction.
7. LS — Indicates the maximum Speed Limit you set.

## Care and Maintenance

### General Use

Turn the scanner off before disconnecting the power.  
If memory is lost, simply reprogram each channel.  
Always press each button firmly until you hear the entry tone for that key entry.

### Location

Do not use the scanner in high-moisture environments such as the kitchen or bathroom.

Avoid placing the unit in direct sunlight or near heating elements or vents.

If the scanner receives strong interference or electrical noise, move it or its antenna away from the source of the noise. If possible, a higher elevation might provide better reception.

Also try changing the height or angle of the antenna.

### Cleaning

Disconnect the power to the unit before cleaning.

Clean the outside of the scanner with a mild detergent.

To prevent scratches, do not use abrasive cleaners or solvents. Be careful not to rub the LCD window.

Do not use excessive amounts of water.

### Repairs

Do not attempt any repair. The scanner contains no user serviceable parts. Contact the Uniden Customer Service Center or take it to a qualified repair technician.

### Birdies

All radios can receive "birdies" or undesired signals. If your scanner stops during Scan mode and no sound is heard, it might be receiving a birdie. Birdies are internally generated signals inherent in the electronics of the scanner.

Press **[L/O]** to lock out the channel.

## Troubleshooting

If your UBC800XLT is not performing properly, try these steps.

Problem	Possible Cause	Suggestion
The scanner doesn't work.	The scanner might not be receiving any power.	Make sure the AC adapter is connected to an AC outlet and the scanner. The display should light and cycle if you repeatedly press <b>[VOL]</b>
		If there is a wall switch that controls power to the AC outlet where you connected the AC adapter, make sure it is on.
Improper reception.	The antenna might need to be adjusted.	Check the antenna connection or move or reposition the antenna.
		Move the scanner.
		You might be in a remote area that could require an optional multi-band antenna. Check with your dealer or local electronics store.
Scan won't stop.	The squelch might need to be adjusted.	Adjust the squelch threshold. See "Turning On the Scanner and Setting the Squelch" on Page 43.
	The antenna might need to be adjusted.	Check the antenna connection.
	One or more channels might be locked out.	Make sure the channels you want to scan are not locked out.
	The channel's frequency might not be stored in memory.	Make sure the channel's frequency is stored in the scanner's memory.
	The channel might not be active.	Wait for a transmission on the channel.

Problem	Possible Cause	Suggestion
Scan won't start.	You must press <b>[SCAN/SEARCH]</b> to scan.	Press <b>[SCAN/SEARCH]</b> .
	The squelch might need to be adjusted.	Adjust the squelch threshold. See "Turning On the Scanner and Setting the Squelch" on Page 43.
	One or more channels might be locked out.	Make sure the channels you want to scan are not locked out.
	The antenna might need to be adjusted.	Check the antenna connection.

If you experience difficulty while in TrunkTracker™ mode, try the following steps.

Problem	Possible Cause	Suggestion
Scanner won't track a trunked system.	The system might not be one your scanner can scan.	Change to another system and try scanning that system.
	The data frequency might be missing.	Enter the data frequency.
	The scanner might need to be changed to a Type 1 scanner setup.	Change to a Type 1 scanner setup. See the programming instructions on the web at <a href="http://www.butelsoftware.com">www.butelsoftware.com</a> .
	The system you are trying to scan might be LTR or EDACS.	Set the scanner to scan LTR or EDACS systems. See the programming instructions on the web at <a href="http://www.butelsoftware.com">www.butelsoftware.com</a> .
	No ID's have been programmed.	Program one or more ID's or use the ID Search mode.
	The ID's you have stored are not active.	Wait for the ID's to become active or scan another system.
Scanner won't acquire the data channel.	The squelch might need to be adjusted.	Adjust the squelch threshold. See "Turning On the Scanner and Setting the Squelch" on Page 43.
	The frequency used for the data channel might be missing.	Check your frequency list for the data channel.

Problem	Possible Cause	Suggestion
Missing replies to conversations.	The scanner might need to be changed to a Type 1 scanner setup.	Change to a Type 1 scanner setup. See the programming instructions on the web at <a href="http://www.butelsoftware.com">www.butelsoftware.com</a> .
	The fleet map might be incorrect.	Try another preset fleet map or program your own fleet map.
	One or more of the system's frequencies might not be entered.	Make sure all the system's frequencies have been entered.
	The system you are trying to scan might be LTR or EDACS.	Set the scanner to scan LTR or EDACS systems. See the programming instructions on the web at <a href="http://www.butelsoftware.com">www.butelsoftware.com</a> .

## Other Specifications

ANT. Jack	BNC Type
Phone Jack	3.5mm (Stereo Type)
Ext. SP Jack	3.5mm (mono Type)
REC. Output Jack	3.5mm (Stereo Type)
DC Power Jack	5.5mm (Center Positive)
Remote Interface Jack	4pin Mini Type
GPS Interface Jack	D-sub 9 pin (Male Wire)
Ext. DC Power and ORG Wire Jack	3 pin (Center Orange Wire)
Internal Speaker	8 ohm, 5 W Max. (77 Φ)
Power Requirements	DC 11.0V ~ 16.6V (Ext. DC Power Jack or DC Power Jack)
Operating Temperature	-20°C ~ +60°C
Storage Temperature	-30°C ~ +70°C
Size (mm)	(W)184 x (D) 151 x (H) 56
Weight	1.57kg

## Other Specifications

# Reference

## Preset Fleet Maps

**Note:** Size Codes in parenthesis indicates that the Size Code spans more than one block.

Preset Map 1

Block	Size Code
0	Size Code 11
1	Size Code 11
2	Size Code 11
3	Size Code 11
4	Size Code 11
5	Size Code 11
6	Size Code 11
7	Size Code 11

Preset Map 2

Block	Size Code
0	Size Code 4
1	Size Code 4
2	Size Code 4
3	Size Code 4
4	Size Code 4
5	Size Code 4
6	Size Code 4
7	Size Code 4

Preset Map 3

Block	Size Code
0	Size Code 4
1	Size Code 4
2	Size Code 4
3	Size Code 4
4	Size Code 4
5	Size Code 4
6	Size Code 12
7	(Size Code 12)

Preset Map 4

Block	Size Code
0	Size Code 12
1	(Size Code 12)
2	Size Code 4
3	Size Code 4
4	Size Code 4
5	Size Code 4
6	Size Code 4
7	Size Code 4

Preset Map 5

Block	Size Code
0	Size Code 4
1	Size Code 4
2	Size Code 12
3	(Size Code 12)
4	Size Code 4
5	Size Code 4
6	Size Code 4
7	Size Code 4

Preset Map 6

Block	Size Code
0	Size Code 3
1	Size Code 10
2	Size Code 4
3	Size Code 4
4	Size Code 12
5	(Size Code 12)
6	Size Code 12
7	(Size Code 12)



Preset Map 7

Block	Size Code
0	Size Code 10
1	Size Code 10
2	Size Code 11
3	Size Code 4
4	Size Code 4
5	Size Code 4
6	Size Code 4
7	Size Code 4

Preset Map 8

Block	Size Code
0	Size Code 1
1	Size Code 1
2	Size Code 2
3	Size Code 2
4	Size Code 3
5	Size Code 3
6	Size Code 4
7	Size Code 4

Preset Map 9

Block	Size Code
0	Size Code 4
1	Size Code 4
2	Size Code 0
3	Size Code 0
4	Size Code 0
5	Size Code 0
6	Size Code 0
7	Size Code 0

Preset Map 10

Block	Size Code
0	Size Code 0
1	Size Code 0
2	Size Code 0
3	Size Code 0
4	Size Code 0
5	Size Code 0
6	Size Code 4
7	Size Code 4

Preset Map 11

Block	Size Code
0	Size Code 4
1	Size Code 0
2	Size Code 0
3	Size Code 0
4	Size Code 0
5	Size Code 0
6	Size Code 0
7	Size Code 0

Preset Map 12

Block	Size Code
0	Size Code 0
1	Size Code 0
2	Size Code 0
3	Size Code 0
4	Size Code 0
5	Size Code 0
6	Size Code 0
7	Size Code 4

Preset Map 13

Block	Size Code
0	Size Code 3
1	Size Code 3
2	Size Code 11
3	Size Code 4
4	Size Code 4
5	Size Code 0
6	Size Code 0
7	Size Code 0

Preset Map 14

Block	Size Code
0	Size Code 4
1	Size Code 3
2	Size Code 10
3	Size Code 4
4	Size Code 4
5	Size Code 4
6	Size Code 12
7	(Size Code 12)

Reference

Preset Map 15

Block	Size Code
0	Size Code 4
1	Size Code 4
2	Size Code 4
3	Size Code 11
4	Size Code 11
5	Size Code 0
6	Size Code 12
7	(Size Code 12)

Preset Map 16

Block	Size Code
0	Size Code 3
1	Size Code 10
2	Size Code 10
3	Size Code 11
4	Size Code 0
5	Size Code 0
6	Size Code 12
7	(Size Code 12)

## User Defined Fleet Maps

### *Type I Programming Information*

When a Type I system is designed, the address information for all the ID's is divided into 8 equal sized blocks, numbered 0–7. When you program your scanner to track a Type I system, you must select a size code for each of these blocks. When you have assigned a size code to all 8 blocks, you'll have defined the fleet map for the system you are tracking. Each size code determines the number of fleets, subfleets, and ID's each block will have. For example, a size code of S-4 has one fleet, which is divided into 16 separate subfleets, and it has a total of 512 individual ID's.

When a block is assigned a size code, the fleet or fleets created within the block are assigned a Type I ID. The way these ID's display on your scanner depend on the block number and the block's size code. When a Type I ID appears, the leftmost digit represents the block which contains the ID.

The next 2-3 digits identify which fleet is active, and the last digit(s) identifies the subfleet.

The details concerning how the size codes are selected by a Type I System designer are highly dependent on the specific needs of the system's users. Some organizations might want many subfleets with only a few radios each, while another organization might want only a few subfleets with many radios each. Your task is to program your fleet map with the same size code assignments as the trunked system. If you do this accurately, you'll track all the Fleet-Subfleet combinations used by the system. In other words, you'll hear complete communications while monitoring a trunked system.

If you don't already know the size codes used, you'll have to guess at them. But since you don't have to figure out all the blocks at once, this isn't as hard as it

seems. Select a size code for a block, and then press **Scan**. Now listen to the communications. If you decide you are receiving most of the replies to the conversations with ID's assigned to the block you just programmed, then you've probably selected the right size code and can work on the next block of the map.

Finally, for most public safety systems there are some size codes which are more common. S-3 and S-4 are probably the most common, followed by S-10, S-11, and S-12.

### ***Size Code Restrictions***

If you select size code S-12, S-13, or S-14, there are some restrictions as to which blocks can be used for these codes.

- S-12 can only be assigned to Blocks 0, 2, 4, or 6.
- S-13 can only be assigned to Blocks 0 and 4.
- S-14 can only be assigned to Block 0.

Since these size codes require multiple blocks, you will be prompted for the next available block when programming a fleet map. For example, if you assign Block 0 as an S-12, you will be prompted for b2, the next block available, instead of b1. And if you assign Block 0 as an S-14, you would not see another prompt because it uses all available blocks.

### **Reference**

### CTCSS Frequencies

67.0	69.3	71.9	74.4	77.0	79.7
82.5	85.4	88.5	91.5	94.8	97.4
100.0	103.5	107.2	110.9	114.8	118.8
123.0	127.3	131.8	136.5	141.3	146.2
151.4	156.7	159.8	162.2	165.5	167.9
171.3	173.8	177.3	179.9	183.5	186.2
189.9	192.8	196.6	199.5	203.5	206.5
210.7	218.1	225.7	229.1	233.6	241.8
250.3	254.1				

### DCS Codes

023	025	026	031	032	036	043	047
051	053	054	065	071	072	073	074
114	115	116	122	125	131	132	134
143	145	152	155	156	162	165	172
174	205	212	223	225	226	243	244
245	246	251	252	255	261	263	265
266	271	274	306	311	315	325	331
332	343	346	351	356	364	365	371
411	412	413	423	431	432	445	446
452	454	455	462	464	465	466	503
506	516	523	526	532	546	565	606
612	624	627	631	632	654	662	664
703	712	723	731	732	734	743	754

## Appendix

### SERVICE SEARCH RANGES

The modulation for the service search frequencies depends on selected band plan except for the CB FM Radio and CB AM Radio service search.

#### *Air*

108.000 MHz to 136.9875 MHz (12.5 KHz STEP)

or

108.000 MHz to 136.9916 MHz (8.33 KHz STEP)

#### *Marine*

90 frequencies. The unit of frequencies is MHz.

The "CH No." shows Marine channel numbers.

No.	CH No.	Frequency
1	1T	156.0500
2	1R	160.6500
3	2T	156.1000
4	2R	160.7000
5	3T	156.1500
6	3R	160.7500
7	4T	156.2000
8	4R	160.8000
9	5T	156.2500
10	5R	160.8500
11	6	156.3000
12	7T	156.3500
13	7R	160.9500
14	8	156.4000
15	9	156.4500
16	10	156.5000
17	11	156.5500
18	12	156.6000

19	13	156.6500
20	14	156.7000
21	15	156.7500
22	16	156.8000
23	17	156.8500
24	18T	156.9000
25	18R	161.5000
26	19T	156.9500
27	19R	161.5500
28	20T	157.0000
29	20R	161.6000
30	21T	157.0500
31	21R	161.6500
32	22T	157.1000
33	22R	161.7000
34	23T	157.1500
35	23R	161.7500
36	24T	157.2000
37	24R	161.8000

38	25T	157.2500
39	25R	161.8500
40	26T	157.3000
41	26R	161.9000
42	27T	157.3500
43	27R	161.9500
44	28T	157.4000
45	28R	162.0000
46	60T	156.0250
47	60R	160.6250
48	61T	156.0750
49	61R	160.6750
50	62T	156.1250
51	62R	160.7250
52	63T	156.1750
53	63R	160.7750
54	64T	156.2250
55	64R	160.8250
56	65T	156.2750

57	65R	160.8750
58	66T	156.3250
59	66R	160.9250
60	67	156.3750
61	68	156.4250
62	69	156.4750
63	70	156.5250
64	71	156.5750
65	72	156.6250
66	73	156.6750
67	74	156.7250
68	75	156.7750

69	76	156.8250
70	77	156.8750
71	78T	156.9250
72	78R	161.5250
73	79T	156.9750
74	79R	161.5750
75	80T	157.0250
76	80R	161.6250
77	81T	157.0750
78	81R	161.6750
79	82T	157.1250
80	82R	161.7250

81	83T	157.1750
82	83R	161.7750
83	84T	157.2250
84	84R	161.8250
85	85T	157.2750
86	85R	161.8750
87	86T	157.3250
88	86R	161.9250
89	87	157.3750
90	88	157.4250

### CB AM Radio

520 frequencies. The unit of frequencies is MHz.

The "CH No." shows CB AM Radio channel numbers.

#### Band A

CH No.	Frequency
1a	26.9650
2a	26.9750
3a	26.9850
4a	27.0050
5a	27.0150
6a	27.0250
7a	27.0350
8a	27.0550
9a	27.0650
10a	27.0750
11a	27.0850
12a	27.1050
13a	27.1150
14a	27.1250
15a	27.1350

16a	27.1550
17a	27.1650
18a	27.1750
19a	27.1850
20a	27.2050
21a	27.2150
22a	27.2250
23a	27.2550
24a	27.2350
25a	27.2450
26a	27.2650
27a	27.2750
28a	27.2850
29a	27.2950
30a	27.3050
31a	27.3150

32a	27.3250
33a	27.3350
34a	27.3450
35a	27.3550
36a	27.3650
37a	27.3750
38a	27.3850
39a	27.3950
40a	27.4050

#### Band B

CH No.	Frequency
1b	27.4150
2b	27.4250
3b	27.4350
4b	27.4550
5b	27.4650

6b	27.4750
7b	27.4850
8b	27.5050
9b	27.5150
10b	27.5250
11b	27.5350
12b	27.5550
13b	27.5650
14b	27.5750
15b	27.5850
16b	27.6050
17b	27.6150
18b	27.6250
19b	27.6350
20b	27.6550
21b	27.6650
22b	27.6750
23b	27.7050
24b	27.6850
25b	27.6950
26b	27.7150
27b	27.7250
28b	27.7350
29b	27.7450
30b	27.7550
31b	27.7650
32b	27.7750
33b	27.7850
34b	27.7950
35b	27.8050
36b	27.8150
37b	27.8250
38b	27.8350
39b	27.8450
40b	27.8550

**Band C**

CH No.	Frequency
1c	26.5150
2c	26.5250
3c	26.5350
4c	26.5550
5c	26.5650
6c	26.5750
7c	26.5850
8c	26.6050
9c	26.6150
10c	26.6250
11c	26.6350
12c	26.6550
13c	26.6650
14c	26.6750
15c	26.6850
16c	26.7050
17c	26.7150
18c	26.7250
19c	26.7350
20c	26.7550
21c	26.7650
22c	26.7750
23c	26.8050
24c	26.7850
25c	26.7950
26c	26.8150
27c	26.8250
28c	26.8350
29c	26.8450
30c	26.8550
31c	26.8650
32c	26.8750
33c	26.8850

34c	26.8950
35c	26.9050
36c	26.9150
37c	26.9250
38c	26.9350
39c	26.9450
40c	26.9550

**Band D**

CH No.	Frequency
1d	27.8650
2d	27.8750
3d	27.8850
4d	27.9050
5d	27.9150
6d	27.9250
7d	27.9350
8d	27.9550
9d	27.9650
10d	27.9750
11d	27.9850
12d	28.0050
13d	28.0150
14d	28.0250
15d	28.0350
16d	28.0550
17d	28.0650
18d	28.0750
19d	28.0850
20d	28.1050
21d	28.1150
22d	28.1250
23d	28.1550
24d	28.1350
25d	28.1450
26d	28.1650

**Appendix**

27d	28.1750
28d	28.1850
29d	28.1950
30d	28.2050
31d	28.2150
32d	28.2250
33d	28.2350
34d	28.2450
35d	28.2550
36d	28.2650
37d	28.2750
38d	28.2850
39d	28.2950
40d	28.3050

**Band E**

CH No.	Frequency
1e	26.0650
2e	26.0750
3e	26.0850
4e	26.1050
5e	26.1150
6e	26.1250
7e	26.1350
8e	26.1550
9e	26.1650
10e	26.1750
11e	26.1850
12e	26.2050
13e	26.2150
14e	26.2250
15e	26.2350
16e	26.2550
17e	26.2650
18e	26.2750
19e	26.2850

20e	26.3050
21e	26.3150
22e	26.3250
23e	26.3550
24e	26.3350
25e	26.3450
26e	26.3650
27e	26.3750
28e	26.3850
29e	26.3950
30e	26.4050
31e	26.4150
32e	26.4250
33e	26.4350
34e	26.4450
35e	26.4550
36e	26.4650
37e	26.4750
38e	26.4850
39e	26.4950
40e	26.5050

**Band F**

CH No.	Frequency
1f	28.3150
2f	28.3250
3f	28.3350
4f	28.3550
5f	28.3650
6f	28.3750
7f	28.3850
8f	28.4050
9f	28.4150
10f	28.4250
11f	28.4350
12f	28.4550

13f	28.4650
14f	28.4750
15f	28.4850
16f	28.5050
17f	28.5150
18f	28.5250
19f	28.5350
20f	28.5550
21f	28.5650
22f	28.5750
23f	28.6050
24f	28.5850
25f	28.5950
26f	28.6150
27f	28.6250
28f	28.6350
29f	28.6450
30f	28.6550
31f	28.6650
32f	28.6750
33f	28.6850
34f	28.6950
35f	28.7050
36f	28.7150
37f	28.7250
38f	28.7350
39f	28.7450
40f	28.7550

**Band G**

CH No.	Frequency
1g	25.6150
2g	25.6250
3g	25.6350
4g	25.6550
5g	25.6650



6g	25.6750
7g	25.6850
8g	25.7050
9g	25.7150
10g	25.7250
11g	25.7350
12g	25.7550
13g	25.7650
14g	25.7750
15g	25.7850
16g	25.8050
17g	25.8150
18g	25.8250
19g	25.8350
20g	25.8550
21g	25.8650
22g	25.8750
23g	25.9050
24g	25.8850
25g	25.8950
26g	25.9150
27g	25.9250
28g	25.9350
29g	25.9450
30g	25.9550
31g	25.9650
32g	25.9750
33g	25.9850
34g	25.9950
35g	26.0050
36g	26.0150
37g	26.0250
38g	26.0350
39g	26.0450
40g	26.0550

**Band H**

CH No.	Frequency
1h	28.7650
2h	28.7750
3h	28.7850
4h	28.8050
5h	28.8150
6h	28.8250
7h	28.8350
8h	28.8550
9h	28.8650
10h	28.8750
11h	28.8850
12h	28.9050
13h	28.9150
14h	28.9250
15h	28.9350
16h	28.9550
17h	28.9650
18h	28.9750
19h	28.9850
20h	29.0050
21h	29.0150
22h	29.0250
23h	29.0550
24h	29.0350
25h	29.0450
26h	29.0650
27h	29.0750
28h	29.0850
29h	29.0950
30h	29.1050
31h	29.1150
32h	29.1250
33h	29.1350

34h	29.1450
35h	29.1550
36h	29.1650
37h	29.1750
38h	29.1850
39h	29.1950
40h	29.2050

**Band I**

CH No.	Frequency
1i	29.2150
2i	29.2250
3i	29.2350
4i	29.2550
5i	29.2650
6i	29.2750
7i	29.2850
8i	29.3050
9i	29.3150
10i	29.3250
11i	29.3350
12i	29.3550
13i	29.3650
14i	29.3750
15i	29.3850
16i	29.4050
17i	29.4150
18i	29.4250
19i	29.4350
20i	29.4550
21i	29.4650
22i	29.4750
23i	29.5050
24i	29.4850
25i	29.4950
26i	29.5150

**Appendix**

27i	29.5250
28i	29.5350
29i	29.5450
30i	29.5550
31i	29.5650
32i	29.5750
33i	29.5850
34i	29.5950
35i	29.6050
36i	29.6150
37i	29.6250
38i	29.6350
39i	29.6450
40i	29.6550

**Band J**

CH No.	Frequency
1j	29.6650
2j	29.6750
3j	29.6850
4j	29.7050
5j	29.7150
6j	29.7250
7j	29.7350
8j	29.7550
9j	29.7650
10j	29.7750
11j	29.7850
12j	29.8050
13j	29.8150
14j	29.8250
15j	29.8350
16j	29.8550
17j	29.8650
18j	29.8750
19j	29.8850

20j	29.9050
21j	29.9150
22j	29.9250
23j	29.9550
24j	29.9350
25j	29.9450
26j	29.9650
27j	29.9750
28j	29.9850
29j	29.9950
30j	30.0050
31j	30.0150
32j	30.0250
33j	30.0350
34j	30.0450
35j	30.0550
36j	30.0650
37j	30.0750
38j	30.0850
39j	30.0950
40j	30.1050

**GERMANY**

CH No.	Frequency
41G	26.5650
42G	26.5750
43G	26.5850
44G	26.5950
45G	26.6050
46G	26.6150
47G	26.6250
48G	26.6350
49G	26.6450
50G	26.6550
51G	26.6650
52G	26.6750

53G	26.6850
54G	26.6950
55G	26.7050
56G	26.7150
57G	26.7250
58G	26.7350
59G	26.7450
60G	26.7550
61G	26.7650
62G	26.7750
63G	26.7850
64G	26.7950
65G	26.8050
66G	26.8150
67G	26.8250
68G	26.8350
69G	26.8450
70G	26.8550
71G	26.8650
72G	26.8750
73G	26.8850
74G	26.8950
75G	26.9050
76G	26.9150
77G	26.9250
78G	26.9350
79G	26.9450
80G	26.9550

**ENGLAND**

CH No.	Frequency
1E	27.60125
2E	27.61125
3E	27.62125
4E	27.63125
5E	27.64125

6E	27.65125
7E	27.66125
8E	27.67125
9E	27.68125
10E	27.69125
11E	27.70125
12E	27.71125
13E	27.72125
14E	27.73125
15E	27.74125
16E	27.75125
17E	27.76125
18E	27.77125
19E	27.78125
20E	27.79125
21E	27.80125
22E	27.81125
23E	27.82125
24E	27.83125
25E	27.84125
26E	27.85125
27E	27.86125
28E	27.87125
29E	27.88125
30E	27.89125
31E	27.90125
32E	27.91125
33E	27.92125
34E	27.93125
35E	27.94125
36E	27.95125
37E	27.96125
38E	27.97125
39E	27.98125
40E	27.99125

**POLAND**

CH No.	Frequency
1P	26.9600
2P	26.9700
3P	26.9800
4P	27.0000
5P	27.0100
6P	27.0200
7P	27.0300
8P	27.0500
9P	27.0600
10P	27.0700
11P	27.0800
12P	27.1000
13P	27.1100
14P	27.1200
15P	27.1300
16P	27.1500
17P	27.1600
18P	27.1700
19P	27.1800
20P	27.2000
21P	27.2100
22P	27.2200
23P	27.2500
24P	27.2300
25P	27.2400
26P	27.2600
27P	27.2700
28P	27.2800
29P	27.2900
30P	27.3000
31P	27.3100
32P	27.3200
33P	27.3300

34P	27.3400
35P	27.3500
36P	27.3600
37P	27.3700
38P	27.3800
39P	27.3900
40P	27.4000

**Appendix**

## CB FM Radio

520 frequencies. The unit of frequencies is MHz.

The "CH No." shows CB FM Radio channel numbers.

### Band A

CH No.	Frequency
1a	26.9650
2a	26.9750
3a	26.9850
4a	27.0050
5a	27.0150
6a	27.0250
7a	27.0350
8a	27.0550
9a	27.0650
10a	27.0750
11a	27.0850
12a	27.1050
13a	27.1150
14a	27.1250
15a	27.1350
16a	27.1550
17a	27.1650
18a	27.1750
19a	27.1850
20a	27.2050
21a	27.2150
22a	27.2250
23a	27.2550
24a	27.2350
25a	27.2450
26a	27.2650
27a	27.2750
28a	27.2850
29a	27.2950

30a	27.3050
31a	27.3150
32a	27.3250
33a	27.3350
34a	27.3450
35a	27.3550
36a	27.3650
37a	27.3750
38a	27.3850
39a	27.3950
40a	27.4050

### Band B

CH No.	Frequency
1b	27.4150
2b	27.4250
3b	27.4350
4b	27.4550
5b	27.4650
6b	27.4750
7b	27.4850
8b	27.5050
9b	27.5150
10b	27.5250
11b	27.5350
12b	27.5550
13b	27.5650
14b	27.5750
15b	27.5850
16b	27.6050
17b	27.6150

18b	27.6250
19b	27.6350
20b	27.6550
21b	27.6650
22b	27.6750
23b	27.7050
24b	27.6850
25b	27.6950
26b	27.7150
27b	27.7250
28b	27.7350
29b	27.7450
30b	27.7550
31b	27.7650
32b	27.7750
33b	27.7850
34b	27.7950
35b	27.8050
36b	27.8150
37b	27.8250
38b	27.8350
39b	27.8450
40b	27.8550

### Band C

CH No.	Frequency
1c	26.5150
2c	26.5250
3c	26.5350
4c	26.5550
5c	26.5650

6c	26.5750
7c	26.5850
8c	26.6050
9c	26.6150
10c	26.6250
11c	26.6350
12c	26.6550
13c	26.6650
14c	26.6750
15c	26.6850
16c	26.7050
17c	26.7150
18c	26.7250
19c	26.7350
20c	26.7550
21c	26.7650
22c	26.7750
23c	26.8050
24c	26.7850
25c	26.7950
26c	26.8150
27c	26.8250
28c	26.8350
29c	26.8450
30c	26.8550
31c	26.8650
32c	26.8750
33c	26.8850
34c	26.8950
35c	26.9050
36c	26.9150
37c	26.9250
38c	26.9350
39c	26.9450
40c	26.9550

**Band D**

CH No.	Frequency
1d	27.8650
2d	27.8750
3d	27.8850
4d	27.9050
5d	27.9150
6d	27.9250
7d	27.9350
8d	27.9550
9d	27.9650
10d	27.9750
11d	27.9850
12d	28.0050
13d	28.0150
14d	28.0250
15d	28.0350
16d	28.0550
17d	28.0650
18d	28.0750
19d	28.0850
20d	28.1050
21d	28.1150
22d	28.1250
23d	28.1550
24d	28.1350
25d	28.1450
26d	28.1650
27d	28.1750
28d	28.1850
29d	28.1950
30d	28.2050
31d	28.2150
32d	28.2250
33d	28.2350

34d	28.2450
35d	28.2550
36d	28.2650
37d	28.2750
38d	28.2850
39d	28.2950
40d	28.3050

**Band E**

CH No.	Frequency
1e	26.0650
2e	26.0750
3e	26.0850
4e	26.1050
5e	26.1150
6e	26.1250
7e	26.1350
8e	26.1550
9e	26.1650
10e	26.1750
11e	26.1850
12e	26.2050
13e	26.2150
14e	26.2250
15e	26.2350
16e	26.2550
17e	26.2650
18e	26.2750
19e	26.2850
20e	26.3050
21e	26.3150
22e	26.3250
23e	26.3550
24e	26.3350
25e	26.3450
26e	26.3650

**Appendix**

27e	26.3750
28e	26.3850
29e	26.3950
30e	26.4050
31e	26.4150
32e	26.4250
33e	26.4350
34e	26.4450
35e	26.4550
36e	26.4650
37e	26.4750
38e	26.4850
39e	26.4950
40e	26.5050

**Band F**

CH No.	Frequency
1f	28.3150
2f	28.3250
3f	28.3350
4f	28.3550
5f	28.3650
6f	28.3750
7f	28.3850
8f	28.4050
9f	28.4150
10f	28.4250
11f	28.4350
12f	28.4550
13f	28.4650
14f	28.4750
15f	28.4850
16f	28.5050
17f	28.5150
18f	28.5250
19f	28.5350

20f	28.5550
21f	28.5650
22f	28.5750
23f	28.6050
24f	28.5850
25f	28.5950
26f	28.6150
27f	28.6250
28f	28.6350
29f	28.6450
30f	28.6550
31f	28.6650
32f	28.6750
33f	28.6850
34f	28.6950
35f	28.7050
36f	28.7150
37f	28.7250
38f	28.7350
39f	28.7450
40f	28.7550

**Band G**

CH No.	Frequency
1g	25.6150
2g	25.6250
3g	25.6350
4g	25.6550
5g	25.6650
6g	25.6750
7g	25.6850
8g	25.7050
9g	25.7150
10g	25.7250
11g	25.7350
12g	25.7550

13g	25.7650
14g	25.7750
15g	25.7850
16g	25.8050
17g	25.8150
18g	25.8250
19g	25.8350
20g	25.8550
21g	25.8650
22g	25.8750
23g	25.9050
24g	25.8850
25g	25.8950
26g	25.9150
27g	25.9250
28g	25.9350
29g	25.9450
30g	25.9550
31g	25.9650
32g	25.9750
33g	25.9850
34g	25.9950
35g	26.0050
36g	26.0150
37g	26.0250
38g	26.0350
39g	26.0450
40g	26.0550

**Band H**

CH No.	Frequency
1h	28.7650
2h	28.7750
3h	28.7850
4h	28.8050
5h	28.8150

6h	28.8250
7h	28.8350
8h	28.8550
9h	28.8650
10h	28.8750
11h	28.8850
12h	28.9050
13h	28.9150
14h	28.9250
15h	28.9350
16h	28.9550
17h	28.9650
18h	28.9750
19h	28.9850
20h	29.0050
21h	29.0150
22h	29.0250
23h	29.0550
24h	29.0350
25h	29.0450
26h	29.0650
27h	29.0750
28h	29.0850
29h	29.0950
30h	29.1050
31h	29.1150
32h	29.1250
33h	29.1350
34h	29.1450
35h	29.1550
36h	29.1650
37h	29.1750
38h	29.1850
39h	29.1950
40h	29.2050

**Band I**

CH No.	Frequency
1i	29.2150
2i	29.2250
3i	29.2350
4i	29.2550
5i	29.2650
6i	29.2750
7i	29.2850
8i	29.3050
9i	29.3150
10i	29.3250
11i	29.3350
12i	29.3550
13i	29.3650
14i	29.3750
15i	29.3850
16i	29.4050
17i	29.4150
18i	29.4250
19i	29.4350
20i	29.4550
21i	29.4650
22i	29.4750
23i	29.5050
24i	29.4850
25i	29.4950
26i	29.5150
27i	29.5250
28i	29.5350
29i	29.5450
30i	29.5550
31i	29.5650
32i	29.5750
33i	29.5850

34i	29.5950
35i	29.6050
36i	29.6150
37i	29.6250
38i	29.6350
39i	29.6450
40i	29.6550

**Band J**

CH No.	Frequency
1j	29.6650
2j	29.6750
3j	29.6850
4j	29.7050
5j	29.7150
6j	29.7250
7j	29.7350
8j	29.7550
9j	29.7650
10j	29.7750
11j	29.7850
12j	29.8050
13j	29.8150
14j	29.8250
15j	29.8350
16j	29.8550
17j	29.8650
18j	29.8750
19j	29.8850
20j	29.9050
21j	29.9150
22j	29.9250
23j	29.9550
24j	29.9350
25j	29.9450
26j	29.9650

**Appendix**

27j	29.9750
28j	29.9850
29j	29.9950
30j	30.0050
31j	30.0150
32j	30.0250
33j	30.0350
34j	30.0450
35j	30.0550
36j	30.0650
37j	30.0750
38j	30.0850
39j	30.0950
40j	30.1050

**GERMANY**

CH No.	Frequency
41G	26.5650
42G	26.5750
43G	26.5850
44G	26.5950
45G	26.6050
46G	26.6150
47G	26.6250
48G	26.6350
49G	26.6450
50G	26.6550
51G	26.6650
52G	26.6750
53G	26.6850
54G	26.6950
55G	26.7050
56G	26.7150
57G	26.7250
58G	26.7350
59G	26.7450

60G	26.7550
61G	26.7650
62G	26.7750
63G	26.7850
64G	26.7950
65G	26.8050
66G	26.8150
67G	26.8250
68G	26.8350
69G	26.8450
70G	26.8550
71G	26.8650
72G	26.8750
73G	26.8850
74G	26.8950
75G	26.9050
76G	26.9150
77G	26.9250
78G	26.9350
79G	26.9450
80G	26.9550

**ENGLAND**

CH No.	Frequency
1E	27.60125
2E	27.61125
3E	27.62125
4E	27.63125
5E	27.64125
6E	27.65125
7E	27.66125
8E	27.67125
9E	27.68125
10E	27.69125
11E	27.70125
12E	27.71125

13E	27.72125
14E	27.73125
15E	27.74125
16E	27.75125
17E	27.76125
18E	27.77125
19E	27.78125
20E	27.79125
21E	27.80125
22E	27.81125
23E	27.82125
24E	27.83125
25E	27.84125
26E	27.85125
27E	27.86125
28E	27.87125
29E	27.88125
30E	27.89125
31E	27.90125
32E	27.91125
33E	27.92125
34E	27.93125
35E	27.94125
36E	27.95125
37E	27.96125
38E	27.97125
39E	27.98125
40E	27.99125

**POLAND**

CH No.	Frequency
1P	26.9600
2P	26.9700
3P	26.9800
4P	27.0000
5P	27.0100



6P	27.0200
7P	27.0300
8P	27.0500
9P	27.0600
10P	27.0700
11P	27.0800
12P	27.1000
13P	27.1100
14P	27.1200
15P	27.1300
16P	27.1500
17P	27.1600

18P	27.1700
19P	27.1800
20P	27.2000
21P	27.2100
22P	27.2200
23P	27.2500
24P	27.2300
25P	27.2400
26P	27.2600
27P	27.2700
28P	27.2800
29P	27.2900

30P	27.3000
31P	27.3100
32P	27.3200
33P	27.3300
34P	27.3400
35P	27.3500
36P	27.3600
37P	27.3700
38P	27.3800
39P	27.3900
40P	27.4000

**PMR**

8 frequencies. The unit of frequencies is MHz.

The "CH No" shows PMR channel numbers.

CH No.	Frequency
1	446.00625
2	446.01875
3	446.03125
4	446.04375
5	446.05625
6	446.06875
7	446.08125
8	446.09375

**Appendix**

**LPD**

69 frequencies. The unit of frequencies is MHz.

The "CH No." shows LPD channel numbers.

CH No.	Frequency				
1	433.075	31	433.825	62	434.600
2	433.100	32	433.850	63	434.625
3	433.125	33	433.875	64	434.650
4	433.150	34	433.900	65	434.675
5	433.175	35	433.925	66	434.700
6	433.200	36	433.950	67	434.725
7	433.225	37	433.975	68	434.750
8	433.250	38	434.000	69	434.775
9	433.275	39	434.025		
10	433.300	40	434.050		
11	433.325	41	434.075		
12	433.350	42	434.100		
13	433.375	43	434.125		
14	433.400	44	434.150		
15	433.425	45	434.175		
16	433.450	46	434.200		
17	433.475	47	434.225		
18	433.500	48	434.250		
19	433.525	49	434.275		
20	433.550	50	434.300		
21	433.575	51	434.325		
22	433.600	52	434.350		
23	433.625	53	434.375		
24	433.650	54	434.400		
25	433.675	55	434.425		
26	433.700	56	434.450		
27	433.725	57	434.475		
28	433.750	58	434.500		
29	433.775	59	434.525		
30	433.800	60	434.550		
		61	434.575		

## Index

### A

- Alert 68
  - Channel 14
  - Custom 14
  - Dangerous Xing-Road 112
  - Duplicate Frequency 14
  - Emergency 68
  - GPS 15
  - Setting Channel 83
- Antenna 29, 31, 35
- Attenuation 42, 74, 82, 101
- Attenuator 14, 91
- Auto Store 16, 92, 95, 100

### B

- Backlight 15, 51
- backlight 33
- Band Plan 75
- Beep 24
  - Alert 69, 112
  - Close Call 95
  - Key 52
- Birdies 14, 115
- Broadcast Screen 99

### C

- Channel
  - Add CTCSS/DCS 81
  - Alert 14
  - All 31
  - Attenuation 82
  - Control 15, 23, 24
  - Control Mode 76
  - Copying 84
  - Creating 79
  - CTCSS/DCS 16
  - Delay 66
  - Delete 79
  - Deleting 85

- Display Mode 49
- Editing 70
- Found, Saving 92
- Group 16, 19
- Group Name 42
- Holding 47
- Lock/Unlock 46, 78
- Lockout 13
- Logical Number 24
- Logical Numbers 24
- Marked 31
- Memory 13
- Modulation 82
- Priority 83
- Programming 77
- Single Autonomous 25
- Step 14
- System 45
- Tone-Out 107
- Close Call
  - DND 95
  - Feature 13
  - Hits 96
  - Hits with Scan 97
  - Options 98
  - Setting 94
  - Using 94
- Contrast 52
- Conventional
  - Auto Store 16
  - Feature 15
  - Programming 62
  - Scanning 21
  - Search and Store 92
  - Startup Options 43
- Copy
  - Channels 85
  - Systems 71
- CTCSS

Display Indicator 42  
Frequencies 124  
Quick Save 81  
Selecting 81  
What is 20

**D**

**Dangerous**

Deleting Location 112  
Option Setting 111  
Review Mode 113  
Road 109  
Screens 114  
Xing 109

**Dangerous Xing, Road  
Settings 112**

**Data**

Alpha 92  
Channel 49  
Download 55  
GPS 54  
LCN 24  
Programming 16  
SCAT 25  
Setting Skip 101  
Skip 14, 66  
Talk Group 24  
Transfer 56

Dimmer 15, 33, 51  
DIN-E 13, 29, 32, 34

**E**

**Edit**

Channel Data 40  
Menu 41  
System Name 63  
Tone Out 40

**Editing**

Band Plan 75  
Channel Groups 70  
Channel Name 79  
Channels 78

Custom Search Range 88  
Frequencies 80  
Service Search 90  
Sites 70  
System Quick Key 64  
Talk Group ID 80

End Code 68

**F**

Fleet 24, 25, 67, 120, 122

**G**

**GPS**

Compatible 108  
Connecting 108  
Distance Units 54  
Features 15  
Initial Operation 108  
Location Based Scanning 109  
Location Information 67  
Non-Location Based 109  
Position Format 53  
Saving Longitude/Latitude 92  
Setting Format 53  
Time Format 53  
Time Zone 53  
Using the Scanner 108

**I**

**I-Call**

Feature 26  
Operations 68

ID Scan 46, 66

Indicators 45, 48

indicators 42

ISO 13, 29, 34, 35

**L**

**Lockout**

Channel Groups 78  
Custom Search Range 90  
Search Limits 17

Setting 84  
Sites 74, 109  
Systems 65

**LTR**

Display 78  
ID 25  
LCN 73  
Scan Time 75  
Site Limit 71  
Trunking 25

**M**

**Menu 17**

Entering Text 18  
To Use 18  
Using 50

**Motorola**

Band Plan 75  
Control Channel 76  
Edit System Names 63  
Emergency Alert Options 68  
End Code 68  
Fleet Maps 67  
I-Call 26  
Status Bit 67  
Trunking 23  
Types 24

Multi-Site 15, 26

**P**

**POI**

Display 114  
Distance 54  
Location, Range 109  
Lock, Unlock 114  
Only For 112  
Setting 111

Port 54

port 56

preprogrammed 15, 86

Preset

Edit Maps 67

Fleet Maps 120  
Search Ranges 88

**R**

**Range**

All 112  
Display 114  
Edit 88  
GPS 15  
Search 20, 43, 87, 91  
Set 67

**S**

**Scan**

Close Call Hits 97  
Control Channel Only 15  
Conventional 21  
Function 18  
ID 46  
Priority 16, 103  
Search Delay 14  
Search With 14, 90  
Selecting Systems 45  
Systems 44  
Trunked 23  
Understanding 19  
What is 20

SCAT 15, 24, 25, 71, 75, 78, 93

**Search**

Assigning a Range to Search Key  
91  
Auto and Store 92  
Close Call Options 98  
Conventional 92  
Custom 87  
Edit a Service 90  
Edit Custom Range 88  
Feature 13, 15  
Frequency Step 102  
ID 46  
Lockout Limits 17  
Quick 87

**Index**

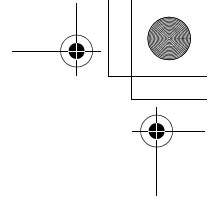
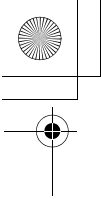

Range 43  
Reviewing ID Lockouts 70  
Scan Delay 14  
Service 86  
Store ID 47  
Trunked and Store 93  
What Is 20  
Squelch 13, 20, 43, 56  
Subfleet 24, 25  
subfleet 24, 122

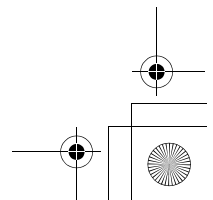
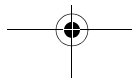
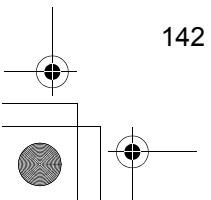
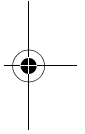
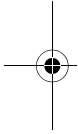

## Declaration of Conformity

Uniden Corporation  
2-12-7 Hatchobori  
Chuo-Ku, Tokyo 104-8512  
Japan

declare, under our sole responsibility, that this equipment "Uniden Bearcat model UBC800XLT" is in compliance with the essential requirements and other relevant provisions of the EMC, R&TTE and LVD Council Directives of the EU.

Declaration of Conformity

143

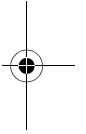
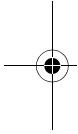
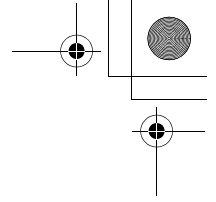
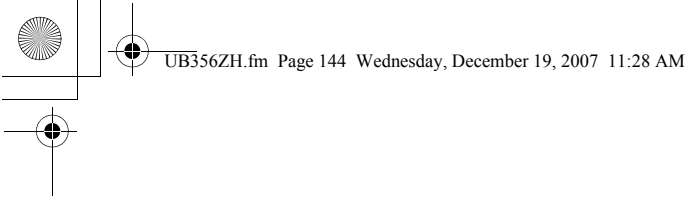

# Uniden®

© 2008 Uniden Corporation.  
UBZZ01356ZZ(0)

All rights reserved.  
Printed in P.R.C. 