

BAOFENG

<http://www.baofengradio.com/>



FC CE 06780 

BAOFENG

<http://www.baofengradio.com/>



User Manual



Two Way Radio

UV-5RX3



220
MHz



Table of Contents

Part I. Getting started

Chapter 1. - Initial setup	01
Safety Information	01
What's in the box	03
Available Accessories: https://www.radioddity.com/	04
Notice	04
Antenna	04
Belt clip	05
Battery	06
Charging and battery maintenance	07
Charging	07
Battery Maintenance	09
Chapter 2. - Getting to know your radio	10
The main display	12
Battery Level Indicator	14
Status LED	14



Side key 1 - CALL (Broadcast FM and Alarm)	14
Side key 2 - MONI (Monitor and Flashlight)	15
VFO /MR-mode key	15
A/B select key	15
Numeric keypad	16
Pound # Key	16
Star * Key	17
Menu and function keys	17
Accessory jack	18
Chapter 3. - Basic Use	19
Power and volume	19
Turning the unit on	19
Turning the unit off	20
Adjusting the volume	20
Making a call	20



Channel selection	21
Frequency (VFO) mode	21
Channel (MR) mode	24
Part II. Advanced topics	
Chapter 4. - Working the menu system	25
Basic use	25
Using short-cuts	26
Chapter 5. - Scanning	27
Scanning modes	27
Time operation	28
Carrier operation	28
Search operation	28
Scanning a Frequency Range (VFO Mode)	29
Scanning Your Selected Channels (Channel Mode)	29
Tone Scanning	30
Scanning for CTCSS and DCS Tones/Codes	31



Chapter 6. - Dual Watch	32
Chapter 7. - DTMF	34
Chapter 8. - Selective calling	36
CTCSS	37
DCS	38
1000Hz, 1450Hz, 1750Hz Tone-burst	39
Chapter 9. - Customization	40
Display	40
Power-on message	42
Chapter 10. - Programming	44
Manual programming	44
Simplex channels	45
Duplex channels	46
Computer programming	46



Part III. How-to and setup guides

Chapter 11. - Repeaters	48
Chapter 12. - Application Specific Setup	51
Commercial Radio Setup	51
Amateur Radio Setup	52
FRS, GMRS, MURS, PMR446	53
Appendix A. – Troubleshooting	53
Appendix B. - Menu definitions	54
Appendix C. - Technical specifications	62
General	62
Transmitter	63
Receiver	63
DCS table	64
CTCSS table	66



Chapter 1.-Initial setup

Safety Information

The following safety precautions should always be observed during operation, service and repair of this equipment.

- Qualified technicians shall service this equipment only.
- Do not tamper the radio for any reason.
- Use only Baofeng radio supplied or approved batteries and chargers.
- Do not use any portable radio with a damaged antenna. If a damaged antenna comes into contact with your skin, a minor burn can result.
- Turn off your radio prior when entering any area with explosive and flammable materials.
- Do not charge your battery in the area with explosive and flammable materials.
- To avoid electromagnetic interference and/or compatibility conflicts, please turn off your radio in any area where posted notices instruct you to do so

Part I Getting Started

Part one covers the basic setup and use of your hand-held two-way transceiver.

- CHAPTER 1 INITIAL SETUP
- CHAPTER 2 GETTING TO KNOW YOUR RADIO
- CHAPTER 3 BASIC USE

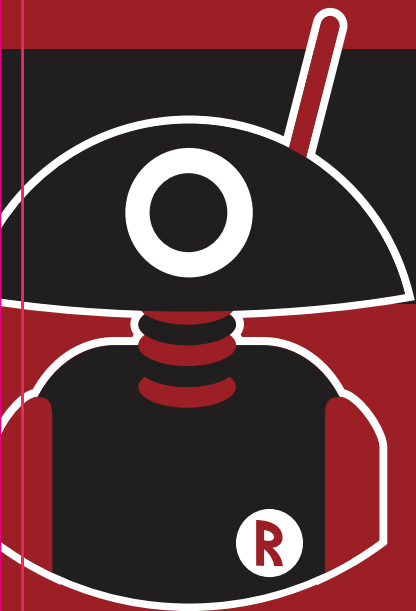



- Turn off your radio before boarding an aircraft; any use of a radio must be in accordance with airline regulations or crew instructions.
- Turn off your radio before entering a blasting area.
- Do not place a radio over an air bag area or in the air bag deployment area for vehicles with an air bag.
- Do not expose the radio under direct sunlight over a long time, nor place it close to heating source.
- When transmitting with a portable radio, hold the radio in a vertical position with the microphone 3 to 4 centimeters away from your lips; also make sure the antenna stays at least 2.5 centimeters away from your body when transmitting.

FIND TUTORIALS, SUPPORT AND MORE



Radioddity.com

  @Radioddity

 support@radioddity.com



What's in the box

This transceiver comes shipped with below items and accessories in the box:



Tri-band Radio

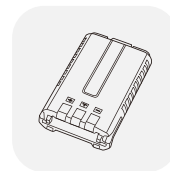

1800mAh Battery



Dual Band Antenna



220 MHz Single band Antenna

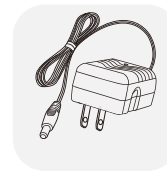

Adapter

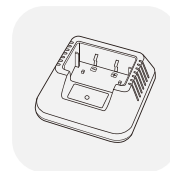

Desktop Charger



Earpiece Kit



Wrist Strap

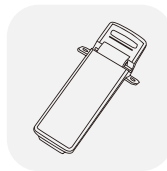

Belt Clip



User Manual

User manual



The radio is compatible with other accessories which are available on:

<https://www.radioddity.com/>

- BL-5 Battery eliminator
- BL-5 AA Battery Pack
- RD-201 Programming Cable
- Radioddity IP54 Speaker Mic
- Radioddity Tri-Band Antenna
- BL-5 1800mAh Battery
- BL-5L 2000mAh Battery
- BL-5L 3800mAh Battery

Notice

Please make sure to install the antenna and battery is charged when start using a radio.

Antenna

This transceiver is fitted with a Male SMA connector. To mount your antenna (Female SMA connector), align the two connectors and turn clockwise until it stops.



- Do not over-tighten your antenna to avoid damage to the outer materials and the connect base.
- When installing the antenna, please remember to grip it by the base and screw.
- When you choose using an external antenna, make sure its SWR is about 1.5:1 or lower to avoid damage to the transceiver.
- Do not hold the antenna with your hand or wrap the outside of it to avoid interference to the transceiver.
- Never transmitting without an antenna.

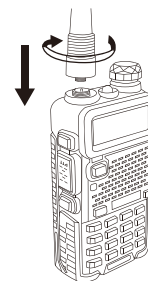

Belt clip

There are two parallel screws mounted on rear radio body, remove them and thread through the holes on the belt clip as you screw them back into the radio body.



Do not add any form of glue to fix the screws on the battery clip. The solvents in the glue may cause damage to the battery casing.

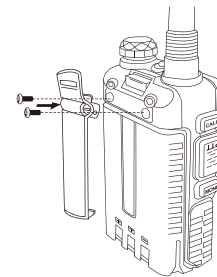



Battery

The radio must be powered off before attaching or removing the battery, you may rotate the power/volume knob all the way counter-clockwise to make sure it has been turned off.

Installation

Push the battery slowly in parallel with the radio body, the lower edge of the battery is about 1-2 cm below the radio's edge.

Once aligned with the guide-rails, slide the battery upward until you hear a click to lock the battery in place.

Removal

To remove the battery, press "PUSH" buckle on the middle top (see Figure 2. 1,"Baofeng UV-5RX3 Radio, overview"), as you slide the battery downward.

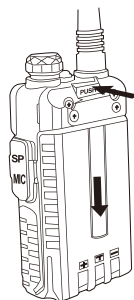
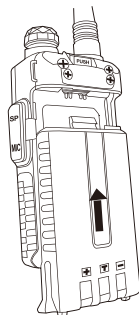

Charging and battery maintenance

Charging



Battery should be fully charged before initial use. Optimum battery efficiency will be achieved after the three full battery charge and discharge cycles.

How to hook up and use the charger correctly:

1. Plug the DC connector of the power adaptor into the charger base.
2. Plug the AC connector of the power adaptor into a main ac wall outlet.
3. Place the radio in the charging base.
4. Make sure the radio is making contact with the charger. When the red LED comes on steady, your radio is charging.
5. The radio is fully charged once the charger's green status LED goes steady. Please remove the radio at that time to avoid the over-charging.



Table 1.1. Charger LED codes

Red LED	Green LED	Status
Flashing	Steady	Standby (charger empty)
Steady	Off	Error (charger with radio)
Off	Steady	Charging
		Charge complete.

The charger and battery are fitted with matching notches so that the battery can be charged individually! That is very practical if you have two batteries, that you can charge one battery while still using your radio.



Battery Maintenance

The battery is provided without power from the factory; please let it charged for at least four to five hours before you start using your radio.



- Use only batteries approved by the original manufacturer.
- Never attempt to disassemble your battery pack.
- Do not expose your batteries to fire or intense heat
- Dispose of batteries in accordance with local recycling regulations.

Prolonging your battery's life

Only charging batteries in normal room temperatures.

- When charging a battery attached to the radio, power off the radio for a faster charge. Before the charging is completed, do not unplug the power to the charger or remove the battery.
- Never charge or use a wet battery.
- Batteries wear out over time. When the radio is operated in a shorter time, please consider purchasing a new battery to replace.
- Battery's performance will be reduced in temperatures below Zero. When working in cold environments, it is suggested to prepare a spare battery. Preferably inside your jacket or in a similar location in order to keep the battery warm.
- Dust can interfere with the connection between battery and the radio. If necessary wipe the contacts with a clean cloth to ensure proper contact with radio and charger.



Storage

In order to prevent damage from over discharge, the battery must be left with partial power. This radio uses a lithium-based battery and a 40% charge is recommended. This level minimizes age-related capacity loss while keeping the battery in operating condition and allowing self-discharge.

Chapter 2. - Getting to know your radio

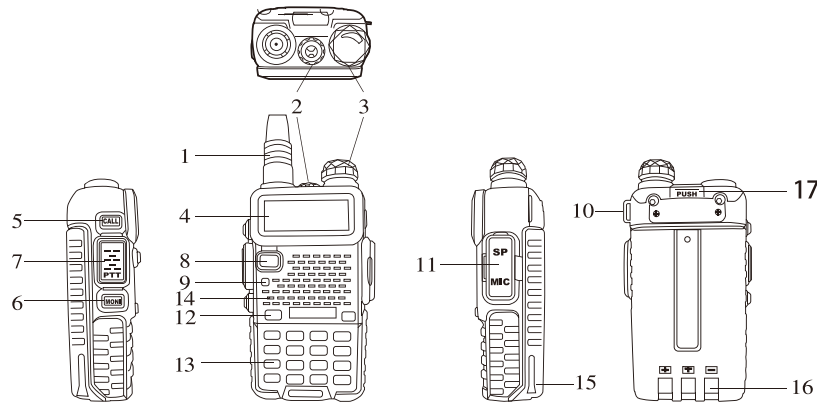

Figure 2.1. Baofeng UV-5RX3, overview



1. Antenna, see the section called "Notice" for details.
2. LED flashlight-See the section called "Side key 2 - MONI (Monitor and Flashlight)" for more information.
3. Power/ Volume knob, usage discussed in the section called "Power and volume".
4. Two-line LCD
5. Call key
6. Monitor key
7. PTT key, usage discussed in the section called "Making a call"
8. VFO / MR mode key
9. Status LED
10. Starap buckle
11. Accessory jack
12. A / B select key
13. Keypad
14. SP.&MIC
15. Battery pack; see the section called "Charging and battery maintenance" for detailsLanyard loop
16. Battery contacts
17. Battery remove button



Please make sure to install the antenna and battery is charged when start using a radio.

- Do not over-tighten your antenna to avoid damage to the outer materials and the connect base.
- When installing the antenna, please remember to grip it by the base and screw.
- When you choose using an external antenna, make sure its SWR is about 1.5:1 or lower to avoid damage to the transceiver.
- Do not hold the antenna with your hand or wrap the outside of it to avoid interference to the transceiver.
- Never transmitting without an antenna.

The main display

Figure 2.2. Baofeng UV-5RX3, display

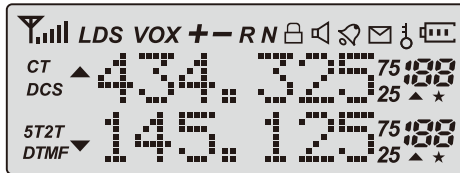

The transceiver is fitted with a seven character by two line dot matrix alphanumeric LCD, with auxiliary icons for miscellaneous features.



Table 2.1. Charger LED codes

Icon	Description	Icon	Description
	Memory channel	<i>R</i>	Reverse function enabled
<i>75</i> <i>25</i>	Least significant modifiers	<i>N</i>	Narrowband enabled
<i>CT</i>	CTCSS enabled		Battery level indicator
<i>DCS</i>	DCS enabled		Keypad lock enabled
<i>+ -</i>	Frequency shift direction (Offset) Channel	<i>L</i>	Low Power Enabled High Power enabled When X7 not Displayed
<i>*</i>	Channel Scan Enabled		Indicates active band or channel
<i>S</i>	Dual watch enabled		Squelch Open/Close Indicator
<i>VOX</i>	VOX enabled		



Even though it is a seven character by two-line display, channel memories are only configurable to six character names.



Battery Level Indicator



When the battery level indicator reads  the battery is depleted. At this point the radio will start beeping periodically as well as flashing the backlight of the display and when voice prompts are enabled, a "Low Voltage" announcement will be heard, indicating that you need to change your battery or put your radio in the charger.

Status LED

The status LED has a very simple and traditional design. When you receive a signal it shows green, when you transmit it shows red, and it's off in standby.

Side key 1 - CALL (Broadcast FM and Alarm)

Press  momentarily to start the broadcast FM receiver. Another momentary press turns the broadcast FM receiver off. If a signal is received on the active frequency or channel while you are listening to the broadcast FM, the squelch will be activated to that frequency (as if scanning) and remain there until the signal goes away; it will then switch back to broadcast FM.

Press and hold  to activate the alarm function. Press  (a short press) again to turn it off.



Side key 2 - MONI (Monitor and Flashlight)

Press  momentarily to turn on the LED flashlight. Another momentary press will flash the LED. Another momentary press turns the flashlight off.

Press and hold  to monitor the signal. This will open up the squelch so you can listen to the unfiltered signal.

VFO / MR - mode key

Pressing  switches between Frequency (VFO) Mode and Memory (MR) mode. Memory mode is sometimes also referred to as Channel mode.

To save frequencies to channel memory you must be in Frequency (VFO) mode.

A / B select key

The  key switches between A (upper) and B (lower) displays. The frequency or channel on the selected display becomes the active listening and transmit frequency or channel.



Numeric keypad

The Baofeng UV-5RX3 hand-held transceiver comes standard with a full numeric keypad.

Figure 2.3. Baofeng UV-5RX3, keypad



The numeric keys have their secondary function printed on them (in reality it's rather menu short-cuts, more on that in Chapter 4, Working the menu system).

The *** SCAN** and **# PTT** keys on the other hand have actual secondary functions, scan and keypad lock respectively.

Pound # Key

In channel mode, **# PTT** also acts as a transmit power shift key. While in channel mode, momentarily press **# PTT** to change between High and Low transmit power. Do note that this does not alter the transmit power stored to memory for that channel; it only affects the current session. Switching to another channel or another operating mode (including broadcast FM) will reset transmit power to what's stored in channel memory.

Keypad Lock

The Baofeng UV-5RX3 features a keypad lock that locks out all keys except for the three side keys.



To enable or disable the keypad lock, press and hold the **key** for about two seconds. You can also enable so that the radio automatically locks the keypad after ten seconds from the menu, see Chapter 4, Working the menu system.

Star * Key

A short momentary press of the key enables the reverse function (see Chapter 11 Repeaters). When listening to broadcast FM a momentary press will start the scanning. Scanning in broadcast FM will stop as soon as an active station is found, regardless of scanner resume method.

To enable the scanner, press and hold the *** SCAN** key for about two seconds. See Chapter 5, Scanning for details.

Menu and function keys

The **MENU** key, used to enter the menu and confirm menu options.

The **UP** and **DOWN** keys are used to navigate through the menu as well as select channels and step up or down in frequency (depending on operating mode).

The **EXIT** key is used to exit menus and cancel menu options.

For a more in-depth explanation on how to work the menu see Chapter 4, Working the menu system.



Accessory jack

The accessory jack on the Baofeng UV-5RX3 is a Kenwood compatible two (2)-pin design

Figure 2.4. Typical 2 pin Kenwood headset configuration.

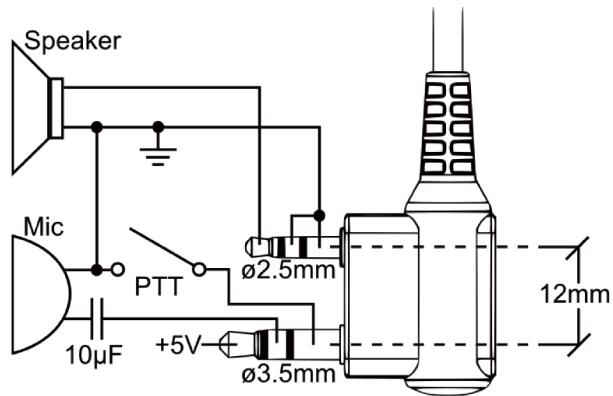

To attach accessories such as headsets, speaker-mics or programming cables, align the connectors and push in fully.



Chapter 3. - Basic Use

Power and volume

Before we turn the power on, make sure you have attached the battery and antenna as described in Chapter 1, Initial setup.

Turning the unit on

To power the radio on, simply rotate the volume/power knob clockwise until you hear a "click". If your radio powers on correctly there should be an audible double beep after about one second and the display will show a message or flash the LCD depending on settings for about one second (see "38 PON MSG - Power On Message" in Appendix B' Menu definitions). Then it will display a frequency or channel. If the Voice prompt is enabled, the voice will announce "frequency mode" or "channel mode".

Figure 3.1 First power-on, display

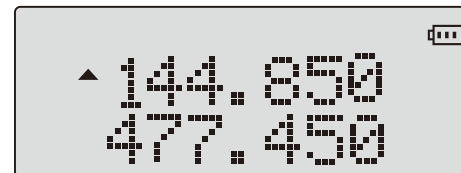

You can get additional information about your radio when you turn it on by holding down miscellaneous keys as you turn it on.



*Holding down the **3SAVE** key while turning on the radio provides you with the firmware version.*

Turning the unit off

Turn the volume/power knob counter-clock wise all the way until you hear a "click". The radio will be off.

Adjusting the volume

To turn up the volume, turn the volume/power knob clock-wise.

To turn the volume down, turn the volume/power knob counter-clock-wise. Be careful not to turn it too far, as you may inadvertently turn your radio off.



*By using the monitor function, enabled from the **MONI** key below the PTT, you can more easily adjust your volume by adjusting it to the un-squelched static.*

Making a call

Press and hold the PTT button on the side of the radio body to transmit. While transmitting, speak approximately 3-5cm from the microphone. When you release the PTT your transceiver will go back to receive mode.





Channel selection

There are two modes of operation: Frequency (VFO) mode, and Channel or Memory (MR) mode.

For daily use, Channel (MR) mode is going to be a whole lot more practical than Frequency (VFO) mode. However, Frequency (VFO) mode is very handy for experimentation out in the field. Frequency (VFO) mode is also used for programming channels into memory. For details on how to program your transceiver see Chapter 10, Programming.

Ultimately which mode you end up using will depend entirely on your use case.

Frequency (VFO) mode

In Frequency (VFO) mode you can navigate up and down the band by using the  and  keys. Each press will increment or decrement your frequency according to the frequency step you've set your transceiver to. For details on how to set the frequency step on your transceiver see Chapter 4, Working the menu system and the section called "1 STEP - Frequency Step1" in Appendix B, Menu definitions.



You can also input frequencies directly on your numeric keypad with kilohertz accuracy. However, the radio will floor to the nearest frequency that corresponds to your frequency step, in other words, when you input frequencies with greater than 1kHz resolution (such as 145.6875 MHz in the example below), always round your input up.

The following example assumes the use of a 12.5kHz frequency step.

Example 3.1. Entering the frequency 145.6875 MHz on display A









1. Use the  key to switch to Frequency (VFO) mode
2. Press  until the  appears next to the upper display (display A).
3. Enter    on the numeric keypad, it should look something like this:

Figure 3.2. Half-entered frequency input



4. Now, for the final four digits. Note that you can only enter three decimals on the keypad, if you type 687 it won't work. So how do you get the fourth and final digit 5 in there? By

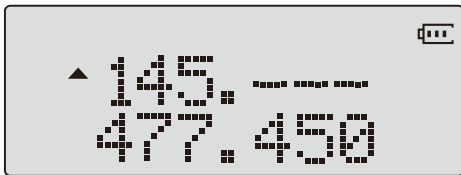

rounding 145.6875 up to 145.6880 MHz, an alternative is entering 145.675, and then pressing the  key once to move it up to 145.6875.



Enter    on the numeric keypad, if all went well the display should look something like this:

Figure 3.3. Successful frequency input



Just because you can program in a channel does not mean you're automatically authorized to use that frequency.

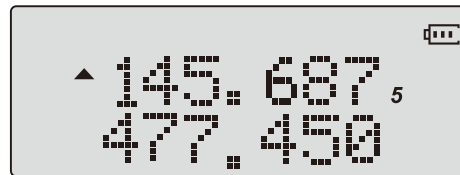

Transmitting on frequencies you're not authorized to operate on is illegal, and in most jurisdictions a serious offence. If you get caught transmitting without a license you can and will get fined, and in worst case sent to jail.

However, it is legal in most jurisdictions to listen. Contact your local regulatory body for further information on what laws, rules and regulations apply to your area.



Channel (MR) mode

The use of Channel (MR) mode is dependent on actually having programmed in some channels to use. To find out more on how to program channels see Chapter 10, Programming.

Once you have channels programmed and ready, you can use the  and  keys to navigate between channels



If you have channels programmed with Transmit power set to Low, you can use the  key momentarily switch over to high power if you're having trouble getting through.

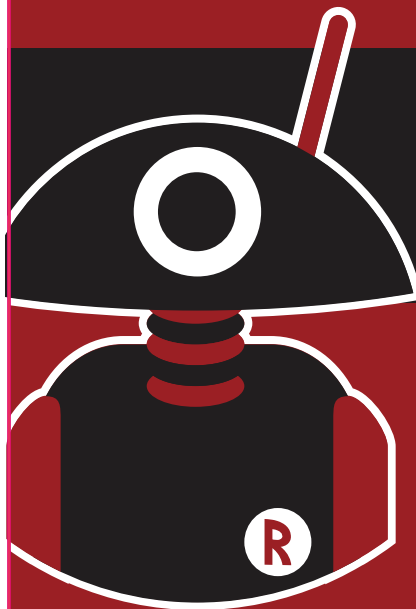

Part II. Advanced topics

Part two covers the more advanced topics, such as setup of repeater offset and programming via computer link.

- CHAPTER 4 WORKING THE MENU SYSTEM
- CHAPTER 5 SCANNING
- CHAPTER 6 DUAL WATCH
- CHAPTER 7 DTMF
- CHAPTER 8 SELECTIVE CALLING
- CHAPTER 9 CUSTOMIZATION
- CHAPTER 10 PROGRAMMING



Chapter 4. - Working the menu system

For a complete reference on available menu items and parameters, see Appendix B, Menu definitions.



If your radio is set to Memory (MR) mode. The following menu items will not take any effect: STEP, TXP, W/N, CTCSS, DCS, S-CODE, PTT-ID, BCL.SFT-D, OFFSET, MEM-CH, BAND

Basic use

1. Press the **MENU** key to enter the menu.
2. Use the **▲** and **▼** keys to navigate between menu items.
3. Once you find the desired menu item, press **ENTER** again to select that menu item.
4. Use the **▲** and **▼** keys to select the desired parameter.
5. When you've selected the parameter you want to set for a given menu item;
 - a. To confirm your selection, press **MENU** and it will save your setting and bring you back to the main menu.
 - b. To cancel your changes, press **MENU** and it will reset that menu item and bring you out of the menu entirely.
6. To exit out of the menu at any time, press the key.



Using short-cuts

As you may have noticed if you looked at Appendix B, Menu definitions, every menu item has a numerical value associated with it. These numbers can be used for direct access of any given menu item.

The menu is also organized in such a way that the ten most common functions are on top, and as can be seen in Figure 2.3, "Baofeng UV-5RX3, keypad", these are also printed on the keypad so you don't have to remember them all.

The parameters also have a number associated with them, see Appendix B, Menu definitions for details.

Procedure 4.1. Using the menu with short-cuts

1. Press the **MENU** key to enter the menu.
2. Use the numerical keypad to enter the number of the menu item.
3. To enter the menu item, press the **MENU** key.
4. For entering the desired parameter, you have two options:
 - a. Use the arrow keys as we did in the previous section;
 - b. Use the numerical keypad to enter the numerical short-cut code.
5. And just as in the previous section;



- a. To confirm your selection, press **MENU** and it will save your setting and bring you back to the main menu.
- b. To cancel your changes, press **EXIT** and it will reset that menu item and bring you out of the menu entirely.
6. To exit out of the menu at any time, press the **EXIT** key.
7. All further examples and procedures in this manual will use the numerical menu shortcuts.

Chapter 5. - Scanning

The Baofeng UV-5RX3 features a built in scanner for the VHF, 220MHz and UHF bands. When in Frequency (VFO) mode it will scan in steps according to your set frequency step. In Channel (MR) mode it will scan your channels.

Dual Watch is inhibited while scanning

To enable the scanner, press and hold the ***SCAN** key for about two seconds. Press any key to exit scanning mode.

Scanning modes

The scanner is configurable to one of three ways of operation: Time, carrier or search, each of which is explained in further details in their respective section below.



Procedure 5.1. Setting scanner mode

1. Press the **MENU** key to enter the menu.
2. Enter **1STEP 8DEEP** on your numeric keypad to turn to scanner mode.
3. Press the **MENU** key to select.
4. Use the **▼** and **▲** keys to select scanning mode.
5. Press the **MENU** key to confirm and save.
6. Press the **EXIT** key to exit the menu.

Time operation

In Time Operation (TO) mode, the scanner stops when it detects a signal, and after a factory pre- set time out, it resumes scanning.

Carrier operation

In Carrier Operation (CO) mode, the scanner stops when it detects a signal, and after a factory preset time with no signal it resumes scanning.

Search operation

In Search Operation (SE) mode, the scanner stops when it detects a signal. To resume scanning you must press and hold the ***SCAN** key again.



Scanning a Frequency Range (VFO Mode)

The UV-5RX3 can scan a user selected frequency range

Procedure 5.2. Settingscanning range

1. Press and Hold for about 2 seconds
2. The Radio will begin to scan the frequency

Scanning Your Selected Channels (Channel Mode)

The UV-5RX3 can scan your programmed memory channels; you can easily add or remove channels from the scanning bank at any time

Procedure 5.3. Scanning channels

1. Press and Hold about 2 seconds to start scanning
2. Channels with a ★ by the Channel number will be included in the scan cycle

Adding or Removing A Channel from the Scan List

1. First Select the Channel You want to Add or Remove from the Scan List, you can do this by either typing the channel number or using the arrow keys to scroll to the desired channel.
2. Press the key to enter the menu.
3. Enter on your numeric keypad to come to Menu 33: SC-ADD
4. Press the key to select.
5. Use the and keys to navigate between menu items.



- a. Set to OFF -to Remove the Channel from the Scanning list
 - b. Set to ON -to Add the Channel to the Scanning List
6. Press the key to confirm.

Tone Scanning

Scanning for CTCSS and DCS Tones/Codes

Scanning for a CTCSS tone or DCS code can be done while Frequency Mode (VFO) or Channel Mode (MR) is selected. Only when VFO mode is selected, can the detected tone/code be saved to menu 11/10.



CTCSS tone and DCS code scanning mode can be accessed with or without a signal being present. The scanning process itself only occurs while a signal is being received.

Not all repeaters requiring a CTCSS tone or DCS code for access will transmit one back. In that case, the transmitter of a station that can access the repeater would need to be scanned. In other words: this would be done by listening to stations on the repeater's input frequency.



Scanning for CTCSS Tone

1. Press the **MENU** key to enter the menu.
2. Enter **1 STEP 1 STEP** on your numeric keypad to come to Menu 11:R-CTCS
3. Press the **MENU** key to select.
4. Press the ***SCAN** to begin CTCSS scanning

A flashing "CT" will be in the left status display to indicate the radio is in CTCSS scanning mode. In this mode, whenever the radio is receiving an RF signal on the selected MR channel or VFO frequency, the lower display will cycle through the CTCSS tones as they are being test. Once the frequency of the received CTCSS tone is determined, the "CT" indicator will stop flashing.

Press the **MENU** key to save the scanned tone into memory (VFO Mode Only) then press the **MENU** key to exit the menu.



Don't forget to set VFO menu 11 back to OFF when the CTCSS tone is no longer required.

Scanning for a DCS tone

7. Press the **MENU** key to enter the menu
- 8 Enter **1 STEP 0 SOL** on your numeric keypad to come to Menu 10: R-DCS
9. Press the **MENU** key to select.
10. Press the ***SCAN** to begin DCS scanning



A flashing "DCS" will be in the left status display to indicate the radio is in DCS scanning mode.

In this mode, whenever the radio is receiving an RF signal on the selected MR channel or VFO frequency, the lower display will cycle through the DCS codes as they are being tested. Once the bits of the received DCS code are determined, the "DCS" indicator will stop flashing.

Press the **MENU** key to save the scanned tone into memory (VFO Mode Only) then press the **EXIT** key to exit the manual.



Don't forget to set VFO menu 10 back to OFF when the DCS tone is no longer required.

Chapter 6. -Dual Watch

In certain situations, the ability to monitor two channels simultaneously can be a valuable asset.

The Baofeng UV-5RX3 features Dual Watch functionality with the ability scans between two frequencies at a fixed intervals and to lock the transmit frequency to one of the two channels it monitors.



Procedure 6.1. Enabling or disabling Dual Watch mode

1. Press the **MENU** key to enter the menu
2. Enter **7 TDR** on the numeric keypad to get to Dual Watch.
3. Press **MENU** to select.
4. Use the **▲** And **▼** keys to enable or disable.
5. Press the **MENU** key to confirm.
6. Press the **EXIT** key to exit the menu.

Due to the way the Baofeng UV-5RX3 is constructed, whenever one of the A or B Frequencies (VFO/MR) goes active, it will default to transmit on that channel. This behavior can be inconvenient, especially if when monitoring a frequency, you should not transmit on. There is a menu option available to lock the transmitter to one of the A or B channels.

Procedure 6.2. Locking the Dual Watch transmit channel

- Press the **MENU** key to enter the menu.
2. Enter **3 SAVE 4 VOX** on the numeric keypad to get to TDR-AB.
 3. Press **MENU** to select.
 4. Use the **▲** And **▼** keys to select A (upper) or B (lower) display.
 5. Press the **MENU** key to confirm.
 6. Press the **EXIT** key to exit the menu.



*If you want to momentarily override the lock without having to set the menu option to OFF, you can do so by pressing the **A/B** key an instant before pressing the PTT.*

Chapter 7. -DTMF

DTMF is an in-band signaling method using dual sinusoidal signals for any given code. Originally developed for telephony systems, it has proved a very versatile tool in many other areas.

In two-way radio systems, DTMF is most commonly used for automation systems and remote control. A common example would be in amateur radio repeaters where some repeaters are activated by sending out a DTMF sequence (usually a simple single-digit sequence)

Table 7.1. DTMF frequencies and corresponding codes

	1209 Hz	1336 Hz	1477 Hz	1633 Hz
697 Hz	1	2	3	A
770 Hz	4	5	6	B
852 Hz	7	8	9	C
941 Hz	*	0	#	D



The Baofeng UV-5RX3 has a full implementation of DTMF, including the A, B, C and D codes.

The numerical keys, as well as the **#** , and ***SCAN** keys correspond to the matching DTMF codes as you would expect The A, B, C and D codes are located in the **MENU** , **▲** , **▼** and **EXIT** keys respectively (+).

To send DTMF codes, press the key(s) corresponding to the message you want to send while holding down the PTT key.



If you have the keypad lock enabled on your radio, you can still send DTMF tones the regular way without having to unlock your radio.



Chapter 8. - Selective calling

Some times when you're working with larger groups of people using the same channel, communication can get very crowded or disorderly. To minimize this problem, several methods of blocking out unwanted transmissions on your frequency have developed. In general, there are two forms of selective calling in two-way radio systems: Group calling, and individual calling.

Group calling, as the name suggest, is a one-to-many form of communication. Every radio in your working group is configured the same way and any radio will make contact with every other radio in the group.

Individual calling, sometimes also known as paging, is a one-to-one form of communication.

Every radio is programmed with a unique ID code. And only by sending out a matching code can you get that radio to open up to your transmissions.

The Baofeng UV-5RX3 features three different ways of group calling

- CTCSS
- DCS
- Tone-burst (1000Hz, 1450HZ, 1750Hz)



The Baofeng UV-5RX3 does not feature any form of individual calling.



Using these features does NOT mean that others won't be able to listen in on your transmissions

They only provide a method to filter out unwanted incoming transmissions. Any communications mode while using these features will still be heard by anyone not employing filtering options of their own.

Also, you cannot change the CTCSS or DCS settings while in memory (MR) mode.

CTCSS and 1750Hz tone-burst are also popular methods among amateur radio operators to open up repeaters.

CTCSS

CTCSS is set with menus 11 R-CTCS and 13 T-CTCS.

For a complete list of available CTCSS codes and corresponding sub-tone frequencies, see Table C.2, "CTCSS Frequencies" in Appendix C, Technical specifications.

Procedure 8. 1. CTCSS setup how-to

1. Press the **MENU** key to enter the menu.
2. Enter **1STEP 1STEP** on the numeric keypad to get to receiver CTCSS.
3. Press **MENU** to select.



4. Enter desired CTCSS sub-tone frequency in hertz on the numeric keypad.
5. Press **MENU** to confirm and save.
6. Enter **1STEP 3SAVE** on the numeric keypad to go to transmitter CTCSS.
7. Press **MENU** to select
8. Enter desired CTCSS sub-tone frequency in hertz on the numeric keypad. Make sure it's the same frequency as that you entered for receiver CTCSS.
9. Press **MENU** to confirm and save.
10. Press **EXIT** to exit the menu system.

To turn CTCSS off, follow the same procedure but set it to off with the 0 SQL key instead of selecting a CTCSS sub-tone frequency.

For more operation details, see the section called "11- Receiver CTCSS" and the section called "13- Transmitter CTCSS" in Appendix B, Menu definitions.

DCS

DCS is set with menus 10 R-DCS and 12 T-DCS

For a complete list of available DCS codes, see Table C.1, "DCS Codes" in Appendix C, Technical specifications.



Procedure 8. 2. DCS setup how-to

1. Press the **MENU** key to enter the menu.
2. Enter **1 STEP 0 SQL** on the numeric keypad to get to receiver DCS.
3. Press **MENU** to select.
4. Enter desired DCS code on the numeric keypad.
5. Press **MENU** to confirm and save.
6. Enter **1 STEP 2 TXP** on the numeric keypad to go to transmitter DCS.
7. Press **MENU** to select.
8. Enter desired DCS code on the numeric keypad. Make sure it's the same code as that you entered for receiver DCS.
9. Press **MENU** to confirm and save.



1000Hz, 1450HZ, 1750HZ Tone-burst

To send out a tone-burst; you simultaneously will press a key while holding down the PTT. No further configuration required using this feature.

The following configurations will transmit accordingly:

PTT + **CALL** = Transmits 1000Hz Tone Burst

PTT + **VFO/MR** = Transmits 1450Hz Tone Burst

PTT + **A/B** = Transmits 1750Hz Tone Burst



If you have the keypad lock enabled on your radio, you can still send a 1750Hz tone the regular way without having to unlock your radio.

Chapter 9. - Customization

The Baofeng UV-5RX3 allows for customization of both the power-on message (via computer link only), and the backlight color during the three states of the transceiver (Transmit, Receive and Standby).



Display

The LCD on the Baofeng UV-5RX3 is backlit by multi-color LEDs, the color of which can be pre-set from the menu system into a variety of colors.

To change the colors, follow these steps:

Procedure 9. 1. Changing backlight color

1. Press the **MENU** key to enter the menu.
2. Enter one of the following on your numeric keypad
 - a. **2 TXP 9 TOT** to change the standby color
 - b. **3 SAVE 0 SQL** to change the receive color.
 - c. **3 SAVE 1 STEP** to change the transmit color
3. Press **MENU** key to select
4. Use the **▲** and **▼** keys to pick the desired color
5. Press **MENU** to confirm and save
6. Press **EXIT** to exit the menu.

To change the duration of the backlight stays on for your LCD, follow these steps:



Procedure 9.2. Setting backlight time-out

1. Press the **MENU** key to enter the menu.
2. Enter **6 ABR** on your numeric keypad to come to backlight time out.
3. Press **MENU** key to select.
4. Use the **▲** and **▼** keys to pick the desired color
5. Press **MENU** to confirm and save
6. Press **EXIT** to exit the menu.

For details see the section called "29 WT-LED- Display backlight color, Standby" and onward in Appendix B, Menu definitions.

To sync channels on the display (simultaneously display channel name and frequency), follow these steps:



Procedure 9.3 . Setting the power-on-message

1. Click **other** in the menu bar; a dialogue box titled "Other" should have popped up.
2. In the box titled "Power On Message", there are two text fields representing the two lines on your LCD. Enter the desired text in the fields.
3. Click **Write** to write your changes to the radio.

Even though the software has eight (8) character wide text for the power-on message, be aware that the display on the UV- 5RX3 can only display a maximum of seven (7) characters.



Make sure that menu item 38 is set to MSG, otherwise your message won't be displayed. See Chapter4 Working the menu system for details on how to navigate the menu.

Sometimes it takes the Baofeng software more than one try to connect to your radio. If you see a dialogue box popping up stating that you have a connection failure, close the dialogue box and click read or write again.



Chapter 10. - Programming

Memory channels are an easy way to store commonly used frequencies so that they can easily be retrieved at a later date.

The Baofeng UV-5RX3 features 128 memory channels that each can hold: Receive and transmit frequencies, transmit power, group signaling information, bandwidth, ANI/ PTT-ID settings and a six-character alphanumeric identifier or channel name 1.

Manual programming

Manual programming is somewhat difficult until you get used to it, especially when programming in duplex channels. Note that the ANI S-CODE IDs can only be set from a computer. When programming channels it is important to remember that you can only save memory channels when working on the upper display in VFO mode.

To create a new channel, start by switching your radio to Frequency (VFO) mode using VFO/MR key. When in Frequency (VFO) mode, select your desired receive frequency using the numerical keypad. After that, use the menu system to configure the finer details of the channel you're wanting to program to memory, such as transmit power, bandwidth, CTCSS or DCS and more.



For more information on how to use the menu system see Chapter 4, Working the menu system and Appendix B, Menu definitions. Information regarding how to set up CTCSS and DCS can be found in Chapter 8, Selective calling



On manual programming you cannot overwrite an existing channel. You must first delete the channel before updating or replacing it

Simplex channels

The following steps assume that you're in Frequency (VFO) mode and that you've entered the desired frequency to store to memory.

1. Press the **MENU** key to enter the menu.
2. Enter **2 TXP 7 TDR** on the numerical keypad to get to MEM-CH.
3. Press **MENU** to select.
4. Use the **▲** and **▼** keys to select an empty memory channel, or enter it directly on the numerical keypad.
5. Press the **MENU** key to confirm.
6. Press the **EXIT** key to exit the menu.

Switch to Channel (MR) mode with the (VFO/MR) key to test your new channel. If you would like to name your channel you will need to do that from a computer. More on that in the section called “Computer programming”.



Duplex channels

The following assumes you've setup a duplex channel in VFO mode on the upper display, as described in Chapter 11, Repeaters, and that you're still in VFO mode.

1. Save as you would a regular simplex channel, as described in the previous section.
2. Press the ***SCAN** key momentary to get into reverse mode
3. Save that again to the same memory channel just as in step one (1)

Switch to Channel (MR) mode with the **VFO/MR** key to test your new channel. If you would like to name your channel you will need to do that from a computer. More on that in the section called “Computer programming”.

Computer programming

The Radio kit does not include a programming cable. To attain a PC cable please visit <https://www.radioddity.com/>

Download programming software at https://www.radioddity.com/baofeng_download/

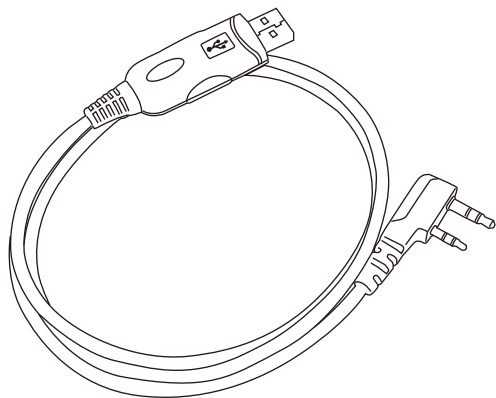

RD-201 PROGRAMMING CABLE
For UV-5RX3 Computer Programming

Software and cable support for Windows, and Linux

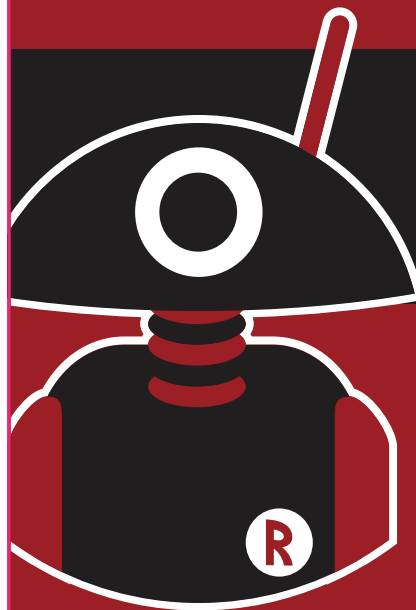

Part III. How-to and setup guides

Part three covers is a collection of how-to documents to help you set up your radio for specific working environments.

- CHAPTER 11 REPEATERS
- CHAPTER 12 AUTOMATIC NUMBER IDENTIFICATION
- CHAPTER 13 APPLICATION SPECIFIC SETUP



Chapter 11. - Repeaters

A radio repeater is an automated transceiver in a fixed location. Usually mounted high up on hilltops or on tall buildings, but sometimes they operate within buildings for internal use. A repeater takes one signal and relays it, usually after amplifying it by orders of magnitude. This can be very handy, as this enables you to use a small low powered hand-held two-way transceiver such as the Baofeng UV-5RX3 to reach great distances.

Whether you're a commercial (business or government) user or an amateur radio operator, chances are you'll deal with a repeater system sooner or later. To find out what settings to use to use your local repeater, ask your employer or someone at your local amateur radio organization for details.

A common type of repeater is the duplex repeater. In a duplex repeater system, the repeater transmits and receives simultaneously, but on different frequencies. To utilize this type of repeater, your radio has to be capable of transmitting and receiving on different frequencies on the same memory channel. How you use this kind of repeater is by setting the receive frequency of your radio to the output frequency of the repeater, and the transmit frequency of your radio to the input frequency of the repeater. Often times, the transmit frequency to use isn't explicitly stated, but rather an offset relative your receive frequency is specified. This is conveniently enough also how the Baofeng UV-5RX3 natively handles repeater set up in VFO, by specifying offset rather than transmit frequency.



This is might cause confusion because many expect this to be true globally when it isn't.

SFT-D and OFFSET only function in VFO mode.



MR mode uses and stores the RX frequency and the TX frequency only. SFT-D and OFFSET don't have to be set or they can even be set completely wrong and working repeater channel can be created

It is convenient to use SFT-D and OFFSET with 'reverse' mode to determine the TX frequency to be stored in a channel, but they are otherwise unused for MR mode.

The following instructions assume that you know what transmit and receive frequencies your repeater employs, and that you're authorized to use it.

Procedure 11.1. Repeater setup

1. Set the radio to Frequency (VFO) mode with the key.
2. Enter the repeater's output (your receiving) frequency by either using the and Keys, or entering it directly on the numerical keypad.
3. Press the key to enter the menu.
4. Enter on the on the numeric keypad to get to frequency offset.
5. Press key to select.
6. Use the and keys and numeric keypad to enter the specified frequency offset. See the section called "26 OFFSET-Frequency shift amount" for details.



7. Press **MENU** to confirm and save.
8. Enter **2 TYP** **6 ABR** on the numeric keypad to get to offset direction.
9. Use the **▲** and **▼** keys to select +(positive) or-(negative) offset.
10. Press **MENU** to firm and save.
11. Optional:
 - a. Save to memory, see the section called “Manual programming” for details.
 - b. Set up CTCSS; see the section called “CTCSS” for details.
12. Press **EXIT** to exit the menu.

If everything went well, you should be able to make a test call through the repeater. If you're experiencing problems making a connection to the repeater, check your setting and/or go through the procedure again.

Certain Amateur Radio repeater (especially in Europe) use a 1750Hz tone burst to open up the repeater. To see how this is done with the Baofeng UV-5RX3, see the section called “1750Hz Tone- burst”.

If you're still unable to make a connection, contact the person in charge of the radio system with your employer or your local amateur radio club, as the case may be.



*If you for some reason want to listen to the repeater's input frequency instead, press ***SCAN** momentarily and you'll reverse your transmit and receive frequencies.*



This is indicated in the LCD on the radio with an R in the top now, next to the + and- for the offset direction.

Chapter 12. - Application Specific Setup

Commercial Radio Setup

Follow these instructions to set your radio to Narrowband mode:

This section is only true for VFO mode.



WN is settable on a per channel basis and has to be set prior to storing a channel. Once a channel has been programmed, the channel must be deleted and reprogrammed to change the WN setting.

1. Press the **WFO/MR** key to enter frequency mode.
2. Press the **MENU** key to enter the menu.
3. Enter **5 WN** on the numerical keypad.
4. Press **MENU** to select.
5. Use the **▲** and **▼** keys to select between Wide and Narrow (“Narr”).
6. Press **MENU** to confirm and save.
7. Press **EXIT** to exit the menu.



If your employer has a dispatch system that requires your radio to identify via ANI, please see Chapter 12, Automatic Number identification for detailed instructions on how to set that up on your radio.

To find out what other channels and features needed, please contact your employer.

Amateur Radio Setup

In contrast with Commercial radio operators, who often need very specific requirements to be compatible with a very specific radio implementation, Amateur radio operators tend to need the broadest possible settings in order to be compatible with as many systems as possible. This basically implies turning all the fancy features that you typically might need for a commercial setup off.

In a typical Amateur radio setup the following settings would be recommended:

- Set bandwidth to Wide (menu item 5).
- Turn DCS and CTCSS off (menu items 10 through 13).
- Turn ANI, DTMFST, S-CODE, PTT-ID off and PTT-LT to Oms (menu items 15 through 17 and 19 through 20).
- Turn off Squelch Tail Elimination (STE) features (menu items 35 through 37).
- Turn roger beep (ROGER) off (menu item 39).

For further information see Appendix B, Menu definitions and Chapter4, Working the menu system.



FRS, GMRS, MURS, PMR446



You may be tempted to use FRS GMRS, MURS (in the USA) or PMR446 (in Europe) frequencies. Do note however there are restrictions on these bands that make this transceiver illegal for use.

Appendix A. - Troubleshooting

Symptom	Possible	Solution
The radio doesn't start	The battery is too low. The battery isn't correctly installed.	Change or recharge the battery. Remove the battery and reinstall it.
The battery dies quickly	The battery is dead. The battery isn't fully charged	Purchase a new battery. Recharge the battery.
The LED indicates reception, but the speaker is silent.	Volume is too low. CTCSS or DCS enabled	Turn up the volume. Change your CTCSS or DCS to match those you're trying to communicate with. Turn CTCSS or DCS off.
Others can't hear my transmission.	Their CTCSS or DCS settings don't match yours. You're too far apart.	Change your CTCSS or DCS settings to match your peers. Move in closer.
The radio transmits without touching the PTT.	The VOX is enabled. VOX sensitivity is too high.	Turn VOX off. Turn down VOX sensitivity.



Appendix B. - Menu definitions

See Chapter4, Working the menu system for more info about using menu-system.

Menu	Name (Full Name)	Settings	Description
0	SQL - Squelch Level	[0-9] Setting the squelch to 0 will Open up the squelch entirely.	-Squelch silences the receiver when there is no signal. -Sensitivity can be varied from .1 to .3 mV on UHF Sensitivity can be varied from .1 to.2 mV on VHF
1	STEP - Frequency Step	2.5K[0] 5.0K[1] 6.25K[2] 10.0K[3] 12.5K[4] 20.0K[5] 25.0K[6] 50.QK [7]	Selects the amount of frequency change in VFO/Frequency mode when scanning or pressing the and keys.
2	TXP - Transmit Power	HIGH [0] LOW [1]	Selects between HIGH and LOW transmitter power when in VFO/Frequency mode. Use the minimum transmitter power necessary to carry out the desired communications.
3	SAVE - Battery Save	OFF [0] 1 2 3 4	Selects the ratio of sleep cycles to awake cycles (1:1,2:1,3:1,4:1). The higher the number the longer the battery lasts. The higher number increases the RX sleep cycle, but you may miss the first few syllables before the RX opens.



4	VOX-Voice	OFF [0] 1 2 3 4 5 6 7	When enabled it is not necessary to push the [PTT] button on the transceiver. Adjust the gain level to an appropriate sensitivity to allow smooth transmission.
5	WN – Wide band Narrow band	WIDE [0] NARR [1]	Wideband (25 kHz bandwidth) or Narrow band (12.5 kHz bandwidth).
6	6 ABR - Display Illumination Time	OFF [0] X 2 3 4 5 6 7 S 9 10	Time-out for the LCD backlight, (seconds)
7	TDR - Dual Watch, Dual Reception	OFF [0] ON [1]	Monitor [A] and [B] at the same time. The display with the most recent activity ([A])
8	BEEP - Keypad Beep	OFF [0] ON [1]	Allows audible confirmation of a key press
9	TOT - Transmission Time- out-Timer	15[0]-600[39] in 15 second steps (TIMEOUT-15)/15=[n]	This feature provides a safety switch that limits transmission time to a programmed value. This will promote battery conservation by not allowing you to make excessively long transmission, and in the event of a stuck PTT switch it can prevent interference to other users as well as battery depletion.



10	R-DCS-Receiver DCS	OFF[0] see DCS Table in Appendix C	Mutes the speaker of the transceiver in the absence of a specific low-level digital signal. If the station you are listening to does not transmit this specific signal, you will not hear anything.
11	R-CTCS - Receiver CTCSS	OFF[0] see CTCSS Table in Appendix C	Mutes the speaker of the transceiver in the absence of a specific and continuous sub-audible signal. If the station you are listening to does not transmit this specific and continuous signal, you will not hear anything.
12	T-DCS- Transmitter DCS	OFF[0] see DCS Table in Appendix C	Transceiver a specific low-level digital signal to unlock the squelch of a distant receiver (usually a repeater)
13	T-CTCS- Transmitter CTCSS	OFF[0] see CTCSS Table in Appendix C	Transceiver a specific and continuous sub-audible signal to unlock the squelch of a distant receiver(usually a repeater).
14	VOICE- Voice Prompt	OFF[0]] ENG [1]] CHI [2]	Allows audible voice confirmation of a key press
15	ANI-ID- Automatic Number ID		Displays the ANI code that has set by Software. This menu cannot be used to change it. The ANI-ID is sent when the alarm is activated and menu 32=CODE



16	DTMFST- DTMF- Side Tone of Transmit code	OFF [0]: No DTMF side Tones are heard DT-ST [2]: Side Tones are heard Only from automatically keyed DTMF codes DT+ANI [3]: All DTMF Side Tones Are heard	Determines when DTMF Side Tones can be Heard from the transceiver speaker.
17	S-CODE Signal Code	1[0] 2[1] 3[2] 4[3] 5[4] 6[5] 7[6] 8[9] 9[8] 10[9] 11[10] 12[11] 13[12] 14[13] 15[14]	Selects 1 of 15 DTMF codes. The DTMF codes are programmed with software and are up to 5 digits each.
18	SC-REV-Scanner Resume Method	To [0]: Time Operation-scanning Will resume after a fixed time has Passed CO [1]: Carrier Operation- Scanning will resume after the signal disappears SE [2]: Search Operation- Scanning will not resume	Scanning Resume Method
19	PTT-ID – When to send the PTT-ID	OFF [0]: No ID is sent BOT [1]: The selected S-CODE is Sent at the beginning EOT [2]: The selected S-CODE is Sent at the beginning and ending	When to Sand PTT-ID Codes are sent during either the beginning or ending of a transmission.
20	PTT-LT-Signal Code sending delay	0-50ms	PTT-ID Delay (milliseconds)



21	MDF-A-Channel Mode A Display	CH [0]: Displays the channel number NAME [1]: Display the channel name FREQ [2]: Display programmed Frequency	[A] MR/Channel Mode Display Format Note: Names must be entered using software
22	MDF-B-Channel Mode B Display	CH [0]: Displays the channel number NAME [1]: Display the channel name FREQ [2]: Display programmed Frequency	[B] MR/Channel Mode Display Format Note: Names must be entered using software
23	BCL- Busy Channel Lock-out	OFF [0] ON [1]	Disables the [PTT] button on a channel that is already in use. The transceiver will sound a beep tone and will not transmit if the [PTT] button is pressed when a channel is already in use.
24	SYNC - Sync	OFF [0] ON[1]	When ON, the two displays will sync. This enables you to see both Channel Name and Frequency at the same time (Use with Menus 21&22)
25	SFT-D – Frequency Shift Direction	OFF [0]: TX = RX (simplex) + [1]: TX will be shifted higher in frequency than RX - [2]: TX will be shifted lower in frequency than RX	PTT-ID Delay (milliseconds)



26	OFFSET - Frequency Shift amount	00.000-69.990 in 10 kHz steps	Specifies the difference between the TX and RX frequencies
27	MEM-CH – Store a Memory	000-127	This menu is used to either create new or modify existing channels (0 through 127) so that they can be accessed from MR/Channel Mode.
28	DEL-CH-Delete a memory channel	000-127	This menu is used to delete the programmed information from the specified channel (0 through 127) so that it can either be programmed again or be left empty.
29	WT-LED - Display backlight color,	OFF [0] BLUE [1] ORANGE [2] PURPLE [3]	Default: PURPLE
30	RX-LED - Display backlight color- Receive	OFF [0] BLUE [1] ORANGE [2] PURPLE [3]	Default: BLUE



32	AL-MOD – Alarm Mode		<p>SITE [0]: Sounds alarm through your radio speaker only</p> <p>TONE [1]: Transmits a cycling tone over-the-air</p> <p>CODE [2]: Transmits '119'(911 in reverse?) followed by the ANI code over-the-air</p>	<p>SITE: Sounds alarm through your radio speaker only</p> <p>TONE: Transmits a cycling tone over-the-air</p> <p>CODE: Transmits '119' (911 in reverse?) followed by the ANI code over-the-air</p>
33	SC-ADD - Scan Add	OFF [0] ON [1]	In Channel mode adds or removes the channel from the scanning list.	
34	TDR-AB—Transmit selection while in Dual Watch mode	OFF[0] A[1] B[2]	When enabled, priority is returned to selected display once the signal in the other display disappears.	
35	STE - Squelch Tail Elimination	OFF[0] ON [1]	This function is used eliminate squelch tail noise between Baofeng handhelds that are communicating directly (no repeater).Reception of a 55 Hz or 134.4 Hz tone burst mutes the audio long enough to prevent hearing any squelch tail noise.	
36	RP-STE - Squelch Tail Elimination	OFF [0] 1 - 10	This function is used eliminate squelch tail noise when communicating through a repeater	



37	RPT-RL - Delay the squelch tail of repeater	OFF [0] 1 - 10	Delay the Tail Tone of Repeater(X100 milliseconds)	
38	PONMSG - Power On Message	FULL [0]: Performs an LCD screen test at power-on MSG [1]: Displays a 2-line power-on message	Controls the behavior of the display when the transceiver is turned on.	
39	ROGER- Roger Beep	OFF [0] ON [1]	Sends an end-of-transmission tone to indicate to other stations that the transmission has ended.	
40	D-ANI - Decode ANI Transmissions	OFF [0] ON [1]	Displays the incoming ANI (DTMF tone) transmission on the received display. Quickly entered DTMF tones-or ANI IDs will be Identified and displayed.	
41	DTMF-G	0-60	Adjusts the audio level of transmitted DTMF tones. Audio level Adjustment for ANI and DTMF Options.	
42	RESET - Restore defaults	VFO [0] ALL[1]	Resets the radio to factory defaults, with some exceptions.	
43	RESET - Restore defaults	VFO [0] ALL[1]	Resets the radio to factory defaults, with some exceptions.	



Appendix C. - Technical specifications

General

General specifications

Specification	Value
Frequency Range (MHz)	65-108(Rx only) 136.000-173.975MHz(Rx/Tx) 200.000-259.975MHz(Rx/Tx) 400.000-519.975MHz(Rx/Tx)
Memory channels	128
Frequency stability	2. 5ppm
Frequency step (kHz)	2.5K/5.0K/6.25K/10.0K/12.5K/20.0K /25.0K/50.0K
Antenna impedance	50 Ohm
Operating temperature	-20 °C to +60 °C
Supply voltage	7.4V
Consumption	≤75mA (standby) 380mA (reception) ≤1.4A(transmission)
Mode of operation	Simplex or semi-duplex
Duty cycle	03/03/54 min. (Rx/Tx/ Standby)
Dimensions(mm)	58X110X32
Weight (g)	214



Transmitter

Transmitter specifications

Specification	Value
RF power (W)	5 (VHF high) 4(200.000-259.975MHz high) 4(UHF high) 1(VHF low) 1(200.000-259.975MHz low)
1(UHF low)	
Type of modulation	FM
Emission class	16K#F3E(wideband)
11K#F3E (narrowband)	
Maximum deviation(kHz)	≤±5.0 (wideband) ≤±2.5 (narrowband)
Spurious emissions (dB)	<-60dB

Receiver

Receiver specifications

Specification	Value
Receiver sensitivity	0.2µV (a t 12dB SINAD)
Intermodulation	60dB
Audio Output	1000mW
Adjacent channel selectivity	65/60dB

**DCS table**

Table C.1. DCS Codes

Number	Code	Number	Code	Number	Code	Number	Code
001	D023N	002	D025N	003	D026N	004	D031N
005	D032N	006	D036N	007	D043N	008	D047N
009	D051N	010	D053N	011	D054N	012	D065N
013	D071N	014	D072N	015	D073N	016	D074N
017	D114N	018	D115N	019	D116N	020	D122N
021	D125N	022	D131N	023	D132N	024	D134N
025	D143N	026	D145N	027	D152N	028	D155N
029	D156N	030	D162N	031	D165N	032	D172N

Number	Code	Number	Code	Number	Code	Number	Code
033	D174N	034	D205N	035	D212N	036	D223N
037	D225N	038	D226N	039	D243N	040	D244N
041	D245N	042	D246N	043	D251N	044	D252N
045	D255N	046	D261N	047	D263N	048	D265N
049	D266N	050	D271N	051	D274N	052	D306N
053	D311N	054	D315N	055	D325N	056	D331N
057	D332N	058	D343N	059	D346N	060	D351N
061	D356N	062	D364N	063	D365N	064	D371N



065	D411N	066	D412N	067	D413N	068	D423N
069	D431N	070	D432N	071	D445N	072	D446N
073	D452N	074	D454N	075	D455N	076	D462N
077	D464N	078	D465N	079	D466N	080	D503N
081	D506N	082	D516N	083	D523N	084	D526N
085	D532N	086	D546N	087	D565N	088	D606N
089	D612N	090	D624N	091	D627N	092	D631N
091	D627N	092	D631N	093	D632N	094	D645N
094	D645N	095	D654N	096	D662N	094	D645N
097	D664N	098	D703N	099	D718N	100	D723N
101	D731N	102	D732N	103	D734N	104	D743N
105	D754N	106	D0231	107	D0251	108	D0261
109	D0311	110	D0321	111	D0361	112	D0431
113	D0471	114	D0511	115	D0531	116	D0541
117	D0651	118	D0711	119	D0721	120	D0731
121	D0741	122	D1141	123	D1151	124	D1161
125	D1221	126	D1251	127	D1311	128	D1321
129	D1341	130	D1431	131	D1451	132	D1521
133	D1551	134	D1561	135	D1621	136	D1651
*137	D1721	D1741	D2051	D2121	D223 1	D2251	D2261
D2431	D2441	D2451	D2461	D2511	D2521	D2551	D2611



D331I	D332I	D343I	D346I	D351I	D356I	D364I	D365I
D371I	D411I	D412I	D413I	D423I	D431I	D432I	D445I
D446I	D452I	D454I	D455I	D462I	D464I	D465I	D466I
D503I	D506I	D516I	D523I	D526I	D532I	D546I	D565I
D606I	D612I	D624I	D627I	D631I	D632I	D645I	D654I
D662I	D664I	D703I	D712I	D723I	D731I	D732I	D734I
D743I	D754I						



**After DCS Number Shortcut I37, in order to navigate through the subsequent codes manually key in shortcut 137 and then use the arrow keys to navigate to the DCS tone required*

CTCSS table

Table C.2. CTCSS Frequencies

Number	Frequency	Number	Frequency	Number	Frequency	Number	Frequency
01	67.0	02	69.3	03	71.9	04	74.4
05	77.0	06	79.7	07	82.5	08	85.4
09	88.5	10	91.5	11	94.8	12	97.4
13	100.0	14	103.5	15	107.2	16	110.9
17	114.8	18	118.8	19	123	20	127.3



21	131.8	22	136.5	23	141.3	24	146.2
25	151.4	26	156.7	27	159.8	28	162.2
29	165.5	30	167.9	31	171.3	32	173.8
33	177.8	34	179.9	35	183.5	36	186.2
37	189.9	38	192.8	39	196.6	40	199.3
41	203.5	42	206.5	43	210.7	44	218.1
45	225.7	46	229.1	47	233.6	48	241.8
49	250.3	50	254.1				