

---

# ALINCO

VHF/UHF FM TRANSCEIVER

# DR-635T/E

## Instruction Manual

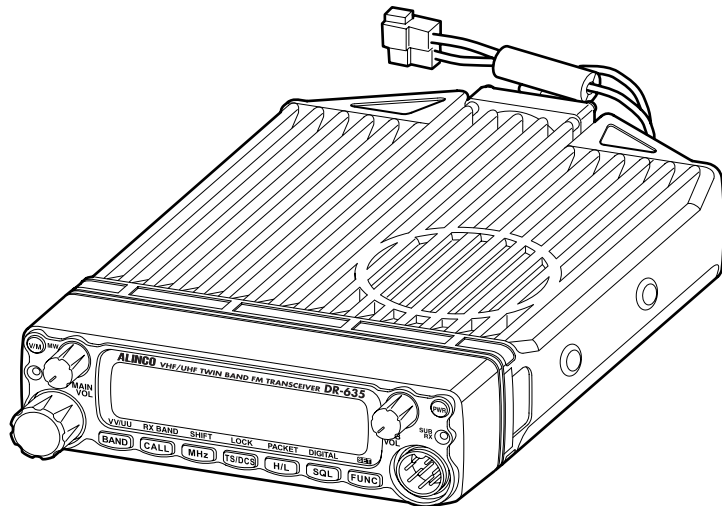

Thank you for purchasing your new Alinco transceiver.

This instruction manual contains important safety and operating instructions. Please read this manual carefully before using the product and keep it for future reference.

# NOTICE / Compliance Information Statement

This equipment has been tested and found to comply with the limits for a Class B digital device, pursuant to part 15 of the FCC Rules.

These limits are designed to provide reasonable protection against harmful interference in a residential installation. This equipment generates, uses, and can radiate radio frequency energy and, if not installed and used in accordance with the instruction manual, may cause harmful interference to radio communications. However, there is no guarantee that interference will not occur in a particular installation. If this equipment does cause harmful interference to radio or television reception, which can be determined by turning the equipment off and on, the user is encouraged to try to correct the interference by one or more of the following measures:

- *Reorient or relocate the receiving antenna.*
- *Increase the separation between the equipment and receiver.*
- *Connect the equipment into an outlet on a circuit different from that to which the receiver is connected.*
- *Consult the dealer or an experienced radio/TV technician for help.*



Tested to Comply  
With FCC Standards  
FOR HOME OR OFFICE USE

Information in this document is subject to change without notice or obligation. All brand names and trademarks are the property of their respective owners. Alinco cannot be liable for pictorial or typographical inaccuracies. Some parts, options and/or accessories are unavailable in certain areas. Changes or modifications not expressly approved by the party responsible for compliance could void the user's authority to operate the equipment.

VHF/UHF FM Transceiver DR-635T

This device complies with Part 15 of the FCC Rules. Operation is subject to the following two conditions: (1) This device may not cause harmful interference, and (2) this device must accept any interference received, including interference that may cause undesired operation.

Manufacturer:ALINCO,INC

Shin-Dai building 9th Floor 2-6, 1-Chome, Dojimahana, Kita-ku, Osaka 530-0004, JAPAN



Conformity Information

In case the unit you have purchased is marked with a CE symbol, a copy of relative conformity certificate or document can be reviewed at <http://www.alinco.com/usa.html>. Please see the back-cover for more details.

Copyright © 2005 All rights reserved. No part of this document may be reproduced, copied, translated or transcribed in any form or by any means without the prior written permission of Alinco. Inc., Osaka, Japan. English Edition Printed in Japan.

# Contents

---

<b>Before operating the transceiver .....</b>	<b>3</b>	Channel name (Alphanumeric) registration function .....	22
Attention .....	3	CALL mode .....	23
<b>Introduction .....</b>	<b>3</b>	To recall a CALL channel .....	23
<b>New and Innovative Features .....</b>	<b>4</b>	To receive signals .....	23
<b>Standard Accessories .....</b>	<b>5</b>	Monitor function .....	24
<b>Initial Installation .....</b>	<b>6</b>	Reverse function .....	24
For a base station set up .....	6	To transmit .....	25
For a mobile station set up .....	7	Selecting transmission power .....	25
Location .....	7	<b>Parameter Setting Mode .....</b>	<b>26</b>
Installing a Mobile Antenna .....	7	A list of the parameters .....	26
Installing the Transceiver .....	7	To use the parameter setting mode .....	27
Front Panel .....	8	Channel Step setting .....	28
External power control function .....	9	Scan Type .....	28
Power supply voltage display function .....	10	Beep Sound .....	28
<b>Part Names and Functions .....</b>	<b>11</b>	Time-Out-Timer (TOT) .....	29
Front Panel .....	11	TOT Penalty .....	29
Rear Panel .....	12	Setting the TOT penalty time .....	29
Display .....	13	APO-Auto Power OFF .....	30
Microphone EMS-53 (Standard) .....	14	Tone-Burst Frequency .....	30
<b>Basic Operations .....</b>	<b>15</b>	Clock shift .....	30
Turning the unit on and off .....	15	Bell .....	31
Switching the MAIN band .....	15	Busy-Channel-Lock-Out (BCLO) .....	31
Audio Volume level setting .....	15	Theft Alarm .....	31
Squelch level setting .....	15	TX display color .....	32
Squelch level setting on the SUB band ..	15	RX display color .....	32
VFO mode .....	16	Stand-by display color .....	32
Changing frequency by channel step .....	16	Dimmer .....	33
Changing frequency by 1 MHz step .....	16	Call sign setting (In packet operation) .....	33
Setting the channel step .....	17	Transmission speed setting (In packet operation) ...	34
Shift Direction and Offset frequency setting .....	18	Beacon interval setting	
Memory Mode .....	19	(In geolocating communication/A.P.R.S) .....	34
Recalling a memory channel .....	19	<b>Useful functions .....</b>	<b>35</b>
How to program memory channel (s) .....	20	Reception band switching .....	35
Memory channel deleting .....	21	V-V/U-U simultaneous reception .....	35
Programmable data in the memory channel ...	21	Single-band mode .....	36
		VFO Auto-program setting function .....	36
		SCANNING FUNCTION .....	37
		•VFO Scan .....	37
		•Memory Scan .....	38
		•Skip-channel setting .....	38
		•Program Scan .....	39
		•Tone Scan .....	39
		•DCS scan .....	40
		KEY-LOCK FUNCTION .....	40
		TONE BURST .....	40

Narrow-band mode .....	41
AM receiver mode .....	41
<b>Selective Communication .....</b>	<b>42</b>
Tone-squelch (CTCSS) and DCS .....	42
DET setting .....	43
Digital voice communication (DR-635T only) ..	44
<b>Special Functions .....</b>	<b>45</b>
THEFT ALARM .....	45
To connect, set and operate .....	45
How the alarm operates .....	46
Setting alarm starting time .....	47
Cable Clone .....	48
Connection .....	48
Setting on the Slave side .....	48
Setting on the Master side .....	49
Packet Communication .....	50
When using EJ-50U .....	50
Packet Mode Setting .....	51
APRS .....	52
APRS Settings .....	52
APRS operation .....	53
TNC Clone .....	54
Remote Control Operation (EMS-57 only) .....	55
List of Remote Control Keys .....	55
Entering a frequency directly .....	56
Entry method depending on tuning step ...	56
<b>Maintenance / Reference .....</b>	<b>57</b>
Reset .....	57
Factory Default Settings .....	57
Troubleshooting .....	58
Optional accessories .....	59
Transmitter Block Diagram .....	60
Specification .....	61

# Before operating the transceiver

---

## Attention

- Do not remove the case or touch the interior components. Tampering can cause equipment trouble.
- Do not use or keep the transceiver where it is exposed to direct sunlight, dusty places, or near sources of heat.
- Keep the transceiver away from TV's or other equipment when it interferes with reception.
- When transmitting for long periods of time at high power, the transceiver might overheat.
- Turn the power off immediately if the transceiver emits smoke or strange odors. Ensure the transceiver is safe, then bring it to the nearest Alinco service center.

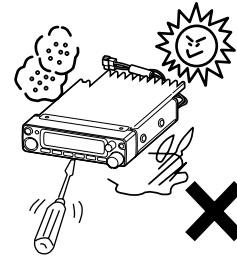

## Notice to California resident users

The Safe Drinking Water and Toxic Enforcement Act of 1986 of the State of California determines that lead and cadmium (used as raw materials in some of the components in this product) are considered carcinogens and reproductive toxicants. Although in the normal use of our products the risk of direct contact with such materials at hazardous level is minimal, please be advised that:

- (1) You should wash your hands after having contact with PVC (polyvinyl chloride) coated materials such as DC cables. PVC may contain lead or lead compounds.
- (2) Wash your hands after having contact with soldered parts. Solder used for the assembly of our products may contain lead or lead compounds.
- (3) Do not directly touch any liquid that may leak from the Nickel Cadmium rechargeable cells. The liquid may contain cadmium.
- (4) Avoid oral contact with any part of our products. If this should occur, rinse the mouth with plenty of water. Consult a doctor if you are unsure if the exposure may have reached hazardous levels.
- (5) Keep our products away from the reach of children. Our products may contain small parts that may cause suffocation, or other consequences, if swallowed.
- (6) Our products are designed for two-way communication purposes only. Any eventual consequences arising from hazardous contacts with defined material(s) caused by misuse of our products are considered to be the user's fault. Please read the instruction manual of this product carefully before use.
- (7) Please dispose of or recycle our products properly in accord with your local regulation(s).
- (8) The user assumes the risk for exposure to chemicals/materials at hazardous levels caused by the use of peripherals or accessories made by third-parties and used in conjunction with our products.

## Introduction

---

Thank you very much for purchasing this excellent Alinco transceiver. Our products are ranked among the finest in the world. This radio has been manufactured with state of the art technology and it has been tested carefully at our factory. It is designed to operate to your satisfaction for many years under normal use.

PLEASE READ THIS MANUAL COMPLETELY TO LEARN ALL THE FUNCTIONS THE PRODUCT OFFERS. WE MADE EVERY ATTEMPT TO WRITE THIS MANUAL TO BE AS COMPREHENSIVE AND EASY TO UNDERSTAND AS POSSIBLE. IT IS IMPORTANT TO NOTE THAT SOME OF THE OPERATIONS MAY BE EXPLAINED IN RELATION TO INFORMATION IN PREVIOUS CHAPTERS. BY READING JUST ONE PART OF THE MANUAL, YOU RISK NOT UNDERSTANDING THE COMPLETE EXPLANATION OF THE FUNCTION.

# New and Innovative Features

---

Your new radio features some of the most advanced functions and reliable engineering available anywhere. The ALINCO design philosophy is focused on developing innovative usable features, including the following:

- Full-duplex operation and Cross-band repeat function\*.
- A large, color-selectable display panel  
Very clear display of frequency, memory name etc. ensure convenient operation.
- Excellent frequency stability  
By using a temperature compensated crystal oscillator (TCXO), deviation less than +/- 2.5ppm is realized.
- V-V/U-U function  
Simultaneous reception of 2 signals within the same band is possible (Excluding the FM broadcast band).
- High-quality materials are used throughout the product and a huge heat sink around the chassis ensures stable and durable operation.
- AM Air-band reception capability (T models only)
- 200 fully programmable memory channels with alphanumeric memory channel labels
- CTCSS, DCS and 5 different Tone-Bursts are standard for selective calling and repeater access worldwide.
- Applicable for Packet communication (With the optional EJ-50U installed)
- Theft Alarm feature
- Auto-Programming VFO for easier repeater access
- Cable-Clone function
- Power supply voltage display function
- Narrow-FM mode
- Microphone remote control function (EMS-57 microphone may be an option depending upon the version you purchased.)
- Front-Control unit separation

\* Where permitted.

# Standard Accessories

Carefully unpack to make sure the following items are found in the package in addition to this manual:

- Transceiver

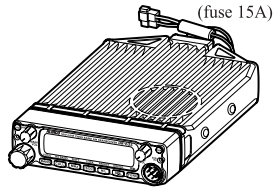

- Microphone EMS-53 or EMS-57 (with DTMF keypad)

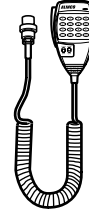

- DC power cable with fuse holder (UA0038)

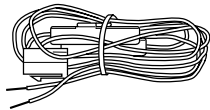

- Mobile mounting bracket. (FM0078Z)

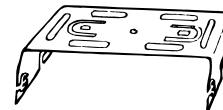

- ACC cable (UX1290A)



- Hardware kit for bracket

Black screws (M4\*8mm)  
4pcs. (AE0012)



Tapping screws  
(M5\*20mm) 4pcs. (AJ0003)



Screws (M5\*20mm)  
4pcs. (AA0013)



Washer (AZ0010)  
S-washer (AZ0009)



- Theft Alarm stickers 2pcs. (PR0454)
- Instruction manual (this manual)
- Warranty certificate (T version only) (PH0009A)
- EJ-50U manual & disc (with TNC version only)

Hexagonal nut (M5) 4pcs.  
(AN0002)



Small (spanner) wrench.  
(FM0079)



Spare fuses (a pair)  
2pcs. (EF0005)

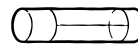

The standard accessories may vary slightly depending on the version you have purchased. Please contact your local authorized Alinco dealer should you have any questions. ALINCO and authorized dealers are not responsible for any typographical errors there may be in this manual. Standard accessories may change without notice.

## Warranty Policy:

Please refer to any enclosed warranty information or contact your authorized Alinco dealer / distributor for the warranty policy.

# Initial Installation

---

Connect the microphone to the front panel of the transceiver.

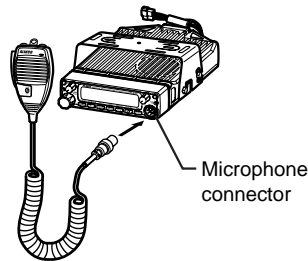

Connect antenna port to a 50 ohm antenna that covers the 2 m/70 cm bands, using good quality 50 ohm coaxial cable.

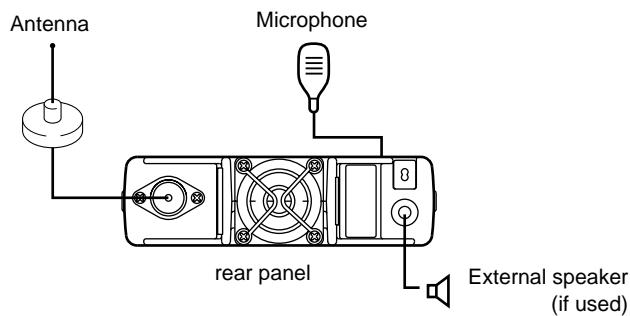

## For a base station set up

The Transceiver requires a 12-13.8VDC negative grounded power source. Use a regulated power supply capable of providing continuous current of 12A or more. Power supplies that do not meet those specifications may cause malfunction and/or damage to the radio and will void the warranty. Alinco offers excellent communication-grade power supplies as optional accessories. Please contact your local authorized Alinco dealer.

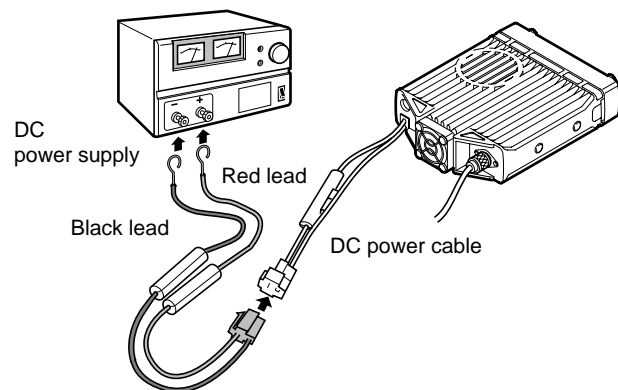



## For a mobile station set up

### Location

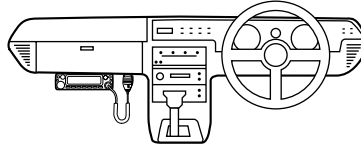

The transceiver may be installed in any position in your car, where the controls and microphone are easily accessible and it does not interfere with the safe operation of the vehicle or the performance of the set. If your vehicle is equipped with air bags, be certain your radio will not interfere with their deployment. If you are uncertain about where to mount the unit, contact your vehicle's manufacturer. Please refer the next page for positioning the front control unit.

### Installing a Mobile Antenna

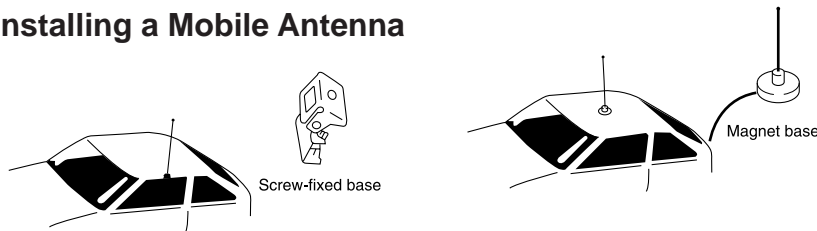

Use a 50 ohm coaxial cable to connect the antenna. Mobile antennas require an appropriate mounting base for proper installation and operation. For more information, see the documentation for your antenna.

**IMPORTANT:** After installing your antenna, ensure that you have the best possible SWR reading. High RF environments can cause severe damage to your unit. Ensure that you are not in a high RF environment when operating the transceiver.

### Installing the Transceiver

See the figures below.

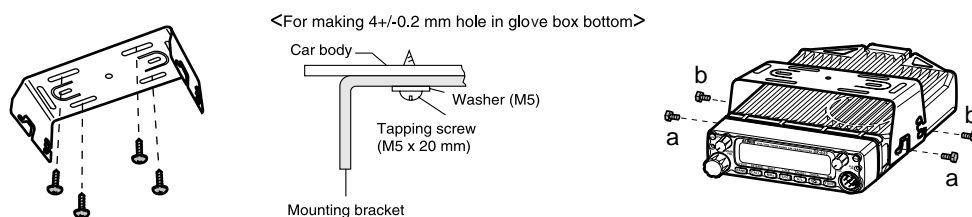

\*Use provided screws only(M4 x 8mm) to fix the bracket. Irregular screws may damage the circuit-board inside.

## Front Panel

The main unit can be set with either side facing up. This can facilitate your ability to hear the speaker clearly. Position the front panel as you prefer.

1. Slide the front panel while keeping the tab pressed.

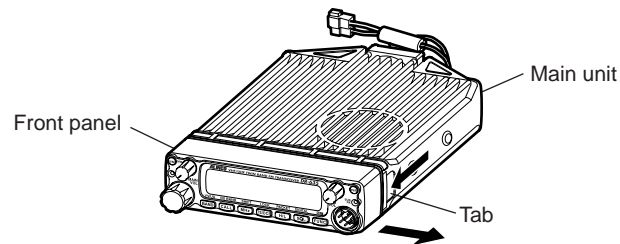

2. Turn the front panel, being careful to keep the cable free from kinks.

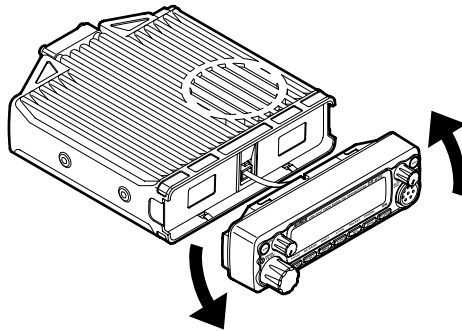

3. Match the catch in the main unit with the slot in the front panel and fit the front panel into the main unit.

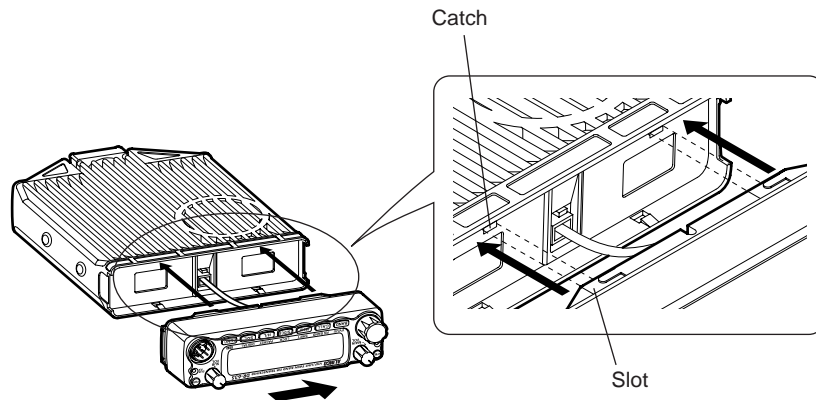

4. Slide the front panel until it locks securely in place.

**NOTE:** By using the optional separation kit EDS-9, you can use the front panel and the main unit in separate positions. The instruction manual for remote placement is provided with the EDS-9.

## External power control function

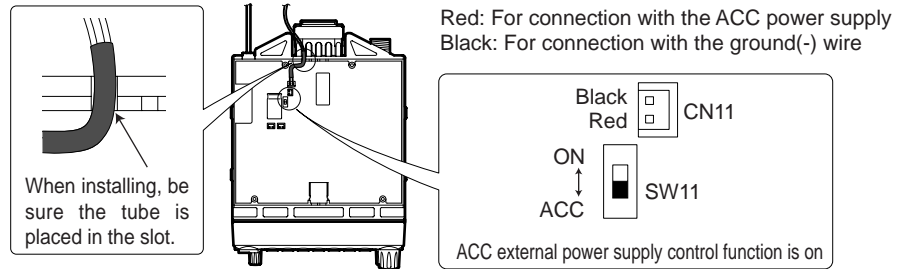

**WARNING:** The connection of cables may involve certain knowledge about the vehicle into which the unit will be installed. Consult with your car-dealer or service station for more information if necessary, as we are not responsible for any damage this installation might cause to your vehicle.

1. Be sure the vehicle has a negative-ground, 12VDC electric system before installation. Connect the provided DC cable with fuse-holder directly to the battery (red cable to the positive terminal) to minimize any possible ignition noise. Be sure the vehicle has a large capacity battery as the use of a transceiver may overload the electric system of the vehicle.
2. In addition, if the optional ignition-key ON/OFF feature is desired, use the provided ACC cable. Remove the cover by unscrewing 4 screws. Connect the ACC cable to the ACC power jack (CN11) on the rear side of the circuit board unit, position the outgoing cable as shown above, select the ACC switch (SW11) to ACC position and reassemble the cover.
3. When installing, be sure to disconnect the battery cables of the vehicle and be sure the ignition key is in the "OFF" position. Connect the ACC cable to the ACC terminal or ACC switch on the vehicle. Make sure the above sequence has been done properly. Reconnect the vehicle's electric system.
4. If this option is selected, the unit can be turned on/off either manually or automatically in accordance with the ignition key position.
  - A: When the ignition key is turned to ACC or ON ("run") position with the unit left turned ON, the unit will turn on automatically and turns OFF when the ignition key is turned to the OFF position.
  - B: To manually turn the power on/off, leave the ignition key in the ACC position and use the PWR switch on the unit. If the ignition key is in the OFF position the unit won't turn on. The power consumption of this feature is about 5mA regardless of the ignition key position. For operation without this option, always use the PWR switch to turn the unit on/off and set SW11 to "on".

## Power supply voltage display function

After connecting the transceiver to a power supply, the supply voltage can be confirmed by pressing the SQL key together with the FUNC key. The supply voltage to the transceiver is then seen on the display.

The transceiver will return to its normal display when any key is pressed.

The display immediately changes as the voltage supply changes.  
It also displays voltage during transmission.

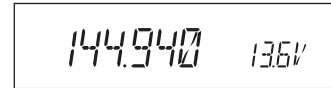

(Example) In case of 13.6V

**IMPORTANT:** The range of the displayed voltage is only from 7 - 16VDC. Because the displayed value is estimated, please use a voltmeter when a more precise reading is desired.

# Part Names and Functions

## Front Panel

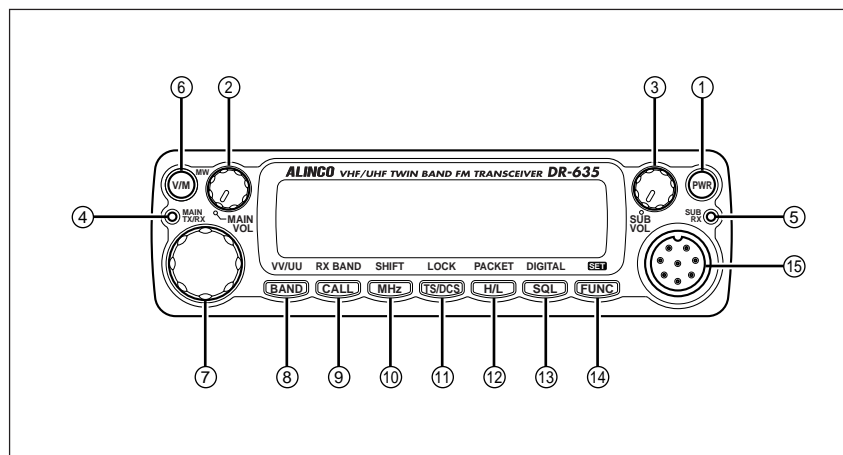

### •Primary Functions

No.	Key	Function
1	PWR key	Power turns ON/OFF whenever switch is pressed.
2	Main VOL knob	Adjusts the volume level on the MAIN band.
3	Sub VOL knob	Adjusts the volume level on the SUB band.
4	Main TX/RX indicator	During transmission on the MAIN band, illuminates in Red, and during reception illuminates in Green.
5	Sub RX lamp	During reception on the SUB, illuminates in Green.
6	V/M/MW	Switches between VFO mode and memory mode.
7	Dial	Changes the frequency, memory channel and various settings.
8	BAND/VVUU	Switches the MAIN band to VHF or UHF.
9	CALL/RX BAND	Switches to CALL Mode.
10	MHZ/SHIFT	In VFO mode, changes frequency in 1 MHz steps.
11	TSDCS/LOCK	Sets the tone squelch and DCS setting.
12	HL/ PACKET	Switches HI/MID/LOW of transmission power.
13	SQL/DIGITAL	Sets the squelch level.
14	FUNC/SET	Sets functions.
15	Mic. Connector	Connection for the provided microphone.

### •Functions which can be activated while [F] appears, after pressing the FUNC Key

No.	Key	Function
6	V/M/MW	Write a to memory channel.
8	BAND/VVUU	Switches to VV/UU mode.
9	CALL/RXBAND	Switches reception bands.
10	MHZ/SHIFT	Sets the shift direction and the offset frequency.
11	TSDCS/LOCK	Sets the key lock function.
12	HL/PACKET	Accesses the packet communication mode or the geolocating communication mode.
13	SQL/DIGITAL	Accesses the digital voice communication mode.

\* [F] illuminates when the FUNC key is pressed.

• **Functions that can be activated while pressing the FUNC Key**

No.	Key	Function
1	PWR	Reset to factory default settings.
5	V/M/MW	Erase the memory.
8	BAND/VVUU	Switches to the single band mode.
9	CALL/RXBAND	Accesses the clone function mode.
10	MHZ/SHIFT	Switches to wide/narrow mode reception.
11	TSDCS/LOCK	Switches to the AM reception mode.
12	HL/PACKET	Sets the channel name function.
13	SQL/D	Accesses the power supply voltage indication mode.

• **Functions that require continuous pressing to be activated.**

No.	Key	Function
13	SQL/DIGITAL	When pressed for 1 second, the monitor function is on. (When the shift is set, the reverse function is on.)
14	FUNC/SET	When pressed for 2 seconds, accesses the set mode.

**Rear Panel**

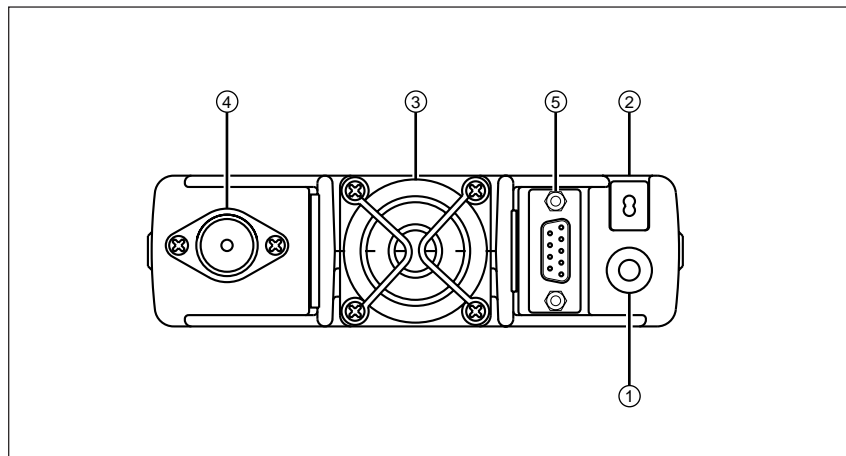

No.	Key	Function
1	External Speaker Terminal	Terminal for optional external speaker. (Also used for the clone function.)
2	Power cable	Connects to the 13.8VDC power supply.
3	Air-cooling fan	Turn on while PTT is being pressed or when the unit is hot.
4	Antenna Connector	Connect an antenna with 50 ohm impedance. (PL-259 or compatible)
5	D-SUB Connector (Optional)	Connects to a personal computer for packet use.

## Display

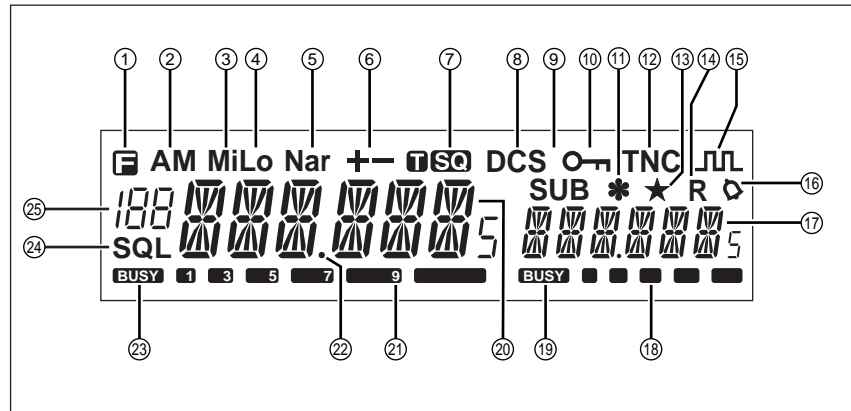

No.	Key	Function
1		Appears when FUNC Key is pressed.
2	AM	Appears during AM reception.
3	Mi	Appears when transmission power is set to MID.
4	Lo	Appears when transmission power is set to LOW.
5	Nar	Appears when in narrow band reception mode.
6	+/-	Appears when setting the shift.
7		Appears when setting the tone squelch.
8	DCS	Appears when setting the DCS.
9	SUB	Appears when SUB band is on the MAIN side.*
10		Appears when setting the key lock.
11	*	Appears when setting the theft alarm function.
12	TNC	Appears when in packet mode (Optional EJ-50U required).
13	★	Appears when SUB band is in the memory mode or call mode.
14	R	Appears when the reverse function is activated.
15		Appears when in the digital voice communication mode.**
16		Appears when setting the bell (pager) function.
17		Indicates the frequency or memory name on the SUB side
18	S Meter	Indicates the relative signal strength level of transmission/reception on the SUB side.
19		Appears when a signal is being received on the SUB side.
20		Indicates the frequency or memory name on the MAIN side.
21	S Meter	Indicates the relative signal strength level of transmission/reception on the MAIN side.
22	.Decimal point	Appears when changing the DCS decode settings. Disappears when setting Memory Channel skip.
23		Appears when a signal is being received on the MAIN side.
24	SQL	Appears when setting the squelch level.
25		Indicates memory numbers in the memory mode.

\*SUB band is the band exclusive for reception when in V-V/U-U.

\*\* T version only. Optional EJ-47U required.

## Microphone EMS-53 (Standard)\*

\*If the version you have purchased contained EMS-57 Multi-function microphone, please also refer page 55.

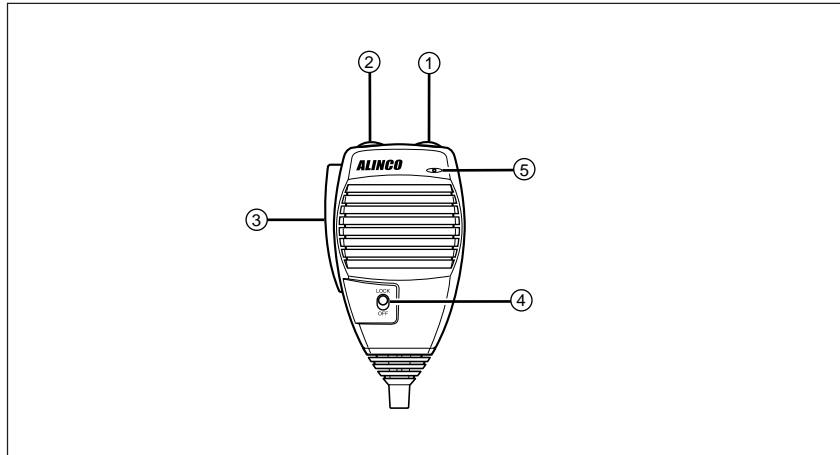

No.	Key	Function
1	UP	Increase the frequency, memory channel number, or setting value.
2	DOWN	Decrease the frequency, memory channel number, or setting value.
3	PTT	Press the PTT(Push-To-Talk)key to transmit.
4	Lock Switch	Locks out the UP and DOWN keys.
5	MIC	Speak here during transmission.

### Mic. Connector Diagram (While looking in the front view of the connector)

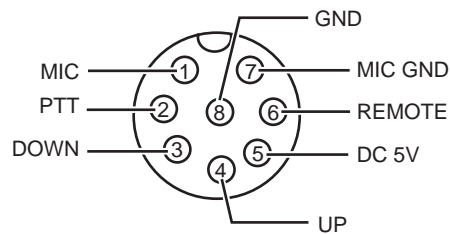



# Basic Operations

## Turning the unit on and off

By pressing the PWR key the power is turned on. By pressing the PWR key again, the power is turned off. Refer page 9 for external power control.

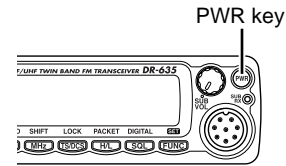

## Switching the MAIN band

Pressing the BAND key will switch the MAIN band between the VHF band and the UHF band.

The MAIN band allows transmission and reception. The SUB band only allows reception. The MAIN band and the SUB band can receive simultaneously.

**IMPORTANT:** On the SUB side, no settings other than the frequency and S meter are indicated.

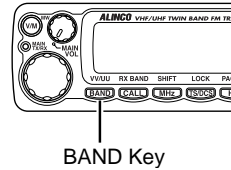

## Audio Volume level setting

The volume of the MAIN band is adjusted by the VOL knob on the MAIN side, and the volume of the SUB band by the VOL knob on the SUB side.

Rotate the VOL knob clockwise to increase the audio level, counterclockwise to decrease.

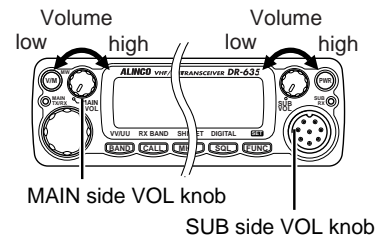

## Squelch level setting

Adjust threshold level of the squelch. A squelch eliminates the background noise when a signal is not received. To set squelch level on the MAIN band side,

1. Press SQL Key.  
[SQL] icon appears on the display and the squelch level will be shown on it.
2. By rotating the main dial or by using the UP/DOWN keys on the microphone, adjust the squelch level to the desired level.
3. When completing the setting, press PTT or any key on the front panel other than the Band key. Then the display will return to the original status; or if there are no operations for 5 seconds, the unit will automatically complete the setting and the display will return to the original status.

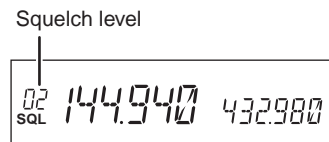

## Squelch level setting on the SUB band

To set the squelch level on the SUB band, press the BAND key while [SQL] appears.

**NOTE:**

- 21 levels, between (00) and (20), are available for the squelch level. (Higher level settings will make the squelch more difficult to open.)
- The default level is 02.

## VFO mode

VFO tuning is set as the default mode at the factory. VFO (variable frequency oscillator) allows you to change the frequency in accordance with the selected channel step as you rotate the main dial or by using the UP/DOWN keys on the microphone. VFO mode is also used to program the data to be stored in the memory channels or to change the parameter settings of the transceiver.

1. Identify the current mode by checking the display. If a “M” or “C” icon is NOT displayed on it, the unit is already in the VFO mode. If memories have not been programmed, the unit cannot be switched to the memory mode.
2. Otherwise press “V/M” key until those icons are gone.

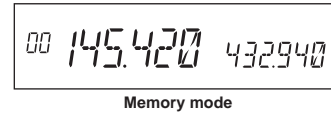
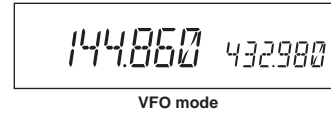

### Changing frequency by channel step

Rotate the main dial clockwise to increase the frequency, counterclockwise to decrease. The UP/DOWN keys on the microphone act in the same way.

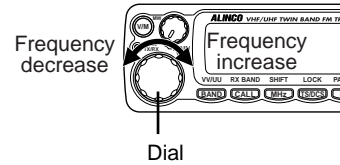

### Changing frequency by 1 MHz step

This will enable a quick change of frequency in 1 MHz steps:

1. Press MHz key. The digits after 100 kHz will disappear from the display.
2. Follow the same sequence as above to change the value.

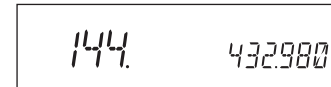

## Setting the channel step

1. When the unit is in VFO mode, enter into the SET mode and select the channel step setting display. (Refer to page 26 to 28 for SET mode).
2. The current channel step will be displayed.
3. You can change the channel step as below by rotating the dial.



Channel step setting display (default)



4. Pressing any key other than the FUNC key or SQL key on the unit will complete the setting and the display will return to the original status.

**IMPORTANT:** By changing the channel step frequency, settings below 10kHz may be automatically corrected.

## Shift Direction and Offset frequency setting

Conventional repeaters are operated in the DUPLEX mode, which receives an incoming signal on one frequency and re-transmits on another. The difference between these two frequencies is called the offset frequency. The offset is variable between 0 to 99.995MHz on this unit.

1. After pressing the FUNC key, and pressing the MHz key while [F] appears on the display, the display will show the current status of the offset frequency and the shift direction. By repeatedly pressing the MHz key, shift direction will be changed as shown to the right.

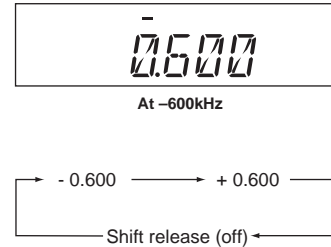

2. By rotating the dial (or by pressing the UP/DOWN key) while the shift frequency is displayed, one click will change the frequency by one channel step.
3. After pressing the FUNC key, rotating the dial will change the frequency by 1MHz depending on which direction the dial is rotated (or if the Mic UP/DOWN key is pressed).
4. Pressing the PTT key or the V/M key will complete the setting and the display will return to the original status.

## Memory Mode

This mode allows recalling and operating the preprogrammed frequency or setting. This unit provides up to 200 memory channels (80 exclusive channels each for VHF and UHF, from 00 to 79CH and 40 common channels for VHF and UHF, from 100 to 139), 1 CALL channel each for V and U (C), 1 program-scan edge memory channel each for V and U (PL) (PH) and 1 VFO automatic program setting channel (AL) (AH).

### Recalling a memory channel

1. Select the memory mode by pressing V/M key. [00] appears on the display to indicate that the unit is in the memory mode. Repeat to switch between memory and VFO.
2. Select a memory channel. Rotating the main dial (or by pressing the UP/DOWN Mic keys) will increase or decrease a memory channel number by 1 channel step. For recalling a memory on the SUB band, first switch the MAIN band by pressing the BAND key. When the SUB side is in the memory mode or CALL mode, [★] appears on the display.

When recalling any memory number between 100 and 139, the display on the SUB side will disappear.

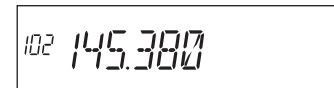
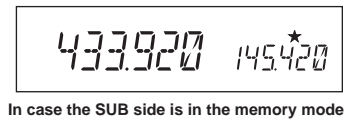
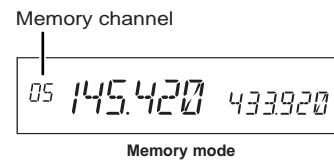

**IMPORTANT:** If memory channels have not been programmed, the unit will not be switched to the memory mode by pressing V/M key. Please read memory channel programming on the next page.

## How to program memory channel (s)

1. Select a frequency to be programmed in the VFO mode and set the parameters as appropriate. Refer to the next page for programmable parameters.
2. By pressing FUNC key, [F] and [Memory No.] icons will appear on the display.
3. Rotate the main dial (or press Mic UP/DOWN key) to select the desired memory channel number.
4. An empty channel is shown with a flashing [Memory No.] icon.
5. By pressing V/M key while [F] icon is on the display, programming will be completed and you will hear a beep sound.
6. If a previously programmed channel is selected in step 3, the memory channel will be overwritten by executing the procedure in step 5.
7. When CH-C is selected, the CALL channel will also be rewritten.

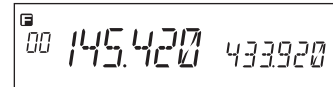

**IMPORTANT:**

- Program the Theft-Alarm frequency in CH99.
- For Channels from 100 to 139, the VHF/UHF band can be programmed indiscriminately (VHF/UHF mixed scanning is possible by memory program scanning.).
- The memory channels can't be edited (programming/deleting) while SUB icon appears on the display. Please change the sub-band frequency to turn it off.

## Memory channel deleting

1. Select the memory mode by pressing the V/M key.
2. Select the desired memory channel number by rotating the main dial.
3. The programmed memory channel has the memory number illuminated on the display.
4. By pressing the M/W key together with the FUNC key while [F] icon is on, a beep will sound and the memory will be deleted. At the same time, [Memory No.] icon will start flashing.

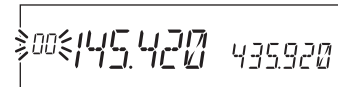
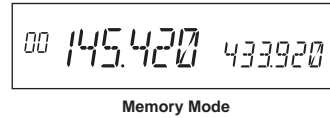

**NOTE:** When an LCD memory channel is flashing, the full contents of the memory are displayed in the LCD.  
After pressing FUNC key again, if you press M/W key while [F] icon is on, you can restore a deleted memory. However, after changing CH or the mode, restoration will not be possible.

## Programmable data in the memory channel

Each Memory channel including 00 – 99, 100 – 39, CALL channel and AL, AH, PL, PH channel can store following:

- Frequency
- Shift frequency
- Shift direction (+ / -)
- Tone encoder frequency
- Tone decoder frequency
- Tone encoder/decoder setting
- DCS encoder code
- DCS decoder code
- DCS setting
- Skip CH setting
- Busy channel Lock Out (BCLO)
- Digital mode setting
- Digital code
- Narrow mode setting
- AM mode setting
- Clock shift setting

## Channel name (Alphanumeric) registration function

The memory channels stored in the memory mode can be displayed with an alphanumeric tag instead of the default frequency display. There are 67 characters available including A-Z, 0-9.

1. In the memory mode, select a channel to be programmed.



2. Press the H/L key together with the FUNC key.

3. The display shows [A ] flashing.

4. Rotate the dial to select a character to be programmed.

5. By pressing the BAND key, the character stops flashing and is entered.  
An identical character to the one just entered flashes on the immediate right ready to be edited.

6. Enter the next character with the BAND key.  
(Repeat the same sequence)



7. Pressing the CALL key during programming will delete all characters to be programmed.

8. Pressing any key other than the BAND key and the CALL key will complete the setting and the display will return to the original status.

**NOTE:** In the memory mode, a designated alphanumeric tag is displayed instead of the frequency for a channel with a designated channel name (CH number is displayed unchanged). By pressing the FUNC key for 5 seconds, the frequency will be displayed.  
(By pressing any key during operation, the display will return to show the channel name. But by operating a key designated for some FUNC key, the unit will enter the designated setting mode.)



## CALL mode

This is a memory mode that allows the transceiver to quickly recall the assigned memory channel by simply pressing the CALL key, regardless of the current status of the unit.

The default setting is 145.00MHz/433.00MHz, and one CALL channel is available on each band.

## To recall a CALL channel

Select the desired VHF or UHF band by pressing the BAND key.

1. Press the CALL key. The C icon appears on the display and the transceiver enters the CALL mode. In this mode, the main dial or the Mic UP/DOWN keys cannot change the frequency or memory channels.
2. Press CALL key again or press V/M key to exit CALL mode.
3. No scan functions are available in the CALL mode.



To store a desired setting in the CALL channel, follow the memory mode programming instructions and assign your selected settings to memory channel C. The call channel can be modified but cannot be eliminated or hidden.

NOTE: The access to call mode is prohibited while mixed memory (CH100-139) mode is selected. Scanning is disabled in CALL mode.

## To receive signals

1. Be sure to have the unit connected to the appropriate antenna, powered on, set the audio volume and squelch level properly on both the MAIN and SUB bands.
2. Select the desired band by pressing the BAND key and browse frequencies or select desired frequency to listen to ongoing communications. The S-meter shows relative signal strength when the transceiver detects an incoming signal, and the RX display lamp (green) turns on.
3. If the S-meter indicates an incoming signal but nothing is heard from the speaker, check the audio level, squelch level, and CTCSS/DCS decoding status, which are explained elsewhere in this manual.

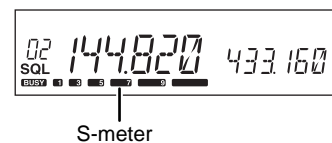

## Monitor function

A Monitor function is available to receive weaker signals. Press and hold SQL key for more than 1 second. Regardless of the level setting of the squelch, it will be opened and the Busy icon/RX lamp will turn on in the display. Press any key on the front panel to exit.



**IMPORTANT:** The Monitor function only operates on the MAIN band. The Monitor function operates irrespective of Tone squelch/DCS function setting.

## Reverse function

This function is for monitoring the transmission frequency instead of receiving frequency in repeater operation. This technique is commonly used to check if it is possible to communicate without using a repeater by monitoring the accessing station's signal strength.

1. Keep pressing the SQL key for more than 1 second while SHIFT is set. [R] icon illuminates on the display to indicate that the reverse function is activated and the squelch opens.
2. Pressing any key will cancel the operation.

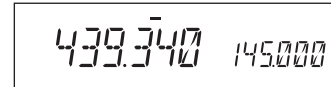

When -5.000MHz SHIFT is set

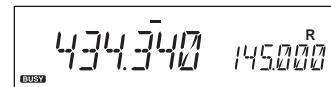

## To transmit

1. Set the transmission band to the MAIN side.
2. Be sure that you are authorized to operate on the selected frequency. Check the system and monitor the frequency to make sure that you are not going to disturb any ongoing communications.
3. Press the PTT key on the microphone. The TX lamp (red) illuminates to show the unit is transmitting. If the receiver's frequency combination is VHF amateur/accessory RX band such as Air-band or FM broadcasting, the sub-band RX mutes due to the nature of receiver circuit design.
4. Speak into the microphone in a normal tone while keeping the PTT key pressed. Hold the microphone approximately 5cm away from your mouth. Speaking too close or too loud may result in poor transmitted audio.
5. Releasing the PTT key will complete the transmission and the unit will return to the receive Mode.

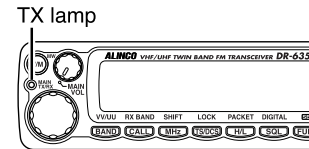

**NOTE:** Pressing the DOWN key together with the PTT key will transmit the CALL tone signal. DR-635E will transmit the Tone Burst signal. See page 39 for details.

The following operation is possible for sub-band while transmitting on the main side: • Dial • V/M key • CALL key • MHz key • SQL key

**IMPORTANT:** If you press the PTT key in out-of-TX frequency range, the [OFF] icon will appear on the display and no transmission will occur. Check the frequency and/or the offset setting.

## Selecting transmission power

1. Press the H/L key. The transmission power switches from Hi to Mid, Mid to Lo and then Lo to Hi. At MID power, the [Mi] icon, and at LOW power, the [Lo] icon illuminates. Nothing appears on the display at Hi power. The default is HI power. The RF meter shows •• when transmitting at LOW power, •••• at MID power and •••••• at HI power.

Transmission power	635T/E	
	VHF	UHF
HI	50W	35W
MID	20W	20W
LOW	5W	5W

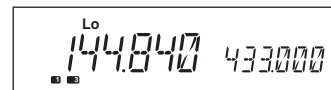

At LOW power



At MID power



At HI power

**IMPORTANT:** While operating with High-power output setting, when the internal temperature exceeds certain level, a protection circuit turns the TX power automatically to MID setting (it resumes high setting automatically when cool down).

# Parameter Setting Mode

**IMPORTANT:** Please read the following pages thoroughly prior to changing any parameters.  
**THE PARAMETERS CANNOT BE SET WITHOUT ENTERING THE SET MODE.**

By entering the Parameter Setting mode, some of the radio's operating parameters can be changed to suit your application. The following is the Selectable Parameters' Menu.

**NOTE:** The Alphanumeric Channel Tag setting will not appear in the menu until memories have been programmed first!

## A list of the setting mode Parameters

Cut and keep the following list of the setting mode parameters for your convenience.

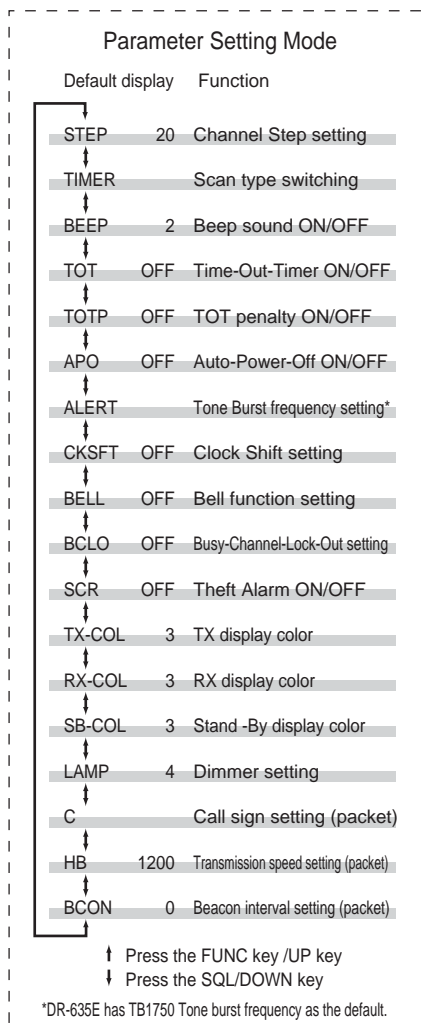

## To use the parameter setting mode

1. Press the FUNC key for more than 2 seconds to enter the parameter Setting mode.
2. Select a menu by pressing the FUNC key and the SQL key, or UP/DOWN keys on the microphone.
3. Rotate the main dial to change the setting.
4. Pressing the FUNC/SQL and UP/DOWN key will complete the setting and enter the next menu.
5. Pressing any key other than the FUNC/SQL or the UP/DOWN key will complete the setting and the unit will exit the parameter setting mode.



Default display

## Channel Step setting

This is to select the channel step to be used in the VFO mode. Refer to the chart below for the sequence of the actual steps and how they are displayed.

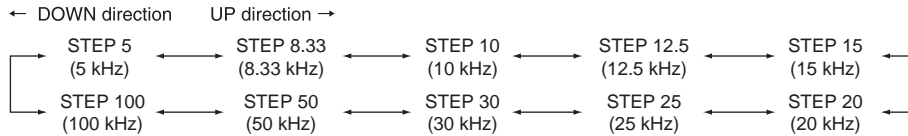

NOTE: The default is as follows.

- DR-635E [STEP 12.5]
- DR-635T [STEP 5]

## Scan Type

This is to select the scan resume condition. The TIMER setting allows the radio to resume scanning after 5 seconds, regardless of the signal receiving status. The BUSY setting resumes scanning when the received signal is gone. The scan mode is explained later.

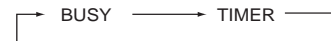
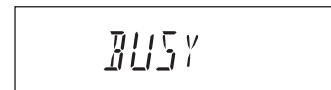

## Beep Sound

This is to change the volume of a beep sound during operation.

1. The [BEEP2] icon appears on the display.
2. By rotating the dial, the display will change as below and the volume of the beep sound will be changed.

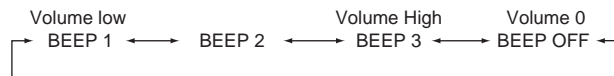
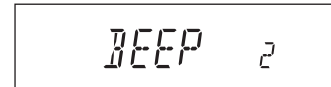

(Refer page 27 for how to enter the setting mode.)

## Time-Out-Timer (TOT)

The TOT feature is popular in repeater systems. It prohibits users from transmitting on the repeater after a certain period of time has elapsed. By setting this function and activating it according to the repeaters' requirement, the radio alerts the user by a beep 5 seconds prior to time-out. When the time is expired, transmitting stops and the transceiver automatically returns to the receiving mode. This avoids the repeater going into its TOT mode. Until the PTT is released once and pressed again, the transceiver will not transmit.

1. In this Menu, the default display shows TOT-OFF.



2. Rotate the main dial to select the desired time-out time. The display should change as shown. The number followed by TOT is the time-out time in seconds. The TOT feature is selectable up to 450 seconds (7.5 minutes).



During the setting time of 60 seconds

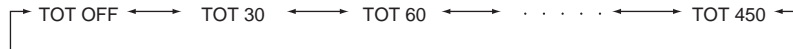

## TOT Penalty

When transmission is shut down in the TOT mode, this function prohibits another transmission during a selected TOT penalty period regardless of the PTT key being pressed. A beep sounds when the PTT key is pressed during the TOT penalty period. If the PTT is continuously pressed over both TOT and the TOT penalty period, this function will be automatically cancelled.

### Setting the TOT penalty time

1. The [TOTP OFF] icon appears on the display.



2. By rotating the main dial, the display changes as below and TOT penalty setting is changed. The penalty time can be set up to 15 seconds.



In case the setting time is 5 seconds

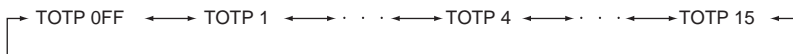

## APO-Auto Power OFF

This feature will automatically shut off the transceiver. It is useful in mobile operation to avoid draining the car battery. If there is no activity or use of the radio, it will turn off automatically after 30 minutes followed by a beep sound.

1. Default is APO-OFF.



2. Rotate dial to select APO-ON to activate the function.



During the ON setting

## Tone-Burst Frequency

This is to access Tone-Burst repeaters which require a certain pitch of audible tone to activate “sleeping” repeaters. Usually, a repeater system does not require the tone once the repeater is activated.

Tone Burst frequency can be set to ALERT, 1750Hz, 2100Hz, 1000Hz and 1450Hz.  
(ALERT is an intermittent recalling sound)

1. The [ALERT] icon appears on the display.

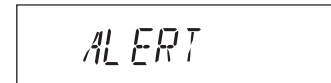

2. By rotating the main dial, the display changes as below and Tone Burst frequency setting is changed.

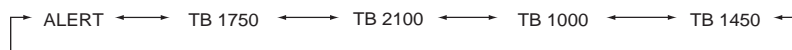

## Clock shift

In the unlikely event that CPU clock noise is present on a particular operating frequency programmed into the radio, you can shift the CPU clock frequency to avoid the CPU clock noise, which normally is so weak that it is inaudible even if the radio is tuned exactly to its frequency.

1. [CKSFT OFF] icon appears on the display.

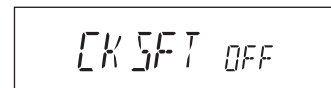

2. By rotating the main dial, the display changes as shown and the Clock shift setting is changed.

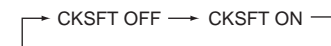



(Refer page 27 for how to enter the setting mode.)

## Bell

The bell informs you that you are being called by sounding a bell, and flashing the bell icon on the display.

1. [BELL OFF] icon appears on the display.

2. By rotating the main dial, the display changes as shown and the Bell function setting is changed.

## Busy-Channel-Lock-Out (BCLO)

This function prohibits transmission as long as there is a signal on the receiving frequency. The default is BCLO-OFF, which is the off position. By activating this function, the radio transmits only when:

1. No signal is received (BUSY icon is gone) on the receiving frequency.
2. The tone-squelch is not opened by receiving the corresponding CTCSS tone.
3. As above, with DCS code.

Otherwise a beep sounds but the unit does not transmit even when the PTT is pressed.

1. The [BCLO OFF] icon appears on the display.

2. By rotating the main dial, the display changes as shown and BCLO setting is changed.

## Theft Alarm

(Please refer page 45 for details)

1. The [SCR OFF] icon appears on the display.

2. By rotating the main dial, the display changes as shown and Theft Alarm is set ON/OFF.

3. When Theft Alarm is set, [\*] icon appears on the display.

## TX display color

This is to select the display illumination color during the transmission.

1. The [TX-COL] appears on the display.



2. By rotating the main dial, the display changes as shown on the right and the illumination color is changed.

TX-COL 1 : Red (amber)  
 TX-COL 2 : Blue  
 TX-COL 3 : Violet

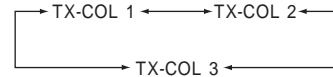

## RX display color

This is to select the display illumination color while receiving.

1. The [RX-COL] appears on the display.



2. By rotating the main dial, the display changes as shown on the right and the illumination color is changed.

RX-COL 1 : Red (amber)  
 RX-COL 2 : Blue  
 RX-COL 3 : Violet

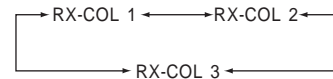

## Stand-by display color

This is to select the display illumination color during the stand-by status (listening but no signal is being received).

1. The [SB-COL] appears on the display.



2. By rotating the main dial, the display changes as shown on the right and the illumination color is changed.

SB-COL 1 : Red (amber)  
 SB-COL 2 : Blue  
 SB-COL 3 : Violet

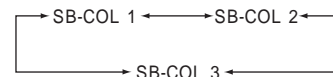

(Refer page 27 for how to enter the setting mode.)

## Dimmer

This is to provide better visibility of the display by dimming the display illumination in the dark.

1. The [LAMP 4] icon appears on the display.



2. By rotating the main dial, the display changes as below and the Dimmer setting is changed. It is bright when set to LAMP 4 and will be darker with 3-2-1.

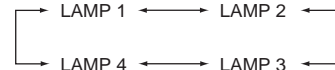

## Call sign setting (In packet operation)

This is to register the call sign of your station to transmit in the Packet communication mode. 36 characters, A - Z and 0 - 9 are available for registration.

1. The display shows [C] flashing.
2. Rotate the dial to select a character to be programmed.
3. By pressing the BAND key, the character is illuminated and entered. An identical character to the one just entered flashes on the immediate right ready to be entered.
4. Enter with the BAND key (Repeat the same sequence). You can program up to 6 digits.
5. Pressing the CALL key during programming will delete all characters to be programmed.



## Transmission speed setting (In packet operation)

This sets the data transmission speed in packet operation.

1. [HB 1200] icon appears on the display.
2. By rotating the main dial, the display changes as shown on the right and the setting is changed.  
[HB 1200] Transmission speed is set at 1200bps.  
[HB 9600] Transmission speed is set at 9600bps.

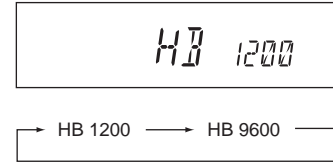

## Beacon interval setting (In geolocating communication/A.P.R.S.®)

This is to set the transmission interval of GPS location data when Geolocating communication is in operation.

1. [BCON 0] icon appears on the display. No transmission is made at BCON 0.
2. By rotating the main dial, the display changes as below and setting is changed.

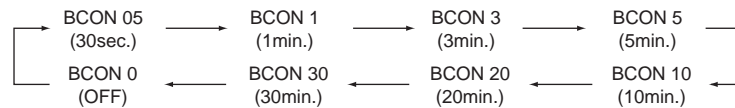

Settings for call sign, transmission speed and beacon interval will be transmitted to the TNC unit (EJ-50U) when cloning the TNC.

Operation of the TNC will stay unchanged until the TNC clone transmission is completed.

# Useful functions

## Reception band switching

This is to Select the receiving band. On the VHF side, FM broadcasting can be received. While in the VFO mode.

1. After pressing the FUNC key, press the CALL key while [F] icon is on.  
On the VHF side, the band switches from 144MHz band to the FM broadcasting band.

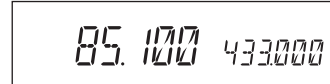

85.100 433000

## V-V/U-U simultaneous reception

This is to receive the same frequency band simultaneously both on the MAIN band and the SUB band.

1. After pressing the FUNC key, press the BAND key while [F] icon is on.  
Display on the SUB band changes to the same frequency band as the MAIN band.  
The default frequency of the SUB band is the VFO default frequency.
2. To change the frequency or settings of the SUB band, switch the SUB band to the MAIN display by pressing the BAND key before operation.
3. By pressing the BANDs key after pressing the FUNC key again, the display will return to the normal V-U display.

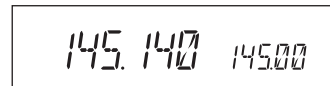

145.140 145.000

When V-V/U-U is set

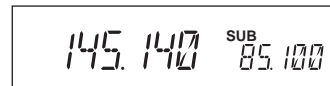

145.140 SUB 85.100

In this case no transmission is possible on the MAIN band

NOTE: The sub-band receive becomes disabled in V-V/U-U operation.

## Single-band mode

This is to use the unit as a single-band transceiver only for VHF or UHF, by eliminating the display on the SUB side.

1. Press the BAND key while pressing and holding the FUNC key.  
The display on the SUB side disappears and its function is temporarily suspended.  
While in the V-V/U-U mode, the unit will not enter in to the single-band mode.



## VFO Auto-program setting function

This is to program various automatic settings in a certain frequency range in the VFO mode. It is useful for quick repeater access.

1. Program the lower edge frequency of the desired range as well as other parameters such as repeater shift, CTCSS tone into the [AL] channel in the memory mode (Refer page 19).  
Programmable items are frequency, shift direction, offset frequency, tone ENC frequency and its setting, tone DEC frequency and its setting, DCSEN code and its setting, and DESDEC setting.
2. As above, program the higher edge frequency in the [AH] channel of the memory. Disregard other settings such as CTCSS tones or repeater shift.
3. In the VFO mode, what has been programmed in the AL memory is automatically set within the frequency band between AL and AH.  
Temporary setting change is possible between AL and AH, but once the frequency is changed by rotating the dial, all the preset values in AL will be restored.
4. To disable this function, delete the AL memory channel data referring P21.



When 439.000MHz 88.5Hz ENC-5.000MHZ  
shift is set in AL



Shows an example within  
VFO auto-program setting

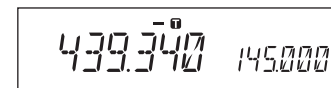

## SCANNING FUNCTION

Use this function to automatically search for signals. 6 different scan types are available in the unit. In the parameter setting mode, choose the Timer mode or the Busy mode to determine the desired resuming condition. If the CTCSS(TSQ) squelch or DCS squelch is set, the audio can be heard only when the tone/code matches the incoming signal. Otherwise, scanning stops but no audio will be heard. The direction of scan, upward or downward, can be changed during the scan by rotating the main dial or pressing the Mic UP or DOWN keys in the desired direction.

### •VFO Scan

Scans all VFO channels in regard to the preset tuning step.

1. Enter the VFO mode.
2. Press UP (to go upward) or Down (to go downward) key for more than 1 second but less than 2 seconds, otherwise press H/L key for more than 2 second.
3. The scan starts. It stops at the frequency where an incoming signal is detected, and resumes the scan according to the resume setting.
4. Press any key other than UP/DOWN keys, H/L key and BAND key to exit.



NOTE: • By pressing the UP/DOWN key for more than 2 seconds the frequency changes as long as the key is pressed.

## •Memory Scan

Scans all memory channels unless the Memory skip feature is selected for a given memory channel.

1. Enter Memory mode.
2. Sequence is the same as in VFO scan. Use UP/DOWN keys for commands, otherwise press H/L key for more than 2 seconds.



### Range of Memory Scan

Exclusive scanning for VHF/UHF:

If scanning is started somewhere between memory channels 00 and 79, scanning is only done within this range.



During mixed scanning for V/U

Mixed scanning for V/U:

If scanning is started somewhere between memory channels 100 and 139, scanning is only done within this range.

## •Skip-channel setting

A memory channel set as a skip-channel will be excluded from scanning during Memory Scan. This designation can be set even after the memory is programed.

1. Press the FUNC key in the Memory mode, and then press the V/M key while the [F] icon is displayed. Skip setting of a memory channel selected is now in place.  
A memory channel with skip setting will have the 1MHz decimal point removed. When the alphanumeric display is selected, a decimal point will appear.
2. To cancel the skip-channel setting, repeat the step 1.

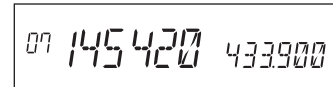

**IMPORTANT: CALL, PL, PH, AL, AH and ch.99 are always skipped.**



## •Program Scan

This is a type of VFO scan, which is done by setting the frequency range of the VFO into the PH and PL channels, it only scans between those frequencies. When the PH and PL are set properly, up to 3 Program scan ranges will be available, which are L-PH, PL-PH and PH-H.

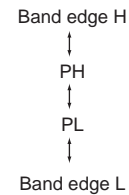

1. Enter the VFO mode and set the PL and PH frequencies into the designated memory channels. Refer to Memory setting for the proper sequence.
2. Return to the VFO mode by pressing V/M key. Set the VFO to the frequency within the range to be program-scanned.
3. Press the MHz key for more than 1 second to start scanning. During this scan mode, the decimal point flashes as shown.
4. Use the main dial or Mic UP/DOWN keys to change the scan direction. Press any key (other than the UP/DOWN keys) to exit.

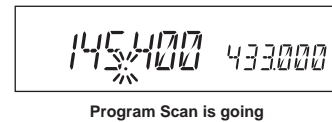

## •Tone Scan

This function automatically searches for the CTCSS tone an incoming signal might carry. This feature is useful to search for the encoding tone of a repeater, or to communicate with a station operating in TSQ (CTCSS squelch) mode.

1. Press TS/DCS key to enter the CTCSS decode setting mode. Press until TSQ is displayed.
2. Press the Mic UP/DOWN key for more than 1 second but less than 2 seconds to start scanning. It scans 38 tones in order.
3. When searching, the decimal point on the tone frequency will flash. Tone scanning stops when the matching tone is detected.
4. The tone scan won't resume unless the operation in step 2 is repeated.
5. Press any key (other than UP/DOWN keys) to exit.

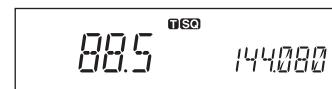

## •DCS scan

Same as previous, but for DCS code search.

1. While in the DCS setting, press the UP/DOWN key for more than 1 second but less than 2 seconds to start scanning.  
(It scans 105 DCS codes in order.)
  - During scanning, the 1 MHz order decimal point will flash.
  - The scan stops when the matching DCS code is detected and reception starts.



**IMPORTANT:** After scanning stops, it will not resume until the dials moved or the Mic UP/DOWN key is pressed.

2. When scanning has finished, pressing any key other than the UP/DOWN key will cancel the scan mode.

## KEY-LOCK FUNCTION

This will lock the keys to avoid unintentional changes.

1. Press FUNC key and press the TS/DCS key while the F is on the display.
2. The [  ] icon appears.
3. With this function activated, only the following commands can be accessed:
  - PTT
  - FUNC+TS/DCS to cancel this function
  - Monitor function (to release squelch for weak signal reception)
  - Squelch setting
  - Volume setting



## TONE BURST

This feature is to alert the other party by adding a tone to the transmitted signal.

- When the PTT key and the DOWN key are pressed together, a tone signal is transmitted.
- The default is an alert sound. The transmitted tone can be changed in the Setting mode.
- For the DR-635E, a 1750Hz tone burst signal is transmitted as the default setting, so that a repeater can be accessed by the tone.

## Narrow-band mode

This feature is useful in areas where narrow band widths are in use.

1. Press the MHz key together with the FUNC key. The [Nar] icon appears on the display to show the unit is in the Narrow mode.
2. Repeat the same operation to return to the normal mode.



In the Narrow mode

**IMPORTANT:** In the NARROW mode, the microphone gain and modulation during transmission and the demodulation range during reception will be lower.

## AM receiver mode

This mode is to receive AM signals.

1. Press the TS/DCS key while the FUNC key is pressed. [AM] icon illuminates on the display to show the unit is in the AM reception mode.
2. Repeat the same operation to return to the FM mode. When the AM RX mode is set, the FM mode will be used for TX even though the AM icon remains displayed.

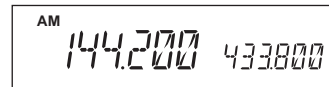

# Selective Communication

Many repeaters require a CTCSS tone or a DCS encode setting as a “key” to access a repeater system, or a receiver using CTCSS or DCS squelch, so-called “selective-calling”. Sometimes, CTCSS or DCS decode features are used on the output of a repeater so they can be used to open a squelch. In this mode, regardless of the main squelch status, the audio can be heard ONLY when the matching tone/code signal is received. The combination of CTCSS squelch and DCS function is not available; only one or the other may be used for a given frequency.

## Tone-squelch (CTCSS) and DCS

1. Press TS/DCS key. The current setting will be displayed with T/SQ/DCS icons and relative frequency/code. Press the same key to select T/SQ/DCS setting.
2. The numbers (such as 88.5) represent the CTCSS frequency in Hz. When it is displayed with the T icon only, the unit transmits the sub-audible tone while the PTT is pressed (encode) and the repeater access is enabled (assuming the repeater is using 88.5).
3. Press the same key again so that the SQ icon shows up on the display. This is the CTCSS decode frequency. This enables CTCSS squelch (or Tone Squelch, TSQ).
4. Press it again so that the 3-digit number and DCS icon is displayed. This is the DCS code, and it enables DCS encoding and decoding.

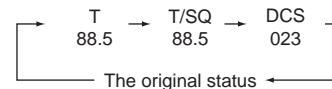

For 2-4, rotate the main dial or press the UP/DOWN keys to change the tone or the code. Press any key (Except TS/DCS, or Mic UP/DOWN keys) to enter the setting and return to the original status. The T/SQ/DCS icon will remain on the display to show the current status. To exit, simply use the TS/DCS key and press it until the relative status icon T/TQ/DCS disappears.

The CTCSS encoding and decoding frequencies may be set differently. The encode setting frequency automatically relates to the decode setting, but the decode setting does not affect encode. The standard set of 38 different CTCSS tones are available as shown on the chart below. DCS encode/decode cannot be separated and are selectable from 105 codes as shown below and on the following page.

67.0	71.9	74.4	77.0	79.7	82.5	85.4	88.5
91.5	94.8	97.4	100.0	103.5	107.2	110.9	114.8
118.8	123.0	127.3	131.8	136.5	141.3	146.2	151.4
156.7	162.2	167.9	173.8	179.9	186.2	192.8	203.5
210.7	218.1	225.7	233.6	241.8	250.3		

023	025	026	031	032	036	043	047	051	053	054	065
071	072	073	074	114	115	116	122	125	131	132	134
143	145	152	155	156	162	165	172	174	205	212	223
225	226	243	244	245	246	251	252	255	261	263	265
266	271	274	306	311	315	325	331	332	343	346	351
356	364	365	371	411	412	413	423	431	432	445	446
452	454	455	462	464	465	466	503	506	516	523	526
532	546	565	606	612	624	627	631	632	645	654	662
664	703	712	723	731	732	734	743	754			

### DET setting

If the DET mode in DCS operation is preferred, press the H/L key while the DCS code is displayed in the setting mode. Observe that a decimal point appears, then follow the remaining sequence to set the parameter and exit.

DET on DCS function stands for Detect-Only mode. In DCS operation, the TX signal carries a digital code such as 001010000 as determined by setting the 3-digit code such as 123,124 etc. This stream is modulated with a very low sub-audible frequency. The RX side, just like TSQ, detects this stream and determines the squelch operation. This DCS code stream is transmitted all the way through the communication like a CTCSS tone (in this case a single continuous tone, instead of digital coded stream).

It is necessary for receiver to correctly and CONTINUOUSLY receive this DCS digital stream to hold the squelch open, otherwise the CPU thinks that the signal is unwanted and it closes the squelch. But due to noise or weak signal strength etc, sometimes it is difficult to continuously receive a DCS stream. By activating DET, the receiver opens the squelch when the first corresponding DCS stream is received, then thereafter, regardless of the status of the DCS codes, the DCS squelch remains opened.

#### Advantage of DET

It enables DCS squelch operation even in poorer conditions, opening the squelch only when a corresponding DCS coded signal is received.

#### Disadvantage of DET

When it is activated, suppose 2 stations are sharing the same channel and using the DCS selective-calling technique and transmitting at the same time. After station A with its corresponding DCS is gone, you may still hear station B, although he can't open your DCS squelch by his signal alone.

## Digital voice communication (DR-635T only)

By installing an optional digital unit EJ-47U, digital voice communication becomes possible.

1. Install EJ-47U to the connector CN3 of the unit.
2. Press the FUNC key, and then press the SQL key while the [F] icon is displayed. [JUL] is shown on the display.
3. Press the FUNC key or the PTT key to enter the digital communication mode. Repeat step 2 to exit and return to the analog FM mode.
4. To cancel the digital communication mode, press the SQL key while the display shows codes in step 2.

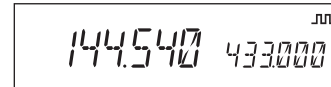

When digital setting is made

**IMPORTANT:** When activating this setting, a code is displayed and switched by rotating the dial, but it does not affect the function of EJ-47U. Please disregard this setting sequence. Digital voice operation on certain amateur radio frequencies may be prohibited, restricted or subject to a special station license. Please be sure to consult with your local authority prior to operating in this mode.

# Special Functions

## THEFT ALARM

This alert uses a beep sound when the unit is about to be removed in an improper manner. This function is useful when the unit is installed in a vehicle.

### To connect, set and operate

**IMPORTANT:** Be sure to connect the power cable directly to the car battery. The power cable of this unit requires voltage at all times to activate this function. For the same reason, the ACC ON/OFF feature must be deactivated.

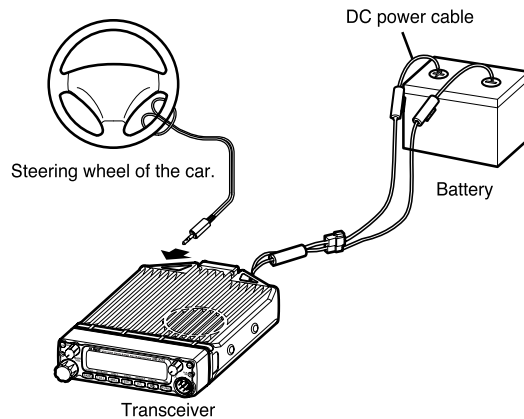

**1.** Wire the alarm cable (There are 2 ways to configure).

1. Modifying and inserting a 3.5 Ø stereo plug for the alarm into the SP terminal jack in the back, as the figure shows. This configuration is recommended for vehicle installation, for easier removal of the cable

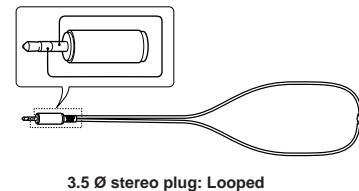

2. Modifying and inserting the provided wiring cable UX1290A into the connector CN10 in the unit. This configuration is recommended for a semi-permanent installation. By selecting this configuration the speaker remains active, either internal or external, as configured.

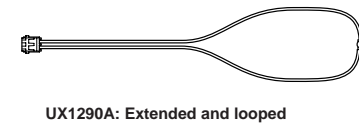

**2.** Be sure to fix the alarm cable to the steering wheel. As the figure shows.

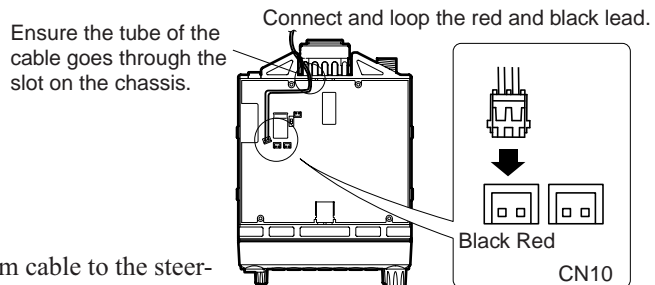

3. Set SCR-ON in the setting mode. The [\*] icon will appear on the display.

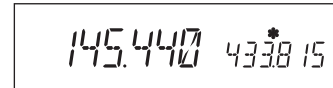

4. Turn OFF the unit. Alarm function is activated, the display will turn off and TX display lamp will start illuminating.

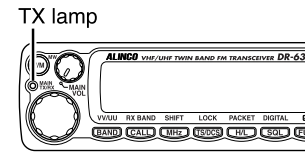

5. To deactivate, turn ON the unit and set SCR-OFF in the setting mode.

**IMPORTANT:**

- To activate the function, be sure to switch OFF the power after having connected the cable for the alarm. (Connecting it after the power is off may activate the alarm)
- The alarm will not be active unless the PWR switch is turned off.
- The alarm function will not operate if the power is OFF in the ACC power supply control function.
- The alarm cable A/B provided with DR-135/435 is not compatible with this unit.

## How the alarm operates

When the alarm cable is removed from the port or cut without using the proper sequence, the alarm sounds for 10 minutes. During the alarm, the unit goes to receive on memory channel 99, according to its pre-programmed setting (TSQ/DCS accepted).

### To cancel the alarm setting while the alarm is functioning

1. When a signal is received on ch.99 the alarm stops. If ch.99 is empty the unit continues monitoring the Main-VFO frequency. Turning on the unit with the SQL key pressed also cancels the alarm.
2. When the power is turned OFF again, the alarm setting resumes.

**NOTE:** The alarm feature on DR-635TA version functions in a slightly different manner.

1. When the alarm starts, the unit alternates between transmit and receive on ch.99 every 5 seconds for 5 minutes.
2. Setting and operation of the function are the same as other versions.  
This feature allows you to monitor and to control the alarm from a remote place by using ch.99 in the memory mode.



## Setting alarm starting time

Choose this operation when a delay period is desired.

1. Enter the Parameter setting mode as described previously and select SCR-DLY. Follow the previous instruction to set.
2. Turn off the unit. Display will disappear but the LCD illumination stays on. After 20 seconds, the TX LED lights up, illumination dims, and the alarm functions. The system won't work during the 20 second "DELAY" period.
3. The alarm sounds under the same condition as described previously. There is a 20 second delay until the alarm sounds. During the 20 second period, only the display illumination is lit. Turn ON the unit with the SQL key pressed during the "DELAY" period to cancel the alarm function.

TX lamp

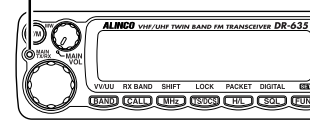

**IMPORTANT:** Please set the parameters at SCR-OFF during normal operation.

NOTE: Please use a sticker provided indicating installation of the theft alarm device.



## Setting on the Master side

1. Press the CALL key with FUNC key pressed. CLONE will be displayed and the radio enters the clone mode.
2. Press PTT. SD\*\*\* will be displayed and the master unit starts sending data to the slave unit.
3. [PASS] will appear on the display when the data has been successfully transmitted.
4. The master radio may stay turned on for the next clone. Turn off the unit to exit from the clone mode.



During transmission

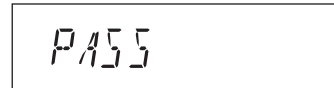

When transmission is finished

If the data is not successfully transmitted, turn off both units, make sure the cable connection is correct and repeat the entire operation from the beginning.

**IMPORTANT:** Never disconnect the cable while data is being transmitted in the clone mode.  
Never perform the clone while the units are in V-V/U-U receive mode.

## Packet Communication

Packet communication is a high-speed data communication system transmitting a package of data generated through a personal computer. The use of Digi-peaters (relay stations) offers communications with DX stations (distant stations). For packet communication, a personal computer, DSB-9 cable and the optional EJ-50U (TNC unit) are required in addition to this unit. The EJ-50U is equipped with a Digi-peater function. For detailed information, please refer to the instruction manual of the EJ-50U.

### When using EJ-50U

#### Connect the EJ-50U with a personal computer.

1. Connect the EJ-50U and DSUB9 connector to this unit following the figure below. A sheet attached to the place meant for the DSUB9 connector can be removed easily by pressing from the inside.

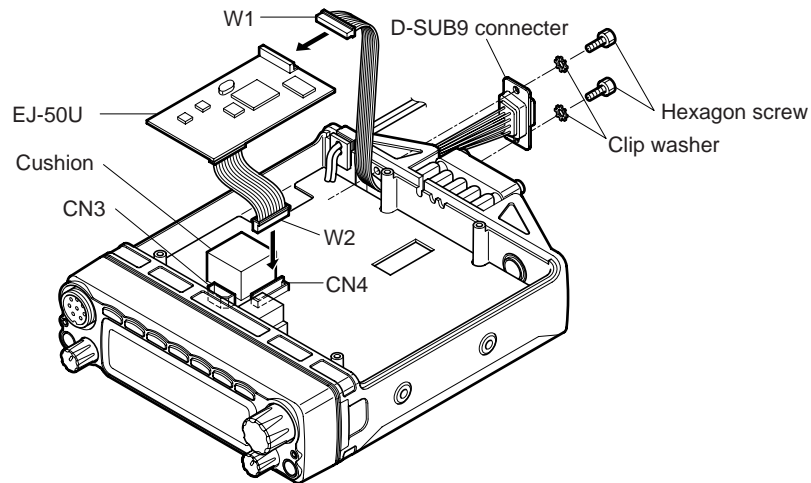

2. Insert DSUB connector W1 into the EJ-50U.
3. Insert W2 of EJ-50U into CN4 of this unit.

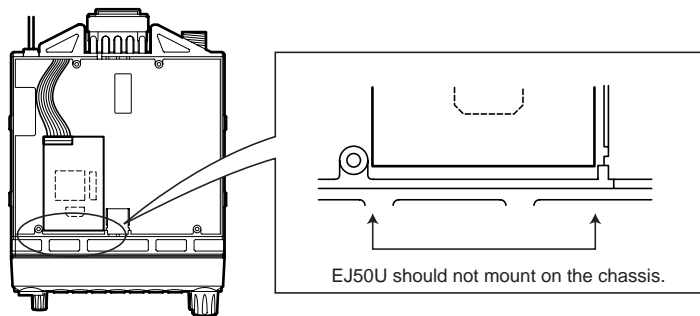

4. Connect the EJ-50U with a personal computer.  
Connect the DSUB connector on the rear panel and the serial port of a personal computer with a straight cable.

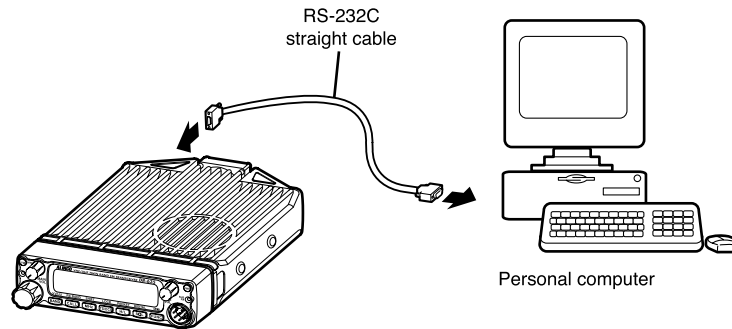

**IMPORTANT:** Between the DSUB9 and a personal computer, use a 9-pin RS-232C straight cable (male-female).

## Packet Mode Setting

1. Press the FUNC key. While [F] icon is on, press the H/L and SQL keys. [TNC] lights up on the display and the unit enters packet mode. By the same operation, [TNC] disappears, the unit exits from packet mode and the display returns to its normal status.
2. Use the computer keyboard to send designated commands from your PC to start packet communication.

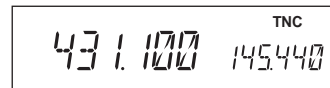

**NOTE:** • Parameters for communication with a PC terminal.  
Please use PC commands to program the following.

Data Speed (Transfer Rate)	: 9600bps
Data Length	: 8 bit
Parity Bit	: None
Stop Bit	: 1 bit
Flow Control	: Xon/Xoff

- What is programmed from a PC is stored in memory even after the TNC unit is removed from the transceiver.
- This TNC unit is not equipped with all the functions an external TNC may have (Some functions may be limited).

**IMPORTANT:** • Packet communication is easily affected by the transmission and reception environment especially in the 9600bps packet mode, communication error may easily occur unless all segments of the S-meter are displayed.

- While in the packet mode or geolocating communication mode, tones or codes are not output even if a Tone setting or a DCS setting is programmed.

## APRS

Install the optional TNC unit EJ-50U and an external GPS receiver to operate in this mode. APRS (Automatic Packet/Position Reporting System) is program software registered as a trademark of Bob Bruninga, WB4APR. With this program, you may trace a mobile station on a map displayed by a computer.

For tracking a mobile station, you may need a PC installed with APRS, this unit (transceiver), and a TNC (EJ-50U). You may also need a GPS receiver, which captures signals from satellites and lets you know where you are.

APRS will retransmit NMEA (National Marine Electronics Association) data message received from a GPS receiver. For detailed information, please see the Internet web page regarding APRS. ([www.taps.org](http://www.taps.org))

**NOTE:** GPS means Global Positioning System.

### APRS Settings

APRS needs TNC unit EJ-50U, a GPS receiver and a PC with APRS software installed. Select an external GPS receiver compatible with the NMEA format.

Configuration NMEA: NMEA-0183, 4800bps/Parity Bit none/Data Length 8bit/Stop Bit 1bit

### Connecting the GPS

Please refer to the chapter or packet communication for EJ-50U installation and connection to a PC.

- I.** Connect a GPS receiver to CN5 connector inside of this unit using the provided wiring cable with some modification.  
(Modification/connection of the wiring cable to the terminal is as follows)

Ensure the tube of the wiring cable goes through the slot on the chassis.

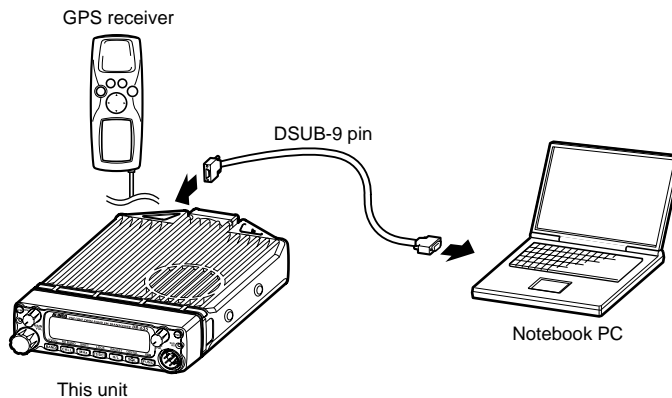
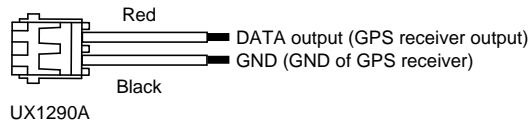
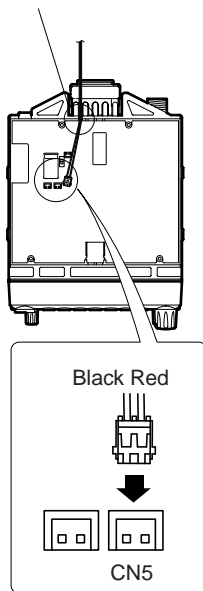

- NOTE:**
- You may remove the PC after setting is completed. (What has been programmed is stored in the TNC unit. To change settings, you must reconnect the computer.)
  - Setting the of call sign of your station, communication speed and Beacon transmission time interual may be changed by the TNC clone of this unit without using a PC.

## APRS operation

For detailed information, please see a list of commands and the instruction manual of the EJ-50U.

1. Boot up the terminal software on the PC, press the FUNC key and press the H/L key while the [F] icon is on. [TNC] lights up on the display and the unit enters Geolocating communication mode.
2. The initial screen of the TNC appears on the PC.
3. Set communication speed of the packets from the command mode (cmd:).  
[Example cmd: HB 1200 or 9600]
4. Register the call sign of your station.  
[Example cmd: MY \*\*\*\*\*]
5. Set the communication speed of the GPS port.  
[Example cmd: GB 4800]
6. Set the automatic transmission time interval.  
[Example cmd: LOC E 3]
7. When the location data etc. is received from the GPS receiver, it will be automatically transmitted as programmed.
8. By pressing the FUNC key and then the H/L key, the TNC will be turned off and transmission of position data will be stopped.
9. By turning the TNC on again, automatic transmission will resume following the previous settings.

The image shows a digital display with three main numbers: '43', '1000', and '145000'. In the top right corner, the letters 'TNC' are displayed. The display is enclosed in a rectangular border.

Geolocating communication mode

The image shows a PC terminal window with the following text:
   
TASCO Radio Modem
   
AX.25 Level 2 Version 2.0
   
Release 03/Dec/99 3Chip ver 1.08
   
Checksum \$04
   
  
cmd:HB 1200
   
HBAUD was 1200
   
cmd:MY JA1234
   
MYCALL was NOCALL
   
cmd:GB 4800
   
GBAUD was 4800
   
cmd:LOC E 6
   
LOCATION was EVERY 0
   
cmd:

Example of PC display

**IMPORTANT:**

- While using APRS software, the header setting for monitoring should be OFF.  
(Input: cmd: LTMH OFF)
- Please use this unit and the GPS receiver reasonably apart from each other.

## TNC Clone

This feature enables setting changes required for APRS function without connecting to a PC. Please use this feature when a setting change is desired while the APRS function is in operation. Setting changes are available for the call sign of your station, communication speed and data transmission time separation (Setting is made in setting mode).

1. Press the FUNC key and then press the H/L key while [F] icon is on (Enter packet mode).
2. Press the CALL key with the FUNC key pressed. The display will show [TNCLON] and data programmed in setting mode for the call sign of your station, the communication speed and data transmission time separation are transmitted.
3. Upon completion of data transmission, the display shows [PASS]. Turning the unit off will make it exit the clone mode and restore normal packet operation.

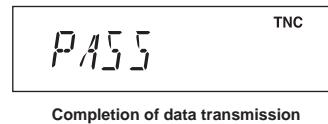
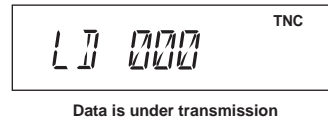



## Remote Control Operation (EMS-57 Only)

The transceiver can be controlled remotely by operating the DTMF keys on the microphone. Frequencies can also be entered directly through the key pads.

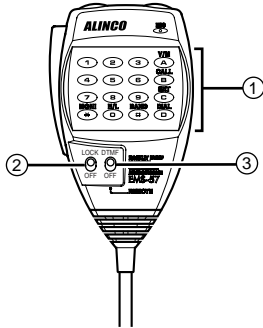

No.	Key	Function
1	DTMF	Enter the remote command or the frequency.
2	LOCK	Press LOCK to prevent the transceiver from accepting remote control inputs from the microphone.
3	DTMF/REMOTE	To operate remote control, press REMOTE.

### List of Remote Control Keys

Key	Transceiver corresponding key	Function	Page
0-9	–	Direct frequency input	–
A	V/M	Memory channel access	19
B	CALL	Call channel access	23
C	SET mode	SET mode access (Note 1)	26
D	FUNC+BAND	Switching reception band	35
*	Press and hold SQL	Monitor function	24
#	BAND	Switching MAIN band	15
0	H/L	Switching transmission output	25

(Note 1) To change the SET mode menu, press the UP and DOWN keys at the top. To change its contents, press the \* and # keys. Press PTT key or C key to return to the frequency display.

## Entering a frequency directly

Frequencies can be entered directly by pressing the numerical keys of the microphone.

- Range of frequencies to be input
  - 76.000 - 107.995MHz (WFM reception)
  - 144.000 - 145.995MHz
  - 430.000 - 439.995MHz

1. Set the microphone DTMF/REMOTE switch to the REMOTE position.
2. DTMF keys can be used to enter from the 100MHz digit.  
(Ex.) When setting 144.20 MHz with the tuning step set to 20kHz.  
Enter 1 4 4 2 0

After entering the fifth digit a slightly longer beep is emitted and the entry is completed.

3. To cancel an entry before it is completed, press the PTT key or C key.

## Entry method depending on tuning step

Depending on the set tuning step, frequency entry may be necessary to the 1 kHz digit. In some cases entry to the 10 kHz digit is sufficient. For cases in which digit entry is only necessary to the 10 kHz digit some digit keys are not accepted.

The relationship between the tuning step and input method is as follows.

Tuning step	Entry completion digit	Final digit selection
5.0 kHz	1 kHz	Completion after input of the 1 kHz digit.
8.33 kHz	1 kHz 10kHz	Depending on the frequency, either the 1kHz digit or 10kHz digit may be entered.
10.0 kHz	10 kHz	Completion after input of the 10 kHz digit.
12.5 kHz	10 kHz	When you input the 10 kHz digit, the 1 kHz digit is set as follows: 0...00.0, 1...12.5, 2...25.0, 3...37.5, 4...invalid 5...50.0, 6...62.5, 7...75.0, 8...87.5, 9...invalid
15.0 kHz	10 kHz	Completion after input of the 10 kHz digit.
20.0 kHz	10 kHz	Completion after input of the 10 kHz digit.
25 kHz	10 kHz	When you input the 10 kHz digit, the 1 kHz digit is set as follows. 0...00.0, 2...25.0, 5...50.0, 7...75.0, Other entries are invalid.
30 kHz	10 kHz	When you input the 10 kHz digit, the 1 kHz digit is set as follows.
50 kHz	10 kHz	When you input the 10 kHz digit, the 1 kHz digit is set as follows. 0...00.0, 5...50.0
100 kHz	10 kHz	Completion after input of the 10 kHz digit.

# Maintenance / Reference

## Reset

Resetting the unit returns all programmed contents to their factory default settings.

1. Press the PWR key for more than 1 second with the FUNC key pressed and turn the power on.
2. All segments of the LCD will be displayed, then default settings are displayed.

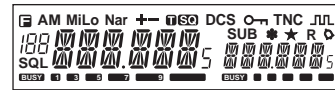

All LCD segments

**IMPORTANT:** While holding the FUNC key down, turn the power on. All segments of the LCD will be displayed, then default settings are displayed.



## Factory Default Settings

	DR-635T	DR-635E
MAIN band	VHF	VHF
VFO frequency (VHF)	145.00MHz	145.00MHz
(UHF)	445.00MHz	435.00MHz
CALL frequency (VHF)	145.00MHz	145.00MHz
(UHF)	445.00MHz	435.00MHz
Memory channel	-	-
Offset direction	-	-
Offset frequency (V/U)	600kHz/5MHz	600kHz/7.6MHz
Channel step	5kHz	12.5kHz
Channel step (FM)	100kHz	100kHz
Tone-squelch setting	-	-
Tone frequency	88.5Hz	88.5Hz
DCS setting	-	-
DCS code	023	023
Output power	HI	HI
Scan resuming condition	busy	busy
Beep volume setting	2	2
Time-Out-Timer	OFF	OFF
TOT penalty	OFF	OFF
APO	OFF	OFF
Tone burst sound setting	ALERT	1750Hz
Clock shift setting	OFF	OFF
Bell setting	OFF	OFF
Busy-Channel-Lock-Out setting	OFF	OFF
Theft Alarm setting	OFF	OFF
Display color setting	3	3
Dimmer setting	4	4
Squelch level	02	02

## Troubleshooting

Please check the list below before concluding that the transceiver is faulty.

If a problem persists, reset the transceiver. This can sometimes correct erroneous operation.

Problem	Possible Causes	Potential Solutions
Power is on, nothing appears on the Display	<ul style="list-style-type: none"> <li>a. + and - polarities of power connection are reversed.</li> <li>b. Fuse is blown.</li> <li>c. ACC power supply is connected but is OFF.</li> </ul>	<ul style="list-style-type: none"> <li>a. Correctly connect the red lead and the black lead of the DC power cable provided respectively to the plus terminal and the minus terminal.</li> <li>b. Check and solve the problem resulting in blown fuse and replace it with a new one with the same rated capacity.</li> <li>c. Turn on the ACC power supply.</li> </ul>
Display is too dim.	Dimmer setting is "LAMP 1 - 3."	Make the dimmer setting "LAMP 4."
No sound comes from the speaker. The unit does not receive.	<ul style="list-style-type: none"> <li>a. The volume knob is rotated too much counter-clockwise.</li> <li>b. Squelch is muted.</li> <li>c. Tone or DCS squelch is active</li> <li>d. PTT key of the microphone is pressed for transmission.</li> <li>e. External speaker is connected.</li> </ul>	<ul style="list-style-type: none"> <li>a. Set the volume knob properly.</li> <li>b. Decrease squelch level.</li> <li>c. Turn tone or DCS squelch off.</li> <li>d. Immediately release the PTT key.</li> <li>e. Remove the jack from the external speaker terminal.</li> </ul>
Keys and the dial do not function.	Key-lock function is activated ([  ] is on).	Cancel key-lock function.
Rotating the dial will not change memory channel.	<ul style="list-style-type: none"> <li>a. No memory is programmed.</li> <li>b. The unit is in CALL mode.</li> </ul>	<ul style="list-style-type: none"> <li>a. Program memory.</li> <li>b. Press V/M key for memory mode.</li> </ul>
Pressing the UP/DOWN key will not change frequencies or memory channels.	<ul style="list-style-type: none"> <li>a. The unit is in CALL mode.</li> <li>b. Lock switch is ON.</li> <li>c. Key-lock function is activated ([] is on).</li> </ul>	<ul style="list-style-type: none"> <li>a. Switch to VFO mode or memory mode.</li> <li>b. Turn off the Lock switch.</li> <li>c. Cancel key-lock function.</li> </ul>
PTT key is pressed but transmission does not occur.	<ul style="list-style-type: none"> <li>a. Microphone terminal is not properly inserted.</li> <li>b. Antenna is not connected.</li> <li>c. SHIFT is set for OFF band transmission.</li> <li>d. The unit is in SUB band reception mode.</li> </ul>	<ul style="list-style-type: none"> <li>a. Properly insert the microphone connection.</li> <li>b. Properly connect the antenna.</li> <li>c. Cancel SHIFT or set within the band.</li> <li>d. Switch to the MAIN band.</li> </ul>

Problem	Possible Causes	Potential Solutions
Packet communication does not function.	<ul style="list-style-type: none"> <li>a. TNC is not connected or set properly.</li> <li>b. The unit is not in the packet mode.</li> <li>c. The squelch is open.</li> <li>d. The data transmission speed is not configured.</li> <li>e. A PC cable other than the straight type is used.</li> </ul>	<ul style="list-style-type: none"> <li>a. Make sure the connections and configurations are properly set.</li> <li>b. Switch to the packet mode.</li> <li>c. Adjust the squelch level where it will open by reception of a signal.</li> <li>d. Adjust the speed by the PC.</li> <li>e. Use a straight type PC cable.</li> </ul>
APRS does not function.	<ul style="list-style-type: none"> <li>a. The unit is not in the packet mode.</li> <li>b. The unit is not configured for automatic transmission.</li> <li>c. The squelch is open.</li> <li>d. The GPS receiver is not geolocating.</li> </ul>	<ul style="list-style-type: none"> <li>a. Switch to the packet mode.</li> <li>b. Use the PC to set transmission time separation.</li> <li>c. Adjust the squelch level where it will open by a reception signal.</li> <li>d. Wait until the GPS receiver properly geolocates.</li> </ul>

**IMPORTANT:** When reception frequencies fall in any one of the formulas below, the unit may receive a non-modulated signal.

This is due to the structure of frequencies of this unit and not a malfunction of the unit.

- (Reception frequency on the MAIN side - 45.1MHz )  
= Reception frequency on the SUB side - 43.4MHz (In u-u)
- (FM reception frequency + 10.7MHz) x 4 = UHF reception frequency - 90.2MHz
- (FM reception frequency + 10.7MHz) x 5 = UHF reception frequency
- (UHF reception frequency - 45.1MHz) x 2  
- (VHF reception frequency - 21.7MHz) x 6 = 45.1MHz
- (UHF reception frequency - 45.1MHz) - (VHF reception frequency - 21.7MHz) x 3  
= 21.7MHz
- In case you are monitoring the 3 multiple of TX frequency, you may hear your voice from the unit but this is normal.

## Optional accessories

- EMS-57 DTMF equipped microphone  
(This comes standard with the DR-635T)

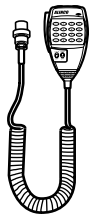

- EMS-53 Microphone  
(This comes standard with the DR-635E)

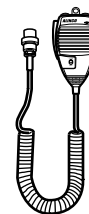

- EJ-50U TNC unit

# Transmitter Block Diagram

DR-635T, DR-635E

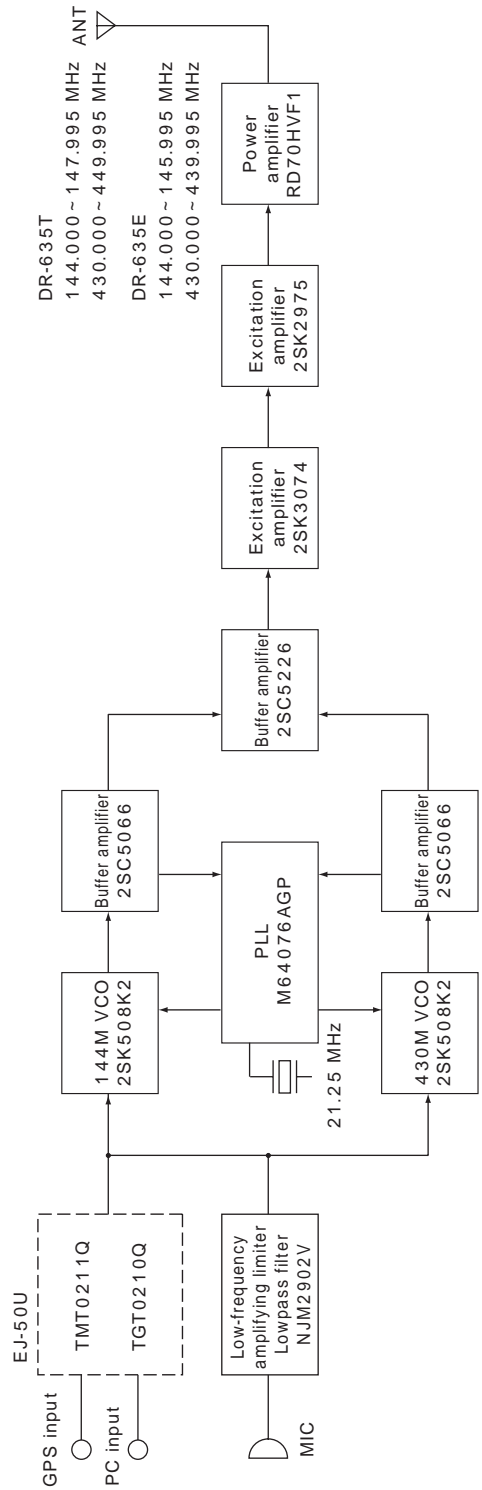

## Specification

General		DR-635T, DR-635E
Frequency coverage	DR-635T	87.500 - 107.995MHz (WFM RX) 108.000 - 135.995MHz (AM RX) 136.000 - 173.995MHz (RX) 144.000 - 147.995MHz(TX) 335.000 - 479.995MHz (RX) 430.000 - 449.995MHz (TX)
	DR-635E	87.500 - 107.995MHz (WFM RX) 144.000 - 145.995MHz (RX, TX) 430.000 - 439.995MHz (RX, TX)
Operating mode	16K0F3E (Wide mode), 8K50F3E (Narrow mode)	
Frequency resolution	5, 8.33, 10, 12.5, 15, 20, 25, 30, 50, 100kHz	
Number of memory channels	200	
Antenna impedance	50Ω unbalanced	
Power requirement	13.8V DC +/-15% (11.7 to 15.8V)	
Ground method	Negative ground	
Current drain	Receive: 0.7A(Max.), 0.5A(Squelched) Transmit: 11.0A	
Operating temperature	- 10 °C to 60 °C	
Frequency stability	+/- 2.5ppm	
Dimensions	140(w) - 40(h) - 185(d) mm (w/o knobs)(5.51" x 1.57" x 7.28")	
Weight	Approx. 1.0kg (2.2lbs.)	
Transmitter		
Output power	High:50W(VHF), 35W(UHF)Mid:20WLow:5W	
Modulation system	Variable reactance frequency modulation	
Maximum frequency deviation	+/- 5kHz (Wide mode) +/-2.5kHz (Narrow mode)	
Spurious emission	-60dB	
Adjacent channel power	-60dB	
Modulation Distortion	Less than 3%	
Microphone impedance	2kΩ	
Receiver		
Sensitivity	-14dBu for 12dB SINAD	
Receiver circuitry	Double conversion superheterodyne	
Intermediate frequency	1st 21.7MHz 2nd 450kHz (VHF) 1st 45.1MHz 2nd 455kHz (UHF)	
Squelch sensitivity	-18dBu	
Selectivity(-6dB/-60dB)	12kHz/28kHz	
Spurious and image rejection ratio	70dB	
Audio output power	2.0W (8Ω,10%THD)	

\*All specifications are subject to change without notice or obligation.

VHF/UHF FM MOBILE TRANSCEIVER 144.000-145.995MHz / 430.000-439.995MHz

**CE0336** 

This device is authorized for use in all EU and EFTA member states.  
An operator's license is required for this device.

**CAUTION: RF Hazard Warning.**

The electro-magnetic (radio Frequency) exposure level of this device may exceed the European standards of the hazard level when transmitting at the high-power setting while connected to a unity gain antenna at a distance of 63cm or less from the operator. Furthermore, the hazardous RF exposure level depends on the conditions of the combination of the antenna gain, distance from the operator, output setting and installation environment, therefore the operator may be exposed to stronger RF even at a distance of more than 63cm. For safety purpose, it is recommended that the antenna be installed outside of, and as far as possible from, the operator's area. Avoid using an excessively high-gained antenna in case the distance between the operator and the antenna is very limited. Always use the minimum necessary output power for communications.



## **XBR (Crossband Repeater) Mode (for the DR-635T Only)**

This mode allows the DR-635T to operate like a repeater using both VHF and UHF bands. That is, when receiving a signal on one band, the DR635T automatically transmits the same signal on another band simultaneously.

**! Notes:**

- *The MAIN band setting cannot be altered in XBR mode.*
- *Any combination of VFO, memory, or CALL channels can be set as receiving and transmitting frequencies of the XBR as far as they are V/UHF combination within the transmitter's coverage.*
- *The XBR doesn't support digital modes such as packet and digital-voice.*
- *The Tone-Squelch feature supports the XBR mode to filter unwanted signals, however, the DCS feature doesn't.*
- *The XBR respects the offset direction and range settings of the transceiver mode.*
- *The TOT function is usable but TOT penalty-time and BCLO functions become deactivated during the XBR operation.*

### **Accessing or exiting the XBR Mode**

Turn the power on while holding the BAND key pressed.

and **R** icons appear on the screen. Repeat the same sequence to exit from the XBR mode.

# **ALINCO,INC.**

Head Office: Shin-Dai building 9th Floor  
2-6, 1-Chome, Dojimahama, Kita-ku,  
Osaka 530-0004, JAPAN  
Phone:+81-6-4797-2136 Fax:+81-6-4797-2157  
E-mail:[export@alinco.co.jp](mailto:export@alinco.co.jp)