

ALINCO

UHF FM TRANSCEIVER

DJ-S45 CQ/T/E

Instruction Manual

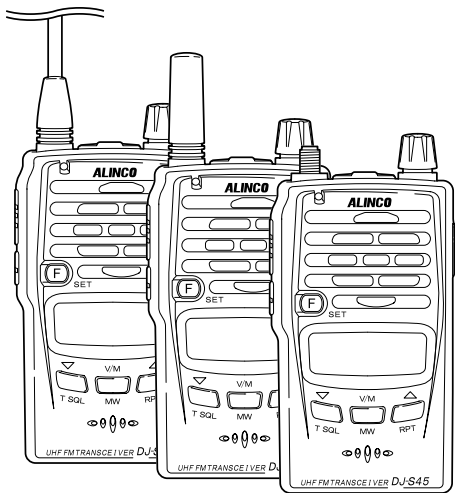

Thank you for purchasing this ALINCO FM transceiver. This instruction manual contains important safety and operating instructions. Please read it carefully before using the transceiver and be sure to keep it for future reference.

ALINCO, INC.

Contents

NOTICE / Compliance Information Statement	3
Before Operating the Transceiver	5
1.Functions and Features	6
1-1 Standard Accessories	6
2.Accessories	7
2-1 Attaching and Detaching Accessories.....	7
2-1-1 Antenna(DJ-S45 T/E only).....	7
2-1-2 Hand Strap	7
2-1-3 Belt Clip.....	7
2-2 Setting Batteries	8
2-3 Lithium Ion Battery Pack.....	8
2-4 Battery Level Indicator	9
3.Control Functions.....	10
3-1 Names and Operations of the Transceiver Controls	10
3-2 Key Operations.....	12
3-3 Display	14
4.Basic Operations.....	15
4-1 Turning the Power ON	15
4-2 Adjusting the Audio Volume	15
4-3 Operating Modes.....	16
4-4 LPD (VFO) Mode	16
4-4-1 Frequency Setting	17
4-5 PMR Mode(DJ-S45 CQ only)	17
4-5-1 Frequency Number Setting	17
4-6 Memory Mode.....	18
4-6-1 Memory Channel Programming	18
4-6-2 Selecting a Memory Channel	19
4-6-3 Clearing a Memory Channel Data	19
4-6-4 Programmable Items to Memory Channel.....	20

4-7	Receiving	20
4-7-1	Adjusting Squelch Level	20
4-7-2	Monitor Function	21
4-8	Transmitting	21
4-8-1	Switching of Transmission Output Level (DJ-S45 T/E only)	22
5.	Parameter Setting Mode	23
5-1	Selectable Parameters.....	23
5-2	Selecting the Setting Mode	28
6.	Advanced Operations	30
6-1	Scanning.....	30
6-1-1	LPD (VFO) Scan	31
6-1-2	PMR Scan(DJ-S45 CQ only)	31
6-1-3	Memory Scan.....	32
6-1-4	Skip Channel.....	32
6-1-5	Tone Scan	33
6-2	Repeater(DJ-S45 T/E only).....	33
6-3	Key Lock.....	34
6-4	Tone Call (Tone Burst)	35
6-5	Channel Display Mode.....	35
7.	Selective Communicating	36
7-1	LPD (VFO) Tone Squelch	36
7-2	PMR Tone Squelch(DJ-S45 CQ only)	38
8.	Cloning / Packet Operation.....	39
8-1	Cloning.....	39
8-2	Packet Operation(DJ-S45 T/E only)	42
9.	Maintenance and Reference	43
9-1	Resetting.....	43
9-2	Options	44
10.	Specifications	45

NOTICE / Compliance Information Statement

DJ-S45 T

This equipment has been tested and found to comply with the limits for a Class B digital device, pursuant to part 15 of the FCC Rules.

These limits are designed to provide reasonable protection against harmful interference in a residential installation.

This equipment generates, uses, and can radiate radio frequency energy and, if not installed and used in accordance with the instruction manual, may cause harmful interference to radio communications. However, there is no guarantee that interference will not occur in a particular installation. If this equipment does cause harmful interference to radio or television reception, which can be determined by turning the equipment off and on, the user is encouraged to try to correct the interference by one or more of the following measures:

- Reorient or relocate the receiving antenna.
- Increase the separation between the equipment and receiver.
- Connect the equipment into an outlet on a circuit different from that to which the receiver is connected.
- Consult the dealer or an experienced radio/TV technician for help.



**Tested to Comply
With FCC Standards
FOR HOME OR OFFICE USE**

Information in this document is subject to change without notice or obligation. All brand names and trademarks are the property of their respective owners. Alinco cannot be liable for pictorial or typographical inaccuracies. Some parts, options and/or accessories are unavailable in certain areas. Changes or modifications not expressly approved by the party responsible for compliance could void the user's authority to operate the equipment.

UHF FM Transceiver DJ-S45 T

This device complies with Part 15 of the FCC Rules. Operation is subject to the following two conditions: (1) This device may not cause harmful interference, and (2) this device must accept any interference received, including interference that may cause undesired operation.

Manufacturer:

ALINCO, Inc Electronics Division
Shin-Dai Bldg 9F, 2-6, 1 Chome
Dojimahama, Kita-ku, Osaka 530-0004 JAPAN

DJ-S45 E

DJ-S45 CQ



Conformity Information

In case the unit you have purchased is marked with a CE symbol, a copy of relative conformity certificate or document can be reviewed at <http://www.alinco.com/usa.html>.

Copyright © 2005 All rights reserved. No part of this document may be reproduced, copied, translated or transcribed in any form or by any means without the prior written permission of Alinco. Inc., Osaka, Japan, English Edition Printed in Japan.



Caution

The use of transceiver in the following places is prohibited.

- Aboard aircraft
- In airports
- In ports
- Within or near the operating area of business wireless stations or their relay stations.

Before using the transceiver in any of the above places, obtain any necessary permission from the proper authorities, and be mindful of the local laws that govern radio operation.

■ Points to Note for Using an External Power Supply

- When the power is supplied from a cigarette socket of a car, use the cigarette lighter cable (EDH-33).
- Turn the power off when connecting or disconnecting the DC cable.
- When using a commercial external antenna, install the antenna ground not to become common with the ground of the external power supply.
- This DC jack supports 3.0~6.0VDC, 2A or more external power source. Please use an appropriate, reliable power supply, and be mindful to the polarity (+ positive center).
- Use of non-genuine accessories will void ALINCO's factory warranty.

1. Functions and Features

- 39 different Tone Squelch function (CTCSS)
- TOT (Time Out Timer) function
- Tone Call function (ALT, 1750, 2100, 1000, 1450Hz)
- Reception Bell (Beeper) function
- **DJ-S45 T/E** 3 types of Scan function (VFO, Memory, Tone)
- **DJ-S45 CQ** 4 types of Scan function (LPD (VFO), Memory, Tone, PMR)
- Cable Cloning
- Rain Proof



Caution

Insert the rubber covers properly and firmly into the jacks of the external speaker, microphone, and power supply. Connecting optional accessories to the transceiver disables the rainproof function.

The **DJ-S45 CQ/T/E** is rainproof but NOT water resistant. Therefore, NEVER rinse nor immerse it in water.

1-1 Standard Accessories

- Belt Clip (with a screw)
- Hand Strap
- Instruction Manual

The accessory status may vary depending on the versions. Please consult with your local dealer for details.

2. Accessories

2-1 Attaching and Detaching Accessories

2-1-1 Antenna(**DJ-S45 T/E** only)

1. Hold the antenna by its base and turn it clockwise until it stops.
Check to be sure the antenna is securely connected.
2. Turn the antenna counter-clockwise to detach it.

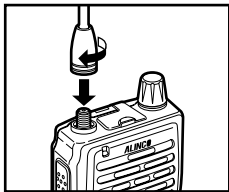

Caution

The **DJ-S45 CQ** takes fixed type antenna due to a legal requirement. NEVER try to detach it.

2-1-2 Hand Strap

1. Attach the hand strap in the upper slot at the rear of the transceiver as shown in the illustration.

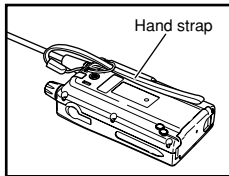

2-1-3 Belt Clip

1. Put the belt clip on the back of the transceiver.
2. Turn the screw clockwise until it stops.
Check to be sure the clip is securely installed.
3. Turn the screw counter-clockwise to detach the belt clip.

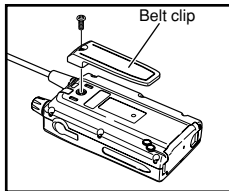

2-2 Setting Batteries

1. Open the cover latch and then open the cover.
2. Set two commercially available AA batteries in the +/- orientation marked at the internal front side.
3. Close the cover and then fix it with the cover latch.

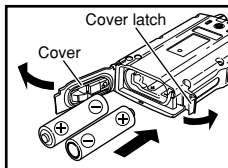

2

2-3 Lithium Ion Battery Pack [EBP-60] (Option)

Please refer to the instruction manual that comes with the battery pack for operating and charging procedures.



Caution

- Manganese batteries are not recommended as they may decrease the transmission output level.
- Be sure to observe proper orientation of the batteries polarity (+/-).
- Latest generation dry cells such as "Oxiride" batteries can be used.
- Ni-MH rechargeable cells are also usable. Please carefully read instructions of its manufacturer to properly use them.
- Regardless of the type of battery you use, please:
 - 1.Never mix the type, brand, or different status of use.
 - 2.Never remove protective materials around cells.
 - 3.Clean the contacts with a dry cloth once in a while to obtain best performance.
 - 4.Respect all the instructions given by battery manufacturer for safe and proper use.

2-4 Battery Level Indicator

- Battery consumption level may change depending on the surrounding temperature or the frequency of use.
- Even if the battery icon appears to indicate the necessity of charging the battery, it can be used further if the usage is only for low output transmission or reception.
- The default setting of the battery pack type is "bAt-1" which is for AA type cells. When using Lithium Ion battery pack, select the battery type setting to "bAt-2" in the Setting mode (page 26, ITEM No.16) to correctly indicate the battery level icon.

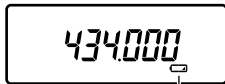

Battery icon

*When the battery level becomes low, the battery icon appears.
Charge or replace the battery.

Reference : Due to the amplification circuitry used in this unit to obtain high output with only 2 batteries, it may happen that the unit cannot be turned on when the battery voltage is getting low (while the low-battery icon is on the display), but not completely discharged yet. This is not a defect but we recommend that:

- When the low-battery icon appears, recharge or replace the batteries.
- When the low-battery icon appears, try not to turn off the radio until fully use up the battery power. When they are completely discharged the display will turn off.

3. Control Functions

3-1 Names and Operations of the Transceiver Controls

■ Top and Front Views

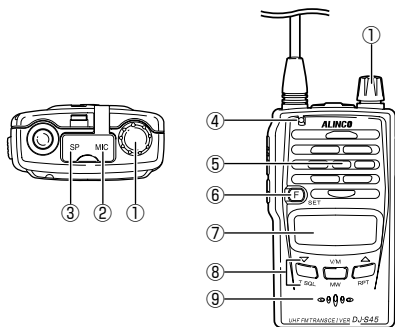

No.	Name	Functions
①	Power/Volume Dial	Switches power ON/OFF, and also adjusts the audio volume.
②	MIC Connector	For connection of the optional external microphone (2k Ω) with 2.5 ϕ stereo plug.
③	SP Connector	For connection of the optional external speaker(8 Ω) with 3.5 ϕ monophonic plug.
④	RX/TX Lamp	Illuminates green when the squelch opens and red when transmitting.
⑤	Speaker	A thin speaker is built in.
⑥	F key	Use this key in combination with other keys to access various functions of the transceiver. Holding this key for 2 seconds activates the Setting mode where various settings are possible.
⑦	Display (LCD)	Refer to "Display" in this manual (page 14).
⑧	Keypad	Refer to "Key Operations" (page 12).
⑨	Microphone	Speak into microphone from a distance of approx. 5cm at normal tone of voice.

Side Views

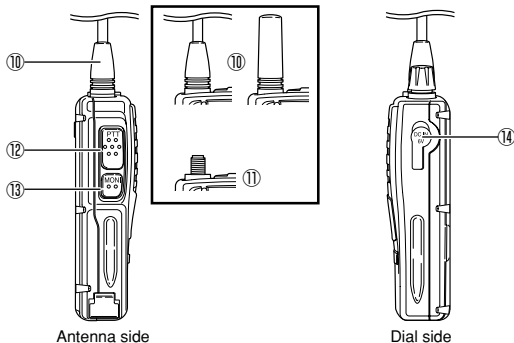

No.	Name	Functions
⑩	DJ-S45 CQ	Undetachable fixed type antenna.
⑪	DJ-S45 T/E SMA Antenna Connector	Install the included antenna. Choose an antenna which has low SWR (standing Wave Ratio) if you purchase one.
⑫	PTT (press to talk) key	While this key is held down, the transceiver transmits. When the key is released, the transceiver returns to the receive mode.
⑬	MONI key	When this key is pressed, the squelch opens and you can hear received signals. The squelch also opens when the tone squelch is set. If this key is pressed while "F" appears, the Key Lock function is activated. Pressing this key, while the PTT key is pressed and held, transmits the tone call signal.
⑭	DC-IN	Terminal for connecting an external power supply. Connect the optional cigarette lighter cable EDH-33 for mobile operation. Use a stable power supply with 3.0~6.0VDC, with a capacity of 2A or more.

3-2 Key Operations

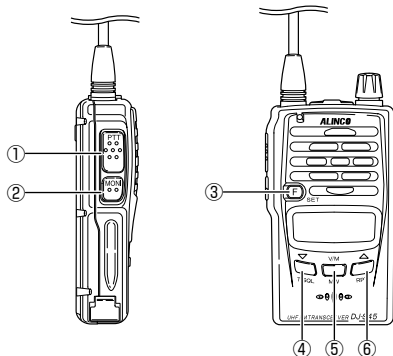

No.	Name	Independent operation	After pressing F key
①	PTT	Transmits or completes the setting in the Setting mode.	
②	MONI	Activates the monitoring function.	Switches the key lock ON/OFF (page 34).
③	F/SET	Accesses Various functions.	DJ-S45 T/E Adjusts the frequency in 1MHz step(page 17).
④	▼/T SQL	Decreases the frequency and memory channels.	Sets the tone squelch function (page 36~38).
⑤	V/M / MW	DJ-S45 T/E Switches VFO/Memory modes. DJ-S45 CQ Switches LPD (VFO)/PMR/Memory modes.	Programs memory channels (page 18).
⑥	▲/RPT	Increases the frequency and memory channels.	DJ-S45 T/E Sets the repeater functions (page 33~34).

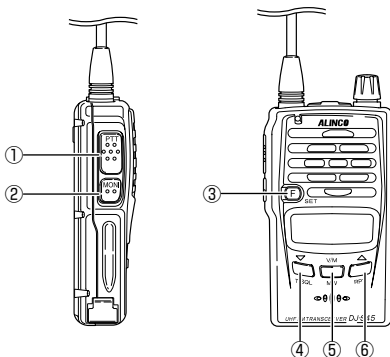

No.	Name	Pressed for a while	During transmission
①	PTT	Enables transmission while holding.	
②	MONI	Activates the monitor operation while holding (page 21).	Transmits tone call signal (page 21).
③	F	Activates the Setting mode (page 28).	
④	▼/T SQL	Pressed shorter than 2 sec., starts downward scanning, and pressed longer than 2 sec., decreases the value continuously (page 30~33).	DJ-S45 T/E Sets the transmission output level low (page 22).
⑤	V/M / MW		
⑥	▲/RPT	Pressed shorter than 2 sec., starts upward scanning, and pressed longer than 2 sec., increases the value continuously (page 30~33).	DJ-S45 T/E Sets the transmission output level high (page 22).

3-3 Display

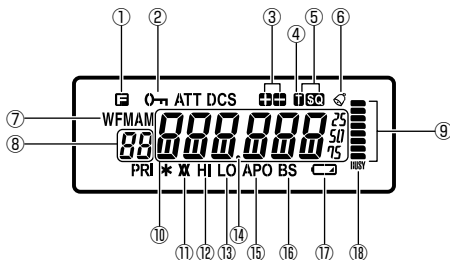

No.	Name	Indication
①		Appears when the F key is pressed.
②		Appears when keys are locked.
③		Indicates the shift (+/-) direction.
④		Appears when the tone encode (ENC) is set.
⑤		Appears when the tone squelch is set.
⑥		Appears when the bell function is ON.
⑦	W	Blinks during memory writing mode.
⑧	88	Indicates memory No. in the Memory mode and setting No. in the Setting mode.
⑨		Indicates the receiving level and the transmission output.
⑩	888888	Indicates the frequency and various setting status.
⑪	XX	DJ-S45 T/E Appears when the repeater function is set.
⑫	HI	DJ-S45 T/E Appears when transmission output level is high.
⑬	LO	DJ-S45 T/E Appears when transmission output level is low.
⑭	.	Divides MHz and kHz of the frequency. Blinks during scanning operation.
⑮	APO	Appears while the Auto-Power-Off function is ON.
⑯	BS	Appears while the Battery-Save function is ON.
⑰		Appears when the remaining battery level is low.
⑱	IUSY	Appears when the squelch opens.

*Unexplained icons are not used on this transceiver.

4. Basic Operations

4-1 Turning the Power ON

Rotate the dial clockwise.

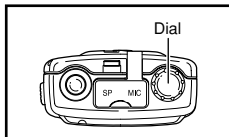

Caution

The dial also performs adjusting the audio volume. Therefore, do not rotate it far, otherwise the audio may be too loud.

To turn the power OFF, rotate the dial counter-clockwise until it clicks.

4-2 Adjusting the Audio Volume

To increase: Rotate the dial clockwise.

To decrease: Rotate the dial counter-clockwise.

When you do not hear any audio because the squelch is closed, press and hold the MONI key and adjust the volume to the suitable level by listening to the white-noise.

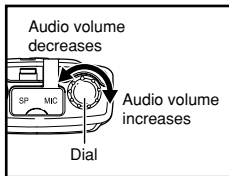

The Squelch level can be adjusted in "Adjusting Squelch Level" (page 20).

4-3 Operating Modes

The **DJ-S45 T/E** has two operating modes; VFO and Memory.

The **DJ-S45 CQ** has three operating modes; LPD (VFO), PMR and Memory.

■ Switching among modes

Every time you press the V/M key, you can change the operating mode as shown in the diagram.

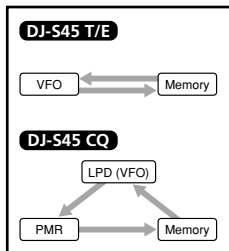

4

4-4 LPD (VFO) Mode

The factory setting is the LPD (VFO) mode.

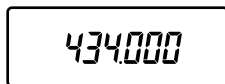

LPD (VFO) mode

4-4-1 Frequency Setting

When ▲/▼ keys are pressed, the frequency increases and decreases in tuning steps.

■ Adjusting the Frequency in 1MHz Steps(DJ-S45 T/E only)

Press the F key twice, and then the MHz figure of the display blinks.

Press ▲/▼ keys while the figure is blinking to adjust the frequency in the 1MHz increments.



4

4-5 PMR Mode(DJ-S45 CQ only)

The frequencies of PMR channels have already been programmed accordingly.

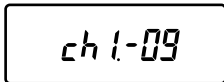

PMR mode

4-5-1 Frequency Number Setting

1. Switch to the PMR mode by pressing the V/M key.

When ▲/▼ keys are pressed, the channel increases and decreases by one channel.

4-6 Memory Mode

The Memory mode is used to call up on a previously programmed frequency. This transceiver has 100 memory channels (0~99CH).

4-6-1 Memory Channel Programming

1. Switch to the LPD (VFO) or PMR mode by pressing the V/M key.
2. Select the desired frequency or channel.
3. Press the F key, and then press the V/M key while the "F" icon appears.

The memory channel No. and the "W" icon blinks.

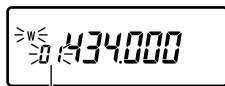

Memory Channel No.

4. Select a memory channel to program by pressing the ▲/▼ keys. Blinking memory channel No. indicates that the channel is not programmed yet. Illuminating memory channel No. indicates that the channel is already programmed.
5. Press the V/W key while the "W" icon blinks.

The selected frequency or channel is programmed to the memory channel.

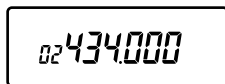

Caution

Re-editing the memory will overwrite the current data.

Reference : You can also program channels from the PMR mode if you purchased the **DJ-S45 CQ** . Its procedure is the same as the LPD (VFO) mode.

4-6-2 Selecting a Memory Channel

1. Switch to the Memory mode by pressing the V/M key. The memory channel No. appears on the display.

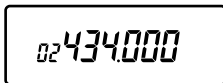

Memory mode

The Memory mode is not activated if there is no preprogrammed data in the Memory channels.

By pressing ▲/▼ keys, memory No. increases and decreases by programmed channels in numerical order.

4-6-3 Clearing a Memory Channel Data

1. Switch to the Memory mode by pressing the V/M key.

2. Press the F key, and then press the V/M key while the "F" icon appears.

Memory channel No. appears and the "W" icon blinks on the display.

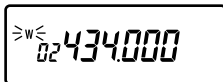

3. Select a memory channel you wish to clear by pressing the ▲/▼ keys. On a programmed channel, "memory channel No." is displayed steadily (without blinking).

4. Press the F key again, and then press the MW key while the "F" icon appears.

The pre-set data is cleared.

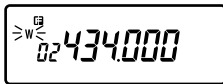

4-6-4 Programmable Items to Memory Channel

The following data can be stored in each memory channel.

- Frequency
- Offset Frequency
- Shift Direction
- Tone Frequency
- Skip CH Setting
- Tone Encoder / Decoder Settings
- Busy Channel Lock Out (BCLO)

4-7 Receiving

1. Turn the power ON.
2. Rotate the dial to adjust the audio volume.
3. Eliminate the noise by setting the squelch. Refer to "Adjusting Squelch Level" below.
4. Select the desired frequency or channel.

When a signal is received on the selected frequency, "BUSY" appears on the display and the received signal is heard. The S meter indicates the signal strength of receiving signal.

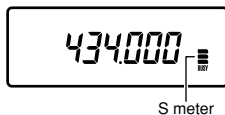

4-7-1 Adjusting Squelch Level

"Squelch" is a function for eliminating noise when no signals are being received.

Press ▲/▼ keys while the MONI key are held down. By repeating this operation, the display switches from "SqL-00" to "SqL-20". The higher the level is set, the squelch opens with the stronger signal.

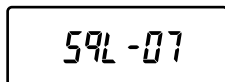

4-7-2 Monitor Function

- While the MONI key is pressed, the squelch opens and noise is heard from the speaker regardless of the squelch setting. "BUSY" appears on the display.
- Weak signals under the squelch threshold level can be heard, using this function.
- Monitoring the selected frequency can be performed even if the tone squelch is set.

4

4-8 Transmitting

1. Select the desired frequency or channel.
2. Press and hold the PTT key, speak into microphone with normal loudness and tone. The S meter indicates that the unit is in the transmitting mode. Speak into the microphone from a distance of approximately 5cm.
3. Release the PTT key to stop transmitting and to return to the receiving mode.

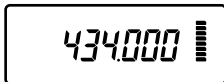

Reference : A tone call signal is transmitted by pressing and holding the PTT key and pressing the MONI key (There are 5 tone call signals that are selectable in the Setting mode).

If the PTT key is pressed when the frequency is outside of the transmitting range, "OFF" appears on the display. You cannot transmit in this status.

4-8-1 Switching of Transmission Output Level(DJ-S45 T/E only)

Transmission power can be changed to HI/LO by pressing the ▲/▼ keys while transmitting.

"LO" appears on the display when the transmitting power is low, and "HI" appears when the transmitting power is high. Initial setting is "HI".



Low



High

5. Parameter Setting Mode

In the Setting mode, you can set various functions of the **DJ-S45 CQ/T/E**.

5-1 Selectable Parameters

Please refer to "5-2 Selecting the Setting Mode" (page 28) for how to enter to the Parameter Setting mode and "9-1 Resetting" (page 43) for the initial factory (default) settings.

The ITEM No. increases when the F key is pressed, and it decreases when MONI key is pressed.

Reference : When activating the Setting mode from the Memory mode of the **DJ-S45 CQ**, the item No. differs depending on the mode which you programmed the channel.

- The ITEM No. of the LPD (VFO) mode indicates if the channel is programmed in the LPD (VFO) mode.
- The ITEM No. of the PMR mode indicates if the channel is programmed in the PMR mode.

■ StP-1250 Tuning step setting

ITEM No. 01 **DJ-S45 T/E**
01 **DJ-S45 CQ LPD (VFO) mode**

The tuning steps can be changed (5/6.25/10/12.5/15/20/25/30/50). This can be set only in the LPD (VFO) mode. ("---,---" appears in the Memory mode.)

■ SHIFt Shift direction setting

ITEM No. 02 **DJ-S45 T/E**
02 **DJ-S45 CQ LPD (VFO) mode**

Shift the transmitting frequency in relation to the receiving frequency as per the offset direction. Only + and - icons appear to indicate the direction. For simplex operation, select OFF status (without +/- icons).

■ 00.600 Offset frequency setting

ITEM No. 03 **DJ-S45 T/E**
 03 **DJ-S45 CQ LPD (VFO) mode**

This function sets the width of the frequency shift (0-99.995MHz).

■ bEP-on Beeper ON/OFF

ITEM No. 04 **DJ-S45 T/E**
 04 **DJ-S45 CQ LPD (VFO) mode** 01 **DJ-S45 CQ PMR mode**

Select ON to enable a beep that sounds after certain keys are touched and/or setting is done.

■ ALt Call tone setting

ITEM No. 05 **DJ-S45 T/E**
 05 **DJ-S45 CQ LPD (VFO) mode** 02 **DJ-S45 CQ PMR mode**

The call tone sound is selected (ALT/1000/1450/1750/2100Hz).

Set the tone burst tone with this parameter.

■ to-oFF TOT setting (seconds)

ITEM No. 06 **DJ-S45 T/E**
 06 **DJ-S45 CQ LPD (VFO) mode** 03 **DJ-S45 CQ PMR mode**

Limit the time of a signal transmission (OFF/30/60/90/---/450sec).

When the TOT time is elapsed, the transceiver automatically shifts to the receive status.

■ AP-oFF APO setting (minutes)

ITEM No. 07 **DJ-S45 T/E**
 07 **DJ-S45 CQ LPD (VFO) mode** 04 **DJ-S45 CQ PMR mode**

This function prevents wasting the battery power when you forget to turn the transceiver off (OFF/30/60/90/120min).

This function automatically turns off the power if there is no operation for the specified period of time.

■ bS-on Battery saving ON/OFF

ITEM No. 08 **DJ-S45 T/E**
 08 **DJ-S45 CQ LPD (VFO) mode** 05 **DJ-S45 CQ PMR mode**

Select ON to save the battery consumption during the stand-by status.

■ bEL-oF Bell ON/OFF

ITEM No. 09 **DJ-S45 T/E**
 09 **DJ-S45 CQ LPD (VFO) mode** 06 **DJ-S45 CQ PMR mode**

The bell function can inform you a signal is being received by a tone sound and LCD indication (Bell icon) like a pager.

■ Stb-on Stand-by-beep ON/OFF

ITEM No. 10 **DJ-S45 T/E**
 10 **DJ-S45 CQ LPD (VFO) mode** 07 **DJ-S45 CQ PMR mode**

When you release the PTT key, a beep sound is transmitted informing your partner(s) your transmission has ended.

■ bCL-oF BCLO ON/OFF

ITEM No. 11 **DJ-S45 T/E**
 11 **DJ-S45 CQ LPD (VFO) mode** 08 **DJ-S45 CQ PMR mode**

The BCLO stands for "Busy Channel Lock Out" and prohibits transmission when the channel is busy.

When BCLO is on, transmitting is available only in the following cases:

- When no signals are received ("BUSY" disappears)
- When a tone matches in the TSQ setting

■ SCAn-t Scan (timed/busy channel) switching

ITEM No. 12 **DJ-S45 T/E**
 12 **DJ-S45 CQ LPD (VFO) mode** 09 **DJ-S45 CQ PMR mode**

Choose between timed scan (SCAn-t) and busy channel scan (SCAn-b). Refer to "6-1 Scanning"(page 30) for details.

■ m**-oF Scan skip setting

ITEM No. 13 **DJ-S45 T/E**
 13 **DJ-S45 CQ LPD (VFO) mode** 10 **DJ-S45 CQ PMR mode**

Memory channel numbers that you want to skip while in Memory Scan operation. You cannot designate channels to skip if no memory channels are programmed. This can be set only in the Memory mode. ("---.---" appears in the LPD (VFO) mode and the PMR mode.)

■ EPo-oF External terminal control ON/OFF

ITEM No. 14 **DJ-S45 T/E**
 14 **DJ-S45 CQ LPD (VFO) mode** 11 **DJ-S45 CQ PMR mode**

Parameter ON outputs 3.0V from the external MIC terminal when the squelch is on (5mA max).

■ Lmp-5 Lamp ON/OFF

ITEM No. 15 **DJ-S45 T/E**
 15 **DJ-S45 CQ LPD (VFO) mode** 12 **DJ-S45 CQ PMR mode**

Select OFF to cancel illumination, ON to always illuminate, and 5 to illuminate the display for 5 seconds at each key operation (except PTT).

■ bAt-1 Battery type switching

ITEM No. 16 **DJ-S45 T/E**
 16 **DJ-S45 CQ LPD (VFO) mode** 13 **DJ-S45 CQ PMR mode**

Choose the battery type between AA cells (bAt-1) and optional Lithium Ion battery (bAt-2) to properly indicate the low-battery icon. Refer to "2-4 Battery Level Indicator"(page 9) for details of battery type.

- SHIFt Repeater shift direction setting
ITEM No. 17 **DJ-S45 T/E**
- 05.000 Repeater offset frequency setting
ITEM No. 18 **DJ-S45 T/E**
- tonE Repeater tone encoding ON/OFF
ITEM No. 19 **DJ-S45 T/E**
- 88.5 Repeater tone frequency setting
ITEM No. 20 **DJ-S45 T/E**

5 Above items No.17 to 20 are related to "Quick-Repeater-Access" ONLY. Refer to page X for operation. ITEM No. 17 and 18 set the same parameters as explained in ITEM No.2 and 3, ITEM No.19 to determine encoding status, and ITEM No. 20 to select the encoding tone.

The Mode Setting Chart is on the next page to cut off for your convenience.

5-2 Selecting the Setting Mode

1. Hold the F key down for 2 seconds.
The display changes to indicate that the Setting mode is activated.
2. Select a menu you wish to set by pressing the MONI key or F key.
3. Set the parameter or value by pressing the ▲/▼keys.
4. Press the PTT key or V/M key to complete the setting.

Switching the bell function On

Reference :

- In the offset frequency setting (ITEM No.03 and 18), MHz frequency is adjustable by pressing the V/M key.
- The last menu operated appears the next time the Setting mode is activated.
- Monitoring cannot be performed in the Setting mode.

5

Please cut off this Mode Setting Chart for your convenience.

Mode Setting Chart

ITEM NO.	Display		Functions
	DJ-\$45 CQ	LPD PMR	
01	01	SIP-1250	Tuning step setting
02	02	SHIFT	Shift direction setting
03	03	00.600	Offset Frequency setting
04	04	01	Beeper ON/OFF
05	05	02	Call tone setting
06	06	03	TOT setting (seconds)
07	07	04	APo-off APO setting (minutes)
08	08	05	Battery saving ON/OFF
09	09	06	Bell ON/OFF
10	10	07	Stb-on Stand-by-beep ON/OFF
11	11	08	bCL-oF BCLo ON/OFF
12	12	09	SCAN-t Scan (timeof/busy channel)switching
13	13	10	m**oF Scan skip setting
14	14	11	EPO-oF External terminal controlling ON/OFF
15	15	12	Limp-5 Lamp 5sec/ON/OFF
16	16	13	bA-1 Battery type (AA/Li-ion)switching
17		SHIFT	Quick-Shift direction setting
18		05.000	Repeater-Offset Frequency setting
19		tonE	Access-Tone ON/OFF
20		88.5	only Tone Frequency setting

6. Advanced Operations

6-1 Scanning

Use this function to automatically search for signals.

When a signal is received, scanning pauses, and resumes after a while depending on the settings of scanning mode.

■ Scanning Modes

Timed Scan: While the scan is pausing, when the signal disappears, the scan resumes and moves to the next channel. Even if a signal is being received, the scan resumes after five seconds.

Busy Channel Scan: While the scan is pausing, the scan resumes, only when the signal disappears.

Scanning direction can be changed by pressing the ▲/▼ keys during the operation.

Reference : Scanning in the tone-squelch operation:

The squelch opens only when the decoding tone of your unit matches the encoding tone of the incoming signal. In case the tones are different, the scan resumes automatically.

6-1-1 LPD (VFO) Scan

Scans the entire band in the LPD (VFO) mode.

1. Switch to the LPD (VFO) mode by pressing the V/M key.
2. Press and hold the ▲/▼ keys for 1 to 2 seconds to start scanning.

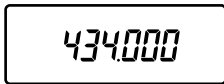

The decimal point blinks during the scan. Scanning direction goes upward by pressing the ▲ key, and downward by pressing the ▼ key.



3. To stop scanning, press the PTT key, the F key or the V/M key.

While MONI key is being pressed, scanning stops temporarily and monitor function is activated. When the key is released, scanning restarts.

6-1-2 PMR Scan (DJ-S45 CQ only)

Scans all channels in the PMR mode.

1. Switch to the PMR mode by pressing the V/M key.
2. The procedures are the same as the LPD (VFO) scan. Refer to the procedures of step2 and 3 above.

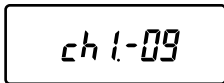

PMR mode

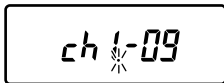

6-1-3 Memory Scan

Scans only the programmed memory channels.

1. Switch to the Memory mode by pressing the V/M key.
2. Press and hold the ▲/▼ keys for 1 to 2 seconds to start scanning.



The decimal point blinks during the scan.

The operation is the same as the LPD (VFO) scan.

3. To stop scanning, press the PTT key, the F key or the V/M key.

While MONI key is being pressed, scanning stops temporarily and monitor function is activated. When the key is released, scanning restarts.

6-1-4 Skip Channel

Memory channels where a memory skip is programmed are out of target for scanning in the memory scanning.

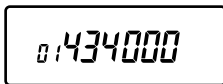

In the memory channel where a memory skip is programmed, the decimal point disappears on the display. Refer to "Scan skip setting"(page 26) for setting procedure.

6-1-5 Tone Scan

This function helps you to find the tone frequency in case CTCSS system is used.

1. Press and hold the ▲/▼ keys for 1 to 2 seconds in the tone squelch setting mode (page 36~38).

Scanning starts and the decimal point blinks.

39 kinds of tone frequencies are scanned in order.

When the tone frequency matches, scanning stops and you can hear the received signal.

Scanning will not resume until the ▲/▼ keys are pressed again.

2. To cancel the tone scan, press the PTT key, the F key or the V/M key.



LPD (VFO) mode

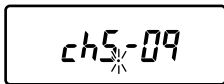

PMR mode

6

6-2 Repeater (**DJ-S45 T/E** only)

Repeaters (Automatic relay stations) are located on top of buildings or mountaintops to allow the communication with stations far away.

■ Quick-Repeater-Access Operation

1. Press the V/M key to activate the LPD (VFO) mode.
2. Press the F key, then the ▲ key while the "F" icon appears. The "XX" icon appears on the display and the repeater function is set. The shift frequency, direction and tone set in the Setting mode (page 27, ITEM No.17 to 20) are applied automatically.
3. To cancel this function, repeat the procedure step 2, and the "XX" icon will disappear.

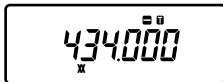

6-3 Key Lock

It is a function that prevents wrong operations when the keys are accidentally pressed.

1. Press the F key, and press the MONI key while the "F" icon appears.
The "🔒" icon appears to indicate the key lock function is activated.
2. To cancel the key lock, press the F key again, and then press the MONI key.



Reference : When the keys are locked, only the PTT and the MONI keys are active. All other keys are not operative.

Transmitting and monitoring operations are possible even when the key lock function is activated.

6-4 Tone Call (Tone Burst)

Use this function to call a partner by adding an audible tone to the transmitting signal.

The tone signal is output while the MONI key is pressed down while the PTT key is pressed and held. The call tone sound can be selected in the Setting mode (page 24, ITEM No.05).

Use this function to access tone burst system repeaters by selecting proper tone.



Caution

A tone call signal cannot be output with a tone ENC signal.
During call tone output, the ENC signal cannot be transmitted.

6-5 Channel Display Mode

This mode is to display the memory channel number only in memory mode operation.

Prior to use this mode, please program the memory channel(s).

1. Turn off, then turn on with both ▲ and ▼ keys pressed.
2. Repeat the same sequence to return to the original display indication mode.
3. Please note that in this status the operating parameters are only limited to those programmed in memory and the access to the Setting mode becomes disabled. Go back to the original display indication mode to change the parameters.

CH-01

7. Selective Communicating

When communicating with a specific station, tone squelch (CTCSS) function can be used. Tone squelch is a function that enables to receive the signal only when its encoding tone matches to your tone decode setting.

There are 39 different selectable tone frequencies/numbers.

No.	Frequency	No.	Frequency	No.	Frequency	No.	Frequency
01	67.0	11	94.8	21	131.8	31	186.2
02	69.3	12	97.4	22	136.5	32	192.8
03	71.9	13	100.0	23	141.3	33	203.5
04	74.4	14	103.5	24	146.2	34	21.07
05	77.0	15	107.2	25	151.4	35	218.1
06	79.7	16	110.9	26	156.7	36	225.7
07	82.5	17	114.8	27	162.2	37	233.6
08	85.4	18	118.8	28	167.9	38	241.8
09	88.5	19	123.0	29	173.8	39	250.3
10	91.5	20	127.3	30	179.9		

7-1 LPD (VFO) Tone Squelch

1. Press the V/M key to activate the LPD (VFO) mode.
2. Press the F key, then the T SQL key while "F" icon appears.
By repeating this process, icon rotates as shown.

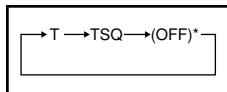

*Nothing appears on the display.

3. Change the tone frequency with ▲/▼ keys.

Select the tone frequency to use from the list above. Please note that T and TSQ tones (ENC/DEC tones) can be set separately and make sure both tones are set correctly.



4. Press the PTT key or the V/M key to complete the setting and return to the LPD (VFO) mode.

When "T" is displayed, the tone ENC is set. Only the tone transmitting functions operates (encode).

When "T SQ" is displayed, the tone squelch is set. Both the tone transmitting functions and the tone squelch operate (decode).

The CTCSS operation is deactivated when none of icons appear.

Reference : Monitoring can be performed by pressing the MONI key even during setting operation.



Caution

- The higher TSQ (decode) frequency setting may risk instable TSQ operation which the squelch may open by receiving a certain tone of voice signal close to the TSQ frequency.
- It is recommended to adjust normal squelch level anyway even TSQ is activated (page 20).

7-2 PMR Tone Squelch (DJ-S45 CQ only)

1. Press the V/M key to activate the PMR mode.

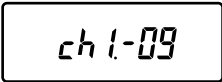
A rectangular LCD display showing the text "ch 1-09" in a digital font.

2. Press the F key, then the T SQL key while "F" icon appears. The tone number blinks. The default setting is "09".

3. Change the tone number with ▲/▼ keys.

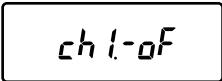
A rectangular LCD display showing the text "ch 1-0F" in a digital font.

Select the tone number to use from the list above.

4. Press the PTT key or the V/M key to complete the setting and return to the PMR mode.

Select OFF (oF) to disable the tone squelch operation. In PMR tone squelch operation, the encoding and decoding tones are always the same and cannot be set separately.

8. Cloning / Packet Operation

8-1 Cloning

When using the cloning function, all setting information (including memory data) of one transceiver (master unit) can be transferred and copied to another transceiver (slave unit) by connecting them with a cable.

■ Connecting the Transceivers

Connect the external speaker jacks on both the master and slave transceivers with commercially available ϕ 3.5 stereo mini plug cable. If you prefer to make one, please refer the chart below.

After connecting them, turn the both units' power ON.



Caution

Connect the cable only when the transceiver power is OFF.

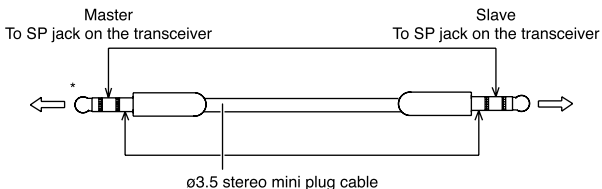

*It is not a problem if there is a connection between the top of the plug.

■ Transmitting the Master Data

1. Press and hold the MONI key and press the PTT key three times.

"CLONE" appears on the display to indicate the Clone mode is activated.



CLONE

2. Press the PTT key on the master unit.

"Sd ***" is displayed and the data-transfer starts.



Sd 078

"PASS" appears when the cloning completes.

Turn the power OFF after "PASS" is displayed.



PASS

Cloning completed

If the data is not transmitted correctly, "PASS" is not displayed. Turn the power ON again, and repeat the procedure from step 1.

3. To cancel the Clone mode, turn the power OFF.



Caution

If the cable is not connected correctly, "Err" appears on the display.

Check the cable connections again.

■ Receiving the Master Data

1. "Ld ***" appears on the slave unit's display while the master data is being transmitted.



Ld 078

"End" appears when the cloning completes.

2. Turn the transceiver power OFF.



Caution

- Do not disconnect the cable while cloning.
- All data in the slave transceiver will be updated to the master transceiver's data during the cloning operation. Be sure you want to overwrite the data before cloning.

8-2 Packet Operation (DJ-S45 T/E only)

Packet operation is one of the data communication methods, which enables data transmission and reception with personal computer through TNC.

■ Packet Operation Connections

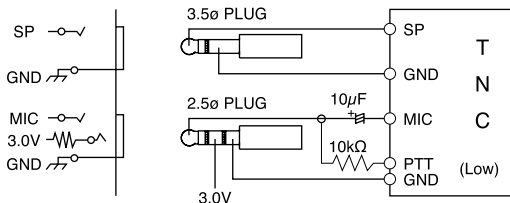

Power is supplied from internal 3V line through a 100Ω resistor.

Connection figure of the packet operation with this unit is shown above. Connect the packet communication TNC (Accessory: Terminal Node Controller) to the SP jack with 3.5ø plug, and to MIC jack with 2.5ø plug on the top of the transceiver.

- Input level adjustment : The transceiver has no MIC level adjustment circuit. Adjust the level on the TNC side.
- Output level adjustment : Use the dial on the top of the transceiver to control the output level from SP terminal.

8



Caution

- Refer to the TNC's instruction manual when connecting the TNC unit to other devices (personal computer, etc.). If the transceiver, TNC unit and connected personal computer are too close with each other, noise between them may cause interference.
- Turn the battery save function off during packet operation.
- Operate up to 1200 bps.

9. Maintenance and Reference

9-1 Resetting

When you reset the transceiver, all settings are returned to the initial factory (default) settings.

1. Turn the power ON while the F key and V/M key are held down.
2. While all the display indications appear, release the keys.

Initial Factory Settings

	DJ-S45		DJ-S45 CQ	
	T	E	LPD (VFO) mode	PMR mode
Frequency	445.000MHz	433.000MHz	434.000MHz	1ch
Memory Channel(0~99)	Unset	Unset	Unset	Unset
Tone Squelch Setting	•••	•••	•••	•••
Transmit Tone Frequency	88.5Hz	88.5Hz	88.5Hz	•••
Receive Tone Frequency	88.5Hz	88.5Hz	88.5Hz	•••
Transmit Power	LOW	LOW		
Key Lock	OFF	OFF	OFF	OFF
Squelch Level	07	07	07	07
Tuning Step	5.0kHz	12.5kHz	12.5kHz	
Shift Direction	•••	•••	•••	
Shift Frequency	5.0MHz	5.0MHz	0.6MHz	
Beeper	ON	ON	ON	ON
Tone Call	ALT	ALT	ALT	1750Hz
TOT	OFF	OFF	OFF	OFF
APO	OFF	OFF	OFF	OFF
Battery Saving	ON	ON	ON	ON
Bell	OFF	OFF	OFF	OFF
Stand-by-beep	OFF	OFF	ON	ON
BCLO	OFF	OFF	OFF	OFF
Scan Mode	Timed	Timed	Timed	Timed
Scan Skip	OFF	OFF	OFF	OFF
External Terminal Controlling	OFF	OFF	OFF	OFF
Lamp Function	ON (5sec.)	ON (5sec.)	ON (5sec.)	ON (5sec.)
Battery Type	1(AA)	1(AA)	1(AA)	1(AA)
Repeater Shift Direction	- (Minus)	- (Minus)		
Repeater Shift Frequency	5.0MHz	5.0MHz		
Repeater Tone Setting	ON	OFF		
Repeater Tone Frequency	88.5Hz	88.5Hz		

9-2 Options

EBP-60	Lithium Ion Battery Pack
EDC-138A	Quick Battery Charger 120Vac
EDC-138E/uk	Quick Battery Charger 240Vac
EDC-138R	Additional Basket (to convert EDC-138 a multiple charger)
EDH-33	Cigar DC/DC Converter
EME-12A	Head Set with VOX (Speaker Type)
EME-13A	Head Set with VOX (Earphone Type)
EME-15A	Tie Pin Microphone with VOX
EME-21A	Earphone Microphone (Heavy-Duty)
EME-23A	Earphone Microphone
EME-26	Curl-Cable Earphone
EME-6	Earphone
EMS-59	Speaker Microphone
ESC-40	Soft Case

* **DJ-S45 CQ/E** : Note for RoHS compliance

Some of the accessories listed above are not RoHS compliant at the moment this manual has been edited. Please refer an updated brochure or ask your dealer for eventual replacements at the moment of the purchase after July 2006.

10. Specifications

■ DJ-S45 CQS/CQL

General			
Frequency Range		LPD (VFO) mode	PMR mode
		TX;433.06000-434.78000MHz RX;433.06000-434.78000MHz	TX;446.00625-446.09375MHz RX;446.00625-446.09375MHz
Modulation		F3	
Ant. Impedance		50 Ω	
Supply Voltage		3.0-6.0VDC(DC-JACK), 2xAA Batteries, Li-ion pack	
Current (DC6.0V)	Transmit	LPD (VFO) mode	PMR mode
		Approx.0.20A	Approx.0.45A
	Receive	Approx. 60mA	
Frequency Stability		+5~-5ppm	
Dimension		57(W) x98 (H) x27.9 (D) mm (Projections exclusive)	
Weight		DJ-S45CQS	DJ-S45CQL
		Approx. 164g (2xAA Batteries inclusive)	Approx. 170g (2xAA Batteries inclusive)

Transmitter			
Power Output (DC6.0V)		LPD (VFO) mode	PMR mode
		Approx. 10mW	Approx. 500mW
Modulation		Variable Reactance	
Max. Deviation		+/-2.5kHz	
Spurious Emission		250nW or less	
Mic. Impedance		Approx. 2k Ω	

Receiver	
System	FM: Double-conversion super heterodyne
Intermediate Freq.	FM: 1st 21.7MHz, 2nd 450kHz
Sensitivity	-15dBu or less (12dB SINAD)
Selectivity	FM: -6dB; 6kHz or over, -60dB; 14kHz or less
AF Output	180mW or over (MAX) 150mW or over (10% Distortion Factor 8 Ω)
Spurious response	2nW or less

- Specifications may be changed without a preliminary announcement in connection with technical development.

■ DJ-S45 T/E

General		DJ-S45 T	DJ-S45 E
Frequency Range		TX: 420.000-449.995MHz RX: 420.000-473.995MHz	TX: 430.000-439.995MHz RX: 430.000-439.995MHz
Modulation		F3	
Ant. Impedance		50 Ω	
Supply Voltage		3.0-6.0VDC(DC-JACK), 2xAA Batteries, Li-ion pack	
Current (DC6.0V)	Transmit	Hi-Power Approx. 1.00A	Lo-Power Approx. 0.45A
	Receive	Approx. 60mA	
Frequency Stability		+5~-5ppm	
Dimension		57(W) x98 (H) x27.9 (D) mm (Projections exclusive)	
Weight		Approx. 162g (2xAA Batteries and SMA Antenna inclusive)	

Transmitter		Hi-Power	Lo-Power
Power Output (DC6.0V)		Approx. 2W	Approx. 0.5W
Modulation		Variable Reactance	
Max. Deviation		+/-5.0kHz	
Spurious Emission		-60dB or less	
Mic. Impedance		Approx. 2k Ω	

Receiver	
System	FM: Double-conversion super heterodyne
Intermediate Freq.	FM: 1st 21.7MHz, 2nd 450kHz
Sensitivity	-15dBu or less (12dB SINAD)
Selectivity	FM: -6dB; 12kHz or over, -60dB; 35kHz or less
AF Output	180mW or over (MAX) 150mW or over (10% Distortion Factor 8 Ω)
Spurious response	60dB or over

- Specifications may be changed without a preliminary announcement in connection with technical development.

ALINCO, INC.

Head Office:Shin-Dai building 9th Floor
2-6, 1-Chome, Dojimahama, Kita-ku, Osaka 530-0004, JAPAN
Phone:+81-6-4797-2136 Fax: +81-6-4797-2157
E-mail:export@alinco.co.jp