

ALINCO

VHF/UHF DUAL BAND FM TRANSCEIVER
ALD-24T/E

INSTRUCTION MANUAL



ALINCO ELECTRONICS INC.

INTRODUCTION

Congratulations, you are now the owner of one of the best of "ALINCO'S" many products, the ALD-24T/E. Your ALD-24T/E has been manufactured and tested very carefully at the factory and will give you satisfactory operation for many years.

CONTENTS

SPECIFICATIONS	page 1
Section 1 CONTROL FUNCTIONS	page 2
Section 2 INSTALLATION	page 6
Section 3 OPERATION	page 8
Section 4 BLOCK DIAGRAM	page 13

ACCESSORIES

Carefully unpack your transceiver and you will find the following accessories included with the transceiver.

* Microphone	x 1
* D.C. Power Cord	x 1
* Spare fuse (8A)	x 2
* Installing angle joint	x 1
* M5 x 20mm screw	x 4
* M5 x 20mm Mounting screw	x 4
* M5 Nut	x 4
* M5 Flat Washer	x 4
* M5 Spring Washer	x 4
* Screws for Bracket	x 4
* M4 x 14mm Screw	x 4
* External Speaker Plug	x 1

SPECIFICATIONS

■ General

Frequency Coverage	144.000 – 148.000MHz. (ALD-24E: 144.000 – 146.000MHz) 440.000 – 450.000MHz. (ALD-24E: 430.000 – 440.000MHz)
Frequency Resolution	5KHz step at VFO-A (ALD-24E: 12.5KHz) 25KHz step at VFO-B (ALD-24E: 25KHz)
Antenna Impedance	50 ohms unbalanced
Power Supply requirement	13.8 Volts D.C.
Current Drain at 13.8V	Receiving Squelched: does not exceed 300mA Transmitting High: 25W Approx. 5A Low: 5W Approx. 2.5A
Dimension	140mm(W) x 50mm(H) x 164mm(D) (5-1/2" x 2" x 6-1/2")
Weight	Approx. 1.2Kgs. (2.64 Lbs.)

■ Transmitter

Output Power	High: 25 Watts Low: Approx. 5 Watts
Emission Mode	16F3
Modulation System	Variable Reactance F.M.
Max. Frequency Deviation	±5KHz
Spurious Emission	More than 60dB below carrier
Microphone	Electret Condenser Microphone
Operating Mode	Simplex Duplex: ±600KHz from receive frequency at 144-148MHz (144-146MHz) : ±5MHz from receive frequency at 440-450MHz (430-440MHz)
DTMF Encoder	Built in (ALD-24T only)

■ Receiver

Receiving System	Superheterodyne, dual conversion
Modulation acceptance	16F3
Intermediate Frequency	1st 21.6MHz 2nd 455KHz
Sensitivity	12dB SINAD less than 0.16µV
Selectivity	More than ±6KHz at -6dB Less than ±12KHz at -60dB
Audio Power Output	More than 2 Watts (8 ohms - 10% Distortion)
Speaker Impedance	8 ohms

1. CONTROL FUNCTION

■ Front PANEL

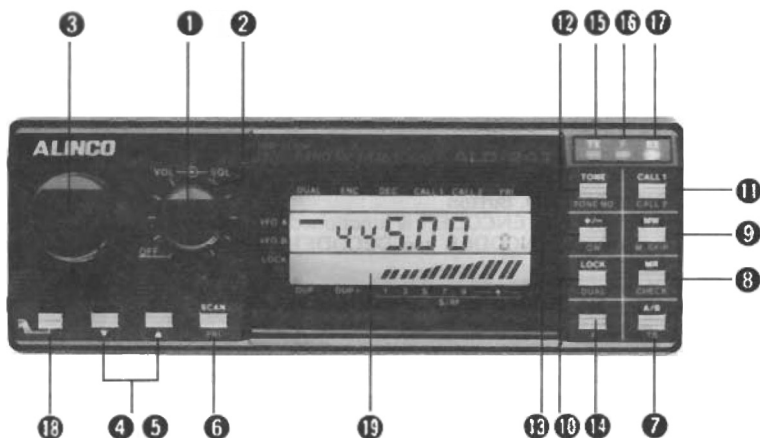

(1) ON/OFF Volume Control

When this control is turned completely counterclockwise, the power is OFF. Rotate clockwise to turn on and increase audio output.

(2) Squelch Control

With no signal present in the receive mode, adjust this control clockwise until the noise threshold is reached and RX LED goes out.

(3) Main Dial

When in VFO-A, turning this control will increase or decrease the frequency in 5KHz steps (12.5KHz – ALD-24E). The same operation in VFO-B will produce 25KHz steps. The main dial is also used to set the sub-audible tone according to table A. (ALD-24T only)

(4 & 5) UP/DOWN Buttons

By pressing the UP/DOWN button once, the frequency is increased or decreased by 1 step. Keeping either button pressed will change the frequency rapidly, 20 steps per second. The UP and DOWN buttons are also used for selection of memory channels when in the MR mode.

(6) Scan/PRI (Scan and Priority Channel Button)

This button is used for frequency/memory scanning and when in either VFO or priority scanning.

(7) A-B/TS (VFO-A, VFO-B and Channel Spacing Button)

Control is used to select VFO-A or VFO-B and to set channel spacing to 5, 10, 15, 20 or 25KHz respectively.

(8) MR/CHECK (Memory Recall/Offset Frequency Check)

Pressing this button selects the memory channel mode, or checks the input frequency for signals.

(9) MW/SKIP (Memory Write/Memory Skip Button)

Used for inserting a frequency into a memory channel or passing up a memory when in memory scan mode.

(10) LOCK/DUAL Button

Pressing this button will lock all function keys except the P.T.T. switch. It also allows you to transmit on one VFO frequency and receive on the other VFO. Used for cross band operation or ODD split.

(11) CALL 1/CALL 2 Button

Press this button, and radio is ready to operate on memory channel 1. Press F and CALL 2, radio is now ready to operate on memory channel 2.

(12) TONE/TONE NO. Button

Press this switch once, ENCODER is functioned and is displayed on LCD. Press it once more, ENCODER and DECODER are functioned and are displayed on LCD.

Pressing it the third time will disable the Tone function.

Pressing the F button and the Tone # button displays the Tone # selected.

(13) +/-/0W (Offset Write Function)

By pressing this button, $\pm 600\text{KHz}$ duplex mode will be functioned and the duplex + or - will appear on the LCD. When the + or - are not displayed on the LCD, the transceiver is in the Simplex mode. Press F button and 0W button and you can set an odd frequency split for transmit. You must also set up the 5MHz $\frac{1}{2}$ duplex operation. You must set offset in VFO-B only for this purpose.

(14) F (Function) Button

By pressing this button once, F (green LED) is lit, and the 9 function control buttons are controlled by the red labels. When it is pressed again, F LED will go out and the functions in white are used.

(15) TX LED

When transmitting, the red LED lights up.

(16) F LED

Lights up showing F button has been pushed. Light goes out when function has been completed or F button is pushed again.

(17) RX LED

Lights up when a signal is received or the squelch is opened.

(18) H/L Button (Hi-Low Power Selection)

This button is used to select Hi (25W) or Low (5W) power output.

(19) LCD Display

Shows frequency, frequency, memory channel or VFO selected. Also shows relative output power and receive signal strength.

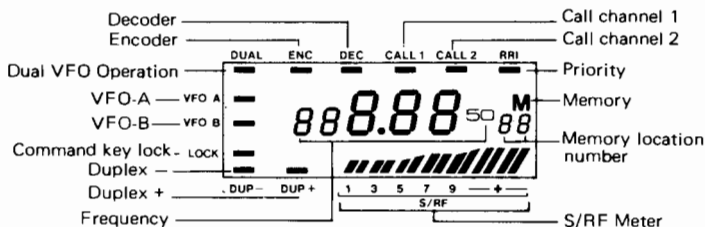

■ REAR PANEL

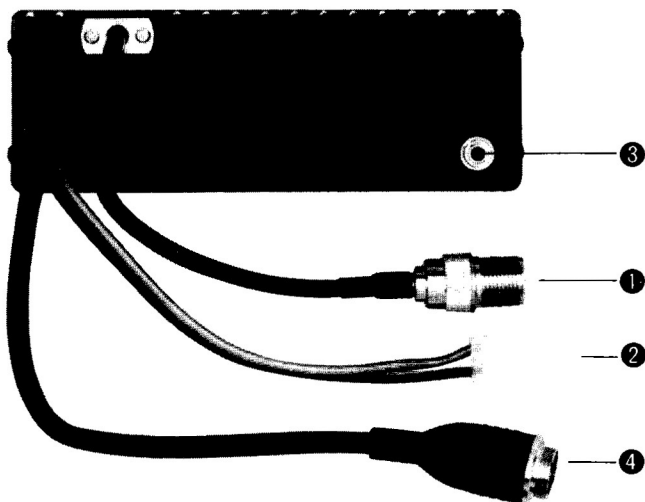

(1) Antenna Connector with internal Duplexer

Used to connect the antenna to the set.

Use a PL259 antenna-plug with 50 Ohms impedance.

(2) Power Connector

(3) External Speaker Jack

When an external speaker (Imp.: 8 Ohms) is used, connect it to this jack.

(4) Microphone Jack

An electret condenser microphone is supplied with the transceiver. Plug it into this 8-pin jack.

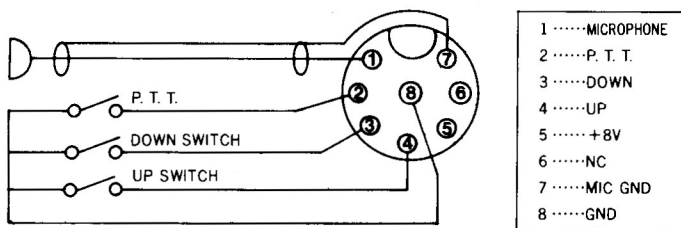

■ UPPER PANEL

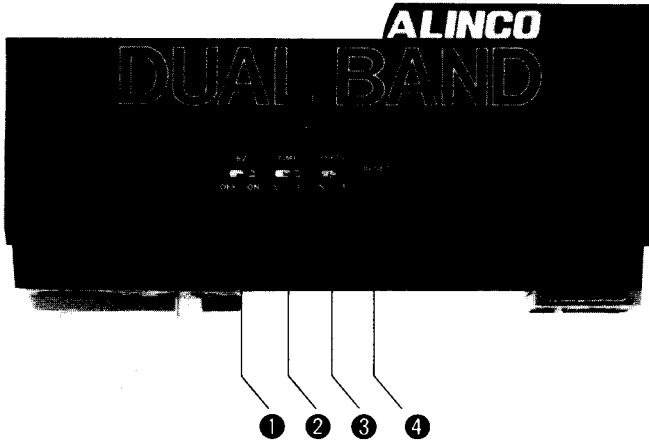

(1) BZ (Buzzer) Switch

Switches the beep sound ON or OFF.

(2) Time Selection Switch

When a signal stops the scanning function, the unit will resume scanning immediately upon loss of signal when in the "S" position.

When in the "L" position, the unit waits for 4 seconds before the scanning resumes.

(3) Speed selection Switch

Selects the scanning speed:

S (slow): 1/4 second per channel

F (fast): 1/20 second per channel

(4) Reset Button

When the power switch is ON, push this button and all memory data will be cleared.

2. INSTALLATION

■ MOBILE INSTALLATION

(1) Location

The transceiver may be installed in any position in your car, where the controls and microphone are easily accessible and safe operation of the vehicle or the performance of the set will not be interfered with.

Refer to the diagrams for installation of the Mounting Bracket.:

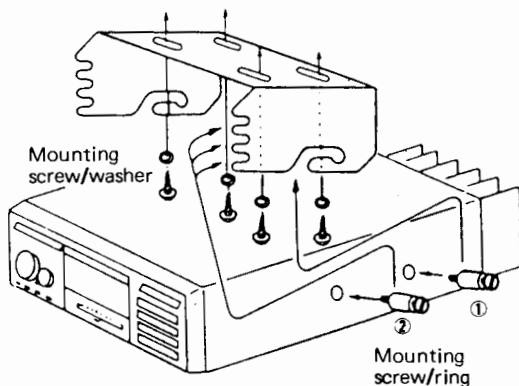
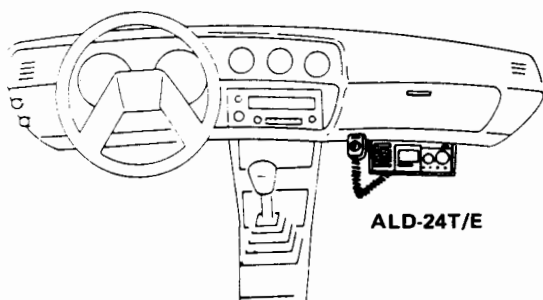

(2) Power Requirements

The transceiver can be operated from any regulated 12 or 13.8V negative ground source.

For mobile use, power connections should be made directly to the battery to minimize the possible ignition noise pickup.

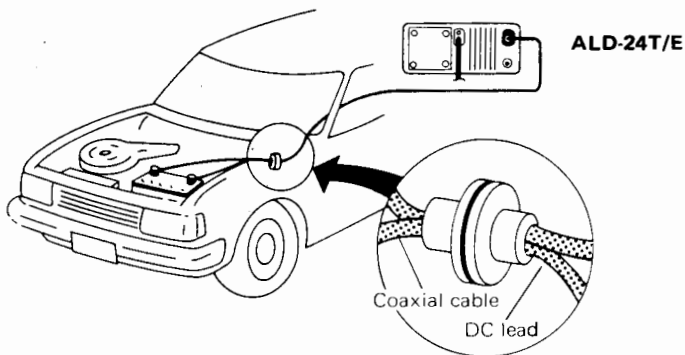

■ BASE STATION INSTALLATION

For fixed base operation, a 13.8V D.C. Power Supply capable of providing at least 8A continuously is required.

The "ALINCO" EPS-110M D.C. Power Supply is suitable for this purpose.

Connect the red lead of the power cable to the Positive (+) terminal, and the black lead to the Negative (-) terminal of EPS-110M.

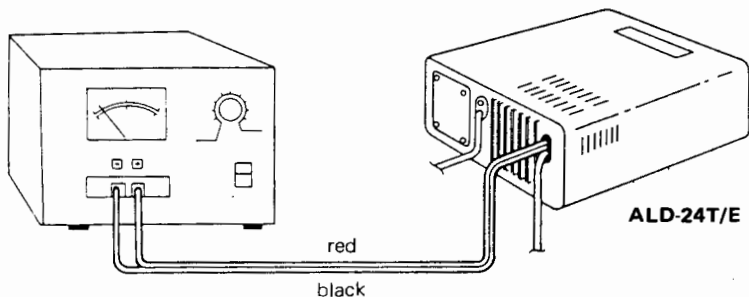

3. OPERATION

■ Initial Set Up of Radio

1. Make sure unit is turned off.
2. Adjust the squelch control completely counter clockwise.
3. Connect 50 ohm load.
4. Depress "reset" control located on the top of the radio.
5. Set 440MHz offset as follows:
 - A. Press "F" button
 - B. Press "0W" button
 - C. Rotate main dial clockwise until display shows 5.00
 - D. Press "+/-" button440 band is now set for 5MHz offset when in repeter operation.

IMPORTANT: All Functions labeled in Red **MUST** be preceded by depressing the F button.

■ Setting the Frequency

1. VFO selection:

Turn the transceiver ON/OFF switch to the ON position. If VFO-A is selected, 145.00MHz will be displayed. If VFO-B is selected, the display will show 144.00MHz.
2. Set the frequency by using the main dial (3). Rotating this dial clockwise, increases VFO frequency.
3. To adjust the frequency spacing, depress F and then TS. The display will show spacing in KHz. If you want frequency spacing other than what is displayed for VFO A/B, rotate the main dial (3) to the desired spacing (5, 10, 15, 20 or 25KHz) (E: 12.5 or 25KHz). When spacing has been selected press the T/S button again, display will return to what was shown previously.
4. To increase or decrease the frequency by the chosen MHz steps, press the UP or DOWN buttons: A beep will sound with the frequency changes. You may also use the main dial (3) to change frequency.



■ Selection of Memory Channels

1. Pressing the MR button will put the unit into the memory recall mode. Then simply press the UP and DOWN buttons to select the memory wanted (from number 01 to 21). If UP and DOWN buttons are depressed more than 0.5 sec., memory channels will change very fast and beep will sound with each change.

IMPORTANT: If frequency display is changed by button or dial while in the MR mode, you must first depress the A/B button and then depress the MR button to get back to previous display of memory channel.

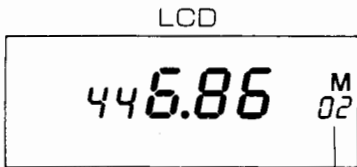

Memory location number
(ALD-24T)

2. To store a frequency in the memory:

- First depress the MR button to access the memory mode. This will be verified by the M appearing over the channel number on the right side of the display. To change memories, depress UP or DOWN button.
- Once you select the memory channel, depress the A/B button to get to the frequency selection mode. Then use the main dial and UP/DOWN buttons to set the frequency you desire to store.
- To store, press the MW button and the frequency is stored in the memory location selected.

Example: To store $f = 145.550\text{KHz}$ in memory location 10,

- Press MR . . . M will appear. $\overset{M}{00}$
- Change the number using UP or DOWN buttons until you reach memory 10.
- Press the A/B button, display shows $\overset{M}{10}$. M disappears when A/B button.
- Use the main dial or UP and DOWN buttons to set the frequency ie: VFO-B – 145.550.
- Press the MW button to store the frequency in memory channel 10.

■ **CALL CHANNEL**

This feature brings the frequency stored in $\overset{M}{01}$ or $\overset{M}{02}$ to the memory simply press CALL 1 for the 01 location or F, CALL 2 for the 02 location.

■ **Scanning Operation**

1. Normal Scanning

By pressing SCAN, the transceiver will start scanning all channels with 5KHz (12.5KHz) spacing on VFO-A and 25KHz (25KHz) spacing on VFO-B.

- The spacing can be set to 5, 10, 15, 20, 25KHz (12.5 or 25KHz) as desired.
- The scanning will stop on a strong signal. If you want to resume scanning, just press the SCAN button and the scanning will stop. Use the main dial to move the frequency UP, then press SCAN again to resume scanning.

Note: a) You can control the scanning speed by using the speed switch on the top of the transceiver [S (slow) – F (fast)].

- The time switch also determines when to resume scanning after the signal disappears.

S (short) Immediately, L (long) after 4 sec.

2. Program Scanning

Store the lower and upper frequency of the segment of the band you wish to scan in memory location number 20 and 21 respectively.

Example: You would like to scan from 145.000MHz to 146.000MHz:

- First press the MR switch and select memory $\overset{M}{20}$ location 20 by using the UP and DOWN buttons. $\overset{M}{20}$
- Press the A/B button to select the lower frequency by means of the main dial or UP and DOWN buttons 145.000MHz. Store this in memory 20.
- Repeat a) and b) for or $\overset{M}{21}$ and frequency 146.000MHz.
- Return to memory 20, then press SCAN. The radio will scan from 145.000MHz to 146.000MHz.

e) By pressing the SCAN button again, the unit will stop scanning and return to transceiver mode.

f) You can also combine bands for scanning.

- Example:
1. Enter 147.000 into memory 20
 2. Enter 442.000 into memory 21
 3. Return to lower frequency in VFO
 4. Press scan

You will now scan from 147.000 to 147.995 and 440.000 to 442.000 MHz. When unit reaches 442.000, it will return to 147.000 and stand over again.

3. Memory Scanning

This feature is used to scan the memory channels. Press MR and then SCAN. To stop memory scan, press the SCAN button again.

4. Memory Skip

This feature is to skip any memory channel during scanning.

To skip a channel in the memory:

- a) Press MR. Then use the UP and DOWN buttons to set the memory channel number you want to skip.
- b) Press F, then M-Skip, the decimal point of the frequency shown on the LCD will disappear, and this frequency will be skipped from the memory during memory scanning.
- c) To return the skipped memory, select the skipped memory number, then press F then M-Skip again. The decimal point will return back.

■ Priority

This feature allows you to monitor one memory channel in addition to whatever is in VFO A or B. To set a priority channel, do the following:

- a) Press the MR button. Select the memory frequency to be entered as the priority channel.
- b) Press A/B button.
- c) Select frequency you normally listen to.
- d) Press scan button again (without prior F). Press F, then PRI. The transceiver will allow you to operate on the frequency entered in the VFO and will sample the priority channel for 1 sec. out of every 6 sec. when signal is heard.

■ Tone Squelch (ALD-24T only)

1. To set the tone squelch feature:

- a) Press F, then the TONE button. A number will appear on LCD.
- b) Select the tone frequency according to the table below by rotating the main dial.
- c) Press the TONE button. This will put the transceiver in VFO-A or VFO-B as previously set, and the ENC indicator will appear on the LCD.
- d) By pressing P.T.T., the tone will be transmitted.

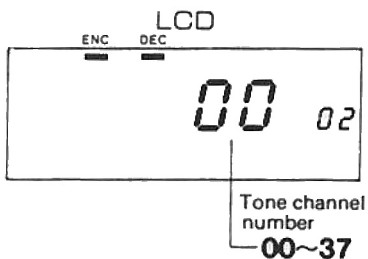

2. Tone Squelch Operation (CTCSS)

- a) By pressing the TONE button again, the DEC indicator will appear on the LCD and the receiver is put in the CTCSS mode.

Note: You can store both features as well as the channel frequency in the memory.

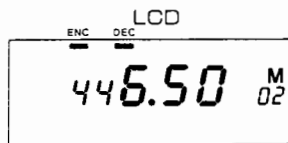

(ALD-24T)

Tone Frequency Table (Table A)

Tone Channel	Tone Freq.	Tone Channel	Tone Freq.	Tone Channel	Tone Freq.	Tone Channel	Tone Freq.
00	—	10	94.8Hz	20	136.5Hz	30	192.8Hz
01	67 Hz	11	100.0Hz	21	141.3Hz	31	203.5Hz
02	71.9Hz	12	103.5Hz	22	146.2Hz	32	210.7Hz
03	74.4Hz	13	107.2Hz	23	151.4Hz	33	218.1Hz
04	77.0Hz	14	110.9Hz	24	156.7Hz	34	225.7Hz
05	79.7Hz	15	114.8Hz	25	162.2Hz	35*	233.6Hz
06	82.5Hz	16	118.8Hz	26	167.9Hz	36	241.8Hz
07	85.4Hz	17	123.0Hz	27	173.8Hz	37	250.3Hz
08	88.5Hz	18	127.3Hz	28	179.9Hz		
09	91.5Hz	19	131.8Hz	29	186.2Hz		

■ Offset Function

1. Programming non-standard Offset

This feature is used to offset the TX above or below the RX frequency.

- a) Standard 600KHz offset is preset at the factory.

- b) To program a non-standard offset:

1. Press the F, then the 0W button.
2. Use the UP and DOWN buttons to set the desired offset spacing.
3. Press the +/- button to return the display to normal.

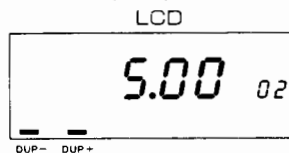

- c) You must also program the offset in VFO-B to 5.00MHz for repeater offset in the 440MHz band. Program as instructed above. Make sure you program only VFO-B for the 5.00MHz offset.

2. Offset Operation

Press the +/- button and DUP- will appear on the display, press +/- button again to get DUP+.

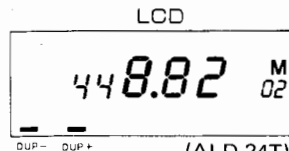

(ALD-24T)

3. Dual Operation

This feature is used to operate VFO-A and VFO-B together for non-standard operations as in CAP or MARS operation, or cross band full duplex.

- Press A/B button to access either VFO.
- Set transmit frequency using dial or UP/DOWN buttons.
- Press A/B button to change to other VFO.
- Set receive frequency as above.
- Press F button then Dual Button. Unit will now transmit on 1st VFO set and receive on 2nd.

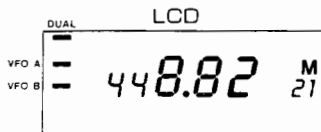

(ALD-24T)

4. Check Operation:

To check for a signal on the input frequency.

- Press F. Then press and hold check button. When holding the check button in this manner the display shows the input frequency and if any signal is present it will be heard.

5. Cross Band, Full Duplex Operation

- For optimum cross band, duplex, operation, the transmit and receive frequencies should not be selected in multiples of 3.

Example: TX - 147.50MHz, RX - 442.50 - $(147.50 \times 3 = 442.50)$ This interval of frequency spacing will result in a severe loss of sensitivity. TX and RX can be in either band.

Example: TX - 147.50MHz, RX - 442.5MHz or TX - 442.5MHz or, RX - 147.50MHz.

- Select TX frequency in either VFO (A or B) and RX frequency in the remaining VFO. Press the "Lock/Dual" Button. The frequency entered in the VFO displayed is now the receive and the other VFO is the transmit. To invert, or reverse, the TX and RX in this mode simply press the A/B button.

Note: The ALD-24T/E has an internal Duplexer, requiring a single antenna capable of operation on both the 2 meter and 70cm bands. To operate the transceiver using a separate antenna for each band will require the use of an external Duplexer. The external Duplexer is not included with the transceiver and must be purchased separately from your favorite dealer.

To connect the external Duplexer, take the single lead, on one side of the Duplexer, and connect it to the SO-239 on the back of the transceiver. Connect the remaining leads, on the other side of the Duplexer, to the 70cm and 2m antennas as indicated.

■ The Microphone

This is a electret condenser microphone with 16 buttons DTMF pad (ALD-24T). Also, on top of microphone are UP/DOWN buttons for frequency controlling functions.

4. BLOCK DIAGRAM

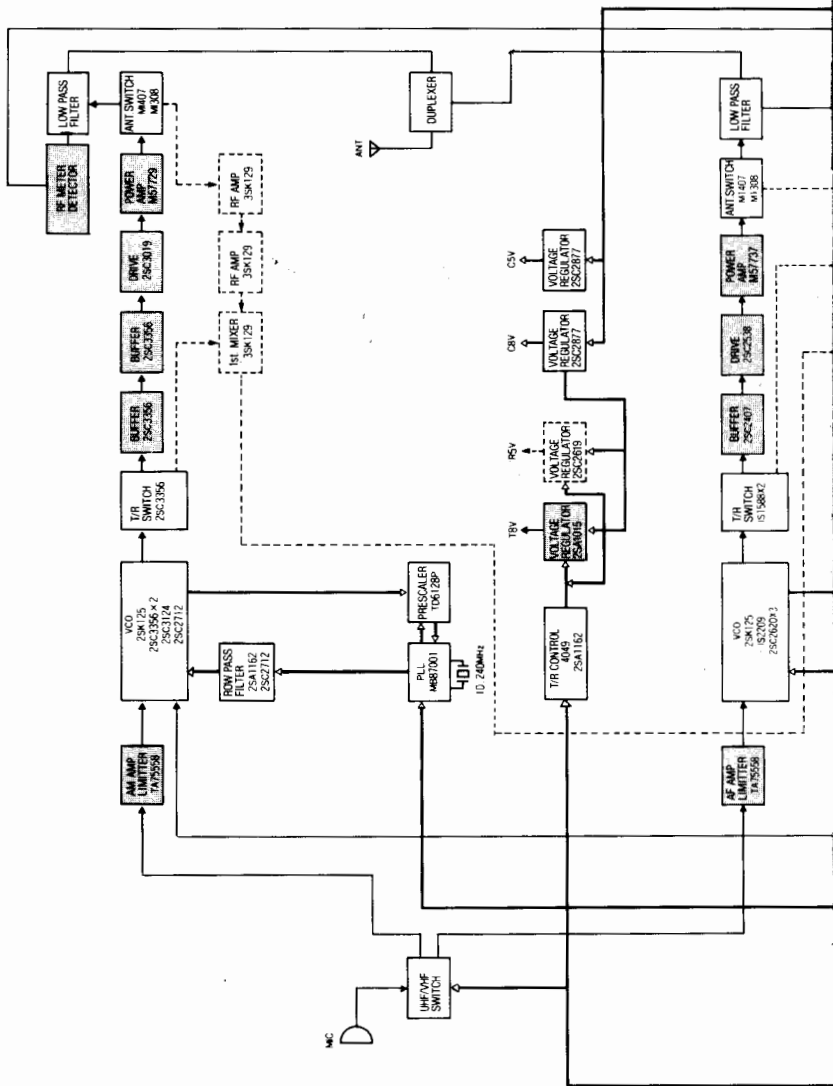



ALINCO ELECTRONICS INC.

20705 S. Western Ave., Suite 104 Torrance Ca. 90501, U.S.A.
Phone: (213) 618-8616

1-1-1 Mishimae, Takatsuki city, Osaka 569. Japan