

PTF 10048

30 Watts, 2.1–2.2 GHz, W-CDMA

GOLDMOS® Field Effect Transistor

Description

The PTF 10048 is an internally matched 30-watt GOLDMOS FET intended for WCDMA applications from 2.1 to 2.2 GHz. It operates at 40% efficiency with 10.5 dB typical gain. Nitride surface passivation and full gold metallization ensure excellent device lifetime and reliability.

- **INTERNALLY MATCHED**
- **Guaranteed Performance at 2.17 GHz, 28 V**
 - Output Power = 30 Watts Min
 - Gain = 10.5 dB Typ at 30 Watts
- **Full Gold Metallization**
- **Silicon Nitride Passivated**
- **Excellent Thermal Stability**
- **100% Lot Traceability**

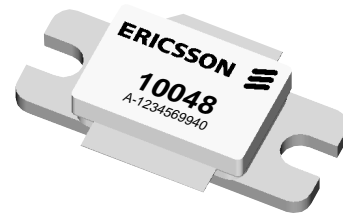
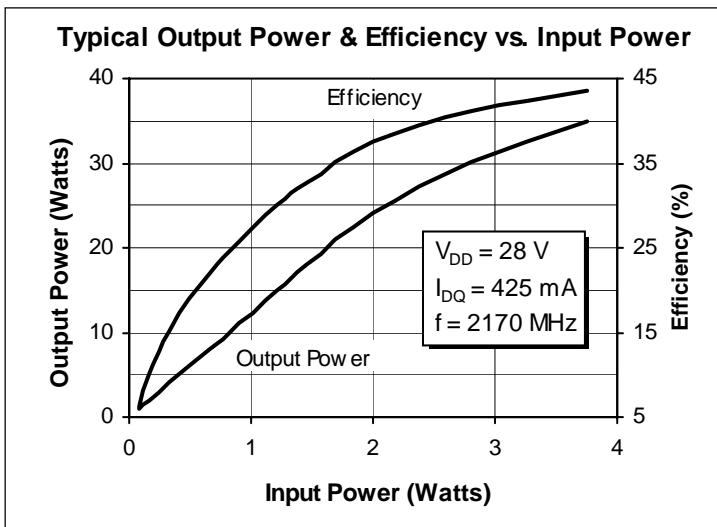

Package 20237

RF Specifications (100% Tested)

Characteristic	Symbol	Min	Typ	Max	Units
Gain ($V_{DD} = 28\text{ V}$, $P_{OUT} = 10\text{ W}$, $I_{DQ} = 425\text{ mA}$, $f = 2.11\text{ \& } 2.17\text{ GHz}$)	G_{ps}	10	11	—	dB
Power Output at 1 dB Compression ($V_{DD} = 28\text{ V}$, $I_{DQ} = 425\text{ mA}$, $f = 2.17\text{ GHz}$)	P-1dB	30	36	—	Watts
Drain Efficiency ($V_{DD} = 28\text{ V}$, $P_{OUT} = 30\text{ W}$, $I_{DQ} = 425\text{ mA}$, $f = 2.17\text{ GHz}$)	η	30	40	—	%
Load Mismatch Tolerance ($V_{DD} = 28\text{ V}$, $P_{OUT} = 30\text{ W}$, $I_{DQ} = 425\text{ mA}$, $f = 2.17\text{ GHz}$ —all phase angles at frequency of test)	Ψ	—	—	10:1	—

All published data at $T_{CASE} = 25^\circ\text{C}$ unless otherwise indicated.

Electrical Characteristics (100% Tested)

Characteristic	Conditions	Symbol	Min	Typ	Max	Units
Drain-Source Breakdown Voltage	$V_{GS} = 0\text{ V}, I_D = 50\text{ mA}$	$V_{(BR)DSS}$	65	65	—	Volts
Zero Gate Voltage Drain Current	$V_{DS} = 28\text{ V}, V_{GS} = 0\text{ V}$	I_{DSS}	—	—	1.0	mA
Gate Threshold Voltage	$V_{DS} = 10\text{ V}, I_D = 75\text{ mA}$	$V_{GS(th)}$	3.0	—	5.0	Volts
Forward Transconductance	$V_{DS} = 10\text{ V}, I_D = 6\text{ A}$	g_{fs}	—	1.8	—	Siemens

Maximum Ratings

Parameter	Symbol	Value	Unit
Drain-Source Voltage	V_{DSS}	65	Vdc
Gate-Source Voltage	V_{GS}	± 20	Vdc
Operating Junction Temperature	T_J	200	$^{\circ}\text{C}$
Total Device Dissipation Above 25°C derate by	P_D	120 0.66	Watts $\text{W}/^{\circ}\text{C}$
Storage Temperature Range	T_{STG}	-40 to +150	$^{\circ}\text{C}$
Thermal Resistance ($T_{CASE} = 70^{\circ}\text{C}$)	$R_{\theta JC}$	1.5	$^{\circ}\text{C}/\text{W}$

Typical Performance

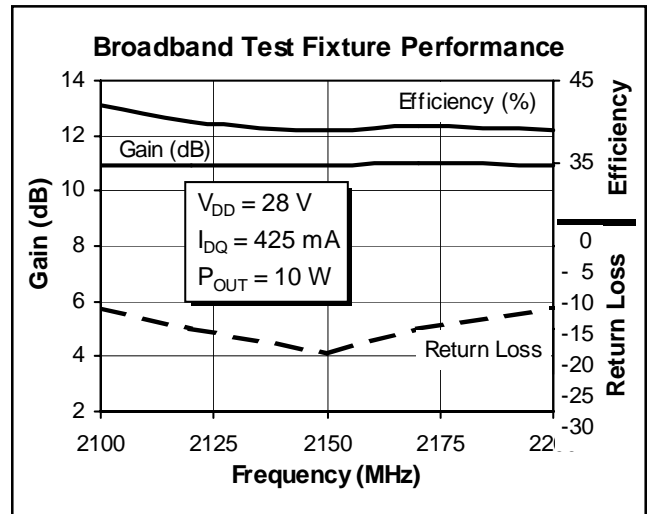
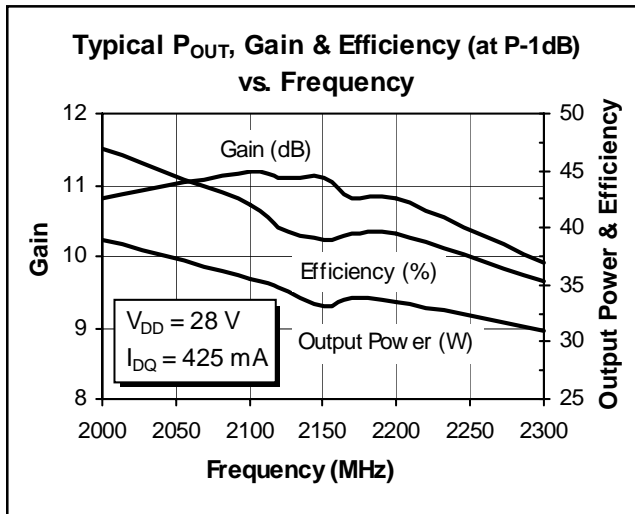

Typical Performance

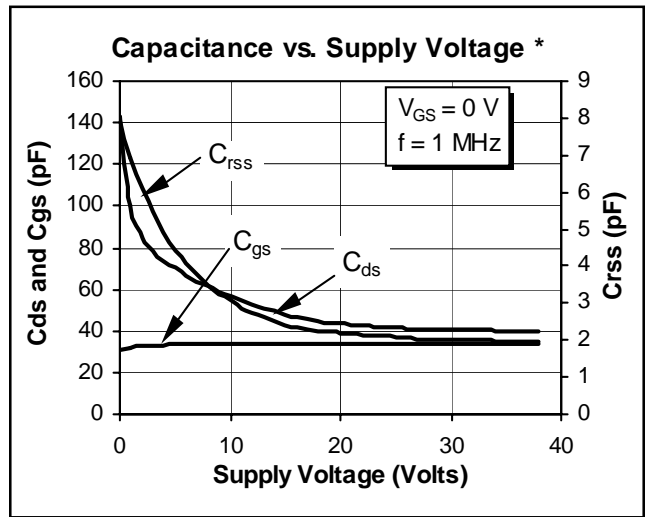
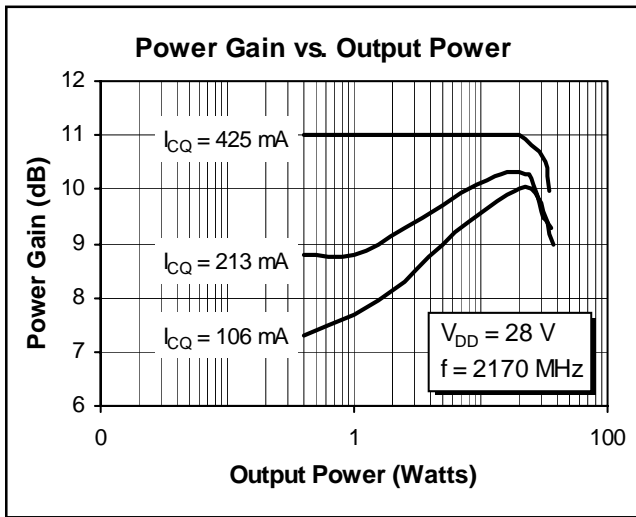
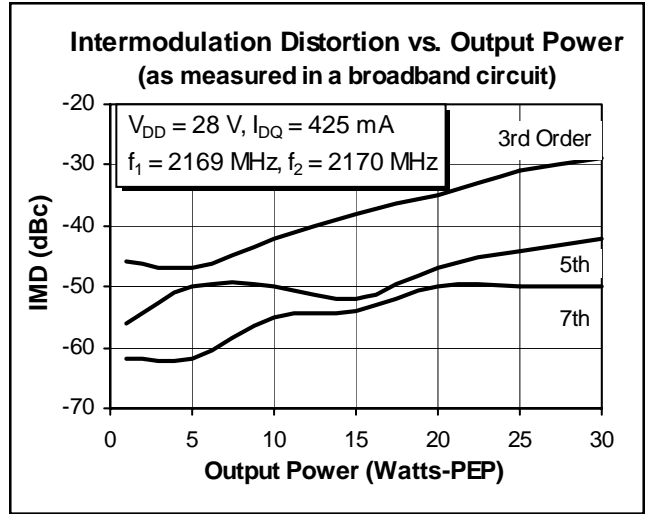
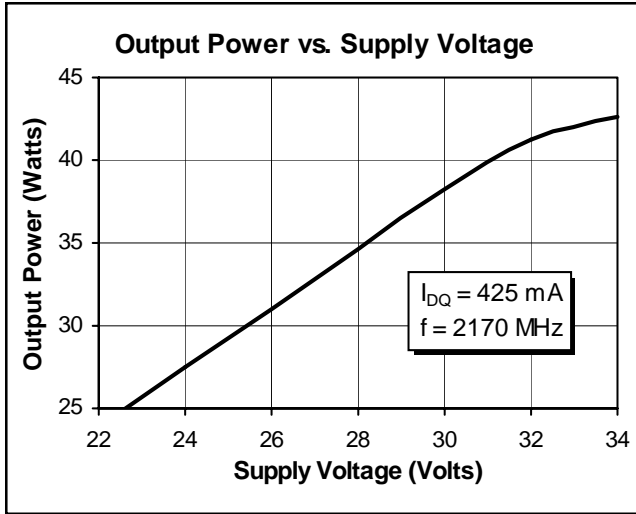

*This part is internally matched. Measurements of the finished product will not yield these figures.

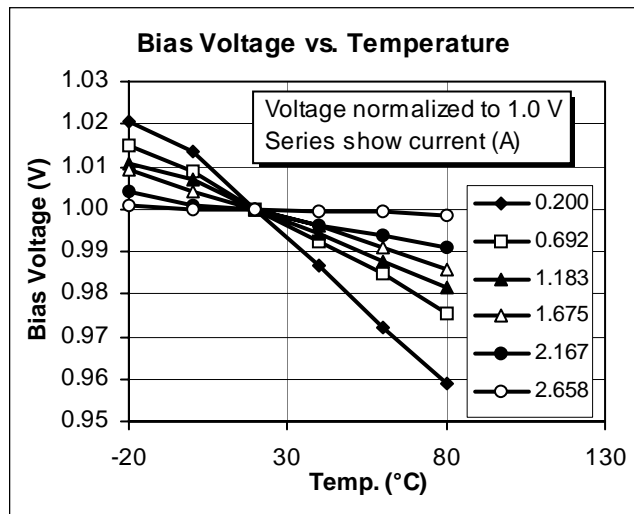

PTF 10048



Impedance Data

($V_{DD} = 28\text{ V}$, $P_{out} = 30\text{ W}$, $I_{DQ} = 425\text{ mA}$)

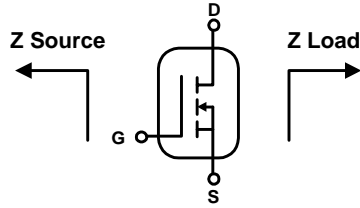

Frequency GHz	Z Source Ω		Z Load Ω	
	R	jX	R	jX
2.00	6.0	-16.7	3.6	-4.7
2.10	10.3	-19.0	3.4	-4.4
2.12	13.2	-19.3	3.4	-4.1
2.15	17.9	-17.3	3.0	-3.8
2.17	18.5	-17.2	2.8	-3.8
2.20	19.6	-12.3	2.9	-3.5
2.30	20.5	-4.6	3.0	-3.3

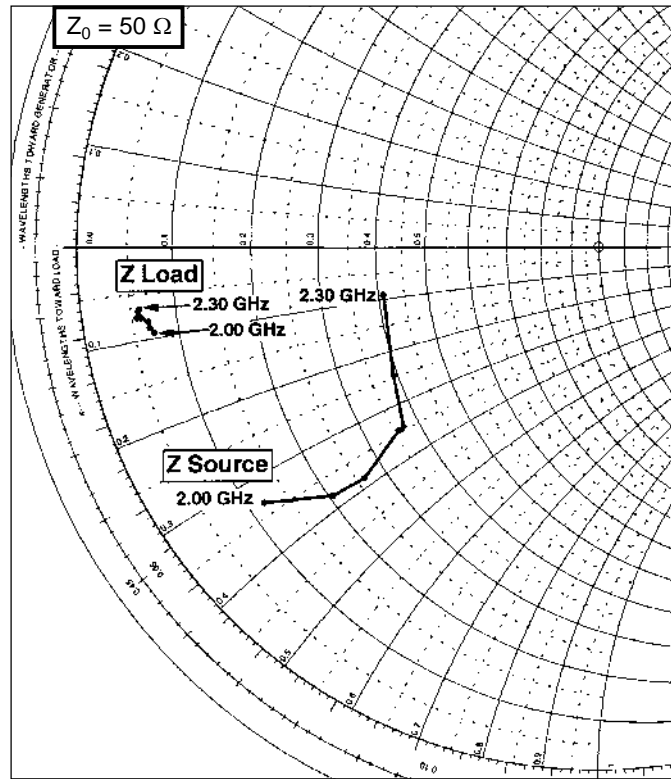

Test Circuit

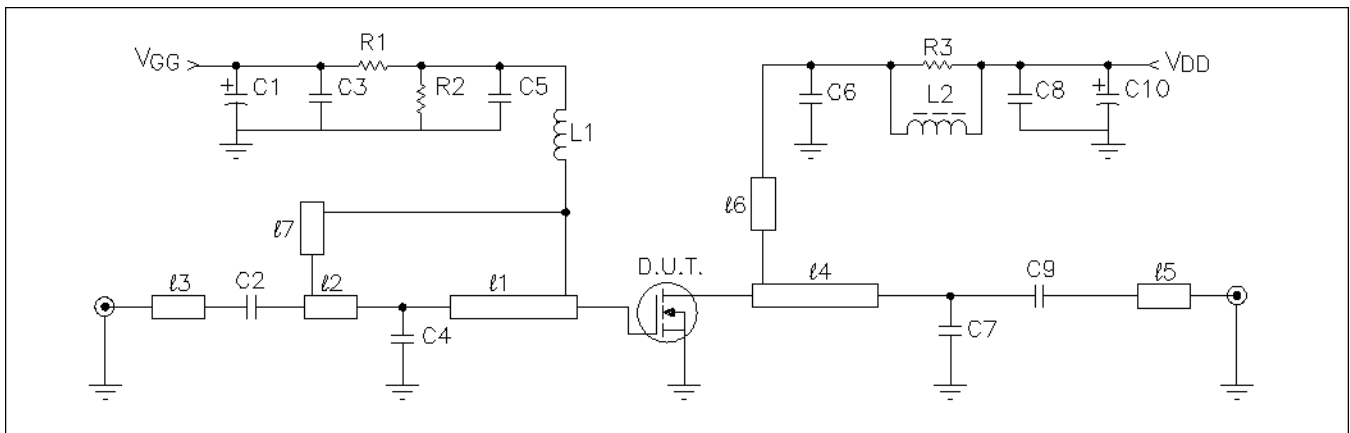

Test Circuit Schematic for $f = 2.15$ GHz

DUT	PTF 10048	LDMOS Power Transistor	J1, J2	SMA Female Connectors, Panel Mount
l1	0.052 λ 2.15 GHz Microstrip	11.14 Ω	L1	4.7 nH
l2, l5	0.255 λ 2.15 GHz Microstrip	50 W	L2	6 mm SMT Ferrite Bead
l3	0.075 λ 2.15 GHz Microstrip	50 W	R1, R2	220 Ω Chip Resistor, P220EC1
l4	0.143 λ 2.15 GHz Microstrip	10.2 Ω	R3	1.0 Ω Chip Resistor, P1.0ECT
l6	0.250 λ 2.15 GHz Microstrip	75 Ω	Circuit Board	0.031" thick, $\epsilon_r = 4.0$, G200, AlliedSignal, 2 oz. copper
l7	0.125 λ 2.15 GHz Microstrip	80 Ω		
C1, C10	10 μ F	Tantalum Capacitor		
C2, C5, C6, C9	10 pF	Chip Capacitor, ATC 100 B		
C3, C8	0.1 μ F, 50 V	Digi-Key P4525-ND		
C4	0.2 pF, 50 V	Chip Capacitor, ATC 100 A		
C7	0.9 pF	Chip Capacitor, ATC 100 A		

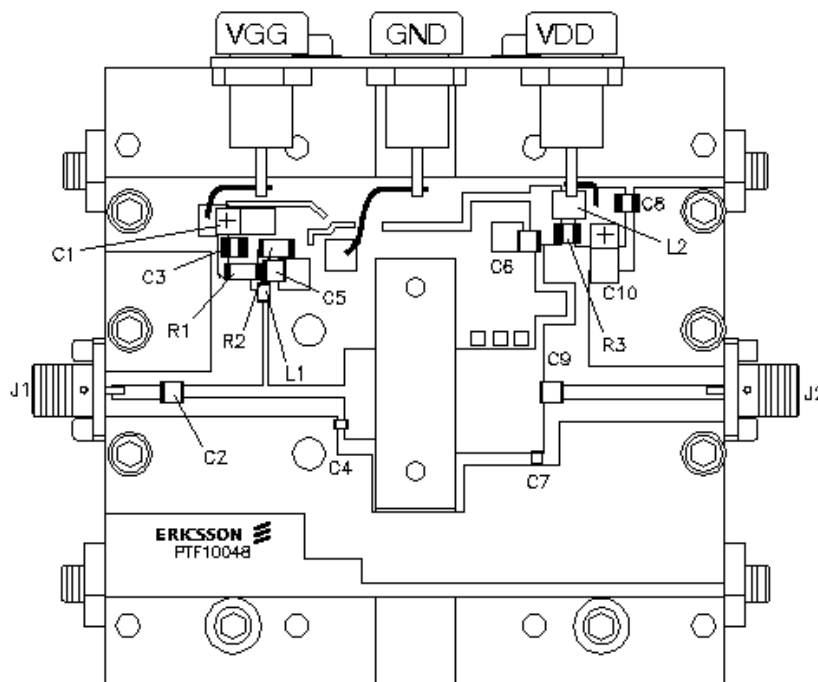

Parts Layout (not to scale)

Case Outline Specifications

