

YAESU

The radio

VHF FM TRANSCEIVER

FT-4VR

FT-4VE

Operating Manual

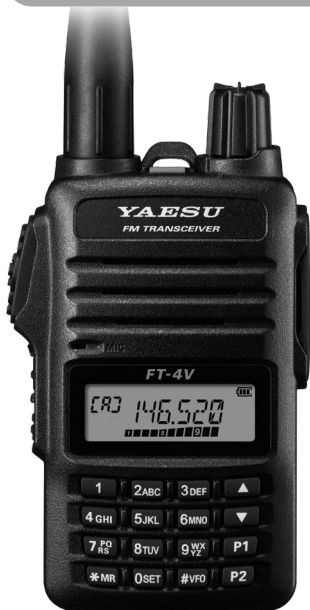







Contents

Introduction	1
About this manual	1
Quick Guide	2
Controls & Connections	3
Transceiver	3
Display	5
The Keypad Functions	7
Safety Precautions (Be Sure to Read)	8
Preparation	11
Installing the Antenna	11
Attaching the Belt Clip	11
Installing the Battery Pack	11
Removing the Battery Pack	11
Supplied Accessories and Options	12
Supplied Accessories	12
Available Options	12
Charging the Battery Pack	12
Charging the Battery Pack using the Rapid Charger (SBH-22)	12
Operation	13
Switching between the VFO-A and VFO-B	13
Tuning to a Frequency	13
Changing the Frequency Step	14
Adjusting the squelch setting	14
Transmission	14
Changing the Transmission Power Level	15
Locking Keys and PTT switch	15
Programmable key [P1]/[P2]	16
Repeater Operation	17
Communicating Via the Repeater	17
Tone Calling (1750 Hz)	17
Using the Memory	18
Registering to Memory Channels	19
Memory Recall	19
Clearing Memories	20
Recalling the Home Channels	20
Changing the Home Channel Frequency	20
Memory Channel Scanning	21
Setting the Receive Operation When Scanning Stops	21
Split Memory	22
Using Memory Tag	22
Using Memory Bank	22
Scanning Function	22
VFO Scan	22
Programmed VFO Scan	23
Weather Broadcast Channels scan (In the USA)	23
Weather Alert Scan (In the USA)	24
Skip Memory Channel	24
Programmable Memory scan (PMS)	24
Dual Receive (DW) feature	24
Convenient Functions	25
VOX Operation	25
VFO Split Mode	25
Tone Squelch feature	25
Digital Code Squelch (DCS) feature	25
New PAGER (EPCS) feature	25
Using Set Mode	26
Tables of Set Mode Operations	26
Restoring to Defaults (Reset) / Setting the Preferred Operating Mode	29
Specifications	30

Introduction

Thank you for purchasing this Yaesu product.





- FT-4VR/VE** is a handheld transceiver for operation in the 144 MHz Amateur radio bands.
- A Bridged Transless (BTL) amplifier provides One Full Watt of Audio in spite of small size.
- Two Quick Recall Keys (User Programmable) for Individual Preferences
- Lockout Capabilities for Keypad/PTT Lockout.
- Emergency Operation with Alarm and HOME channel display.

- A variety of individual selective calling functions; such as tone squelch (CTCSS) and DCS functions  28
- Large-capacity 200 memory channels  18
- 2 home channels and 10 pairs of PMS memory channels  20
- Create mnemonic tags for memory channels and PMS channel  19
- Automatic power OFF (APO) feature turns the transceiver OFF after a preset time period  26
- The cloning feature allows the memory and configuration data from one transceiver to be transferred to another **FT-4VR/VE**.....  29
- The VOX system provides automatic transmit/receive switching based on voice  28

We urge you to read this manual in its entirety, and also the Advance Manual (available for download on the Yaesu website), to gain a full understanding of the amazing capability of the exciting new **FT-4VR/VE** Transceiver.

About this manual

Reference icon symbols and conventions are used in this manual. Their meanings are described in the below chart.

Symbols	Description
	This icon indicates cautions and information that should be read.
	This icon indicates notes, tips and information that should be read.
	This icon indicates other pages containing relevant information.
	This icon indicates FT-4VR/VE Advance Manual on the YAESU Website containing relevant information.

Quick Guide

Names and display of Controls

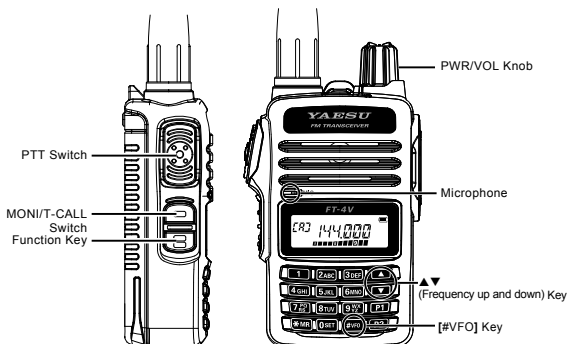

Normal operation (VFO Mode)

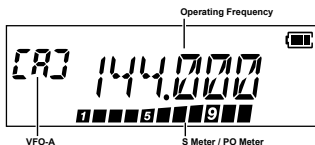

① Turning the Power ON

Rotate the until it clicks.

② Adjusting the volume

Rotate the .

③ Selecting VFO-A or B

Press the .

The operating mode changes between the VFO-A and the VFO-B.

④ Tuning the frequency

Press the or .

⑤ Adjusting the squelch setting

The squelch level may be adjusted to mute the background noise when no signal is received.

1. Press the (Function key), then press the .
2. Press the or to adjust the squelch level.

* When the squelch level is increased, the noise is more likely to be silenced, but it may become more difficult to receive weak signals.

3. Press the (Function key) to save the setting.

⑥ Transmitting Signals

● Transmitting

Press the , then speak into microphone.

Transceiver

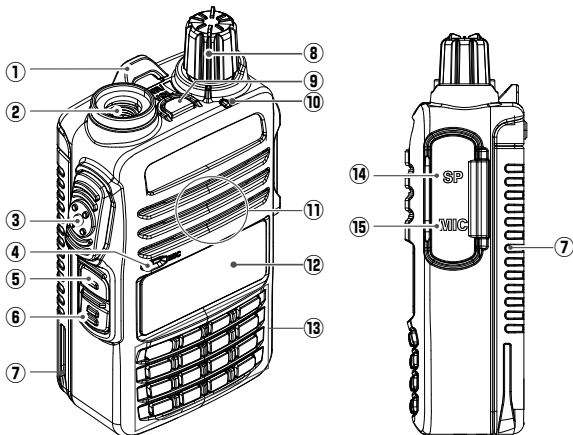

①	Strap attachment (📖 11)
②	Antenna Jack(SMA) (📖 11)
③	PTT Switch (📖 14) <ul style="list-style-type: none"> • Press and hold the PTT switch to transmit, and release it to receive. • In the Set mode, press the PTT switch to save the new setting and return to normal operation.
④	Microphone (📖 14)
⑤	MONI/T.CALL Switch <ul style="list-style-type: none"> • USA/Asian version While pressing and holding the MONI/T.CALL Switch, the squelch is opened temporarily. Press the Function key, then press the MONI/T.CALL Switch to adjust the squelch level. • European version Press the MONI/T.CALL switch to activate the T-CALL (1750 Hz).

⑥	<p>Function Key (☞26)</p> <p>Pressing the Function key activates the “Secondary” key function. Press and hold the Function key enters the Set mode. In the Set mode, pressing the Function key defines and saves the setting.</p>
⑦	<p>Battery pack(☞12)</p>
⑧	<p>PWR/VOL Knob</p> <ul style="list-style-type: none"> • Turn this control clockwise to turn the transceiver ON and to increase the volume. • Counter-clockwise rotation into the click-stop will turn the transceiver OFF.
⑨	<p>Emergency Key</p> <p>Press and hold it for three seconds to enable the Emergency Alarm beep functions and display the Home channel VHF frequency.</p>
⑩	<p>TX/BUSY Indicator Lamp</p> <p>This indicator glows green when the squelch opens, and it glows red during transmit.</p>
⑪	<p>Speaker</p>
⑫	<p>LCD (Liquid Crystal Display)</p> <p>The display shows frequency and current operating condition.</p>
⑬	<p>Keypad</p> <p>The functions of the keypad are described in detail on page 7.</p>
⑭	<p>SP jack</p> <p>SP jack provides connection for an earphone.</p>
⑮	<p>MIC jack</p> <p>MIC jack provides connection for a microphone or clone cable.</p>





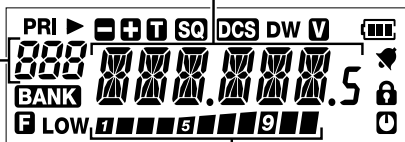





Frequency / Memory Tag / PAGER
Set Mode Item

VFO-A/B
Memory Channel Number
Home Channel Display
Memory Bank



S Meter : Displays the received signal strength
PO Meter : Displays the transmit power level

Icon	Description													
PRI	Priority Memory Channel													
	Memory channel registered as a skip memory.	24												
	Repeater Shift Direction Split Memory (two different frequencies)	17 22												
	T : Appears when the tone encoder function. T SQ : Appears when the tone squelch function.	28												
DCS	Appears when the DCS is in use.	27												
	The battery condition is displayed in 4 steps. : Full battery charge : Enough battery charge : Battery is depleted. Charge battery. : (When blinking) Charge battery immediately.	13												
F	Appears when a function key is pressed.	7												
LOW	TX Power Level Indicator (LOW/MID TX Power Selected)	15												
	<table border="1"> <thead> <tr> <th>Tx Power</th> <th>Icon</th> <th>TX Power Meter during transmission</th> </tr> </thead> <tbody> <tr> <td>HIGH (5 W)</td> <td>(No display)</td> <td></td> </tr> <tr> <td>MID (2.5 W)</td> <td>LOW</td> <td></td> </tr> <tr> <td>LOW (0.5 W)</td> <td>LOW</td> <td></td> </tr> </tbody> </table>	Tx Power	Icon	TX Power Meter during transmission	HIGH (5 W)	(No display)		MID (2.5 W)	LOW		LOW (0.5 W)	LOW		
Tx Power	Icon	TX Power Meter during transmission												
HIGH (5 W)	(No display)													
MID (2.5 W)	LOW													
LOW (0.5 W)	LOW													

Icon	Description	
DW	Appears when the Dual Receive (DW) function is enabled.	 24
	Appears when the APO (Automatic Power-Off) function is enabled.	 26
	Appears when the bell function is enabled.	 26
	Appears when the lock function is enabled.	 15
BANK	Appears when the Memory Bank function is enabled.	 22
V	Appears when the VOX (Voice Operated Transmit) function is enabled.	 28

The Keypad Functions

Key	Primary Function (Press Key)			Secondary Function (Press F + Key)	Third Function (Press and Hold for over one second)
	VFO	Memory Recall	Inputting Memory Tag		
Function	Activates the "Secondary" key function (F appears).	Activates the "Secondary" key function (F appears).	Moves the cursor to the right.	Deactivates the "Secondary" key function (F appears).	Enters the Set mode.
#VFO	Switches the band control between VHF (VFO-A) and FM RADIO Broadcast (VFO-B).	Memory Offset Tuning	—	PMS(Program Memory (Mode) Scan).	Program Scan Setting
MR	Recalls the Memory mode and activates the "Memory Tune" mode.	—	Numbers "", "+", "-", "r", "@" Press and hold this key to complete the memory channel registration	Dual Receive (DW) function	Memory write mode
P1	Recalls the stored P1(Programmable key) setting.	—	Stores to the Home channel	Recalls the Home channel.	Stores the P1(Programmable key) setting.
P2	Recalls the stored P2(Programmable key) setting.	—	Stores the Split Memory.	Reverses the transmit and receive frequencies while working through a repeater.	Stores the P2(Programmable key) setting.
1	Number "1"	Recalls the stored memory channel.	Number "1"	—	Recalls the "Weather" broadcast channel bank.
2 ABC	Number "2"	Recalls the stored memory channel.	Number "2", or characters "A", "B", "C", "a", "b", or "c"	—	Activates the ARTS feature.
3 DEF	Number "3"	Recalls the stored memory channel.	Number "3", or characters "D", "E", "F", "d", "e", or "f"	—	—
4 GHI	Number "4"	Recalls the stored memory channel.	Number "4", or characters "G", "H", "I", "g", "h", or "i"	—	—
5 JKL	Number "5"	Recalls the stored memory channel.	Number "5", or characters "J", "K", "L", "j", "k", or "l"	—	—
6 MNO	Number "6"	Recalls the stored memory channel.	Number "6", or characters "M", "N", "O", "m", "n", or "o"	—	Key Lock feature
7 PQRS	Number "7"	Recalls the stored memory channel.	Number "7", or characters "P", "Q", "R", "S", "p", "q", "r", or "s"	—	—
8 TUV	Number "8"	Recalls the stored memory channel.	Number "8", or characters "T", "U", "V", "t", "u", or "v"	—	—
9 WXYZ	Number "9"	Recalls the stored memory channel.	Number "9", or characters "W", "X", "Y", "Z", "w", "x", "y", or "z"	DTMF autodialer setting	—
0 SET	Number "0"	Recalls the stored memory channel.	Number "0" or space	—	—

Safety Precautions (Be Sure to Read)

Be sure to read these important precautions, and use this product safely.

Yaesu is not liable for any failures or problems caused by the use or misuse of this product by the purchaser or any third party. Also, Yaesu is not liable for damages caused through the use of this product by the purchaser or any third party, except in cases where ordered to pay damages under the laws.

Types and meanings of the marks



DANGER

This mark indicates an imminently hazardous situation, which, if not avoided, could result in death or serious injury.



WARNING

This mark indicates a potentially hazardous situation, which, if not avoided, could result in death or serious injury.



CAUTION

This mark indicates a potentially hazardous situation, which, if not avoided, may result in minor or moderate injury or only property damage.

Types and meanings of symbols



These symbols signify prohibited actions, which must not be done to use this product safely. For example:  indicates that the product should not be disassembled.



These symbols signify required actions, which must be done to use this product safely. For example:  indicates that the power plug should be disconnected.



DANGER

Do not use this product in an area where RF transmitters are prohibited, e.g., inside of a hospital, airplane, or train.

This product can affect electronic or medical devices.

Do not use this product while riding a bicycle or driving a car. Accidents can result.

Be sure to stop the bicycle or car at a safe place before using this product.

Do not perform transmission in a crowded place for the safety of persons using a medical device such as a cardiac pacemaker.

The radio wave emitted from this product can cause the medical device to malfunction and result in an accident.

Do not touch any material leaking from the LCD display with bare hands.

The chemical may adhere to your skin or enter your eye, and cause chemical burns. In such a case, consult the doctor immediately.

Do not touch any material leaking from the battery pack with bare hands.

The chemical that has stuck to your skin or entered your eye can cause chemical burns. In such a case, consult the doctor immediately.

Do not use this product or the battery charger anywhere inflammable gas is produced.

A fire or explosion can occur.



DANGER

Do not solder or short-circuit the terminals of the battery pack.



A fire, leak, overheating, explosion, or ignition may result.

Do not carry the battery pack together with a necklace, hairpin, or small metal objects. A short circuit can result.



If thunder and lightning develop nearby when an external antenna is used, immediately turn this transceiver OFF, and disconnect the external antenna from it.

A fire, electrical shock, or damage may result.



WARNING

Do not power this transceiver with a voltage other than the specified power supply voltage.



A fire, electric shock, or damage may result.

Do not use the battery pack for any model other than the specified transceiver.



A fire, leak, overheating, explosion, or ignition can result.

Do not make very long transmissions.



The main body of the transceiver may overheat, resulting component failure or operator burns.

Do not disassemble or make any alteration to this product.



An injury, electric shock, or failure may result.

Keep the terminals of the battery pack clean.



If terminal contacts are dirty or corroded, a fire, leak, overheating, explosion, or ignition can result.

Do not handle the battery pack or charger with wet hands. Do not insert or remove the power plug with wet hands.



An injury, leak, fire, or failure may result.

If smoke or a strange odor is emitted from the main body, battery pack, or battery charger, immediately turn the transceiver off; remove the battery pack, and remove the power plug from the outlet.



A fire, chemical leak, overheating, component damage, ignition, or failure may result. Contact the dealer from which you purchased this product or Yaesu Amateur Customer Support.

Do not use the battery pack which is externally damaged or deformed.



A fire, leak, heating, explosion, or ignition can result.

Do not use any battery charger which is not specified by Yaesu.



A fire or failure can result.

When transmitting, keep the transceiver at least 5.0 mm (3/16 inch) away from your body.



Use only the supplied antenna. Do not use modified or damaged antennas.





















If charging of the battery pack cannot be completed within the specified charging time, immediately remove the power plug of the battery charger from the outlet.



A fire, leak, overheating, explosion, or ignition can result.



CAUTION

-
-  **Do not dangle or throw the transceiver by holding its antenna.**
This may injure others and may also result in damage and failure of the transceiver.
-
-  **Do not use the transceiver in a crowded place.**
The antenna may strike others and result in an injury.
-
-  **Do not place this transceiver indirect sunlight or near a heater.**
The case may be deformed or discolored.
-
-  **Do not place this transceiver in a humid or dusty place.**
A fire or failure may result.
-
-  **While transmitting, keep the antenna as far from you as possible.**
Long-time exposure to electromagnetic waves may have a negative impact on your health.
-
-  **Do not wipe the case using thinner and benzene etc.**
Use only a soft, dry cloth to wipe stains from the case.
-
-  **If the transceiver will not be used for an extended period, turn it OFF and remove the battery pack for safety.**
-
-  **Do not drop, strike, or throw the transceiver.**
A failure or damage may result.
-
-  **Keep magnetic cards and video tape away from the transceiver.**
The data recorded on cash cards or videotapes may be erased.
-
-  **Charge the battery pack within the temperature range from +5 °C to +35 °C (+41 °F to +95 °F).**
Charging the battery pack outside this temperature range can cause leak, overheating, decrease in performance, or reduction in service life can result.
-
-  **When unplugging the power cord of the battery charger, be sure to hold the power plug.**
Pulling the power cord can damage it and cause a fire or electronic shock.
-
-  **Do not use the earpiece microphone at an extremely high volume level.**
Hearing impairment can result.
-
-  **Keep this product out of the reach of children.**
Injury to the child, or damage to the transceiver may result.
-
-  **Install the hand strap and belt clip securely.**
Improper installation may cause the FT-4VR/VE to fall or drop, resulting in an injury or damage.
-
-  **Do not place a heavy object on the power cord of the AC adapter.**
The battery cord can be damaged, resulting in a fire or electric shock.
-
-  **Do not use the included AC adapter to charge any battery pack which is not specified for use with the AC adapter.**
A fire can result.
-
-  **Do not operate the transceiver near the TV or radio.**
Radio disturbance can occur in the transceiver, the TV, or the radio.
-
-  **Do not use any products other than the specified options and accessories.**
Failure or miss operation may result.
-
-  **When the AC adapter is not in use, remove its power plug from the outlet.**
-
-  **Before discarding a depleted battery pack, affix tape or insulating covering to its terminals.**
-
-  **Be sure to check with the manufacturer of any hybrid or fuel-saving automobile regarding use of the transceiver in that car.**
Noise generated by an onboard electrical device (inverter, etc.) can disrupt the normal operation of the transceiver.
-

Installing the Antenna

- Turn the antenna clockwise until it is secured.
 - Do not hold or twist the upper part of the antenna when installing or removing it. To do so may break the conductors inside the antenna.
 - Do not key the transmit without installing the antenna. The transmitter components may be damaged.
 - When using an antenna other than the one supplied, or connecting to an external antenna, ensure that the SWR is adjusted to 1.5 or lower.



Attaching the Belt Clip

- Attach the belt clip on the back of transceiver using the supplied screws (two).
 - Be sure to use the supplied screws when attaching the belt clip. If any other screws are used, the belt clip cannot be secured firmly to the battery pack and the transceiver may drop off together with the battery pack; the transceiver and battery pack may fall off, causing injury, breakage and other damage.
 - Use a hand strap which can withstand the weight of the transceiver. If the hand strap is not strong enough, the it may break and the transceiver may fall, causing injury, breakage and other difficulty.

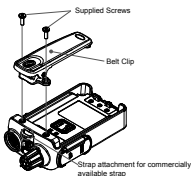

Installing the Battery Pack

- Referring to the figure at the right ①, insert the battery pack into the seals of the battery compartment on the back of the transceiver.
- Push the battery pack ② in until the battery latch clicks securely.

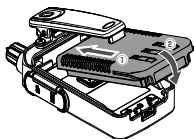

Removing the Battery Pack

- Turn the transceiver OFF. While sliding the latch in the direction of the arrow, as shown in the illustration, slide the battery pack downward and out of the transceiver.

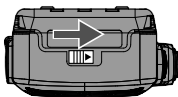

Supplied Accessories and Options

Supplied Accessories

- Rechargeable Li-Ion Battery Pack (7.4V, 1,750mAh) **SBR-28LI**
- AC adapter **SAD-20***
- Rapid Charger **SBH-22**
- Antenna **SRA-16N**
- Belt Clip **SHB-18**
- Operating Manual (this manual)
- SBR-28LI Manual

*: Depending on the transceiver version.



If any item is missing, contact the dealer from which the transceiver was purchased.

Available Options

- Rechargeable Li-Ion Battery Pack (7.4V, 1,750mAh) **SBR-28LI**
- AC adapter **SAD-20***
- Rapid Charger **SBH-22**
- VOX Earpiece Microphone **SSM-512B**
- Antenna **SRA-16N**
- Speaker Microphone **SSM-16B**
- Programming Cable **SCU-35**
- Clone Cable **SCU-36**
- Belt Clip **SHB-18**

*: Depending on the transceiver version.

Charging the Battery Pack

Charging the Battery Pack using the Rapid Charger (SBH-22)

Using the supplied SAD-20 AC Adapter and the supplied Rapid Charger, it takes about 3.5 hours* to charge the SBR-28LI battery pack fully.

*(Charging time may be increased, depending on the battery condition.)

1. Turn the transceiver OFF to install the battery pack.
2. Referring to the figure at the right, connect the battery charger plugs.

When the battery is being charged, rapid charger indicator lights red.

3. When charging is completed, rapid charger cradle indicator will light green.

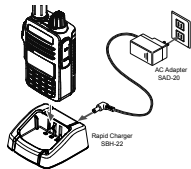





- The rapid charger indicator blinks red and the battery pack is not charged after a lapse of 10 or more hours, stop charging the battery pack immediately. The battery pack is presumed to be at the end of its service life, or defective. In this case, replace the battery pack with a new one.



- Charge the battery pack within the temperature range from +5 °C to +35 °C (+41 °F to +95 °F).

● Approximate Operating Time and Remaining Charge Level Indication

Approximate operating time for the transceiver with the fully charged lithium-Ion battery pack (SBR-28LI), and the indication of the remaining charge level of the battery is shown in the below table:

Frequency band	Band in Use Charge	Level Indication (Icon)
144 MHz band	Approx. 15 hours*	 :Full battery charge  :Enough battery charge  :Battery is depleted.  Charge battery.
FM Broadcast Band	Approx. 12.0 hours	 : (When blinking) Charge battery immediately.

*: The battery charge level calculations are based on an operating cycle of:
TX:RX:Standby = 5:5:90
(TX Power 5 W, RX audio output 200 mW, Battery save 200 ms)

Operation

Switching between the VFO-A and VFO-B

Press the [#VFO] key repeatedly to toggle the frequency control between the VFO-A and VFO-B.



To listen to the FM broadcast radio, press the [#VFO] key to change to the VFO-B. FM broadcast band may be received signals in the VFO-B mode only.

Tuning to a Frequency

- Press the [▲] key or [▼] key to tune the frequency.
By pressing the function key and then press the [▲] key or [▼] key, the frequency will change in 1 MHz steps.
- The operating frequency may be entered directly from the keypad by pressing the numbered digits on the keypad in the proper sequence.



When entering a frequency using the numeric keys, it may be canceled by pressing the PTT switch.

Changing the Frequency Step

Pressing the [▲] key or [▼] key, the frequency step may be changed. Normally, the factory default setting will provide a good frequency step.

Press and hold the Function key (Enters the Set mode)	→	Press the ▲ or ▼ key (Select Set Mode "37 STEP")	→	Press the Function key (Confirms the setting)
--	---	---	---	--

1. Press the [▲] key or [▼] key to select the desired frequency step.
2. Press the **PTT** switch to save the setting and return to normal operation.



In the default setting, the frequency step is set to "AUTO", which automatically provides a suitable frequency step according to the frequency band.

Adjusting the squelch setting

The squelch level may be adjusted to mute the background noise when no signal is present.

1. Press the function key and then press the **MONI/T-CALL** switch.
"LVL □"(0-15) will appear on the display.
2. Press the [▲] key or [▼] key to adjust the squelch to a level at which the background noise is muted.
3. Press the function key to save the setting.



- The default setting is "LVL 2".
- When the squelch level is increased, the noise is more likely to be silenced, however, at the higher setting it may become more difficult to receive weak signals.

Transmission

1. While pressing and holding the **PTT** switch, speak into the microphone.
TX/BUSY indicator lights red during the transmission.



If the PTT switch is pressed when a frequency other than the amateur ham radio band is selected, an alarm tone (beep) will be emitted and "ERROR" appears on the LCD, disabling transmission.

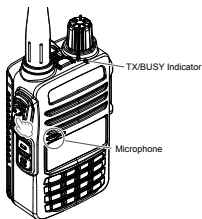

2. Release the **PTT** switch to return to receive mode.
When receiving a signal, the TX/BUSY Indicator lights green.

Changing the Transmission Power Level

Press and hold the Function key → Press the ▲ or ▼ key → Press the Function key
(Enters the Set mode) (Select Set Mode "40 TX PWR") (Confirms the setting)

1. Press the [▲] or [▼] to select one of the following transmission power levels.



TX PO Level	Icon	PO meter
HIGH (5W)*	(off)	1 ■ ■ ■ ■ 5 ■ ■ ■ ■ 9 ■ ■ ■ ■
MID (2.5W)	LOW	1 ■ ■ ■ ■ 5
LOW (0.5W)	LOW	1 ■ ■

*: The default setting.

2. Press the **PTT** switch to save the setting and return to the normal operation.



The transmission power level may be set separately for each frequency band.

Locking Keys and PTT switch

1. Press and hold the [6] key, "LOCK" is displayed on the LCD for one second, the "🔒" icon appears on the LCD, and then the keys are locked.



- The keys and the **PTT** switch may be selected to be locked using Set Mode [18 LOCK] (□□27). The default setting is the "LK KEY" (the keys are locked).
- The **MONI/T-CALL** switch, the **PWR/VOL** knob and the Emergency key cannot be locked.

2. Press and hold the [6] (LOCK) switch again, "UNLOCK" will be displayed on the LCD, the keys are unlocked.

Programmable key [P1]/[P2]

[P1] and [P2] keys may be used for the followings:

- One Touch Recall of a preferred setting
- One Touch Recall of the Mode settings

(1) One touch recall of the preferred status

1. To store a preferred setting, Press and hold one of the [P1] or [P2] keys.
2. To recall a stored one touch preferred status, press the associated [P1] or [P2] key.

(2) Set Mode Recall feature

1. Press and hold the Function key, and then press the [▲] or [▼] key to select the desired Set Mode item.
2. When the desired Set Mode item is displayed on the screen, press and hold one of the [P1] or [P2] keys to store the Set Mode item.
3. To recall a stored one touch preferred Set Mode, press a [P1] or [P2] key to recall the assigned Set Mode Item.

(3) Preset Functions assigned to the [P1] and [P2] keys

Press the Function key, then press the [P1] or [P2] keys to recall the preset functions as listed in the table at the below. These Function key functions may not be changed.

Key	Function
Function key + [P1]	HOME channel
Function key + [P2]	Reverse function

Communicating Via the Repeater

The transceiver includes an ARS (Automatic Repeater Shift) function which sets the repeater operation automatically when the receiver is tuned to the repeater frequency.

1. Set the downlink (output) frequency from the repeater.
2. “**-**” or “**+**” icons may automatically appear above the frequency,



• The reverse state

The “reverse” state temporarily reverses the transmit and receive frequencies. This allows checking to find if direct communication with the other station is possible.

1. Press the Function key, and then press the [P2] key.
The transmit and receive frequencies are temporarily reversed (“reverse” state).

In the “reverse” state, the “**-**” or “**+**” blinks on the LCD.

2. Press the Function key to exit from the “reverse” state.

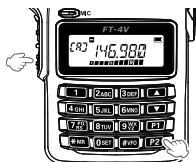

- The repeater settings may be changed from the Set Mode.
Set mode “**30 RPT.FRQ**”: Allows changing the repeater shift offset (□28).
Set mode “**31 RPT.SFT**”: Allows setting the repeater shift direction (□28).
Set mode “**29 RPT.ARS**”: Allows setting the ARS function (□28).

Tone Calling (1750 Hz)

If your transceiver is **FT-4VE** (European version), press and hold in the **MONI/T-CALL** switch to generates the 1750 Hz burst tone to access the European repeater.

The transmitter will automatically be activated, and the 1750 Hz audio tone will be superimposed on the carrier. Once the repeater has been accessed, release the **MONI/T-CALL** switch, and use the **PTT** switch to activate the transmitter thereafter.

If needed, the **FT-4VR** (USA/Asian version), may be set to access repeaters which require a 1750 Hz burst tone by setting the **MONI/T-CALL** switch to serve as a “Tone Call” switch instead. To change the configuration of the **MONI/T-CALL** switch, use Set Mode “**19 M/T-CL**” (□27).

Using the Memory

The **FT-4VR/VE** transceiver incorporates Large-capacity memory channels that can register the operating frequency, communication mode, and other operational information.

- 200 Memory Channels
- 2 Home Channels
- 10 pairs PMS Memory channel

Each memory channel can store the following information:

- Operating frequency
- Frequency steps
- TX output power
- Memory tag
- Repeater information
- Tone information
- DCS information
- Skip memory information

10 Memory Banks, labeled "BANK 1" through "BANK10". Each Memory Bank can be assigned up to 200 channels from the "standard" and "PMS" memory channels.

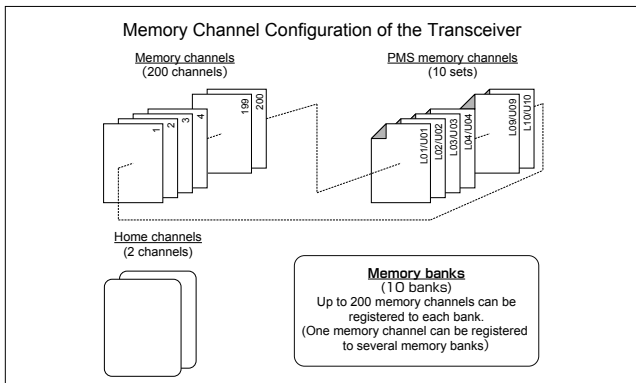

For additional details on the PMS memory channel and Memory Bank, refer to the Advanced Manual which may be downloaded from the Yaesu website.

CAUTIONS!

The information registered to memory channels can be corrupted by incorrect operation, static electricity, or electrical noise. Also, it can be erased in the event of a failure or repair. Be sure to keep a record of the settings on paper.

Registering to Memory Channels

1. Set the frequency and the communication mode to be registered to a memory channel.
2. Press and hold the [***MR**] key.
A blank memory channel will be displayed automatically.
3. Press the [**▲**] key or [**▼**] key to select the desired channel number.
4. Input the memory tag
Use the numeric keys to input the characters.
If not inputting a "Tag" (label), proceed to step 5.



Input Character

Example: Press the [2] key repeatedly to toggle among the following available characters.

2 → A → B → C → a → b → c → 2 → ...

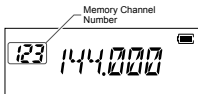

Press the function key to move the cursor.

5. Press and hold the [***MR**].
The beep sounds and the memory is saved.

Memory Recall

1. While operating in the VFO mode, press the [***MR**] key to enter the Memory mode.
The memory channel most recently used appears on the LCD.
2. Press the [**▲**] or [**▼**] key to select the desired memory channel.
When the transceiver is already set to the Memory mode, an easy way to recall a memory channel is to enter the memory channel number using the numeric keypad.
3. Press the [***MR**] key to exit the memory mode, and return to VFO operation.

- To recall Memory Channel #200, enter "200". To recall Programmable Memory channels "L01/U01" through "L10/U10" enter "201/202" through "219/220".
- The FT-4VR/VE may be set to operated only in the registered memory channels. Press and hold the **MONI/T.CALL** key and the **PTT** switch simultaneously, while turning the radio **ON** to enter the preferred operating mode.
In the preferred operating mode, press the [**▲**] key or [**▼**] key to select the [**F5 M-ONLY**], then press the function key to enter the Memory Channel Only mode. To cancel the Memory Channel Only mode, press the [**▲**] key or [**▼**] key to select the [**F5 M-ONLY**], then press the function key again.



Clearing Memories

Press and hold the Function key (Enters the Set mode)	→	Press the ▲ or ▼ key (Select Set Mode "20 MEM DEL")	→	Press the Function key (Confirms the setting)
--	---	--	---	--

1. Press the [▲] key or [▼] key to select the memory channel from which the data is to be cleared.
2. Press the function key.
"del OK" appears on the LCD and the memory channel is cleared.
3. Press the **PTT** switch to save the setting and return to the normal operation.



Data on memory channel One, and the Home channel cannot be cleared.

Recalling the Home Channels

1. Press the Function key, and then press the [P1] key.
"H" and the home channel frequency of the currently selected band appears on the LCD.
2. Press the [#VFO] key or press the Function key, and then press the [P1] key to return to the previous frequency.



Changing the Home Channel Frequency

1. Set the frequency and the operating mode that are to be stored as the home channel.
2. Press and hold the [*MR] key.
A blank memory channel will be displayed automatically.
3. Press the [P1] key.
"HOM-IN" is displayed, the Home channel frequency is changed and the radio is returned to normal operation.

Memory Channel Scanning

The receiver may be set to scan memory channels:

1. While operating in the VFO mode, press the [***MR**] key to enter the Memory mode.
2. Press and hold the [**▲**] key or [**▼**] key.
Scanning starts of the memory channels begins.
If the scanner halts on an incoming signal, the back light will turn ON and the decimal point between the "MHz" and "kHz" digits of the frequency display will blink.
3. Press the function key to cancel the scanning.

Setting the Receive Operation When Scanning Stops

Press and hold the Function key (Enters the Set mode)	→	Press the ▲ or ▼ key (Select Set Mode "34 SCN.RSM")	→	Press the Function key (Confirms the setting)
--	---	--	---	--

1. Press the [**▲**] key or [**▼**] key to select the operation that is to be performed after the scan stops:

Display	Description
BUSY (Default setting)	In BUSY mode, the scanner will halt on a signal it encounters. Scanning will resume two seconds after the other station signal ceases transmitting. In the case of constant-carrier signals like Weather Station broadcasts, the scanner will likely remain on this frequency indefinitely.
HOLD	In HOLD mode, the scanner will halt on a signal it encounters. Scanning will only resume when it is manually re-initiated.
TIME	In TIME mode, the scanner will halt on a signal it encounters, scanning will resume after five seconds even if a signal is still on the frequency.

2. Press the **PTT** switch to save the setting and exit to normal operation.



The above Set Mode [**34 SCN.RSM**] operation is common for all scanning operations.



For additional details on the following functions, refer to the **Advanced Manual** which may be downloaded from the Yaesu website.

Split Memory

Two different frequencies, one for receive and another for transmit, may be stored in one memory channel.

Using Memory Tag

Memory name tags may be assigned to the memory channels and home channels.

Using Memory Bank

The transceiver allows using up to 10 memory banks to allow sorting and registering the channels in convenient groups.

Scanning Function

The transceiver supports the following four scanning functions:

- VFO Scan
- Programmed Scan
- Memory Channel Scan
- Programmable Memory Scan(PMS)
- Memory Bank Scan



For additional details on the **Programmable Memory Scan (PMS)** and **Memory Bank Scan**, refer to the **Advanced Manual** which may be downloaded from the Yaesu website.

VFO Scan

VFO scan function scans the frequencies, and detects signals.

- Press and hold the [▲] key or [▼] key to start scanning in the VFO mode.
- Press the **PTT** switch, [▲] or [▼] key to cancel scanning.



- If scanning is in operation when the transceiver is turned OFF, then when it is turned ON again, scanning will resume instantly.
- To set the transceiver action when scanning stops, see "Setting the Receive Operation When Scanning Stops" on page (□21).

Programmed VFO Scan

The scan condition may be selected for VFO scanning.

1. Press the [#VFO] key to enter the VFO mode.
2. Press and hold the [#VFO] key.
3. Press the [▲] or [▼] key to select the bandwidth for Programmed VFO scanning.

Display	Description
BAND (default setting)	The scanner will sweep frequencies on the current operating band.
+1MHz	The scanner will sweep ± 1 MHz from the operating frequency.
+2MHz	The scanner will sweep ± 2 MHz from the operating frequency.
+5MHz	The scanner will sweep ± 5 MHz from the operating frequency.
ALL	The scanner will sweep all frequencies.
PMS-X	The scanner will sweep frequencies designated by the currently selected PMS (Programmable Memory Scan) frequency pair.



PMS-X will appear in the [#VFO] selections after setting a PMS frequency pair. See the Advance Manual for detail.

Weather Broadcast Channels scan (In the USA)

In the USA, the VHF Weather Broadcast Station Memory Channel Bank has been pre-programmed at the factory for immediate access to NOAA weather information stations.

1. Press and hold the [1] key to recall the Weather Broadcast Memory Bank.
2. Press the [▲] or [▼] key to select the desired Weather Broadcast channel.

3. To scan for additional or stronger Weather stations, just press the **PTT** switch (or press and hold the [▲] or [▼] key).

When the scanner pauses on a station, press the **PTT** switch once to halt the scan, or press the **PTT** switch again to restart the scan.

CH	Frequency	CH	Frequency
1	162.550 MHz	6	162.500 MHz
2	162.400 MHz	7	162.525 MHz
3	162.475 MHz	8	161.650 MHz
4	162.425 MHz	9	161.775 MHz
5	162.450 MHz	10	163.275 MHz

4. To return to normal operation, press the [*MR] key, or press and hold the [1] key again.

Weather Alert Scan (In the USA)

This feature allows you to check the Weather Broadcast Memory Channels for the presence of the NOAA Alert Tone while operating using VFO scan or Memory channel scan.

When the Weather Alert Scan feature is engaged, the **FT-4VR/VE** will check the Weather Broadcast Channels for activity every five seconds while scanning. If you watch the display carefully, you'll observe the scanner periodically shifting to the Weather Broadcast channel, scanning the Weather channels quickly in search of the Alert Tone, after which regular scanning will resume for another five seconds.

1. Press and hold the Function key to enter the Set Mode.
2. Press the [**▲**] key or [**▼**] key to select the "**46 WX ALT**".
3. Press the Function key, then press the [**▲**] key or [**▼**] key to select "**ALT. ON**".
4. Press the **PTT** switch to save the setting and return to normal operation.
5. Press and hold the [**▲**] key or [**▼**] to start scanning.

Scanning starts and the display will remain on the VFO frequency, but every five seconds the transceiver will scan the Weather Broadcast Channels for activity.

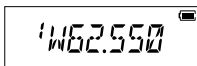

6. Press the [***MR**] key to return to normal operation.



For additional details on the following functions, refer to the **Advanced Manual** which may be downloaded from the **Yaesu website**.

Skip Memory Channel

Skip memory channels: Permits designating undesired channels to be skipped during scanning.

Programmable Memory scan (PMS)

This function scans only the range of frequencies between the lower and upper limits registered in a pair of PMS Programmable Memory channels. 10 sets of PMS memory channels (L01/U01 to L10/U10) are available.

Dual Receive (DW) feature

The transceiver checks for signals on the frequency registered to the selected memory channel (Priority Memory Channel) once approximately every 5 seconds.

VOX Operation

The VOX system provides automatic transmit/receive switching based on voice input. With the VOX system enabled, you do not need to press the PTT switch in order to transmit. Optional VOX earpiece microphone (SSM-512B) is also available.

VFO Split Mode

Two different frequencies, one for receive and another for transmit, may be operated.

Tone Squelch feature

The tone squelch opens the speaker audio only when a signal containing the specified CTCSS tone is received. By matching the tone frequency with the partner station in advance, a quiet standby is possible.

Digital Code Squelch (DCS) feature

DCS (Digital Coded Squelch) function allows audio to be heard only when signals containing the same DCS code are received.

New PAGER (EPCS) feature

This new feature allows calling specified stations only, by using a pager code that combines two CTCSS tones. Even when the person who is called is not near the transceiver, the information is displayed on the LCD indicating that a call was received. When the call is received, the bell sounds. The transceiver is automatically placed in transmit mode (for about 2.5 seconds) when called by the other party, and notifies the other party that you are ready to communicate.

Using Set Mode

The Set Mode permits configuring the various functions according to individual operating needs and preferences.

1. Press and hold the Function key.
The previously selected Set Mode item is displayed.
2. Press the [▲] key or [▼] key to select the desired Set Mode item.
3. Press the function key, then press the [▲] key or [▼] key to change the setting.
4. Press the **PTT** switch to save the settings and return to normal operation.



- In step 4 above, press the Function key to save the new setting and return to Set Mode item to set the other Set Mode.
- On some setting screens, key operation is different than described in the above steps (For example, inputting the characters, etc.). Refer to the Advance manual.



For additional details, refer to the Advanced Manual which may be downloaded from the Yaesu website

Tables of Set Mode Operations

No.	Set Mode item	Description	Selectable options (Options in bold are the default settings)
1	APO	Sets the length of time until the transceiver turns off automatically.	OFF / 0.5 Hours – 12 Hours
2	AR BEP	Sets the beep option during ARTS operation.	OFF / INRANG / ALWAYS
3	AR INT	Sets the polling interval during ARTS operation.	25 SEC / 15 SEC
4	BCLO	Turns the busy channel lockout function ON/OFF.	BCL.OFF / BCL.ON
5	BEEP	Sets the beep function on pressing the keypad, or stopping the receiver scanning.	KEY+SC / KEY / OFF
6	BELL	Selects the number of CTCSS/DCS/PAGER/ARTS Bell ringer repetitions.	OFF / 1 T / 3 T / 5 T / 8 T / CONT
7	CWID	Turns the CW Identifier ON/OFF during ARTS operation.	TX OFF / TX ON

No.	Set Mode item	Description	Selectable options (Options in bold are the default settings)
8	CW WRT	Sets the CW ID during ARTS operation.	ID= _____ (6 characters) default: blank
9	DC VLT	Displays the voltage.	(Voltage)
10	DCS.COD	Sets the DCS CODE RX and TX.	104 DCS CODEs / OFF default: 023 R / 023 T
11	DT DLY	Sets the DTMF code transmission delay time.	50MS / 250MS / 450MS / 750MS / 1000MS
12	DT SET	Selects the DTMF auto dialer memory channel and edits the DTMF code (Maximum 16 digits)	d1 – d9
13	DT SPD	Sets the DTMF code transmission speed.	50MS / 100MS
14	EDG.BEP	Turns the Band-edge beeper ON/OFF. While selecting the frequency via the [▲] or [▼] key.	BEP.OFF / BEP. ON
15	LAMP	Selects the LCD/Keypad Lamp mode.	5 SEC / 10 SEC / 30 SEC / CONT / OFF
16	LED.BSY	Turns the TX/BUSY indicator ON/OFF while receiving signals.	BSY ON / BSYOFF
17	LED.TX	Turns the TX/BUSY indicator ON/OFF while transmitting signals.	TX ON / TXOFF
18	LOCK	Configures the lock mode setting.	LK KEY / LK PTT / LK P+K
19	M/T-CL	Selects the function of the [MONI/T-CALL] switch.	MONI / TC1750* / TC2100 / TC1000 / TC1450 (*: European / Asian Version)
20	MEM.DEL	Deletes the memory channel	–
21	MEM. TAG	Edits the memory channel tag.	–
22	PAG.ABK	Turns the pager answer back Function ON/OFF	ABK.OFF / ABK. ON
23	PAG.CDR	Specifies a personal code (receive).	01 – 05 – 50, 01 – 47 – 50
24	PAG.CDT	Specifies a personal code (transmit).	01 – 05 – 50, 01 – 47 – 50
25	PRI.RVT	Turns the Priority Revert feature ON/OFF.	RVTOFF / RVT ON
26	PSWD	Turns the Password feature ON/OFF.	PWD.OFF / PWD. ON
27	PSWDWT	Inputs the password.	(4 digits)

No.	Set Mode item	Description	Selectable options (Options in bold are the default settings)
28	RF SQL	Adjusts the RF Squelch threshold level.	OFF / S-1 / S-2 / S-3 / S-4 / S-5 / S-6 / S-8 / S-FULL
29	RPT.ARS	Turns the ARS function on/off.	ARS.ON / ARS.OFF
30	RPT.FRQ	Sets the repeater shift width.	OFF / 0.025MHz – 99.975MHz
31	RPT.SFT	Sets the repeater shift direction.	SIMPLX / +RPT / -RPT
32	RXSAVE	Selects the Receive mode Battery Saver interval ("sleep" ratio)	200 MS – 2 SEC / OFF
33	SCN.LMP	Turns the scan lamp ON/OFF while paused.	ON / OFF
34	SCN.RSM	Configures the scan stop mode settings.	BUSY / HOLD / TIME
35	SKIP	Turns the Memory Scan "Skip" channel selection mode ON/OFF.	OFF / SKIP
36	SQL.TYP	Selects the Tone Encoder and/or Decoder mode.	OFF / R-TONE / T-TONE / TSQ / REV TN / DCS / PAGER
37	STEP	Sets the frequency steps.	AUTO / 5.0 / 6.25 / 10.0 / 12.5 / 15.0 / 20.0 / 25.0 / 50.0 / 100.0 k
38	TN FRQ	Sets the TONE frequency.	OFF / 67.0 R – 100.0 R – 254.1 R OFF / 67.0 T – 100.0 T – 254.1 T
39	TOT	Sets the timeout timer.	OFF / 1MIN – 3MIN – 30MIN
40	TX PWR	Selects Transmitter Power	HIGH (5W) / MID (2.5W) / LOW (0.5W)
41	TXSAVE	Turns the Transmit Battery Saver ON/OFF.	SAVOFF / SAV ON
42	VFO.SPL	Turns the "VFO Split" operation ON/OFF.	VSP.OFF / VSP. ON
43	VOX	Turns the VOX function ON/OFF.	VOXOFF / VOX ON
44	WFM.RCV	Broadband FM Radio (WFM) function Enables/Disables.	WFM.ON / WFM.OFF
45	W/N.DEV	Sets the Transmit Modulation Level in the FM mode.	WIDE / NARROW
46	WX ALT	Turns the Weather Alert Scan ON/OFF.	ALT.OFF / ALT. ON

(*): This function displays depending on the transceiver version.

Restoring to Defaults (Reset) / Setting the Preferred Operating Mode

The following reset or preferred operating modes may be selected.

1. Turn the transceiver **OFF**.
2. Press and hold the **MONI/T.CALL** key and the **PTT** switch simultaneously, while turning the transceiver ON.
3. When the LCD backlight comes on, release the **MONI/T.CALL** key and **PTT** switch.
4. Referring to the below table, press the [**▲**] or [**▼**] key to select the desired resets or desired operating modes.
5. Press the Function key momentarily to activate the selected operating mode.

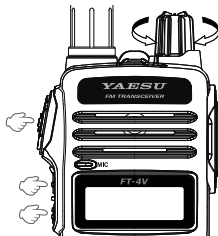

Display	Description
F1:SET RST	Resets the Set Mode settings to factory defaults.
F2:MEM RST	Clears the Memory settings to factory defaults.
F3:MB. RST	Clears the Memory Bank assignments.
F4:ALL RST	Clears the all memories and other settings to factory defaults.
F5:M-ONLY	Memory Mode operation only.
F6:CLONE	Clone Mode.

CAUTION!

Resetting the transceiver (F2 MEM RST / F4 ALL RST) will clear all memories.

Always make a note of the memory channel settings, etc. before resetting.



- To cancel this operation, turn the transceiver OFF.
- Perform F4:ALL.RST to restore all of the following Set Mode items to default.
10 DCS.COD 26 PSWD 27 PSWDWT 30 RPT.FRQ 31 RPT.SFT
35 SKIP 36 SQL.TYP 37 STEP 38 TN FRQ 40 TX PWR
45 W/N.DEV

Specifications

● General

Frequency Range	RX: 136 - 174 MHz TX: 136 - 174 MHz (Asian version) 144 - 146 MHz (European version) 144 - 148 MHz (USA version)
FM Broadcast:	65 - 108 MHz
Channel Steps	: 5/10/12.5/15/20/25/50/100kHz
Mode of Emission	: F2D, F3E, F2A
Frequency Stability	: ± 2.5 ppm (-20°C to $+60^{\circ}\text{C}$ [-4°F to $+140^{\circ}\text{F}$])
Antenna Impedance	: 50 ohms
Supply Voltage	: Nominal: 7.4 V DC, Negative Ground SBR-28LI
Current Consumption (Approx.)	: 190 mA (Receive, 200 mW Audio Output) 95 mA (Standby, Saver Off) 23 mA (Standby, Saver On) 5 mA (Auto Power Off) 1.5 A (5 W TX, 144 MHz) 7.4 V DC
Operating Temperature	: -4°F to $+140^{\circ}\text{F}$ (-20°C to $+60^{\circ}\text{C}$)
Case Size	: 2.0" (W) x 3.5" (H) x 1.2" (D) (52x90x30mm) (W/O knob and antenna)
Weight (Approx.)	: 8.82 oz (250g) with SBR-28LI and antenna

● Transmitter

RF Power Output	: 5.0 W (High) / 2.5 W (Middle) / 0.5 W (Low) (@ 7.4 V with SBR-28LI)
Modulation Type	: Variable Reactance
Maximum Deviation	: ± 5.0 kHz
Spurious Emission	: USA/Asian version At least 60 dB below (@TX Power High, Middle) At least 50 dB below (@TX Power Low) European version At least 60 dB below (@TX Power High, Middle) At least 55 dB below (@TX Power Low)
Microphone Impedance (Approx.)	: 2 k Ω

● Receiver

Circuit Type	: Direct-conversion
Sensitivity	: 0.2 μ V for 12 dB SINAD (140 - 150 MHz, NFM)
Selectivity (-6 dB/-60 dB)	: FM, NFM \pm 25 kHz / 12.5 kHz
AF Output	: 800 mW (16 Ω for THD 10 % 7.4 V DC) internal speaker 800 mW (16 Ω for THD 10 % 7.4 V DC) external speaker

Specifications are subject to change without notice, and are guaranteed within the 144 MHz amateur bands only. Frequency ranges will vary according to transceiver version; check with your dealer.

Symbols placed on the equipment

 Direct current

YAESU Limited Warranty

Limited Warranty is valid only in the country/region where this product was originally purchased.

On-line Warranty Registration:

Thank you for buying YAESU products! We are confident your new radio will serve your needs for many years! Please register your product at **www.yaesu.com** - Owner's Corner

Warranty Terms:

Subject to the Limitations of the Warranty and the Warranty Procedures described below, YAESU MUSEN hereby warrants this product to be free of defects in materials and workmanship in normal use during the "Warranty Period." (the "Limited Warranty").

Limitations of Warranty:

- A. YAESU MUSEN is not liable for any express warranties except the Limited Warranty described above.
- B. The Limited Warranty is extended only to the original end-use purchaser or the person receiving this product as a gift, and shall not be extended to any other person or transferee.
- C. Unless a different warranty period is stated with this YAESU product, the Warranty Period is three years from the date of retail purchase by the original end-use purchaser.
- D. The Limited Warranty is valid only in the country/region where this product was originally purchased.
- E. During the Warranty Period, YAESU MUSEN will, at its sole option, repair or replace (using new or refurbished replacement parts) any defective parts within a reasonable period of time and free of charge.
- F. The Limited Warranty does not cover shipping cost (including transportation and insurance) from you to us, or any import fees, duties or taxes.
- G. The Limited Warranty does not cover any impairment caused by tampering, misuse, failure to follow instructions supplied with the product, unauthorized modifications, or damage to this product for any reasons, such as: accident; excess moisture; lightning; power surges; connection to improper voltage supply; damage caused by inadequate packing or shipping procedures; loss of, damage to or corruption of stored data; product modification to enable operation in another country/purpose other than the country/purpose for which it was designed, manufactured, approved and/or authorized; or the repair of products damaged by these modifications.
- H. The Limited Warranty applies only to the product as it existed at the time of the original purchase, by the original retail purchaser, and shall not preclude YAESU MUSEN from later making any changes in design, adding to, or otherwise improving subsequent versions of this product, or impose upon YAESU MUSEN any obligation to modify or alter this product to conform to such changes, or improvements.
- I. YAESU MUSEN assumes no responsibility for any consequential damages caused by, or arising out of, any such defect in materials or workmanship.

- J. TO THE FULLEST EXTENT PERMITTED BY LAW, YAESU MUSEN SHALL NOT BE RESPONSIBLE FOR ANY IMPLIED WARRANTY WITH RESPECT TO THIS PRODUCT.
- K. If the original retail purchaser timely complies with the Warranty Procedures described below, and YAESU MUSEN elects to send the purchaser a replacement product rather than repair the "original product", then the Limited Warranty shall apply to the replacement product only for the remainder of the original product Warranty Period.
- L. Warranty statutes vary from state to state, or country to country, so some of the above limitations may not apply to your location.

Warranty Procedures:

1. To find the Authorized YAESU Service Center in your country/region, visit www.yaesu.com. Contact the YAESU Service Center for specific return and shipping instructions, or contact an authorized YAESU dealer/distributor from whom the product was originally purchased.
2. Include proof of original purchase from an authorized YAESU dealer/distributor, and ship the product, freight prepaid, to the address provided by the YAESU Service Center in your country/ region.
3. Upon receipt of this product, returned in accordance with the procedures described above, by the YAESU Authorized Service Center, all reasonable efforts will be expended by YAESU MUSEN to cause this product to conform to its original specifications. YAESU MUSEN will return the repaired product (or a replacement product) free of charge to the original purchaser. The decision to repair or replace this product is the sole discretion of YAESU MUSEN.

Other conditions:

YAESU MUSEN'S MAXIMUM LIABILITY SHALL NOT EXCEED THE ACTUAL PURCHASE PRICE PAID FOR THE PRODUCT. IN NO EVENT SHALL YAESU MUSEN BE LIABLE FOR LOSS OF, DAMAGE TO OR CORRUPTION OF STORED DATA, OR FOR SPECIAL, INCIDENTAL, CONSEQUENTIAL, OR INDIRECT DAMAGES, HOW EVER CAUSED; INCLUDING WITHOUT LIMITATION TO THE REPLACEMENT OF EQUIPMENT AND PROPERTY, AND ANY COSTS OF RECOVERING, PROGRAMMING OR REPRODUCING ANY PROGRAM OR DATA STORED IN OR USED WITH THE YAESU PRODUCT.

Some Countries in Europe and some States of the USA do not allow the exclusion or limitation of incidental or consequential damages, or a limitation on how long an implied warranty lasts, so the above limitation or exclusions may not apply. This warranty provides specific rights, there may be other rights available which may vary between countries in Europe or from state to state within the USA.

This Limited Warranty is void if the label bearing the serial number has been removed or defaced.

1. Changes or modifications to this device that are not expressly approved by YAESU MUSEN could void the user's authorization to operate this device.
2. This device complies with part 15 of the FCC Rules. Operation is subject to the following two conditions: (1) This device may not cause harmful interference, and (2) this device must accept any interference including received, interference that may cause undesired operation.
3. The scanning receiver in this equipment is incapable of tuning, or readily being altered, by the User to operate within the frequency bands allocated to the Domestic public Cellular Telecommunications Service in Part 22.

This device complies with Industry Canada license-exempt RSS standard(s). Operation is subject to the following two conditions: (1) this device may not cause interference, and (2) this device must accept any interference, including interference that may cause undesired operation of the device.

Le présent appareil est conforme aux CNR d'Industrie Canada applicables aux appareils radio exempts de licence. L'exploitation est autorisée aux deux conditions suivantes : (1) l'appareil ne doit pas produire de brouillage, et (2) l'utilisateur de l'appareil doit accepter tout brouillage radioélectrique subi, même si le brouillage est susceptible d'en compromettre le fonctionnement.

DECLARATION BY MANUFACTURER

The Scanner receiver is not a digital scanner and is incapable of being converted or modified to a digital scanner receiver by any user.

WARNING: MODIFICATION OF THIS DEVICE TO RECEIVE CELLULAR RADIOTELEPHONE SERVICE SIGNALS IS PROHIBITED UNDER FCC RULES AND FEDERAL LAW.

EU Declaration of Conformity

We, Yaesu Musen Co. Ltd of Tokyo, Japan, hereby declare that this radio equipment **FT-4VE** is in full compliance with EU Radio Equipment Directive 2014/53/EU. The full text of the Declaration of Conformity for this product is available to view at <http://www.yaesu.com/jp/red>

ATTENTION – Conditions of usage

This transceiver works on frequencies that are regulated and not permitted to be used without authorisation in the EU countries shown in this table. Users of this equipment should check with their local spectrum management authority for licensing conditions applicable for this equipment.



AT	BE	BG	CY	CZ	DE
DK	ES	EE	FI	FR	UK
GR	HR	HU	IE	IT	LT
LU	LV	MT	NL	PL	PT
RO	SK	SI	SE	CH	IS
LI	NO	-	-	-	-

Disposal of Electronic and Electrical Equipment

Products with the symbol (crossed-out wheeled bin) cannot be disposed as household waste.

Electronic and Electrical Equipment should be recycled at a facility capable of handling these items and their waste by-products.

Please contact a local equipment supplier representative or service center for information about the waste collection system in your country.



YAESU

The radio

Copyright 2018
YAESU MUSEN CO., LTD.
All rights reserved.

No portion of this manual may be
reproduced without the permission of
YAESU MUSEN CO., LTD.

YAESU MUSEN CO., LTD.

Tennozu Parkside Building
2-5-8 Higashi-Shinagawa, Shinagawa-ku, Tokyo
140-0002 Japan

YAESU USA

6125 Phyllis Drive, Cypress, CA 90630, U.S.A.

YAESU UK

Unit 12, Sun Valley Business Park, Winnall Close
Winchester, Hampshire, SO23 0LB, U.K.

1803M-AC-1
Printed in China



E H O 6 9 N 2 0 0