

OPERATING MANUAL

FT-411



E2580100(112t-fk)



YAESU MUSEN CO., LTD.
C.P.O. BOX 1500
TOKYO, JAPAN

CONTENTS

SPECIFICATIONS	2
LIST OF ACCESSORIES & OPTIONS	3
CONTROLS & CONNECTORS	4
TOP PANEL	4
FRONT & SIDE PANELS	6
ACCESSORIES & OPTIONS	8
Battery Packs and Cases	8
Battery Removal and Replacement	9
Battery Chargers	10
Speaker/Microphones	12
Antenna Considerations	12
YH-2 Headset	12
FTS-17 Tone Squelch Unit Installation	13
OPERATION	14
Preliminary Operating Information	14
Squelch Setup	14
Important Keypad Information	15
VFO Frequency & Step Selection	16
Transmitting	18
Repeater Splits	18
Changing the Standard Repeater Shift	19
Memory Storage	20
Memory Recall & Copy	21
Hiding and Erasing Memories	21
Call Channel Memory	22
Scanning	22
Memory Skip Scanning	23
Programmable Memory Scanning (PMS)	23
Priority Channel Monitoring	24
Multi-Channel Priority Monitoring	24
Tone Squelch/Pager Operation	25
Power Saver	26
APO (Automatic Power-Off)	28
VOX (Voice-Actuated Transmit Switching)	28
DTMF Memories	29
System Reset	30
In Case of Problems	31
Getting the Most from Your Batteries	32
Data Cloning	34

FT-411 COMPACT 2m CPU-CONTROLLED FM TRANSCEIVER

The FT-411 is an ultra compact FM hand-held providing up to five watts of RF power and a wealth of new features for the 2m amateur band. Slightly smaller and lighter than the FT-23R/73R, the FT-411 accepts the same battery packs, and has rubber gasket seals around all external controls and connectors keep out dust and rain or spray assuring years of reliable operation even in harsh environments.

Sixteen multi-function keys provide the ultimate in programmability of 49 freely tunable memories and two vfos. All memories store repeated shifts or separate tx/rx frequencies, CTCSS (Continuous Tone Controlled Squelch System) tone frequencies and tone encode/decode selections*, with one instant-recall call channel memory and two special purpose memories for limited subband tuning/scanning. Busy channel band or selective memory scanning is provided along with priority channel monitoring; 1MHz up/down stepping; ARS (automatic repeater shift) when tuned to repeater subbands, plus a top panel rotary dial for memory and frequency selection. The keypad serves as a DTMF encoder during transmission, and up to 10 DTMF memories can store 15 digits each for quick playback of commonly used numbers.

The liquid crystal display shows six frequency digits, memory selection, CTCSS tone frequency while setting*, page-received status when paged by a CTCSS tone*, and includes a bargraph S/PO meter. Yaesu's power saver system can be set by the operator for optimum sampling rate/standby ratio, or can be turned off for packet operation. And our new APO (Automatic Power Off) system shuts off the transceiver to avoid dead batteries if you doze off or are called away unexpectedly.

Operation under difficult conditions is simplified by a lamp button illuminating the display and backlit translucent keypad, diatonically assigned function-dependent keypad beeps and a built-in VOX system allowing hands-free operation with the optional YH-2 headset.

Please read this manual carefully to gain a clear understanding of the features of the FT-411.

* CTCSS and paging features require optional FTS-17 Tone Unit.

SPECIFICATIONS

GENERAL

Frequency coverage (MHz):

144 to 147.0005 (version A)

144 to 145.0075 (version B)

Channel steps:

5, 10, 12.5, 20 & 25 kHz

Standard repeater shift:

600 kHz

Emission type:

G3E

Supply voltage:

5.5 to 15.0 VDC

Current consumption:

Stby (1sec Save) 7mA; Rcv: 150mA;

Transmit (6W): 1300 mA;

Auto Power Off: 6 mA

Antenna (BNC jack):

YHA-16 rubber flex antenna

Case size (WHD, in mm):

w/FNB/FBA-9/17: 55x122x32

w/FNB/FBA-10: 55x139x32

w/FNB-11: 55x188x32

w/FNB-12/-14: 55x155x32

Weight (approx):

430g w/FNB-10, 550g w/FNB-11

RF Power Chart

Battery Type	RF Output (watts)
(Dry Cell Cases)	
FBA-9 (6xAAA cells)	2.0
FBA-10/17 (6xAA cells)	2.5
(Ni-Cd Packs)	
FNB-9 (7.2V, 200 mAh)	2.5
FNB-10/17 (7.2V, 600 mAh)	2.5
FNB-11 (12V, 600 mAh)	5.0
FNB-12 (12V, 500 mAh)	5.0
FNB-14 (7.2V, 1000 mAh)	2.5

RECEIVER

Circuit type:

Double-conversion superheterodyne

Sensitivity (for 12dB SINAD):

better than 0.158uV (-10dBu)

Adjacent channel selectivity:

better than 60dB

Intermodulation:

better than 65dB

Audio output:

0.5W @8 ohms for 5% THD (12V)

TRANSMITTER

Power output:

(see RF Power Chart)

Frequency stability:

better than 10 ppm

Modulation system:

variable reactance

Maximum deviation:

±5 kHz

FM Noise:

better than -40dB @ 1 kHz

Spurious emissions:

better than 60dB below carrier

Audio distortion (@ 1 kHz):

less than 5%, w/3 kHz deviation

Microphone type:

2-kilohm condenser

Burst tone:

1750 Hz (except version A)

ACCESSORIES & OPTIONS

FNB-9	7.2V, 200mAh Ni-Cd Battery Pack
FNB-10	7.2V, 600mAh Ni-Cd Battery Pack
FNB-11	12V, 600mAh Ni-Cd Battery Pack
FNB-12	12V, 500mAh Ni-Cd Battery Pack
FNB-14	7.2V, 1000mAh Ni-Cd Battery Pack
FNB-17	7.2V, 600mAh Compact Ni-Cd Battery Pack
FBA-9	Dry cell Battery Case for 6 AAA-size cells
FBA-10	Dry cell Battery Case for 6 AA-size cells
FBA-17	Compact Dry Cell Battery Case for 6 AA-size cells
NC-18B	117 VAC Compact Wall Charger for FNB-11/-12
NC-18C	220-234 VAC Compact Wall Charger for FNB-11/-12
NC-27B	117 VAC Compact Wall Charger for FNB-9
NC-27C	220-234 VAC Compact Wall Charger for FNB-9
NC-28B	117 VAC Compact Wall Charger for FNB-10/-17
NC-28C	220-234 VAC Compact Wall Charger for FNB-10/-17
NC-29	Desktop Quick Charger for FNB-9/-10/-11/-12/-14/-17
NC-34B	117 VAC Compact Wall Charger for FNB-14
NC-34C	220-234 VAC Compact Wall Charger for FNB-14
PA-6	Mobile DC Adapter/Charger for FNB-9/-10/-14/-17
CSC-35	Soft Case for Transceiver with FNB-/FBA-9/-17
CSC-36	Soft Case for Transceiver with FNB-/FBA-10
CSC-37	Soft Case for Transceiver with FNB-12/-14
CSC-38	Soft Case for Transceiver with FNB-11
MMB-32A	Mobile Hanger Bracket
MH-12A2B	External Hand Speaker/Microphone
YHA-16	Rubber flex antenna
FTS-17	CTCSS Subaudible Tone Squelch Unit
MH-18A2B	Compact Speaker/Microphone
MH-19A2B	Earpiece/Microphone
YH-2	Headset

Specifications may be subject to change without notice or obligation. Availability of accessories may vary: some accessories are supplied as standard per local regulations and requirements, others may be unavailable in some regions. Check with your Yaesu dealer for additions to the above list.

CONTROLS & CONNECTORS

TOP PANEL

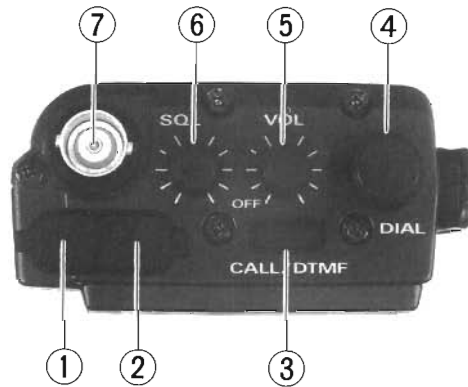

(1) EAR Jack

This 2-conductor mini phone jack provides audio output for an external earphone or optional Speaker/Mic (listed on previous page). When a plug is installed in this jack the front panel loudspeaker is disabled.

(2) MIC Jack

This 2-conductor micro-mini phone jack accepts microphone input from an external Speaker/Mic or other external source. When a plug is installed in this jack the front panel microphone is disabled.

(3) CALL/DTMF Button

This button toggles between CALL channel and VFO or memory. Also, if the F/M key is pressed just before this button, the DTMF memory mode is toggled on and off (as indicated by a telephone icon).

(4) DIAL Rotary Selector

This 20-position detented rotary switch tunes the operating (or CTCSS tone) frequency or selects the memory channels, according to which function is selected by the keys on the front panel. This knob duplicates some of the functions of the up and down arrow keys for operating convenience.

(5) VOL (OFF) Control

This control adjusts the volume of the receiver. Turn this control to the fully counterclockwise position (into the click stop) to turn the transceiver OFF.

(6) SQL Control

This control sets the threshold level at which received signals (or noise) open the noise squelch. For prolonged battery life and squelch sensitivity when the FTS-17 Tone Squelch Unit is not installed, set this control from counterclockwise just to the point where noise is silenced (and the BUSY/TX indicator on the front panel is off) when the channel is clear.

(7) Antenna Jack

This BNC jack accepts the supplied YHA-16 rubber flex antenna, or any other antenna designed to provide 50-ohm impedance on the 2m band.

FRONT & SIDE PANELS

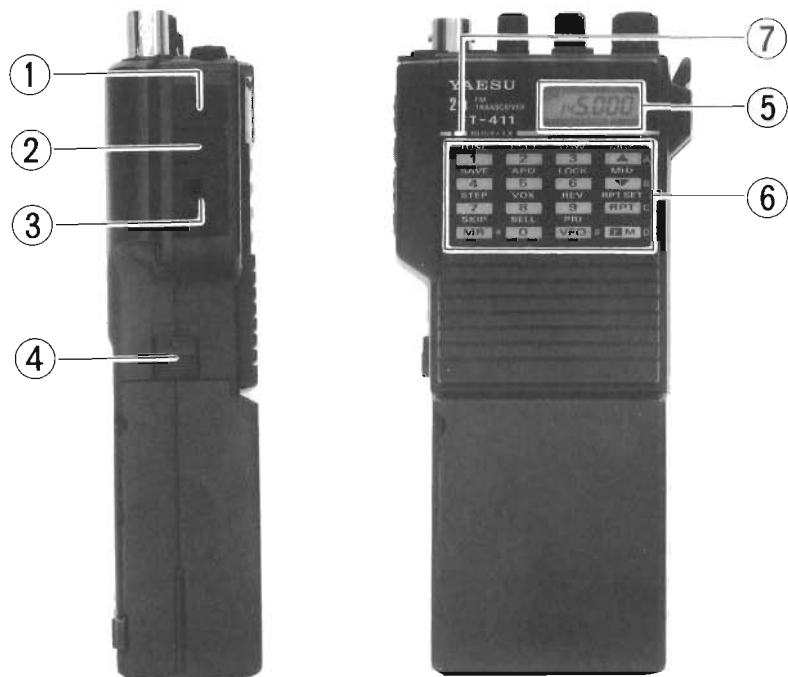

(1) Lamp Button

Press this button to illuminate the display and keypad when necessary.

(2) Monitor (Burst) Button

In the USA version, this button opens the squelch momentarily without disturbing the setting of the SQL control. In the European version, this button activates the 1750 Hz Burst tone generator.

(3) PTT Button

Press and hold this (Push-to-Talk) button to transmit. The BUSY/TX indicator glows red while transmitting.

(4) Unlock Lever

Slide this mechanical lever upward to release the battery for removal.

(5) LCD (Liquid Crystal Display)

The display shows the selected operating conditions as indicated in the following diagram:

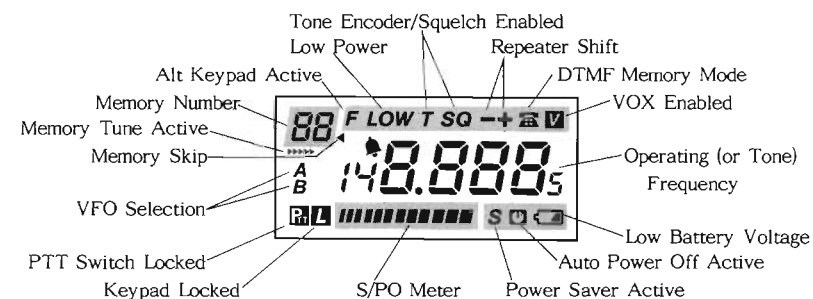

(6) Keypad

These sixteen keys select the various operating features of the transceiver during reception, and generate DTMF (Dual Tone Multi Frequency) tone pairs during transmission. One or two beeps will sound whenever one of the keys is pressed (if the beeper is active). The labels on the faces of the keys indicate their primary functions, while the labels above fifteen of the keys indicate alternate functions, which are activated by pressing the F/M key first, and then another key within three seconds. When referring to alternate key functions in this manual, we show the alternate key label followed by the primary label in parentheses (). Primary key functions are referred to by the labels on the keyfaces, except the arrow keys, which are referred to as the Up and Down arrow keys, or just the "arrow keys".

Remember to always press the F/M key first (momentarily, unless otherwise indicated) when you want to use an alternate key function. All key functions are described in the "Operation" section, and summarized on the FT-411 Operator's Quick Reference Card.

(7) BUSY/TX Indicator Lamp

This LED indicator glows green when the noise squelch is open during reception, and red when transmitting.

ACCESSORIES & OPTIONS

Battery Packs and Cases

The following rechargeable Ni-Cd battery packs are recommended for use with the FT-411:

FNB-9	7.2V 200 mAh
FNB-10/17	7.2V 600 mAh
FNB-11	12V 600 mAh
FNB-12	12V 500 mAh
FNB-14	7.2V 1000 mAh

The following battery cases are also available for operating the FT-411 with non-rechargeable dry cell batteries (not supplied):

FBA-9 Battery Case for 6 'AAA' (UM-4) batteries
FBA-10 and **FNB-17** Battery Cases for 6 'AA' (UM-3) batteries

In some countries, one or more of the above may be supplied with the transceiver. If not, contact the nearest Yaesu dealer to purchase the desired battery pack or case. We do not recommend the use of any other type of battery with the FT-411, and using another type may affect your warranty.

The Ni-Cd packs listed above may be recharged either while attached to the transceiver or separately, using the battery chargers described on the following pages. Each Ni-Cd pack should be fully charged before it is used with the transceiver for the first time. Note that most of these packs require different wall chargers: NC-27B/C for the FNB-9, NC-28B/C for the FNB-10/-17, NC-18B/C for FNB-11 or FNB-12, and NC-34B/C for FNB-14. Make certain that you use the correct charger for each pack. The NC-29 Desktop Quick charger may be used with all of these Ni-Cd packs.

RF power output from the transmitter will differ in some cases according to which type of battery is used, as shown in the RF Power Chart in the Specifications section.

Battery Removal and Replacement

1. Make sure that the VOL control is set into the OFF click-stop, and remove the protective soft or hard case, if used.
2. Grasp the upper portion of the transceiver with your left hand, so that your palm is over the speaker and your left thumb is on the UNLOCK button.
3. Move the UNLOCK button in the direction indicated by the small arrowhead, while using your right hand to slide the battery case toward the side with the UNLOCK button. The battery case should slide smoothly out of its track.
4. To open the FBA-9, FBA-10 and FBA-17 battery cases, place both of your thumbs on the mounting tracks on top of the case and gently pry the tracks apart. Install six batteries, paying attention to the polarity indicated inside the case. Always replace all six cells.

Do not attempt to open any of the rechargeable Ni-Cd packs.

5. To replace the battery case or Ni-Cd pack, repeat steps 2 and 3 above, simply sliding the battery case in the other direction after aligning the shorter side of the battery case with the track below the UNLOCK button.

Battery Chargers

It is not necessary to remove the battery pack from the transceiver when charging, but transceiver operation may be impaired (by noise) while charging the battery. Therefore we recommend having an extra battery pack on hand so that the transceiver can be used while the spare pack is being charged.

Do not attempt to recharge dry cell batteries used in the FBA-9, FBA-10 or FBA-17.

NC-18B/C

The NC-18B (117VAC) and NC-18C (220-234VAC) are compact chargers for recharging the FNB-11 and FNB-12 Ni-Cd battery packs from the AC line. A completely discharged pack requires approximately 15 hours to recharge with the NC-18B/C. Do not attempt to charge the FNB-9, FNB-10, FNB-14 or FNB-17 with the NC-18B/C, as the charging voltage is too high to safely charge those packs.

NC-27B/C

The NC-27B (117VAC) and NC-27C (220-234VAC) are compact chargers for recharging the FNB-9 Ni-Cd battery pack from the AC line. A completely discharged pack requires approximately 15 hours to recharge with the NC-27B/C. Do not attempt to charge the FNB-10, FNB-11, FNB-12, FNB-14 or FNB-17 with the NC-27B/C, as the charging voltage is not high enough.

NC-28B/C

The NC-28B (117VAC) and NC-28C (220-234VAC) are compact chargers for recharging the FNB-10 and FNB-17 Ni-Cd battery packs from the AC line. A completely discharged pack requires approximately 15 hours to recharge with the NC-28B/C. Do not attempt to charge the FNB-9, FNB-11, FNB-12 or FNB-14 with the NC-28B/C, as the charging voltage is not correct for those packs.

NC-34B/C

The NC-34B (117VAC) and NC-34C (220-234VAC) are compact chargers for recharging the FNB-14 Ni-Cd battery pack from the AC line. A completely discharged pack requires approximately 15 hours to recharge with the NC-34B/C. Do not attempt to charge the FNB-9, FNB-10, FNB-11, FNB-12 or FNB-17 with the NC-34B/C, as the charging voltage and current are not correct for those packs.

NC-29 5-hour Quick Charger

The NC-29 is a universal battery charger with quick and trickle charging modes for the FNB-9, FNB-10, FNB-11, FNB-12, FNB-14 and FNB-17 Ni-Cd packs. The quick mode is automatically selected initially, to bring the battery pack up to full charge as fast as safely possible using an internal timer. Three LED indicators show elapsed charging time after 1, 3 and 5 hours. The charger then automatically reverts to the trickle mode (green LED indicator), to prevent self-discharge. The quick mode recharges a completely discharged battery in about 5 hours, depending on temperature.

CAUTION: When using the NC-29, do not remove and then replace a battery from the charger while it is charging, as this will reset the timer and may then overcharge the battery.

PA-6 Mobile DC-DC Adapter/Charger for FNB-9, -10, -14 and -17

The PA-6 is a DC-DC adapter for use when operating the transceiver mobile, and for charging the FNB-9, FNB-10, FNB-14 and FNB-17 Ni-Cd battery packs. The PA-6 recharges a completely discharged FNB-9 in about 5 hours, an FNB-10 or FNB-17 in about 15 hours, or trickle charges an FNB-14 (to full charge in about 35 hours). Care must be used to avoid overcharging the batteries, as the PA-6 does not include a timer. The PA-6 cannot be used for charging the FNB-11 or FNB-12, as the charging voltage is too low.

Use with 12-volt negative ground electrical systems only.

Speaker/Microphones

The MH-12A2B and MH-18A2B Speaker/Mics and MH-19A2B Earpiece-/Mic can be used to increase operating convenience and extend communications range and signal strength. Each is equipped with a dual plug connector which mates with the EAR and MIC jacks on the top panel of the transceiver, disabling the internal speaker and microphone. The cable allows the transceiver to be left clipped to your belt, or to be held overhead above obstructions for improved performance, if required. For mobile operation with the MMB-32A Mobile Hanger, the transceiver can be left in the Hanger during operation.

A Speaker/Mic can be held close to your ear during reception; or an external earphone can be connected to the transceiver via the Speaker/Mic plug, attenuating audio from the speaker in the Speaker/Mic. To transmit just hold the Speaker/Mic close to your mouth and close the PTT switch on the microphone (or on the cord of the MH-19A2B).

Antenna Considerations

While the supplied YHA-16 rubber flex antenna is convenient for short-range operation, the standard BNC connector allows use of a higher gain antenna for extended range base or mobile operation. However, any antenna used with the FT-411 must have an impedance close to 50 ohms on the 2m band. Also, if the antenna is connected with a feedline, use only good quality 50-ohm coaxial cable. To obtain a proper fit with some BNC plugs, you may need to remove the rubber gasket around the antenna jack on the transceiver.

YH-2 Headset

The YH-2 includes a lightweight earphone and miniature boom microphone, permitting totally hands-free operation of the transceiver with the VOX (voice-actuated transmit/receive switching) system in the transceiver. To transmit when using the YH-2 it is only necessary to speak. The boom microphone will pick up your voice, which will automatically activate the transmitter and be sent out over the air (watch what you say!). To return to receive, just stop talking.

FTS-17 Tone Squelch Unit Installation

The FTS-17 is a subaudible CTCSS (Continuous Tone-Controlled Squelch System) which offers programmable selection of 38 tones for transmission and filter/detectors for reception. Transmit-only (encode) and transmit/receive (encode/decode) modes are selectable from keys on the transceiver.

Make sure the transceiver is off. Remove the hard or soft case, if used, and remove the battery pack.

1. Remove the four screws affixing the battery spring plate on the bottom of the transceiver and carefully remove the plate.
2. Connect the plug in the transceiver to the FTS-17.
3. Replace the battery spring plate and its four screws, and the battery pack.

Tone Squelch operation with the FTS-17 is described on page 25.

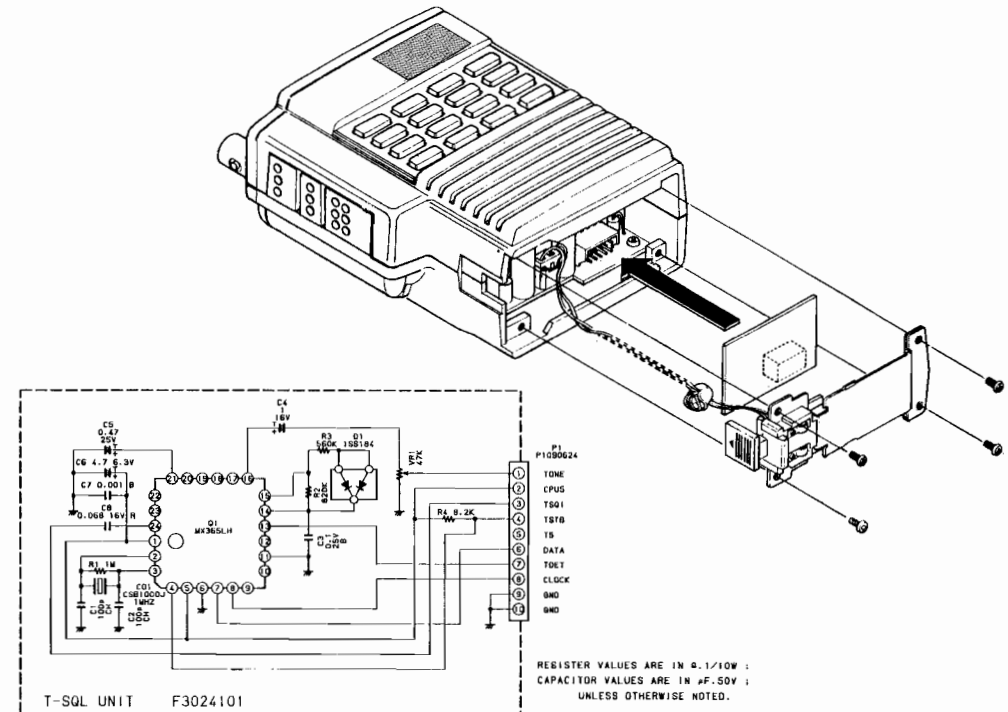

OPERATION

This chapter describes the various transceiver functions in detail. After studying these descriptions, keep the FT-411 Operator's Quick Reference Card handy in case you need to refresh your memory.

Preliminary Operating Information

Before operating the transceiver for the first time, charge the battery pack completely (if using Ni-Cd batteries) as described on pages 10 and 11. If using the FBA-9, FBA-10 or FBA-17 battery case, install the batteries as described on page 9.

Connect the YHA-16 rubber flex antenna to the antenna jack on the top of the transceiver. Never operate the transceiver without an antenna connected.

For now, do not connect a Speaker/Mic or Headset (until you are familiar with basic operation).

Before proceeding, please read the Controls and Connectors chapter if you have not already, to familiarize yourself with the functions of the controls. Note especially item (6) on page 7, which describes the terminology used in this chapter when referring to the keys.

Except for certain special cases mentioned later, the keypad functions as a DTMF (Dual Tone Multi Frequency) tone generator during transmission.

If you have trouble getting the transceiver to work as described, see "In Case of Problems" on page 31.

Squelch Setup

Set the SQL control fully counterclockwise, rotate the VOL control out of the click-stop and adjust for a comfortable volume on the noise or received signal. The BUSY/TX indicator LED should glow green. If a signal is present, rotate the DIAL selector on the top panel to a channel where only noise is heard.

Adjust the SQL control just to the point where the noise is silenced and the LED is extinguished. If the SQL control is set further clockwise, sensitivity to weak signals will be reduced. Now, whenever a signal reaches the receiver that is strong enough to open the squelch, the indicator will glow green.

Note that while receiving, one or more bargraph segments may appear along the bottom of the display, indicating signal strength on the receiving frequency. This indication is not affected by the squelch setting, so even squelched signals may have some indication. If you notice more than one or two bargraph segments appearing while the squelch is still closed, try reducing the squelch control setting (if you want to hear weak signals).

The Monitor switch on the USA versions (just above the PTT switch) allows you to check for channel activity beneath the squelch level and to adjust the volume without having to adjust the squelch: just press the Monitor switch and the squelch will open.

Above the Monitor switch (the Burst switch on European versions) is the Lamp switch. Press it to light the display and keypad.

Important Keypad Information

If the keypad beeper is enabled, each key on the keypad produces its own beep (or combination) when the key action is accepted. If you don't hear a beep when a key is pressed, either the volume is set too low, or the keystroke was not accepted. During transmission, key tones are the DTMF tone pairs (which are also transmitted).

Pressing the F/M key (at the lower right corner of the keypad) momentarily activates the alternate keypad functions, labelled on the panel just above each key. If no key is pressed within three seconds of pressing the F/M key, the keys return to their standard functions, labelled on each keyface. Throughout this manual, when we say "press the F/M key" we mean press it just momentarily (less than $\frac{1}{2}$ -second), unless specified otherwise.

Transmitting

Press F/M and then LOW(3) to toggle between high and low power output. The pitch of the keypad beeper will indicate whether high or low power is being selected, and "LOW" is displayed above the 1 MHz digit when low power is selected (we recommend using low power whenever possible to minimize possible interference to other stations and prolong battery life).

When you wish to transmit, wait until the channel is clear (BUSY/TX lamp off), and squeeze the PTT switch. During transmission the BUSY-/TX lamp glows red, and relative transmitter power output is indicated graphically along the bottom of the display. Release the PTT switch to receive.

If using a version B (in Europe), press the BURST switch (above the PTT switch) to transmit a 1750 Hz tone to access repeaters that require it.

Repeater Splits

The ARS (Automatic Repeater Shift) feature in the FT-411 provides repeater shift of the transmit frequency whenever you are tuned to a standard repeater subband (see diagram below). When enabled, a small "-" or "+" displayed above the 10's of kHz of the frequency indicates that repeater shift is active, and closing the push-to-talk switch changes the display to the (shifted) transmit frequency.

© Version A

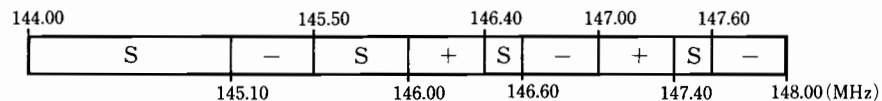

© Version B

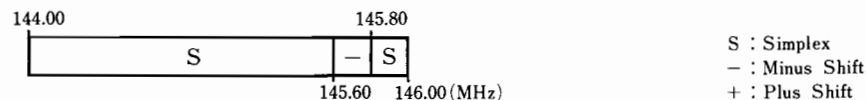

The ARS function is disabled at the factory. It is toggled on and off by pressing F/M, RPT, F/M and RPT (that is, each key, twice alternately). Pressing F/M and RPT the first time displays the repeater

shift offset (default 600 kHz, but adjustable) at the right, and if ARS is now enabled, an "A" at the left. With this display, pressing only the F/M key toggles ARS between enabled and disabled states, and RPT returns the display to the operating frequency. So after pressing F/M and RPT the first time, if you want to leave ARS as it is, just press RPT. Otherwise, press F/M to change it and press RPT once more when finished.

When the ARS feature is inactive (either disabled, or outside of the standard repeater subbands) the RPT button manually activates offset of the transmitting frequency from the receiving frequency for plus or minus shift. Just press RPT: once for minus shift, or twice for plus shift ("- " or "+ " displayed above the 10 kHz frequency digit). When you press the PTT switch to transmit (or F/M and REV(9) to reverse transmit and receive frequencies), the display will shift down or up by the programmed offset, if in band (or else 'Err' is displayed). Pressing RPT again returns you to simplex operation.

Changing the Standard Repeater Shift

As mentioned above, 600 kHz repeater offset is programmed in the transceiver, and can be easily reprogrammed as desired. If you have one or two repeaters in your area with non-standard splits, you can program separate transmit and receive frequencies in memory as described later. However, if most or all of the repeaters you use have an offset different than 600 kHz, you can reprogram the standard offset (as used by the RPT button and ARS) instead.

Changing the shift offset is the same as described above for changing the state of the ARS feature, except that you use the DIAL knob, arrow keys or numeric keypad entry to change the shift offset when it is displayed (that is, after pressing F/M and RPT). Any repeater offset must be a multiple of 50 kHz. If you use the keypad to enter the new offset you will start with the 10's of MHz digit, so if the new offset is less than 1 MHz, you will have to enter two 0's, followed by the 100's of kHz and 10's of kHz digits. For example, press 0060 to select 600 kHz offset (the 1's of kHz digit is assumed to be always zero, and so is not entered). After selecting the desired offset, make sure the ARS feature is set as desired ("A" at the left if enabled), and then press RPT to return to the VFO frequency display.

Memory Storage

The FT-411 offers forty-six general purpose memories, numbered 1 through 46, and three special memories, labelled C, L and U. All of these memories can store separate receive and transmit frequencies or repeater shift, and tone squelch data (if the optional FTS-17 is installed). The C memory is recalled instantly whenever the CALL button on the top panel is pressed (for use as an emergency or call channel), and the L and U memories are used for PMS operation, described later.

To store a frequency in memory:

- (1) Select the desired frequency (and repeater split, if desired) in the VFO mode as described above.
- (2) Press and hold the F/M key for $\frac{1}{2}$ -second (until the second beep sounds). A Memory number appears blinking in the shaded box at the upper left corner of the display.
- (3) Within five seconds of step (2), use the DIAL knob or arrow keys to select the desired Memory for storage. If you select one that was already being used, it will be overwritten with new data in the next step.
- (4) Press F/M again to store the displayed data into the selected Memory: the Memory number will stop blinking for a second, and then disappear as operation continues in the VFO mode.

When storing split-frequency memories you have the choice of either the Repeater Split method, described previously, or of storing separate transmit and receive frequencies. To store a separate transmit frequency, just store the receive frequency as described above, and then tune to the desired transmit frequency, press F/M again for $\frac{1}{2}$ -second, and then press and hold the PTT switch while pressing F/M once more (the transmitter is not activated in this case). By either method the results will be the same in operation, except that storing a separate transmit frequency applies only to one memory, while the offset method applies to all (when the RPT button is pressed).

Memory Recall & Copy

There are two ways to recall stored memories. If you know the memory number, just enter it on the keypad and then press MR (the "L" memory is 47 for this purpose, while the "U" memory is 48).

If you aren't sure of the memory number, press the MR to select the Memory mode (a Memory number/letter is displayed at the upper left), and then use the DIAL knob or arrow keys to select the desired memory. Naturally, vacant memories are not displayed.

For split-frequency memories, "-" or "+" will be displayed to remind you of the shift if stored by the offset method. If you stored a memory with a separate transmit frequency, "-+" are displayed together. In either case, you can press F/M and REV(9) to check the transmit frequency without transmitting (and press these keys again to return).

You can retune a selected memory by pressing the MR key: a dotted underline (.....) appears under the channel box at the upper left, and you can tune the displayed memory frequency in the same ways as described for the vfos. If you want to store the new memory settings in the current, or another memory, just follow steps (2) - (4) of the memory storage procedure above: operation will be left on the memory.

If you want to copy memory data to a vfo (overwriting previous data), you can do so while the memory retune feature is active: just press F/M and the VFO key to copy to the last-used VFO.

If you don't want to save your changes to the memory, press only the MR key to return to the original memory data.

Hiding and Erasing Memories

As already mentioned, storing data in a memory automatically overwrites data that was previously stored there. However, if you regularly move from one area to another, you may not want to use the same memories all the time, or you may wish to change your operating memories without having to rewrite them from scratch. This can be done by masking certain memories so that they are completely hidden from operation, and recalling them only when desired for operation.

To completely mask a memory, recall it and press the F/M key for ½-second (until the memory number blinks). Then press the MR key. This causes the display to change to memory 1, and the previously-selected memory is no longer selectable manually, or by scanning (as described later). Note that you cannot hide memory 1.

To unmask a hidden memory for operation, recall any memory and press F/M for ½-second. Then select the memory number to be restored, and press MR.

When you have hidden memories, avoid accidentally overwriting them.

Call Channel Memory

The call channel memory can be instantly recalled by pressing the CALL/DTMF button on the top panel. "C" appears in the memory window at the upper left corner of the display.

As mentioned earlier, you can store the same kinds of data in the CALL channel as in the general purpose memories: just follow steps (1) and (2) of the memory storage procedure, and then press the CALL/DTMF button. Also, if storing a separate transmit frequency, press the CALL button while holding the PTT switch when storing the transmit frequency (after storing the receive frequency - the transceiver will stay in the VFO mode).

Scanning

Before starting the scanner, make sure the SQL control is set to squelch off the noise on a clear channel. Scanning is activated and deactivated by the arrow keys. Just press and hold either key for more than ½-second to start the scanner. If the transceiver is in the VFO mode (or on the CALL channel), the whole band will be scanned. If in the memory mode, only the memories will be scanned.

The scanner pauses (and the decimal point blinks) whenever a signal is detected which is strong enough to open the squelch. You have a choice of two scan-resume modes: either Pause mode, in which the scanner pauses for as long as the carrier keeps the squelch open, or the 5-second duration mode, in which the scanner pauses for five seconds and then resumes scanning whether or not the signal is still present.

To set the scan-resume mode, press F/M and then STEP(7). A small "P" or "5" at the left indicates the current mode. Press F/M to change it, or just press STEP(7) alone to return to the frequency display.

You can stop the scanner manually by pressing the PTT or an arrow key, or by turning the DIAL knob.

NOTE: The scanner checks about 14 channels per second. To prevent this process from being interrupted by the power saver, saver operation is automatically suspended during scanning, resulting in some increase in power drain.

Memory Skip Scanning

When you have some busy channels stored in memories you may wish to skip them when scanning other memories, but still have them available for manual selection. You can mark a memory to be skipped by pressing F/M and then SKIP(MR) while the memory is recalled. A tiny arrowhead will be displayed just to the right of the memory number box, and this memory will be skipped during scanning (although you can still recall it manually).

To unmask a scan-skip memory, just repeat the same steps you took to mask it: select the memory manually, and press F/M and SKIP(MR).

Programmable Memory Scanning (PMS)

In addition to band and memory scanning, the FT-411 can scan between two frequencies of your choice stored in the special memories labelled "L" and "U":

- (1) Store the lower edge of the desired scanning range in memory L, and the upper edge in memory U.
- (2) With either memory U or L recalled, press the MR key. A dotted underline will appear at the bottom of the memory number box at the upper left.

You can now tune or scan as described previously, between the nearest multiples of 100 kHz (xxx.000, xxx.100, xxx.200, etc.) below memories L and U.

To cancel PMS operation, stop scanning, if necessary (DIAL knob arrow keys or PTT), and press the MR key to return to regular memory operation, or the VFO key to return to VFO mode.

Priority Channel Monitoring

Priority monitoring allows automatic checking for activity on a memory every five seconds while operating on a vfo or other memories. When a signal appears on the priority memory while receiving, operation will automatically shift to that memory, for as long as a carrier is received. If you transmit while paused on the priority memory, priority monitoring is cancelled and operation stays on the priority memory.

The squelch must first be preset, and the frequency to be monitored must be stored in a memory (this MUST be memory 1 if you will be operating on other memories during priority monitoring).

Press the VFO key to operate on a vfo, or else select the memory you want to operate on, and then press F/M and PRI(VFO). A 'P' will appear in the memory window at the upper left corner of the display, and about every five seconds the displayed frequency will shift to the priority memory briefly while the receiver checks for a signal.

As long as no signal appears on the priority memory to open the squelch, you can tune, scan, transmit and receive on the vfo, or select and operate on other memories. If a station you wish to talk with appears on the priority memory, press the PTT switch momentarily while receiving his signal, to stop priority checking. Otherwise, when a signal appears on the priority memory, checking will pause and the decimal on the display will blink; then priority monitoring will resume (according to how you set the scan resume mode - either after a 5-second pause, or after the carrier drops). To cancel priority monitoring manually, press either the MR or VFO key.

Note that you can use any other memory as a priority channel in the above procedure when operation during priority monitoring is to be on the vfo.

Multi-Channel Priority Monitoring

The priority monitoring function described above can be used to sequentially check multiple memory channels. After storing the memories, mask (hide) those you do not want checked, as described under "Memory Skip Scanning" on page 23. Then activate scanning of these memories by pressing an arrow key for $\frac{1}{2}$ -second from the memory mode. You can now press F/M and PRI(VFO) to activate priority monitoring of the memories while operating on the vfo. Each time the priority system checks a memory, it will be one higher or lower than the one checked previously.

When operating on the vfo while priority monitoring one or more memories, you can activate vfo scanning by holding an arrow key for $\frac{1}{2}$ -second.

Tone Squelch/Pager Operation

The FT-411 can be used to silently monitor for calls on busy channels, and to transmit CTCSS tones, when the optional FTS-17 Tone Squelch Unit is installed. The transmit (encode) function superimposes a subaudible tone (at a frequency too low to be heard) on the transmitted carrier, while the decode function monitors receiver audio through a narrow filter at the same subaudible frequency, keeping the squelch closed until a matching tone is received. If the paging bell feature is activated, an incoming signal with the matching tone will cause the speaker to sound an alerting "ring", and a small bell icon will blink above the 10's of MHz digit on the display (so that you know if a call came in while you were busy elsewhere). Installation instructions for the FTS-17 are in the 'Installation' chapter.

To check or set the CTCSS tone frequency and paging ring status, press [F]+TSET(2). The tone frequency will be displayed (in Hz). To change the tone frequency, rotate the DIAL knob or press the arrow keys until the display shows the tone frequency you require (if only 88.5 is displayed, the FTS-17 is not installed). Also, a lower-case "b" is displayed at the right if the keypad beeper is activated: it MUST be activated if the paging ring is to sound when a CTCSS call is received. Press the F/M key to toggle the keypad/ring tones on, if desired, and then press TSET(2) to return to the operating frequency display.

With the keypad/ring tones turned on as just described, you must also activate the paging bell if you want to use this feature. Press F/M and then BELL(0): a small bell icon appears above the 10's of kHz digit when activated. This icon will blink after a call is received.

To activate tone squelch press F/M and then the TONE(1) key. A tiny "T" will appear at the top of the display above the decimal, and the tone generator will be activated for transmission. Press F/M and TONE(1) again and "SQ" will be displayed next to the "T" as tone squelch is activated for both transmission and reception. Now only a matching tone frequency will open the squelch. Pressing F/M and TONE(1) once more turns off the tone squelch features.

Once you have the tone squelch set up the way you want it, you can store it in any memory. Afterwards, to change the stored settings, just recall the memory, reset the tone frequency or function, and store the memory again (press and hold F/M ½-second, and then press it again momentarily).

FTS-17 Tone Frequency Chart (Hz)

67.0	79.7	91.5	103.5	118.8	136.5	156.7	179.9	210.7	241.8
71.9	82.5	94.8	107.2	123.0	141.3	162.2	186.2	218.1	250.3
74.4	85.4	97.4	110.9	127.3	146.2	167.9	192.8	225.7	—
77.0	88.5	100.0	114.8	131.8	151.4	173.8	203.5	233.6	—

Power Saver

The Power Saver allows the transceiver to monitor a frequency for activity while drawing as much as 400% less current than is required for normal squelched reception. This is done by removing power from all circuits (except a timer and the display) for programmable intervals. Between these intervals, the receiver is enabled for 30ms to check the displayed frequency for activity. A tiny "S" is displayed below the 10's of kHz digit when the Power Saver feature is enabled. During power saving, the "S" flashes on and off.

When a signal appears the receiver functions normally. However, if the carrier drops for more than about 3 seconds, power saving resumes automatically. If the PTT switch is closed at any time during power saver operation, the transmitter activates as usual. If no station

responds to the transmission within 3 seconds after releasing the PTT switch, power saving resumes.

If no "S" appears below the 10's of kHz digit, power saving is disabled. To enable it, press F/M and then SAVE(4), and wait a few seconds. Normally you will want to keep it enabled, but if you use the transceiver for packet operation you will want it disabled, as it might otherwise interfere with packet reception. To disable power saving, press F/M followed by SAVE(4) and then the "0" key quickly ("OFF" will be displayed for a few seconds before the display returns to the operating frequency.

Remember that power saving only occurs when the squelch is closed (BUSY/TX lamp off). As shipped from the factory, power saving provides a 1:6.7 duty cycle (30ms receive, 200ms sleep). This ratio can be reprogrammed from the keypad for 1:1 to 1:33.3. To do this, first select the ratio you want from the chart below and note its corresponding key number, then press F/M, SAVE(4) and the number you selected (quickly). The display will show the resulting save time in decimal seconds, and then will return to the operating frequency. Turning the transceiver on and off does not affect the state (or programmed ratio) of the power saver.

POWER SAVER INTERVALS

Key Nr.	Save Time (ms)	Save/Rcv Ratio	Avg. Current Consump. (mA)
1	30	1:1	23
2	70	2.3:1	16.2
3	100	3.3:1	13.8
4	200 (default)	6.7:1	10.4
5	300	10:1	9.1
6	500	16.7:1	7.9
7	700	23.3:1	7.4
8	800	26.7:1	7.2
9	1000	33.3:1	7.0

EXAMPLE: to program a save ratio of 10:1

Press F/M followed by SAVE(4) and then (immediately) the 5 key. The display shows 0.30 indicating 300 ms save time, and the returns to the operating frequency.

APO (Automatic Power-Off)

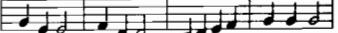
This feature automatically puts the transceiver to sleep if the keypad/DIAL knob, PTT or CALL/DTMF buttons are not used for a selectable period of 10, 20 or 30 minutes. One minute before going to sleep, a warning melody will sound (), and the APO clock icon will begin to blink. If no key is pressed within the next minute, the display will change to "OFF", with the clock icon blinking. If power saving is also enabled, the small "S" will blink to the left of the clock icon, even though power saving is NOT active in this condition.

The APO clock icon appears at the bottom right corner of the display whenever the APO feature is enabled. To toggle it on and off, press F/M and then APO(5).

To check the current setting of the APO timer, turn off the transceiver and then press and hold the "5" key while turning it back on. The display will show the current timer setting (in minutes) before changing to the frequency display. If you want to change the timer setting, turn the transceiver off again, and then press and hold either the "1", "2" or "3" key, for 10-, 20- or 30-minute APO time, respectively, while switching the transceiver back on.

VOX (Voice-Actuated Transmit Switching)

When the optional YH-2 Headset is connected to the EAR and MIC jacks on the top panel, VOX can be activated for hands-free operation. Press F/M once and then VOX(8) repeatedly to toggle the VOX system between low sensitivity ("Lo" displayed), high sensitivity ("Hi" displayed) and off ("OFF" displayed). After making your selection, wait a few seconds for the display to return to the operating frequency. Use low sensitivity when in a noisy area where other sounds might otherwise trigger the transmitter. When the VOX is enabled (with either high or low sensitivity), a tiny reverse "V" is displayed in the upper right corner.

NOTE: the VOX system is not designed work with the internal microphone or with external speaker/microphones.

DTMF Memories

The FT-411 provides ten memories, numbered 0 through 9, for storage of DTMF tone sequences of up to 15 digits each, for storage of commonly used remote DTMF control sequences or telephone numbers to be used on autopatching systems.

A special mode must be activated to use the DTMF memory features. This mode is toggled on and off by pressing F/M and then the CALL/-DTMF button on the top panel. A small telephone icon is displayed above the rightmost frequency digit when this mode is active.

To store a DTMF memory:

- (1) Activate the DTMF memory mode as just described.
- (2) Press and hold the F/M key for $\frac{1}{2}$ -second (until the second beep sounds).
- (3) Within 5 seconds of step (2), press a numbered key corresponding to the DTMF memory number you want to store. The display will change to the following:

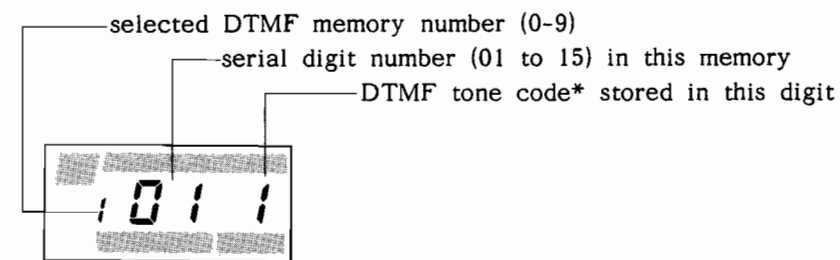

* DTMF codes are displayed as 0-9, A, b, C, d, E (for *), F (for #) and "-" for empty (none stored).

- (4) Again press and hold F/M for $\frac{1}{2}$ -second, and then key in the numbers of the DTMF sequence you want to store. As you do so, the serial digit number in the center of the display will increment automatically as the entered code is displayed at the right. If you make a mistake press the PTT switch and repeat this step.

- (5) After entering the desired DTMF sequence, press the CALL/DTMF key on to top panel briefly, and then press the numbered key corresponding to the memory number stored, to replay the stored codes in the loudspeaker.
- (6) Turn the DIAL knob to select another DTMF memory to store, if desired, and repeat steps (4) and (5).
- (7) Press the CALL/DTMF button to return to the frequency display.

To recall a stored DTMF memory on the air, first make sure the DTMF memory mode is activated (the telephone icon is displayed). Then close the PTT switch and press the number of the DTMF memory to transmit.

CAUTION: When the DTMF memory mode is active, the keypad cannot be used to transmit individual DTMF codes. Turn the DTMF memory mode off (F/M and then CALL/DTMF) if you do not have the required DTMF sequence stored in memory, and then enter the DTMF digits individually.

System Reset

To reset all programmable features and setting to their factory defaults, turn off the transceiver and then press and hold both the VFO and MR keys while switching it back on.

In Case of Problems

The basic features of this transceiver are not complicated, but it is still possible to get lost, at least until you have had the chance to learn all of the functions of the keypad and display. If the display shows nothing at all, check the power switch (VOL control), and if necessary, remove the battery pack and check that the contacts are clean. If all appears to be physically in order, recharge or replace the batteries.

The display includes enough symbols and function indicators to let you know what is going on as long as power is applied, so it is well worthwhile to study the display diagram on page 7 carefully. For example, if the frequency display changes unexpectedly when you transmit (or if 'Err' appears), check for a small '+' or '-' at the upper righthand corner. Also, if only a few seemingly non-sensical digits appear, try switching the set off and back on to clear any special display modes, such as tone squelch, repeater offset, channel step or DTMF memory setting.

Most illegal commands will cause two beeps to sound. If pressing a key appears to do nothing, first check for a small 'L' in reverse type at the lower left, which indicates if the keypad is locked. If so, press F/M and then LOCK(6) to unlock the keys. If the 'L' is not there, press F/M or CALL/DTMF on the top panel, which will terminate many partially entered commands. If you still cannot enter data, check the TX indicator to see if it is red, indicating that the transceiver is transmitting. Releasing the PTT switch should return the set to receive. If still nothing happens, switch the transceiver off, and then back on.

If you find the stored data is definitely non-sensical or far from what you want, try the System Reset procedure described on the previous page.

To avoid confusion resulting from inadvertent key presses, set the keypad lock on (press F/M and LOCK(6)) if you set the transceiver down while it is on, and then remember to set the lock back off when you wish to enter data.

Getting the Most from Your Batteries

How long the batteries last between charges or replacement depends largely on your operating habits, and how you care for the batteries (if using a rechargeable Ni-Cd pack). The FT-411 offers a variety of ways to conserve battery consumption, and thus to extend the charge life of the batteries. Knowing how to use these features properly can be critical in emergencies. Here is a summary of the features to consider if battery life is a concern:

- * Make sure that the set is off when not in use. This can also prevent premature battery pack failure from over-discharge.
- * Unless monitoring for calls, activate the APO feature so that power drain is minimized if you doze or are called away. Set the APO time for a 10 minute shutoff, increasing this time only if necessary.
- * Always use the power saver feature to monitor for calls (except packet). If you can ensure your callers will make calls at least $\frac{1}{2}$ -second long, you can make maximum use of this feature by setting the save time to 500 ms (there is little benefit in setting it any longer).
- * Choose a quiet frequency and close the squelch on background noise when monitoring for a call. The FTS-17 Tone Squelch option is useful for creating your own quiet channel if the entire band is crowded.
- * Use the lowest possible volume setting when listening to signals. In noisy environments, use an earphone or the YH-2 headset so you can keep the volume low.
- * Using the LOW power setting requires about 60% less current when transmitting, so it is a good idea to develop the habit of always using this setting, switching to high power only if low power fails to get through. If you live in a location where high power is almost always needed, consider replacing the antenna with a higher gain type instead of opting for high power (the result on transmit is the same, with the added benefit of better reception). Make sure that any external antenna is designed for 50-ohms impedance on the operating frequency.

As the battery discharges, the voltage drop when transmitting will increase. When the voltage becomes critical, a tiny battery icon appears at the lower right corner of the display, indicating that the batteries should be replaced or recharged as soon as possible.

If using rechargeable batteries, do not keep operating once the battery icon has come on, as this could cause over-discharge of the cells and destroy the pack. However, recharging Ni-Cd batteries often, with little use in between charges, can also shorten the useful charge life of the cells. Therefore the best way to get the most out of your Ni-Cds is to use the battery pack just until the battery icon comes on, and then immediately give the pack a full recharge. Unfortunately this is not always convenient, since it can be hard to tell exactly when the charge will run out. One solution to this problem is to carry an extra, fully charged pack with you if you do not wish to have operation interrupted.

Power and Charge Life Chart

Battery Model	Power (watts)	Charge Life* (hours, approx.)
Dry Cell Cases		
FBA-9 (UM-4 x 6)	2.0	6 (w/Alkaline)
FBA-10/-17 (UM-3 x 6)	2.5	6 (w/Manganese) 18 (w/Alkaline)
7.2V Ni-Cd Packs		
FNB-9 (200 mAh)	2.5	2
FNB-10/-17 (600 mAh)	2.5	5.5
FNB-14 (1000 mAh)	2.5	12
12V Ni-Cd Packs		
FNB-11 (600 mAh)	5.0	4.5
FNB-12 (500 mAh)	5.0	4

- * operating 6 sec transmit, 6 sec receive and 48 seconds standby, with VOL set for 0.25W receive audio, Power Saver ON and set for 300ms intervals (1:10 duty cycle).

