

2m FM TRANSCEIVER

FT-2500M

Operating Manual

- Military Spec. Construction
- High Efficiency, Integrated Die Cast Chassis and Heat Sink
- Advanced Track Tuning (ATT) Receiver
- Large Alpha-Numeric LCD Display
- 3 Variable Power Output Levels
- 31 Memories

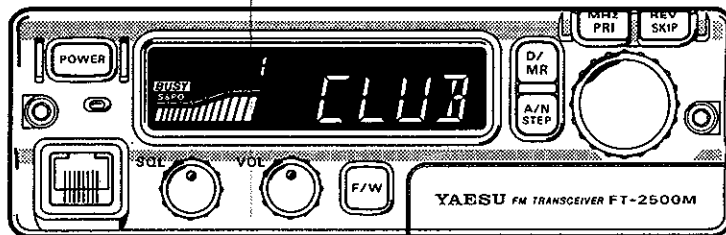

English

Spanish

French

YAESU

2m FM TRANSCEIVER FT-2500M

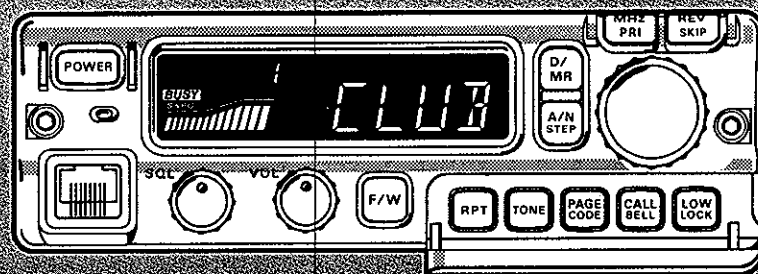

English

Table of Contents

<i>Specifications</i>	2	Priority Channel Monitoring	25
<i>Controls & Connectors</i>	3	CTCSS Operation	26
Display Indications	6	CTCSS "Bell" Paging	27
<i>Installation</i>	8	Customizing Ringer Melody Attributes	28
Antenna Considerations	8	DTMF Paging System	29
Mobile Installation	8	DTMF Code Squelch System	30
Base Station Installation	10	Storing & Enabling Code Memories	31
External Speakers & Microphones	10	Naming Paging Code Memories	32
<i>Operation</i>	11	DTMF Code Squelch Operation	33
Preliminary Setup	11	DTMF Paging Operation	34
Squelch Setup	12	Trigger Pager	36
Frequency Selection Modes	12	Special Paging Functions	36
Frequency & Step Selection	13	Ringer Melody Settings	38
Transmitting	14	Composing the User-Melody Ringer	39
Transmit Time-Out Timer	15	APO (Automatic Power-Off)	40
Repeater Operation	15	Adjusting Panel Backlighting	40
Automatic Repeater Shift	17	<i>In Case of Problems</i>	41
Storing Memories	17	Memory Backup	43
Recalling Memories	18	<i>Memory Cloning</i>	43
Odd Split Memories	19	<i>Packet Radio Interconnections</i>	44
Naming Memories	19	Squelch Status Modification	45
CALL Channel Memory	20	Modification for 9600-Baud Packet	46
Separate Tx Frequency Memories	21	<i>Internal Adjustments</i>	48
Memory Tuning	21	<i>Installation of Options</i>	49
Masking Memories	22	<i>FT-2500M Operators Quick Reference</i>	
Scanning	22	<i>Chart</i>	51
Memory Skip Scanning	23		
Programmed Limit Scanning	23		

E

FT-2500M Features

The FT-2500M is Yaesu's new successor to the famous FT-2400H, the industry's first amateur transceiver designed to meet rugged U.S. military specifications for shock and vibration (MIL-SPEC 810-C). The FT-2500M is upgraded with a new front panel and control knob layout, and additional operator features.

Selectable power output of 5, 25 or 50 watts without the need of forced air cooling is possible due to the large heatsink surface area of the compartmentalized one-piece diecast chassis. Backlighting for the large LCD (display) and knobs is manually adjustable, or automatically controlled by a photosensor, and the less-used buttons have a flip-down protective cover.

The thirty-one tunable memories can each be programmed with a 4-character channel name, which can then be displayed in place of frequency, as desired. Each memory offers complete programmability and scanning functions, such as independent tx/rx frequencies, independent repeater offset and CTCSS tone, programmable scan limits, selectable scan resume modes and memory skip, priority monitoring and a 1-touch instant-recall CALL channel.

Channel steps are user-selectable from 5 to 50 kHz, and Automatic Repeater Shift can set standard repeater shifts when you tune to a repeater subband. A 1750-Hz tone generator is included in European versions.

A 39-tone programmable CTCSS encoder is built in as standard, and the FTS-17A CTCSS unit can be installed to provide tone squelched private channels and a CTCSS paging bell feature to sound a paging alert tone when the tone squelch opens.

DTMF (Dual-Tone, Multi-Frequency) -based selective calling and private paging capabilities can be easily added with the optional FRC-6, controlled entirely from the front panel. You can select any of 999 3-digit ID codes for your transceiver, and then have your receiver stay quiet until your code is received (from any standard DTMF-equipped transceiver). When a call is received, the FT-2500M displays the caller's code, and a paging beeper can be set to sound and even to respond to the call automatically. Seven DTMF code memories store your ID plus those of six other frequently-called stations or groups you wish to monitor.

Specifications

General

Frequency Range: (Tx) 144 ~ 146 or 148 MHz,
(Rx) 144 ~ 146 MHz or 140 ~ 174 MHz

Channel Steps: 5, 10, 12.5, 15, 20, 25 & 50 kHz

Frequency Stability: $< \pm 10$ ppm (-20 to $+60$ °C)

Mode of Emission: F3 (G3E)

Antenna Impedance: 50 ohms, unbalanced

Supply voltage: 13.8V DC $\pm 10\%$, negative ground

Current Consumption (typical):

Rx: 600 mA, Tx hi/mid/low: 12/9/5A

Operating Temperature Range: -20 to $+60$ °C

Case Size (WHD):

160 \times 50 \times 180 mm (w/o knobs)

Weight: 1.5 kg (3.3 lb.)

Transmitter

Output Power (hi/mid/low): 50/25/5W

Modulation Type: Variable Reactance

Maximum Deviation: ± 5 kHz

Spurious Radiation: less than -60 dB

Microphone Impedance: 2k Ω

Receiver

Circuit Type:

Double Conversion Superheterodyne

IFs: 21.4 MHz & 455 kHz

Sensitivity (for 12dB SINAD):
better than 0.2 μ V

Selectivity ($-6/-60$ dB): 12/30 kHz

IF Rejection: better than 70 dB

Image Rejection: better than 70 dB

Maximum AF Output:

3.5 W into 4 ohms @10% THD

Specifications subject to change without notice or obligation.

Accessories

FTS-17A CTCSS Unit

FRC-6 DTMF Pager Unit

MH-26G8J Hand Mic w/Burst

MH-27A8J DTMF Keypad Mic

SP-7 External Loudspeaker

FP-800 AC Power Supply

Controls & Connectors

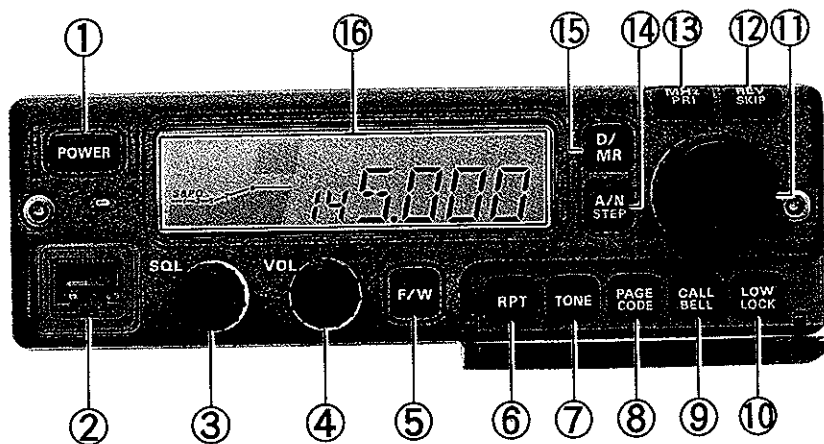

(1) **POWER** Button

Press this button to turn on the transceiver. Press and hold it for $\frac{1}{2}$ -second to turn it off.

(2) Microphone Jack

This 8-contact modular jack accepts transmit audio, tone call (burst) or dial/memory selection and scanning control from the microphone, and provides receiver audio for a speaker/mic. Memories can be copied to and

from another FT-2500M through this jack, and a Packet TNC can be connected.

(3) SQL Control

This control sets the threshold level at which a received signal (or noise) opens the squelch and can be heard. For maximum squelch sensitivity set this control from counterclockwise just until noise is silenced (and the **BUSY** indicator on the display is off) when the channel is clear.

Function Buttons (behind flip-down door)

To open the flip-down door, pry the right edge (next to the selector knob) out gently with a fingertip. To close the door, press upwards on the bottom edge of the door at its center. *Do not try to close the door by pushing from the front.*

The five buttons behind the door control most of the programmable features. If the beeper is enabled, one or more beeps will sound when a button is pressed, if the resulting command is accepted. The white label shows the primary function of each button. However, if you press the **F/W** button first, these buttons will perform alternate functions. On three of these, the alternate function is indicated by the orange label on or beneath the button. These are described in the *Operation* chapter. Also, see the functional *Quick Reference Chart* at the end of the manual for a short explanation of most button functions.

For descriptions in this manual, we refer to alternate button functions by preceding the button name with "**F/W** →" to remind you to press the **F/W** button first. For example, the expression **F/W** → **LOW LOCK** indicates that you should press the **F/W** button followed immediately (within five seconds) by the **LOW LOCK** button.

(4) VOL Control

This control adjusts the volume of the receiver audio and of the button beeper.

(5) **F/W** Button

This activates the alternate functions (orange labels) of most of the other buttons. It is also used to store current operating data into a

memory (by holding it down for ½-second, releasing and pressing again), and to toggle several programmable features.

(6) **RPT** Button

This toggles repeater shift: + (up), - (down) or off. The alternate function displays shift offset and ARS status.

(7) **Ⓣ** Button

This toggles the CTCSS (subaudible tone) features: encode (on transmission only), encode/decode (on both transmission and reception), and off. If the optional FTS-17A CTCSS Unit is not installed, only encode and off modes are available. The alternate function displays the CTCSS tone frequency and button beeper status.

(8) **Ⓟ** Button

This activates DTMF paging (or code squelch) if the FRC-6 DTMF Paging Unit option is installed. The alternate function displays DTMF Code Memories.

(9) **Ⓞ** Button

Press this to jump to and from your CALL channel memory. The alternate function toggles the CTCSS paging bell, described later.

(10) **Ⓛ** Button

Press this button while receiving to toggle high/medium and low transmitter power (50/25 and 5 watts, respectively). The display shows "LOW" (above the S-meter) when either low or mid-level power is selected. The alter-

nate function of this button disables the selector knob and most of the front panel buttons (except itself, **Ⓢ** and **Ⓟ** and the microphone buttons). Press **Ⓢ** and this button again to unlock the panel.

(11) Selector Knob

This 24-position detented rotary switch is used for tuning, memory selection and most function settings. The microphone UP/DWN buttons duplicate the functions of this knob.

(12) **Ⓡ** Button

During split-frequency operation, such as through a repeater, this button reverses transmit and receive frequencies. During memory operation, the alternate function sets the current memory to be skipped during scanning.

(13) **Ⓜ** Button

This button allows tuning in 1-MHz steps (the kHz digits blank on the display). If receiving on a memory, pressing this button the first time activates the *Memory Tune* (MT) mode, and pressing it again enables 1-MHz steps. The alternate function of this button activates priority monitoring, described in the *Opera-*

tion chapter (f^7 displayed instead of the memory number to the upper left of the frequency).

(14) **A/N STEP** Button

While receiving on a memory, pressing this button toggles the display between frequency and alphanumeric name. The alternate function displays (and allows changing) the tuning step size, and the scan-resume mode, as described later.

(15) **D/MR** Button

This button switches operation between the two main tuning modes: dial and memory. The alternate function cancels alternate func-

tions of other keys. This button is duplicated by a button on the microphone in non-European versions.

(16) Display

The display segments are as shown below. The main digits on the display may show operating frequency, memory name, or any of many parameters during setting, such as tuning step size, CTCSS tone frequency, or DTMF Code Memory contents if the FRC-6 Paging Option is installed.

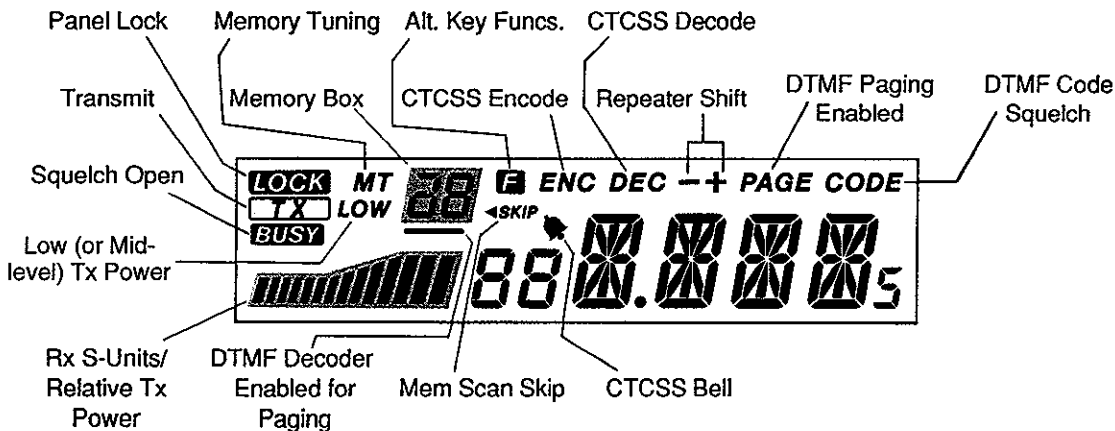

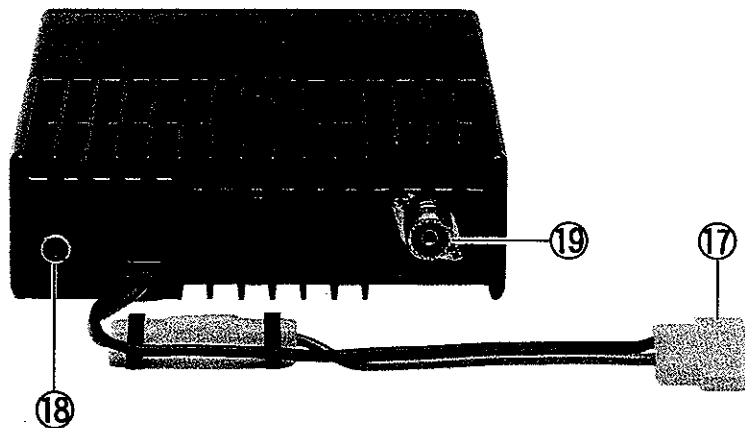

(17) 13.8VDC Cable Pigtail w/Fuse

This is the power supply connection for the transceiver. Use the supplied DC cable to connect this pigtail to the car battery or other DC power supply capable of at least 12 Amperes (continuous duty). Make certain that the red lead connects to the positive side of the supply. The fuse is 15-A, fast-blow.

(18) EXT SP Jack

This 2-contact mini phone jack accepts a 4- to 16-ohm external speaker such as the Yaesu SP-7. Inserting a plug disables the internal speaker.

(19) ANT Coaxial Socket

Connect a 144-MHz antenna to this type-M (SO-239) socket using 50-ohm coaxial cable and a type-M (PL-259) plug. Make sure the antenna is designed specifically for use on the operating frequency.

Installation

This chapter describes installation of the FT-2500M with typical supplied accessories. Installation of internal options (the FRC-6 DTMF Pager Unit and the FTS-17A CTCSS Unit) are described at the back of this manual. If you have any of these options, turn to *Installation of Options* at the back before installing the transceiver as described below.

Antenna Considerations

The FT-2500M is designed for use only with an antenna having an impedance near 50 ohms on the 2-meter band. For optimum performance use a high quality, carefully designed antenna. The antenna should always be connected when operating the transceiver, to avoid damage that could otherwise result if transmission occurs accidentally without an antenna.

Make sure your antenna is designed to handle 50 watts continuous transmitter power.

For best performance and safety in mobile installations, mount the antenna in the center of a flat surface, out of reach of human hands: 50 watts can cause an RF burn to anyone touching the antenna during transmission!

Also for best performance use the shortest possible length of thick, top-quality coaxial cable for your feedline. Be sure to use a matching type-M plug for the jack on the transceiver.

Mobile Installation

The FT-2500M must only be installed in cars having a negative ground electrical system. Mount the transceiver where the display, controls and microphone are easily accessible, using the supplied MMB-48 mobile mounting bracket. The transceiver may be installed in any position, but should not be near a heater vent or where it could interfere with driving. Make sure to provide plenty of space at the top and rear so that air can flow freely through the heatsink. Refer to the diagrams on the next page for installation.

- Decide the mounting location with sufficient clearance for the transceiver, plus space for ventilation above and behind the set. Use the mounting bracket as a template to mark the locations of the mounting holes. Use a 4.8-mm ($\frac{3}{16}$ ") bit to drill the holes, and secure the bracket with the four supplied long screws, washers and nuts (see diagram).

- ❑ Position the transceiver in the bracket so that the holes in the sides are aligned with those in the sides of the bracket, and bolt the transceiver into place with the supplied short screws and flat washers.
- ❑ The microphone hanger may be installed wherever convenient.

Mobile Power Connections

To minimize voltage drop and avoid blowing the car fuses, connect the supplied DC cable directly to the battery terminals. *Do not attempt to*

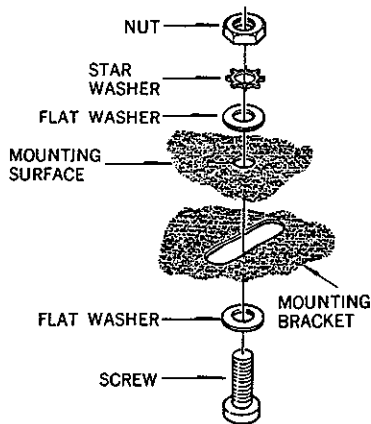

defeat or bypass the fuse — it is there to protect you and the equipment.

- ❑ Before connecting the transceiver, check the voltage at the battery terminals while revving the engine. If it exceeds 15 volts, adjust the car regulator before proceeding.
- ❑ Connect the RED power cable lead to the POSITIVE (+) battery terminal, and the BLACK lead to the NEGATIVE (-) terminal. If you need to extend the power cable use #14 AWG or larger insulated, stranded copper wire. Connect the cable to the transceiver pigtail only after connecting to the battery.

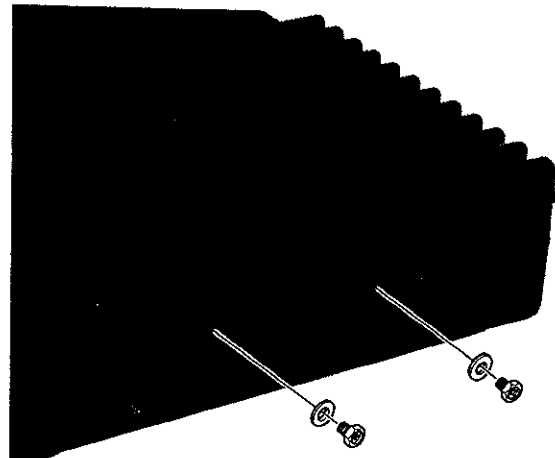

Warning!

Never apply AC power to the power cable of the transceiver, nor more than 15 volts DC. When replacing the fuse, use only a 15-A fast-blow type. Damage resulting from failure to adhere to these precautions may void your warranty.

Base Station Installation

Operation from the AC line requires a power supply capable of providing at least 12 A continuously at 13.8-V DC. We recommend using an external speaker, since the internal speaker is mounted on the bottom of the transceiver. The FP-800 AC power supply/loudspeaker is available from your Yaesu dealer to meet these needs. Use the DC power cable supplied with the transceiver for making power connections, and con-

Note!

The P button at the top right corner of the MH-27A8J has no function when used with the FT-2500M.

nect the external speaker cable to the speaker jack on the rear panel.

External Speakers

Using an external speaker with the FT-2500M lets you position the source of audio where it is most convenient to overcome background noise in and around the car. The optional SP-7 External Speaker includes its own swivel-type mounting bracket, and is available from your Yaesu dealer. Of course the older SP-3, SP-4 or SP-55 External Speakers may also be used. Plugging in an external speaker disables the speaker in the transceiver.

Microphones

The MH-26G8J microphone for the European (version B) FT-2500M includes a button on the front for transmitting a 1750-Hz burst tone, to access repeaters that require it. The MH-27A8J DTMF keypad microphone also includes a button on the front, which, when used with the version-A FT-2500M, duplicates the  button on the front panel of the transceiver. Both microphone models include a PTT (Push-To-Talk) switch to activate the transmitter, and UP/DWN buttons for tuning and memory selection.

Operation

This chapter describes the transceiver functions in detail. After studying these descriptions, refer to the *FT-2500M Operator's Quick Reference Chart* at the end of the manual in case you need to refresh your memory.

Preliminary Setup

Before operating the transceiver, recheck power supply and antenna connections, and connect your microphone to the front panel jack. Never operate the transceiver without a proper antenna for the operating band. Also, please read the earlier *Controls & Connectors* section, if you have not already, to familiarize yourself with the controls.

As mentioned before, references to alternate button functions have "F/W →" in front of the button name to remind you to press the F/W button first momentarily, and then the other button within five seconds (while F appears above the leftmost frequency digit on the display). Don't hold the F/W button down longer than 1/2-second *unless told to do so*, as that will give you a different result, and don't press two buttons as the same time (except the PTT switch, when storing a separate transmit frequency). When a but-

Turning Power Off

To turn the transceiver off, you must press and hold the POWER button for 1/2-second.

ton should be held down (as opposed to just pressed momentarily) the instructions will say so.

A five-second timer starts when you press F/W, and clears when you press a button to make a new selection. If you don't make a selection in five seconds, the button functions return to normal (white labels).

A beeper provides useful audible feedback when buttons are pressed, at a level determined by the volume control. Each button has a different beep pitch, and each function has a unique beep combination. For example, when you press the LOW LOCK button, you will hear a pair of low-, medium- or high-pitched beeps corresponding with the RF power level selected. You can disable the beeper as described in the box on the next page, but we recommend you keep it enabled while getting to know the controls.

Disabling the Beeper

If you want to turn the beeper off (or back on), you can press **F/W** → **Ⓣ** → **F/W** → **Ⓣ** (each button twice, alternately). If you lock the controls (page 14) and have the beeper enabled, pressing a button will sound a different musical note for as long as it is held.

If you have trouble getting the transceiver to work as described, see *In Case of Problems* on page 41.

Squelch Setup

Before turning on the transceiver for the first time:

- Preset the VOL and SQL controls fully counter-clockwise.
- Press the **POWER** button (if the transceiver is off) and adjust the VOL control for comfortable volume on the noise or any received signal. **BUSY** should be displayed in reverse letters at the far left.
- If you hear a signal, turn the selector knob to a clear channel (only noise).

- Turn the SQL control clockwise just to silence the noise. The **BUSY** indicator will disappear. Setting the SQL further clockwise reduces sensitivity to weak signals. Whenever a signal reaches the receiver that is strong enough to open the squelch, **BUSY** is displayed.

Note that while receiving, one or more bargraph segments may appear at the lower left corner of the display, indicating signal strength of received signals. This is not affected by the squelch setting, so even squelched signals can give some indication. If more than two bargraph segments appear while the squelch is closed, try reducing the squelch control setting (if you want to hear weak signals).

Frequency Selection Modes

Dial Mode

This mode is for tuning or scanning the band when looking for a channel on which to operate, when you don't have a specific frequency in mind. In this mode, the selector knob and microphone UP/DWN buttons each tune the band in the selected step size, or in 1-MHz steps, and the scanning function tunes in the selected step size.



Memory Mode

This mode is mainly for operating only on specific frequency channels known in advance (and programmed into the memories). For example, after storing the frequencies of your local repeaters into memories, you can limit operation to only those channels by selecting the memory mode. In this mode, the selector knob, microphone UP/DWN buttons and scanning function select sequentially from the stored memories. The FT-2500M gives you 31 memories, each of which can store repeater shift and direction, CTCSS settings, and separate receive and transmit frequencies. There is also a *Memory Tune* mode, in which you can tune just like the dial mode, and store the resulting retuned memory into the same or another memory. This and other special memory mode functions are described later, but you will want to keep these terms in mind.

You can tell at a glance which type of operation is in effect by looking in the shaded memory box above and to the left of the frequency display. If the box is empty, you are in the dial mode. If you see a number or an \downarrow , \uparrow or \square in the box, you are in the memory mode.

The $\left(\frac{D}{MR}\right)$ button near the top right corner of the display (and the button on the front of the MH-27A8J microphone in the U.S.A. version) toggles between the dial and memory modes. While in the memory mode, your previous dial mode selections are preserved. Also, when you switch from the dial to the memory mode, the last-selected memory is recalled.

Frequency & Step Selection

You can select a new operating frequency from either the dial mode or by retuning a memory. For now, we suggest using the dial mode. If you see a memory number in the memory box, press $\left(\frac{D}{MR}\right)$ to switch to dial mode. There are two ways to select your operating frequency: by the selector knob, or with the microphone UP/DWN buttons. However, holding one of these buttons for more than $\frac{1}{2}$ -second starts the scanner. This is described later, but if you've already started it, just press the PTT to stop.

To select the MHz range in which you wish to operate: first press $\left(\frac{MHz}{PR}$ (above the selector knob) so that the kHz digits are blanked, and then turn the knob. To return to normal tuning and display, just wait five seconds, or press $\left(\frac{MHz}{PR}\right)$ again to re-display the kHz digits, and then turn the selector knob.

Locked Controls

If nothing happens when you press a button or turn the selector knob, the controls may be locked. Check for **LOCK** at the top left corner of the display, and if you see it, press **F/W** → **LOW LOCK** to unlock the controls. Later you will want to enable the lock (with the same button sequence) to prevent having your settings disturbed. Pressing buttons while locked sounds different musical notes for as long as a button is held, but only the unlocking sequence affects operation.

Default channel (tuning) steps are 5 kHz in all transceiver versions, to select another step size, press **F/W** → **A/N STEP**, turn the selector knob for the desired steps, and press **A/N STEP** again. See the box above if the buttons or knob fail to operate.

Transmitting

Press **LOW LOCK** (behind the flip-down door) several times, if necessary, to select low power output. The display returns to normal after a few seconds, and **LOW** appears to the left of the memory box (when either low or mid-level power is se-

lected). When you wish to transmit, wait until the channel is clear (**BUSY** not displayed), and squeeze the PTT switch on the microphone while talking across the front of it. During transmission, **TX** appears at the left side of the display, and the **S & PO** bargraph shows relative transmitter power output; 4-segments for low power, 8- for mid-level, and full-scale for high (see below). Release the PTT switch to receive.

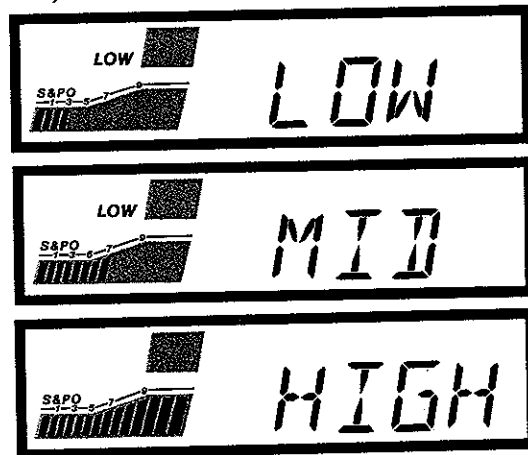

FT-2500M Power Settings

If you require more power press **LOW LOCK** again (to switch to medium or high power). However, we recommend using low power whenever possible to minimize possible interference, current consumption and heating.

If using a European version, press the button on the front of the mic. to transmit a 1750-Hz Burst Tone to access repeaters that require it.

Transmit "Time-Out Timer"

The Time-Out Timer limits transmit time after the PTT is first pressed (from 5 to 60 mins.), after which the transmitter automatically un-keys (even if the PTT is still depressed). To reset the timer and transmit again, the PTT must first be released. This feature is useful to limit long key-down periods when high power-output is selected, or to limit interference and protect your radio in the event that the PTT switch becomes inadvertently stuck depressed (between the car seats, for example).

- Press and hold **[F/W]** for ½-second, then press **[MHz PRI]**, the display will appear as below.
- Rotate the selector knob to select the tx time limit (5 - 60 mins.), in 5-min. increments, or **[OFF]** for off, then press **[MHz PRI]** again to save the setting, and return to the frequency display.



The TOT now starts *each time you press the PTT* and resets after its release. When the timer expires, a beep sounds and the **[TX]** indicator blinks as the transmitter un-keys (**S & PO** segments will remain lit until PTT is released).

Repeater Operation

The FT-2500M offers several methods to set up split frequency operation for repeaters: manual (band, and memory-specific), automatic (ARS), and independently stored transmit/receive frequencies. The manual and automatic methods shift the transmit frequency above or below the receive frequency by a programmable offset. This offset is preset at the factory to 600 kHz, but can be easily changed as described in the box on the next page.

When in the dial mode, only one offset at a time can be used. This offset can only be changed while in the dial mode, and is applied any time repeater shift is activated (manually, or by ARS) in the dial mode. For repeaters that require an odd split, you can either program a memory-specific offset, or store an independent transmit frequency in the same memory. These methods are described later in the discussion on memories.

To activate the standard shift manually, just press the **[RPT]** button: once for minus shift, again for plus shift, and again to return to simplex. A small "-" or "+" sign appears at the top center of the display when minus or plus shift is selected, respectively.

Example: To operate through a 146.34/146.94 MHz repeater:

- Tune the display to 146.340 MHz (to receive on the output frequency).
- Press **[RPT]** once, a "-" (minus) should appear at the top center of the display (if not keep pressing **[RPT]** until it does).
- When the channel is clear, press the PTT switch on the microphone and send your call sign. The display should shift to 146.340 MHz while you transmit.

Of course this example only works if the offset is set to 600 kHz, as supplied from the factory. You can change it as described in the *Repeater Offset & ARS* box at the right.

With repeater split activated, you can reverse the transmit and receive frequencies by pressing the **[REV SKIP]** button above the selector knob. Use this to display the transmit frequency without transmitting, and to check the strength of signals on a

Repeater Offset & ARS

To display the current repeater offset, press **[FW] → [RPT]**. The offset is displayed in MHz, to three decimal places. You can change the offset in 50-kHz steps with the selector knob or microphone **DOWN** and **UP** buttons. In most cases you will want to keep the repeater offset programmed to the most commonly used split in your area.

Also, you can enable/disable *ARS* (Automatic Repeater Shift) by pressing **[FW]** at any time while the offset is displayed. An **A** appears in the memory box when *ARS* is enabled.

When set as desired, press **[RPT]** to return the display to the operating frequency.

repeater uplink frequency. The repeater shift sign blinks while reverse split is selected. Press **[REV SKIP]** again to return to the normal shift direction.

Automatic Repeater Shift

The ARS (Automatic Repeater Shift) feature activates repeater offset automatically whenever you tune to the standard repeater subbands (see chart below). With this feature enabled, a small "-" or "+" at the top center of the display indicates that repeater shift is active, and pressing the PTT switch changes to the (shifted) transmit frequency.

The ARS function is enabled at the factory. See the box on the previous page to disable it.

As already mentioned, you can use the manual shift method (RPT button) at any time to select a new shift state, whether ARS is activated or not. However, if you change frequency inside a repeater subband with ARS activated, manual repeater shift selections are canceled.

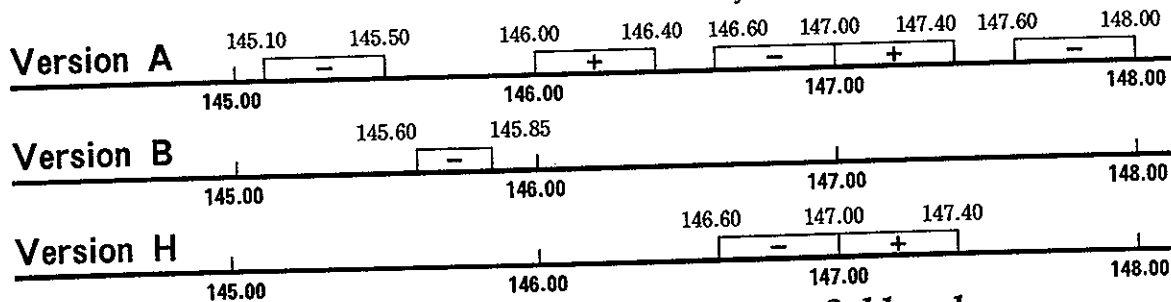

Automatic Repeater Shift - Repeater Subbands

Storing Memories

The FT-2500M offers 31 channel memories, labeled 1 ~ 28, L, and U. Each can initially store the current operating data from the dial mode or a retuned memory. Once a memory has been stored, its repeater shift and offset, CTCSS tone data and settings for the DTMF Paging and CTCSS options can be modified, a 4-character name can be assigned, and a separate transmit frequency can be stored. Memory C (the CALL channel memory) can be recalled instantly by the  button, and memories L and U store programmable subband limits, described later, in addition to general purpose operation.

To store a frequency in memory:

- Select the desired frequency (and repeater split direction, if desired) in the dial mode as already described, or by retuning a memory.

- Press and hold **[FW]** for ½-second, until a second beep sounds. A memory number or letter appears blinking in the memory box.



Shaded Memory Box

- Within five seconds of pressing **[FW]**, use the selector knob or microphone DWN and UP buttons to select the desired memory for storage (in the memory box). If you select one that was already being used, it will be overwritten with new data in the next step.
- Press **[FW]** momentarily to store the displayed data into the selected memory. The memory label will stop blinking for a second, and then disappear as operation continues in the dial mode.

Example: Store the 146.340/146.940 repeater data in memory 5.

- First perform the steps in the example on page 16 to set up the desired frequency and offset on the dial.
- Press and hold **[FW]** for ½-second to display a memory label in the memory box, then do the next step within 5 seconds.

- Turn the selector knob so that **5** (the memory number to store) shows in the memory box.
- Press **[FW]** again, momentarily. That's it. The dial data has been stored in memory 5. After a few seconds the memory box will clear, and you are left operating from the dial.

To confirm that this worked, turn the selector knob to change the dial frequency (to anything), then press **[D/MR]** to change from dial to memory mode. The numeral **5** should appear in the memory box, and **145.940** (the receive frequency) should appear on the display. Press **[REV SKIP]** to confirm the transmit frequency (**146.340** MHz).

You can use any memory (except C, the CALL channel) with the same result. Memory C requires a slightly different procedure. Notice that pressing **[D/MR]** from the dial mode always recalls the last stored or used memory.

Recalling Memories

In confirming the results of the last example, we pressed **[D/MR]** to change from the dial mode to the memories after they were stored. The memory label appears in the memory box at the upper left corner of the frequency display whenever operating on a memory.

When more than one memory has been stored, you can select a memory for operation with either the selector knob or the microphone DWN and UP buttons. If you use these buttons, press and release the button for each memory: if you hold the button down for ½-second, memory scanning will start.

Odd-Split Memories

After storing a frequency, with or without repeater shift, from the dial, you can modify the repeater shift and offset of that memory only. Just recall the memory, press **[RPT]** as necessary to set the shift direction, and then follow the steps in the "Repeater Offset & ARS" box on page 16. If you want to make the new offset permanent for that memory, remember to press and hold **[F/W]** for ½-second, until the second beep sounds and then press it again momentarily. Of course you could also store a separate transmit frequency in the memory (described later) to obtain the same result, but you may find this more straightforward when dealing with repeaters.

Naming Memories

Once you have stored a memory, you can assign it a name or abbreviation to be displayed when it is recalled, in place of the frequency.

Names can be up to four characters long, using the following alpha-numeric 51-character set.

Alphanumeric Character Set

[M]	A	B	C	D	E	F	G	H	I	J
K	L	M	N	O	P	Q	R	S	T	U
V	W	X	Y	Z	0	1	2	3	4	5
6	7	8	9	\$	()	*	+	-	/
=	?	^	_	~	{	}	%			

To store a name, *first store the memory and then recall it* as described previously.

- Select a memory channel, then press and hold **[F/W]** for ½-second, until the second beep sounds and the memory number starts blinking in the memory box.
- Within five seconds of pressing **[F/W]**, press **[A/N STEP]**. Unless a name was previously stored for this memory, the frequency will be replaced by a blinking **u**, in the MHz-digit's place.
- You can now use the selector knob to choose the first character of the name to be displayed.
- After selecting the desired character, use **[MHZ PRI]** or the microphone UP button to get the next **u** blinking, and use the selector knob to set this character.

- Repeat the last step until all characters are set as desired, and then press **[A/N STEP]** twice. At the first press, the display returns to the memory frequency. After the second press, the memory name is displayed — for this and any other memories that have been assigned names (unnamed memories are still be displayed as channel frequencies).

You can toggle between frequency and name views for named memories at any time (*while receiving on a memory*) by pressing **[A/N STEP]**.

CALL - Channel Memory

Although invisible to the memory recall method described so far, the CALL channel memory can be instantly toggled by the **[CALL BELL]** button. **[CALL BELL]** appears in the memory box when the CALL memory is active. The factory default for the CALL channel memory is *the bottom edge of*

the amateur band for the country the transceiver is exported to. You can reprogram it from the dial with any frequency and repeater state, or even a separate transmit frequency. After storing the frequency, you can also set and change repeater settings, and give it a name to display in place of frequency, just by recalling it before following those procedures.

To store the current dial frequency/repeater state in the CALL channel memory, hold **[F/W]** for ½-second to display something in the memory box, then press **[CALL BELL]**. To store a name for the CALL channel, follow the same steps for a regular memory after pressing **[CALL BELL]** (so the procedure is done while **[CALL BELL]** appears in the memory box). To store a separate transmit frequency in the CALL channel, after storing the receive frequency, tune the dial to the transmit frequency and repeat the storing procedure above, but this time holding the PTT switch when you press **[CALL BELL]**.

Note!

Names stored in memories *always stay with the memory number* - they are not copied or overwritten when storing a returned memory into another memory.

Separate Transmit Frequency Memories

Besides the CALL memory, all other memories can store independent rx and tx frequencies (however, if you are operating through a repeater, you might find storing a unique repeater offset to be simpler — see *Odd-Split Memories*). To store a separate tx frequency.

- Store the rx frequency using the method described under *Simple Memory Storage* (it doesn't matter if a repeater offset is active).
- Tune to the desired tx frequency, then press and hold **[F/W]** for ½-second to display the memory label box again.
- Press and hold the PTT switch while pressing **[F/W]** once more momentarily (this will not key the transmitter).

Whenever you recall a separate transmit frequency memory, “-+” appear together at the top center of the display. As with regular repeater offset operation, you can press **[REV SKIP]** to display the transmit frequency, but in this case both shift symbols will blink.

After storing a memory with a separate tx frequency, if you rewrite the rx frequency, the separate tx frequency is deleted.

Memory Tuning

While receiving on a recalled memory, you are free to change settings such as repeater shift and offset as already described, as well as CTCSS and DTMF Paging settings, described later. However, in the memory mode, the selector knob and microphone UP/DWN buttons normally just select from among the stored memories. To change the function of these controls so that you can retune the current memory, press the **[MHz PR]** button momentarily. **MT** appears to the left of the memory label in the memory box, and you can tune in the same ways as described before for the dial mode (including MHz steps). If you are displaying the memory name instead of frequency, the display will change to frequency while you tune.

You can store the new frequency and settings in the current, or another, memory. Just press and hold **[F/W]** for ½-second, select the new memory (if desired), and press **[F/W]** again momentarily. Operation remains on the (new) memory as the old memory reverts to its original state. After retuning a memory, if you don't want to save your changes, just press **[D/MR]**: once to return to the original memory data, or twice if you want to leave the memories and return to the dial mode.



Masking Memories

As already mentioned, storing data in a memory automatically overwrites previously stored data (except the memory name). However, if you regularly move from one operating area to another, you may not always want to use the same memories. With the FT-2500M, you can determine which memories are available during memory selection and scanning without having to rewrite them from scratch. This is done by masking certain memories from selection and operation, and restoring them only when desired.

To mask any memory (except Memory Ch. 1),

- Recall the memory you want to mask, then press **F/W** for ½-second (until the second beep and the memory label blinks). If you were displaying the memory name, it now reverts to frequency.
- Press **REV SKIP**. The display changes to memory channel 1, and the previously selected memory can no longer be selected manually, or by scanning (described later).

To restore a masked memory for operation,

- Recall any memory, then press and hold **F/W** for ½-second.

- Next select the memory number to be restored, then press **REV SKIP** (not **F/W**!).

After you have masked some memories, be careful not to overwrite them accidentally. If you do, you will lose all channel data except the name.

Scanning

Before you start scanning, make sure the SQL control is set to squelch off the noise on a clear channel. You start and stop scanning with the DWN and UP buttons on the microphone. Just press and hold the button for more than ½-second to start scanning. If the transceiver is in the dial mode, band scanning will result. Otherwise, if a memory label is displayed, only the memories will be scanned.

The scanner pauses when a signal opens the squelch, and the decimal point on the display blinks. Scanning resumes according to one of two selectable modes- *Pause* or *5-Second* and is explained in the box found on the next page. You can also stop the scanner manually by pressing **D/MR**.

Scan Resume Mode Selection

You have a choice of two scan-resume modes: either *Pause* mode, in which the scanner pauses for as long as the carrier keeps the squelch open, or the *5-Second* mode, in which the scanner pauses for five seconds and then resumes scanning whether the signal is still present or not. The *5-Second* mode is the factory default.

To change the scan-resume mode (when not scanning), press **F/W** → **AN STEP**. A **P** or **S** in the memory box indicates the current mode. If you want to change it, press **F/W** momentarily. Press **AN STEP** again to return to the frequency display when the scan-resume mode is set the way you want it.

Memory Skip Scanning

When you have some very active channels stored in memories you may wish to skip them when scanning, but still have them available for manual selection. You can mark a memory to be skipped by pressing **F/W** → **REV SKIP** while receiving on the memory (**SKIP** appears in tiny letters just to the right of the memory number box to show

that this memory will be skipped during scanning (although you can still recall it manually). Once set, the scan skip state remains with the memory until it is specifically canceled.

To do this and re-enable the memory for scanning, just repeat the steps you took to disable it: select the memory manually, and press **F/W** → **REV SKIP**.

Programmed Limit Scanning

Besides band and memory scanning, the FT-2500M can be set to tune or scan only between two frequency limits of your choice (with the selected channel steps). Briefly, the procedure is to store the limits in the special memories labeled **L** (lower) and **U** (upper), and then with either memory recalled, press **MHZ PRI** momentarily.

As described previously in *Memory Tuning*, **MT** appears in the memory box (but this time it is blinking), and you can tune the memory, although the frequencies stored in memories **L** and **U** now limit the tuning and scanning range to the resulting subband. If the either **ARS** or manual repeater shift is activated, repeater offset is applied automatically when you transmit (even if the resulting transmit frequency is outside the subband limits). If you store an odd repeater

offset (this is, one different from the dial mode's repeater offset) in one of the limits, the odd offset will be applied.

Note: The frequency resolution of subband limits is 100 kHz, although the channel resolution of memories L and U is the selected channel step size. Therefore the frequencies stored in both memories L and U are rounded down to the nearest 100 kHz to determine the actual subband limits. Since they are not limited to a specific frequency, you can still use memories L and U for other purposes on any frequency within the 100-kHz range above the intended subband limit.

Example: To limit reception to 144.0 ~ 145.0 MHz.

- Tune the dial to *any frequency between 144.000 and 144.095 MHz.*
- Hold **[FW]** for ½-second, tune the selector knob so that **L** appears in the memory box, and then press **[FW]** again momentarily. The displayed frequency is now stored to provide an effective lower subband limit of 144.000 MHz.

- Tune the dial to any frequency between 145.000 and 145.095 MHz.
- Repeat the second step, selecting **U** in the memory box. This stores the effective upper subband limit of 145.000 MHz.
- Press **[D/MR]** to change to memory operation, then press **[MHz PRI]** momentarily to activate the 144.000 ~ 145.000 subband limits for tuning and scanning.

To cancel your subband limits and return to memory operation, press **[D/MR]** (if you are scanning, or want to return to dial operation, you must press it twice). Pressing the **[CALL BELL]** button also cancels subband limits as operation switches to the CALL channel.

Once you have stored the L and U memories, you can reactivate the subband just by recalling either memory and pressing **[MHz PRI]**. However, you cannot activate the subband when the L or U memories are marked for skip-scanning (you'll get ordinary memory tuning), or if either of these memories are masked (hidden).

Priority Channel Monitoring

Priority monitoring provides automatic checking for activity on a priority channel (memory) every five seconds while operating on the dial or other memories. When the receiver detects a signal on the priority channel, operation automatically shifts to that memory while the signal is present (plus a few seconds). If you transmit while paused on the priority channel, priority monitoring ceases and operation stays on the priority memory.

To set up for priority monitoring:

- Preset the squelch, and store the frequency to be monitored in a memory (this must be memory 1 if you will be operating on other memories during priority monitoring).
- Press **[D/MR]** to operate in the dial mode, or else select the memory you want to operate on, and then press **[F/W] → [MHZ/PRI]**.

P appears in the memory box, and about every five seconds the displayed frequency shifts to the priority memory briefly while the receiver checks for a signal.

While no signal appears on the priority channel to open the squelch, you can tune, transmit and receive on the dial, or select and operate on other memories (but not scan them). If a station you wish to talk with appears on the priority memory, press the PTT switch momentarily while receiving their signal, to stop priority checking. Otherwise, when a signal appears on the priority memory, priority checking will pause and the decimal on the display will blink.

Priority monitoring will resume according to how you set the scan-resume mode - either after a 5-second pause, or after the carrier drops (see page 23). To cancel priority monitoring manually, press **[D/MR]**.

Note that you can use any other memory as a priority channel in the above procedure when you are going to be operating in dial mode. You cannot, however, switch from memory to dial operation or vice-versa without first canceling priority monitoring (pressing **[D/MR]** cancels priority monitoring). You also cannot scan during priority monitoring.



CTCSS Operation

The built-in tone encoder function can be used to access repeaters and stations that require a CTCSS (subaudible) tone, by sending a tone whenever you transmit. Also, *if you have the FTS-17A CTCSS Unit option installed*, you can silently monitor for calls on busy channels. The encode function superimposes a subaudible tone (at a frequency too low to be heard) on the transmitted carrier. The optional (FTS-17A) decode function monitors receiver audio through a narrow filter at the same subaudible frequency, keeping the squelch closed until you receive a matching tone. *Installation of Options* at the back of this manual describes installation of the FTS-17A.

To check or set the CTCSS tone frequency, press **[F/W] → [TONE]** to display the tone frequency in Hz. To change the tone frequency, rotate the selector knob or press the microphone DWN and UP buttons until the display shows the tone frequency you require (from the choices in the table at the right).

FTS-17A Tone Frequencies			
67.0	94.8	131.8	186.2
69.3	97.4	136.5	192.8
71.9	100.0	141.3	203.5
74.4	103.5	146.2	210.7
77.0	107.2	151.4	218.1
79.7	110.9	156.7	225.7
82.5	114.8	162.2	233.6
85.4	118.8	167.9	241.8
88.5	123.0	173.8	250.3
91.5	127.3	179.9	

Press **[TONE]** to return to the operating frequency display after checking or selecting the tone frequency.

To activate CTCSS operation just press **[TONE]** when the operating frequency is displayed. **ENC** (encode) appears at the top of the display and the tone generator is activated for transmission. If you press **[TONE]** again without the FTS-17A option, the encoder turns off. If the FTS-17A is installed, both **ENC** and **DEC** (decode) are displayed together as tone squelch is activated for both transmission and reception (requiring a matching tone frequency to open the squelch). Pressing **[TONE]** once more disables the tone squelch.

You can store different CTCSS tones (and encode/decode states) in each memory in the same manner (and at the same time) as storing operating frequencies. Later, to change the tone or state stored in a memory, just recall it, reset the tone frequency or function, and store the memory again.

CTCSS "Bell" Paging (with the FTS-17A)

CTCSS Bell operation is very similar to the CTCSS encode/decode operation just described, in that subaudible tones open the squelch. However, if you are waiting for a call, it is sometimes convenient to have the transceiver "ring" to get your attention. The CTCSS Bell mode displays a small bell (🔔) above the 10's-of-MHz frequency digit on the display (or to the left of the name, if displaying a memory by name). When you receive a matching CTCSS call, 🔔 blinks to indicate you received a call, and the transceiver rings like a telephone if you have the ringer enabled (see the box on the next page). To activate the CTCSS Bell:

- Tune to the desired frequency or memory, then select a CTCSS tone frequency using the **[F/W]** and **[TONE]** buttons as described on the previous page, if you have not already.
- When you expect to receive calls from stations using tone squelch (decoding, or CTCSS Bell at their end), activate tone squelch encode/decode operation as described above, so they will not miss your signal when you turn off the CTCSS Bell later to reply.

- Press **[F/W]** → **[CALL BELL]** to activate CTCSS Bell paging (🔔 appears).

As with CTCSS decoding, only those calls with the matching CTCSS tone will cause the transceiver to ring and the squelch to open while the caller transmits, all others are ignored. 🔔 begins to blink, and continues until you manually reset it (by pressing the PTT switch to transmit). Note that the other station does not need to be using the CTCSS Bell function to call you: they can use normal CTCSS encode-only (or encode/decode) functions of their transceiver.

When you receive a call, if you have the ringer enabled, you need to disable the CTCSS Bell feature to prevent ringing every time the other station transmits: press **[F/W]** → **[CALL BELL]** to turn it off.

The CTCSS Bell settings can be individually programmed for each memory channel.

Note: If you activate the Bell without having an FTS-17A installed, it will ring every time the squelch opens.

Customizing Ringer Melody Attributes

You can control the way the transceiver rings when either a selective call (CTCSS Bell, or DTMF Page) is received. To check or change the state of the ringer, press and hold **[F/W]** for ½-second, then press **[PAGE CODE]**. The large number in the center of the display indicates the length of each ring, you can select **1**, **3**, **5** or **8** (ringing tone pairs) with the selector knob or microphone buttons ("--" = no ringing).

The memory box also shows either **P** (for DTMF pager), **B** (for CTCSS Bell), or **L** (for user-programmed melody; described later), indicating to which response mode the displayed ringer length setting applies. Press **[MHZ PRI]** to display and allow changing the other mode's ringer setting.

The right of the display also shows either **INT** (for initialized melody), or **USE** (for user-melody), indicating which Ringer Alerting Tone will be played. You can press **[D/MR]** to toggle between initialized and user-melody selection (if the user-melody has already been programmed).

A letter **S** displayed just above the VOL control indicates the melody will play a single time when a call is received, otherwise the ringer will sound initially, and every minute thereafter until reset by the PTT, or corresponding tone button. Press **[F/W]** to toggle between single and continuous ringing.



Ringer Attributes Display

DTMF Paging System (with the FRC-6 Option)

The FRC-6 option includes a DTMF tone encoder/decoder and a dedicated microprocessor providing paging and selective calling features under DTMF control.

The DTMF paging system performs two basic functions; it turns a busy channel full of chatter into a quiet one, and lets you call specific stations, and receive calls only from stations you wish to talk with. All of this is made possible by the use of 3-digit codes known only to you and your friends or group members.

If your friends or club members monitor a particular calling frequency or repeater to chat on, this feature is useful to quiet the radio except for calls specifically to you. By planning a 3-digit paging code system among your friends/group, you can contact a single member, or call all group members at the same time.

Any DTMF-equipped station can call you, whether they use their transceiver's built-in paging feature or generate the paging code using a DTMF microphone. In either case, the paging code sequence requires seven digits, in a

DTMF Paging Code Sequence

ID code of station or group to be called			* - key	Your ID Code		
1st digit	2nd digit	3rd digit	*	1st digit	2nd digit	3rd digit

In the DTMF Paging mode, the FT-2500M automatically generates this sequence when you press the PTT.

The DTMF Paging System is similar to CTCSS Bell Paging in its alerting function, *except* that using DTMF control, you have 999 3-digit code possibilities instead of 38 CTCSS tone choices!

There are eight DTMF Code Memories labeled **0** - **7**. Although their number is displayed in the shaded memory box when selected, they are completely separate from the memories used to store channel data. You can also give each Code Memory an *alphanumeric name* (up to 4 characters, explained later), which can be displayed in place of the 3-digit code to help you remember the user (review *Naming Memories* on pages 19 & 20).

Basically, you can store any 3-digit number you want in these Code Memories *with one exception*:

- Code Memory 0 - read-only, used for displaying the ID Code of the calling station

Also, note that Code Memory 1 has a special function—it is reserved for *your* personal ID code, and is “always enabled” for paging.

Before using DTMF Paging, you must first program Code Memories 1 - 7 with the 3-digit codes you will use the most. The table below is an example of how you might want to arrange your Code Memories.

Code Mem #	ID Code	A/N Name	User
0	—	n/a	read-only, ID Code of last station calling you
1	445	PEPS	store your personal ID Code here
2	373	CLUB	Amateur Club Group Code
3	566	RPTR	Club Repeater Group Code
4	312	ENTL	Repeater Control Op. ID Code
5	384	HOME	Home
6	099	TOM	Tom
7	618	BILL	Bill

DTMF Code Memories (example)

DTMF Code Squelch System (with FRC-6 Option)

Like DTMF Paging, the Code Squelch mode also uses a 3-digit DTMF sequence, sent automatically by the FT-2500M at the start of every transmission. Your receiver normally remains silent to all signals that are not prefixed by your selected 3-digit code. After you receive the tones, your squelch opens and stays open during their transmission. While both CTCSS and DTMF Code Squelch permit quiet monitoring of an otherwise busy channel, DTMF control gives you a greater degree of privacy (999 code combinations versus 39 CTCSS tone choices).

Before operating in Code Squelch mode, both you and the station you want to contact must first agree upon a 3-digit code to use.

The following section will explain how to store and then manually select the one Code Memory holding the 3-digit DTMF code that you and the other station will use to open the squelch of both stations.

As with the paging modes, *any DTMF-equipped station can call you* (they can use a DTMF keypad to send the three digits if you are in code squelch mode, or six digits in paging mode).

Storing Code Memories

As mentioned above, the first thing to do before using paging or code squelch systems is to store your Personal ID Code in Code Memory 1.

- Activate the DTMF Code Memory display by pressing **[F/W]** → **[PAGE CODE]**. The current Code Memory number appears blinking in the shaded memory box, and the frequency display is replaced by the corresponding 3-digit DTMF Code (**[000]**, if not used before).



- Turn the selector knob to select Code Memory 1, then press either **[MHz PRI]** or the mic. UP button. The Code Memory number will stop blinking, and the first digit of the 3-digit DTMF Code will start blinking.
- Turn the selector knob to select a number (DTMF Digit) between **[1]** and **[9]**, corresponding to the first number of the personal ID code you have chosen for your station.
- Press **[MHz PRI]** or the microphone UP button again to cause the next digit to the right to blink, and

again turn the selector knob to select the next digit of your ID code.

- Repeat the above step to set the last digit.

At this point, if you want to go back and change one of the three code digits, you can press the DWN button on the microphone.

Your ID code is now stored in Code Memory 1. You can press **[PAGE CODE]** to return to the frequency display now, or continue storing other code memories in the same way: press **[MHz PRI]** or the microphone UP/DWN buttons again to get the Code Memory number in the memory box blinking, turn the selector knob, and repeat the above steps.

After filling your Code Memories, you will need to consider two additional features before beginning operation, as described next.

Enabling Code Memories for Paging

With DTMF Paging enabled, your transceiver will only alert you when the three digit stored in Code Memory 1 (your personal code) are received. However, if you want to be alerted when other paging codes (stored in Code Memories 2 - 7) are received, additional Code Memories can also be enabled. By doing this you can set your



Note!

The underbar in the shaded box beneath the Code Memories is displayed *permanently on Code Memory 1, since this is your ID* (that you will always want to receive when paging is activated). Also, the underbar never appears on Code Memory 0, since this is reserved to display the ID of incoming paging calls.

FT-2500M to only alert you when a call is received for you or your club group, for example.

- To enable specific Code Memories for operation, first enter the Code Memory setting mode as before (press **[F/W]** → **[PAGE CODE]**).
- Next, select a Code Memory you want to enable and press the **[F/W]** button to toggle DTMF paging capability on and off. When the Code Memory is enabled, an underbar ("_") appears beneath the memory box.

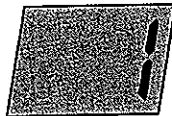

Naming Paging Code Memories

Code Memories 1 - 7 can also be named like channel memo-

ries, using the same 51-character alphanumeric set. This can instantly let you know who you are calling, instead of having to memorize codes or keep a list handy.

- To enter an alphanumeric label, simply select the desired Code Memory (**[F/W]** → **[PAGE CODE]**), then press **[A/N STEP]**. If there was no name entered for the selected Code Memory before, the 3-digit code will disappear.
- Next, press **[MHZ PRI]** so that the blinking **u** appears in the first digit's place, then use the same procedure as described in *Naming Memories* (page 19) to label the desired Code Memories (knob → **[MHZ PRI]** → knob → **[MHZ PRI]**).
- After naming your Code Memories, you can select which ones will be displayed by their name, by pressing **[A/N STEP]** to toggle between name/number display.
- When finished, press **[PAGE CODE]** to return to the operating display.

The DTMF paging and code squelch systems are selected by the **[PAGE CODE]** button. Either **PAGE**, **PAGE** & **▼** or **CODE** appears at the top of the display when DTMF paging trigger paging or code squelch is activated, respectively.

DTMF Code Squelch Operation

When you are ready for operation, select the desired Code Memory, then, from the operating display, press  until **CODE** appears at the upper right.





When using DTMF Code Squelch (**CODE** displayed), your squelch will open when you receive the correct 3-digit DTMF ID code (matching that in the currently-selected DTMF Code). Likewise, each time you press the PTT, the same 3-digit DTMF code is automatically sent to open the other station's DTMF Code Squelch.

A few things to remember when using DTMF Code Squelch:

- You can only receive a call on the *currently-selected* Code Memory (DTMF Paging, however, offers several).
- The display does not change, nor does any ringer or melody alert you.
- Code Memories 1 ~ 7 *always function the same* — the special functions described earlier for Code Memory 1 (personal ID-always on) and enabling paging Code Memories *do not apply*.
- Wait a second or two after pressing the PTT each time for the DTMF code to be sent and his squelch to open before you start speaking.

DTMF Paging Code Delay

When calling other stations with DTMF paging or code squelch, particularly through repeaters, you may find some are unable to receive your calls. This can be caused by their receiver squelch not opening fast enough (after receiving your carrier) to allow all of the DTMF codes to be received and decoded. To correct this problem, you can set a longer delay between the time your transmitter is activated and the time that the first DTMF digit is transmitted.

Press  →  if necessary, to activate the DTMF Code setting display (the number in the memory box blinks). Then select any Code Memory except 0, then press  to toggle the DTMF Code delay between 450 and 750 ms (a  or  appears in the shaded memory box indicating the selected delay).

As with the auto-transpond feature, the DTMF Code Delay selection applies to all Paging Codes.

DTMF Paging Operation

When you are ready to use the DTMF Paging function, select the desired Code Memory, then, from the operating display, press  until **PAGE** appears at the top right.

When a paging call is received, the DTMF digit sequence is decoded, and if the first three digits match those stored in Code Memories 1, or 2 ~ 7 (if turned on — see *Enabling Code Memories for Paging*, page 31), the transceiver responds:

- the **PAGE** indicator blinks for 3 secs.
- the ringer melody plays (the melody, duration and play repetition can be customized, and is explained in detail later. See page 36).
- the panel display will change according to which Code Memory matches received ID code.

If the other station was paging you personally (ID code matches that in Code Memory 1), the display shows **P** with the ID code of the calling station to the right, as below.



Personal Page Call display (Code Memory 1)

If the ID code matches that in another enabled Code Memory, the display shows the Code Memory label ($\overline{[2]} - \overline{[7]}$) and the 3-digits stored there. If you gave the Code Memory an alphanumeric name and selected it for display, the name will appear instead of the 3-digit code.



Page Call display (Code Memories 2-7)

In this case you will know who was being called from the display, however, *to see the ID code of the calling station, you must select and view the contents of Code Memory 0, which is reserved for this purpose.*



A few important points to remember about DTMF Paging operation are:

- The currently selected Code Memory determines what station you are paging when you press the PTT. After receiving a call, Code Memory 0 is automatically selected for you.
- If you want to call someone else, you will have to manually recall the Code Memory holding their ID code again.

In either of the above examples, you can press your PTT switch afterwards to call back the paging station by sending your ID Code, and to reset the transceiver for the next page call.

If you then want to talk with the other station, you will both have to turn the paging function off (press  until **PAGE** disappears), or switch to Code Squelch operation. Otherwise, both of your transceivers will continue ringing each time you transmit (this can be avoided by using the Trigger Pager feature, on the next page).

To switch to Code Squelch, both of you must have the same 3-digit code selected, so one of you has to change your Code Memory selection (since *both* transceivers are now set to Code Memory 0, with each other's ID displayed). If you select Code Memory 1, it will match his Code Memory 0, and all he will have to do is switch from paging to code squelch mode.

- To do this, after you have exchanged initial paging calls, press  until only **CODE** appears at the top, then  →  to bring up the code setting display.
- Next turn the selector knob to display a blinking **!** in the memory box. If, while you were doing this, he just changed from paging to

Paging Error Display

If your transceiver rings after receiving a DTMF Paging call, but the display shows **ERR**, this indicates there was a problem decoding the DTMF digit string. This can be caused by the signal dropping out suddenly, or if the other station was sending the DTMF digits manually, and sent them too slowly (there is a time limit for digit spacing). If you have difficulty paging stations while working through a repeater, see the box on page 33 (DTMF Paging Code Delay).

code squelch mode, you should now be able to communicate without the ringing.

When you finish your conversation, to reactivate DTMF Code Paging, press  twice so that **PAGE** is again displayed.

If you would like to initiate a paging call, simply select the correct Code Memory for the station you want to call, turn on the paging mode (**PAGE** displayed), and press the PTT.

Trigger Pager

When used with other transceivers having this feature, you can talk to stations immediately after they have paged you, without having to manually change to Code Squelch operation.

- To activate this function, press **PAGE CODE** until **PAGE**, along with the small  icon appears.

Your transceiver's display indications are the same as before when a page call is received, however, to respond simply press the PTT and begin talking with 3 seconds after the DTMF sequence has been sent. If the other station also has their transceiver set for Trigger Pager operation, you can both continue communications as normal, however, if the 3-second limit after PTT-release expires, the paging mode will reset to receive a new call.

Special Paging Functions

The way your transceiver responds after receiving paging calls can be customized using two special features: *Pager Tele-Forwarding* and *Pager Answerback*. These features provide automatic response while you are away from the radio when page call is received.

Pager Tele-Forwarding

This turns your FT-2500M into a "page relay-station." When this feature is enabled, receiving a page call with your ID Code causes the transceiver to automatically (within five seconds) re-transmit the same DTMF digit string. So if you are away from your transceiver, but still within range, your FT-2500M can forward page calls that might otherwise be missed.

To turn this function on, do the following:

- First enter the code setting mode by pressing **F/W** → **PAGE CODE**, and select any code memory except Memory 0.
- If alphanumeric display is enabled, turn it off by pressing **A/N STEP**.
- Next press **RPT** until **T** appears to the right of the 3-digit code. Toggle the **RPT** button to step through the response mode choices:
 - **A** Pager "Answerback" (covered next)
 - **T** Pager "Tele-Forwarding"
 - none (no automatic response)
- Press **A/N STEP** to restore the Code Memory name, if necessary, then press **PAGE CODE** to return to the operating display. You only need to do this once as the setting applies to all Code Memories.

Pager Answerback

This feature is similar to Pager Tele-Forwarding just described, except that the FT-2500M "answers-back" the calling station, then resets for the next call. This informs the other station that the call was received and you are in range (although you were not necessarily there to hear it). Code Memory 0 displays the calling station's ID code, so you know who called while you were away.

- First enter the code setting mode by pressing **F/W** → **PAGE CODE**, and select any code memory except Memory 0.
- If alphanumeric display is enabled, turn it off by pressing **A/N STEP**.
- Next press **RPT** until **⏏** appears to the right of the 3-digit code.
- Press **A/N STEP** to restore the Code Memory name if necessary, then press **PAGE CODE** to finish and return to the operating display.

After enabling either the Pager Automatic Forwarding or Pager Transpond feature, they automatically activate any time you enable the DTMF Paging mode. For a comparison of Pager Automatic Forwarding and Pager Transpond functions, see the box at the right.

Special Paging Functions

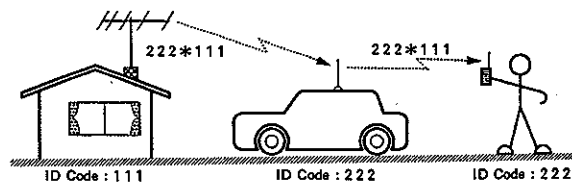

Pager Tele-Forwarding- When page calls directed to you (with your personal ID code) are received, the FT-2500M automatically "re-transmits" the page call (in its original) sequence, the resets.

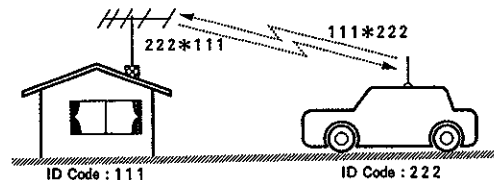

Pager Answerback- When a page call for you is received, the FT-2500M automatically "calls back" the paging station with your personal ID in the correct sequence, the resets for the next call.

Ringer Melody Settings

There are two choice of ringer melodies that he transceiver plays when a call is received in the CTCSS Bell and DTMF Paging modes. The default melody is programmed at the factory and cannot be changed, however, there is a special user-programmable memory that allows you to compose your own, and select it as the default melody, if desired.

To play back or change the default ringer melody for each mode, press and hold **[F/W]** for ½-second, then press **[PAGE CODE]**. The display will appear as shown below, at first the display combinations may appear confusing, but their indications are straightforward.



The larger number in the center of the display is the ringer repetition (how many times the melody will repeat when you are called). This can be set for 1, 3, 5, or 8 repetitions, or turned

off "--", by the selector knob or mic UP/DWN buttons. To hear what the ringer melody sounds like, press **[TONE]** for play-back.

The smaller digit to the left is the ringer sequence setting, 5 indicates *single*, and means the transceiver plays the melody once for each call received. If the space is blank, the *continuous* ringer mode is selected, and the ringer melody sequence is played initially, then continues thereafter at one minute intervals until reset by pressing the PTT. Choose which type of alert you want by toggling the **[F/W]** button.

The digit in the memory box indicates which calling mode the displayed setting is for, and can be changed by toggling the **[Mhz PRI]** button for one of the three following settings;

- [BP]** for DTMF pager ringer
- [B]** for the CTCSS Bell ringer
- [U]** (blinking) for a User-Programmed melody (covered later)

At the right, the large **[BP]** indicates the default factory-programmed melody is selected. After the User-Melody has been programmed, it can be selected by pressing the **[D/MR]** button (**[U]** appears). To compose your own ringer melody, see the next page.

Composing the User-Melody Ringer

The user-ringer melody can be programmed with a string of up to 16 digits. Each digit code corresponds to a note from the traditional music scale, and encompasses 3 octaves as shown in the table below. To insert a rest note (space) into the melody, select **7**.

	C+	D+		F+	G+	A+	
	C	D	E	F	G	A	B
2nd Octave	C ₈	D ₈	E ₈	F ₈	G ₈	A ₈	B ₈
1st Octave	C ₅	D ₅	E ₅	F ₅	G ₅	A ₅	B ₅
	C ₄	D ₄	E ₄	F ₄	G ₄	A ₄	B ₄

To compose your own melody;

- First display the ringer settings as before (press and hold **F/W** for 1/2-second, then press **PAGE CODE**), next toggle **MHZ/PRI** twice so that **11** is blinking in the memory box and "—" is displayed.

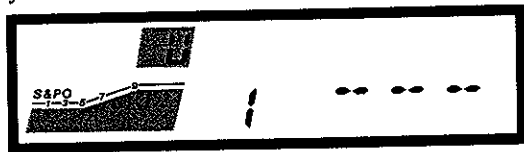

- Next press **F/W** ("—" begins flashing) and note that the smaller number to the left now indicates the serial digit place in the melody (from **1** to **16**)
- Rotate the selector knob or use the mic. UP/DWN buttons to choose first note of your melody. The selected note will appear flashing.
- With the desired note appearing on the display, press **MHZ/PRI** to save the entry and move on to the next note to be entered. Notice that the flashing "—" appears again and the serial digit counter has incremented.
- Enter a new note and repeat the above step as many times as necessary to complete your melody.
- To review each note entry simply toggle the **MHZ/PRI** button to step through each note, if you melody is less than 16 notes, the unused slots will show "—". If you made a mistake entering a particular note, simply press **RPT** when the incorrect note is displayed, then re-enter the correct one.
- To play back the melody as it will sound when you receive a call, press **TONE**. When finished, press **PAGE CODE** twice to return to frequency display.

APO (Automatic Power-Off)

The FT-2500M provides the APO system to shut off the transceiver after up to 24 hours of button or PTT inactivity. The APO feature is disabled from the factory. However, you can turn it on by pressing **[F/W]** for ½-second, followed by **[RPT]**. The display will appear as below.



- Rotate the selector knob to choose the inactivity time before power-off. You can select from 1 to 24 hours in 1-hour increments, or **[OFF]** for off.
- Press **[RPT]** after selecting the desired inactivity period to return to the channel display *and start the timer*. From this point on, if no activity is detected (pressing the panel buttons or PTT), the transceiver will turn off after the selected delay time.

Adjusting Panel Backlighting

A photosensor located just above the microphone jack monitors ambient light conditions and automatically adjusts the LCD and panel backlighting. You can watch the display respond by covering the sensor with your finger. This provides a bright, high-contrast display in daylight and a softer, subdued display at night.

To manually set the backlighting to the brightness you prefer (8 levels are available), press and hold **[F/W]** for ½-second, then press **[D/MR]**. The display will appear as below.



- Rotate the selector knob to adjust the brightness. The small digit displays the current level (1-8 and **[OFF]** for automatic).
- Press **[D/MR]** to enter the new backlighting level and return to the operating display.

In Case of Problems

Although basic operation of the FT-2500M is simple, some of the newer features may seem somewhat complicated at first. The small number of controls belies the variety of features that are available, and some buttons have more functions than are indicated by their labels. So it is not difficult to get lost, at least until you have had the chance to familiarize yourself with all of the features. This section provides some tips to help you navigate the various display and button modes.

If the display shows nothing at all, push the power switch, and check the power supply connections and the fuse in the power cable pigtail. If the fuse is blown, you will need to find out and correct the cause before replacing it. Replace the fuse only with one of the same type and capacity: 15-A, fast-blow.

The display usually tells a lot about the current state of operation. With the FRC-6 option installed, the display can take on many different states. Most of these are shown at the right, together with the button to press in each case to return to the main (operating frequency) display. You will also see a (programmable) 4-letter word



Main Frequency Display



Repeater Shift & ARS - press RPT



CTCSS Freq. & Beeper - press TONE



Step & Scan Resume - press A/N



DTMF Code Setting (option) - press PAGE

displayed in place of frequency when a named memory is displayed. Pressing **(A/N STEP)** will display the frequency. Except for the main frequency and the memory name displays, most or all of the other buttons will be disabled anyway.

It is well worthwhile to study the main frequency display diagram on page 6 carefully. This display is the basis for basic operation. For example, if the frequency display changes unexpectedly when you transmit (or if $\bar{L} r r$ appears), check for a small "+" or "-" at the top center, indicating that repeater shift is active and the resulting transmit frequency is out of range.

If the main frequency or memory name display is visible, but pressing a button appears to do nothing, first check for **LOCK** at the top left corner of the display. If you see it, press **(F/W) → (LOW LOCK)** to unlock the buttons. Otherwise, you can press **(D/MR)**, which will usually terminate any partially entered commands.

If the number in the memory box is blinking, the display is showing a DTMF Memory Code.

This occurs spontaneously when a DTMF page is received. Press **(PAGE CODE)** to return the frequency display to normal.

If you still cannot enter data, check to see if the **(TX)** indicator near the upper left of the display is on, indicating that the transceiver is transmitting. Releasing the PTT switch should return the set to receive. If still nothing happens, switch the transceiver off, and then back on.

If the display shows all segments at the same time, or shows $\bar{L} - \bar{r} r$ and you cannot turn the set off, you may have inadvertently started memory cloning - press the PTT switch (the display will change to $\bar{L} r r$, and then hit the power switch to return to normal operation.

To avoid confusion resulting from inadvertent button presses, set the keypad lock on (press **(F/W) → (LOW LOCK)**) if you leave the transceiver unattended while it is on. Remember to set the lock back off when you wish to enter data.

Memory Backup

Normally, a lithium battery inside the transceiver retains all operational settings while memories are stored in EEPROM while the power is off or disconnected. If the transceiver loses operational settings (but not channel memories), this battery should be replaced.

The front panel must be removed to gain access to the battery, which is on the inside of the front panel, just behind the memory box on the display. It should be replaced only by an Yaesu-authorized technician to ensure proper installation properly.

Memory Cloning

All memory data stored in one transceiver can be moved to another by connecting the microphone jacks together with the optional cloning cable, available from your Yaesu dealer. To order this cable, specify Yaesu Part No. T9101418.

- Turn both transceivers off, and connect the mic jacks together. Press and hold the **[F/W]** buttons while turning the power switches on. All segments of the displays will be blinking.
- Press **[REV SKIP]** on the destination transceiver (the display will show **[- - -]** in place of frequency).
- Press **[RPT]** on the source transceiver. The display will show **[- - -]** while the data is being transferred, and should then return to normal. If **[- - -]** appears on the destination display, turn both transceivers off and try again. If the display of the destination transceiver remains all blank or all on, and you cannot turn the transceiver off, press the PTT switch (the display will change to **[- - -]**), and then hit the power switch to return to normal operation. Recheck your cable, and then try again.
- Turn both transceivers off and remove the cloning cable.

Packet Radio Interconnections

For packet radio operation with the FT-2500M, you need to connect your TNC to the front panel microphone jack. You can make a connection cable with an 8-pin modular telephone-style (RJ-45) plug. Check with your local electronics hardware store for selection of the proper connector and tools. If you do not wish to construct one, Yaesu offers a 1-meter long cable with an assembled modular plug at one end for TNC interconnection. Contact your Yaesu Dealer for price and ordering information (part no. T9101428).

Use high quality shielded audio or microphone cable of the shortest possible length to construct the patch cord. We do not recommend modifying regular telephone line cables for this purpose; while they do have a pre-assembled plug, most do not have braided shielding, and may experience problems when exposed to the RF environment in the shack.

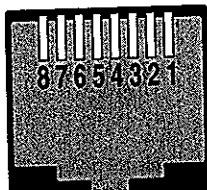

1. Call Button
2. Rx Audio
3. PTT Button
4. Mic Tx Audio
5. Ground
6. +5 V DC
7. Up Button

TNC	FT-2500M Mic Jack	Comment
RX AUDIO	pin 2	8 ohms, de-emphasized. Maximum level 4 -V _{rms} . (controlled by VOL knob)
PTT(TX)	pin 3	ground to transmit
TX AUDIO	pin 4	2 k-Ω, pre-emphasized. Optimum input level approx. 5 mV _{rms} .
GND	pin 5	Audio signal ground

Connecting your TNC

Different model TNCs use different labels or names to identify plugs and connections for packet interconnection. However, don't let this confuse you, as there are only 4 basic connections needed to/from your FT-2500M to interface your TNC unit.

Refer to the table above and drawing below left for microphone jack connection. Pin numbers on the drawing are referenced looking straight into the modular jack from the front.

Pin 1 - Not normally used, however, if your TNC is an earlier-style model, you may need this, See *Squelch Status Modification*, on the next page.

Pin 2 - Provides the audio fed to the TNC for decoding. This 8-ohm, de-emphasized audio

output must be adjusted to the proper level for your TNC using the VOL control. You can use the audio available at the EXT SPKR jack on the rear panel, but this disables the internal speaker. Maximum audio level is 4 V_{rms} @ 8 Ω.

Pin 3 - (PTT) Keys the transmitter when grounded.

Pin 4 - This is where you feed the audio from your TNC to be transmitted. Your TNC will usually have an output control to adjust its audio level. You can use another receiver to monitor the level, or adjust it until you have solid connects to a BBS. Optimum audio input level is 5 mV_{rms} @ 2 kΩ.

Pin 5 - Audio signal return (ground)

Note!

Performing the Squelch Status Operation at the night will disable the microphone DMR button function (in U.S.A. versions) and/or 1/750-Hz toneburst feature (in European versions) accessed using the microphone.

Squelch Status Modification

Earlier-model TNCs requiring a squelch status output (channel busy) indication, can get this via mic. jack pin 1 by shorting two jumper pads located on the Control Unit. Before performing this modification, see the notice in the box at the lower left.

- Remove the five screws attaching the top cover and remove the cover (see page 49).
- To the right of the lithium back-up battery, locate jumpers JP5 & JP6.

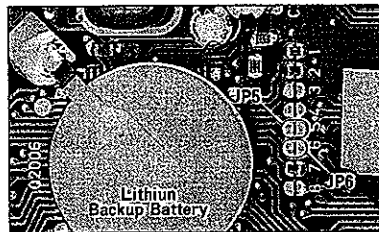

- Short the split pads of each jumper by bridging a small solder bead across them. Use a low-wattage soldering iron and do not apply heat for longer than 3 seconds.

Reassemble the transceiver, this completes the modification.

Modification for 9600-Baud Packet

Operation at high data rates requires special interfacing since the FT-2500M bandwidth and pre- and de-emphasis circuitry are not optimized for this mode of operation.

If you want to use your FT-2500M with a 9600-baud Packet TNC, the following modification should enable better performance at this higher data rate. However, throughput performance at 9600 baud is not guaranteed.

If you choose to perform this modification, you will need a low-wattage soldering iron, tweezers and the following components:

- (2 pcs.) 0- Ω chip resistors* (see the box on the next page concerning TNC audio).
- (1 pc.) 10-k Ω chip resistor (you may have to experiment with the value of this resistor until the audio input level in optimum).
- (2 pcs.) 5-cm-long insulated wire leads (#22 AWG)
- (2 pcs.) 1- μ F tantalum chip capacitors* (see the box on the next page concerning TNC audio).

If you are not confident at surface mount soldering, contact your Yaesu dealer for assistance.

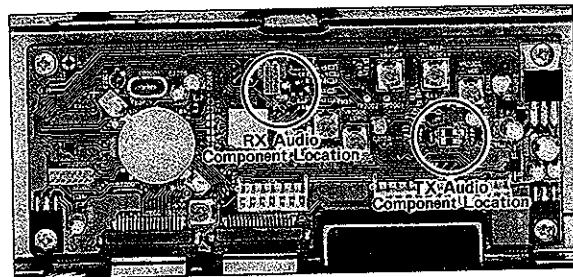

Fig. 1 Modification Component Locations

- Remove the top cover as described on page 50 to expose the CNTL Unit. Refer to Fig. 1 to familiarize yourself with the part locations.
- Locate the unused pad beneath connector J2004, labeled **C** (Fig. 2). Install a 0- Ω chip resistor* across at this location, and a wire to the pad just to the left labeled **DISC**. This makes the connection for de-emphasized discriminator audio output for decoding.

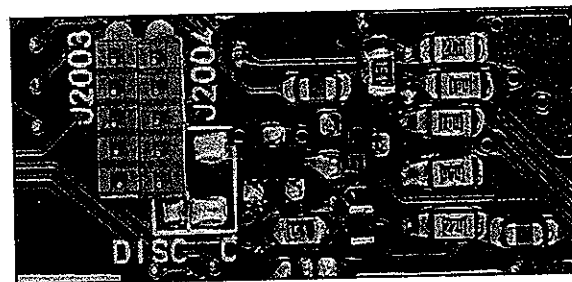

Fig. 2 RX Audio Component Location

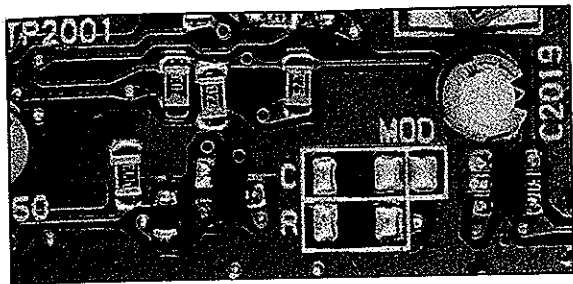
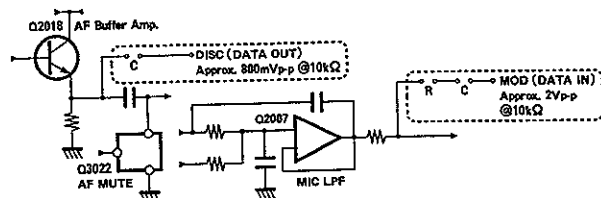

Fig. 3 TX Audio Component Location

- ❑ Next locate the set of pads labeled **MOD (C & R)**, above connector J2008 (fig. 3). Solder a 10-k Ω chip resistor across pad **R**, and a 0- Ω chip resistor* across pad **C**, and a wire lead to the adjacent pad. This is where pre-emphasized audio is fed to the transmitter.
- ❑ Note the small cut-out in the left rear corner of the chassis. Run the DATA IN/OUT leads from your TNC through this cut-out and solder them to the appropriate leads on the CNTL Unit. Use heat-shrink tubing if available to insulate spliced connections from the transceiver chassis and PCB.
- ❑ After checking all connections for integrity, replace the top cover and tighten all screws. This completes the modification.



TNC DATA IN/OUT Lead Connection

While this modification should work with most units, experimentation with audio input and output level may be necessary before optimum performance is obtained. At 9600 baud, transmitter deviation and receiver bandwidth approach design limit specifications.

Note!

If your TNC does not have a coupling capacitor in-line for transceiver audio connections, you will need to substitute 1- μ F tantalum chip capacitors in place of the 0- Ω chip resistors. Refer to the TNC documentation to determine correct placement for proper polarity.

Internal Adjustments

Inside the top cover are several adjustments that you may wish to make to match the transceiver to your operating requirements (the top cover can be removed as described on the next page). You can adjust the volume of the button beeper (relative to the front panel VOL control) by the **BEEP** trimmer, and medium and low power output levels by the **MID** and **LOW** trimmers if you have a VHF wattmeter. See the *Caution* box at the right.

Caution!

The other trimmers inside the front panel should not be adjusted without the proper test equipment. Doing so could degrade performance, or even damage the transceiver, and will void your warranty. Ask your Yaesu dealer for help if you need any other adjustments made.

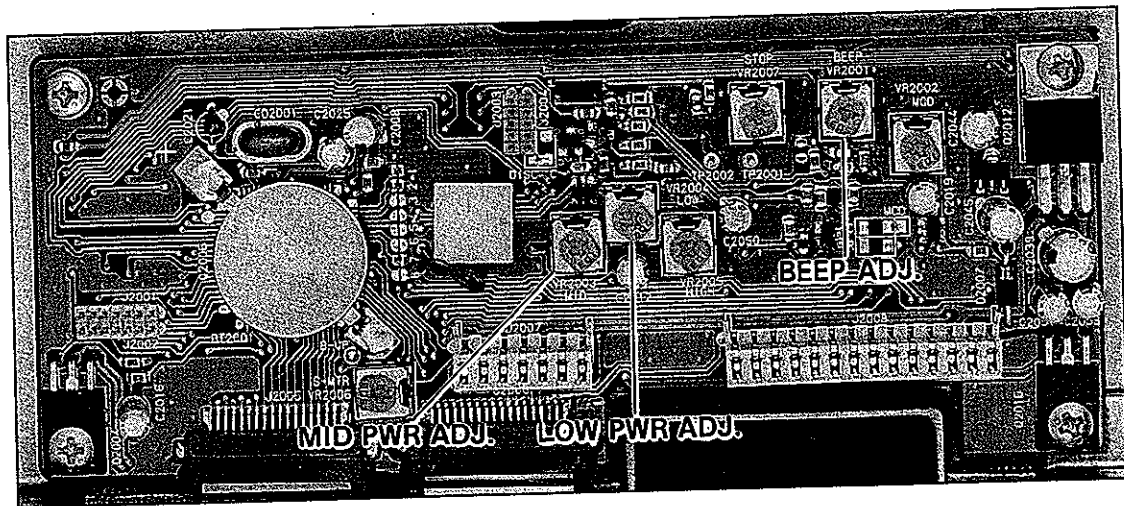

FT-2500M Internal Adjustment Locations

Installation of Options

This section describes the installation procedures for the FRC-6 DTMF Pager and FTS-17A CTCSS Unit. These options are available from your Yaesu dealer.

The FRC-6 provides DTMF paging/selcall features using 3-digit DTMF station ID codes. Seven code memories store your ID code plus those of six frequently-called stations or groups. Control is provided through the front panel of the transceiver. See the *Operation* chapter for operational details.

The FTS-17A includes a decoder for 39 subaudible CTCSS tones, programmable from the front panel of the FT-2500M. It provides silent monitoring of busy channels when activated by the ENCode/DECode Tone Squelch function.

- ❑ Disconnect the DC power cable, and referring to Figure 1 on the next page, remove the four screws affixing the top cover (two on either side), and *loosen* the one on top from the back by several turns. Lift the rear edge of the cover slightly, then remove it.

Note!

At the rear left corner of the CNFL Unit compartment is a plastic plug that seals a small cable entrance cut-out in the chassis; ensure it is in place when replacing the cover.

- ❑ Referring to Figure 2, note the accessory mounting locations. If installing the FTS-17A, remove the paper from the double-sided adhesive pad.
- ❑ Carefully align the pins with the white connectors on the board, and press the unit(s) into place. The FTS-17A goes over the smaller connector, and the FRC-6 over the larger one.
- ❑ The factory adjusts the output tone levels (the small trimmers accessible through the option boards) for the proper deviation, so they should require no further adjustment.
- ❑ Replace the top cover and four screws removed in the first step, and remember to tighten the screw at the back of the top panel from the rear.

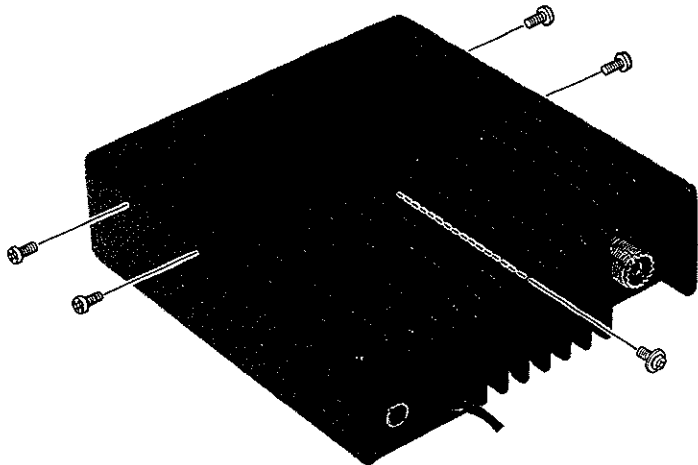

Figure 1.

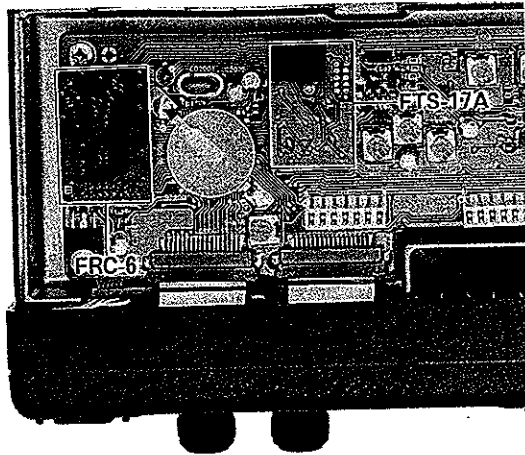
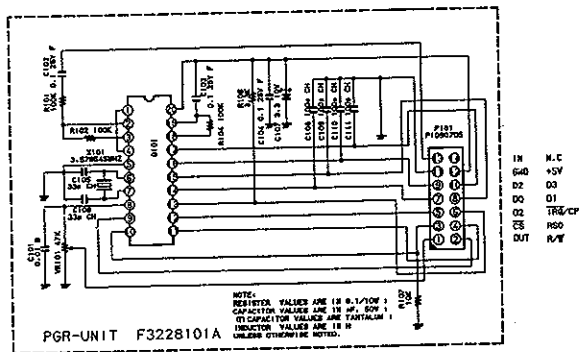
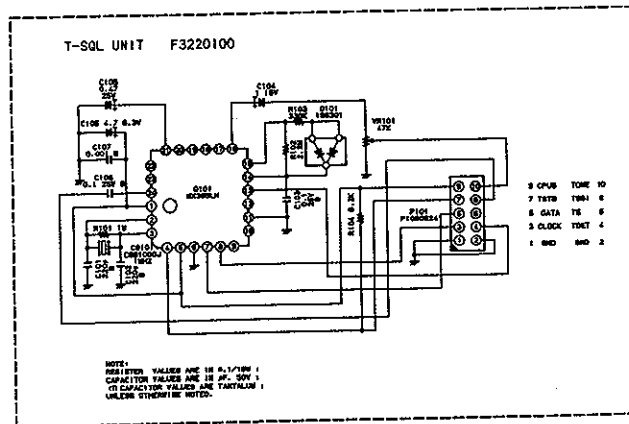

Figure 2.



FRC-6 Circuit Diagram



FTS-17A Circuit Diagram

FT-2500M Operator's Quick Reference Chart

Button	Normal Function	Alternate Function (after pressing F/W)	DTMF Code Setting Function (while 3-digit Code Memory is displayed)
POWER	Hold this button momentarily (>1/2 sec.) to turn set on/off	Same as Normal Function.	Same as Normal Function.
D/MR	Toggle Dial/Memory operation	Cancel alternate functions of other keys (automatic after 5 seconds)	Toggle 450/750 msec delay after PTT before DTMF Code is sent
F/W	Press momentary to enable alternate functions of other keys. Hold 1/2 sec. to select memory for storage, and press again to store.	Cancel alternate functions of other keys (automatic after 5 seconds)	On Code Memories 2-7, enables Memory to be decoded for paging (underline appears under memory box if selected memory enabled).
REV SKIP	With repeater offset selected, toggles reversed Tx/Rx frequencies. Direction sign (-+) blinks while reversed.	During memory operation, toggles scan skip of selected memory. No function when using the Dial.	none
MHZ PRI	Toggles 1-MHz tuning steps during dial operation. In Memory Mode, enables memory tuning.	Toggle Priority Monitoring.	Select next digit to right (turn selector knob to change blinking digit).
LOW LOCK	Toggle High/Medium/Low Transmit Power	Enable/Disable Button Lock	none
RPT	Toggles Repeater Shift direction (-/+ / off-simplex).	Display repeater shift offset and ARS state (P in memory box if enabled, F/W to change) RPT alone to end display.	Toggle Page Auto-Forward, Page Transpond Modes.

* only with optional FRC-6 DTMF Pager Unit installed.

** only with optional FTS-17A CTCSS Unit installed.

FT-2500M Operator's Quick Reference Chart (continued)

Button	Normal Function	Alternate Function (after pressing F/W)	DTMF Code Setting Function (while a digit is being entered is displayed)
Ⓣ	Toggle CTCSS Mode: ENC ode/ DEC ode**/Off.	Display CTCSS tone freq. and "b" if key/button beeper enabled (press F/W to change). Press Ⓣ alone to finish and end display.	none
Ⓟ	Toggle DTMF* PAGE / CODE -Squelch/Off.	Display DTMF Code Setting. Use selector knob to choose the desired Code Memory. Press Ⓟ alone to finish and end display.	Cancel DTMF Code Setting Mode.
Ⓚ	Toggle CALL Channel.	Toggle CTCSS Bell**.	none
Ⓜ	Memory mode only: Toggle memory name/frequency display. To change memory name, store first, then hold F/W 1/2 sec, and press this button.	Display channel steps and scan resume mode. Press F/W to change scan resume mode. Press Ⓜ alone to finish and end display	Store DTMF name

Setting Functions (after pressing **F/W** > 1/2 sec)

F/W (> 1/2 sec) → D/MR	Panel Backlighting Dimmer Set
F/W (> 1/2 sec) → MHZ PRI	Time-Out Timer Set
F/W (> 1/2 sec) → RPT	Auto Power-Off Set
F/W (> 1/2 sec) → PAGE CODE	Set Paging Ringer Alert Melody Attributes
[D/MR + REV SKIP] → POWER	General Memory Reset, clears all information stored in channel memories

* only with optional FRC-6 DTMF Pager Unit installed.

** only with optional FTS-17A CTCSS Unit installed.

YAESU

Performance without compromise.SM

YAESU MUSEN CO., LTD.

C.P.O. Box 1500, Tokyo, Japan

YAESU U.S.A.

17210 Edwards Rd., Cerritos, California 90703

U.S.A.

YAESU EUROPE B.V.

Snipweg 3. 1118DN Schiphol, The Netherlands

YAESU UK LTD.

Unit 2, Maple Grove Business Centre

Lawrence Rd., Hounslow, Middlesex TW4 6DR, UK

Copyright 1994

Yaesu Musen Co., Ltd.

All rights reserved.

No portion of this manual
may be reproduced without
the permission of
Yaesu Musen Co., Ltd.