

FT-2200

*Transceptor Móvil
2-mts., 50-Watt*

*Mobile Transceiver
2-m, 50 Watt*

*Manual De
Instrucciones*

*Instruction
Manual*



Table of Contents

Features	1	CTCSS "Bell" Paging w/FTS-27	26
Specifications	2	DTMF Paging & Code Squelch	27
Controls & Connectors	3	Storing Code Memories	29
Installation	7	Page Code Inhibit	30
Base Station Installation	9	Paging & Code Squelch Operation	31
Accessories	10	Special Paging Functions	33
Operation	11	DTMF Auto-Dial Memories	35
Preliminary Setup	11	Ringer Settings	36
Frequency Selection Modes	13	Composing your own Ringer Alert Melody	36
Channel Step Selection	14	Memory-Only Mode	37
Transmitting	15	Digital Voice System Operation w/DVS-3 Option	39
Time-Out Timer	15	Voice System Display	39
Repeater Splits	16	Segmentation Code Selection Notes	41
Automatic Repeater Shift	17	On-the-air Recording & Playback	43
Simple Memory Storage & Recall	18	DVS-3 Remote Operation	43
Odd-Split Memories	19	In Case of Problems	47
CALL Channel Memory	19	Resetting the CPU & Memory Backup	48
Separate Tx Frequency Memories	20	Packet Radio TNC Interconnections	48
Memory Tuning	20	CAT System Computer Control	49
Masking Memories	21	CAT Programming Instructions	50
Scanning	21	Installation of Options	52
Programmable Memory Scanning & Tuning	22	DVS-3	52
Priority Channel Monitoring	24	FTS-27	54
CTCSS Operation	25	FT-2200 Quick Reference Guide	55

The Yaesu FT-2200 is a compact, full-featured radio providing selectable power output of 5, 25 or 50-Watts, and includes many convenient operating functions.

Forty nine tunable memories offer flexible programming and scanning functions, such as odd-split Tx/Rx frequencies, programmable repeater offset and scan limits, selectable scan resume modes and memory skip, priority channel monitoring and instant-recall CALL channel. Channel steps are user-selectable from 5 to 50 kHz, and ARS (Automatic Repeater Shift) can be activated to automatically set standard repeater shifts when tuning to repeater subbands. Backlighting for the large LCD (display), knobs and major buttons is controlled using a photo-sensor to automatically adjust to ambient light conditions.

A 38-tone programmable CTCSS encoder is built-in, and the FTS-27 CTCSS decoder unit can be installed to provide squelched private channels and a CTCSS Bell feature to sound an alert tone when the tone squelch opens.

DTMF (Dual-Tone, Multi-Frequency)-based selective calling and private paging lets you select any of 999 3-digit ID codes for your transceiver

and then have your receiver stay quiet until your code is received (from any standard DTMF-equipped transceiver). When a call is received, the FT-2200 displays the caller's code, and a paging beeper can be set to sound. With the Auto-Page/Forward features, your FT-2200 can respond automatically by acknowledging or relaying a page call received when you are not present. Seven DTMF code memories store your ID plus those of six other frequently-called stations or groups you wish to monitor. In addition, 10 DTMF Auto-dial memories store up to 15 digits each for quick playback of commonly used numbers.

The optional DVS-3 permits digital voice recording and playback in the FT-2200. For remote operation, the optional MW-2 Wireless remote-control unit duplicates most front-panel controls (including volume and squelch), adding a DTMF keypad and microphone. A tiny panel plugs into the microphone jack of the radio to receive commands from the unit. The microphone jack also includes signal for CAT System control from an external personal computer.

Please read this manual carefully to familiarize yourself with the FT-2200 features.

General

Frequency Range: See Version Chart Below

Channel Steps: 5, 10, 12.5, 15, 20, 25 & 50 kHz

Frequency Stability: $< \pm 10$ ppm (-10 to $+50^{\circ}\text{C}$)

Mode of Emission: G3E

Antenna Impedance: $50\text{-}\Omega$, unbalanced

Supply voltage: $13.8\text{V DC} \pm 10\%$, negative ground

Current Consumption (typical):

Rx: 700 mA, Tx hi/med./low: 10/6/3A

Operating Temperature Range: -20 to $+60^{\circ}\text{C}$

Case Size (WHD): $140 \times 40 \times 160$ mm (w/o knobs)

Weight: approx. 1.25 kg (2.8lb)

VERSION		B1	A2	A3	B3
Range (MHz)	144-146	x			
	Rx: 140-174 Tx: 140-150		x		
	140-174			x	x
	1750 Hz Tone Burst	x			x

Transmitter

Output Power (high/med./low): 50/25/5W

Modulation Type: Variable Reactance

Maximum Deviation: ± 5 kHz

Spurious Radiation: less than -60 dB

Microphone Impedance: $2\text{k}\Omega$ electret condenser

Receiver

Circuit Type: Double Conversion Superheterodyne

IFs: 455 kHz and 17.7 MHz

Sensitivity (for 12dB SINAD): better than $0.21\mu\text{V}$

Selectivity ($-6/-60$ dB): 12/30 kHz

Image Rejection: better than 65 dB

Max. AF Output: 1.5Ω into 8Ω @5% THD

AF Output Impedance: $4\text{-}16\Omega$ ($8\text{-}\Omega$ int. spkr.)

Specifications subject to change without notice or obligation.

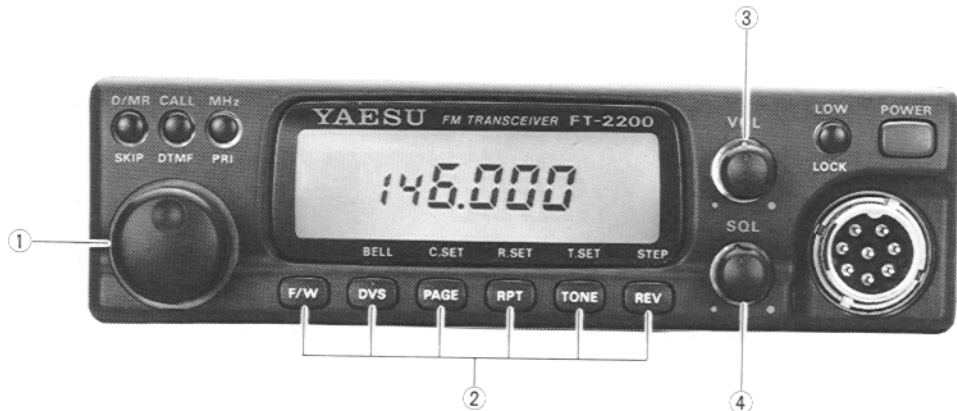

(1) DIAL

This 20-position detented rotary switch is used for tuning, memory selection and most function settings. The **DWN** and **UP** keys on the microphone duplicate the functions of this knob.

(2) Main Function Keys (with white labels)

These six keys select most of the major operating features. If the button beeper is enabled, one or more beeps will sound when a key is pressed, if the resulting command is accepted. The white labels on the keyfaces show the primary function of each key. However, if you press the **(F/W)** key first, these keys will perform alternative functions

indicated by the blue label near each key (and described in the *Operation* chapter).

(3) VOL Control

This control adjusts the volume of the receiver audio and of the button beeper.

(4) SQL Control

This control sets the threshold level at which a received signal (or noise) opens the squelch and can be heard. For maximum squelch sensitivity set this control from counterclockwise just until noise is silenced (and the "**BUSY**" indicator on the display is off) when the channel is clear.



(5) Microphone Jack

This 8-pin jack accepts transmit audio, band selection and scanning control from the microphone, and provides receiver audio (for a speaker/mic). Also, a packet TNC can be connected here.

(6) Button

Press this button to turn on the transceiver. Press it again to turn the transceiver off.

(7) Button

Toggle this button while receiving to select high/mid/low transmitter power (50/25/5 watts).

The display shows “**LOW**” when low power is selected, and “**MID**” for mid-range power output. The alternate function of this button disables the DIAL knob and most of the front panel keys and buttons, with the exception of itself,  and

 (covered later).

(8) LCD (Display)

The liquid crystal display segments are as shown on the following page. You can check them by switching the transceiver on while holding the  key.

(9)  Button

This button allows tuning in 1-MHz steps. If receiving on a memory, pressing this button the first time activates “Memory Tuning” (MT) mode, and pressing it again enables 1-MHz steps. The alternate function of this button activates priority monitoring, described in the *Operation* chapter (“P” displayed instead of the memory number above and left of the frequency).

(10)  Button

Press this button to jump to and from your CALL channel memory. The alternate function activates the DTMF auto-dial functions, described later.

(11)  Button

This button switches operation between the two main tuning modes: dial and memory. The alternate function marks the current memory to be skipped during scanning.

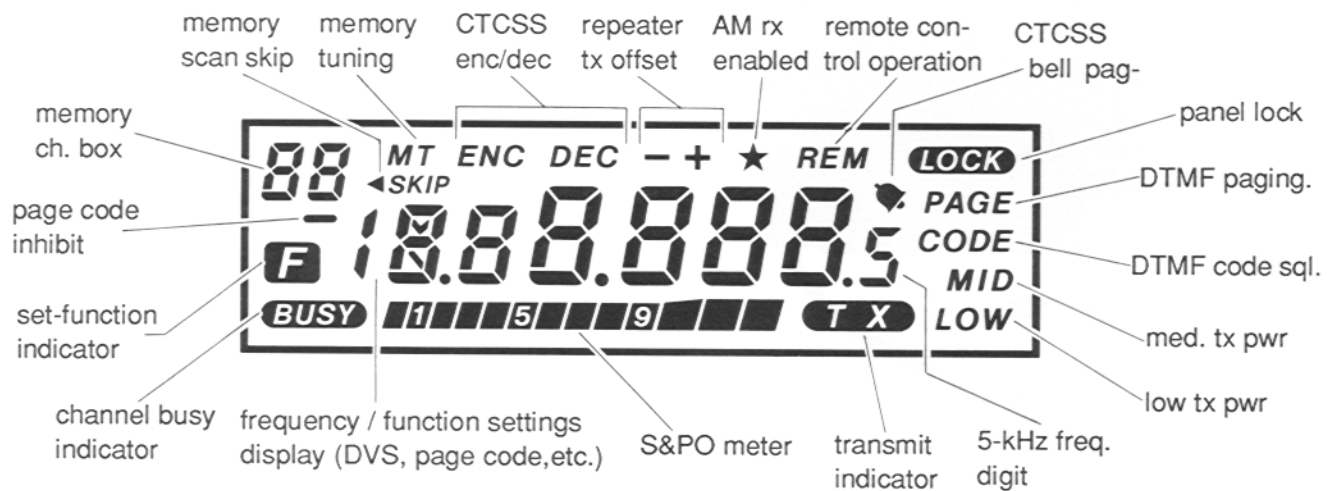

(12) 13.8V DC Cable Pigtail w/Fuse

This is the power supply connection for the transceiver. Use the supplied DC cable to connect this pigtail to the car battery or other DC power supply capable of at least 15 Amperes (continuous duty). Make certain that the RED lead connects to the POSITIVE side of the supply. The fuse is 15A, fast-blow.

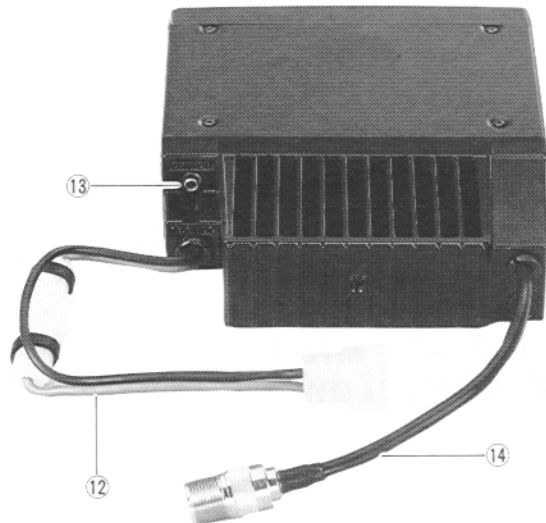
**(13) EXT SP Jack**

This 2-contact mini phone jack accepts a 4- to 16- Ω external speaker such as the Yaesu SP-3, SP-4, SP-7 or SP-55. Inserting a plug into the jacks disables the internal speaker.

(14) ANT Cable Pigtail with Coaxial Socket

Connect an antenna to this type-M socket using 50- Ω coaxial cable and a type-M plug. Make sure the antenna is designed specifically for use on the 2-meter Amateur band.

Installation

This chapter describes installation of the FT-2200 with typical supplied accessories. Installation of internal options (the DVS-3 or FTS-27 Tone Squelch Unit) should be done *before installing the transceiver* and is described in the *Installation of Options* chapter at the back of this manual.

Antenna Considerations

The FT-2200 is designed for use with antennas having an impedance near 50- Ω at all operating frequencies. For optimum performance use a high quality, carefully designed antenna. The antenna should be connected whenever power is on, to avoid damage that could otherwise result if transmission occurs accidentally without an antenna.

Ensure your antenna is designed to handle 50 Watts continuous transmitter power. For best performance and safety in mobile installations, mount the antenna in the center of a flat surface, out of reach of human hands: 50 Watts can cause an RF burn *to anyone touching the antenna during transmission!*

For best performance use the shortest possible length of thick, top-quality coaxial cable. Be sure to use a matching type-M plug for the jack on the transceiver pigtail.

Mobile Installation

The FT-2200 must only be installed in cars having a *negative ground* electrical system. Mount the transceiver where the display, controls and microphone are easily accessible, using the supplied MMB-37 mobile mounting bracket. The transceiver may be installed in any position, but should not be near a heater vent or where it could interfere with driving. Make sure to provide plenty of space at the rear so that air can flow freely through the heatsink. Refer to the diagrams on the next page for installation.

- Decide the mounting location with sufficient clearance for the transceiver, plus space for ventilation around the cooling fan and above and below the set. Use the mounting bracket as a template to locate the mounting holes. Use a 4.8-mm ($\frac{3}{16}$ "

bit to drill the holes, and secure the bracket with the supplied screws, washers and nuts (see diagram).

- Screw the two mounting clips to the sides of the transceiver using the small hex bolts and supplied washers. Position the transceiver in the bracket so that the clip on the left side fits into the slot in the left side of the bracket (figure 3), then push the right side of the transceiver upwards until it latches.
- To remove the transceiver, place your hand underneath it and pull the latch on the right side of the bracket outward until the right side of the transceiver drops free. The microphone hanger may be installed wherever convenient.

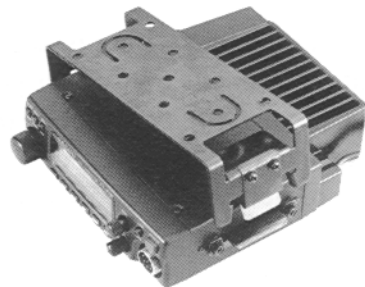
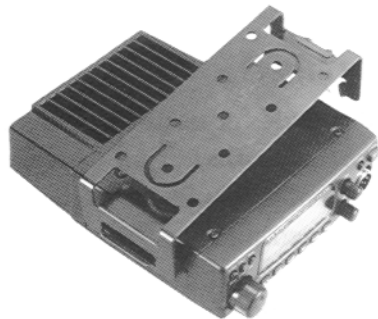
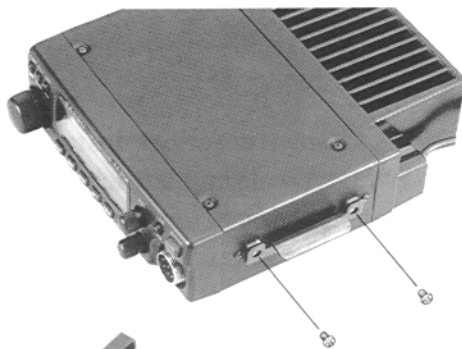
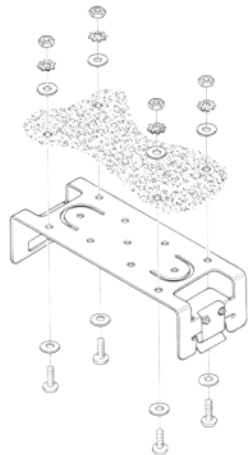

Mobile Power Connections

To minimize voltage drop and avoid blowing the car fuses, connect the supplied DC cable directly to the battery terminals. *Do not attempt to defeat or bypass the fuse — it is there to protect you and the equipment!*

Warning!

Never apply AC power to the power cable of the transceiver, nor DC voltage of greater than 15 volts. When replacing the fuse, only use a 15-Amp fast-blow type. Failure to observe these safety precautions will void the warranty.

- Before connecting the transceiver, check the voltage at the battery terminals while revving the engine. If it exceeds 15 volts, adjust the car regulator before proceeding.
- Connect the RED power cable lead to the POSITIVE (+) battery terminal, and the BLACK lead to the NEGATIVE (-) terminal. If you need to extend the power cable use #14 AWG or larger insulated, stranded copper wire. Connect the cable to the transceiver only after connecting to the battery.

Base Station Installation

Operation from the AC line requires a power supply capable of providing at least 15A continuously at 13.8 V DC. The FP-700 AC power supply/loudspeaker is available from your Yaesu dealer to meet these needs. Use the DC power cable supplied with the transceiver for making power connections, and connect the external speaker cable to either speaker jack on the rear panel.

External Speakers

The optional SP-7 External Speaker includes its own swivel-type mounting bracket, and is available from your Yaesu dealer. Of course the older SP-3, SP-4 or SP-55 External Speakers may also be used. Plugging in an external speaker disables the speaker in the transceiver.

Microphones

The MH-26D8 handie microphone for the European version FT-2200 includes a button on the front for transmitting the 1750Hz tone-burst, to access repeaters that require it. The MH-27B8 DTMF keypad microphone also includes a button

on the front, which, when used with the A2 version FT-2200, duplicates the  button on the front panel of the transceiver. Both microphone models include a **PTT** (Push-to-Talk) switch to activate the transmitter, and **UP/DWN** buttons for tuning and memory selection.

Below is a partial list of available accessories, for further details, see your nearest YAESU dealer.

<i>Accessories</i>		<i>Order Code</i>
FTS-27	CTCSS Tone Squelch Unit	A05970001
DVS-3	Digital Voice System Unit	A02950001
MW-2	Remote Control/Wireless Microphone.	A04850002
FP-700	AC Mains Power Supply	A625501-X
MH-26F8	Hand Microphone/1750 Hz Tone Burst	A04250001
MH-27B8	Hand Microphone/DTMF Keypad	A04280001
MF1A3B	Boom Microphone	D1000044
SB-10	PTT Switch Unit for MF1A3B or YH-1	D3000396
YH-1	Headset	D3000262

Other Mobile Accessories

Other options to enhance safety and mobile operating convenience are the MW-2 Wireless Remote Controller/DTMF Microphone, which duplicates the front panel controls and adds a DTMF keypad; the YH-1 Headset and the full size MF-1A3B boom microphone with flexible arm (both use the SB-10 **PTT** switch) allowing practically hands-free operation.

Operation

This chapter describes the transceiver functions in detail. After studying these descriptions, refer to the *FT-2200 Operator's Quick Reference Guide* at the end of this manual in case you need to refresh your memory.

Preliminary Setup

Before operating the transceiver, re-check power supply and antenna connections, and connect your microphone (or the module of the MW-2 Wireless Mic) to the front panel jack. Never operate the transceiver without a proper antenna, also read the earlier *Front Panel Controls* section, if you have not already, to familiarize yourself with the controls.

The next few pages describe some characteristics of the FT-2200 controls critical to its operation, and some of the terms will be used in later sections.

Operating your radio may seem a little complicated at first, however, once you become fa-

miliar with a few common keystrokes, operation will become easier and more straightforward. The functions and operating features of your transceiver can be turned on and off by pressing the appropriate front-panel function keys. Some functions come on *directly* after pressing a single button, and are indicated by white lettering on the button, or in amber print above it. Others “levels” of functions require pressing the **(F/W)** button preceding a key sequence or combination to activate them.

The *duration* the **(F/W)** key is held when initially pressed determines which function of the following button will be accessed. *Momentarily* (less than 1/2 sec.) pressing **(F/W)** and releasing it causes a single beep to sound, and the “F” indicator to the left of the frequency display to come on. This accesses the “first level” of functions printed in *blue* near each respective key. Holding the key longer will result in a second beep, after which the “F” indication will turn off and the digit contained in the memory box window will begin blink-

ing, “second level” functions are accessed in this way.

A five-second timer starts when you press **[F/W]** and automatically restarts when you turn the DIAL knob or press a microphone button. Pressing a key or front-panel button accepts the entry and shuts off the timer.

Note! To simplify describing keystrokes, “first level” function key sequences are shown by **[F/W]** ⇒ preceding the function key to be pressed, while “second level” functions are denoted using brackets “[**[F/W]**] ⇒ ” to remind you to *hold the key longer* (until the second beep sounds and display indications appear).

A key/button beeper provides useful audible feedback whenever a button is pressed, at a level determined by the volume control. Each key and button has a different beep pitch, and each function has a unique beep combination. You can disable the beeper as described in the box above, but we recommend you keep it enabled while first getting to know the controls.

If you have trouble getting the transceiver to work as described, see *In Case of Problems* on page 44.

Beeper Disabling

If you want to turn the beeper off, press **[F/W]** ⇒ **[T.SET TONE]** and **[F/W]** ⇒ **[T.SET TONE]** again. Repeating the key sequence will turn it back on again. However, we recommend leaving it on while first becoming familiar with operating your radio.

Squelch Setup

Before turning on the transceiver for the first time:

- Preset the **VOL** and **SQL** controls fully counterclockwise.
- Then press the **[POWER]** button (if the transceiver is off) and adjust the **VOL** control for comfortable volume on noise or any received signal. “**BUSY**” should be displayed in to the left of the **S&PO** meter scale.
- If you hear a signal turn the DIAL knob to a clear channel (only noise).
- Turn the **SQL** knob clockwise just to silence the noise, the “**BUSY**” indicator will disappear. Setting the **SQL** further clockwise reduces sensitivity to weak signals. Whenever a signal reaches the

receiver that is strong enough to open the squelch, “**BUSY**” will be displayed.

Note that while receiving, one or more bargraph segments may appear at the lower left corner of the display, indicating signal strength of received signals. This is not affected by the squelch setting, so even squelched signals can give some indication. If more than two bargraph segments appear while the squelch is closed, try reducing the squelch control setting (if you want to hear weak signals).

Locked Controls

If *nothing happens* when you press a button or turn the DIAL knob, the panel controls may be “locked” (you normally use this to prevent accidental changes). If “**LOCK**” is displayed in the upper-right corner of the display, press **(F/W)** ⇒  to unlock the panel controls. Later you may want to enable the lock (with the same button sequence) to prevent having your settings disturbed. Pressing buttons while locked emits musical tones, however only the unlocking sequence affects operation.

Frequency Selection Modes

Dial Mode

This mode is for tuning or scanning the band when looking for a channel on which to operate, when you don't know the specific frequency in advance. In this mode, the DIAL knob and microphone buttons each tune the band in the selected step size, or in 1-MHz steps, and the scanning function tunes in the selected step size. You also need the dial mode, at least initially, to select a frequency to be stored into a memory.

Memory Mode

This mode is mainly for operating on specific frequency channels known in advance (and programmed into the memories). For example, after storing the frequencies of your local repeaters into memory channels, you can confine operation to those channels by selecting the memory mode. While in this mode, the DIAL knob, microphone buttons and scanning function select sequentially from the stored memories. There are 49 memories (plus 5 special purpose memories) available, and also a Memory Tune mode, in which you can tune just like the dial mode, and store the resulting

retuned memory into the same or another memory. This and other special functions that apply to the memory mode are described later, but you will want to keep these terms in mind.

You can tell which channeling mode is selected by looking in the memory box at the upper left corner of the display. If the box is empty, you are in the dial mode. If you see a small number

Channel Step Selection

Tuning steps are preset to the correct size for the country the FT-2200 is exported. To change to another step size, press **F/W** ⇒ **STEP REV** and use the DIAL knob or microphone **UP/DWN** keys to select a different step.



The indication in the memory box is the *Scan Resume Mode*, and is described later. Once the desired step size is displayed, press **STEP REV** to return to the frequency display.

or an “L”, “U” or “L” in the box, the memory mode is selected.

Pressing the **D/MR SKIP** button at the top left of the radio toggles between the dial and memory modes.

Frequency & Step Selection

To select the MHz range in which to operate, momentarily press the **MHZ PRI** button to enable 1-MHz steps, and then turn the DIAL knob. Holding **MHZ PRI** longer (until the second beep sounds) enables 10-MHz steps in some transceiver versions. For fine tuning, press **MHZ PRI** again, or just wait five seconds, and then turn the selector knob. Normally the tuning step size will have been preset for your area. If not, you can change the step size as described in the box at the left.

You also can use the **UP/DWN** buttons on the microphone to select your operating frequency. However, holding one of these buttons for more than ½-second starts the scanner. This is described later, but if you’ve already started it, just press a microphone button again to stop.

Transmitting

Press the $\begin{matrix} \text{LOW} \\ \text{LOCK} \end{matrix}$ button above the microphone jack to select 3-watt output (“**LOW**” appears at the bottom right corner of the display when low power is selected). When you want to transmit, wait until the channel is clear (“**BUSY**” not displayed), and squeeze the **PTT** switch on the microphone. During transmission, “**TX**” appears above the frequency, and the S&PO bargraph shows relative transmitter power output (4 segments for low power, 8 for mid- and full-scale for high-power). Release the **PTT** switch to receive.

If you require more power, press the $\begin{matrix} \text{LOW} \\ \text{LOCK} \end{matrix}$ button again (to switch to mid- and high-power). However, we recommend using low power whenever possible to minimize possible interference, current consumption and heating.

On European versions, press the **BURST** button on the MH-26A8 mic. to transmit a 1750-Hz Burst Tone to access repeaters that require it.

Note: The “**P**” button on the MH-27A8J DTMF microphone is not used with the FT-2200.

Transmit “Time-Out Timer”

The TOT limits transmission time after the **PTT** is pressed (from 5~60 mins.), after which the transmitter automatically un-keys (even if the **PTT** is still depressed). To reset the timer and transmit again, the **PTT** must first be released. This feature is useful to limit long key-down periods when high-power output is selected, or to limit interference and protect your radio if the mic. **PTT** switch becomes inadvertently stuck in the depressed position (between the seats of your car, for example).

- Press [$\begin{matrix} \text{F/W} \end{matrix}$] \Rightarrow $\begin{matrix} \text{MHz} \\ \text{PRI} \end{matrix}$, the display will appear as below.

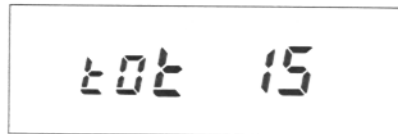

- Rotate the DIAL knob to select the timer limit (5 ~ 60 mins.) in 5-min. steps, or “**OFF**” for off, then press $\begin{matrix} \text{MHz} \\ \text{PRI} \end{matrix}$ again to save the setting, and return to the frequency display.

The TOT now starts each time you press the **PTT** and resets after it’s release. When the timer expires a beep sounds and the **TX** indicator blinks as the transmitter un-keys.

Changing Repeater Offset

Press **F/W** ⇒ **R.SET RPT** to display the current repeater offset in MHz, to three decimal places.



0.600

You can change the offset in 50-kHz steps using either the **DIAL** or microphone **UP/DWN** buttons. In most cases you will want to keep the repeater offset programmed to the most commonly used split in your area.

Also, you can enable/disable **ARS** (Automatic Repeater Shift), by pressing **F/W** at any time while the offset is displayed. An “**A**” appears in the memory box when **ARS** is enabled.

When the offset is set as desired, press **R.SET RPT** once again to return the display to the operating frequency.

Repeater Splits

The FT-2200 offers three methods to set up split frequency operation for repeaters: manual, automatic and independently stored tx/rx frequencies. Both manual and automatic methods shift the transmit frequency above or below the receive frequency by a programmable offset. This offset is preset at the factory to 600 kHz (depending on transceiver version), but can be easily changed as described in the box at the left.

Note that only *one offset at a time* can be used with the manual and automatic methods. Use the independent transmit frequency method when you want to store other offsets, such as frequencies of repeaters with non-standard splits. This is described later under *Separate Transmit Frequency Memories*.

To activate the standard shift manually, simply press **R.SET RPT** once for minus shift, again for plus shift, and again to return to simplex. A small “-” or “+” sign will appear above the frequency display.

Example: To operate through a 146.340/146.940 MHz repeater:

- Press **R.SET** (**RPT**) once. A “-” should appear at the top of the display (if not, keep pressing **R.SET** (**RPT**) until it does).
- When the channel is clear, press the **PTT** switch on the microphone and send your callsign. The display should shift to 146.340 MHz while you transmit.

Of course this example only works if the offset is set to 600 kHz, as supplied from the factory. If it is not, you can change it as described in the “*Changing Repeater Offset*” box.

With repeater split activated, you can temporarily reverse the transmit and receive frequencies by pressing the **STEP** (**REV**) key. Use this to display the transmit frequency without transmitting, and to

check the strength of signals on a repeater input frequency. The repeater shift sign blinks while reverse split is selected. Press **STEP** (**REV**) again to return to the normal shift direction.

ARS (Automatic Repeater Shift)

The ARS (Automatic Repeater Shift) feature in the FT-2200 activates repeater offset automatically whenever you tune to a standard repeater subband. With this feature enabled, a small “-” or “+” at the bottom left indicates that repeater shift is active, and closing the **PTT** switch changes to the (shifted) transmit frequency.

The ARS function is *disabled* at the factory. See the box on the previous page (*Changing Repeater Offset*) to enable it.

Automatic Repeater Shift - Repeater Subbands

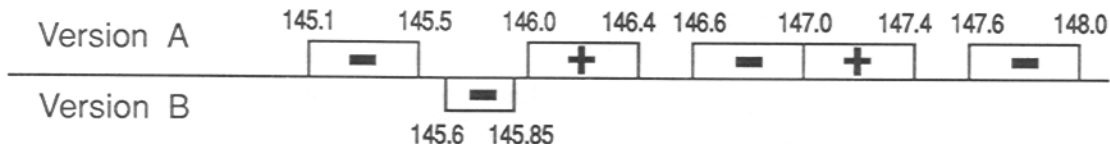



As already mentioned, you can use the manual shift method ( key) at any time to select a new shift state, whether ARS is activated or not. However, if you change frequency with ARS activated, manual repeater shift selections are canceled.

Simple Memory Storage & Recall

The FT-2200 offers 53 memories, labelled 1~49, L1, U1, L2 and U2. Each can store separate receive and transmit frequencies or repeater shift, and CTCSS tone data. Memory 1 (the CALL channel memory) can be recalled instantly by the  button, and memories L1 & L2 and U1 & U2 store programmable subband limits, described later, in addition to general purpose operation.



To store a frequency in memory:

- Select the desired frequency (and repeater split manually, if desired) in the dial mode as already described.
- Press [], a memory number or letter appears blinking in the memory box for the selected band.
- Within five seconds of pressing , use the DIAL knob or microphone **UP/DWN** keys to select the desired memory for storage. If you select

one that was already being used, it will be overwritten with new data in the next step.

- Press  momentarily to store the displayed data into the selected memory. The memory label will stop blinking for a second, and then disappear as operation continues in the dial mode.

Example: Store the 146.340/146.940 repeater data in memory 5.

- First perform the steps in the example on page 16~17 to set up the desired frequency and offset on the dial.
- Press [] to display the memory label in the memory box at the left, then do the next step within 5 seconds.
- Turn the DIAL knob, if necessary, so that “5” (the memory number to store) shows in the memory box.
- Press  again, momentarily. That’s it. The frequency has been stored in memory 5, and you are left operating on the dial.

To confirm that this worked, turn the DIAL knob to change the frequency (to anything), then press  to change from dial to memory mode. The numeral “5” should appear in the memory

box, and “146.340” (the receive frequency) should appear on the display. Press STEP REV to confirm the transmit frequency of 146.340 MHz.

You can use any memory (except “ L ”, the CALL channel) with the same result. Memory C requires a slightly different procedure. Notice that pressing D/MR SKIP from the dial mode always recalls the last stored or used memory.

Recalling Memories

In confirming the results of the last example, we used the D/MR SKIP button to change from the dial mode to the memories after they were stored. The memory label appears in the memory box at the upper left corner of the frequency display whenever operating on a memory.

When more than one memory has been stored, you can select a memory for operation with either the DIAL knob or the microphone **UP/DWN** buttons. If you use the microphone buttons, press and release the button for each memory: if you hold the button down for ½-second, memory scanning will start.



Odd-Split Memories

After storing a frequency, with or without repeater shift, from the dial, you can modify the repeater shift and offset of that memory only. Just recall the memory, press R.SET RPT as necessary to set the shift direction, and then follow the steps in the “Changing Repeater Offset” box on page 16. If you want to make the new offset permanent for that memory, remember to press F/W (for ½ second, until the second beep sounds) and then press it again momentarily. Of course you could also store a separate transmit frequency in the memory (described later) to obtain the same result, but you may find this more straightforward when dealing with repeaters.

Call Channel Memory

Although invisible to the memory recall methods just described, the CALL channel memory can be instantly toggled by pressing the CALL DTMF button, “ L ” appears in the corresponding memory box. The factory default for the CALL channel memory is the bottom edge of the band. You can reprogram it from the dial with any frequency and repeater state, or even a separate transmit frequency. After

storing the frequency, you can also set and change repeater settings, just by recalling it before following those procedures.

To store the current frequency/repeater state in the CALL channel memory, just press [FW] to display something in the memory box, then press the  button. To store a separate transmit frequency in the CALL channel, after storing the receive frequency, use the DIAL knob to select the transmit frequency and repeat the above, but this time *holding the PTT switch when you press the  button.*

Separate Transmit Frequency Memories

Besides the CALL memory, all other memories can store independent Rx and Tx frequencies (however, if you're working through a repeater, you might find storing a unique repeater offset to be simpler - see "*Odd Split Memories*", previous page). To store a separate transmit frequency,



- Store the receive frequency using the method already described under "*Simple Memory Storage*" (it doesn't matter if a repeater offset is active).
- Tune to the desired transmit frequency, then press [FW] to display the memory label box again.

- Press and hold the PTT switch while pressing  once more momentarily (this will not key the transmitter).

Whenever you recall a separate transmit frequency memory, “- +” appear together at the top of the display. Again, you can press the  key to display the transmit frequency, and the shift symbols will blink.

After storing a memory with a separate transmit frequency, if you rewrite the receive frequency, the separate transmit frequency is deleted.

Memory Tuning

While receiving on a recalled memory, you can retune it and change other memorized settings (like repeater shift) by first pressing the  button momentarily. “MT” appears to the right of the memory label in the memory box, and you can tune in the same ways as described before (including the 1-MHz button). You can store the new frequency and settings in the current or other memory, press [FW], select the new memory (if desired), and press  again momentarily. Operation remains on the (new) memory as the old memory (if different) reverts to its original state. After re-

tuning a memory, if you don't want to save your changes, just press D/M/R SKIP : once to return to the original memory data, or twice if you want to leave the memories and return to the dial mode.

Masking Memories

As already mentioned, storing data in a memory automatically overwrites previously stored data. However, if you regularly move from one area to another, you may not always want to use the same memories. With the FT-2200, you can select and alter which memories are available without having to rewrite them from scratch. This can be done by masking certain memories (except for memory channel 1) so that they are hidden from operation, and unmasking them only when desired. Any memory channel can be masked except for channel 1.

To mask a memory,

- Recall the memory to be masked.
- Press [F/W] \Rightarrow STEP REV , this causes the display to change to the next lower stored memory, and the previously selected memory to be no longer selectable manually, or by scanning (described later).

To unmask a hidden memory for operation,

- Recall any memory, press [F/W], then select the memory number to be restored.
- Press the STEP REV key (not F/W !).

Note! When you have hidden some memories, be careful not to overwrite them accidentally. If you do, you will lose the previous contents.

Scanning

Before you start scanning, make sure the **SQL** control is set to squelch off the noise on a clear channel. You start and stop scanning with the **UP/DWN** keys on the microphone. Just press and hold either button for more than 1/2-second to start the scanner. If the transceiver is in the dial mode, band scanning will result. Otherwise, if a memory label is displayed, only the memories will be scanned.



Scanning pauses when a signal opens the squelch, and the decimal point on the display blinks. You can stop the scanner manually by pressing the **PTT**, or **UP/DWN** buttons on the microphone, or the D/M/R SKIP button.

Memory Skip Scanning

When you have some very active channels stored in memories you may wish to skip them when scanning, but still have them available for manual selection. You can mark a memory to be skipped by pressing **(F/W)** \Rightarrow  while receiving

Scan Resume Selection

You have a choice of *two* scan-resume modes: either *Carrier* mode, in which the scanner pauses for as long as the carrier keeps the squelch open; or the *Timed* mode, in which the scanner pauses for five seconds and then resumes scanning whether the signal is still present or not. The 5-second timed mode is the factory default.

To change the scan-resume mode, press **(F/W)** \Rightarrow , a small “ ± 5 ” or “ ± 5 ” in the memory box indicates the current mode. If you want to change it, press **(F/W)** momentarily. Press the  key to return to the frequency display when the scan-resume mode is set the way you want it.

on the memory. The “**◀ SKIP**” indicator appears to the right of the memory number box to show that this memory will be skipped during scanning (although you can still recall it manually).

To re-enable a scan-skip memory for scanning, just repeat the steps you took to disable it: select the memory manually, and press **(F/W)** \Rightarrow .

PMS (Programmable Memory Scan)

Besides band and memory scanning, the FT-2200 can be set to scan (or tune) only the frequency limits between two sets of special-purpose memory channel-pairs labeled $L1$ & $U1$ and $L2$ & $U2$

- Store the lower edge of the desired scanning range in memory $L1$, and the upper edge in memory $U1$.
- With either memory $U1$ or $L1$ recalled, press the  button momentarily.

As just described in Memory Tuning, “**MT**” appears next to the memory box, and you can tune the memory. The frequencies stored in memory pairs $L1/U1$ and $L2/U2$ now limit your tuning and scanning range to the resulting subband. If the either **ARS** or manual repeater shift is activated, repeater offset is applied automatically when

you transmit (even if the resulting transmit frequency is outside the subband limits).

Example: To limit reception to 146.0 ~ 148.0 MHz using memory pair \downarrow / \uparrow (only applicable to certain transceiver versions)

- Tune the dial to any channel between 146.000 and 146.095 MHz (see note below right).
- Press [**F/W**], tune the DIAL knob so that “ $\downarrow /$ ” appears in the memory box, and then press [**F/W**] again momentarily. The displayed frequency is now stored to provide an effective lower subband limit of 146.000 MHz.
- Tune the dial to any channel between 148.000 and 148.095 MHz.
- Repeat the second step, selecting “ $\uparrow /$ ” in the memory box. This stores the effective upper subband limit of 148.000 MHz.
- Press $\begin{matrix} \text{D/MR} \\ \text{SKIP} \end{matrix}$ to change to memory operation.
- Press the $\begin{matrix} \text{MHz} \\ \text{PRI} \end{matrix}$ button momentarily to activate the 146.000 ~ 148.000 subband limits for tuning and scanning.

To cancel your limits and return to memory operation, press $\begin{matrix} \text{D/MR} \\ \text{SKIP} \end{matrix}$ (if you are scanning, or want to return to dial operation, you must press it twice).

Pressing the $\begin{matrix} \text{CALL} \\ \text{DTMF} \end{matrix}$ button also cancels subband limits as operation switches to the CALL channel.

Once you have stored the \downarrow and \uparrow memory pairs, you can reactivate the subband just by recalling either memory and pressing $\begin{matrix} \text{MHz} \\ \text{PRI} \end{matrix}$. However, you cannot activate the subband when the \downarrow or \uparrow memory pairs are marked for skip-scanning, or if either of these memories are individually masked (hidden).

Note!



The frequency resolution of the PMS-subband limits is 100 kHz, although the channel resolution of the subband limits is the selected channels step size. Therefore the frequencies stored in these memories are both *rounded down to the nearest 100 kHz* for their purpose as subband limits.

Since the subband limit memories are not limited to a specific frequency, you can still use them for other purposes within the 100-kHz range above the intended subband limit.

Priority Channel Monitoring

This function automatically checks for activity on a memory every five seconds while operating on the dial or other memories (but not while scanning). When the receiver detects a signal on the priority memory, operation automatically shifts to that memory while the signal is present (plus a few seconds). If you transmit while paused on the priority memory, priority monitoring ceases and operation stays on the priority memory.

To set up for priority monitoring:

- Preset the squelch, and store the frequency to be monitored in a memory (this must be memory 1 if you will be operating on other memories during priority monitoring).
- Press  to operate in the dial mode, or else select the memory you want to operate on, and then press  ⇒ .

A “P” appears in the memory box, and about every five seconds the displayed frequency shifts to the priority memory briefly while the receiver checks for a signal.

While no signal appears on the priority memory to open the squelch, you can tune, transmit and

receive on the dial, or select and operate on other memories (but not scan them). If a station you wish to talk with appears on the priority memory, press the **PTT** switch momentarily while receiving their signal, to stop priority checking. Otherwise, when a signal appears on the priority memory, priority checking will pause and the decimal on the display will blink. Priority monitoring will resume according to how you set the scan-resume mode - either after a 5-second pause, or after the carrier drops (see *Scan Resume Selection*). To cancel priority monitoring manually, press .

Note that you can use any other memory as a priority channel in the above procedure when you are going to be operating in dial mode. You cannot, however, switch from memory to dial operation or vice-versa without first canceling priority monitoring (pressing  cancels priority monitoring).

CTCSS Operation

The built-in Tone Encoder function can be used to access repeaters and stations that require a CTCSS tone, by sending a tone whenever you transmit. Also, if you have the FTS-27 Tone

Squelch Unit option installed, you can silently monitor for calls on busy channels. The encode function superimposes a subaudible tone (at a frequency too low to be heard) on the transmitted carrier. The optional (FTS-27) decode function monitors receiver audio through a narrow filter at the same subaudible frequency, keeping the squelch closed until you receive a matching tone. *Installation of Options* at the back of this manual describes installation of the FTS-27.

- To check or set the CTCSS tone frequency, press **F/W** ⇒ **T.SET TONE** to see the tone frequency displayed in Hz.



- To change the tone frequency, rotate the DIAL knob or press the microphone **DWN/UP** keys until the display shows the correct tone frequency you require (from the choices in the following table).
- Press **T.SET TONE** to return to the operating frequency display after checking or selecting the tone frequency.

FTS-27 Tone Frequencies (Hz)			
67.0	94.8	131.8	186.2
69.3	97.4	136.5	192.8
71.9	100.0	141.3	203.5
74.4	103.5	146.2	210.7
77.0	107.2	151.4	218.1
79.7	110.9	156.7	225.7
82.5	114.8	162.2	233.6
85.4	118.8	167.9	241.8
88.5	123.0	173.8	250.3
91.5	127.3	179.9	

To activate CTCSS operation

- Press **T.SET TONE** when the operating frequency is displayed. “ENC” (encode) appears at the upper-left edge of the display and the tone generator is activated for transmission. If you press **T.SET TONE** again without the FTS-27 option, the encoder turns off. If the FTS-27 is installed, both “ENC” and “DEC” (decode) are displayed together as tone squelch is activated for both transmission and reception (requiring a matching tone frequency to open the squelch). Pressing **T.SET TONE** once more disables tone squelch.

You can store different CTCSS tones (and encode/decode states) in each memory in the same manner (and at the same time) as storing operating frequencies. Later, to change the tone or state stored in a memory, just recall it, reset the tone frequency or function, and store the memory again.

“CTCSS Bell” Paging with the FTS-27

CTCSS Bell operation is very similar to the CTCSS encode/decode operation just described, in that subaudible tones open the squelch. However, if you are waiting for a call, it is sometimes convenient to have the transceiver “ring” to get your attention. The CTCSS Bell mode displays a small bell “

To activate the CTCSS Bell:

- Select a CTCSS tone frequency using the **F/W** and **T.SET** **TO** keys as described on the previous page, if you have not already.
- When you expect to receive calls from stations using tone squelch (decoding, or CTCSS Bell), activate tone squelch encode/decode operation as

described above, so you will not miss calls when you turn off the CTCSS Bell later to reply.

- Then, press **F/W** ⇒ **BELL** **DVS**.

As with CTCSS decoding, calls without a matching CTCSS tone will be ignored by your receiver. Any call received with the matching CTCSS tone will cause the transceiver to ring and the squelch to open while the caller transmits. The bell icon begins to blink, and continues until you manually reset it (by pressing the **PTT** switch to transmit, or re-tuning using the **DIAL** knob or **UP/DWN** keys). Note that the other station does not need to be using the CTCSS Bell function to call you: they can use normal CTCSS encode-only (or encode/decode) functions of their transceiver.

When you receive a call, if you have the ringer enabled, you may want to disable the CTCSS Bell feature to prevent ringing every time the other station transmits: press **F/W** ⇒ **BELL** **DVS** to turn it off.

The CTCSS Bell system is not memory-specific: turning it on or off affects the dial and all memories.

DTMF Paging & Code Squelch

The FT-2200 includes dedicated microprocessor circuitry providing paging and selective calling features using DTMF tones. This allows you to place a call to a specific station or group, and to receive calls directed only to you or groups of your choice.

The paging and code squelch systems use 3-digit numeric codes (000 ~ 999), transmitted as DTMF (Dual-Tone, Multi-Frequency) tone pairs. Eight Code Memories numbered 0 ~ 7 (entirely independent of the 49 channel memories) are used to store 3-digit DTMF paging codes.

Your receiver normally remains quiet until it receives three DTMF digits that matches one of those stored in a selected DTMF Code memory. The squelch then opens so the caller is heard, and in the paging mode, the transceiver also rings. When you close the **PTT** to transmit, the same three pre-stored DTMF code digits are transmitted automatically. In the paging mode, three more DTMF digits are also sent, representing your personal station identification.

The DTMF paging and code squelch systems are selected by the  key. Either “PAGE” or “CODE” appears on the display when DTMF paging or code squelch is activated, respectively.

DTMF Code Squelch

The code squelch mode is very simple. Both you and the other station communicate using the same 3-digit DTMF sequence, sent automatically by the FT-2200 at the start of every transmission. Your receiver normally remains silent to all signals that are not prefixed by your selected 3-digit code. When you receive the tones, your squelch opens and stays open until a few seconds after the end of their transmission.

Before using DTMF code squelch, you must first store and then manually select the one Code Memory holding the 3-digit DTMF code required to open *your* squelch (as described on the following pages). Also, in the code squelch mode, Code Memories 1 ~ 7 always function the same — the distinctions and special settings described below for the paging mode do not apply.

In either code squelch or paging modes, any DTMF-equipped station can call you. They can

use a DTMF keypad to send the three digits if you are in code squelch mode, or seven digits (actually, three digit - * - three digits, e.g. 123 * 456) if you are in paging mode.

DTMF Paging

In the DTMF paging mode, you can receive signals that are prefixed with any of up to six different 3-digit codes, according to the way you program the Code Memories. When you receive a paging call, the selected Code Memory changes automatically, and the display responds in one of two ways, depending on how you stored the paging code:

Individual Codes

These are personal ID codes to identify each station uniquely. You store one of these for your ID in Code Memory 1, and up to six other Individual Codes of stations you call often, in Code Memories 2 ~ 7. When someone else transmits your Individual Code your display shows “P” in the Code Memory position (that is, the 100’s-of-MHz position), with the other station’s Individual

Code appearing to the right so you can see who called (see below).

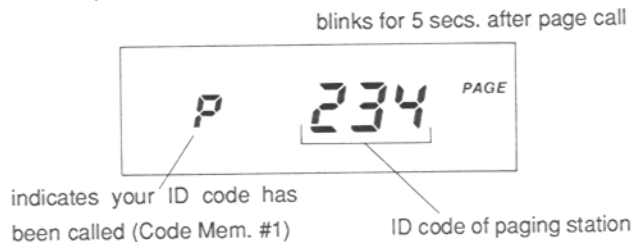

Group Codes

This type of code identifies a group of stations. You would generally share a Group Code with other club members or friends. When you receive a call with a Group Code the Code Memory number (2 ~ 7) in which you stored that 3-digit Group Code appears in the Code Memory position on your display, with the 3-digit Code number to the right, as below.

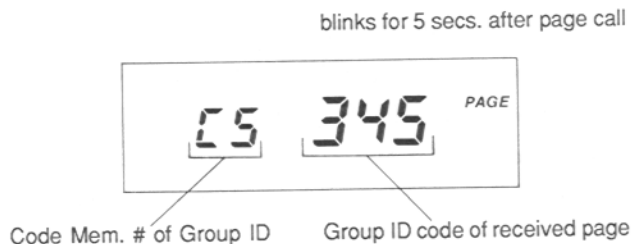

Note that for a Group Code, the display does not show the ID and code of the caller, but those of the group instead. Code Memories 2~7 can be used to store either Individual Codes (for calling purposes only) or Group Codes (for both calling and receiving), as you desire.

With either type of page, the **PAGE** indicator starts blinking when a page is received, and continues for approximately five seconds.

Remember, the difference between code paging and code squelch operation is that *with the code squelch, you can only receive a call on the currently-selected Code Memory, and the display does not change when a call is received.* The Individual/Group distinction does not apply (although you must still store the 3-digit Code Memories).

DTMF Code Monitoring

Whenever a 3-digit DTMF code is received while either code squelch or DTMF paging is active, the code is automatically written into Code Memory 0. By selecting this Code Memory as described below, you can see what DTMF code was last received, whether it opened your squelch or not.

Storing Code Memories



The first thing to do before using the paging or code squelch systems is to store your Individual Code in Code Memory 1.

- Activate paging or code squelch functions by pressing .

Pressing this key combination cycles through;

- DTMF Paging (“**PAGE**” displayed),
- *Trigger* paging (the “” icon displayed with “**PAGE**”),
- Code Squelch (“**CODE**” displayed), and No paging (none of the above symbols).

You may have to repeat these keystrokes until you get either “**PAGE**” or “**CODE**” displayed .

- Press  ⇒  to enable the Code setting mode. The frequency display is replaced by a blinking Code Memory number in the memory box, and the corresponding 3-digit Code (“**000**” if not used before) in the center of the display (shown next).



- Turn the DIAL knob or **UP/DWN** keys to select Code Memory 1 (this digit can be set to 0 ~ 7, with 0 being “read-only”, and 2 ~ 7 programmable with group or other individual’s IDs). Code Memory 1 is for your personal DTMF paging ID Code.
- Press the MHz PRI button . The Code Memory number will stop blinking, and the first digit of the DTMF code to store will begin to blink.
- Turn the DIAL knob to select a DTMF Code digit between 0 and 9, corresponding to the first digit of the personal ID code for your station on this band.
- Press MHz PRI again to cause the next digit to the right to blink, and again use the DIAL to select the next digit of your ID code.
- Repeat the above step to set the last digit.

At this point, if you want to go back and change one of the three code digits, press MHz PRI and step to the digit to be corrected.

- Press the C.SET PAGE key to return the display to its normal paging mode.

Your ID Code is now stored in Code Memory 1. You can use the same procedure to store the Memory Codes of other individuals or groups in Code Memories 2 ~ 7, but with an additional feature. Generally, you store another station’s ID Code so you can page them, but do not want to have your transceiver ringing every time someone else calls them. On the other hand, you store group codes with the intention of receiving any pages to the group (so you want your squelch to open and the transceiver to ring, if paging).

Page Code Inhibit

When storing Code Memories 2 ~ 7 as just described, you have an opportunity to decide whether your transceiver should respond to incoming paging calls on a particular Memory Code. After pressing F/W \Rightarrow C.SET PAGE to activate Code setting, and while the leftmost (Memory Code) digit is blinking, you can press the F/W key to toggle DTMF squelch paging capability on and off. When on, and the decoder is enabled to receive paging calls with

this Code Memory, a small underbar “_” appears beneath the digit.

Therefore, if you are setting a Group Code, you want to have the underbar on, and if setting another station’s Individual Code, you want it off. As already mentioned, this distinction does not apply to code squelch only (non-paging) operation.

Note that the underbar *is displayed permanently on Code Memory 1*, since this is your own ID (that you will always want to receive when paging is activated). Also, the underbar *never appears on Code Memory 0*, since this Memory slot is reserved for displaying a paging station’s individual code.

Once you have stored your own ID Code in Code Memory 1, you can activate the paging or code squelch functions by pressing . As mentioned earlier, repeatedly pressing this key cycles through DTMF Paging, Trigger Pager (covered next), and DTMF Code Squelch.

DTMF Code Squelch Operation

As described earlier, with the DTMF Code Squelch active (“CODE” displayed), your squelch

will open when you receive the proper 3-digit DTMF ID code according to the selected code memory. Likewise, each time you press the **PTT**, the same 3-digit code is automatically sent to open the other station’s DTMF Code squelch.

DTMF Paging Operation

Now you are ready to receive DTMF Paging calls directed to you. Any DTMF-equipped station can call you by sending your 3-digit code, followed by an asterisk “*” and their 3-digit ID Code. If you monitor with the code squelch activated (“CODE” displayed), your squelch will open when you receive your ID Code. If you are monitoring with the DTMF Paging feature activated (“PAGE” displayed), the transceiver reacts according to how you stored your Code Memories, as previously described.

If you press your **PTT** switch after receiving a call, the Code (either Individual or Group) is transmitted automatically, and if paging is enabled, your ID Code is sent.

To respond to an individual call, where your display shows Code Memory 0, pressing your **PTT** switch causes your transceiver to transmit your

ID Code and the other station's ID Code automatically (that is, the one displayed in Code Memory 0), and resets the pager to receive another call. The other station will then hear a ring from their receiver, as their squelch opens.

You will want to switch from Paging to Code Squelch mode once contact is established, or your transceiver will continue to ring every time the other station transmits. To do this, press  until "CODE" appears at the right of the display.

With Code Squelch activated in this manner, you will hear three DTMF code digits transmitted when you press your **PTT** switch. These digits are those stored in the Code Memory currently displayed in place of the 100's-of-MHz digit, and they will open the squelch of the other station. Therefore, at the start of each transmission, you must wait a second or two after pressing the **PTT** switch for the DTMF code to be sent (you will hear it in your speaker).





When your conversation is finished, you can reactivate DTMF Code Paging, by toggling



until "PAGE" is displayed.



DTMF Code Delay

When calling other stations with DTMF paging or Code Squelch, particularly through repeaters, you may find some are unable to receive your calls. This can be caused by their receiver squelch not opening fast enough (after receiving your carrier) to allow all of the DTMF codes to be received and decoded. To correct this problem, you can set a longer delay time between the time your transmitter is activated and the time that the first DTMF tone is generated. You may need to experiment with different delay times to determine which is optimum.

Press  ⇒  to activate the paging code display, the current delay time is the smaller single number to the left of the 3-digit code. Toggle the  key to select a DTMF Code delay time of 200msec, 400msec(default), 700msec or 1000msec. When the desired delay time is displayed, press  to save your entry and return to the frequency display.

Trigger Pager

This feature can be used exclusively between Yaesu transceivers to avoid having to manually change to Code Squelch operation to talk after a page call is received.

To activate this feature press  until a small “” icon appears along with “PAGE”.







Your transceiver will respond as before when a page is received, however if the other station is using a Yaesu transceiver (also in the Trigger Pager mode), communication can begin by pressing the PTT, and begin talking *within three seconds* after the DTMF code is sent. The pager resets to receive a new call as soon as either station fails to respond to the other within three seconds.



Special Paging Functions

The way your transceiver responds to an incoming paging call can be customized using two special functions: *Auto-Page Forwarding* and *Auto-Page Transpond*. These features provide automated response when you are out of hearing range of your transceiver, but not out of radio range when a call is received.

Auto-Page Forwarding

This feature can be used to extend the radius of your paging range by using your transceiver as a paging-relay(forwarding) station. With this feature enabled, a valid received page code will cause your radio to immediately(within five seconds) re-transmit the same page code. Thus, if you are away from your vehicle, but are carrying a hand-held transceiver, for example, and still within range of your FT-2200, a paging call from stations beyond your un-aided range can still be received.

To activate auto-page forwarding, just press  after the DTMF Code setting display is active, or  ⇒  ⇒ . A “” appears at the right when the feature is enabled. Toggling the  button at this point steps through the following three choices:

- “” Auto-Page Forwarding
- “” Auto-Page Transpond(covered next)
- “ - ” no response (off)

Press **C.SET** **PAGE** again to return to the frequency display, the function is active any time the Paging mode is selected (“PAGE” displayed).

Auto-Page Transpond

Normally, after a page is received, the indicator blinks on the display until you transmit to respond to the page, or press **D/MR** **SKIP** or to return to the frequency/memory display. This lets you know if a call came in while you were distracted, but it does not let the caller know whether or not you received his page. The auto-transpond feature addresses this problem. When enabled, your display still changes to show Memory Code 0 and the caller’s code, and the ringer still sound (if it is enabled), but the radio also automatically transmits your ID Code back to the caller. Thus he can tell that you’re in range, although possibly not able to answer his page right away.

To activate this feature, toggle the **D/MR** **SKIP** button as above until “**A**” appears.

Note that Auto-transpond is not Code-Memory specific: it is either enabled or disabled for all paging calls (including groups).

Special Paging Functions

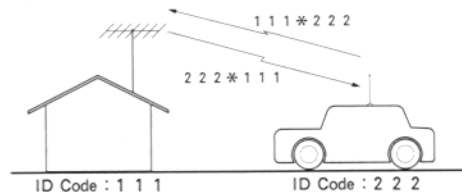

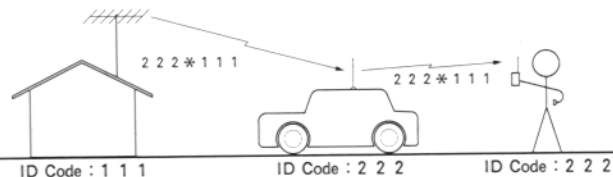

Auto-Page Transpond - When a page call for you is received, the FT-2200 automatically “calls back” the paging station with your personal ID in the correct code sequence, then resets for the next call.



Auto-Page Forward - When page calls directed to you (with your personal ID code) are received, the FT-2200 automatically re-transmits the page call (original sequence), then resets.





DTMF Auto-dial Memories

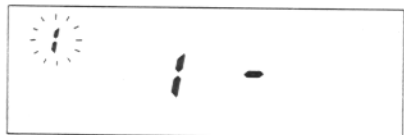









There are ten memories, numbered 1~10, for storage of DTMF tone sequences of up to 15 digits each, that can be used for telephone numbers for autopatching systems. One of these memories can be dedicated to store the user-programmable Ringer Alert Melody (covered later).



To use the DTMF memory feature a special mode must first be activated by pressing  ⇒  , the display will appear as shown next with the currently selected DTMF Memory blinking in the memory box.



To store a DTMF memory:

- After pressing  ⇒  , rotate the DIAL knob to select any DTMF Memory from 1~10 (except “U5”, this is not an Auto-dial Memory and is explained on the following page).
- Press , then rotate the DIAL knob to select the first DTMF digit to enter.

- Press   to save the first entry and move on to the second-digit's place. Repeatedly use the DIAL and   button to enter all the digits of your sequence. As each digit is entered, the counter to the left will advance to reflect the current serial digit place (up to 15). If at any time you enter an incorrect digit, you can start over by pressing  , the serial counter will reset back to the first digit entry place.
- If you are storing fewer than 15 digits, press  briefly to terminate entry, otherwise entry terminates after the 15th digit is entered. To replay the stored digits, press  .
- To store digits in another auto-dial memory, turn the DIAL knob to select another DTMF memory and repeat the last three steps.
- Press   to return to the frequency display.

To use the DTMF auto-dialer while transmitting, first select the desired DTMF Auto-dial memory (1~10) as described above, then press   after keying the **PTT**. Note: you can release the **PTT** once the DTMF sequence has started, as the radio will remain keyed until the last digit has been sent.

Ringer Settings

You can control the way the transceiver rings when either a selective call (CTCSS Bell, or DTMF Page) is received. In addition, you can program (“compose”) your own ringer melody in a special user memory and select it as the default melody. To check or change the state of the ringer, press **[F/W]** ⇒ **[PAGE]**^{C.SET}, the display will appear similar to that shown next.

displayed ringer setting default / user-programmed
DTMF Paging / CTCSS Bell ringer melody selection

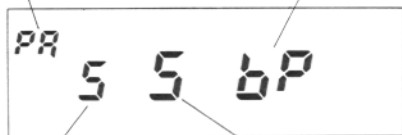

single / continuous ringer

ringer duration

The number in the center of the display indicates the alert ringer duration, and can be set to “bP” (OFF), 1, 3, 5 or 8 (ringing tone pairs) with the DIAL knob or mic **UP/DWN** buttons. There

may also be a smaller size letter “5” displayed just to the left. If present, the ringer is set to only ring *once* (single ring) when a call is received. If you want the ringer to continue sounding when a call is received, *and every minute thereafter* until reset by the **PTT**, or corresponding tone button, toggle the **MHZ**^{PRI} button so that the “5” disappears.

The memory box shows either “PR” (for DTMF pager) or “bP” (for CTCSS Bell), indicating which response mode the displayed ringer settings apply. Press **[F/W]** to allow changing the other mode’s ringer setting.

At the right side, “bP” indicates the currently selected factory-default ringer, when a user-programmed melody “55” has been entered (covered next), toggling **D/MR**^{SKIP} will select which will be the default alert ringer.

Composing your own Ringer Alert Melody

The user-programmed ringer alert memory, displayed as “55” can be selected and programmed in the exact same manner as described for DTMF Auto-dial Memories on the previous page, however, this melody is played back with notes from

the traditional music scale. The following scale is provided below for your reference.

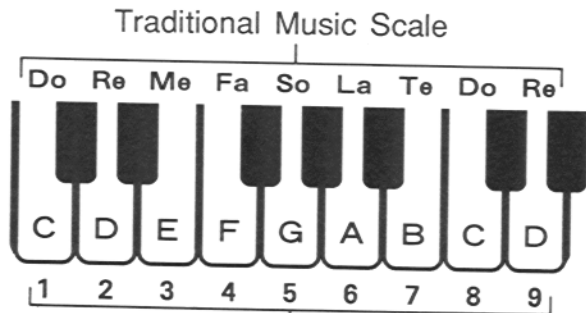

Corresponding Digit Entry

After first programming the user memory channel with your own melody, you can select it as the alert ringer;

- Press [**FW**] ⇒ [**C.SET**/**PAGE**], then select either CTCSS Bell “**hP**” or DTMF Pager “**PP**” using the [**FW**] button.
- Toggle the **D/MR**/**SKIP** key to change from the default ringer “**hP**” to user-programmed “**US**”. These two steps can be repeated for both CTCSS Bell and DTMF Paging, if you desire.

“Memory-Only” Mode



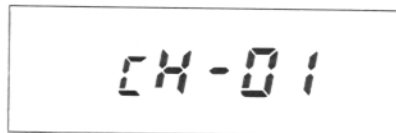

You can select this feature to have the front panel only show currently selected memory channels instead of the default display as shown below. Other individual settings (i.e., repeater shift, tone squelch indications) *originally programmed in each memory channel* will still appear. However, you cannot change these settings from the front panel controls while in this mode (all push-button controls are disabled except for the **LOW**/**LOCK** key).



After programming your radio’s memory channels, you can activate this feature by turning the transceiver off, then pressing and holding the **BELL**/**DVS** & **C.SET**/**PAGE** keys together while powering the radio back on again. Use the DIAL knob or mic. **UP/DWN** keys to select the memory channel for operation. Repeat the above step to return to normal operation.

Extended Reception & AM Receive

The FT-2200 reception range can be extended down to 110 MHz, and has an AM detector that can be activated to permit reception of aeronautical band(110 - 136 MHz) transmissions (note: extended frequency coverage not available on some transceiver versions and specification are guaranteed only within amateur bands).

To extend the receive range, turn the radio off, then press and hold the  &  keys together while turning the power on again. AM is automatically selected when receiving below 140.000 MHz, and is indicated by the "★" icon displayed above the tens-of-MHz digit. AM receive can be toggled on/off by pressing  ⇒ . Extended receive frequencies and AM mode settings can be programmed into memory channels as before.

Digital Voice System Operation (w\DVS-3 Option)

The DVS-3 includes the latest microprocessor-controlled PCM (pulse-code modulation) digital voice recording and memory circuitry, allowing recording either from the microphone or receiver, and playback through the loudspeaker or on the air.

A one-megabit RAM (random access memory) on the DVS-3 can be used as a single block for up to 128 seconds of recording, or be recorded in segments for selective playback. Eight memory segments can be grouped in various ways for recording and playback, as determined by your choice of "Segmentation Codes".

The sampling bit rate of the A-D (analog-to-digital) converter is front-panel selectable between 8, 11, 16 and 32 kilobits/second. This allows you to select the optimum trade-off between recording time and fidelity. Different bit rates may be selected for different segments.

The microphone **DWN/UP** keys activate and deactivate recording and playback, while the

S&PO bargraph shows relative record/playback time elapsed.

Voice System Display

When installed, digital voice operation is toggled on and off by pressing the  key. With digital voice operation activated the display has the following format:

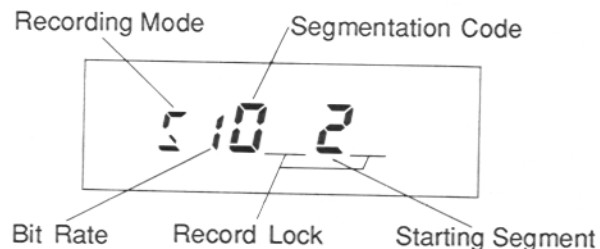

- Recording Mode ("5" or "M")

This is either "5" for Speaker or "M" for Microphone: the Speaker Recording Mode indicates that the source of audio for recording is the loudspeaker – that is, received signals. The Microphone Recording Mode indicates that the source of audio for recording is the microphone – that is,

messages from the local operator. The **T.SET** **TONES** key toggles between these recording modes.

- Bit Rate (1 ~ 4)

The number displayed in this location signifies the selected sampling bit rate for recording or playback in this Segmentation Code, as follows:

Bit Rate No.	kbits/sec	1-Segment Play/Record Time (secs.)	All Segments Play/Record Time (secs.)
1	32	4	32
2	16	8	64
3	11	12	92
4	8	16	128

Note that the slower bit rates (larger Bit Rate Nos.) provide more recording time, but at reduced fidelity. Press the **STEP** **REV** key and rotate the DIAL knob (while the displayed Bit Rate digit is blinking) to select a different rate.

- Segmentation Code (0 ~ 9 or R ~ F)

The character displayed here indicates which memory segment or combination is selected for recording and playback, as follows:

- 0 Segments 2 ~ 8 combined
- 1~9 Individual Segment access
- 9 Segments 1 and 2 combined
- R Segments 3 and 4 combined
- b Segments 5 and 6 combined
- c Segments 7 and 8 combined
- d Segments 2 and 4 combined
- E Segments 5 and 8 combined
- F Segments 2 ~ 8 accessed sequentially (1 at a time)

While the DVS-3 is activated, rotating the DIAL knob selects the Segmentation Code. The other displayed parameters change according to the way they are set for each Segmentation Code.

- Starting Segment (1 ~ 9)

The number here identifies the starting Segment number of this Segmentation Code for recording or playback. This is, of course, identical with the Segmentation Code for Codes 1 ~ 8, and is automatic when selecting the Segmentation Code with the DIAL knob.

- Record Lock (“L” or blank)

“L” is displayed here when the displayed Segmentation Code is Locked to prohibit recording. Press the  button to toggle record locking on and off.

Segmentation Code Selection Notes

While the DVS-3 is activated, the DIAL knob selects from among the sixteen possible Segmentation Codes. As stated above, each Segmentation Code has its own set of associated parameters, displayed when each Code is selected.

Note that Segmentation Codes 0, 9 and A ~ F select the same memory segments as Codes 1 ~ 8, merely with different partitioning. Therefore, if you record in Code 2, for example, the recording will be played back in Codes 0, 2, 9, d and F, since each access the same memory segment (2).



Recording

You may want to partition the memory for two different purposes: storing your replies to incoming calls, and recording incoming messages. You must decide how much of the memory to dedicate to each purpose yourself, which in turn determines

which memory segments to use for each purpose. However, despite that consideration, you should record your callsign in Segment 1.

The **UP** button on the microphone starts recording, and can be used to stop it as well. While recording, the S-meter indicates the relative recording time elapsed: when the S-meter reaches full scale, the currently selected memory is full.

To record your callsign:

- Turn on the radio, and press  to activate digital voice operation.
- Press  key, if necessary, so that “M” appears at the left (to select Microphone recording).
- Rotate the DIAL knob while watching the Segmentation Code digit in the center of the display (that is, the leftmost of the large digits), and select Segmentation Code 1. Notice that a “1” also appears in the Starting Segment display position (Code 1 always starts with Segment 1).
- Note the number (1~4) displayed just to the right of the “M”, signifying the bit rate. You will want to experiment with all four possible bit rates (as detailed below), but for now, let’s start with the fastest rate, number 1. If another number is

displayed, press the **STEP REV** key, turn the DIAL knob until “1” appears next to the “M”, and press **STEP REV** again.

- Rotate the DIAL knob to select Segmentation Code 1 in the center of the display.
- There should be no “L” at the right side of the display, since you don’t want to lock out your callsign. If you see an “L”, press the **MHz PRI** button to clear it.
- Put your finger near the **UP** button on the microphone, and hold it near your mouth. Now, while watching the S-meter for recording time, press the **UP** button momentarily and speak your callsign. Then either press **UP** again to stop recording, or just wait until the S-meter reaches full scale (and recording stops automatically).

You may not have had enough time between the two beeps that signaled the start of recording and the beep at the end. Anyway, to check your results, just press the **DWN** button on the microphone (and adjust the volume, if necessary).

If you were very close, you might want to just press the **UP** button again and re-record, speaking a little faster. Otherwise (or just for fun), change the bit rate to 2 (press **STEP REV**, turn the DIAL knob

one click clockwise, and press **STEP REV** again) and try again. Notice you have twice the recording time (the S-meter advances more slowly during recording).

Press the **DWN** button again to play back this recording. You will notice it sounds a little ‘scratchy’. Bit rates 3 and 4 provide even longer recording times, but sound even more scratchy (go ahead and try them). If you find you have much left-over time (as indicated on the S-meter), press any microphone button to stop recording. Pick the fastest bit rate that gives you just the necessary recording time.

You can record any other memory segments in the same way you did your callsign. You may even record while transmitting (if the digital voice system is activated), in which case Microphone recording is selected automatically.

On-The-Air Recording & Playback

When the digital voice system on, you can play back over the air anything that you have previously recorded: select the Code to play back and then press the **DWN** button while holding the **PTT** switch.

On-The-Air Recording & Playback

When the digital voice system on, you can play back over the air anything that you have previously recorded: select the Code to play back and then press the **DWN** button while holding the **PTT** switch.

You can also record incoming signals heard in the loudspeaker:

- Press **BELL** **DVS** (if displaying frequency) to activate the digital voice system.
- Press the **T.SET** **PHONE** key, if necessary, to select the Speaker Recording Mode.
- Select the desired Segmentation Code using the DIAL knob, and then select the desired Bit Rate using the **STEP** **REV** key and DIAL knob.
- Press the **UP** button on the microphone to start recording.
- Press the **DWN** button to play back the recording (and hold the **PTT** if you want to play it back over the air).

Remote Recording and Playback

If you have a second transceiver equipped with a DTMF keypad, you can operate the DVS-3 re-

motely using 3-key DTMF comands, listed in the table on the next page.

To do this, the DVS-3 must first be activated and then set to the remote control mode, as follows:

- Press **BELL** **DVS** (if displaying channel frequency) to activate the DVS-3.
- Note the indicated bit rate, and change it, if desired, as described previously.
- Press the **R.SET** **RPT** button, the display will appear as below with "R 1" displayed at the left to indicate remote recording & playback.

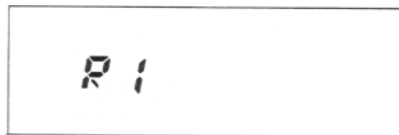

The transceiver is now set for remote control. The Command Set Chart on the next page shows the various commands and their effect. To send a command, hold the PTT switch on the remote transceiver while entering the indicated DTMF Code key, one at a time. Then, if you are recording, speak into the microphone. Otherwise, release the

PTT switch and listen for the response from the DVS-3. Note that segment 1 (which should be your callsign) is read back before any other data is transmitted.

Remote Command Set

Func. Name	DTMF Code	Description	Note
Reset	# # #	Cancel input or stop recording	
Check Empty	# 0 0	Check for unused segments	(1)
Record All	* 0 0	Record segments 2 ~ 8	(2)
Record One	* 0 1	Record in any (unlocked) segment	(3)
Bit Rate	* 1 r	Set Bit Rate r (1~4) for recording	(2)
Confirm	# 0 1	Playback last recording to confirm	(4)
Lock Last	* 0 2	Lock last recording	(1)
Play All	# 1 0	Playback all unlocked segments	(4)
Play One	# 1 x	Playback segment x (1~8 only)	(4)
Unlock All	# 2 0	Unlock all locked segments	(1)
Unlock One	# 2 x	Unlock segment x (1~8)	(1)

Notes (referenced in above table):

(1) High/low tone response indicates success (memory available or lock/unlock executed), else low/high tone response indicates failure (memory full or lock/unlock not executed).

(2) Segment 1 (callsign) played back followed by a single beep if record successful, else low/high tones returned after segment 1 playback (to indicate record attempt failed).



(3) Same as note (2) if command accepted, else no response.

(4) Segment 1 played back followed by a single beep and then the selected segment(s), if successful. Low/high tones if playback command rejected. In the case of multiple segments, each is separated by (suppressed) high/low beeps.

Whenever a remote command is received, the transceiver display shows the Segmentation Code accessed (0, or 2 ~ 8). Up to four codes will be displayed, scrolling from right to left on a first-in/first-out basis (older codes disappear). This allows you to tell at a glance if someone has called, and where their messages may be located.

Locking Segments

You may record some segments you don't want played back over the air during remote access. These can be locked out locally by pressing the  button when the DVS-3 is in its normal (non-

remote) mode. Pressing  once locks out both recording and playback, indicated by an "L" near the center of the display and another "L" at the right of the display (see below). Press  a second time to allow playback, but not recording (only the rightmost "L" displayed). Press  a third time to cancel lockout.

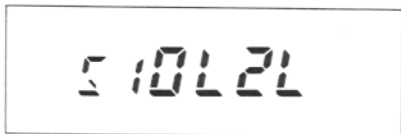



Note that segments that are locked out for playback cannot be accessed by remote operators. However, segments locked out for recording only (rightmost "L" displayed when the Segmentation Code is displayed), can be unlocked by remote operators, and then recorded over and locked again, if desired. The usefulness of this design is that if you are away from the transceiver and have it set for remote operation, your friends can call in and leave messages. You can then access the messages while you are away, using another transceiver, and either leave your replies or just clear the available

memories (those you haven't locked out for playback locally) to accept new messages.

Private Station ID Codes

For added security, the DVS-3 remote recording system includes a special private station ID code that is programmable to prevent anyone from accessing messages stored in memories who does not know your ID code. Your ID code may range from 0001 ~ 9999. Once you have selected your ID, be careful who you divulge it to.

To set your ID code:

- From the dial mode, press  to activate the DVS-3, then press  followed by the  button. The display will appear as below, indicating the current ID code (or "0000" if none is stored), with the left most digit blinking.



Rotate the DIAL knob to select the desired digit.

- Press the microphone **UP** button to shift the blinking digit one place to the right.

Repeat the last two steps as necessary to enter the desired 4-digit ID code, then press the  button again to save your entry and return to the original display.

Once you have programmed your ID code, any station calling in with a remote command (when the DVS-3 is set for remote operation) must precede their DTMF command with the ID code you have just stored. Leading zeros are not required, so, for example, if your ID code is 0001, remote commands need only be prefixed by a DTMF "1" digit entry.

Any remote commands received without a valid ID code prefix will be ignored (unless you set the ID code to 0000).

Note: if the remote transceiver is very close to the DVS-3, it may be overloaded by the RF field, which may cause the DVS-3 to shut down (and return to the operating frequency) after responding to a remote command.

In Case of Problems



Don't worry if you find FT-2200 operation somewhat complicated at first. The small number of controls belies the variety of features that are available, and some keys and buttons have more functions than are indicated by their labels. So it is not difficult to get lost, at least until you have had the chance to learn the various functions of the display and keys. This section provides some tips to help you navigate the various display and key modes.

If the display shows nothing at all, push the power switch, and check the power supply connections. Note: In cold climates the display on the Controller Unit may fail to operate in temperatures below $-20\text{ }^{\circ}\text{C}$ ($-4\text{ }^{\circ}\text{F}$).

The state of the display tells a lot (but not all) about the current state of operation. Depending on the options installed, the display can take on many different states.



It is well worthwhile to study the frequency display diagram on page 5 carefully. For exam-

ple, if the frequency display changes unexpectedly when you transmit (or if "Err" appears), check for a small "+" or "-" at the top of the display.

If pressing a button appears to do nothing, first check for "LOCK" at the upper right corner of the display. If you see it, press the  \Rightarrow  to unlock the keys. Otherwise, you can press the  button, which will usually terminate any partially entered commands.



If you still cannot enter data, check to see if the "TX" indicator at the bottom of the display is on, indicating that the transceiver is transmitting. Releasing the PTT switch should return the set to receive. If still nothing happens, switch the transceiver off, and then back on.

As a last resort, if you are unable to gain sensible control of the transceiver, reset the CPU as described in the next section.

To avoid confusion resulting from inadvertent button presses, set the keypad lock on (press  \Rightarrow ) if you leave the transceiver unattended

while it is on. Remember to set the lock back off when you wish to enter data.

Resetting the CPU

Resetting the CPU clears all memories, repeater shifts and other settings to their defaults, and leaves the transceiver CPU in the same state as when it left the factory. To reset the CPU, press *and hold* the  button and  key while switching the transceiver back on.

Memory Backup

Normally, a lithium battery inside the transceiver retains all settings and memories while power is off or disconnected. If this battery ever needs replacing, the transceiver will be found to have lost its memories, although it will still operate properly.

Note!

The control head must be disassembled to access to the battery. It should be replaced only by a Yaesu-authorized technician to ensure that it is installed properly.

Packet Radio TNC Interconnections

Most popular packet radio TNCs can be connected to the microphone jack of the FT-2200 as follows, use shielded cable for the audio lines, and keep the interconnecting cables as short as possible to avoid RF pickup.

"RADIO" jack on TNC	Mic jack on transceiver	Comment
Receiver Audio in	pin 4	8 ohms, de-emphasized
PTT out	pin 6	ground to transmit
Transmit Audio out	pin 8	400 ohms, pre-emphasized

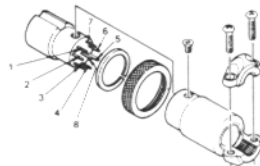
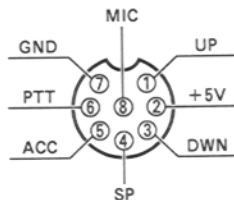

8-pin CONNECTOR

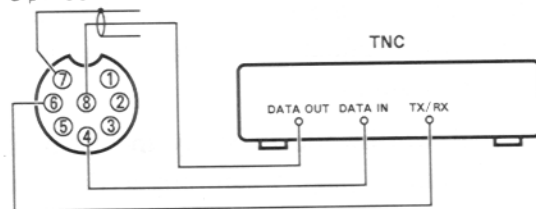

CAT System External Computer Control

The CAT (Computer Aided Transceiver) System in the FT-2200 allows external control of the operating frequency, tx/rx switching, high/medium/low transmit power selection and CTCSS tone frequency and encode/decode status from an external personal computer (CTCSS decoding requires the optional FTS-27 to be installed). An external level converter, such as the FIF-232 Interface Box is required for connection between computer and transceiver.

Serial data is passed at TTL levels (0 and +5VDC) at 4800 bits/sec. from pin 2 or 3 (Tx/D) of the computer RS-232C serial port to pins 1 and 3 of the microphone jack on the front panel of the transceiver, wired as shown below:

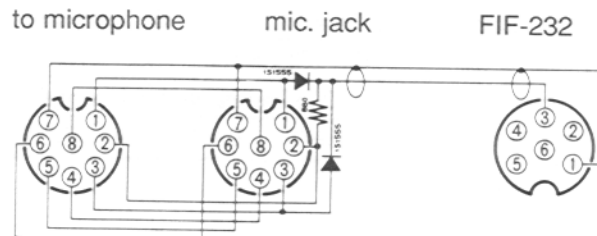

Each data byte sent consists of one start bit, two stop bits and no parity bit:

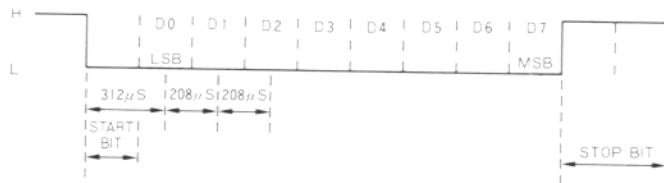

All CAT System data transfers consist of blocks of five bytes as just described, sent with 50 to 200 ms between each byte. The last byte to be sent in each block is the *instruction opcode*, while the first four bytes of each block are *arguments*: either parameters for that instruction, or dummy values (required to pad the block out to five bytes when fewer are needed by the instruction):

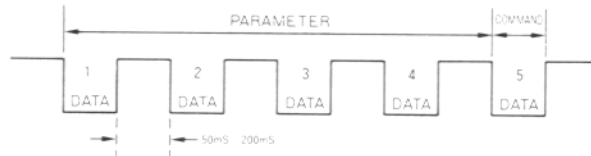

Example: set 145.5000 MHz as the current operating frequency;

- First you must determine the opcode for the desired instruction (see below). These opcodes should be stored in the program so they can be looked up when the user requests the corresponding command.
- In our example the instruction would be “Set Frequency”, so the opcode is 01H. An “H” following each byte value indicates hexadecimal (base 16) values.
- Build the four argument byte values for the desired frequency by breaking it into 2-digit blocks (BCD “packed decimal” format).

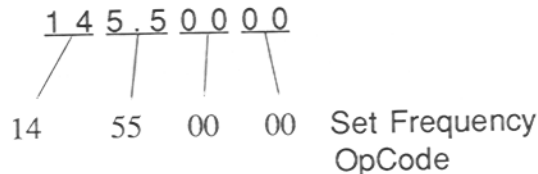

- The resulting 5-byte block should look like this (again, in hexadecimal format):

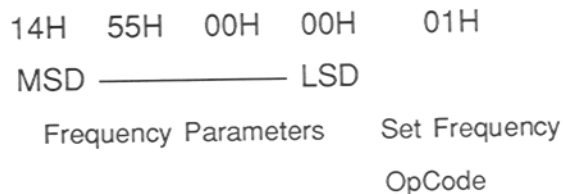

Instruction OpCode Chart

Instruction Description	Parameters				Instruction Code	Remarks
	MSD			LSD		
Set Frequency	(P1)	(P2)	(P3)	(P4)	01H	(P1 ~ P4): eight packed-BCD digits (as explained in text)
Set Power Output	(PO)	●	●	●	18H, 28H or 48H	(PO) 18H = LOW 28H = MID 48H = HIGH
Tx/Rx (PTT)	(PTT)	●	●	●	08H or 88H	(PTT) 08H = Transmit 88H = Receive
Set CTCSS Tone Frequency	FAH	(TC)	●	●	FAH	(TC) CTCSS Tone Code (see chart on next page)
Set CTCSS Tone ENC/DEC	(TN)	●	●	●	8AH, 4AH or 8AH	(TN) 8AH = OFF 4AH = ENC 8AH = ENC/DEC

“ ● ” denotes padding bytes: any value is acceptable(see text).

- Send these five bytes to the transceiver, *in reverse order from that shown above* — from right-to-left (from LSD to MSD).

There are five instruction opcodes for the FT-2200, as listed in the table on the previous page. Notice that some instructions require no specific parameters, but *every* Command Block sent to the radio *must consist of five bytes*. The unused parameter bytes (“dummy” or “padding” bytes) will be ignored when such instructions are executed,

so their values are irrelevant (they need not be zeros).

The CAT control program in the computer must construct the 5-byte block by selecting the appropriate instruction opcode, organizing the parameters, if any, and providing “dummy” argument bytes for padding. The resulting five bytes are then sent, *opcode last*, to the SI serial input (pins 1 & 3) on the microphone jack of the transceiver.

CTCSS Tone Hex Value Table

Tone (Hz)	Value(Hex)	Tone(Hz)	Value(Hex)	Tone(Hz)	Value(Hex)
67.0	3F	103.5	1C	162.2	06
69.3	39	107.2	0C	167.9	15
71.9	1F	110.9	1B	173.8	05
74.4	3E	114.8	0B	179.9	14
77.0	0F	118.8	1A	186.2	04
79.7	3D	123.0	0A	192.8	13
82.5	1E	127.3	19	203.5	03
85.4	3C	131.8	09	210.7	12
88.5	0E	136.5	18	218.1	02
91.5	3B	141.3	08	225.7	11
94.8	1D	146.2	17	233.6	01
97.4	3A	151.4	07	241.8	10
100.0	0D	156.7	16	250.3	00

Installation of Options

This section describes the installation procedures for the DVS-3 Digital Voice Recorder and FTS-27 Tone Squelch Unit. These options are both available from your Yaesu dealer. If installing both the FTS-27 and the DVS-3, *install the DVS-3 first*. The DVS-3 enables recording and playback of received signals and messages for transmission. See the “*Digital Voice Operation*” chapter for details.

DVS-3 Digital Voice Recorder Unit Installation

- Disconnect the DC power cable, and set the transceiver upside-down. Referring to Figure 1, remove the four screws affixing the bottom cover, loosen the four side screws and remove the cover.
 - Lift the speaker out of its bracket, remove the screw attaching the speaker bracket to the chassis, then set the bracket and speaker aside for now. Referring to Figure 2, note the accessory mounting location. If the FTS-27 is already installed, *carefully and gently* pry the unit (with its adhesive tape) from the top of the VCO can and place it to the side.
- Refer to Figure 3 for the location of the three connectors used by the DVS-3 (the two larger plugs go to connectors on the front control unit, the smaller plug on the main unit). Connect the cables from the DVS-3 to these connectors carefully, so as not to install the plugs upside down.
 - If a FTS-27 is already installed, it should be placed in the bare area on the DVS-3 board at this time as shown in figure 4.
 - Position the DVS-3 as shown in Figure 5, and use the supplied screw to fix it in place. Replace the loudspeaker and its bracket, the top cover, and four screws.

Figure 1.

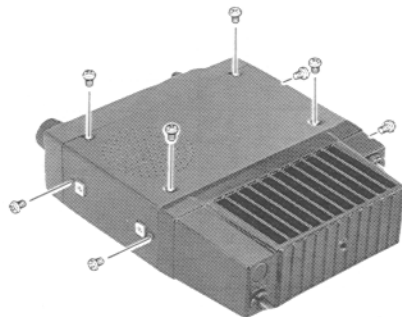

Figure 2.

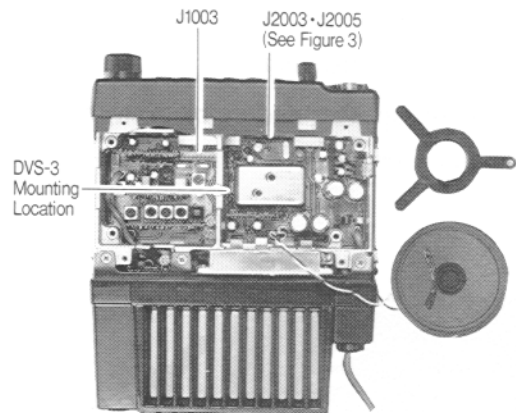

Figure 4.

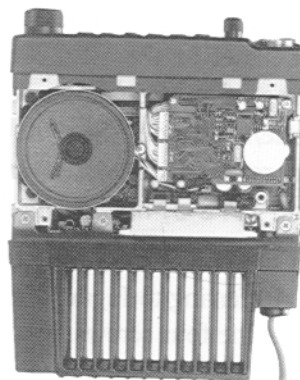

Figure 3.

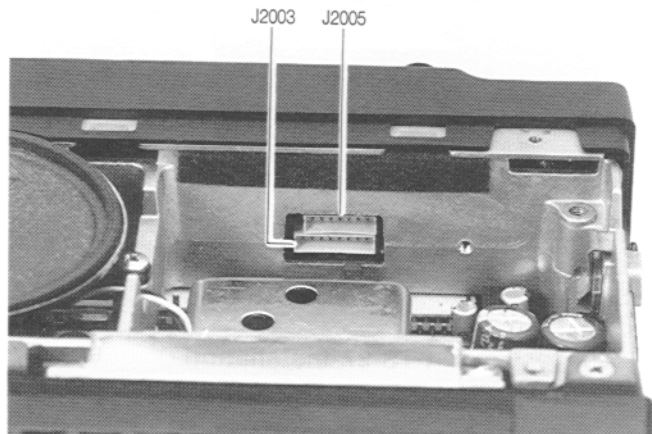
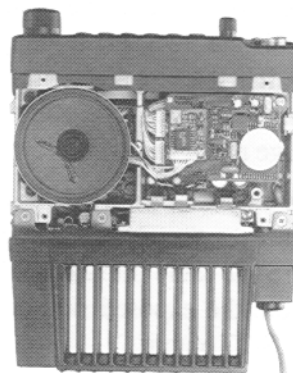

Figure 5.



FTS-27 Tone Squelch Unit Installation

The FTS-27 includes a decoder for 38 EIA standard subaudible CTCSS tones, programmable from the front panel of the FT-2200. It provides silent monitoring of busy channels when activated by the **ENCode/DECCode**. See the “*Operation*” chapter for operational details. If installing both the FTS-27 and DVS-3, *install the DVS-3 first*.





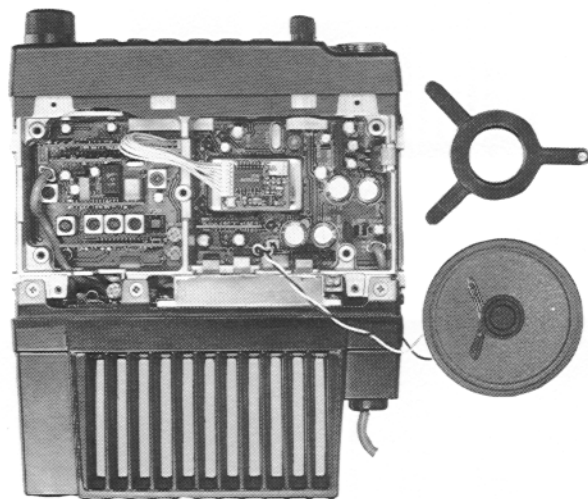





- Disconnect the power cable, and turn the set upside-down. Referring to Figure 1 on the previous page, remove the four screws affixing the bottom cover, loosen the four side screws and remove the cover.
- Referring to Figure 2, locate the unused 12-pin connector J1003 inside the front panel. Peel the covering from one side of the double-sided tape provided with the FTS-27, if the DVS-3 is installed, stick it in the bare area on the DVS-3 board (fig. 4), otherwise place it on the top of the VCO housing (large metal can).
- Note in the figure at the right how the FTS-27 cable routes over the chassis compartmentation. Plug the FTS-27 cable into J1003. Then peel the covering from the exposed side of the tape, and press the FTS-27 onto it.

- The factory adjusts the output tone level (VR1 on the FTS-27) for the proper deviation, so it should require no further adjustment.
- Replace the loudspeaker and its bracket, the top cover, and four screws.



FTS-27 Installation

FT-2200 Quick Reference Guide

Button	Direct (Normal) Function	1st-level function - after pressing  => (" F " displayed for 5 seconds)	2nd-level function - after pressing [] => (memory box blinks)
	Switch transceiver ON/OFF	same as Normal Function	same as Normal Function
	Toggle Dial/Memory Modes	Memory Channel Skip/Reset	none
	Toggle CALL Channel	Display DTMF Autodial Memory Settings	Toggle CALL Channel
	Dial Mode: Toggle 1\10—MHz tuning steps Memory Mode: Enable Memory Tuning	Toggle Priority Channel Monitoring	Display Time-Out Timer (TOT) Settings
	Toggle High/Medium/Low Transmit Power	Enable/Disable Front Panel Controls (lock)	none
	Momentary: enables alternate functions of other keys. Hold > 1/2 sec. to select memory for storage, and press again to store.	none	none
	Enables DVS operation/Display DVS Settings	Enables/Disable CTCSS Bell Paging " " displayed	none
	Selects DTMF Paging, DTMF Code Squelch and Trigger Paging Operation	Displays Page Code Memories and Settings	Displays Alert Ringer Settings

Button	Direct (Normal) Function	1st-level function - after pressing [F/W] ⇒ (" F " displayed for 5 seconds)	2nd-level function - after pressing [F/W] ⇒ (memory box blinks)
R.SET RPT	Select Repeater Shift (-/+)	Display/change standard repeater offset	none
T.SET TO	Select CTCSS Tone encode and decode (with FTS-27 installed), " ENC " & " DEC " displayed.	Display/select CTCSS Tone Frequency (39 EIA-Standard Tones (67.0 – 250.3-Hz)	none
STEP REV	When a repeater offset is active, reverses TX/RX frequencies (RX on repeater input).	Display/select frequency tuning steps (5, 10, 12.5, 15, 20, 25 and 50-kHz) and Scan Resume Mode: " 5 " - timed 5-sec. or " 5 " - Carrier resume.	Masks a currently selected memory channel from operation, otherwise, no function.

Power-on Functions

Hold the following key(s) while turning the transceiver ON. Repeating the sequence will disable the function.	Function
[F/W] ⇒ POWER	LCD check, all LCD indicators and readouts are displayed (blinking).
[BELL DVS] + [C.SET PAGE] ⇒ POWER	Memory-only Mode, regular display is replaced with large memory channel indication, and previously programmed channel settings (see page 37 for details).
[D/MR SKIP] + [STEP REV] ⇒ POWER	CPU reset, erases ALL programmed settings and returns radio to factory default state (see page 45).