

# ICF-SW1000T

## SERVICE MANUAL

US Model  
Canadian Model  
AEP Model  
UK Model  
E Model  
Tourist Model



Model Name Using Similar Mechanism	WM-EX606
Tape Transport Mechanism Type	MT-WMRX707-60

### SPECIFICATIONS

#### Radio section

Circuit system

FM: Super heterodyne

AM: Dual conversion super heterodyne

Frequency range

Band	Italy model	Saudi Arabia model	Other model
FM	87.5-108.0 MHz	87.5-108.0 MHz	76.0-108.0 MHz
SW	3850-26100 kHz	1621-26100 kHz	1621-29999 kHz
MW	530-1620 kHz	530-1620 kHz	530-1620 kHz
LW	150-285 kHz	150-285 kHz	150-529 kHz

Intermediate frequency

FM: 10.7 MHz

SW/MW/LW: 55.845 MHz (1st)  
455 kHz (2nd)

#### Cassette-Corder

Track system

Compact cassette stereo

Frequency response

Playback: 20-18,000 Hz

Recording/Playback: 70-8,000 Hz

#### General

Speaker

Approx. 45 mm (1 13/16 inches) diameter, 8 ohms,  
one speaker system

Maximum output

250 mW (at 10% harmonic distortion)

Power requirements

RADIO BATT: DC 3 V, two R6 (size AA)  
batteries

TAPE BATT: DC 1.5 V, one R6 (size AA) battery

External power source

DC 3 V

Output

One  $\phi$  (headphones) jack (stereo minijack)  
16 ohms

Input

One mixing microphone input jack (stereo  
minijack)

Dimensions

Approx. 176×105×40 mm (w/h/d)  
(7×4 1/4×1 5/8 inches incl. projecting parts)

Mass

Unit approx. 464 g (1 lb 0.4 oz)  
Approx. 593 g (1 lb 4.9 oz) incl.  
alkaline batteries, C-60HF tape,  
headphones, and strap

FM STEREO/SW/MW/LW  
PLL SYNTHESIZED RECEIVER  
STEREO CASSETTE-CORDER  
**SONY**<sup>®</sup>

## TABLE OF CONTENTS

### Supplied accessories

- Stereo headphones (1)
- Ear pads (2)
- Stereo microphone (1)
- Compact antenna (1)
- Antenna connector (1)\*1
- Carrying case (1)
- Hand strap (1)
- Wave Handbook (1)\*2
- Shortwave Guide (1)\*1
- Batteries (3)\*1

Your dealer may not handle some of the above listed optional accessories. Please ask your dealer for detailed information on the optional accessories available in your country.

Design and specifications are subject to change without notice.

\*1For the World model only.

\*2Not applicable for the Saudi Arabian model.

\*3For the Saudi Arabian model only.

<u>Section</u>	<u>Title</u>	<u>Page</u>
<b>1.</b>	<b>SERVICING NOTE</b> .....	3
<b>2.</b>	<b>GENERAL</b>	
	Location of controls .....	5
	Inserting the batteries .....	7
	Setting the clock .....	8
	Listening to the radio – Scan tuning .....	8
	Playing a cassette .....	9
	Recording radio broadcasts .....	10
	Various tuning methods for optimum reception .....	11
	Receiving SSB and CW transmissions .....	14
	Receiving optimum AM broadcast – Synchronous detection .....	14
	Changing the MW channel step for use in foreign countries .....	15
	Connecting an external antenna for optimum reception .....	15
	Recording with a microphone .....	16
	To wake up to the desired broadcast – Standby function .....	17
	To fall asleep while listening to the desired broadcast – Sleep timer .....	18
	To record the desired broadcast with the timer – Timer recording .....	19
	Using the hold function to prevent accidental operation .....	20
	Attaching the strap .....	20
	Replacing the batteries .....	21
	Operating with house current or car battery .....	21
<b>3.</b>	<b>DISASSEMBLY</b> .....	22
<b>4.</b>	<b>MECHANICAL ADJUSTMENT</b> .....	25
<b>5.</b>	<b>ELECTRICAL ADJUSTMENTS</b> .....	25
<b>6.</b>	<b>DIAGRAMS</b>	
6-1.	Printed Wiring Board –Tuner Section .....	32
6-2.	Schematic Diagram –Tuner Section .....	37
6-3.	Schematic Diagram –Deck Section .....	42
6-4.	Printed Wiring Board –Deck Section .....	45
6-5.	Schematic Diagram –Control Section .....	48
6-6.	Printed Wiring Board –Control Section .....	51
6-7.	IC Pin Function Description SIGNAL Board IC201 $\mu$ PD1724GB-687-1A7 (PLL SYNTHESIZER CONTROLLER) .....	55
	MICROCOMPUTER Board IC701 $\mu$ PD753012GC- E05-3B9(SYSTEM CONTROLLER, LCD DRIVE, KEY CONTROL) .....	57
<b>7.</b>	<b>EXPLODED VIEWS</b> .....	59
<b>8.</b>	<b>ELECTRICAL PARTS LIST</b> .....	63

## SECTION 1 SERVICING NOTE

Hall element H501 mounted on the MD board is used to detect rotation of the reels. Because it is mounted on the MD board, when the MD board is being removed, rotation of the reels cannot be detected and the auto-off/tape-end detector circuit does not operate correctly.

Switch S502 (for N/R and FF/REW) is also mounted on the MD board. Therefore, without the MD board, the head cannot be placed in playback position, and power cannot be supplied to the circuitry of the playback system.

When the MD board is being removed, follow the procedures below, in order to check operation of the mechanisms of the tape deck and to check voltages supplied to each circuit.

**NOTE:**

Do not change the setting position of switch S502 when removing the MD board. If it has been changed accidentally, or if the desired mode cannot be set with the switch, adjust the setting again after the MD board is installed.

**FF/REW mode**

- (1) Apply a square wave signal or a sine wave signal to hall element H501. (See the figure on the below.)
- (2) Press the STOP switch for selecting STOP mode.
- (3) Press the FF or REW switch.
- (4) Remove the MD board.

**PLAY mode**

- (1) Apply a square wave signal or a sine wave signal to hall element H501. (See the figure on the below.)
- (2) Press the STOP switch for selecting STOP mode.
- (3) Press the PLAY switch. With the MD board installed, pressing the PLAY switch selects the FWD or REV mode alternatively.
- (4) Remove the MD board.

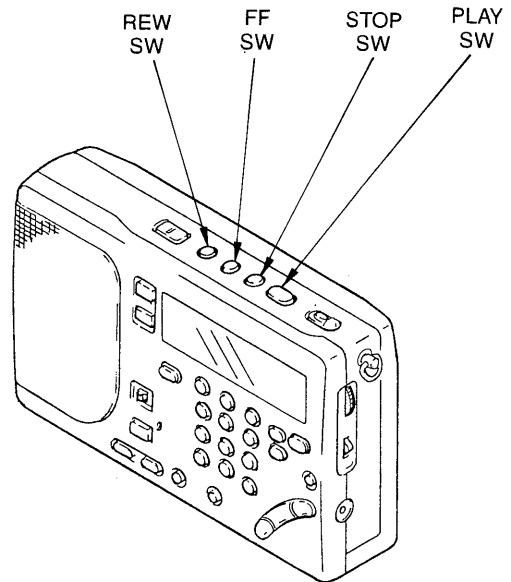

FRONT CABINET

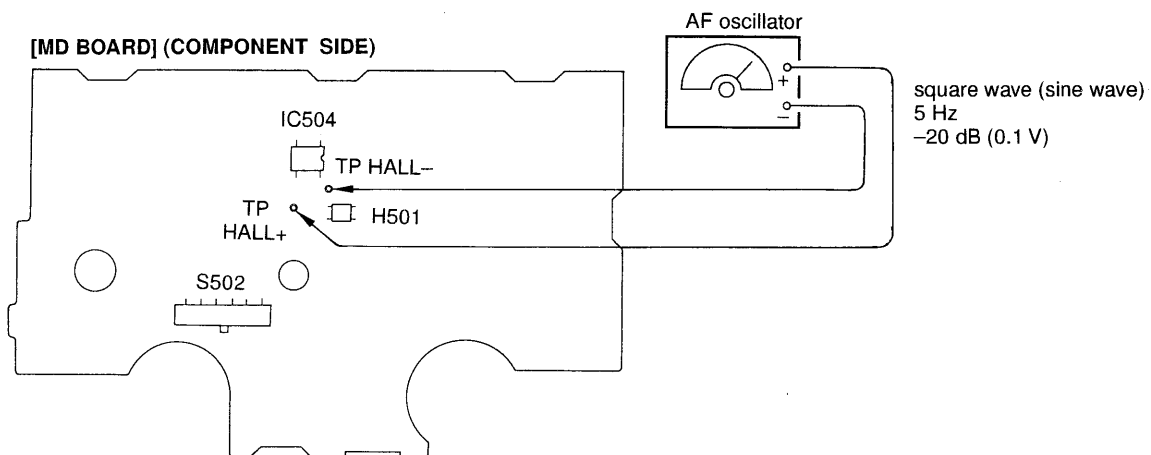

**Function of the lever and rotating mechanisms for mode selection**

- Mode selection starts when the motor rotates reversely.
- Change lever (B) moves to the left or right when driven with the gear (cam).
- The switch set position of switch S502 (4-position switch) is determined in accordance with the position of Change lever (B). When the switch set position is set appropriately, the motor rotates normally and the tape starts moving.

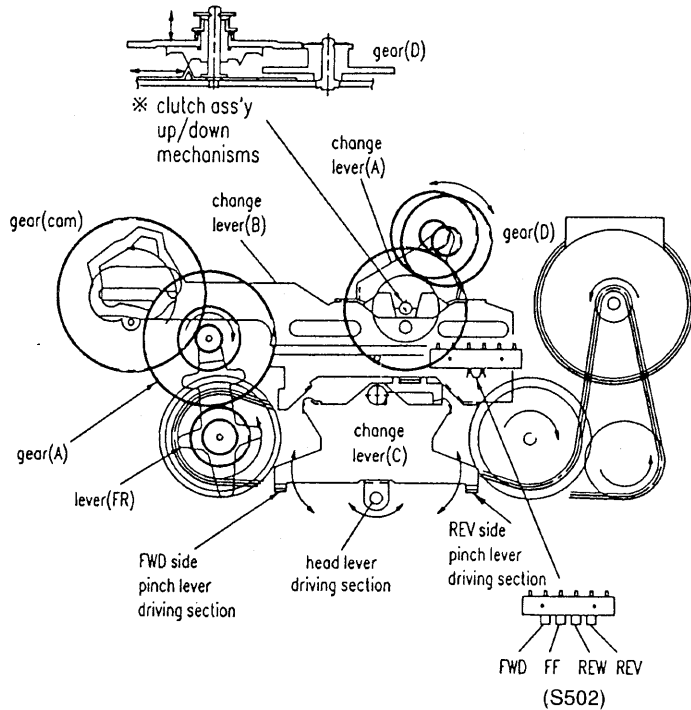

- Lever (FR) is driven with gear (A) by friction, and it swings to the left or right depending on the rotating direction of the motor.
- Selector levers (A) and (C) also swing to the left or right in accordance with the movement of change lever (B), and the clutch assembly moves upward or downward accordingly.
- The pinch roller is activated and the head is placed in playback position with selector lever (C).
- When the mode is switched from one mode to another, the pinch roller is activated while the motor is rotating reversely (for a short period of time), causing a little slackness in the tape transport.

**1. Rotating Mechanisms In PLAY Mode**

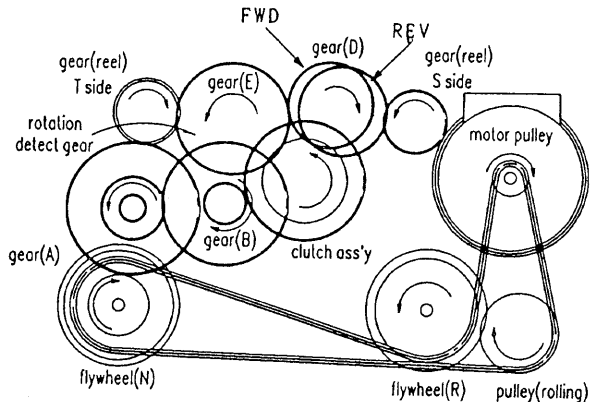

**2. Rotating Mechanisms in FF, REW Mode**

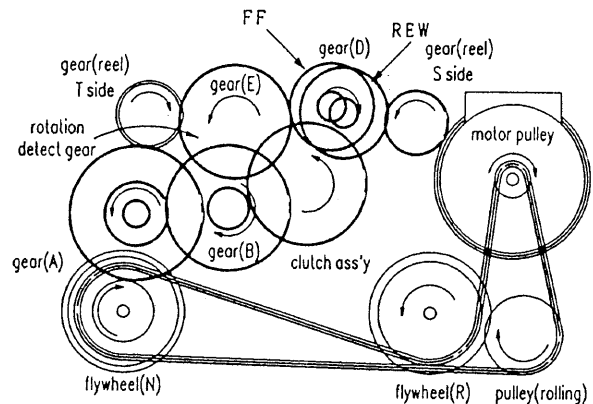

## Location of controls

Refer to the pages indicated in ( ) for details.

Front

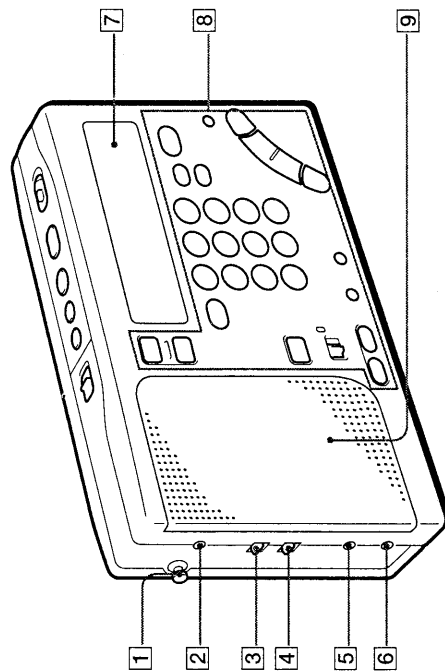

- 1 Telescopic antenna (9)
- 2 EXT ANT jack (22)
- 3 SENS DX•LOCAL (FM/AM sensitivity) selector (9)
- 4 ST•MONO (stereo/monaural) selector (9)
- 5 MIC jack (25)
- 6 ⌋ (headphones) jack
- 7 Display
- 8 Control panel
- 9 Speaker

Rear

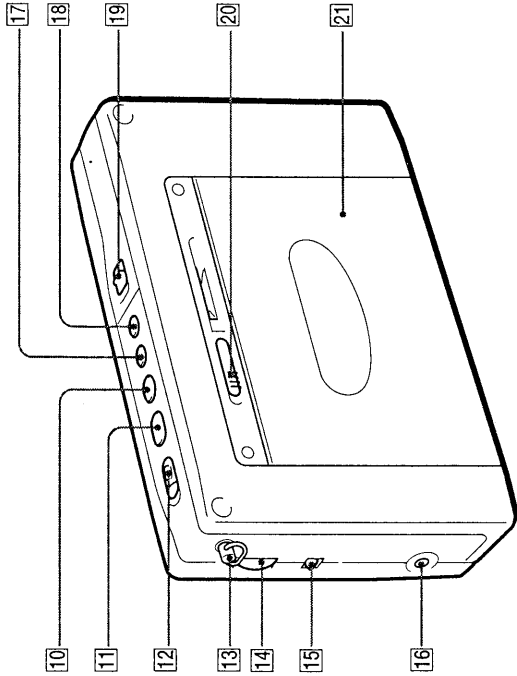

- 10 ■ (stop) button (10, 11)
- 11 ◀▶ (play) button (10, 11)
- 12 REC (record) switch (13)
- 13 Hand strap retainer (33)
- 14 VOLUME control (9)
- 15 TONE selector (9)
- 16 DC IN 3V ⚡ (external power input) jack (35)
- 17 FF (fast forward) button (11)
- 18 REW (rewind) button (11)
- 19 HOLD switch (32)
- 20 ◁ OPEN (cassette compartment opener) control (10)
- 21 Cassette compartment

## SECTION 2 GENERAL

This section is extracted from instruction manual.

### Control panel

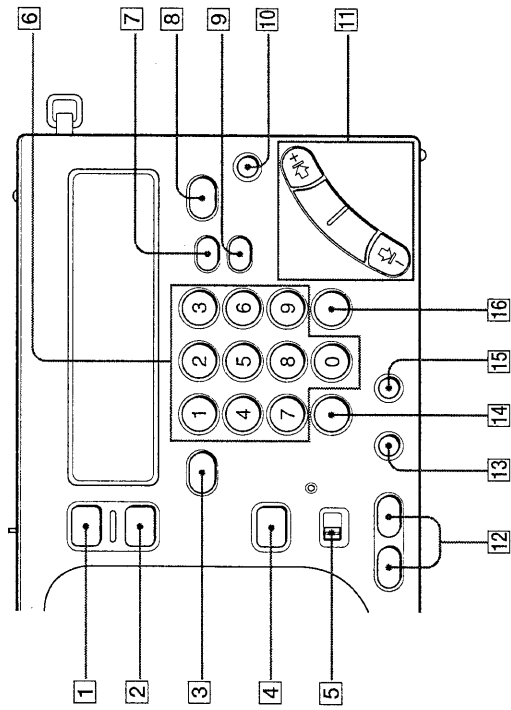

- 1 RADIO POWER ON/OFF button (8)
- 2 SLEEP button (29)
- 3 FM/AM button (8)
- 4 STANDBY ON/OFF button (27)
- 5 MODE selector (28)
- 6 MEMORY PRESET/DIRECT TUNE numeric buttons (16, 17)
- 7 SYNC (Synchronous detection) button\*1(20)
- 8 PAGE button (17, 18)
- 9 SSB (Single Side Band) button\*2(19)
- 10 LIGHT button  
Press this button to turn on the light for about 20 seconds for display viewing in the dark.
- 11 MANUAL TUNE/SCAN•STANDBY TIME SET/ TIME SET buttons (8)
- 12 STANDBY MEMORY•STANDBY TIME SET buttons (27, 30)
- 13 ENTER•TIME SET button (7, 17)
- 14 DIRECT button (16)
- 15 AM BAND button (8)
- 16 EXE•DISPLAY button (7, 16)  
Press this button to display the clock while operating the radio or cassette.  
Press again to return to the previous display.

\*1 SYNC U button for the Saudi Arabian model.

\*2 SYNC L button for the Saudi Arabian model.

### Base

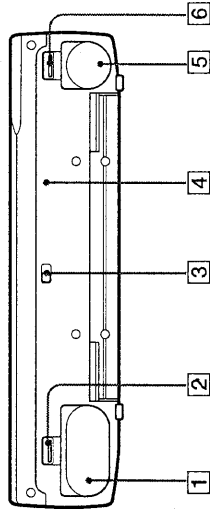

- 1 RADIO BATT battery holder (6)
- 2 OPEN (RADIO BATT opener) control (6)
- 3 ISS (AM interference suppression) selector (13)
- 4 RESET button  
Press this button with a pointed object when the unit fails to function properly. When this button is pressed, the preset broadcast stations and the clock settings are erased.
- 5 TAPE BATT battery holder (6)
- 6 OPEN (TAPE BATT opener) control (6)

# Inserting the batteries

Insert the batteries to operate the unit with batteries.  
Insert the batteries into both battery holders when using the cassette.

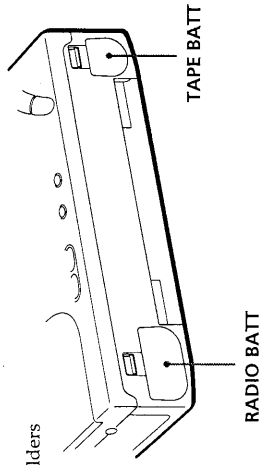

To operate the unit with house current or car battery, refer to "Operating with house current or car battery" on page 35.

- 1 Push the OPEN tabs and remove the RADIO BATT and TAPE BATT battery holders.

- 2 Insert two R6 (size AA) batteries into the RADIO BATT battery holder and insert one R6 (size AA) battery into the TAPE BATT battery holder.

**Note**  
It is not necessary to insert a battery into the TAPE BATT battery holder if you wish to operate the radio only. However, to use the cassette, insert the batteries into both the RADIO BATT and TAPE BATT battery holders. Otherwise, the unit may not operate properly.

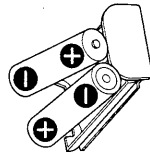

Insert with the correct ⊕⊖ polarity as indicated.

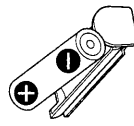

- 3 Insert both battery holders back into the unit.

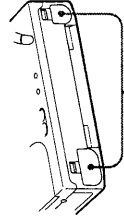

Insert until it clicks.

## Display

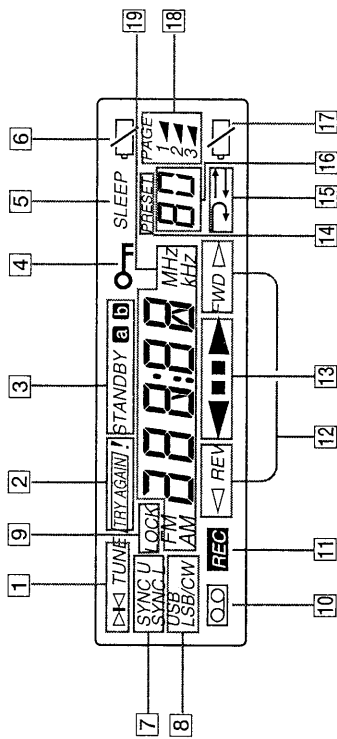

- 1 TUNE indicator (16)  
Appears when a broadcast station is tuned.
- 2 TRY AGAIN! indicator (16, 21)  
Flashes when an invalid MW tune interval or an invalid frequency (direct tuning) is entered.
- 3 STANDBY **a** / **b** indicators (27, 30)  
Appear when the standby function is operational.
- 4 HOLD indicator (32)  
Appears when the HOLD function is operational. All buttons will be locked and will not be operational.
- 5 SLEEP indicator (29)  
Appears when the sleep timer is operational.
- 6 (low radio batteries) indicator (34)
- 7 SYNC U / SYNC L (synchronous detection) indicators (20)
- 8 USB / LSB / CW (single side band / continuous wave) indicators\* (19)
- 9 LOCK (synchronous detection) indicator (20)  
Appears when synchronous detection mode is operational.
- 10 (cassette) indicator  
Appears when a cassette is inserted.
- 11 REC (record) indicator
- 12 REV / FWD  $\triangleleft$  /  $\triangleright$  (tape direction) indicators (10)
- 13 REV appears when the current tape direction is the side facing the unit (reverse side). FWD  $\triangleright$  appears when the current tape direction is the side facing the cassette compartment cover.
- 14 (tape operation) indicators
- 15 PRESET indicator
- 16  $\rightarrow$  /  $\leftarrow$  (playback / recording mode) indicators (10)
- 17 Preset number / sleep duration display (17, 18, 29)
- 18 (low tape battery) indicator (34)
- 19 PAGE (page number) indicators (17)
- Frequency / time / tape operation display

\* Not applicable for the Saudi Arabian model.

## Setting the clock

Set the clock when you initially insert the batteries or when the clock is reset at which time "0:00" flashes.

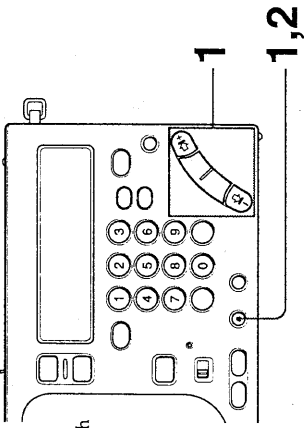

- 1 Press and hold **TIME SET • ENTER** while pressing **HOUR** or **MIN** repeatedly until the correct time is displayed.

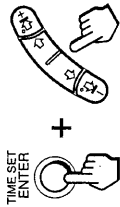

Each time **MIN** ( $\leftarrow$  or  $\rightarrow$ ) is pressed, the minute will decrease ( $\leftarrow$ ) or increase ( $\rightarrow$ ) by one minute. Each time **HOUR** ( $\leftarrow$  or  $\rightarrow$ ) is pressed, the hour will decrease ( $\leftarrow$ ) or increase ( $\rightarrow$ ) by one hour.

Press and hold the button to decrease or increase rapidly.

2

Release **TIME SET • ENTER**.

The " " starts flashing and the clock operates.

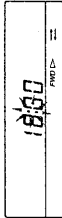

### Tips

- The clock is displayed in 24-hour indication.
- Press **TIME SET • ENTER** to stop the flashing of "0:00".
- To set the clock accurately, release **TIME SET • ENTER** at the time of the tone.

### To display the clock

Press **EXE** to display the clock while operating the radio or the cassette. The current time appears for about 10 seconds and then the previous display returns. However, the clock cannot be displayed while scan tuning.

While the clock is displayed, press **EXE** again to return to the previous display.

### Note

You cannot set the clock while operating the radio or the cassette.  
Press **RADIO POWER ON/OFF** to turn off the radio, or press **■** to stop the tape.

## Listening to the radio—scan tuning

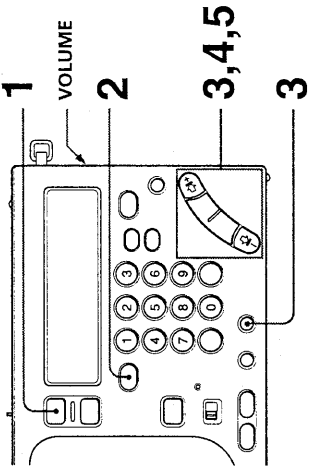

To manually tune in to the desired broadcast station, refer to "Manual tuning" on page 14.

To immediately tune in to the desired broadcast station, refer to "Direct tuning" on page 16.

To preset a broadcast station for instant recall, refer to "Preset tuning" on page 17.



- 1 Press **RADIO POWER ON/OFF**.  
The radio turns on.

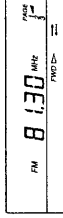

- 2 Press **FM/AM** to select either **FM** or **AM**.  
Select **AM** to listen to **SW, MW** or **LW**.

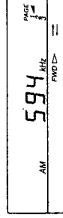

3

When you select **AM**, press  $\leftarrow$  or  $\rightarrow$  while pressing **AM BAND** to select **MW, LW**, or meter band (**SW**)\*.

Skip this step and proceed to step 4 if you wish to listen to **FM**.

\* For details on the meter band, refer to "Meter bands and SW" on page 15.

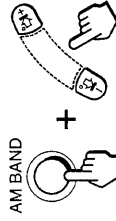

The minimum frequency allocation for each band is displayed.

4

Press and hold  $\leftarrow$  or  $\rightarrow$  and release when scanning of the frequency begins.

When a broadcast station is received automatically, scanning pauses for about 2 seconds. Then, scanning resumes to tune in to the next broadcast station.

Scanning repeats in a cycle within the meter band frequency range (see page 15). Scanning during **SSB** reception repeats in a cycle within the **150-29999 kHz frequency range**.\*

\* Not applicable for the Saudi Arabian model.



5

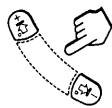

Press  $\leftarrow$  or  $\rightarrow$  to stop scanning and to listen to the currently tuned broadcast station.

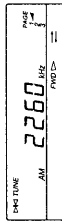

**Tips**

- To enjoy FM stereo reception, plug the stereo headphones. Set ST • MONO to ST or MONO to select stereo or monaural reception as necessary.
- When listening to news, set TONE to NEWS for optimum results. Vocal output will be sharper and clearer. When listening to music, set to MUSIC for optimum results.
- During MW reception at nighttime when radio wave intensity is dramatically stronger, or when interference is prevalent, scanning may tend to tune in to almost every null broadcast. Set SENS to LOCAL so that the null broadcast of weaker radio wave intensity is skipped. Under normal conditions, set to DX.

**Note**

When reception does not improve, connect an external antenna (see page 22).

**Other operations**

To	Press or turn
Fine tune the reception	$\leftarrow$ , $\rightarrow$ , $\leftrightarrow$
Adjust the volume	VOLUME
Turn off the radio	RADIO POWER ON / OFF

**To improve reception**

- For FM reception**  
Gently pull out the telescopic antenna and adjust the length, angle and direction to obtain optimum reception.
- For MW/LW reception**  
Retract the telescopic antenna and rotate the unit to reorient the built-in ferrite bar antenna to obtain optimum reception.
- For SW reception**  
Gently pull out the telescopic antenna to its full length and set vertically to obtain optimum reception.

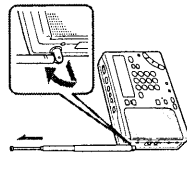
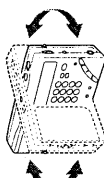
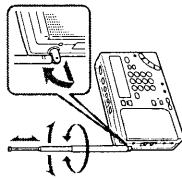

**Playing a cassette**

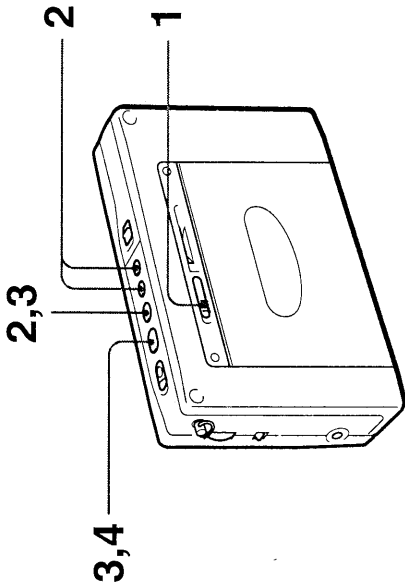

1

Slide OPEN and insert a cassette. Remove the slack of the tape and insert the cassette with the exposed side facing down.

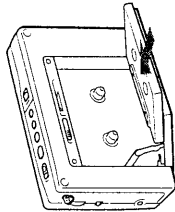
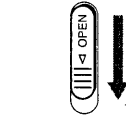

2

Select whether you wish to play one side or both sides of the cassette.

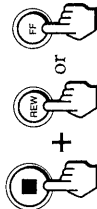

To play one side: Press FF while pressing  $\blacksquare$ .  
To play both sides: Press REW while pressing  $\blacksquare$ .

3

Press  $\blacktriangleleft$  while pressing  $\blacksquare$  to select the side you wish to play.

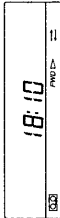
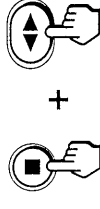

To play the side facing the cassette holder (forward side): Display "FWD  $\blacktriangleleft$ ".  
To play the side facing the unit (reverse side): Display " $\blacktriangleleft$  REV".

4

Press  $\blacktriangleleft$ .

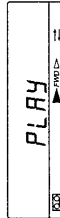

# Recording radio broadcasts

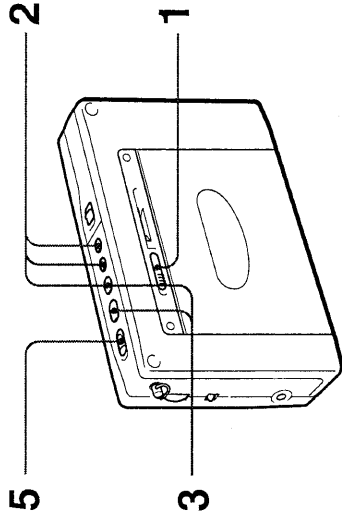

To record with a microphone, refer to "Recording with a microphone" on page 25.

## Tips

- To enjoy stereo-recorded cassettes, plug the stereo headphones. Set ST • MONO to ST or MONO to select stereo or monaural as necessary.
- The ATS (Auto Tape Selector) function automatically determines and selects the type of cassette you wish to use for playback only: Normal or CrO<sub>2</sub>/Metal cassette.

## Note

The reverse side only is played when playback begins from the reverse side of the cassette.

## Other operations

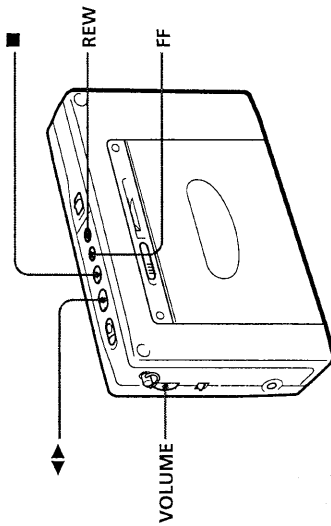

To	Press or turn
Adjust the volume	VOLUME
Switch the playback side	◀▶ during playback
Stop playback, FF, REW, and REC	■
Fast forward	FF during stop
Rewind	REW during stop
Fast forward while monitoring the sound (cue)	FF during playback
Rewind while monitoring the sound (review)	REW during playback

## 1

Slide OPEN and insert a cassette.

### Note

Before inserting a cassette, make sure that the cassette tab is not broken off. A cassette with a broken tab cannot be recorded.

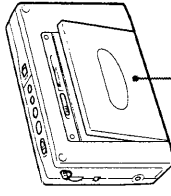
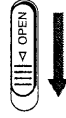

Insert the cassette with the side you wish to record facing the cassette holder.

## 2

Select whether you wish to record one side or both sides of the cassette.

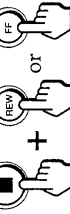

To record one side: Press FF while pressing ■.

To record both sides: Press REW while pressing ■.

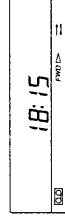

◀▶: Records one side.  
▶: Records both sides.

## 3

Press ◀▶ while pressing ■ to display "FWD ▶".

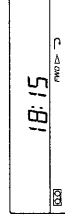
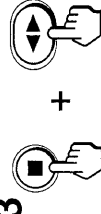

## 4

Tune in to the desired broadcast station you wish to record. Refer to pages 8 and 14-18.

# Various tuning methods for optimum reception

## Manual tuning

Use  $\leftarrow$   $\rightarrow$  and  $\Rightarrow$   $\Leftarrow$  search for the desired broadcast station. Use the outer buttons to search rapidly in large frequency increments. Use the inner buttons to search precisely in small frequency increments.

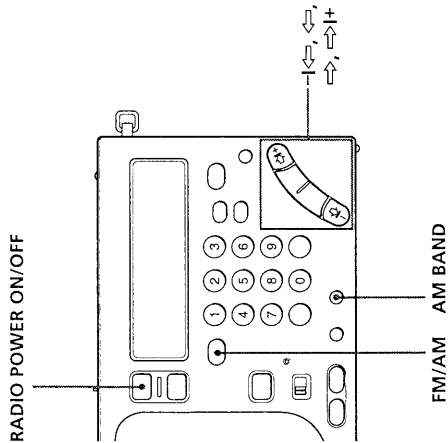

Press the red button in the center and slide REC.



After a few seconds, the frequency is displayed.

### To stop recording

Press ■.

### To record the side facing the unit (reverse side)

Insert the cassette with the side you wish to record facing the unit (reverse side). Press  $\blacktriangleleft$  while pressing ■ to display "REV".

Recording stops on the side facing the unit regardless of whether one side or both sides is selected.

### To record an FM stereo broadcast

Set ST • MONO to ST or MONO to select stereo or monaural recording as necessary.

### To improve AM reception for recording

When recording an AM broadcast, the reception may contain noise interferences that were not present prior to recording. In this case, set ISS on the bottom of the unit to the position (1, 2 or 3) in which noise interferences are minimal to obtain optimum reception for recording.

### To protect your important recorded cassettes

Break off the cassette tab of side A or B to prevent accidental recording of your important cassettes. If you wish to use the cassette for recording again, cover the opening of the broken tab with adhesive tape.

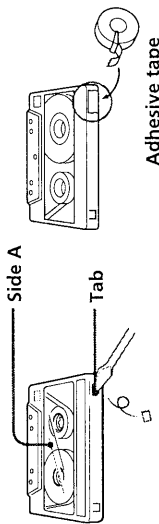

Adhesive tape

"REV" flashes when recording is attempted on a cassette with a broken tab. A cassette with a broken tab cannot be recorded.

## 5

### Tips

- Adjusting VOLUME and TONE does not affect the sound to be recorded.
- Speaker output is monaural when recording. To enjoy FM stereo reception, plug the stereo headphones.
- Recording stops automatically when RADIO POWER ON/OFF is pressed to turn off the radio.

### Notes

- Use Type I (normal) cassettes only for recording. Playback may be distorted or a segment may not be erased completely when a CrO<sub>2</sub> or metal cassette is used.
- Recording with weak batteries generates unnecessary noise and produces unsatisfactory recordings. In this case, replace the batteries with new ones.
- Operate REC approximately 2 seconds prior to the point you wish to begin recording. If not, the leading segment may not be recorded.
- Switching the recording side is not possible when  $\blacktriangleleft$  is pressed during recording.
- The buttons for the radio are operational while recording. To prevent accidental operations, use the hold function (see page 32).

### Tips

- The previously tuned broadcast station is received when you turn on the radio.
  - When  $\leftarrow$  or  $\rightarrow$  is pressed repeatedly in the AM band (MW, SW, and LW), the frequency repeats through the range of 150-29,999 kHz to enable search of all available broadcast stations (not applicable for the Saudi Arabian model\*1).
  - For the Saudi Arabian model when  $\leftarrow$  or  $\rightarrow$  is pressed repeatedly in the AM band (MW, SW, and LW), the frequency repeats through the ranges of 150-285 kHz and 530-26,100 kHz.
- Turn on the radio.
  - Select either FM or AM. Select AM to listen to SW, MW or LW.
  - When you select AM, press  $\leftarrow$  or  $\rightarrow$  while pressing AM BAND to select MW, LW or meter band (SW). Skip this step and proceed to step 4 if you wish to listen to FM.
  - Press  $\leftarrow$ ,  $\rightarrow$ ,  $\Rightarrow$ , and  $\Leftarrow$  repeatedly to search for the desired broadcast station. Each time the buttons are pressed, the channel step changes as shown below.

Band	$\leftarrow$ or $\Rightarrow$ H	$\leftarrow$ or $\rightarrow$
FM	0.05 MHz	0.05 MHz
SW	5 kHz	1 kHz
MW	9/10 kHz	1 kHz
LW	9 kHz	1 kHz
SSB (AM)*2	1 kHz	0.1 kHz*1

\*2 Not applicable for the Saudi Arabian model.  
\*3 Units of 0.1 kHz is not indicated in the display.

## Various tuning methods for optimum reception (continued)

### Direct tuning

When the desired broadcast station is known, enter the frequency with the numeric buttons for immediate selection.

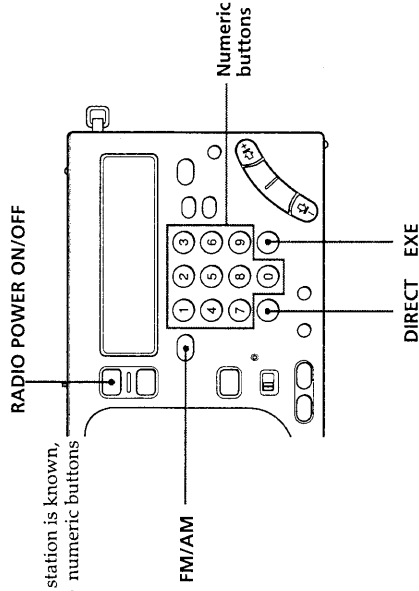

### Tips

- When you have entered the wrong frequency, in step 4, press **DIRECT** to cancel the current entry and enter the correct frequency.
  - "TRY AGAIN!" flashes when the frequency entered is invalid and beyond the allocated frequency range for reception. Check and make sure that the frequency is valid and repeat from step 3 again.
  - The minimum digit entry is 0.05 MHz (50 kHz) for the FM band, and 1 kHz for the AM band.
- 1** Turn on the radio.
  - 2** Select either FM or AM. Select AM to listen to SW, MW or LW.
  - 3** Press **DIRECT**. The frequency in the display disappears.
  - 4** Enter the frequency of the desired broadcast station by pressing the numeric buttons. FM band: A decimal point is not required for entry. For example, to enter 84.7 MHz, press 8, 4 and 7. AM band: The lower triple zero digits are omitted for entry. For example, to enter 10,000 kHz, press 1 and 0.
  - 5** Press **EXE**. When the desired broadcast station is received, "▶◀ TUNE" appears in the display.

### Note

Complete each button operation in steps 3 to 5 within 10 seconds. If the previously tuned frequency appears in the display, repeat from step 3 again.

### Meter bands and SW

SW is divided into 14 bands that are generally referred to as meter bands. The frequency range that is applicable for automatic scanning is shown below.

Band	Frequency Range	Scan Frequency Range	Meter band
LW	150-529	153-522	—
	150-285 *	153-279 *	—
MW	530-1620	530-1620 *	—
	531-1620 *	531-1620 *	—
AM	2250-2550	2250-2550	120 meter band
	3150-3450	3150-3450	90 meter band
	3850-4050	3850-4050	75 meter band
	4700-5100	4700-5100	60 meter band
	5900-6250	5900-6250	49 meter band
	7100-7400	7100-7400	41 meter band
	9400-10000	9400-10000	31 meter band
	11500-12150	11500-12150	25 meter band
	13500-13900	13500-13900	22 meter band
	15000-15700	15000-15700	19 meter band
	17450-18000	17450-18000	16 meter band
	18850-19100	18850-19100	15 meter band
	21450-21950	21450-21950	13 meter band
	25600-26100	25600-26100	11 meter band
FM	76.00-108.00	76.00-108.00	—
	87.50-108.00 *	87.50-108.00 *	—

\*1 For the Saudi Arabian model only.

\*2. When the channel step is 10 kHz (see page 19).

\*3. When the channel step is 9 kHz (see page 19).

## Preset tuning

Your favorite broadcast stations can be stored on a total of 3 pages. Each page can store up to 10 broadcast stations.

Before tuning in to a preset broadcast station, you must complete the procedure below to preset your favorite broadcast stations.

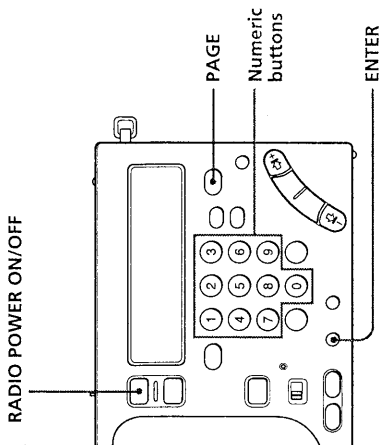

- 1 Turn on the radio.
- 2 Tune in to the desired broadcast station you wish to preset.
- 3 Press PAGE repeatedly to select the page you wish to store your favorite broadcast station on.  
Each time you press PAGE, the display changes in the following order:  
1 → 2 → 3
- 4 Press a numeric button (0-9) while pressing ENTER.

**Tip**  
To change and modify the preset broadcast station, store the new broadcast station to the selected preset number. The previous preset broadcast station is overwritten by the new preset broadcast station.

When FM 81.9 MHz is assigned to preset number 1 of page 1.

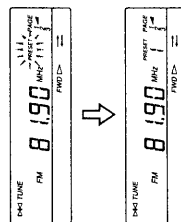

The broadcast station is assigned to the selected number.

## Various tuning methods for optimum reception (continued)

### Tuning in to a preset broadcast station

- 1 Turn on the radio.
- 2 Press PAGE repeatedly to select the page which contains the desired preset broadcast station you wish to tune in to.
- 3 Press the numeric button (0-9) to which the desired broadcast station you wish to tune in to is assigned.

The desired preset broadcast station is received.

## Receiving SSB and CW Transmissions

(not applicable for the Saudi Arabian model)

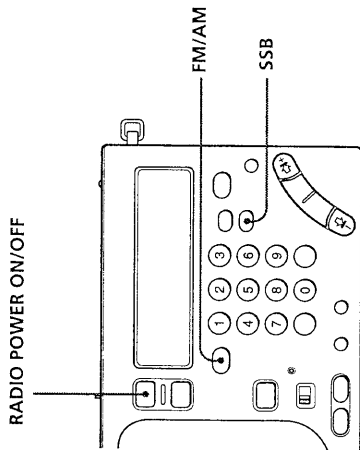

You can receive SSB (Single Side Band) and CW (Continuous Wave) transmissions with the built-in BFO circuit.

### Tip

For more details on SSB and CW, refer to "Tips on radio waves" on page 47.

- 1 Turn on the radio.
- 2 Press FM/AM to select AM.
- 3 Press SSB to select USB or LSB/CW.

Each time SSB is pressed, the display changes in the following order:  
(Normal mode) → USB → LSB/CW.

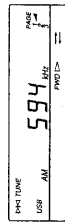

- 4 Tune in to the desired broadcast station.  
Refer to pages 8 and 14-18.

## Receiving optimum AM broadcast

—Synchronous detection

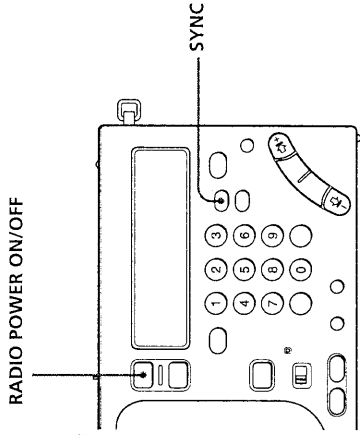

You can receive AM broadcast (especially SW broadcast) under optimum condition with the synchronous detection circuit.

(not applicable for the Saudi Arabian model)

**Tip**  
For more details on synchronous detection, refer to "Tips on radio waves" on page 47.

- 1 Turn on the radio.
- 2 Tune in to the desired broadcast station.  
Refer to pages 8 and 14-18.
- 3 Press SYNC to select SYNC U or SYNC L to obtain optimum AM reception.

### Note

If neither SYNC U nor SYNC L improves AM reception, or if the reception deteriorates even further, press SYNC again (SYNC U or SYNC L for the Saudi Arabian model) to cancel the synchronous detection mode. "LOCK" in the display disappears.

(not applicable for the Saudi Arabian model)  
Each time SYNC is pressed, the display changes in the following order:  
(Normal mode) → SYNC U → SYNC L.

"LOCK" appears in the display when the synchronous detection mode is operating.

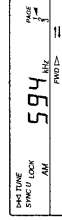

For the Saudi Arabian model, press SYNC U or SYNC L to obtain optimum AM reception.

## Changing the MW channel step for use in foreign countries

The MW channel step of this unit is factory-set to 9 kHz. The channel step differs depending on the area to match the frequency allocation system of the country. Change the MW channel step as necessary.

10 kHz  
Japan, Europe, and other countries:  
9 kHz

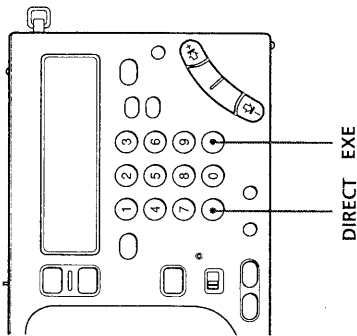

### Notes

- When you have entered the wrong MW channel step in step 3, press DIRECT to cancel the current entry and enter the correct value.
- "TRY AGAIN!" flashes when the MW channel step entered is invalid (i.e., not 9 or 1 and 0). Repeat from step 2 again.
- Complete each button operation in steps 2 to 4 within 10 seconds. If the clock display returns, repeat from step 2 again.

**1** Turn off the radio.

**2** Press DIRECT.

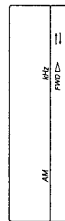

**3** Press the numeric buttons (1, 9 and 0) to enter the desired MW channel step (9 or 1 and 0).

**4** Press EXE.

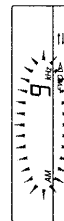

The MW channel step flashes for about 3 seconds and then the clock display returns.

## Connecting an external antenna for optimum reception

### Tips

- When extending the cord and case of the supplied SW compact antenna outside the window, make sure that doing so will not pose any threat or danger to you and others. In addition, make sure to secure firmly so as not to drop the SW compact antenna.
- After using the SW compact antenna, turn the reel in the direction of the arrow to wind up the cord.



### Using the supplied SW compact antenna

Under normal conditions, the telescopic antenna is sufficient for optimal SW reception. However, the use of the supplied SW compact antenna is recommended if the reception is poor when listening to the radio inside a building due to concrete and metal obstructions.

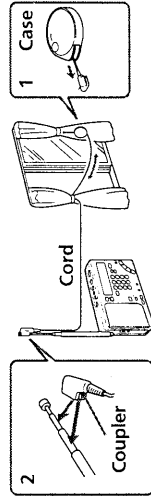

**1** Fully pull out the cord from the case.

**2** Attach the coupler to the telescopic antenna.

**3** If the window can be opened, gently extend the cord with the case outside the window after making sure that doing so will not pose any danger.

If the window cannot be opened, fully extend the cord along the frame of the window.

### Using an external FM antenna (not supplied)

FM reception may be poor and unsatisfactory with the telescopic antenna when the FM signal is notably weak, ignition noise from passing automobiles is severe, or signal interference is prevalent at high-rise building environments. In this case, connect a commercially available external FM antenna with a 75-ohm coaxial cable.

### External FM antenna (not supplied)

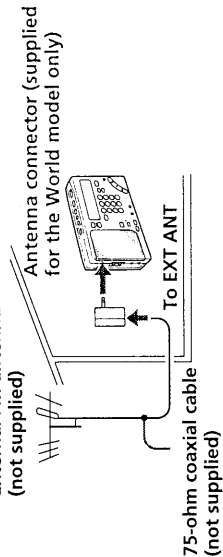

## Recording with a microphone

Use the supplied microphone to record a meeting, or simply enjoy recording with the microphone.  
Use Type I (normal) cassettes only for recording.

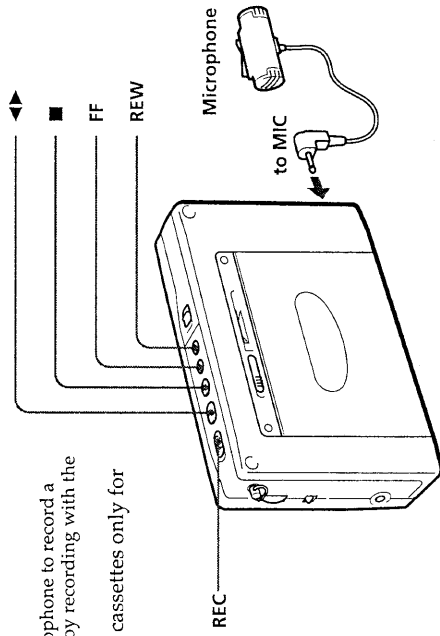

- 1** Insert a cassette.  
Insert the cassette with the side you wish to record facing the cassette holder.  
Before inserting a cassette, make sure that the cassette tab is not broken off.  
A cassette with a broken tab cannot be recorded.
- 2** Select whether you wish to record one side or both sides of the cassette.  
To record one side  $\rightarrow$ : Press FF while pressing  $\blacksquare$ .  
To record both sides  $\rightarrow$ : Press REW while pressing  $\blacksquare$ .
- 3** Make sure that the cassette is inserted with the side you wish to record facing the cassette holder.  
Press  $\blacktriangleleft$  while pressing  $\blacksquare$  to display "FWD  $\blacktriangleright$ ".
- 4** Connect the supplied microphone to the MIC jack of the unit.
- 5** Start recording.

**To stop recording**  
Press  $\blacksquare$ .

**To record the side facing the unit (reverse side)**  
Insert the cassette with the side you wish to record facing the unit (reverse side). Press  $\blacktriangleleft$  while pressing  $\blacksquare$  to display " $\blacktriangleleft$  REV".

Recording stops on the side facing the unit regardless of whether one side or both sides is selected.

### Using the antenna connector (supplied for the World model only)

- 1** Connect an optional coaxial cable to the supplied antenna connector.

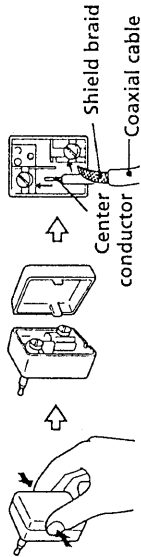

- 2** Connect the antenna connector to the EXT ANT jack of the unit.

### Using the wide range antenna (not supplied)

Use the wide range antenna AN-1 or AN-102 (not supplied) to improve SW, MW and LW receptions as necessary. Wide range antenna usage will differ for SW and MW/LW receptions as described below.

#### For SW reception

Use the connection cord supplied with the AN-1 or AN-102 to connect between the OUTPUT jack of the antenna controller and the EXT ANT jack of this unit.

#### For MW/LW reception

- 1** Use the connection cord and antenna coupler supplied with the AN-1 or AN-102 to connect between the OUTPUT jack of the antenna controller and the INPUT jack of the antenna coupler.

- 2** Position the antenna coupler near the unit where MW/LW reception is optimal.

Retract the telescopic antenna.

When AN-1 is used.

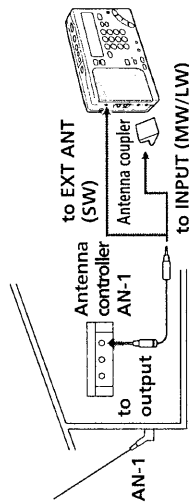

#### Notes

- Connect the recommended antennas only to the EXT ANT jack of the unit. The EXT ANT jack supplies a 3 V DC power output to the recommended antennas. Failure to use the recommended antennas where applicable may lead to the malfunction of the unit.
- Keep the unit and antenna away from fluorescent lights, televisions, and computers which may generate noise.
- When receiving MW or LW broadcasts without using the external MW/LW antenna, make sure to disconnect the SW external antenna where applicable. If not, the built-in ferrite bar antenna will not operate and MW/LW broadcast will not be received successfully.
- Retract the telescopic antenna when using an external antenna.
- Set up the external antenna as far away from the street as possible.
- For more details on the external antenna, refer to its Operating Instructions manual.



## To wake up to the desired broadcast

### —Standby function

The standby function enables you to turn on the radio and tune in to your favorite broadcast station at the desired time. The standby function features a dual alarm so that you can enter two different preset times. Before using the standby function, make sure that the clock is set correctly (see page 7).

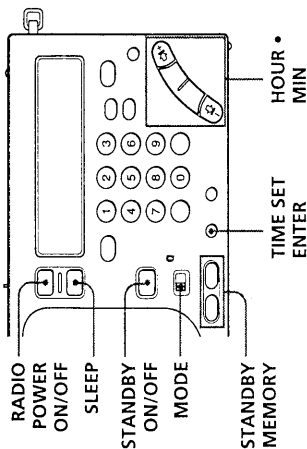

**Using the supplied microphone**  
The clip of the supplied microphone can be swiveled in the desired direction and fastened for your convenience.



### Notes on recording

#### Recording level

The recording level is fixed. Adjusting VOLUME and TONE does not affect the sound to be recorded.

#### Recording with the supplied microphone

- Before inserting a cassette, make sure that the cassette tab is not broken off. A cassette with a broken tab cannot be recorded to prevent accidental recording of your important cassette. If you wish to use the cassette for recording again, cover the opening of the broken tab with adhesive tape.
- Operate REC approximately 2 seconds prior to the point you wish to begin recording. If not, the leading segment may not be recorded.
- Switching the recording side is not possible when **◀▶** is pressed during recording.

- When the supplied microphone is connected, power is supplied from the unit.
- The supplied microphone is a plug-in-power type and should be connected to MIC jacks of cassette recorders that are compatible with the plug-in-power type only.
- To prevent accidental operations of the buttons, use the hold function (see page 32).

**1** Tune in to the desired broadcast station you wish to preset.

**2** Adjust VOLUME as necessary.

**3** Press **a** or **b** of STANDBY MEMORY while pressing ENTER.

The broadcast station is assigned to the selected button.

**4** Turn off the radio.

**5** Press HOUR or MIN repeatedly while pressing either **a** or **b** of STANDBY MEMORY (which you pressed in step 3) to set the desired standby time for the radio to turn on.

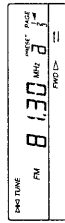

Display the desired standby time for the radio to turn on.

#### Note

Make sure that the radio is turned off before setting the desired standby time. You cannot set the standby time when the radio or cassette is operating.

## To fall asleep while listening to the desired broadcast—Sleep timer

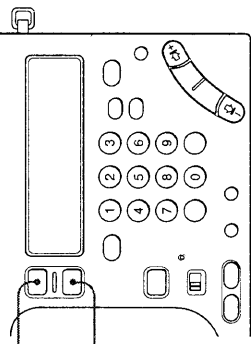

You can turn off the radio automatically after a specified number of minutes (10–90 minutes) with the sleep timer function.

- Press SLEEP repeatedly while pressing either **a** or **b** of STANDBY MEMORY (which you pressed in step 3) to set the desired duration for the operation of the radio.  
Each time SLEEP is pressed, the display changes in the following order:  
60 (minutes) → 50 → 40 → 30 → 20 → 10 → 90 → 80 → 70

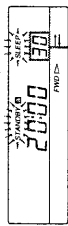

Display the desired duration for the operation of the radio.

- The clock display returns when **a** or **b** is released.  
Press STANDBY ON/OFF repeatedly to display "STANDBY **a**" or "STANDBY **b**" (which you selected in step 3).  
Each time STANDBY ON/OFF is pressed, the display changes in the following order:  
STANDBY **a** → STANDBY **b** → STANDBY **a** → (None)

- Set MODE to RADIO.  
When the preset standby time arrives, the preset broadcast station is received. After the preset duration for the operation of the radio has elapsed, the radio turns off.

### To check the preset standby time

Press **a** or **b** of STANDBY MEMORY. The preset standby time and preset duration for the operation of the radio are displayed while the button is pressed.

### To change the preset standby time

Repeat steps 5 through 7 to change the existing preset standby time.

### To cancel the standby function

Press STANDBY ON/OFF repeatedly so that "STANDBY" in the display disappears.

### Tip

To temporarily cancel the standby function, slide HOLD in the direction of the arrow to display "0-m" while the radio is turned off. When "0-m" in the display disappears, the standby function is operational (see page 32).

### Notes

- When you set STANDBY **a** and STANDBY **b**, and the preset standby time arrives while the other standby function is operating, the most recent standby function will have priority over the other and receive the appropriate broadcast.
- Once you preset the desired standby time, the radio turns on at the preset time everyday.
- When the preset standby time arrives while the radio or cassette is operated, the standby function will have priority over the current operation and receive the appropriate broadcast automatically.
- If you set STANDBY **a** and STANDBY **b** to an identical preset time, only STANDBY **a** operates.

- Press SLEEP.

The radio turns on. "SLEEP" flashes and the duration for the operation of the sleep timer (60 minutes) appears in the display.

- Press SLEEP repeatedly to display the desired duration for the operation of the sleep timer.  
Each time SLEEP is pressed, the display changes in the following order:  
60 (minutes) → 50 → 40 → 30 → 20 → 10 → 90 → 80 → 70

Sleep timer begins after "SLEEP" stops flashing and remains in the display, and the duration for the operation of the sleep timer disappears.

- Tune in to the desired broadcast station.

The radio turns off automatically after the selected duration for the operation of the sleep timer elapses.

### To change the preset duration for the operation of the sleep timer

Press SLEEP repeatedly to display the desired duration for the operation of the sleep timer.

### To turn off the radio before the preset duration has elapsed

Press RADIO POWER ON/OFF.

**Tip**  
The previously tuned broadcast station is received when SLEEP is pressed to turn on the radio.

### Note

Repeat from step 1 again if the sleep timer begins before you have set the desired duration. The sleep timer begins automatically after about 5 seconds when SLEEP is released.

### Note

When the sleep timer is activated while recording the radio, the recording will stop and the power will turn off.

## To record the desired broadcast with the timer—Timer recording

The timer recording function enables you to turn on the radio and tune in to your favorite broadcast station at the desired time for recording. Use the timer recording function when you wish to record a broadcast while away or unattended. Before using the timer recording function, make sure that the clock is set correctly (see page 7).

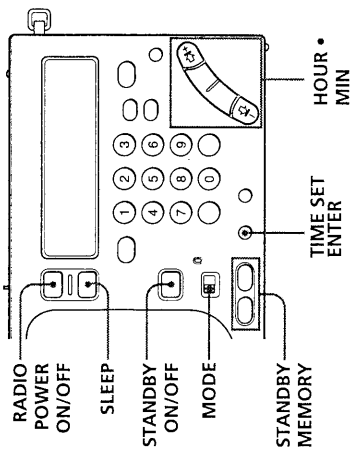

- 1 Insert a cassette.
- 2 Insert the cassette with the side you wish to record facing the cassette holder.
- 3 Tune in to the desired broadcast station you wish to record and adjust VOLUME.
- 4 Press **a** or **b** of STANDBY MEMORY while pressing ENTER. The broadcast station is assigned to the selected button.
- 5 Turn off the radio.
- 6 Press HOUR or MIN repeatedly while pressing either **a** or **b** of STANDBY MEMORY (which you pressed in step 3) to set the desired standby time for the radio to turn on for recording.

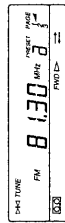

Display the desired standby time for the radio to turn on for recording.

### Tip

To temporarily cancel the standby function, slide HOLD in the direction of the arrow to display "0-m" while the radio is turned off. When "0-m" in the display disappears, the standby function is operational (see page 32).

### Notes

- When you set STANDBY **a** and STANDBY **b**, and the preset standby time arrives while the other standby function (timer recording) is operating, the most recent standby function will have priority over the other and record the appropriate broadcast.
- Once you preset the desired standby time, the radio operates at the preset time everyday.
- When the preset standby time arrives while the radio or cassette is operated, the standby function will have priority over the current operation and record the appropriate broadcast automatically.
- If you set STANDBY **a** and STANDBY **b** to an identical preset time, only STANDBY **a** operates.
- When a cassette is not inserted, or the tab of the cassette is broken, recording is not possible. Instead, the radio will receive the appropriate broadcast.

- 6 Press SLEEP repeatedly while pressing either **a** or **b** of STANDBY MEMORY (which you pressed in step 3) to set the desired duration for the operation of the radio.

Each time SLEEP is pressed, the display changes in the following order:  
60 (minutes) → 50 → 40 → 30 → 20 → 10 → 90 → 80 → 70

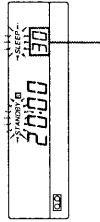

Display the desired duration for the operation of the radio.

- 7 The clock display returns when **a** or **b** is released. Press STANDBY ON/OFF repeatedly to display "STANDBY **a**" or "STANDBY **b**" (which you selected in step 3). Each time STANDBY ON/OFF is pressed, the display changes in the following order:  
STANDBY **a** → STANDBY **b** → STANDBY **a** **b** → (None)

- 8 Set MODE to REC.

The indicator beside the switch turns red.

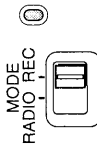

When the preset standby time arrives, the preset broadcast station is received and recorded. After the preset duration for the operation of the radio has elapsed, the radio and recording operation will turn off.

## Using the hold function to prevent accidental operations

When the hold function is used, all buttons are locked and are not operational. When carrying the unit or operating the radio or cassette, use the hold function to prevent accidental operations. In addition, use the hold function to temporarily cancel the standby function (see pages 28 and 31).

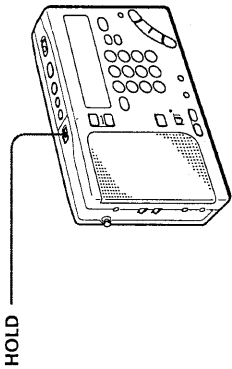

**Tip** When the hold function is used, the illumination of the display is turned off.

**Note** The hold function cannot be used to hold cue and review operations.

Slide HOLD in the direction of the arrow to display "O-T". All buttons are locked and are not operational when "O-T" is displayed.

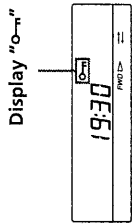

### To cancel the hold function

Slide HOLD in the opposite direction of the arrow so that "O-T" disappears in the display.

### To temporarily cancel the standby and timer recording functions

When the hold functions is used, the standby and timer recording functions are temporarily canceled. This is applicable when the radio is not operating only.

## Attaching the strap

Attach the supplied strap to facilitate handling of the unit. In addition, you can use the strap as a stand.

### To attach

Attach the strap to the fixture on the side of the unit as shown.

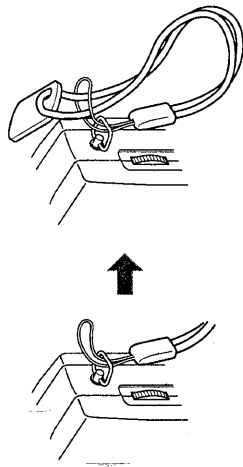

### Using the stand

Insert the tab of the strap into the slot on the rear side of the unit as shown.

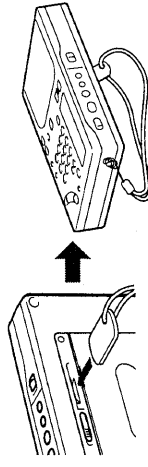

## Replacing the batteries

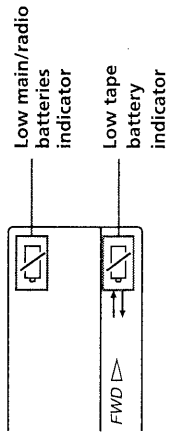

### Notes

- Replace the batteries within 3 minutes after the batteries are removed from the holders. Otherwise, the preset broadcast stations and clock settings will be erased. In this case, preset the broadcast stations and set the time again.
- "⏏" will disappear in the display when the radio or tape is operated after the batteries are replaced.

### Main/radio batteries

Radio or tape stops operating, and "⏏" will flash in the display when the main/radio batteries require replacement. Replace with two new R6 (size AA) batteries.

When the batteries are completely exhausted, "⏏" stops flashing and remains in the display. All operations will not be possible.

### Tape battery

The tape battery supplies the necessary power to drive the motor for tape operation. Sound quality will deteriorate, tape operation will become unstable, and "⏏" will flash in the display when the tape battery requires replacement. Replace with a new R6 (size AA) battery.

When the battery is completely exhausted, "⏏" stops flashing and remains in the display. All operations will not be possible.

### Battery Life (Approximate hours)

	Sony R6 alkaline (size AA)	Sony R6 (size AA)
Tape Playback	approx. 37	approx. 14
Radio FM	approx. 27	approx. 9
Play AM	approx. 21	approx. 7
MIC recording	approx. 36	approx. 13
Radio FM	approx. 18	approx. 6.5
Recording AM	approx. 15	approx. 5

## Operating with house current or car battery

### House current

To operate the unit with house current, connect the optional AC power adaptor AC-E30HG to the DC IN 3V jack of the unit.

### to a wall outlet

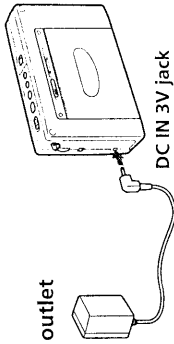

### Notes on the AC power adaptor

- Do not bend or twist the power cord unnecessarily and do not place heavy objects on the power cord.
- When disconnecting the AC power adaptor from the wall outlet, pull out by the plug. Do not pull the power cord.
- Disconnect the AC power adaptor from the wall outlet when the unit is not to be used for a long period of time. Make sure to pull out by the plug.

### Car battery

To operate the unit with car battery, connect a car battery cord to the DC IN 3V jack of the unit. For more details on the car battery cord, refer to its Operating Instructions manual.

### Notes on external power sources

- When operating the unit with an external power source, do not remove the batteries in the RADIO BATT battery holder which serve as a backup of the memory. Replace the batteries regularly once a year.
  - When operating the unit with the internal batteries, remove the AC power adaptor or car battery cord in the following order: ① disconnect from the wall outlet or car battery, and ② disconnect from the DC IN 3V jack of the unit.
- Make sure that the plug of the external power source is disconnected before operating the unit.
- Use the recommended Sony AC power adaptor or car battery cord only. The polarity of the plugs of other manufacturers may be different. Failure to use the recommended AC power adaptor or car battery cord may lead to the malfunction of the unit.



Polarity of the plug

## SECTION 3 DISASSEMBLY

**Note:** Follow the disassembly procedure in the numerical order given.

### BATTERY BOX

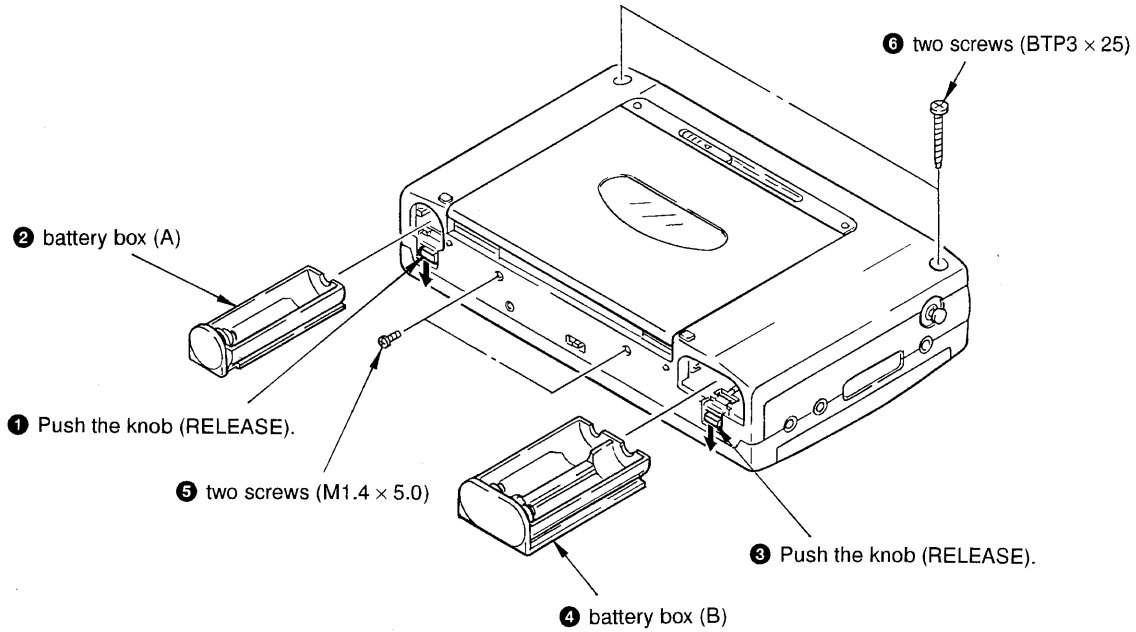

### REAR CABINET

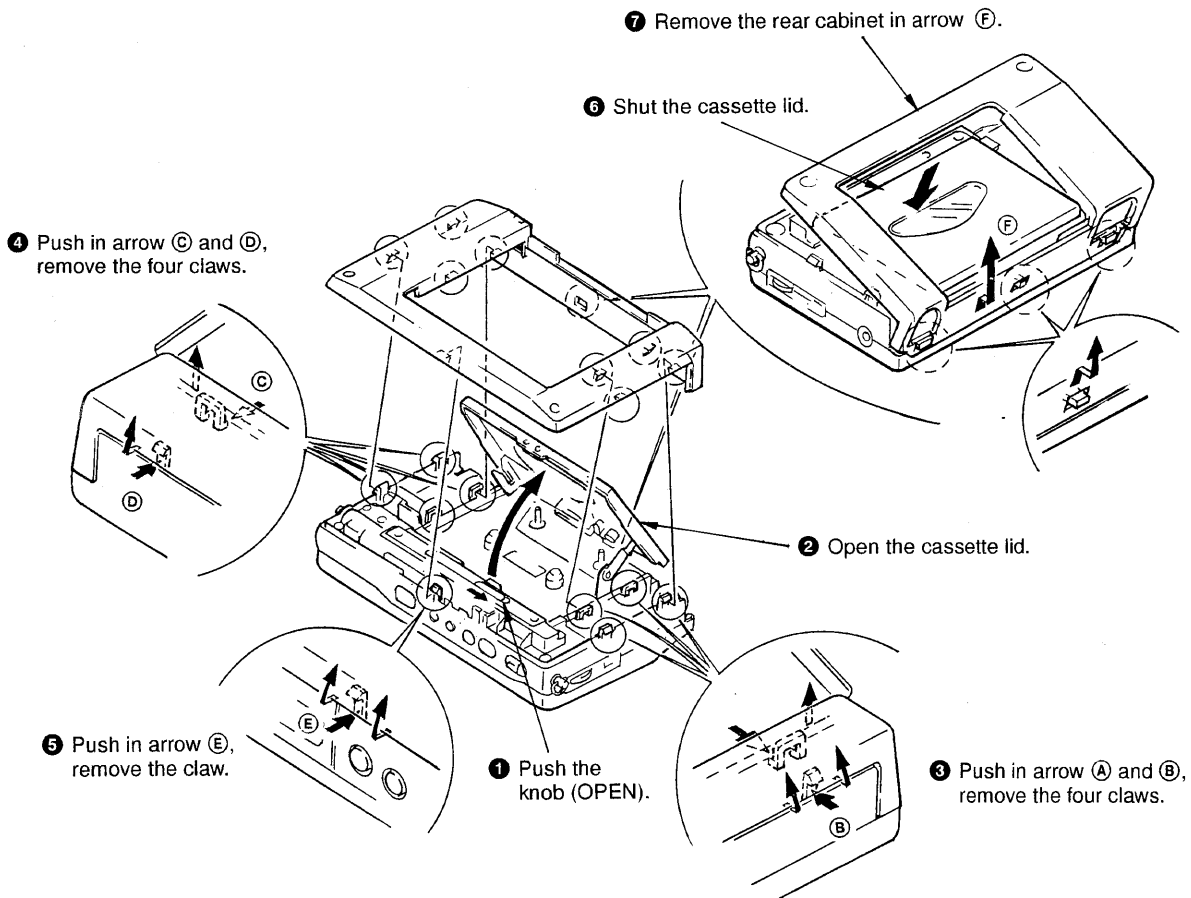

## REAR PANEL

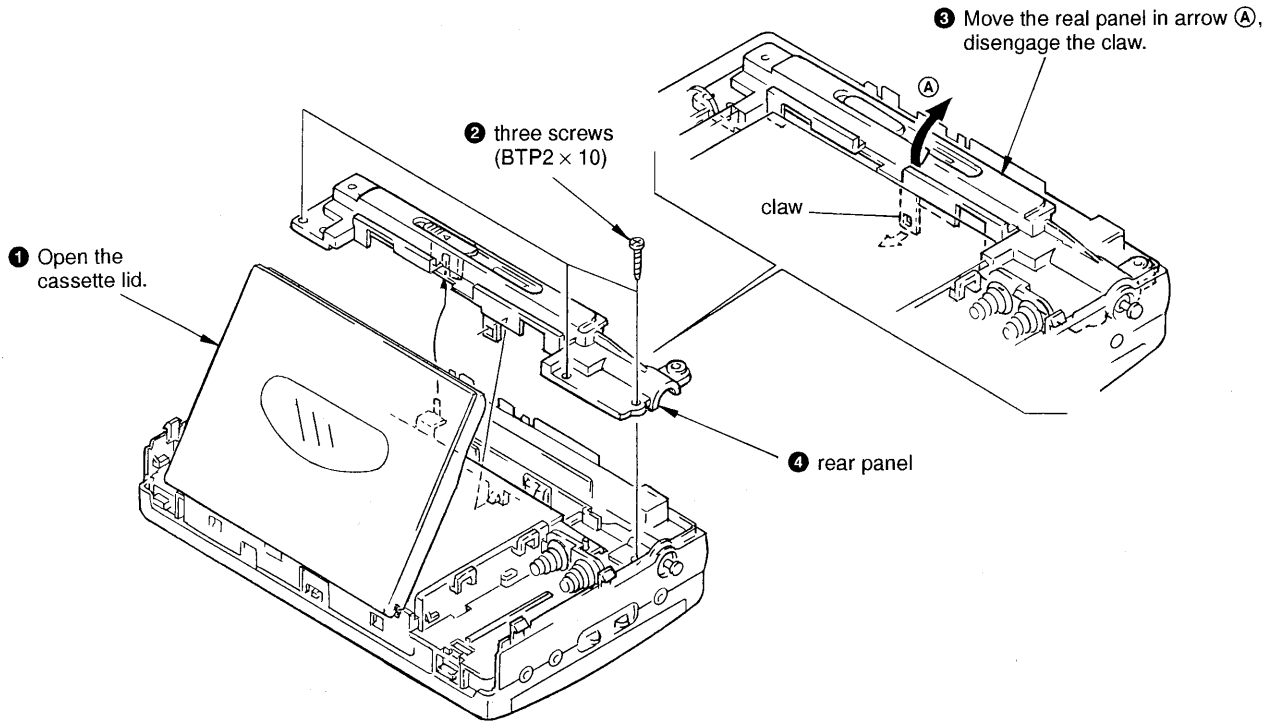

## MD ASSEMBLY

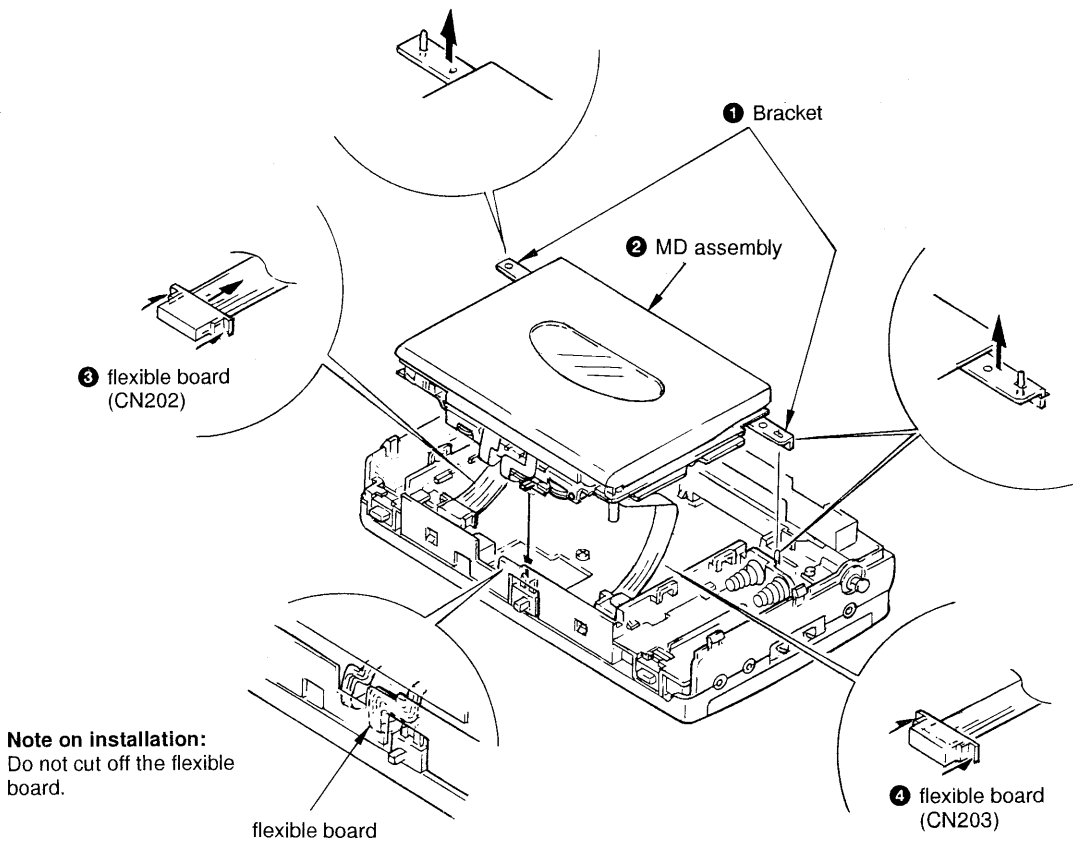

## CHASSIS ASSEMBLY

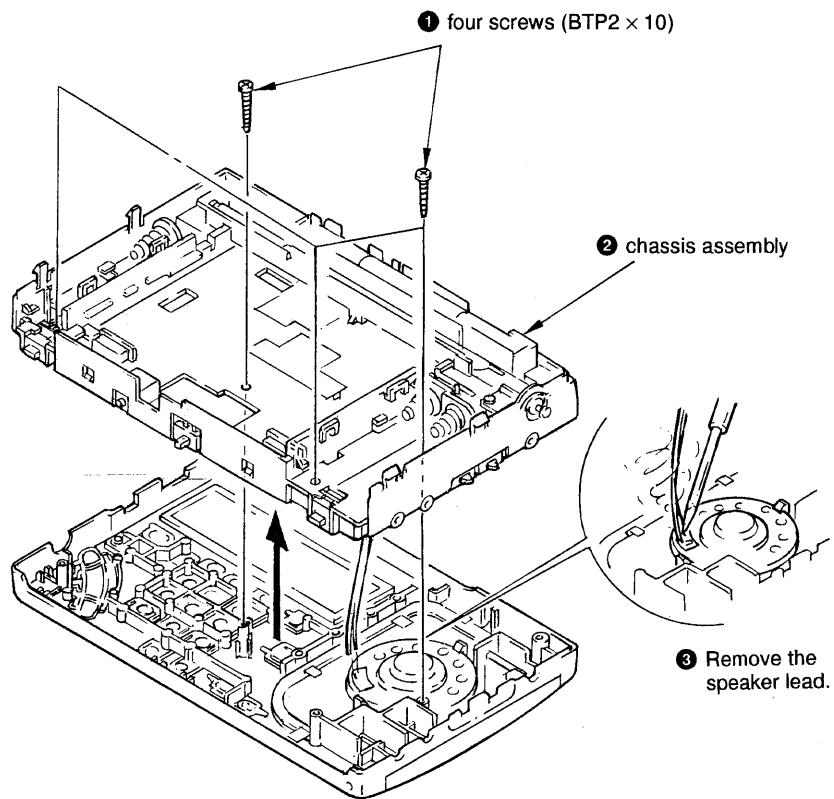



## SECTION 4 MECHANICAL ADJUSTMENT

### PRECAUTION

1. Clean the following parts with a denatured-alcohol-moistened swab:
 

record/playback head	pinch roller
erase head	rubber belts
capstan	idlers
2. Demagnetize the record/playback head with a head demagnetizer. (Do not bring the head demagnetize close to the erase head.)
3. Do not use a magnetized screwdriver for the adjustments.
4. After the adjustments, apply suitable locking compound to the parts adjusted.
5. The adjustments should be performed with the rated power supply voltage (1.3 V) unless otherwise noted.

### Torque Measurement

Mode	Torque Meter	Meter Reading
FWD	CQ-102C	21-38 g•cm (0.29-0.53 oz•inch)
FWD Back Tension		0.5-3 g•cm (0.01-0.04 oz•inch)
REV	CQ102RC	21-38 g•cm (0.29-0.53 oz•inch)
REV Back Tension		0.5-3 g•cm (0.01-0.04 oz•inch)
FF	CQ201B	more than 60 g•cm (more than 0.84 oz•inch)
REW		

### Tape tension Measurement

Mode	Tension Meter	Meter Reading
FWD	CQ-403A	more than 40 g•cm (more than 1.4 oz)
REV	CQ-403R	

## SECTION 5 ELECTRICAL ADJUSTMENTS

### DECK SECTION

### PRECAUTION

1. Perform adjustment under the following condition, unless otherwise specified.
  - Positions of switches and control knobs  
 VOLUME knob ..... mechanical center  
 SENS switch ..... HIGH

### • Test tape

Type	Signal	Used for
WS-48A	3 kHz, 0dB	tape speed adjustment

### Tape Speed Adjustment

Procedure:

Mode : FWD playback

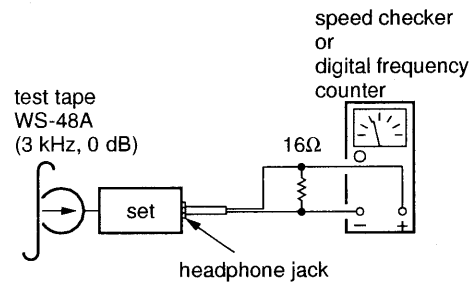

Adjustment Value:

Speed checker	Digital frequency counter
3,000 Hz ± 0.5 %	2,985 - 3,015 Hz

Adjust the RV601 so that a difference in frequency at the start of tape winding and at the end of winding is within 0.5 % (15 Hz) respectively.

After adjustment, select the REV PLAY mode, and confirm that the characteristics satisfy the standard.

Adjustment Location: MD Board (Conductor Side)

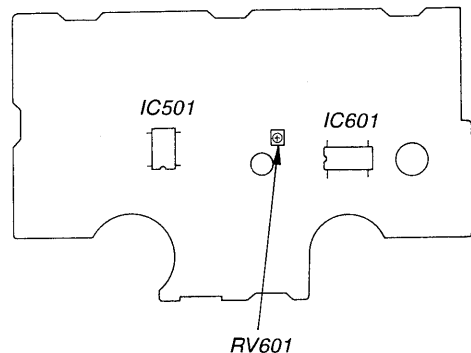



## FM TRACKING Adjustment

**Note:** This adjustment should be performed after the remove Rod-Antenna (ANT2).  
This adjustment should be performed after the VCO VOLTAGE ADJUSTMENT.

### Setup:

BAND selector : FM  
VOLUME control: Arbitrary

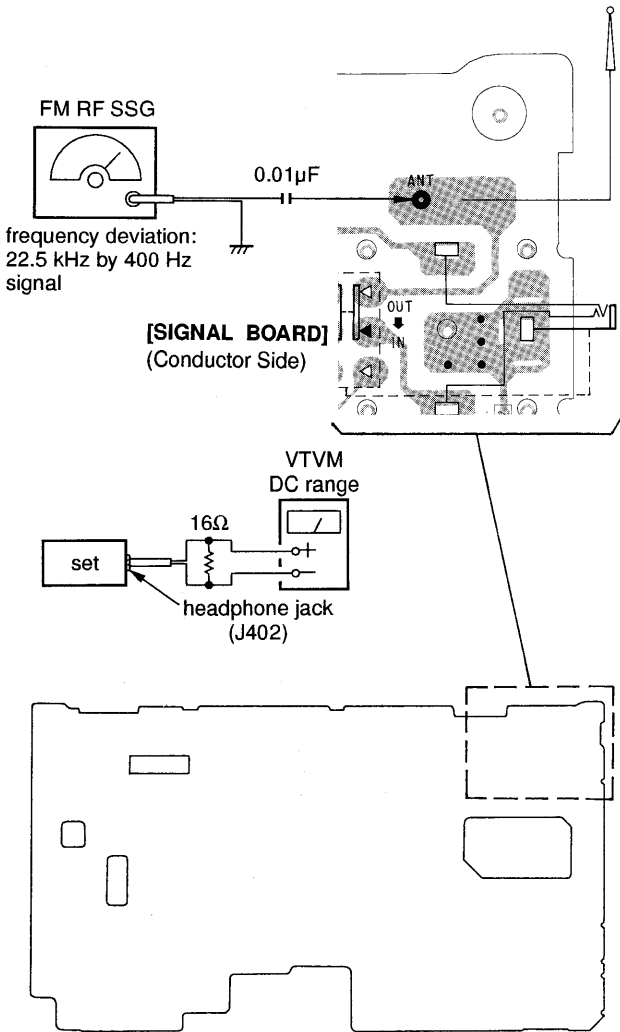

### Procedure:

1. Set the frequencies of the FM RF SSG and the frequency display of the set to 76 MHz
2. Adjust T2 and T3 to obtain a maximum reading on the VTM.
3. Set the frequencies of the FM RF SSG and the frequency display of the set to 108 MHz.
4. Adjust CT3 and CT4 to obtain a maximum reading on the VTM.
5. Repeat the above steps several times, and finish the adjustment with the trimmers CT3 and CT4.

## FM STEREO (76 kHz) Adjustment

### Setup:

BAND selector: FM  
VOLUME control: Arbitrary

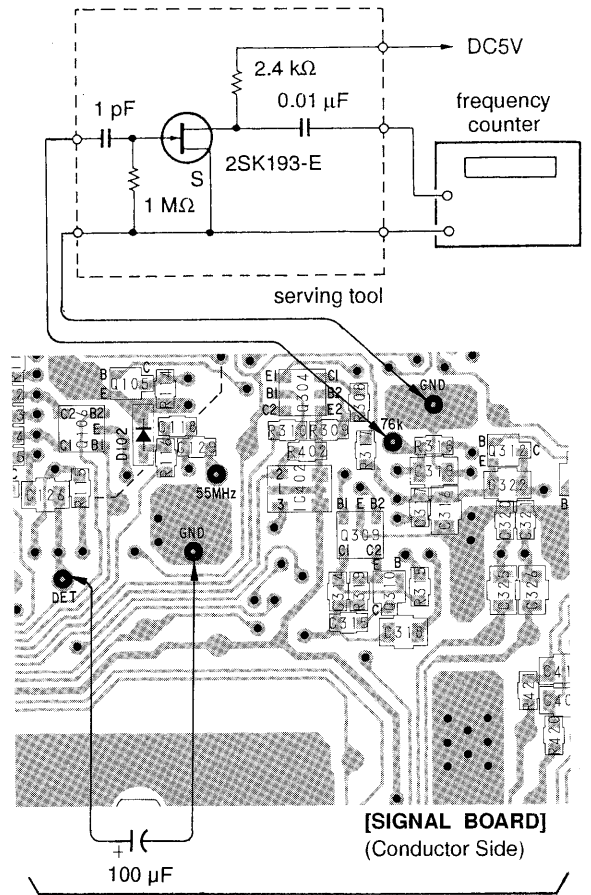

### Procedure:

1. Adjust RV301 to obtain a 75.9–76.1 kHz on the frequency counter.

## SD Adjustment

### Setup:

BAND Selector: FM  
VOLUME control: Arbitrary

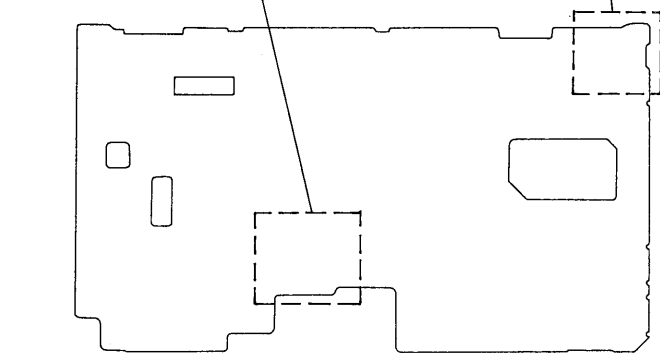
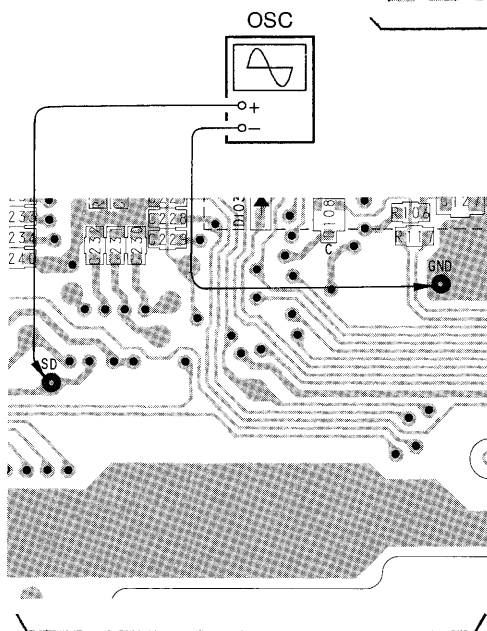
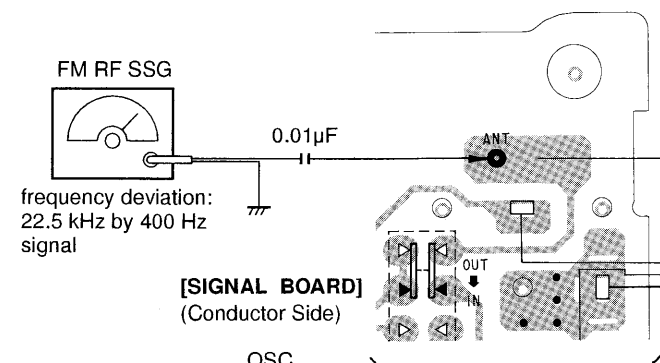

### Procedure:

1. Tuner the set to 93 MHz.  
(FM RF SSG frequency is 93.025 MHz)

2. Adjust the RV102 so that a waveform on oscilloscope is as shown below.

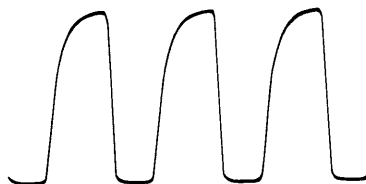

## 1st IF Adjustment

### Setup:

BAND Selector: AM  
VOLUME control: arbitrary

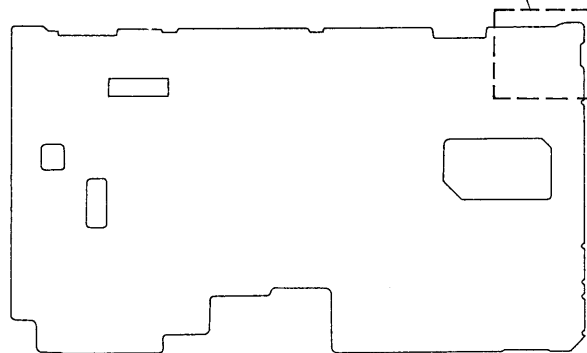
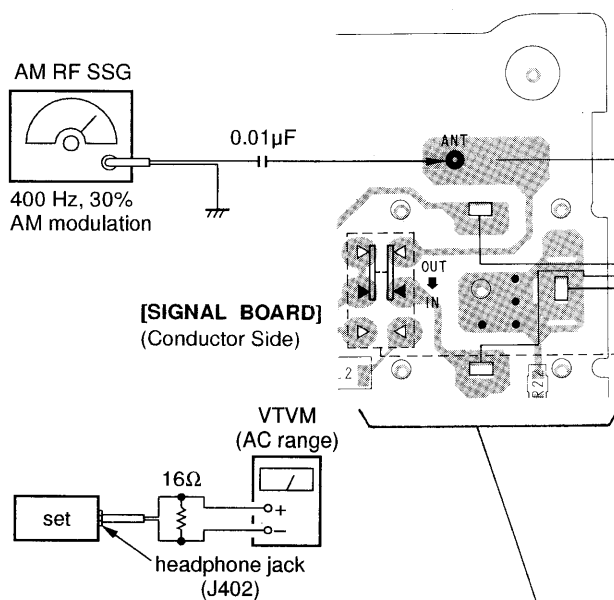

### Procedure:

1. Set the frequencies of the AM RF SSG and the frequency display of the set to 150 kHz.
2. Adjust T5 and T6 to obtain a maximum reading on the VTVM.

## 2nd LOCAL Adjustment

### Setup:

BAND Selector: AM  
VOLUME control: Arbitrary

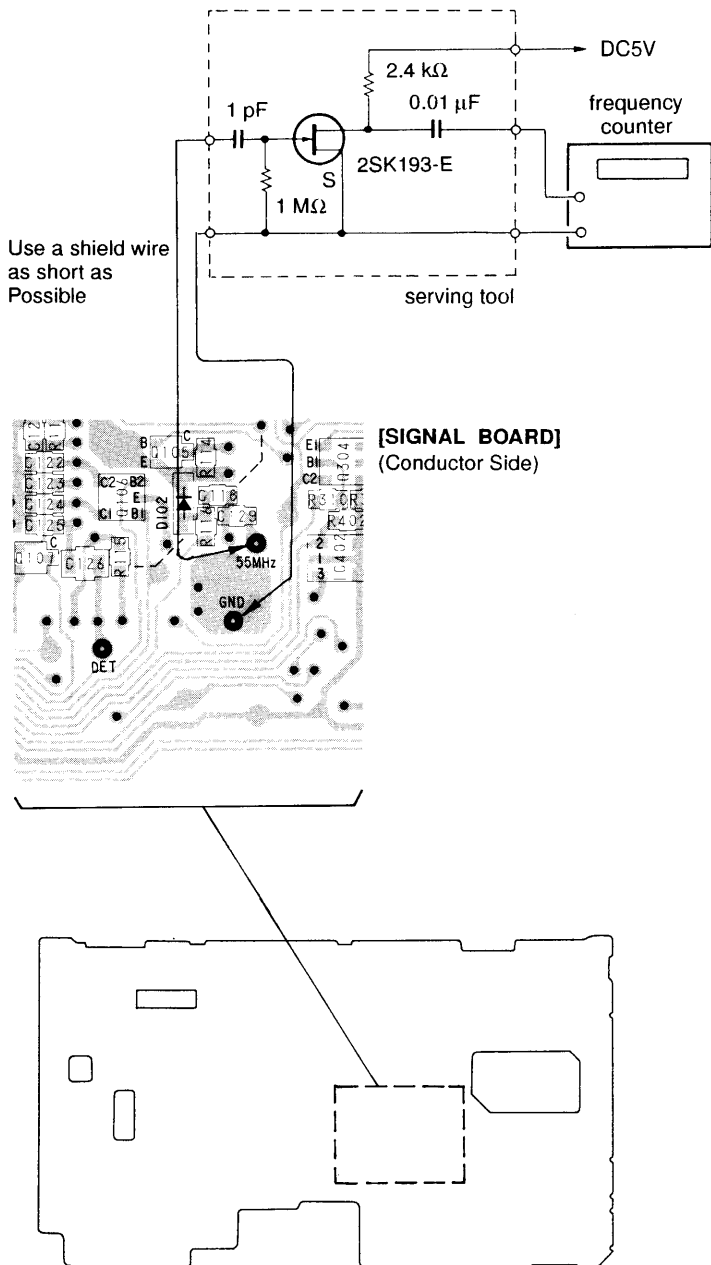

## SSB ZERO BEAT Adjustment

### Setup:

BAND selector: AM  
MODE: SSB (USB or LSB/CW)

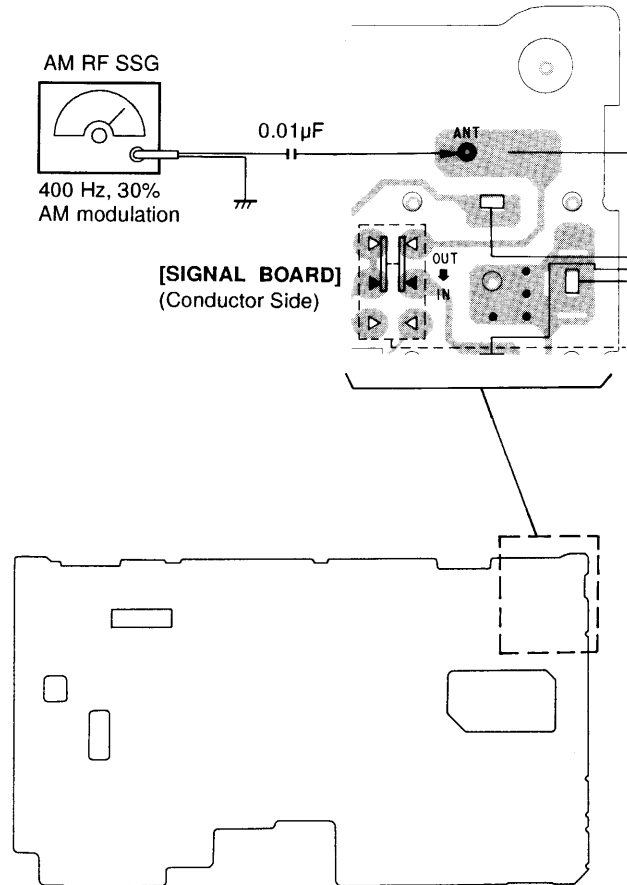

### Procedure:

1. Adjust the RV101 to attain zero beat (no beat sound heard).
2. Change the mode to the alternative band (LSB/CW if USB), and check if the zero beat is retained.  
If not, readjust.

### Procedure:

1. Tune the set to AM 150 kHz .
2. Press the [SSB] key, and confirm that [USB] is displayed.
3. Press the [←] key (outside).
4. Adjust T102 (pink) to obtain a 55.38997 –55.39003 MHz on the frequency counter.
5. Press the [→] key (inside) only once. (Return to 2 if wrong)
6. Adjust T103 (Yellow) to obtain a 55.38907 –55.38913 MHz on the frequency counter.

## 2 MHz clock Frequency Adjustment

**Note:** When X701 on Microcomputer board is replaced, it is necessary to adjust the clock frequency.

### Setup:

BAND selector: AM

VOLUME control: Arbitrary

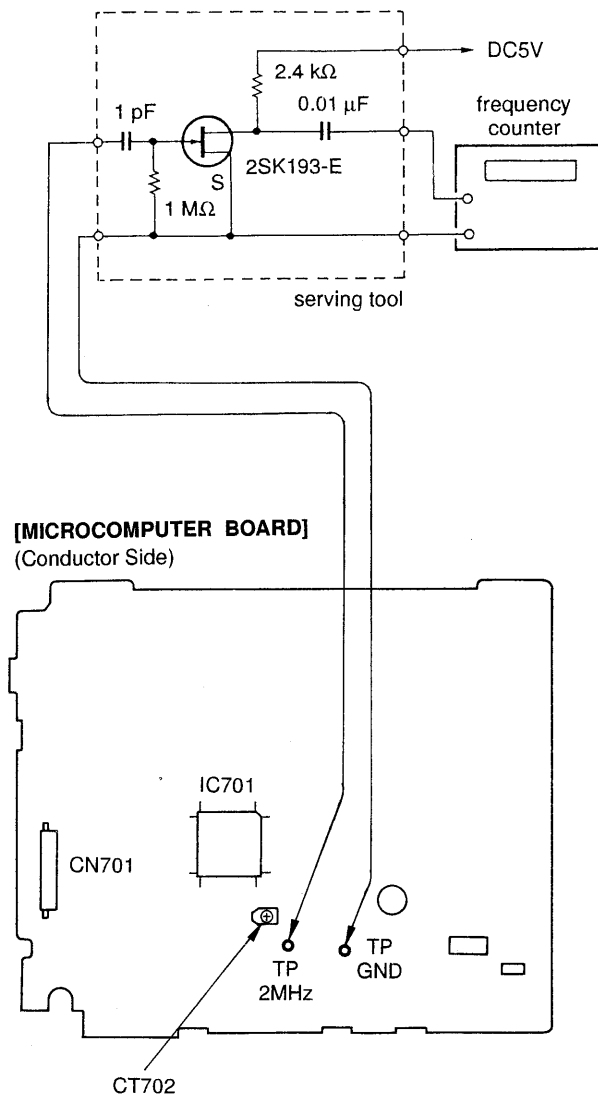

## • Parts Location Diagram Relevant to the Adjustment

[SIGNAL BOARD]  
(Component Side)

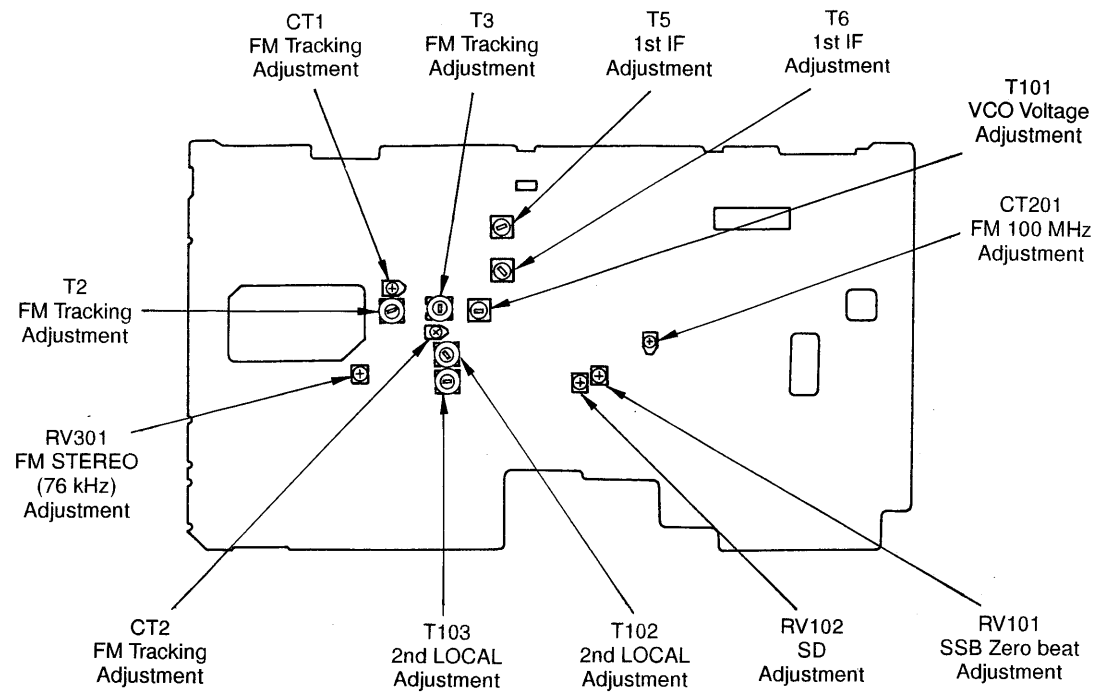

### Procedure:

1. Tune the set to 150 kHz.
2. Adjust CT702 for 2.040 MHz  $\pm$  1 kHz reading on the frequency counter.

SECTION 6  
DIAGRAMS

6-1. PRINTED WIRING BOARD -TUNER Section-

• Semiconductor Location

Ref. No.	Location	Ref. No.	Location
D1	D-24	Q103	E-21
D2	D-26	Q104	E-22
D3	D-24	Q105	E-23
D4	E-23	Q106	E-22
D5	D-28	Q107	F-22
D6	C-24	Q108	F-21
D7	C-24	Q201	C-19
D8	C-24	Q202	C-20
D9	C-24	Q203	D-20
D101	E-23	Q204	D-19
D102	F-23	Q205	D-23
D103	F-20	Q206	D-19
D201	D-20	Q207	E-19
D202	D-19	Q208	D-19
D301	D-10	Q301	D-11
D302	D-11	Q302	D-11
D303	F-5	Q303	E-18
D401	H-16	Q304	E-23
D402	H-16	Q305	G-5
D403	H-12	Q306	F-4
D404	H-16	Q307	G-5
		Q308	F-6
IC101	E-7	Q309	F-24
IC201	F-10	Q310	F-24
IC301	E-11	Q311	F-25
IC302	F-4	Q312	F-24
IC402	F-23	Q313	G-5
IC403	G-3	Q401	H-26
		Q402	H-25
		Q403	G-26
		Q404	G-27
Q1	C-26	Q405	H-26
Q2	C-25	Q406	H-25
Q3	C-25	Q407	H-25
Q4	C-26	Q408	H-11
Q5	D-24	Q409	H-11
Q6	D-24	Q410	H-11
Q7	E-24	Q411	F-3
Q8	D-23	Q412	H-25
Q9	C-26	Q413	F-25
Q10	C-25	Q414	G-25
Q11	D-24	Q415	G-25
Q12	C-23	Q416	H-25
Q13	C-23	Q417	H-26
Q14	D-22		
Q101	D-22		
Q102	E-21		

**Note on Printed Wiring Board:**

- : parts extracted from the component side.
- : parts extracted from the conductor side.
- : indicates side identified with part number.
- : Through hole.
- : Pattern from the side which enables seeing.

(The other layers' patterns are not indicated.)

**Caution:**

Pattern face side: Parts on the pattern face side seen from the conductor side are indicated.

Parts face side: Parts on the parts face side seen from the component side are indicated.

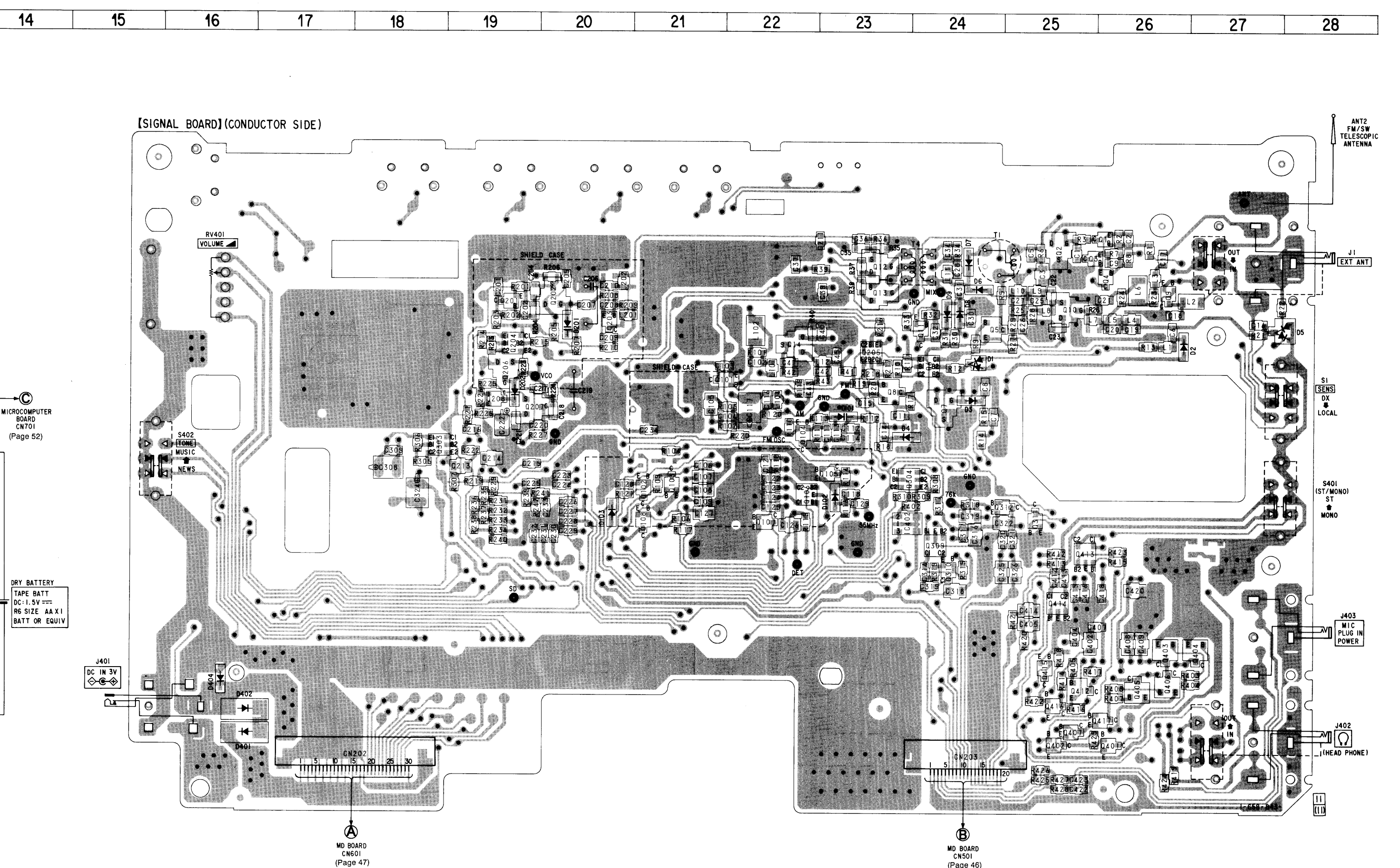
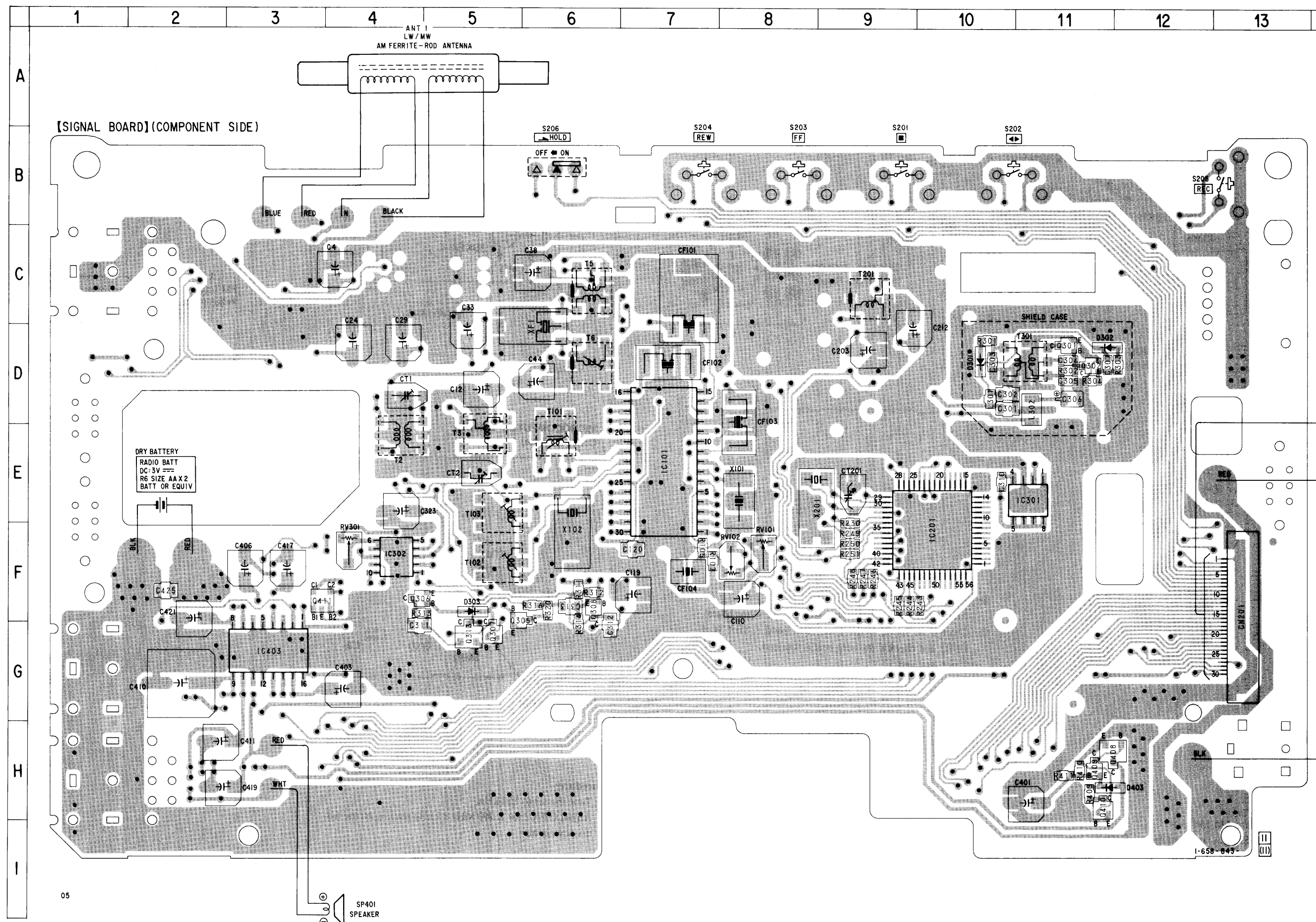





6-3. SCHEMATIC DIAGRAM -DECK Section-

1 2 3 4 5 6 7 8 9 10 11 12 13 14 15 16 17 18 19 20 21

• IC Block Diagrams

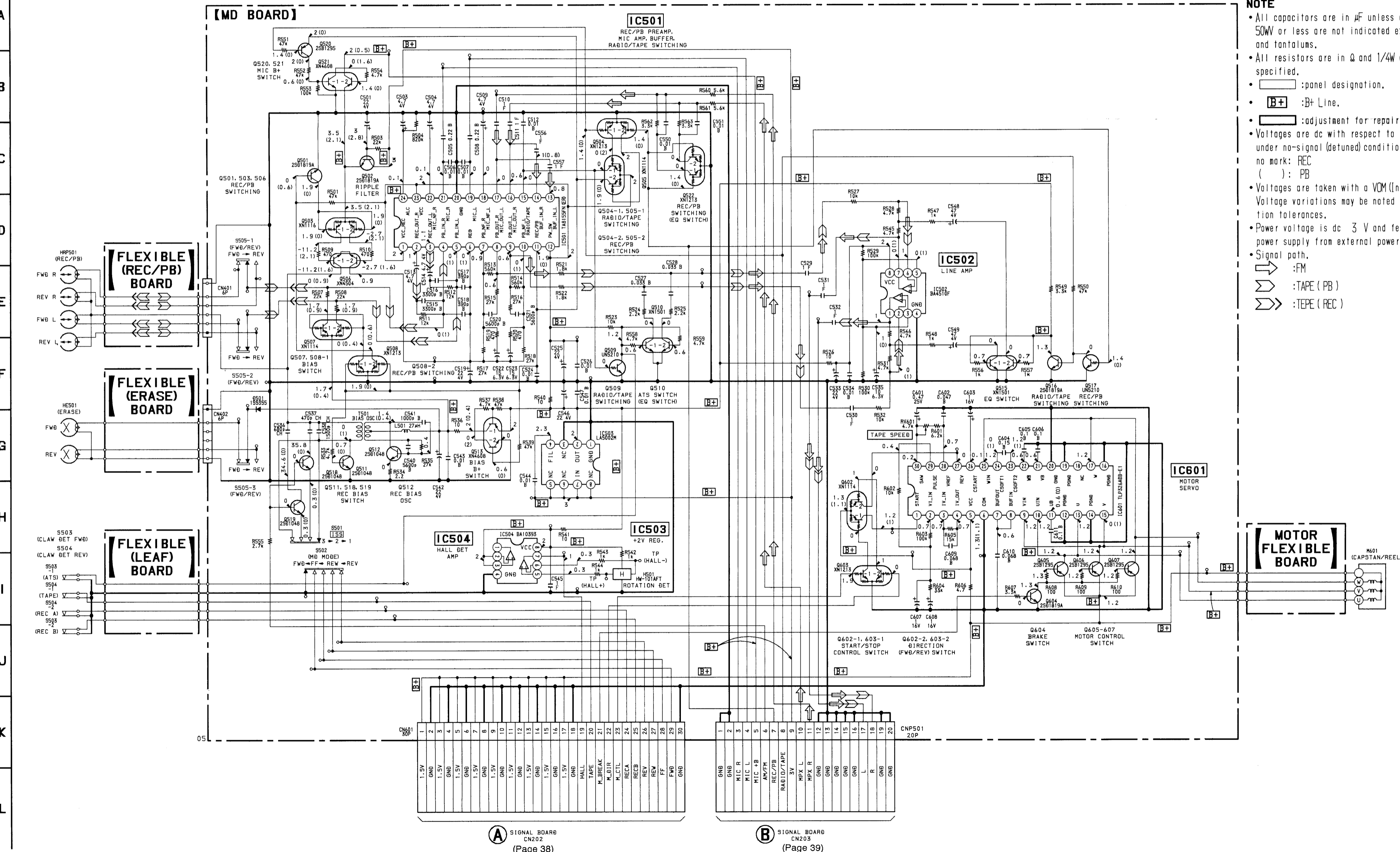
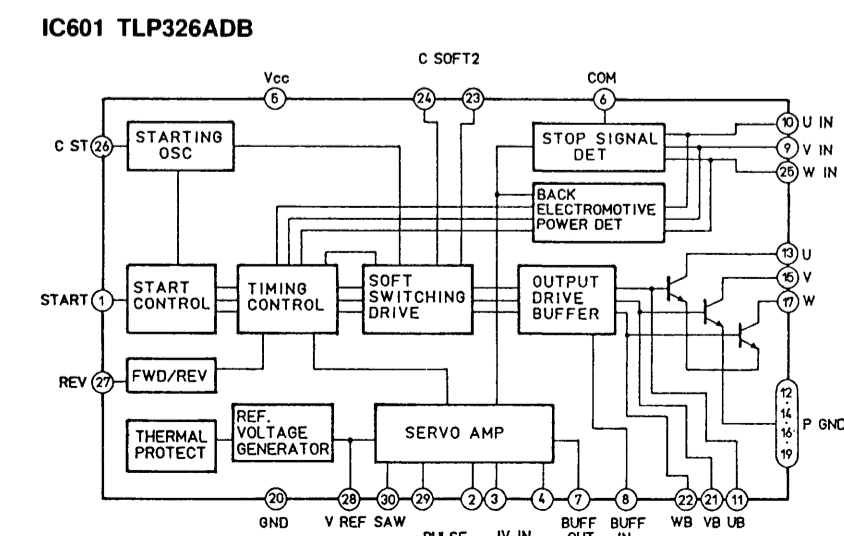
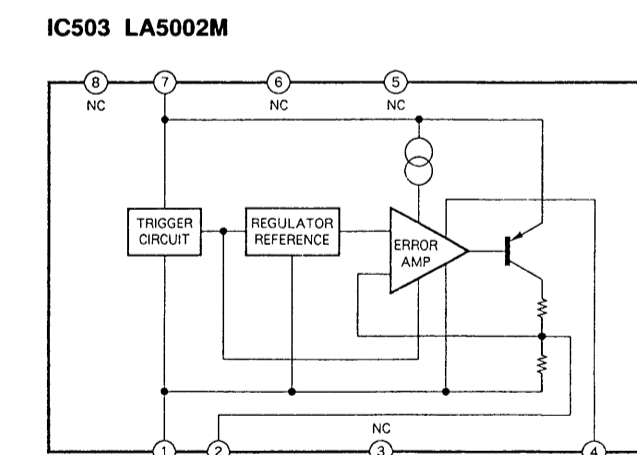
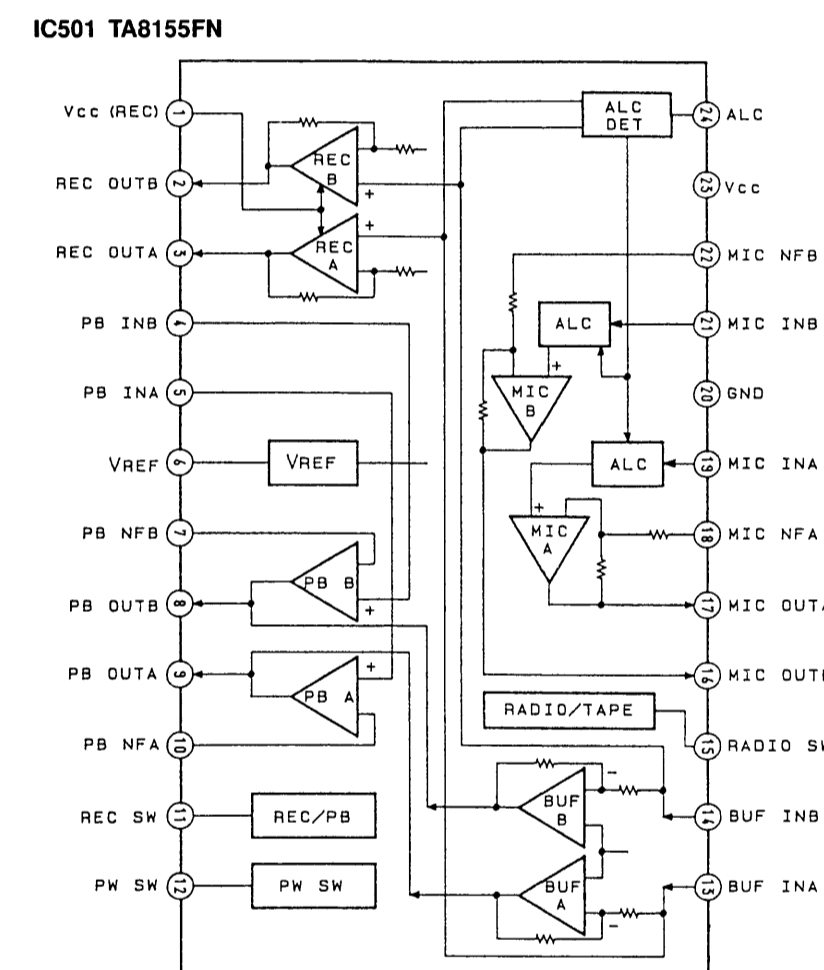

**NOTE**

- All capacitors are in  $\mu\text{F}$  unless otherwise noted, pF:  $\mu\text{pF}$
- 50W or less are not indicated except for electrolytics and tantalums.
- All resistors are in  $\Omega$  and  $1/4\text{W}$  or less unless otherwise specified.
- [ ] : panel designation.
- [B+] : B+ Line.
- [ ] : adjustment for repair.
- Volts are dc with respect to ground under no-signal (detuned) conditions.
- no mark: REC
- ( ) : PB
- Volts are taken with a VOM (input impedance  $10\text{M}\Omega$ ). Voltage variations may be noted due to normal production tolerances.
- Power voltage is dc 3 V and fed with regulated dc power supply from external power voltage jack.
- Signal path.
- [ ] : FM
- [ ] : TAPE (PB)
- [ ] : TAPE (REC)

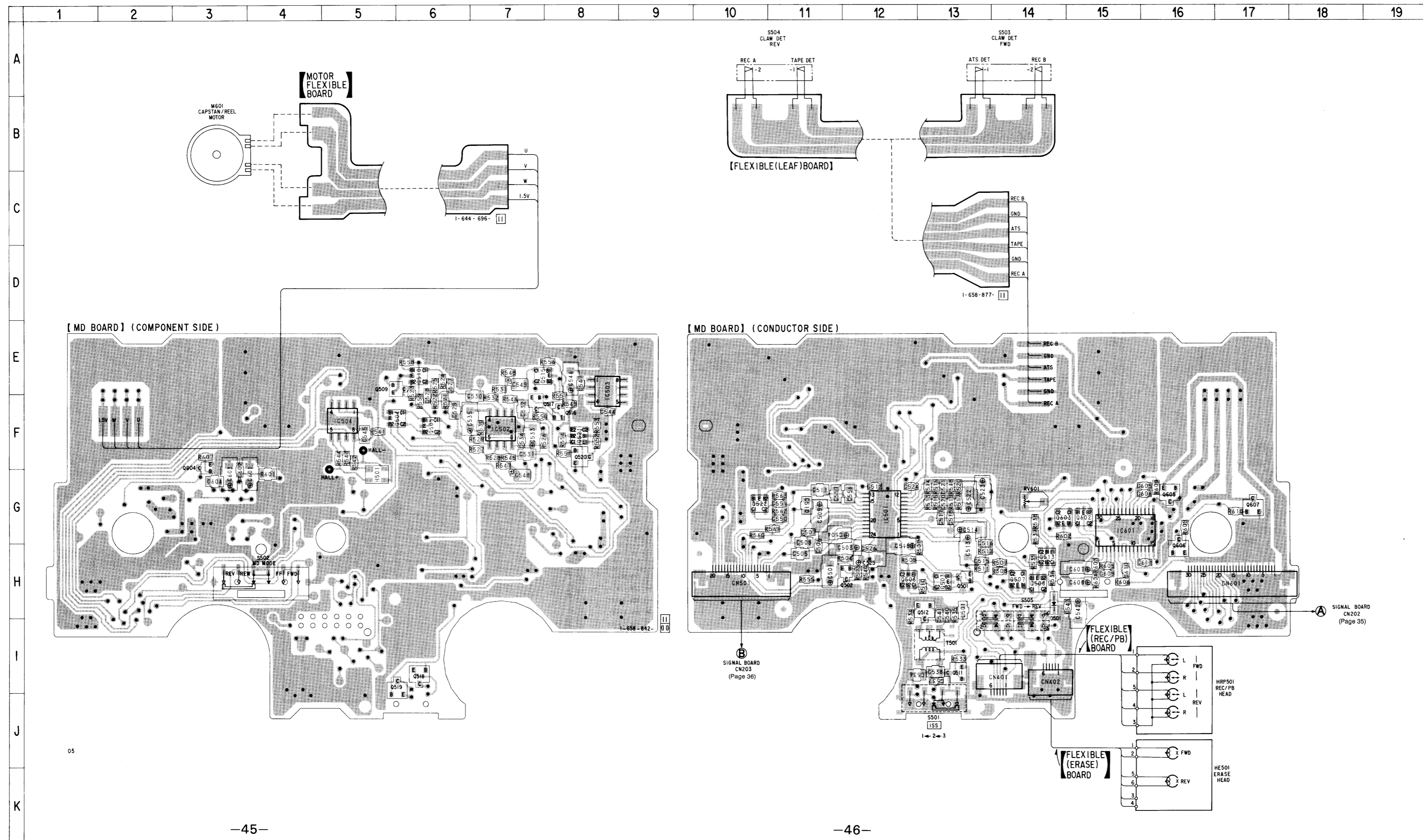

● Semiconductor Location

Ref. No.	Location
D501	H-14
IC501	G-12
IC502	F-7
IC503	E-8
IC504	F-5
IC601	G-15
Q501	H-13
Q502	H-12
Q503	H-13
Q504	F-5
Q505	F-6
Q506	H-12
Q507	H-14
Q508	H-14
Q509	E-5
Q510	E-6
Q511	I-13
Q512	H-13
Q513	H-14
Q515	E-7
Q516	F-8
Q517	F-7
Q518	I-6
Q519	I-5
Q520	F-8
Q521	F-8
Q522	G-10
Q602	G-15
Q603	G-14
Q604	F-3
Q605	G-16
Q606	H-16
Q607	G-17

**Note on Printed Wiring Board:**

- : parts extracted from the component side.
- : parts extracted from the conductor side.
- : Through hole.
- ▨ : Pattern from the side which enables seeing.

(The other layers' patterns are not indicated.)

**Caution:**

Pattern face side: Parts on the pattern face side seen from the pattern face are indicated.

Parts face side: Parts on the parts face side seen from the parts face are indicated.

• Waveforms

⑥ IC701 2.04Vp-p, 2MHz

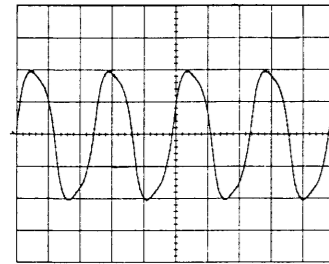

⑦ IC701 1.5Vp-p, 2MHz

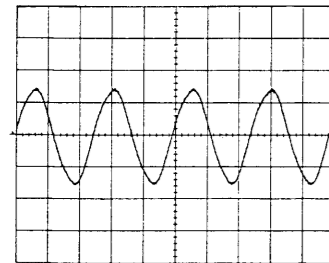

⑧ IC701 2Vp-p, 32.768kHz

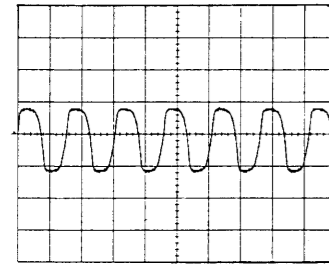

⑨ IC701 1.3Vp-p, 32.768kHz

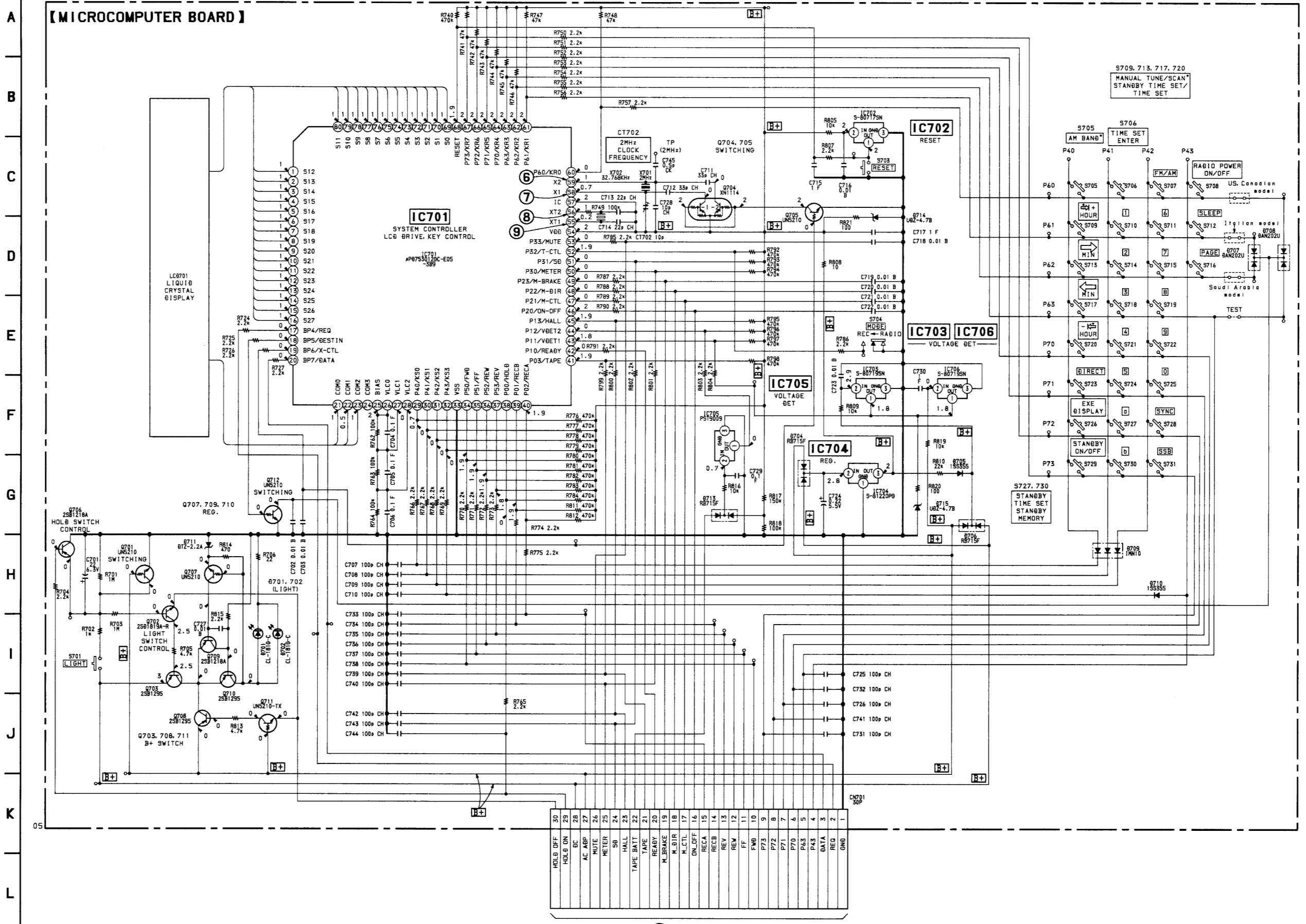
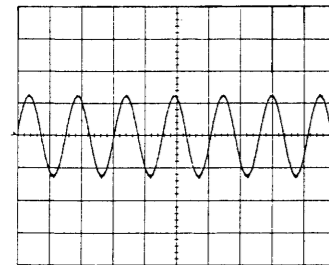



**6-7. IC PIN FUNCTION DESCRIPTION**

**SIGNAL BOARD IC201  $\mu$ PD1724GB-687-1A7 (PLL SYNTHESIZER CONTROLLER)**

Pin No.	Pin Name	I/O	Function
1	LCD10	O	Not used this set
2	LCD9	O	Not used this set
3	LCD8	O	Not used this set
4	LCD7	O	Not used this set
5	LCD6	O	Not used this set
6	LCD5	O	Not used this set
7	LCD4	O	Not used this set
8	LCD3	O	Not used this set
9	LCD2	O	Not used this set
10	LCD1	O	Not used this set
11	NC	-	No connection
12	COM3	O	Not used this set
13	COM2	O	Not used this set
14	COM1	O	Not used this set
15	VSS3	-	Not used this set
16	CAP2	-	Not used this set
17	CAP1	-	Not used this set
18	VSS2	-	Not used this set
19	VDP=H_MUTE	O	Applies half mute during cue review (H during cue review only)
20	CGP=BEEP	O	Not used this set
21	NC	-	No connection
22	+B	-	Power supply terminal
23	VHF	I	FM local oscillation input terminal (86.7 MHz-118.7 MHz)
24	HF	I	AM local oscillation input terminal (55.995 MHz-85.844 MHz)
25	AM	I	Not used this set
26	GND	-	Ground terminal
27	EO1	O	Not used this set
28	EO2	O	PLL error output terminal
29	CE	I	CE is connected to the power supply
30	X1	-	Connects 75 KHz X'tal
31	X2	-	
32	VSS4	-	Not used this set
33	PA3=RADIO/TAPE	O	Controls the power supply for the radio system
34	PA2=REC/PB	O	Switches the record and playback AMP status (REC/PB)
35	PA1=AM/FM	O	Switches the power supply between AM circuit and FM circuit
36	PA0=ROD/BAR	O	Switches the power supply between rod antenna and bar antenna
37	PB3 D/A	O	For 100 Hz step at SSB
38	PB2 D/A	O	
39	PB1 D/A	O	
40	PB0 D/A	O	

Pin No.	Pin Name	I/O	Function
41	PC3=ENV/PSN	O	PSN/ENV select "H" : ENV "L" : PSN
42	PC2=SSB/SYNC	O	SSB/SYNC select "H" : SSB "L" : SYNC
43	PC1=L/U	O	LSB/USB select "H" : LSB "L" : USB
44	PC0=READY	O	Ready signal output to system control (IC701)
45	K3=REQ	I	Data signal input from system control (IC701)
46	K2=DATA	I	Request signal input from system control (IC701)
47	K1	I	Not used this set
48	K0	I	Not used this set
49	NC	-	No connection
50	NC	-	No connection
51	LCD16	O	Not used this set
52	LCD15	O	Not used this set
53	LCD14	O	Not used this set
54	LCD13	O	Not used this set
55	LCD12	O	Not used this set
56	LCD11	O	Not used this set

**MICROCOMPUTER BOARD IC701  $\mu$ PD753012GC-E05-3B9 (SYSTEM CONTROLLER, LCD DRIVE, KEY CONTROL)**

Pin No.	Pin Name	I/O	Function
1	S12	O	Segment signal output to LCD (LCD701)
2	S13	O	Segment signal output to LCD (LCD701)
3	S14	O	Segment signal output to LCD (LCD701)
4	S15	O	Segment signal output to LCD (LCD701)
5	S16	O	Segment signal output to LCD (LCD701)
6	S17	O	Segment signal output to LCD (LCD701)
7	S18	O	Segment signal output to LCD (LCD701)
8	S19	O	Segment signal output to LCD (LCD701)
9	S20	O	Segment signal output to LCD (LCD701)
10	S21	O	Segment signal output to LCD (LCD701)
11	S22	O	Segment signal output to LCD (LCD701)
12	S23	O	Segment signal output to LCD (LCD701)
13	S24	O	Segment signal output to LCD (LCD701)
14	S25	O	Segment signal output to LCD (LCD701)
15	S26	O	Segment signal output to LCD (LCD701)
16	S27	O	Segment signal output to LCD (LCD701)
17	BP4/REQ	O	Request signal output to PLL synthesizer control (IC201)
18	BP5/DESTIN	O	Source signal output terminal for destination judgment
19	BP6/X-CTL	O	Used for shifting the system clock (2 MHz)
20	BP7/DATA	O	Data signal output to PLL synthesizer control (IC201)
21	COM0	O	Common signal output to LCD (LCD701)
22	COM1	O	Common signal output to LCD (LCD701)
23	COM2	O	Common signal output to LCD (LCD701)
24	COM3	O	Not used this set
25	BIAS	-	Output terminal for cutting off external split resistor
26	VLC0	-	LCD drive power terminal
27	VLC1	-	Split resistor is connected externally
28	VLC2	-	(1/3 duty, 1/3 bias)
29	P40/KS0	O	Key source signal output terminal
30	P41/KS1	O	Key source signal output terminal
31	P42/KS2	O	Key source signal output terminal
32	P43/KS3	O	Key source signal output terminal
33	VSS	-	Ground terminal
34	P50/FWD	I	Judges the mechanical deck status
35	P51/FF	I	
36	P52/REW	I	
37	P53/REV	I	
38	P00/HOLD	I	Detects the ON/OFF of key HOLD
39	P01/REC B	I	Detects an erase protect notch on the side-B of tape
40	P02/REC A	I	Detects an erase protect notch on the side-A of tape

Pin No.	Pin Name	I/O	Function
41	P03/TAPE	I	Detects the presence of a tape
42	P10/READY	I	Ready signal input from PLL synthesizer control (IC201)
43	P11/VDET1	I	Detects the voltage of main battery
44	P12/VDET2	I	Detects the voltage for motor battery
45	P13/HALL	I	Detects the motor rotation
46	P20/ON-OFF	O	Controls the power supply
47	P21/M-CTL	O	Controls the motor
48	P22/M-DIR	O	
49	P23/M-BRAKE	O	
50	P30/METER	I	Judges the AM scan stop
51	P31/SD	I	Judges FM scan stop and SYNC lock status
52	P32/T-CTL	I	Detects the timer switching
53	P33/MUTE	O	Mute signal output terminal "H" : MUTE ON
54	VDD	-	Power supply terminal
55	XT1	-	Connects sub clock X'tal (32 KHz)
56	XT2	-	
57	IC	-	No connection
58	X1	-	Connects main clock X'tal (2 MHz)
59	X2	-	
60	P60/KR0	I	Key return signal input terminal
61	P61/KR1	I	Key return signal input terminal
62	P62/KR2	I	Key return signal input terminal
63	P63/KR3	I	Key return signal input terminal
64	P70/KR4	I	Key return signal input terminal
65	P71/KR5	I	Key return signal input terminal
66	P72/KR6	I	Key return signal input terminal
67	P73/KR7	I	Key return signal input terminal
68	RESET	I	System reset input terminal
69	S0	O	Segment signal output to LCD (LCD701)
70	S1	O	Segment signal output to LCD (LCD701)
71	S2	O	Segment signal output to LCD (LCD701)
72	S3	O	Segment signal output to LCD (LCD701)
73	S4	O	Segment signal output to LCD (LCD701)
74	S5	O	Segment signal output to LCD (LCD701)
75	S6	O	Segment signal output to LCD (LCD701)
76	S7	O	Segment signal output to LCD (LCD701)
77	S8	O	Segment signal output to LCD (LCD701)
78	S9	O	Segment signal output to LCD (LCD701)
79	S10	O	Segment signal output to LCD (LCD701)
80	S11	O	Segment signal output to LCD (LCD701)





(2) CHASSIS SECTION

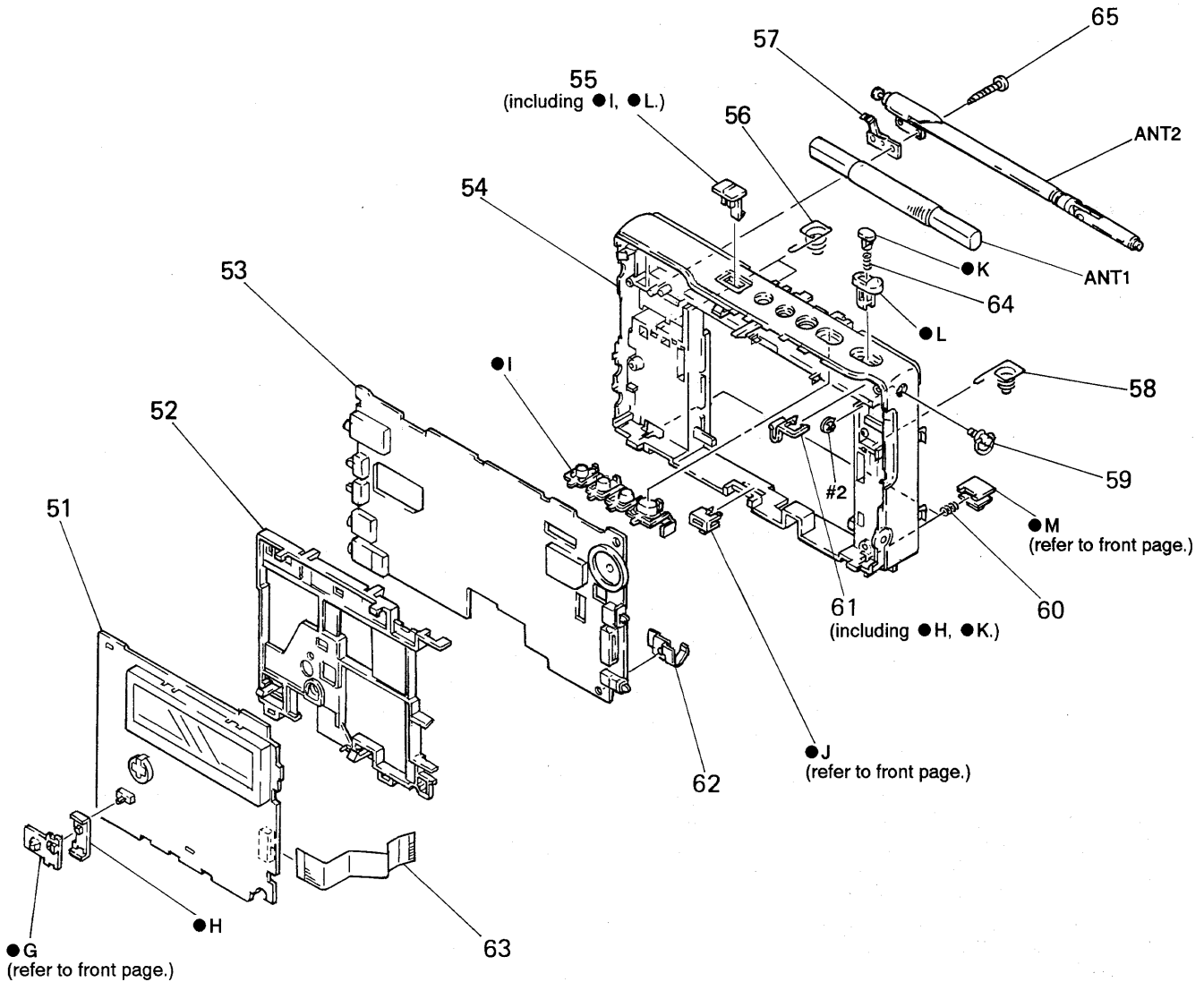

Ref. No.	Part No.	Description	Remark
51	A-3662-419-A	MICROCOMPUTER BOARD, COMPLETE	
52	3-929-769-01	CHASSIS (SUB)	
53	A-3662-421-A	SIGNAL BOARD, COMPLETE	
54	3-929-768-01	CHASSIS (MAIN)	
55	3-929-748-01	KNOB (COMBINED) (including KNOB (HOLD)/KNOB (REC)/ BUTTON (PLAY))	
56	3-930-222-01	SPRING (B), BATTERY COIL	
57	3-929-856-01	PLATE (ANT), CONTACT	
58	3-929-656-01	SPRING (A), BATTERY COIL	
59	3-930-466-01	BRACKET (HAND STRAP)	

Ref. No.	Part No.	Description	Remark
60	3-378-943-01	SPRING (WIND)	
61	3-929-744-01	SLIDER (COMBINED) (including POINTER/BUTTON (REC)/ SLIDER (REC))	
62	3-929-845-01	PLATE (TC), CONTACT, BATTERY	
63	1-658-875-11	FLEXIBLE (B) BOARD	
64	3-896-660-01	SPRING, COMPRESSION	
65	3-933-239-01	SCREW +BTP 2X10	
ANT1	1-501-793-11	ANTENNA, FERRITE-ROD (LW. MW)	
ANT2	1-501-794-11	ANTENNA, TELESCOPIC (FM)	

(3) MD, MECHANISM SECTION-1  
(MT-WMRX707-60)

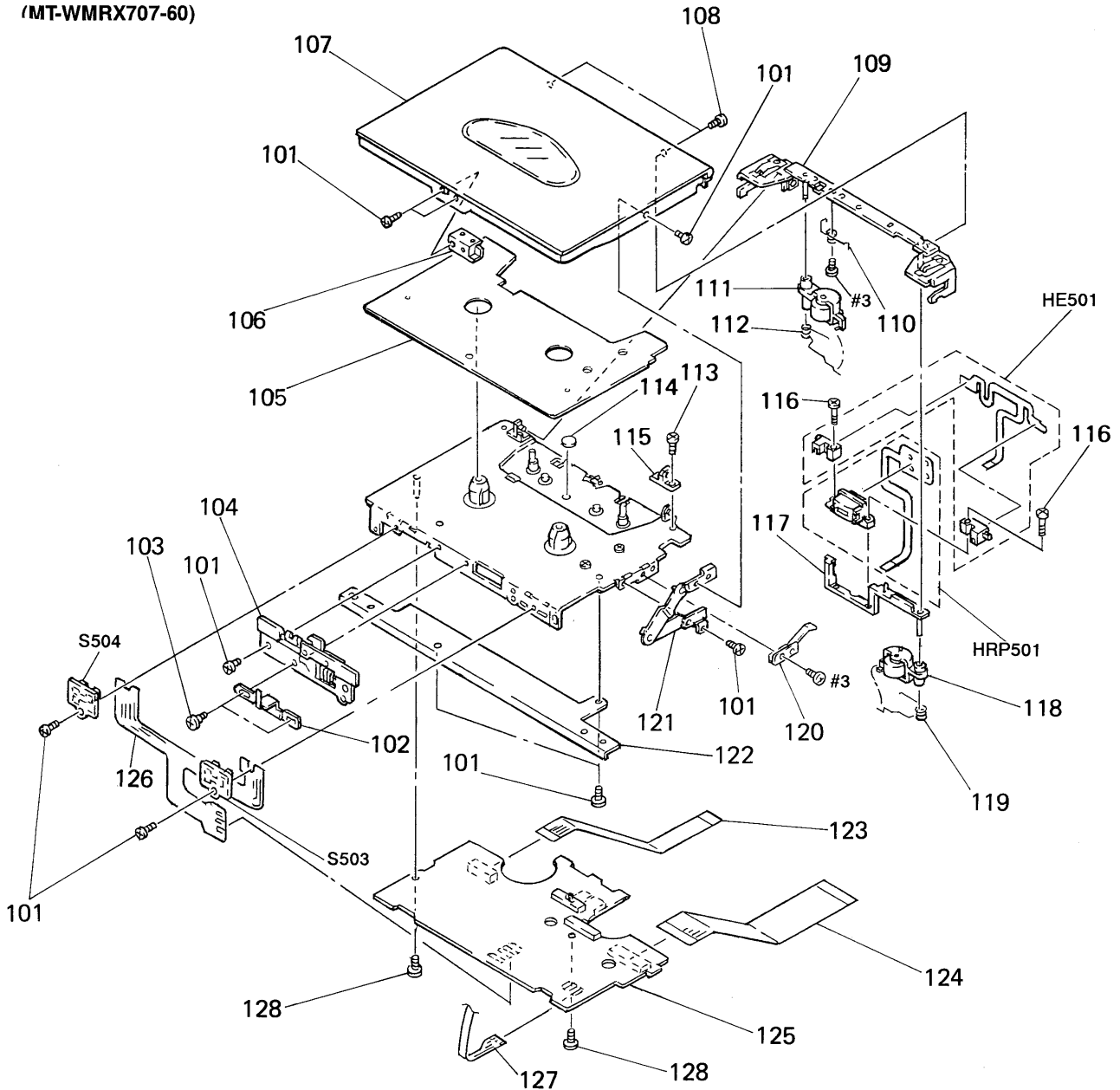

Ref. No.	Part No.	Description	Remark	Ref. No.	Part No.	Description	Remark
101	3-704-197-11	SCREW (M1.4X2.0), LOCKING		* 117	3-386-646-01	LEVER, HEAD	
102	3-929-841-01	LEVER (OPEN)		118	X-3366-296-1	PINCH LEVER (R) ASSY	
103	3-929-894-01	SCREW (M1.4), PRECISION STEP		119	3-386-685-02	SPRING (PINCH R)	
104	X-3366-556-1	BRACKET ASSY		120	3-929-844-01	SPRING (EJECT)	
105	3-929-853-01	COVER, MD		121	X-3368-975-1	ARM ASSY, CLICK	
106	3-929-776-01	LOCKER, OPEN		122	3-929-840-01	BRACKET	
107	X-3371-208-1	LID ASSY, CASSETTE		123	1-658-876-11	FLEXIBLE (C) BOARD	
108	3-365-630-11	SCREW (M1.4)		124	1-658-874-11	FLEXIBLE (A) BOARD	
109	X-3366-299-1	HOLDER ASSY		125	A-3662-423-A	MD BOARD, COMPLETE	
110	3-386-683-01	SPRING (H)		126	1-658-877-11	FLEXIBLE (LEAF) BOARD	
111	X-3366-298-1	PINCH LEVER (N) ASSY		127	1-644-696-11	MOTOR FLEXIBLE BOARD	
112	3-386-684-02	SPRING (PINCH N)		128	3-366-892-01	SCREW (M1.4X1.1)	
113	3-704-197-21	SCREW (M1.4X2.5), LOCKING		HE501	1-500-059-11	HEAD, MAGNETIC (ERASE)	
* 114	3-378-826-01	SHEET (AB)		HRP501	1-500-060-11	HEAD, MAGNETIC (RECORD/PLAYBACK)	
115	3-386-704-01	GUIDE (B), HOLDER		S503	1-692-100-11	SWITCH, LEAF (CLAW DET FWD(ATS/REC B))	
116	3-389-448-01	SCREW (M1.4), STEP		S504	1-692-101-11	SWITCH, LEAF (CLAW DET REV(TAPE/REC A))	

(4) MD, MECHANISM SECTION-2  
(MT-WMRX707-60)

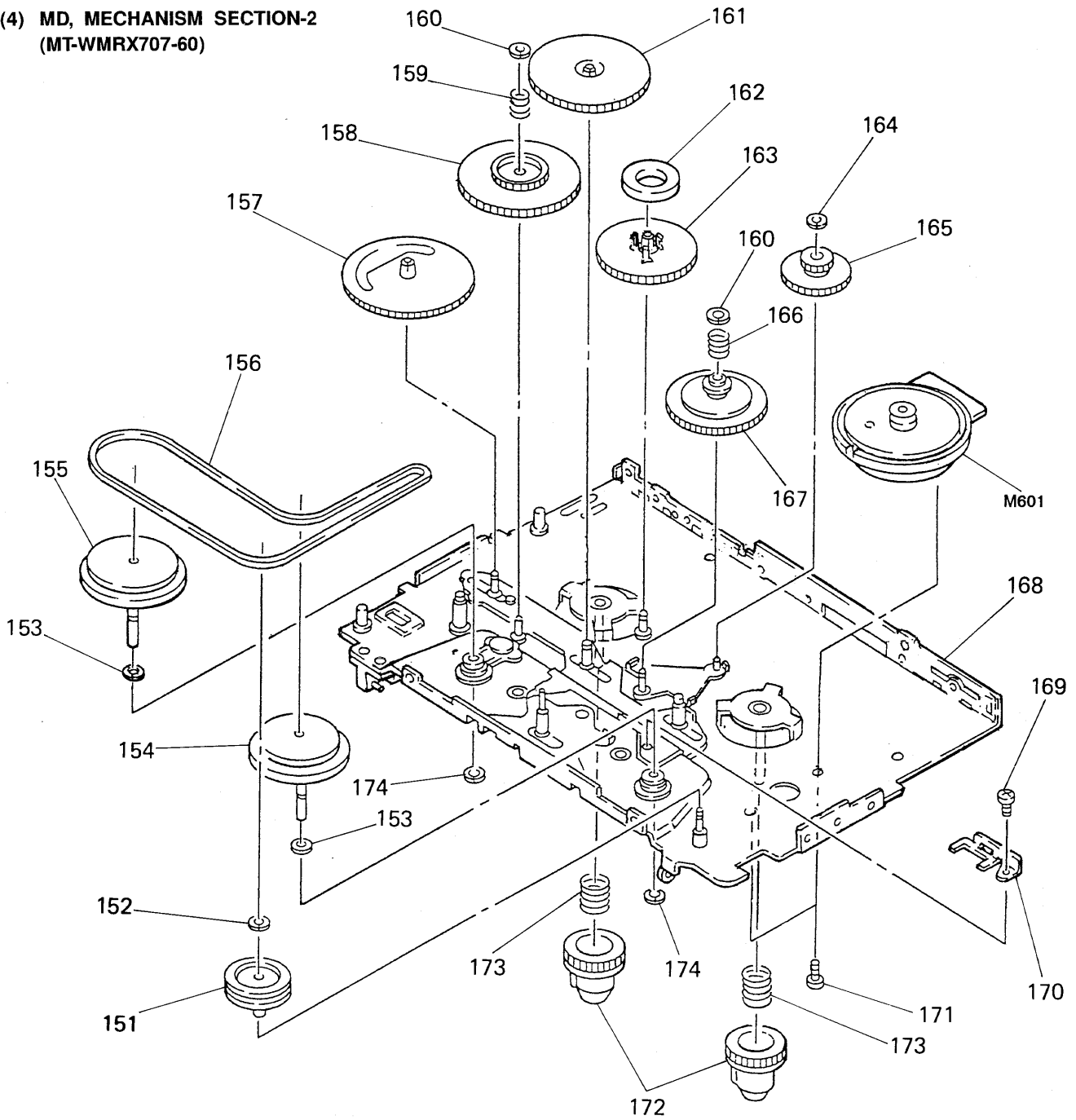

Ref. No.	Part No.	Description	Remark	Ref. No.	Part No.	Description	Remark
151	3-386-711-01	PULLEY (REVERSE)		164	3-338-645-31	WASHER (0.8-2.5)	
152	3-338-645-21	WASHER (0.8-2.5)		165	3-386-632-01	GEAR (D)	
153	3-386-694-01	WASHER		166	3-904-227-01	SPRING, COMPRESSION	
154	X-3368-637-1	WHEEL (RS) ASSY, CAPSTAN		167	X-3370-392-2	CLUTCH ASSY	
155	X-3368-636-1	WHEEL (NS) ASSY, CAPSTAN		168	X-3366-295-1	CHASSIS ASSY (K)	
156	3-908-638-01	BELT		169	3-366-892-01	SCREW (M1.4X1.1)	
157	3-386-852-01	GEAR (CAM)		* 170	3-906-049-01	LEVER (REC), SELECTION	
158	3-386-631-01	GEAR (A)		171	3-906-045-01	SCREW	
159	3-386-663-01	SPRING, COMPRESSION		172	3-386-634-03	GEAR (REEL)	
160	3-906-183-01	WASHER		173	3-386-662-01	SPRING, COMPRESSION	
161	3-386-691-01	GEAR (B)		174	3-325-394-01	WASHER, STOPPER	
162	3-386-706-01	MAGNET		M601	1-698-084-11	MOTOR	
163	3-386-633-01	GEAR (E)					

## SECTION 8 ELECTRICAL PARTS LIST

**FLEXIBLE (LEAF)**

**MD**

**NOTE:**

- Due to standardization, replacements in the parts list may be different from the parts specified in the diagrams or the components used on the set.
- -XX and -X mean standardized parts, so they may have some difference from the original one.
- RESISTORS  
All resistors are in ohms.  
METAL: Metal-film resistor.  
METAL OXIDE: Metal oxide-film resistor.  
F: nonflammable
- Abbreviation  
IT: Italian      EA: Saudi Arabia      JE: Tourist

- Items marked "\*" are not stocked since they are seldom required for routine service. Some delay should be anticipated when ordering these items.
- SEMICONDUCTORS  
In each case, u:  $\mu$ , for example:  
uA ..:  $\mu$ A.    uPA..:  $\mu$ PA.  
uPB..:  $\mu$ PB.    uPC..:  $\mu$ PC.    uPD..:  $\mu$ PD.
- CAPACITORS  
uF:  $\mu$ F
- COILS  
uH:  $\mu$ H

When indicating parts by reference number, please include the board.

The components identified by mark  $\Delta$  or dotted line with mark  $\Delta$  are critical for safety. Replace only with part number specified.

Les composants identifiés par une marque  $\Delta$  sont critiques pour la sécurité. Ne les remplacer que par une pièce portant le numéro spécifié.

Ref. No.	Part No.	Description	Remark	Ref. No.	Part No.	Description	Remark
	1-658-877-11	FLEXIBLE (LEAF) BOARD *****		C532	1-164-346-11	CERAMIC CHIP 1uF	16V
S503	1-692-100-11	SWITCH, LEAF (CLAW DET FWD(ATS/REC B))		C533	1-104-847-11	TANTAL. CHIP 22uF	20% 4V
S504	1-692-101-11	SWITCH, LEAF (CLAW DET REV(TAPE/REC A))		C534	1-162-970-11	CERAMIC CHIP 0.01uF	10% 25V
*****				C535	1-135-259-11	TANTAL. CHIP 10uF	20% 6.3V
A-3662-423-A	MD BOARD, COMPLETE *****			C536	1-163-137-00	CERAMIC CHIP 680PF	5% 50V
		< CAPACITOR >		C537	1-164-315-11	CERAMIC CHIP 470PF	5% 50V
C501	1-104-847-11	TANTAL. CHIP 22uF	20% 4V	C538	1-163-145-00	CERAMIC CHIP 0.0015uF	5% 50V
C503	1-135-151-21	TANTALUM CHIP 4.7uF	20% 4V	C540	1-164-172-11	CERAMIC CHIP 0.0056uF	10% 25V
C504	1-135-151-21	TANTALUM CHIP 4.7uF	20% 4V	C541	1-162-964-11	CERAMIC CHIP 0.001uF	10% 50V
C505	1-164-489-11	CERAMIC CHIP 0.22uF	10% 16V	C542	1-104-847-11	TANTAL. CHIP 22uF	20% 4V
C506	1-162-970-11	CERAMIC CHIP 0.01uF	10% 25V	C543	1-162-970-11	CERAMIC CHIP 0.01uF	10% 25V
C507	1-162-970-11	CERAMIC CHIP 0.01uF	10% 25V	C544	1-162-970-11	CERAMIC CHIP 0.01uF	10% 25V
C508	1-164-489-11	CERAMIC CHIP 0.22uF	10% 16V	C545	1-164-346-11	CERAMIC CHIP 1uF	16V
C509	1-135-151-21	TANTALUM CHIP 4.7uF	20% 4V	C546	1-104-847-11	TANTAL. CHIP 22uF	20% 4V
C510	1-164-346-11	CERAMIC CHIP 1uF	16V	C547	1-162-970-11	CERAMIC CHIP 0.01uF	10% 25V
C511	1-164-346-11	CERAMIC CHIP 1uF	16V	C548	1-107-811-11	TANTAL. CHIP 47uF	20% 4V
C512	1-162-970-11	CERAMIC CHIP 0.01uF	10% 25V	C549	1-107-811-11	TANTAL. CHIP 47uF	20% 4V
C513	1-135-151-21	TANTALUM CHIP 4.7uF	20% 4V	C550	1-162-970-11	CERAMIC CHIP 0.01uF	10% 25V
C514	1-135-151-21	TANTALUM CHIP 4.7uF	20% 4V	C551	1-162-970-11	CERAMIC CHIP 0.01uF	10% 25V
C515	1-162-967-11	CERAMIC CHIP 0.0033uF	10% 50V	C556	1-164-346-11	CERAMIC CHIP 1uF	16V
C516	1-162-967-11	CERAMIC CHIP 0.0033uF	10% 50V	C557	1-164-346-11	CERAMIC CHIP 1uF	16V
C517	1-164-392-11	CERAMIC CHIP 390PF	10% 50V	C601	1-135-145-11	TANTALUM CHIP 0.47uF	10% 35V
C518	1-164-392-11	CERAMIC CHIP 390PF	10% 50V	C602	1-165-176-11	CERAMIC CHIP 0.047uF	10% 16V
C519	1-104-847-11	TANTAL. CHIP 22uF	20% 4V	C603	1-135-091-91	TANTAL. CHIP 1uF	20% 16V
C520	1-164-172-11	CERAMIC CHIP 0.0056uF	10% 25V	C604	1-164-492-11	CERAMIC CHIP 0.15uF	10% 16V
C521	1-164-172-11	CERAMIC CHIP 0.0056uF	10% 25V	C605	1-107-826-11	CERAMIC CHIP 0.1uF	10% 16V
C522	1-107-685-11	TANTAL. CHIP 15uF	20% 6.3V	C606	1-107-826-11	CERAMIC CHIP 0.1uF	10% 16V
C523	1-107-685-11	TANTAL. CHIP 15uF	20% 6.3V	C607	1-135-091-91	TANTAL. CHIP 1uF	20% 16V
C524	1-162-970-11	CERAMIC CHIP 0.01uF	10% 25V	C608	1-135-091-91	TANTAL. CHIP 1uF	20% 16V
C525	1-104-847-11	TANTAL. CHIP 22uF	20% 4V	C609	1-110-563-11	CERAMIC CHIP 0.068uF	10% 16V
C526	1-162-970-11	CERAMIC CHIP 0.01uF	10% 25V	C610	1-110-563-11	CERAMIC CHIP 0.068uF	10% 16V
C527	1-164-677-11	CERAMIC CHIP 0.033uF	10% 16V	C611	1-107-826-11	CERAMIC CHIP 0.1uF	10% 16V
C528	1-164-677-11	CERAMIC CHIP 0.033uF	10% 16V	< CONNECTOR >			
C529	1-164-346-11	CERAMIC CHIP 1uF	16V	* CN401	1-764-051-11	CONNECTOR, FPC (ZIF) 6P	
C530	1-164-346-11	CERAMIC CHIP 1uF	16V	* CN402	1-764-051-11	CONNECTOR, FPC (ZIF) 6P	
C531	1-164-346-11	CERAMIC CHIP 1uF	16V	CN501	1-573-929-11	CONNECTOR, FFC/FPC (ZIF) 20P	
				* CN601	1-573-939-11	CONNECTOR, FFC/FPC (ZIF) 30P	

Ref. No.	Part No.	Description	Remark	Ref. No.	Part No.	Description	Remark
		< DIODE >					
D501	8-719-988-62	DIODE 1SS355		R503	1-216-837-11	METAL CHIP 22K 5%	1/16W
		< HOLE ELEMENT >		R504	1-216-856-11	METAL CHIP 820K 5%	1/16W
H501	8-759-052-95	HALL ELEMENT HW-101AFT-DEF		R507	1-216-837-11	METAL CHIP 22K 5%	1/16W
		< IC >		R508	1-216-837-11	METAL CHIP 22K 5%	1/16W
IC501	8-759-062-63	IC TA8155FN		R509	1-216-817-11	METAL CHIP 470 5%	1/16W
IC502	8-759-298-70	IC BA4510F-T1		R510	1-216-817-11	METAL CHIP 470 5%	1/16W
IC503	8-759-804-76	IC LA5002M		R511	1-216-834-11	METAL CHIP 12K 5%	1/16W
IC504	8-759-510-73	IC BA10393F-E2		R512	1-216-834-11	METAL CHIP 12K 5%	1/16W
IC601	8-759-996-15	IC TLP326ADB		R513	1-216-854-11	METAL CHIP 560K 5%	1/16W
		< COIL >		R514	1-216-854-11	METAL CHIP 560K 5%	1/16W
L501	1-412-996-31	INDUCTOR 27uH		R515	1-216-838-11	METAL CHIP 27K 5%	1/16W
		< TRANSISTOR >		R516	1-216-838-11	METAL CHIP 27K 5%	1/16W
Q501	8-729-402-32	TRANSISTOR 2SD1819A-R		R517	1-216-838-11	METAL CHIP 27K 5%	1/16W
Q502	8-729-402-32	TRANSISTOR 2SD1819A-R		R518	1-216-838-11	METAL CHIP 27K 5%	1/16W
Q503	8-729-423-75	TRANSISTOR XN1116		R519	1-216-817-11	METAL CHIP 470 5%	1/16W
Q504	8-729-403-07	TRANSISTOR XN1213		R520	1-216-817-11	METAL CHIP 470 5%	1/16W
Q505	8-729-422-41	TRANSISTOR XN1114		R521	1-216-824-11	METAL CHIP 1.8K 5%	1/16W
Q506	8-729-425-18	TRANSISTOR XN4504		R522	1-216-824-11	METAL CHIP 1.8K 5%	1/16W
Q507	8-729-422-41	TRANSISTOR XN1114		R523	1-216-833-11	METAL CHIP 10K 5%	1/16W
Q508	8-729-403-07	TRANSISTOR XN1213		R524	1-216-825-11	METAL CHIP 2.2K 5%	1/16W
Q509	8-729-420-44	TRANSISTOR UN5210		R525	1-216-825-11	METAL CHIP 2.2K 5%	1/16W
Q510	8-729-402-13	TRANSISTOR XN1501		R526	1-216-797-11	METAL CHIP 10 5%	1/16W
Q511	8-729-800-37	TRANSISTOR 2SD1048-X7		R527	1-216-833-11	METAL CHIP 10K 5%	1/16W
Q512	8-729-800-37	TRANSISTOR 2SD1048-X7		R528	1-216-829-11	METAL CHIP 4.7K 5%	1/16W
Q513	8-729-402-16	TRANSISTOR XN4608		R529	1-216-845-11	METAL CHIP 100K 5%	1/16W
Q515	8-729-402-13	TRANSISTOR XN1501		R530	1-216-845-11	METAL CHIP 100K 5%	1/16W
Q516	8-729-402-32	TRANSISTOR 2SD1819A-R		R531	1-216-829-11	METAL CHIP 4.7K 5%	1/16W
Q517	8-729-420-44	TRANSISTOR UN5210		R532	1-216-833-11	METAL CHIP 10K 5%	1/16W
Q518	8-729-800-37	TRANSISTOR 2SD1048-X7		R533	1-216-829-11	METAL CHIP 4.7K 5%	1/16W
Q519	8-729-800-37	TRANSISTOR 2SD1048-X7		R534	1-216-789-11	METAL CHIP 2.2 5%	1/16W
Q520	8-729-807-87	TRANSISTOR 2SB1295-UL6		R535	1-216-838-11	METAL CHIP 27K 5%	1/16W
Q521	8-729-402-16	TRANSISTOR XN4608		R536	1-216-797-11	METAL CHIP 10 5%	1/16W
Q522	8-729-403-07	TRANSISTOR XN1213		R537	1-216-829-11	METAL CHIP 4.7K 5%	1/16W
Q602	8-729-422-41	TRANSISTOR XN1114		R538	1-216-841-11	METAL CHIP 47K 5%	1/16W
Q603	8-729-403-07	TRANSISTOR XN1213		R539	1-216-841-11	METAL CHIP 47K 5%	1/16W
Q604	8-729-402-32	TRANSISTOR 2SD1819A-R		R540	1-216-797-11	METAL CHIP 10 5%	1/16W
Q605	8-729-807-87	TRANSISTOR 2SB1295-UL6		R541	1-216-797-11	METAL CHIP 10 5%	1/16W
Q606	8-729-807-87	TRANSISTOR 2SB1295-UL6		R542	1-216-821-11	METAL CHIP 1K 5%	1/16W
Q607	8-729-807-87	TRANSISTOR 2SB1295-UL6		R543	1-216-821-11	METAL CHIP 1K 5%	1/16W
		< RESISTOR >		R544	1-216-821-11	METAL CHIP 1K 5%	1/16W
R501	1-216-841-11	METAL CHIP 47K 5%	1/16W	R545	1-216-829-11	METAL CHIP 4.7K 5%	1/16W
				R546	1-216-829-11	METAL CHIP 4.7K 5%	1/16W
				R547	1-216-821-11	METAL CHIP 1K 5%	1/16W
				R548	1-216-821-11	METAL CHIP 1K 5%	1/16W
				R549	1-216-827-11	METAL CHIP 3.3K 5%	1/16W
				R550	1-216-841-11	METAL CHIP 47K 5%	1/16W
				R551	1-216-841-11	METAL CHIP 47K 5%	1/16W
				R552	1-216-841-11	METAL CHIP 47K 5%	1/16W
				R553	1-216-845-11	METAL CHIP 100K 5%	1/16W

<b>MD</b>	<b>MICROCOMPUTER</b>
-----------	----------------------

Ref. No.	Part No.	Description	Remark		
R554	1-216-829-11	METAL CHIP	4.7K	5%	1/16W
R555	1-216-826-11	METAL CHIP	2.7K	5%	1/16W
R556	1-216-821-11	METAL CHIP	1K	5%	1/16W
R557	1-216-821-11	METAL CHIP	1K	5%	1/16W
R558	1-216-829-11	METAL CHIP	4.7K	5%	1/16W
R559	1-216-829-11	METAL CHIP	4.7K	5%	1/16W
R560	1-216-830-11	METAL CHIP	5.6K	5%	1/16W
R561	1-216-830-11	METAL CHIP	5.6K	5%	1/16W
R562	1-216-827-11	METAL CHIP	3.3K	5%	1/16W
R563	1-216-827-11	METAL CHIP	3.3K	5%	1/16W
R601	1-216-068-00	METAL CHIP	6.2K	5%	1/10W
R602	1-216-833-11	METAL CHIP	10K	5%	1/16W
R603	1-216-845-11	METAL CHIP	100K	5%	1/16W
R604	1-216-839-11	METAL CHIP	33K	5%	1/16W
R605	1-216-835-11	METAL CHIP	15K	5%	1/16W
R606	1-216-793-11	METAL GLAZE	4.7	5%	1/16W
R607	1-216-827-11	METAL CHIP	3.3K	5%	1/16W
R608	1-216-809-11	METAL CHIP	100	5%	1/16W
R609	1-216-809-11	METAL CHIP	100	5%	1/16W
R610	1-216-809-11	METAL CHIP	100	5%	1/16W
< VARIABLE RESISTOR >					
RV601	1-241-593-11	RES, ADJ, METAL GRAZE	4.7K		
< SWITCH >					
S501	1-762-079-11	SWITCH, SLIDE (ISS)			
S502	1-692-370-11	SWITCH, SLIDE (MD MODE)			
S505	1-692-589-11	SWITCH, SLIDE (FWD/REV)			
< TRANSFORMER >					
T501	1-411-447-21	COIL (BIAS OSC)			
*****					
A-3662-419-A MICROCOMPUTER BOARD, COMPLETE					
*****					
1-537-946-11 CONDUCTIVE BOARD, CONNECTION					
3-929-745-01 PLATE (COMBINDE), LIGHT GUIDE					
< CAPACITOR >					
C701	1-124-778-00	ELECT CHIP	22uF	20%	6.3V
C702	1-162-970-11	CERAMIC CHIP	0.01uF	10%	25V
C703	1-162-970-11	CERAMIC CHIP	0.01uF	10%	25V
C704	1-164-156-11	CERAMIC CHIP	0.1uF		25V
C705	1-164-156-11	CERAMIC CHIP	0.1uF		25V
C706	1-164-156-11	CERAMIC CHIP	0.1uF		25V
C707	1-162-927-11	CERAMIC CHIP	100PF	5%	50V
C708	1-162-927-11	CERAMIC CHIP	100PF	5%	50V
C709	1-162-927-11	CERAMIC CHIP	100PF	5%	50V
C710	1-162-927-11	CERAMIC CHIP	100PF	5%	50V

Ref. No.	Part No.	Description	Remark		
C711	1-162-921-11	CERAMIC CHIP	33PF	5%	50V
C712	1-162-921-11	CERAMIC CHIP	33PF	5%	50V
C713	1-162-919-11	CERAMIC CHIP	22PF	5%	50V
C714	1-162-919-11	CERAMIC CHIP	22PF	5%	50V
C715	1-164-346-11	CERAMIC CHIP	1uF		16V
C716	1-162-970-11	CERAMIC CHIP	0.01uF	10%	25V
C717	1-164-346-11	CERAMIC CHIP	1uF		16V
C718	1-162-970-11	CERAMIC CHIP	0.01uF	10%	25V
C719	1-162-970-11	CERAMIC CHIP	0.01uF	10%	25V
C720	1-162-970-11	CERAMIC CHIP	0.01uF	10%	25V
C721	1-162-970-11	CERAMIC CHIP	0.01uF	10%	25V
C722	1-162-970-11	CERAMIC CHIP	0.01uF	10%	25V
C723	1-162-970-11	CERAMIC CHIP	0.01uF	10%	25V
C724	1-125-486-11	DOUBLE LAYERS	0.22F		5.5V
C725	1-162-927-11	CERAMIC CHIP	100PF	5%	50V
C726	1-162-927-11	CERAMIC CHIP	100PF	5%	50V
C727	1-162-970-11	CERAMIC CHIP	0.01uF	10%	25V
C728	1-162-915-11	CERAMIC CHIP	10PF	0.5PF	50V
C729	1-164-156-11	CERAMIC CHIP	0.1uF		25V
C730	1-164-346-11	CERAMIC CHIP	1uF		16V
C731	1-162-927-11	CERAMIC CHIP	100PF	5%	50V
C732	1-162-927-11	CERAMIC CHIP	100PF	5%	50V
C733	1-162-927-11	CERAMIC CHIP	100PF	5%	50V
C734	1-162-927-11	CERAMIC CHIP	100PF	5%	50V
C735	1-162-927-11	CERAMIC CHIP	100PF	5%	50V
C736	1-162-927-11	CERAMIC CHIP	100PF	5%	50V
C737	1-162-927-11	CERAMIC CHIP	100PF	5%	50V
C738	1-162-927-11	CERAMIC CHIP	100PF	5%	50V
C739	1-162-927-11	CERAMIC CHIP	100PF	5%	50V
C740	1-162-927-11	CERAMIC CHIP	100PF	5%	50V
C741	1-162-927-11	CERAMIC CHIP	100PF	5%	50V
C742	1-162-927-11	CERAMIC CHIP	100PF	5%	50V
C743	1-162-927-11	CERAMIC CHIP	100PF	5%	50V
C744	1-162-927-11	CERAMIC CHIP	100PF	5%	50V
C745	1-162-904-11	CERAMIC CHIP	0.5PF	0.25PF	50V
< CONNECTOR >					
* CN701	1-573-939-11	CONNECTOR, FFC/FPC (ZIF) 30P			
< TRIMMER >					
CT702	1-141-327-11	CAP, VAR, TRIMMER (CHIP TYPE) 10P			
< DIODE >					
D701	8-719-037-71	LED	CL-181G-C		(LIGHT)
D702	8-719-037-71	LED	CL-181G-C		(LIGHT)
D704	8-719-988-82	DIODE	RB715F		
D705	8-719-988-62	DIODE	1SS355		
D706	8-719-988-82	DIODE	RB715F		

# MICROCOMPUTER

Ref. No.	Part No.	Description	Remark	Ref. No.	Part No.	Description	Remark
D707	8-719-941-86	DIODE DAN202U		R743	1-216-841-11	METAL CHIP 47K 5%	1/16W
D708	8-719-941-86	DIODE DAN202U		R744	1-216-841-11	METAL CHIP 47K 5%	1/16W
D709	8-719-951-22	DIODE 1MN10					
D710	8-719-988-62	DIODE 1SS355		R745	1-216-841-11	METAL CHIP 47K 5%	1/16W
D711	8-719-976-69	DIODE DTZ2. 2A		R746	1-216-841-11	METAL CHIP 47K 5%	1/16W
				R747	1-216-841-11	METAL CHIP 47K 5%	1/16W
D713	8-719-988-82	DIODE RB715F		R748	1-216-841-11	METAL CHIP 47K 5%	1/16W
D714	8-719-976-96	DIODE DTZ4. 7C		R749	1-216-845-11	METAL CHIP 100K 5%	1/16W
D715	8-719-976-96	DIODE DTZ4. 7C					
< IC >							
IC701	8-759-372-72	IC uPD753012GC-E05-3B9		R750	1-216-825-11	METAL CHIP 2. 2K 5%	1/16W
IC702	8-759-255-03	IC S-80717SN-DE-T1		R751	1-216-825-11	METAL CHIP 2. 2K 5%	1/16W
IC703	8-759-249-34	IC S-80719SN-DG		R752	1-216-825-11	METAL CHIP 2. 2K 5%	1/16W
IC704	8-759-255-04	IC S-81220PG-PS-T1		R753	1-216-825-11	METAL CHIP 2. 2K 5%	1/16W
IC705	8-759-372-71	IC PST9009NL		R754	1-216-825-11	METAL CHIP 2. 2K 5%	1/16W
IC706	8-759-249-34	IC S-80719SN-DG					
< LIQUID CRYSTAL DISPLAY >							
LCD701	1-810-964-11	DISPLAY PANEL, LIQUID CRYSTAL		R755	1-216-825-11	METAL CHIP 2. 2K 5%	1/16W
< TRANSISTOR >							
Q701	8-729-420-44	TRANSISTOR UN5210		R756	1-216-825-11	METAL CHIP 2. 2K 5%	1/16W
Q702	8-729-402-32	TRANSISTOR 2SD1819A-R		R757	1-216-825-11	METAL CHIP 2. 2K 5%	1/16W
Q703	8-729-807-87	TRANSISTOR 2SB1295-UL6		R762	1-216-845-11	METAL CHIP 100K 5%	1/16W
Q704	8-729-422-41	TRANSISTOR XN1114		R763	1-216-845-11	METAL CHIP 100K 5%	1/16W
Q705	8-729-420-44	TRANSISTOR UN5210					
Q706	8-729-402-55	TRANSISTOR 2SB1218A-R-TX		R764	1-216-845-11	METAL CHIP 100K 5%	1/16W
Q707	8-729-420-44	TRANSISTOR UN5210		R765	1-216-825-11	METAL CHIP 2. 2K 5%	1/16W
Q708	8-729-807-87	TRANSISTOR 2SB1295-UL6		R766	1-216-825-11	METAL CHIP 2. 2K 5%	1/16W
Q709	8-729-402-55	TRANSISTOR 2SB1218A-R-TX		R767	1-216-825-11	METAL CHIP 2. 2K 5%	1/16W
Q710	8-729-807-87	TRANSISTOR 2SB1295-UL6		R768	1-216-825-11	METAL CHIP 2. 2K 5%	1/16W
Q711	8-729-420-44	TRANSISTOR UN5210					
Q712	8-729-420-44	TRANSISTOR UN5210		R769	1-216-825-11	METAL CHIP 2. 2K 5%	1/16W
< RESISTOR >							
R701	1-216-857-11	METAL CHIP 1M 5%	1/16W	R770	1-216-825-11	METAL CHIP 2. 2K 5%	1/16W
R702	1-216-821-11	METAL CHIP 1K 5%	1/16W	R771	1-216-825-11	METAL CHIP 2. 2K 5%	1/16W
R703	1-216-857-11	METAL CHIP 1M 5%	1/16W	R772	1-216-825-11	METAL CHIP 2. 2K 5%	1/16W
R704	1-216-825-11	METAL CHIP 2. 2K 5%	1/16W	R773	1-216-825-11	METAL CHIP 2. 2K 5%	1/16W
R705	1-216-829-11	METAL CHIP 4. 7K 5%	1/16W				
R706	1-216-801-11	METAL CHIP 22 5%	1/16W	R774	1-216-825-11	METAL CHIP 2. 2K 5%	1/16W
R724	1-216-825-11	METAL CHIP 2. 2K 5%	1/16W	R775	1-216-825-11	METAL CHIP 2. 2K 5%	1/16W
R725	1-216-825-11	METAL CHIP 2. 2K 5%	1/16W	R776	1-216-853-11	METAL CHIP 470K 5%	1/16W
R726	1-216-825-11	METAL CHIP 2. 2K 5%	1/16W	R777	1-216-853-11	METAL CHIP 470K 5%	1/16W
R727	1-216-825-11	METAL CHIP 2. 2K 5%	1/16W	R778	1-216-853-11	METAL CHIP 470K 5%	1/16W
R740	1-216-853-11	METAL CHIP 470K 5%	1/16W				
R741	1-216-841-11	METAL CHIP 47K 5%	1/16W	R779	1-216-853-11	METAL CHIP 470K 5%	1/16W
R742	1-216-841-11	METAL CHIP 47K 5%	1/16W	R780	1-216-853-11	METAL CHIP 470K 5%	1/16W
				R781	1-216-853-11	METAL CHIP 470K 5%	1/16W
				R782	1-216-853-11	METAL CHIP 470K 5%	1/16W
				R783	1-216-853-11	METAL CHIP 470K 5%	1/16W
				R784	1-216-853-11	METAL CHIP 470K 5%	1/16W
				R785	1-216-825-11	METAL CHIP 2. 2K 5%	1/16W
				R786	1-216-825-11	METAL CHIP 2. 2K 5%	1/16W
				R787	1-216-825-11	METAL CHIP 2. 2K 5%	1/16W
				R788	1-216-825-11	METAL CHIP 2. 2K 5%	1/16W
				R789	1-216-825-11	METAL CHIP 2. 2K 5%	1/16W
				R790	1-216-825-11	METAL CHIP 2. 2K 5%	1/16W
				R791	1-216-825-11	METAL CHIP 2. 2K 5%	1/16W
				R792	1-216-853-11	METAL CHIP 470K 5%	1/16W
				R793	1-216-853-11	METAL CHIP 470K 5%	1/16W
				R794	1-216-853-11	METAL CHIP 470K 5%	1/16W



# MICROCOMPUTER

# MOTOR FLEXIBLE

# SIGNAL

Ref. No.	Part No.	Description	Remark
R795	1-216-853-11	METAL CHIP	470K 5% 1/16W
R796	1-216-853-11	METAL CHIP	470K 5% 1/16W
R797	1-216-853-11	METAL CHIP	470K 5% 1/16W
R798	1-216-853-11	METAL CHIP	470K 5% 1/16W
R799	1-216-825-11	METAL CHIP	2.2K 5% 1/16W
R800	1-216-825-11	METAL CHIP	2.2K 5% 1/16W
R801	1-216-825-11	METAL CHIP	2.2K 5% 1/16W
R802	1-216-825-11	METAL CHIP	2.2K 5% 1/16W
R803	1-216-825-11	METAL CHIP	2.2K 5% 1/16W
R804	1-216-825-11	METAL CHIP	2.2K 5% 1/16W
R805	1-216-833-11	METAL CHIP	10K 5% 1/16W
R807	1-216-825-11	METAL CHIP	2.2K 5% 1/16W
R808	1-216-797-11	METAL CHIP	10 5% 1/16W
R809	1-216-833-11	METAL CHIP	10K 5% 1/16W
R810	1-216-837-11	METAL CHIP	22K 5% 1/16W
R811	1-216-853-11	METAL CHIP	470K 5% 1/16W
R812	1-216-853-11	METAL CHIP	470K 5% 1/16W
R813	1-216-829-11	METAL CHIP	4.7K 5% 1/16W
R814	1-216-817-11	METAL CHIP	470 5% 1/16W
R815	1-216-825-11	METAL CHIP	2.2K 5% 1/16W
R816	1-216-833-11	METAL CHIP	10K 5% 1/16W
R817	1-216-847-11	METAL CHIP	150K 5% 1/16W
R818	1-216-845-11	METAL CHIP	100K 5% 1/16W
R819	1-216-833-11	METAL CHIP	10K 5% 1/16W
R820	1-216-809-11	METAL CHIP	100 5% 1/16W
R821	1-216-809-11	METAL CHIP	100 5% 1/16W
< SWITCH >			
S701	1-571-187-11	SWITCH, TACTIL (REFLOW TYPE) (LIGHT)	
S703	1-554-088-00	SWITCH, KEY BOARD (RESET)	
S704	1-553-977-31	SWITCH, SLIDE (MODE)	
S705	1-571-187-11	SWITCH, TACTIL (REFLOW TYPE) (AM BAND)	
S706	1-571-187-11	SWITCH, TACTIL (REFLOW TYPE) (TIME SET/ENTER)	
S707	1-571-187-11	SWITCH, TACTIL (REFLOW TYPE) (FM/AM)	
S708	1-571-187-11	SWITCH, TACTIL (REFLOW TYPE) (RADIO POWER ON/OFF)	
S709	1-571-187-11	SWITCH, TACTIL (REFLOW TYPE) (⇌)/HOUR)	
S710	1-571-187-11	SWITCH, TACTIL (REFLOW TYPE) (1)	
S711	1-571-187-11	SWITCH, TACTIL (REFLOW TYPE) (6)	
S712	1-571-187-11	SWITCH, TACTIL (REFLOW TYPE) (SLEEP)	
S713	1-571-187-11	SWITCH, TACTIL (REFLOW TYPE) (⇌)/MIN)	
S714	1-571-187-11	SWITCH, TACTIL (REFLOW TYPE) (2)	
S715	1-571-187-11	SWITCH, TACTIL (REFLOW TYPE) (7)	
S716	1-571-187-11	SWITCH, TACTIL (REFLOW TYPE) (PAGE)	
S717	1-571-187-11	SWITCH, TACTIL (REFLOW TYPE) (⇌)/MIN)	
S718	1-571-187-11	SWITCH, TACTIL (REFLOW TYPE) (3)	
S719	1-571-187-11	SWITCH, TACTIL (REFLOW TYPE) (8)	
S720	1-571-187-11	SWITCH, TACTIL (REFLOW TYPE) (⇌)/HOUR)	
S721	1-571-187-11	SWITCH, TACTIL (REFLOW TYPE) (4)	

Ref. No.	Part No.	Description	Remark
S722	1-571-187-11	SWITCH, TACTIL (REFLOW TYPE) (9)	
S723	1-571-187-11	SWITCH, TACTIL (REFLOW TYPE) (DIRECT)	
S724	1-571-187-11	SWITCH, TACTIL (REFLOW TYPE) (5)	
S725	1-571-187-11	SWITCH, TACTIL (REFLOW TYPE) (0)	
S726	1-571-187-11	SWITCH, TACTIL (REFLOW TYPE) (EXE DISPLAY)	
S727	1-571-187-11	SWITCH, TACTIL (REFLOW TYPE) (a)	
S728	1-571-187-11	SWITCH, TACTIL (REFLOW TYPE) (SYNG)	
S729	1-571-187-11	SWITCH, TACTIL (REFLOW TYPE) (STANDBY ON/OFF)	
S730	1-571-187-11	SWITCH, TACTIL (REFLOW TYPE) (b)	
S731	1-571-187-11	SWITCH, TACTIL (REFLOW TYPE) (SSB)	
< VIBRATOR >			
X701	1-577-703-21	VIBRATOR, CERAMIC (2MHz)	
X702	1-567-098-41	VIBRATOR, CRYSTAL (32.768kHz)	
*****			
1-644-696-11 MOTOR FLEXIBLE BOARD			
*****			
*****			
A-3662-421-A SIGNAL BOARD, COMPLETE			
*****			
< CAPACITOR >			
C1	1-165-176-11	CERAMIC CHIP	0.047uF 10% 16V
C2	1-162-970-11	CERAMIC CHIP	0.01uF 10% 25V
C3	1-164-346-11	CERAMIC CHIP	1uF 16V
C4	1-124-778-00	ELECT CHIP	22uF 20% 6.3V
C5	1-162-959-11	CERAMIC CHIP	330PF 5% 50V
C6	1-162-970-11	CERAMIC CHIP	0.01uF 10% 25V
C7	1-162-970-11	CERAMIC CHIP	0.01uF 10% 25V
C8	1-164-357-11	CERAMIC CHIP	1000PF 5% 50V
C9	1-162-970-11	CERAMIC CHIP	0.01uF 10% 25V
C11	1-162-970-11	CERAMIC CHIP	0.01uF 10% 25V
C12	1-124-778-00	ELECT CHIP	22uF 20% 6.3V
C14	1-164-357-11	CERAMIC CHIP	1000PF 5% 50V
C15	1-162-970-11	CERAMIC CHIP	0.01uF 10% 25V
C16	1-162-957-11	CERAMIC CHIP	220PF 5% 50V
C17	1-164-363-11	CERAMIC CHIP	560PF 5% 50V
C18	1-162-970-11	CERAMIC CHIP	0.01uF 10% 25V
C19	1-162-907-11	CERAMIC CHIP	2PF 0.25PF 50V
C20	1-162-908-11	CERAMIC CHIP	3PF 0.25PF 50V
C21	1-162-926-11	CERAMIC CHIP	82PF 5% 50V
C22	1-162-970-11	CERAMIC CHIP	0.01uF 10% 25V
C23	1-162-970-11	CERAMIC CHIP	0.01uF 10% 25V
C24	1-124-778-00	ELECT CHIP	22uF 20% 6.3V
C25	1-162-915-11	CERAMIC CHIP	10PF 0.5PF 50V
C26	1-162-926-11	CERAMIC CHIP	82PF 5% 50V
C27	1-162-907-11	CERAMIC CHIP	2PF 0.25PF 50V

# SIGNAL

Ref. No.	Part No.	Description	Remark			Ref. No.	Part No.	Description	Remark		
C28	1-162-915-11	CERAMIC CHIP	10PF	0. 5PF	50V	C205	1-162-970-11	CERAMIC CHIP	0. 01uF	10%	25V
C29	1-126-607-11	ELECT CHIP	47uF	20%	4V	C206	1-162-847-11	CERAMIC	0. 047uF	10%	16V
C30	1-162-970-11	CERAMIC CHIP	0. 01uF	10%	25V	C207	1-162-905-11	CERAMIC CHIP	1PF	0. 25PF	50V
C31	1-162-970-11	CERAMIC CHIP	0. 01uF	10%	25V	C208	1-162-917-11	CERAMIC CHIP	15PF	5%	50V
C32	1-162-970-11	CERAMIC CHIP	0. 01uF	10%	25V	C209	1-162-970-11	CERAMIC CHIP	0. 01uF	10%	25V
C33	1-126-607-11	ELECT CHIP	47uF	20%	4V	C210	1-162-913-11	CERAMIC CHIP	8PF	0. 5PF	50V
C34	1-162-970-11	CERAMIC CHIP	0. 01uF	10%	25V	C211	1-162-921-11	CERAMIC CHIP	33PF	5%	50V
C35	1-162-970-11	CERAMIC CHIP	0. 01uF	10%	25V	C212	1-126-607-11	ELECT CHIP	47uF	20%	4V
C36	1-162-970-11	CERAMIC CHIP	0. 01uF	10%	25V	C213	1-164-346-11	CERAMIC CHIP	1uF		16V
C37	1-162-970-11	CERAMIC CHIP	0. 01uF	10%	25V	C214	1-164-346-11	CERAMIC CHIP	1uF		16V
C38	1-126-607-11	ELECT CHIP	47uF	20%	4V	C215	1-162-927-11	CERAMIC CHIP	100PF	5%	50V
C39	1-162-916-11	CERAMIC CHIP	12PF	5%	50V	C216	1-162-927-11	CERAMIC CHIP	100PF	5%	50V
C40	1-164-376-11	CERAMIC CHIP	11PF	5%	50V	C217	1-162-970-11	CERAMIC CHIP	0. 01uF	10%	25V
C41	1-162-970-11	CERAMIC CHIP	0. 01uF	10%	25V	C218	1-162-970-11	CERAMIC CHIP	0. 01uF	10%	25V
C42	1-162-917-11	CERAMIC CHIP	15PF	5%	50V	C219	1-130-834-00	FILM	1uF	10%	63V
C43	1-162-970-11	CERAMIC CHIP	0. 01uF	10%	25V	C220	1-162-964-11	CERAMIC CHIP	0. 001uF	10%	50V
C44	1-124-778-00	ELECT CHIP	22uF	20%	6. 3V	C221	1-162-970-11	CERAMIC CHIP	0. 01uF	10%	25V
C45	1-162-970-11	CERAMIC CHIP	0. 01uF	10%	25V	C222	1-107-811-11	TANTAL. CHIP	47uF	20%	4V
C102	1-164-363-11	CERAMIC CHIP	560PF	5%	50V	C223	1-162-921-11	CERAMIC CHIP	33PF	5%	50V
C103	1-162-970-11	CERAMIC CHIP	0. 01uF	10%	25V	C224	1-162-913-11	CERAMIC CHIP	8PF	0. 5PF	50V
C104	1-162-970-11	CERAMIC CHIP	0. 01uF	10%	25V	C225	1-164-156-11	CERAMIC CHIP	0. 1uF		25V
C105	1-164-346-11	CERAMIC CHIP	1uF		16V	C226	1-164-156-11	CERAMIC CHIP	0. 1uF		25V
C106	1-162-970-11	CERAMIC CHIP	0. 01uF	10%	25V	C227	1-162-970-11	CERAMIC CHIP	0. 01uF	10%	25V
C107	1-164-346-11	CERAMIC CHIP	1uF		16V	C228	1-162-970-11	CERAMIC CHIP	0. 01uF	10%	25V
C108	1-164-346-11	CERAMIC CHIP	1uF		16V	C229	1-162-970-11	CERAMIC CHIP	0. 01uF	10%	25V
C109	1-162-970-11	CERAMIC CHIP	0. 01uF	10%	25V	C230	1-162-970-11	CERAMIC CHIP	0. 01uF	10%	25V
C110	1-124-779-00	ELECT CHIP	10uF	20%	16V	C231	1-162-970-11	CERAMIC CHIP	0. 01uF	10%	25V
C111	1-162-908-11	CERAMIC CHIP	3PF	0. 25PF	50V	C232	1-162-970-11	CERAMIC CHIP	0. 01uF	10%	25V
C112	1-164-357-11	CERAMIC CHIP	1000PF	5%	50V	C233	1-162-970-11	CERAMIC CHIP	0. 01uF	10%	25V
C113	1-164-357-11	CERAMIC CHIP	1000PF	5%	50V	C234	1-164-357-11	CERAMIC CHIP	1000PF	5%	50V
C114	1-162-915-11	CERAMIC CHIP	10PF	0. 5PF	50V	C301	1-164-346-11	CERAMIC CHIP	1uF		16V
C116	1-164-156-11	CERAMIC CHIP	0. 1uF		25V	C302	1-164-346-11	CERAMIC CHIP	1uF		16V
C117	1-110-967-11	TANTAL. CHIP	100uF	20%	4V	C303	1-162-915-11	CERAMIC CHIP	10PF	0. 5PF	50V
C118	1-164-357-11	CERAMIC CHIP	1000PF	5%	50V	C304	1-162-915-11	CERAMIC CHIP	10PF	0. 5PF	50V
C119	1-126-607-11	ELECT CHIP	47uF	20%	4V	C305	1-162-970-11	CERAMIC CHIP	0. 01uF	10%	25V
C120	1-164-346-11	CERAMIC CHIP	1uF		16V	C306	1-107-811-11	TANTAL. CHIP	47uF	20%	4V
C121	1-162-970-11	CERAMIC CHIP	0. 01uF	10%	25V	C307	1-162-970-11	CERAMIC CHIP	0. 01uF	10%	25V
C122	1-162-966-11	CERAMIC CHIP	0. 0022uF	10%	50V	C308	1-110-967-11	TANTAL. CHIP	100uF	20%	4V
C123	1-162-970-11	CERAMIC CHIP	0. 01uF	10%	25V	C309	1-162-970-11	CERAMIC CHIP	0. 01uF	10%	25V
C124	1-162-970-11	CERAMIC CHIP	0. 01uF	10%	25V	C310	1-162-970-11	CERAMIC CHIP	0. 01uF	10%	25V
C125	1-164-363-11	CERAMIC CHIP	560PF	5%	50V	C311	1-164-346-11	CERAMIC CHIP	1uF		16V
C126	1-164-346-11	CERAMIC CHIP	1uF		16V	C312	1-164-346-11	CERAMIC CHIP	1uF		16V
C127	1-164-346-11	CERAMIC CHIP	1uF		16V	C313	1-164-346-11	CERAMIC CHIP	1uF		16V
C128	1-164-357-11	CERAMIC CHIP	1000PF	5%	50V	C314	1-164-227-11	CERAMIC CHIP	0. 022uF	10%	25V
C129	1-162-904-11	CERAMIC CHIP	0. 5PF	0. 25PF	50V	C315	1-162-970-11	CERAMIC CHIP	0. 01uF	10%	25V
C201	1-162-970-11	CERAMIC CHIP	0. 01uF	10%	25V	C316	1-164-346-11	CERAMIC CHIP	1uF		16V
C202	1-162-917-11	CERAMIC CHIP	15PF	5%	50V	C317	1-164-156-11	CERAMIC CHIP	0. 1uF		25V
C203	1-126-607-11	ELECT CHIP	47uF	20%	4V	C318	1-164-346-11	CERAMIC CHIP	1uF		16V
C204	1-162-905-11	CERAMIC CHIP	1PF	0. 25PF	50V						

Ref. No.	Part No.	Description	Remark
C319	1-163-137-00	CERAMIC CHIP	680PF 5% 50V
C320	1-162-970-11	CERAMIC CHIP	0.01uF 10% 25V
C321	1-162-970-11	CERAMIC CHIP	0.01uF 10% 25V
C322	1-164-346-11	CERAMIC CHIP	1uF 16V
C323	1-126-607-11	ELECT CHIP	47uF 20% 4V
C324	1-110-967-11	TANTAL. CHIP	100uF 20% 4V
C325	1-164-346-11	CERAMIC CHIP	1uF 16V
C326	1-164-346-11	CERAMIC CHIP	1uF 16V
C401	1-124-778-00	ELECT CHIP	22uF 20% 6.3V
C402	1-164-346-11	CERAMIC CHIP	1uF 16V
C403	1-124-779-00	ELECT CHIP	10uF 20% 16V
C404	1-162-927-11	CERAMIC CHIP	100PF 5% 50V
C405	1-164-346-11	CERAMIC CHIP	1uF 16V
C406	1-126-603-11	ELECT CHIP	4.7uF 20% 35V
C407	1-165-128-11	CERAMIC CHIP	0.22uF 16V
C408	1-164-346-11	CERAMIC CHIP	1uF 16V
C409	1-164-346-11	CERAMIC CHIP	1uF 16V
C410	1-128-391-11	ELECT CHIP	330uF 20% 6.3V
C411	1-126-607-11	ELECT CHIP	47uF 20% 4V
C412	1-162-970-11	CERAMIC CHIP	0.01uF 10% 25V
C413	1-162-970-11	CERAMIC CHIP	0.01uF 10% 25V
C414	1-164-346-11	CERAMIC CHIP	1uF 16V
C415	1-162-927-11	CERAMIC CHIP	100PF 5% 50V
C416	1-162-970-11	CERAMIC CHIP	0.01uF 10% 25V
C417	1-126-603-11	ELECT CHIP	4.7uF 20% 35V
C418	1-165-128-11	CERAMIC CHIP	0.22uF 16V
C419	1-126-607-11	ELECT CHIP	47uF 20% 4V
C420	1-164-346-11	CERAMIC CHIP	1uF 16V
C421	1-124-779-00	ELECT CHIP	10uF 20% 16V
C422	1-162-964-11	CERAMIC CHIP	0.001uF 10% 50V
C423	1-162-964-11	CERAMIC CHIP	0.001uF 10% 50V
C425	1-164-346-11	CERAMIC CHIP	1uF 16V
< FILTER >			
CF101	1-760-199-11	FILTER, CERAMIC	
CF102	1-579-974-11	FILTER, CERAMIC	
CF103	1-579-974-11	FILTER, CERAMIC	
CF104	1-577-065-31	FILTER, CERAMIC	
< CONNECTOR >			
* CN201	1-573-939-11	CONNECTOR, FFC/FPC (ZIF) 30P	
CN202	1-573-370-21	CONNECTOR, FFC/FPC 30P	
CN203	1-573-360-21	CONNECTOR, FFC/FPC 20P	
< TRIMMER >			
CT1	1-141-327-11	CAP, VAR, TRIMMER (CHIP TYPE) 10P	
CT2	1-141-327-11	CAP, VAR, TRIMMER (CHIP TYPE) 10P	
CT201	1-141-327-11	CAP, VAR, TRIMMER (CHIP TYPE) 10P	

Ref. No.	Part No.	Description	Remark
< DIODE >			
D1	8-719-941-86	DIODE DAN202U	
D2	8-719-044-76	DIODE 1SS356-TW11	
D3	8-719-002-81	DIODE 1T363	
D4	8-719-002-81	DIODE 1T363	
D5	8-719-800-76	DIODE 1SS226	
D6	8-719-044-76	DIODE 1SS356-TW11	
D7	8-719-044-76	DIODE 1SS356-TW11	
D8	8-719-044-76	DIODE 1SS356-TW11	
D9	8-719-044-76	DIODE 1SS356-TW11	
D101	8-719-002-81	DIODE 1T363	
D102	8-719-002-81	DIODE 1T363	
D103	8-719-988-62	DIODE 1SS355	
D201	8-719-002-81	DIODE 1T363	
D202	8-719-988-62	DIODE 1SS355	
D301	8-719-988-62	DIODE 1SS355	
D302	8-719-977-39	DIODE DTZ13A	
D303	8-719-988-62	DIODE 1SS355	
D401	8-719-053-18	DIODE 1SR154-400TE-25	
D402	8-719-053-18	DIODE 1SR154-400TE-25	
D403	8-719-988-62	DIODE 1SS355	
D404	8-719-977-39	DIODE DTZ13A	
< IC >			
IC101	8-752-064-32	IC CXA1376AM	
IC201	8-759-351-32	IC uPD1724GB-687-1A7	
IC301	8-759-804-76	IC LA5002M	
IC302	8-759-804-98	IC LA3335M	
IC402	8-759-255-02	IC S-80723SN-DL-T1	
IC403	8-752-058-42	IC CXA1622M	
< JACK >			
J1	1-573-178-11	JACK (EXT ANT)	
J401	1-580-372-11	JACK, DC (POLARITY UNIFIED TYPE) (DC IN 3V)	
J402	1-573-177-11	JACK (⊙)	
J403	1-774-045-11	JACK (MIC PLUG IN POWER)	
< COIL >			
L1	1-412-979-21	INDUCTOR 1uH	
L2	1-412-963-11	INDUCTOR 100uH	
L3	1-412-993-11	INDUCTOR 15uH	
L4	1-412-978-21	INDUCTOR 0.82uH	
L5	1-412-978-21	INDUCTOR 0.82uH	
L6	1-410-658-31	INDUCTOR CHIP 220uH	
L7	1-412-987-31	INDUCTOR 4.7uH	
L8	1-412-990-31	INDUCTOR 8.2uH	
L9	1-412-978-21	INDUCTOR 0.82uH	
L10	1-412-979-21	INDUCTOR 1uH	

# SIGNAL

Ref. No.	Part No.	Description	Remark	Ref. No.	Part No.	Description	Remark
L11	1-412-978-21	INDUCTOR	0. 82uH	Q309	8-729-403-07	TRANSISTOR	XN1213
L12	1-412-973-11	INDUCTOR	0. 33uH	Q310	8-729-402-32	TRANSISTOR	2SD1819A-R
L101	1-412-989-11	INDUCTOR	6. 8uH	Q311	8-729-420-44	TRANSISTOR	UN5210
L102	1-410-658-31	INDUCTOR CHIP	220uH	Q312	8-729-402-96	TRANSISTOR	UN5114
L104	1-412-991-11	INDUCTOR	10uH	Q313	8-729-800-37	TRANSISTOR	2SD1048-X7
L201	1-412-987-31	INDUCTOR	4. 7uH	Q401	8-729-402-32	TRANSISTOR	2SD1819A-R
L202	1-412-975-31	INDUCTOR	0. 47uH	Q402	8-729-420-44	TRANSISTOR	UN5210
L301	1-412-996-31	INDUCTOR	27uH	Q403	8-729-807-87	TRANSISTOR	2SB1295-UL6
L302	1-410-658-31	INDUCTOR CHIP	220uH	Q404	8-729-807-87	TRANSISTOR	2SB1295-UL6
		< TRANSISTOR >		Q405	8-729-807-87	TRANSISTOR	2SB1295-UL6
Q1	8-729-423-52	TRANSISTOR	2SC3931-C	Q406	8-729-807-87	TRANSISTOR	2SB1295-UL6
Q2	8-729-123-86	TRANSISTOR	2SK238-K16	Q407	8-729-420-44	TRANSISTOR	UN5210
Q3	8-729-423-52	TRANSISTOR	2SC3931-C	Q408	8-729-807-87	TRANSISTOR	2SB1295-UL6
Q4	8-729-402-32	TRANSISTOR	2SD1819A-R	Q409	8-729-402-32	TRANSISTOR	2SD1819A-R
Q5	8-729-807-87	TRANSISTOR	2SB1295-UL6	Q410	8-729-420-44	TRANSISTOR	UN5210
Q6	8-729-402-16	TRANSISTOR	XN4608	Q411	8-729-403-07	TRANSISTOR	XN1213
Q7	8-729-123-86	TRANSISTOR	2SK238-K16	Q412	8-729-807-87	TRANSISTOR	2SB1295-UL6
Q8	8-729-807-87	TRANSISTOR	2SB1295-UL6	Q413	8-729-402-13	TRANSISTOR	XN1501
Q9	8-729-402-96	TRANSISTOR	UN5114	Q414	8-729-403-07	TRANSISTOR	XN1213
Q10	8-729-116-64	TRANSISTOR	2SK508-K51	Q415	8-729-420-44	TRANSISTOR	UN5210
Q11	8-729-402-32	TRANSISTOR	2SD1819A-R	Q416	8-729-402-32	TRANSISTOR	2SD1819A-R
Q12	8-729-116-64	TRANSISTOR	2SK508-K51	Q417	8-729-420-44	TRANSISTOR	UN5210
Q13	8-729-116-64	TRANSISTOR	2SK508-K51			< RESISTOR >	
Q14	8-729-208-47	TRANSISTOR	2SK210-GR	R1	1-216-841-11	METAL CHIP	47K 5% 1/16W
Q101	8-729-420-44	TRANSISTOR	UN5210	R2	1-216-845-11	METAL CHIP	100K 5% 1/16W
Q102	8-729-402-55	TRANSISTOR	2SB1218A-R-TX	R3	1-216-821-11	METAL CHIP	1K 5% 1/16W
Q103	8-729-420-44	TRANSISTOR	UN5210	R5	1-216-797-11	METAL CHIP	10 5% 1/16W
Q104	8-729-423-52	TRANSISTOR	2SC3931-C	R6	1-216-825-11	METAL CHIP	2. 2K 5% 1/16W
Q105	8-729-402-96	TRANSISTOR	UN5114	R7	1-216-847-11	METAL CHIP	150K 5% 1/16W
Q106	8-729-403-07	TRANSISTOR	XN1213	R8	1-216-841-11	METAL CHIP	47K 5% 1/16W
Q107	8-729-420-44	TRANSISTOR	UN5210	R9	1-216-833-11	METAL CHIP	10K 5% 1/16W
Q108	8-729-420-44	TRANSISTOR	UN5210	R10	1-216-829-11	METAL CHIP	4. 7K 5% 1/16W
Q201	8-729-423-52	TRANSISTOR	2SC3931-C	R11	1-216-841-11	METAL CHIP	47K 5% 1/16W
Q202	8-729-208-47	TRANSISTOR	2SK210-GR	R12	1-216-841-11	METAL CHIP	47K 5% 1/16W
Q203	8-729-423-52	TRANSISTOR	2SC3931-C	R13	1-216-837-11	METAL CHIP	22K 5% 1/16W
Q204	8-729-402-16	TRANSISTOR	XN4608	R14	1-216-821-11	METAL CHIP	1K 5% 1/16W
Q205	8-729-402-16	TRANSISTOR	XN4608	R15	1-216-845-11	METAL CHIP	100K 5% 1/16W
Q206	8-729-220-93	TRANSISTOR	2SK209-G	R17	1-216-797-11	METAL CHIP	10 5% 1/16W
Q207	8-729-220-93	TRANSISTOR	2SK209-G	R18	1-216-845-11	METAL CHIP	100K 5% 1/16W
Q208	8-729-402-32	TRANSISTOR	2SD1819A-R	R19	1-216-833-11	METAL CHIP	10K 5% 1/16W
Q301	8-729-402-32	TRANSISTOR	2SD1819A-R	R20	1-216-845-11	METAL CHIP	100K 5% 1/16W
Q302	8-729-402-32	TRANSISTOR	2SD1819A-R	R21	1-216-817-11	METAL CHIP	470 5% 1/16W
Q303	8-729-402-16	TRANSISTOR	XN4608	R22	1-216-805-11	METAL CHIP	47 5% 1/16W
Q304	8-729-402-16	TRANSISTOR	XN4608	R23	1-216-809-11	METAL CHIP	100 5% 1/16W
Q305	8-729-420-44	TRANSISTOR	UN5210	R24	1-216-833-11	METAL CHIP	10K 5% 1/16W
Q306	8-729-402-96	TRANSISTOR	UN5114	R25	1-216-823-11	METAL CHIP	1. 5K 5% 1/16W
Q307	8-729-420-44	TRANSISTOR	UN5210	R26	1-216-853-11	METAL CHIP	470K 5% 1/16W
Q308	8-729-402-32	TRANSISTOR	2SD1819A-R	R27	1-216-797-11	METAL CHIP	10 5% 1/16W

Ref. No.	Part No.	Description	Remark
R28	1-216-809-11	METAL CHIP	100 5% 1/16W
R29	1-216-825-11	METAL CHIP	2. 2K 5% 1/16W
R30	1-216-817-11	METAL CHIP	470 5% 1/16W
R31	1-216-845-11	METAL CHIP	100K 5% 1/16W
R32	1-216-839-11	METAL CHIP	33K 5% 1/16W
R33	1-216-841-11	METAL CHIP	47K 5% 1/16W
R34	1-216-825-11	METAL CHIP	2. 2K 5% 1/16W
R35	1-216-821-11	METAL CHIP	1K 5% 1/16W
R36	1-216-821-11	METAL CHIP	1K 5% 1/16W
R37	1-216-797-11	METAL CHIP	10 5% 1/16W
R38	1-216-797-11	METAL CHIP	10 5% 1/16W
R39	1-216-797-11	METAL CHIP	10 5% 1/16W
R40	1-216-831-11	METAL CHIP	6. 8K 5% 1/16W
R41	1-216-797-11	METAL CHIP	10 5% 1/16W
R42	1-216-805-11	METAL CHIP	47 5% 1/16W
R43	1-216-815-11	METAL CHIP	330 5% 1/16W
R101	1-216-826-11	METAL CHIP	2. 7K 5% 1/16W
R102	1-216-851-11	METAL CHIP	330K 5% 1/16W
R103	1-216-837-11	METAL CHIP	22K 5% 1/16W
R104	1-216-838-11	METAL CHIP	27K 5% 1/16W
R105	1-216-809-11	METAL CHIP	100 5% 1/16W
R106	1-216-825-11	METAL CHIP	2. 2K 5% 1/16W
R107	1-216-841-11	METAL CHIP	47K 5% 1/16W
R109	1-216-817-11	METAL CHIP	470 5% 1/16W
R110	1-216-813-11	METAL CHIP	220 5% 1/16W
R111	1-216-837-11	METAL CHIP	22K 5% 1/16W
R112	1-216-845-11	METAL CHIP	100K 5% 1/16W
R113	1-216-849-11	METAL CHIP	220K 5% 1/16W
R114	1-216-825-11	METAL CHIP	2. 2K 5% 1/16W
R115	1-216-797-11	METAL CHIP	10 5% 1/16W
R116	1-216-845-11	METAL CHIP	100K 5% 1/16W
R117	1-216-825-11	METAL CHIP	2. 2K 5% 1/16W
R118	1-216-833-11	METAL CHIP	10K 5% 1/16W
R119	1-216-823-11	METAL CHIP	1. 5K 5% 1/16W
R120	1-216-845-11	METAL CHIP	100K 5% 1/16W
R121	1-216-833-11	METAL CHIP	10K 5% 1/16W
R201	1-216-817-11	METAL CHIP	470 5% 1/16W
R202	1-216-841-11	METAL CHIP	47K 5% 1/16W
R203	1-216-797-11	METAL CHIP	10 5% 1/16W
R204	1-216-803-11	METAL CHIP	33 5% 1/16W
R205	1-216-805-11	METAL CHIP	47 5% 1/16W
R206	1-216-805-11	METAL CHIP	47 5% 1/16W
R207	1-216-839-11	METAL CHIP	33K 5% 1/16W
R208	1-216-803-11	METAL CHIP	33 5% 1/16W
R209	1-216-841-11	METAL CHIP	47K 5% 1/16W
R210	1-216-797-11	METAL CHIP	10 5% 1/16W
R213	1-216-829-11	METAL CHIP	4. 7K 5% 1/16W
R214	1-216-841-11	METAL CHIP	47K 5% 1/16W
R215	1-216-841-11	METAL CHIP	47K 5% 1/16W

Ref. No.	Part No.	Description	Remark
R216	1-216-841-11	METAL CHIP	47K 5% 1/16W
R217	1-216-829-11	METAL CHIP	4. 7K 5% 1/16W
R218	1-216-841-11	METAL CHIP	47K 5% 1/16W
R219	1-216-797-11	METAL CHIP	10 5% 1/16W
R220	1-216-809-11	METAL CHIP	100 5% 1/16W
R221	1-216-809-11	METAL CHIP	100 5% 1/16W
R222	1-216-833-11	METAL CHIP	10K 5% 1/16W
R223	1-216-829-11	METAL CHIP	4. 7K 5% 1/16W
R224	1-216-835-11	METAL CHIP	15K 5% 1/16W
R225	1-216-833-11	METAL CHIP	10K 5% 1/16W
R226	1-216-833-11	METAL CHIP	10K 5% 1/16W
R227	1-216-835-11	METAL CHIP	15K 5% 1/16W
R228	1-216-797-11	METAL CHIP	10 5% 1/16W
R229	1-216-843-11	METAL CHIP	68K 5% 1/16W
R230	1-216-833-11	METAL CHIP	10K 5% 1/16W
R231	1-216-843-11	METAL CHIP	68K 5% 1/16W
R232	1-216-843-11	METAL CHIP	68K 5% 1/16W
R233	1-216-843-11	METAL CHIP	68K 5% 1/16W
R234	1-216-843-11	METAL CHIP	68K 5% 1/16W
R235	1-216-839-11	METAL CHIP	33K 5% 1/16W
R236	1-216-839-11	METAL CHIP	33K 5% 1/16W
R237	1-216-839-11	METAL CHIP	33K 5% 1/16W
R238	1-216-839-11	METAL CHIP	33K 5% 1/16W
R239	1-216-839-11	METAL CHIP	33K 5% 1/16W
R240	1-216-843-11	METAL CHIP	68K 5% 1/16W
R241	1-216-839-11	METAL CHIP	33K 5% 1/16W
R242	1-216-843-11	METAL CHIP	68K 5% 1/16W
R243	1-216-825-11	METAL CHIP	2. 2K 5% 1/16W
R244	1-216-825-11	METAL CHIP	2. 2K 5% 1/16W
R245	1-216-825-11	METAL CHIP	2. 2K 5% 1/16W
R246	1-216-825-11	METAL CHIP	2. 2K 5% 1/16W
R247	1-216-825-11	METAL CHIP	2. 2K 5% 1/16W
R248	1-216-825-11	METAL CHIP	2. 2K 5% 1/16W
R249	1-216-825-11	METAL CHIP	2. 2K 5% 1/16W
R250	1-216-825-11	METAL CHIP	2. 2K 5% 1/16W
R251	1-216-825-11	METAL CHIP	2. 2K 5% 1/16W
R301	1-216-821-11	METAL CHIP	1K 5% 1/16W
R302	1-216-843-11	METAL CHIP	68K 5% 1/16W
R303	1-216-845-11	METAL CHIP	100K 5% 1/16W
R304	1-216-845-11	METAL CHIP	100K 5% 1/16W
R305	1-216-825-11	METAL CHIP	2. 2K 5% 1/16W
R306	1-216-837-11	METAL CHIP	22K 5% 1/16W
R307	1-216-841-11	METAL CHIP	47K 5% 1/16W
R308	1-216-825-11	METAL CHIP	2. 2K 5% 1/16W
R309	1-216-837-11	METAL CHIP	22K 5% 1/16W
R310	1-216-841-11	METAL CHIP	47K 5% 1/16W
R311	1-216-797-11	METAL CHIP	10 5% 1/16W
R312	1-216-845-11	METAL CHIP	100K 5% 1/16W

# SIGNAL

Ref. No.	Part No.	Description	Remark		
R313	1-216-833-11	METAL CHIP	10K	5%	1/16W
R314	1-216-821-11	METAL CHIP	1K	5%	1/16W
R315	1-216-841-11	METAL CHIP	47K	5%	1/16W
R316	1-216-825-11	METAL CHIP	2.2K	5%	1/16W
R317	1-216-809-11	METAL CHIP	100	5%	1/16W
R318	1-216-840-11	METAL CHIP	39K	5%	1/16W
R319	1-216-833-11	METAL CHIP	10K	5%	1/16W
R320	1-216-825-11	METAL CHIP	2.2K	5%	1/16W
R402	1-216-833-11	METAL CHIP	10K	5%	1/16W
R403	1-216-821-11	METAL CHIP	1K	5%	1/16W
R404	1-216-821-11	METAL CHIP	1K	5%	1/16W
R405	1-216-833-11	METAL CHIP	10K	5%	1/16W
R407	1-216-821-11	METAL CHIP	1K	5%	1/16W
R408	1-216-821-11	METAL CHIP	1K	5%	1/16W
R409	1-216-818-11	METAL CHIP	560	5%	1/16W
R410	1-216-829-11	METAL CHIP	4.7K	5%	1/16W
R411	1-216-841-11	METAL CHIP	47K	5%	1/16W
R412	1-216-821-11	METAL CHIP	1K	5%	1/16W
R413	1-216-821-11	METAL CHIP	1K	5%	1/16W
R414	1-216-833-11	METAL CHIP	10K	5%	1/16W
R415	1-216-833-11	METAL CHIP	10K	5%	1/16W
R416	1-216-821-11	METAL CHIP	1K	5%	1/16W
R417	1-216-821-11	METAL CHIP	1K	5%	1/16W
R418	1-216-833-11	METAL CHIP	10K	5%	1/16W
R419	1-216-805-11	METAL CHIP	47	5%	1/16W
R420	1-216-837-11	METAL CHIP	22K	5%	1/16W
R421	1-216-837-11	METAL CHIP	22K	5%	1/16W
R422	1-216-833-11	METAL CHIP	10K	5%	1/16W
R423	1-216-833-11	METAL CHIP	10K	5%	1/16W
R424	1-216-805-11	METAL CHIP	47	5%	1/16W
R425	1-216-831-11	METAL CHIP	6.8K	5%	1/16W
R426	1-216-831-11	METAL CHIP	6.8K	5%	1/16W
R427	1-216-815-11	METAL CHIP	330	5%	1/16W
R428	1-216-815-11	METAL CHIP	330	5%	1/16W
R429	1-216-841-11	METAL CHIP	47K	5%	1/16W
< VARIABLE RESISTOR >					
RV101	1-241-597-11	RES, ADJ, METAL GRAZE	100K		
RV102	1-241-597-11	RES, ADJ, METAL GRAZE	100K		
RV301	1-241-595-11	RES, ADJ, METAL GRAZE	22K		
RV401	1-223-967-11	RES, VAR, CARBON 50K	(VOLUME)		
< SWITCH >					
S1	1-572-552-11	SWITCH, SLIDE (SENS)			
S201	1-554-088-00	SWITCH, KEY BOARD (■)			
S202	1-554-088-00	SWITCH, KEY BOARD (◀▶)			
S203	1-554-088-00	SWITCH, KEY BOARD (FF)			
S204	1-554-088-00	SWITCH, KEY BOARD (REW)			

Ref. No.	Part No.	Description	Remark
S205	1-554-088-00	SWITCH, KEY BOARD (REC)	
S206	1-553-510-00	SWITCH, SLIDE (HOLD)	
S401	1-572-552-11	SWITCH, SLIDE (ST/MONO)	
S402	1-572-552-11	SWITCH, SLIDE (TONE)	
< TRANSFORMER >			
T1	1-426-468-11	TRANSFORMER, HIGH FREQUENCY	
T2	1-411-446-21	COIL (FM ANT)	
T3	1-411-445-21	COIL (FM RF)	
T4	1-426-357-11	TRANSFORMER, RF	
T5	1-403-633-11	TRANSFORMER, IF	
T6	1-403-634-11	TRANSFORMER, IF	
T101	1-403-638-11	COIL (WITH CORE) (OSC)	
T102	1-403-632-11	COIL (WITH CORE)	
T103	1-403-630-11	COIL (WITH CORE) (OSC)	
T201	1-403-629-11	COIL (WITH CORE) (OSC)	
T301	1-449-021-21	COIL, DC/DC CONVERTER	
< VIBRATOR >			
X101	1-760-200-11	VIBRATOR, CERAMIC (3.64MHz)	
X102	1-760-197-11	VIBRATOR, CRYSTAL (55.39MHz)	
X201	1-579-744-21	VIBRATOR, CRYSTAL (75kHz)	
< FILTER >			
XF1	1-760-198-11	FILTER, CRYSTAL (55.845MHz)	
*****			
MISCELLANEOUS			
*****			
63	1-658-875-11	FLEXIBLE (B) BOARD	
123	1-658-876-11	FLEXIBLE (C) BOARD	
124	1-658-874-11	FLEXIBLE (A) BOARD	
126	1-658-877-11	FLEXIBLE (LEAF) BOARD	
127	1-644-696-11	MOTOR FLEXIBLE BOARD	
ANT1	1-501-793-11	ANTENNA, FERRITE-ROD (LW.MW)	
ANT2	1-501-794-11	ANTENNA, TELESCOPIC (FM)	
HE501	1-500-059-11	HEAD, MAGNETIC (ERASE)	
HRP501	1-500-060-11	HEAD, MAGNETIC (RECORD/PLAYBACK)	
M601	1-698-084-11	MOTOR	
S503	1-692-100-11	SWITCH, LEAF (CLAW DET FWD(ATS/REC B))	
S504	1-692-101-11	SWITCH, LEAF (CLAW DET REV(TAPE/REC A))	
SP401	1-505-141-11	SPEAKER (4.5CM)	
*****			

Ref. No.	Part No.	Description	Remark
----------	----------	-------------	--------

\*\*\*\*\*  
**HARDWARE LIST**  
 \*\*\*\*\*

- |    |              |                               |  |
|----|--------------|-------------------------------|--|
| #1 | 7-685-152-19 | SCREW +BTP 3X25 TYPE2 N-S     |  |
| #2 | 7-624-104-04 | STOP RING 2.0, TYPE -E        |  |
| #3 | 7-627-553-17 | PRECISION SCREW +P 2X2 TYPE 3 |  |

\*\*\*\*\*

ACCESSORIES & PACKING MATERIALS  
 \*\*\*\*\*

- |   |              |  |  |
|---|--------------|--|--|
| △ | 1-506-443-01 | ADAPTOR, PLUG (JE)   |  |
|   | 1-542-116-11 | MICROPHONE   |  |
|   | 3-800-621-01 | MANUAL, INSTRUCTION (JAPANESE, ENGLISH,<br>KOREAN, ARABIC) (EA, JE)                      |  |
|   | 3-800-621-11 | MANUAL, INSTRUCTION (ENGLISH, FRENCH,<br>SPANISH, PORTUGUESE, SWEDISH) (US, AEP, E)      |  |
|   | 3-800-621-21 | MANUAL, INSTRUCTION (ENGLISH, FRENCH,<br>GERMAN, ITALIAN, DUTCH) (AEP, UK, IT, Canadian) |  |
|   | 3-893-802-11 | BOOK, GUIDE, WAVE (EXCEPT EA)  |  |
| * | 3-912-863-01 | GUIDE, SHOOT WAVE (EA)   |  |
|   | 3-929-852-01 | STRAP, HAND  |  |
|   | 3-930-303-01 | CASE, CARRYING   |  |
|   | 8-953-538-90 | HEADPHONE MDR-E741//K SET  |  |
|   | X-3329-657-1 | ATTACHMENT   |  |

\*\*\*\*\*

The components identified by mark △ or dotted line with mark △ are critical for safety. Replace only with part number specified.	Les composants identifiés par une marque △ sont critiques pour la sécurité. Ne les remplacer que par une pièce portant le numéro spécifié.
--	--

