

SONY

GUIDE ***VISUAL***
WORLD-BAND
RECEIVER
CRF-V21

Contents

The Radiofacsimile System	3
Facsimile Principles	4
Radiofacsimile Modulation	7
Radiofacsimile Overview	9
Radiofacsimile Transmission of Weather Charts	10
Satellite Radiofacsimile	14
When Clear Reception Cannot Be Obtained—Cause and Cure	19
Weather Chart Radiofacsimile Frequency List	23

The Radiofacsimile System

As used in this manual,
"radiofacsimile transmission"
means sending a facsimile signal by radio.
We have included the principles of facsimile and
radiofacsimile here for your reference.



Facsimile Principles

Basically, what a facsimile system does is to convert visual information into an electronic signal at the sender's end, transmit this signal electronically, and reconvert to visual form at the recipient's end.

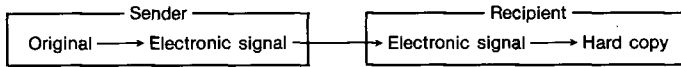

Transmission

At the sender's side, the original is broken up into a fine grid, and the darkness information is read off one line at a time and transmitted to the recipient. The original is wrapped around a cylindrical drum and rotated once for each line to read the data. (This reading process is called scanning, and each line is called a scanning line.) In order to turn the graphic data into an electronic signal, a light is shone on the drum and the amount of reflected light is sensed. A photosensitive element (such as a phototransistor or CCD) is used to convert the light into an electric current.

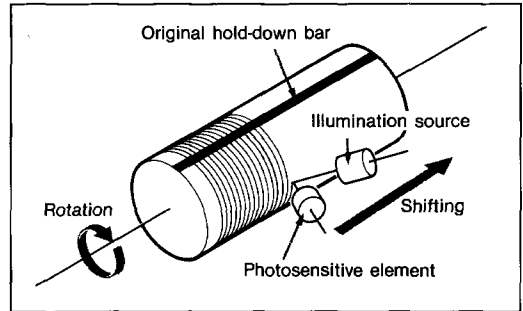

The strength of the reflected light depends on the darkness of the part of the frame being read, so the generated electric current varies from point to point. (White areas reflect a large amount of light, and so generate a large current, while black areas reflect a small amount of light and generate a small current.)

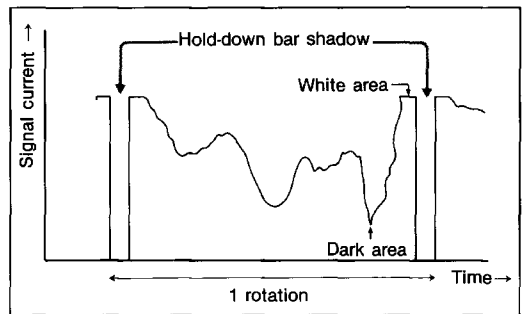

The signal generated in this way is sent to the recipient. If telephone lines are used this is ordinary facsimile, while if a radio transmitter is used, it is called radiofacsimile.

Reception

At the receiving end, a piece of recording paper is wrapped around a drum the same size as the transmission drum, and the drum is rotated at the same speed. A needle is in contact with the drum with the signal current applied to it, and the darkness of the image produced varies with the amount of current to reproduce the original image. One line is reproduced with each rotation of the drum.

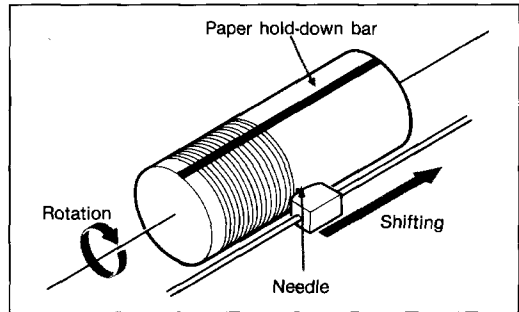

Reproduction Method Used by This Unit

For this unit, instead of rotating a drum, a recording needle (head) is moved across the paper to reproduce the image.

For example, when the drum at the sender's end is rotating at 120 rpm, every rotation takes 0.5 second. It means that a line ends every 0.5 second. (Actually, 16 lines are reproduced at a time, so 0.5×16 seconds, or a total of 8 seconds, are available per line.) In this way, the line speed (reproduce speed) is determined by the rotational speed of the drum at the sender's end. This is why the reproduce speed is set in terms of drum rotation rate.

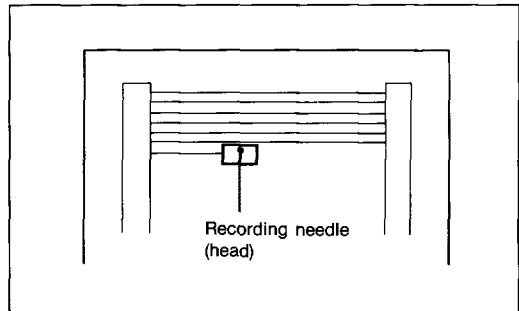

Vertical/Horizontal Ratio — “Index of Cooperation”

The width of the reproduced frame is determined by the diameter of the drum, while the height is determined by the shift density, or how many scanning lines are in each millimeter. (This is because the number of lines is the same as at the sender's end.)

If exactly the same size drum is used by both the sender and recipient, and the rotation rates are the same, setting the shift density to be the same value at both ends will reproduce the frame at its original size. However, if the drums at the two ends are different sizes this will not work. In this case, a parameter called the “index of cooperation” allows the frame to be reproduced with the correct vertical/horizontal ratio. Setting the index of cooperation to the same value at both ends will guarantee the correct frame proportions.

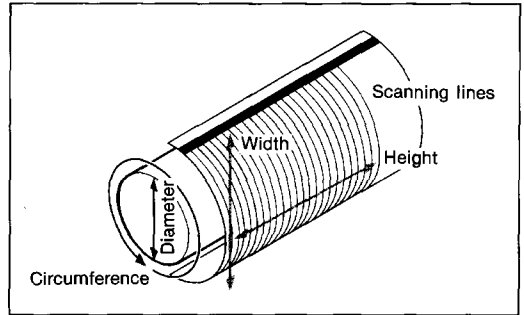

The Index of Cooperation

Let the diameter of the sending drum be A , the diameter of the receiving drum be A' , the scanning density on the sender's end be B , and the scanning density on the receiving end be B' .

The width of the frame is equal to the circumference of the drum, so the width of the original is $A \times \pi$, while the width of the reproduced frame is $A' \times \pi$.

Let the enlargement ratio of the reproduced width compared with the original width be M . M becomes larger with increasing receiving drum size:

$$M = \frac{A' \times \pi}{A \times \pi} = \frac{A'}{A}$$

Next, let the enlargement ratio of the reproduced height compared with the original height be N . N becomes larger with decreasing scanning density (coarser scanning) at the receiving end.

$$N = \frac{B}{B'}$$

For the vertical/horizontal ratio to be correct, M should equal N . This means that:

$$\frac{A'}{A} = \frac{B}{B'}$$

The quantity $A \times B$, which is the product of the drum diameter and the scanning density, is the index of cooperation.

The index of cooperation is set by International radiofacsimile standards to be either 576 or 288. This unit can handle either, with its “H” (576) and “L” (288) settings.

Radiofacsimile Modulation

When graphic information is electronically transmitted using radiofacsimile, the black and white areas are represented by two different radio frequencies. When receiving, assuming A is the published frequency, since this is only the center frequency before frequency shifting, $(A - 400)\text{Hz}$ is the frequency for black, and $(A + 400)\text{Hz}$ is the frequency for white. (When a photograph is transmitted, intermediate frequencies are also used to represent halftones.) This modulation method is called FSK (Frequency Shift Keying).

There are some broadcast stations that use the frequencies B or C instead of the center frequency A as the published frequency. If when using this unit the black-and-white pattern is almost invisible, try either adding or subtracting 1.9 kHz from the published frequency. Also, most stations have a frequency shift of 400 Hz as shown in the diagram, but some stations, especially longwave (LW) stations (below 300 kHz) have frequency shifts of 150 Hz. In that case it is necessary to set the receiver's shift frequency to 150 Hz (see the "Operating Instructions").

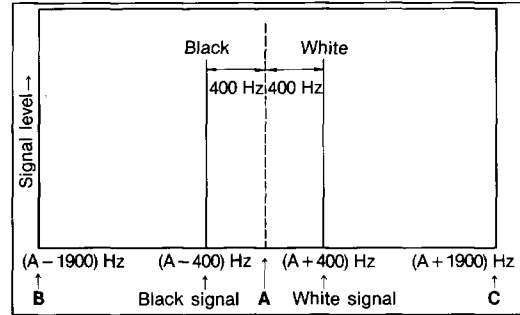

Radiofacsimile Overview

There are basically two main types of radiofacsimile used by the weather reporting services. One is weather charts transmitted from land-based stations, while the other is photographs transmitted by orbiting satellites (satellite facsimile).

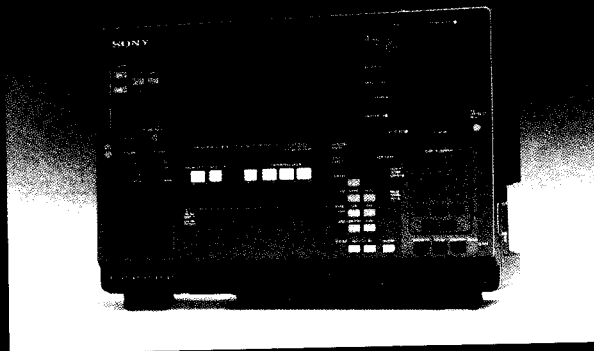

Radiofacsimile Transmission of Weather Charts

A wide variety of weather charts are transmitted around the world, directed at shipping, airplanes, and other users. The broadcasts include surface analyses (temperature, wind direction, wind speed and atmospheric pressure charts, etc.), upper-air analyses (satellite photos, etc.), and sea conditions charts (wave heights, etc.). Both present conditions and predictions are broadcast.

World Weather Radiofacsimile Stations

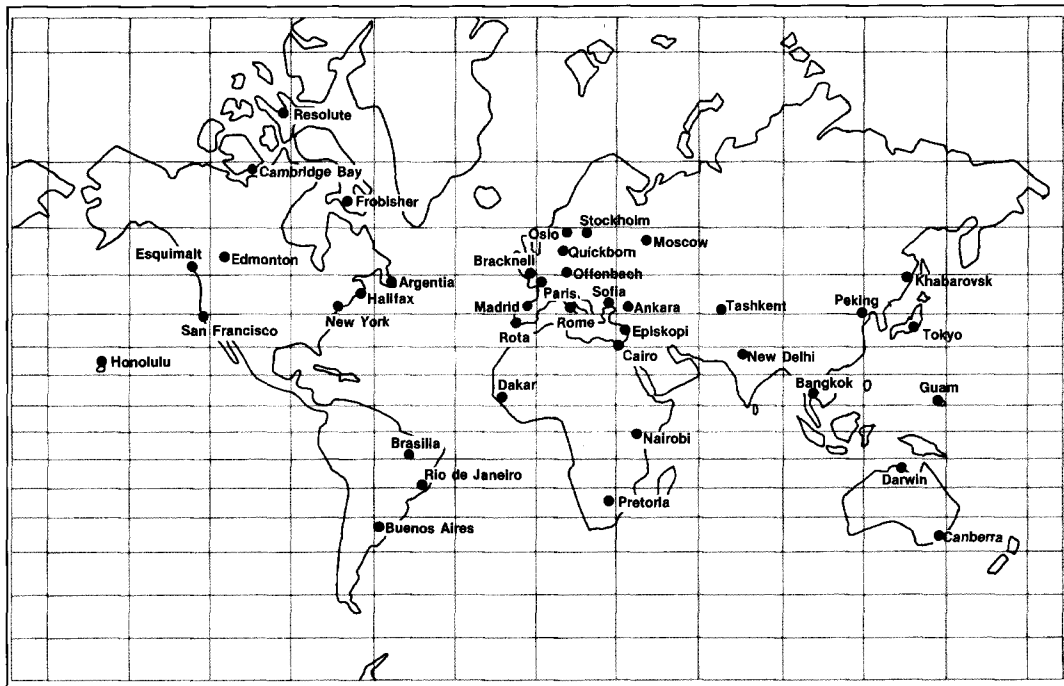

Types of Weather Charts—Plotting Symbols

Most weather charts contain an abbreviated heading indicating the type of chart, the region, and the time. The abbreviated heading normally consists of the following:

AABB(cc)DDDD EEFFgg

AA: Type of chart (see chart 1.)

BB: Region covered (see chart 2.)

(cc): Two-digit code if necessary. Used to distinguish similar charts.

DDDD: International country code (4 letters) or station callsign (3 letters).

EEFFgg: International date, hour, and minute (GMT).

However, in the USSR, Moscow time (3 hours earlier) is used.

Chart 1

S: Surface data

Code	Meaning
SD	Radar summary
SI	Current conditions at 0300, 0900, 1500, 2100 GMT
SM	Current conditions at 0000, 0600, 1200, 1800 GMT
SO	Oceanographic data
ST	Sea-ice information
SX	Other surface data

U: Upper-air data

Code	Meaning
US	Current upper-air conditions (radiosonde, radio wind direction finding)
UX	Other upper air data

A: Analysis

Code	Meaning
AH	Upper-air thickness analysis
AN	Nephanalysis
AS	Surface analysis
AU	Upper-air analysis
AW	Sea wave analysis
AX	Other analysis

F: Forecasts

Code	Meaning
FB	Significant weather forecast
FE	Extended forecast
FH	Upper-air thickness forecast
FS	Surface forecast
FU	Upper-air forecast
FW	Wave forecast
FX	Other forecast

W: Warnings

Code	Meaning
WH	Hurricane warning
WO	Other warning
WT	Typhoon warning
WW	Warnings and current conditions

C: Averages

Code	Meaning
CO	Oceanographic average
CS	Surface average
CU	Upper-air average

Chart 2

Code	Region
AA	South pole
AE	Southeast Asia
AF	Africa
AG	Argentina
AP	West Africa
AO	South Africa
AS	Asia
AU	Australia
BZ	Brazil
CI	China
EA	East Africa
EE	East Europe
EG	Egypt
EU	Europe
EW	West Europe
FE	Far East
FR	France
IO	Indian Ocean
JP	Japan
KN	Kenya
ME	East Mediterranean

Code	Region
NA	North America
NT	North Atlantic
NZ	New Zealand
OC	Oceania
PA	Pacific Ocean
PN	North Pacific
PS	South Pacific
PW	West Pacific
SA	South America
SN	Sweden
SP	Spain
TH	Thailand
TU	Turkey
UK	United Kingdom
XN	Northern Hemisphere
XS	Southern Hemisphere
ST	Equatorial Region
XX	Other Regions
ZA	Zambia

Radiofacsimile Weather Chart Examples

Weather Satellite GMS Cloud Photo (Station: JMH, Heading: GMS picture)



Typhoon Forecast (Station: JMH, Heading: WTFE 02)

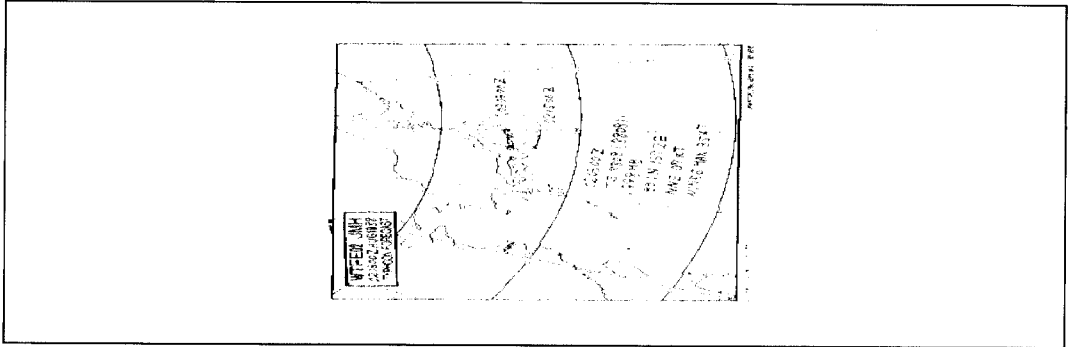

Open Sea Wave Analysis (Station: JMH, Heading: AWPN)

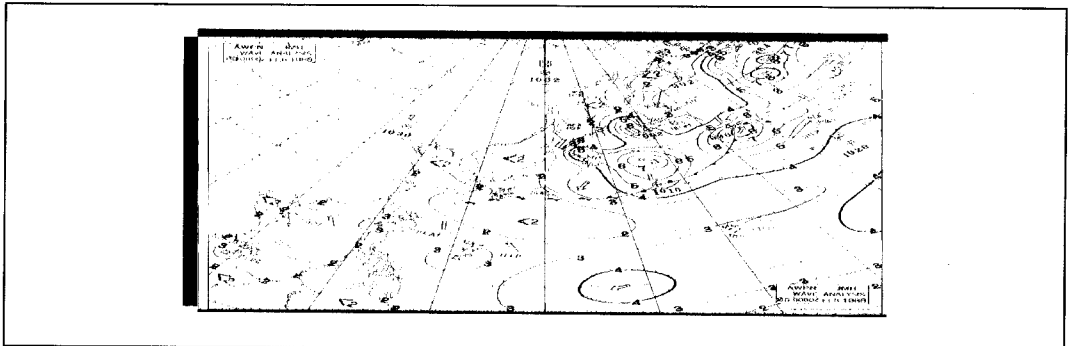

Significant Weather Forecast (Station: JMJ, Heading: FBPN)

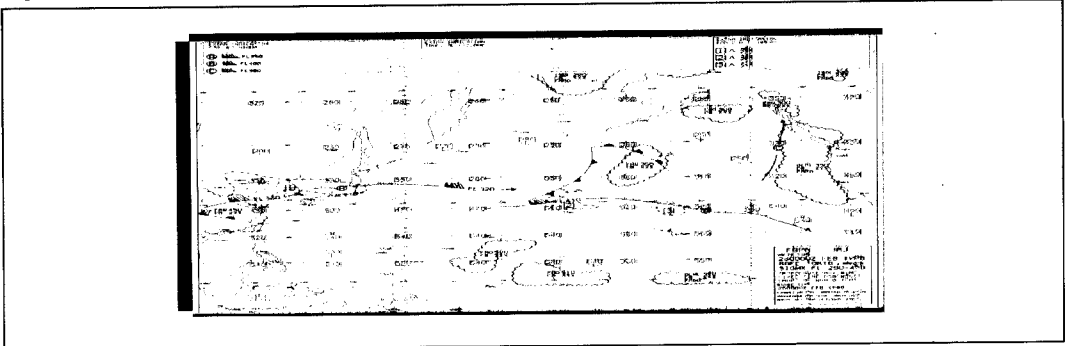

24-Hour 500 mb Atmospheric Pressure Contour Forecast (Station: JMJ, Heading FUPA 502)

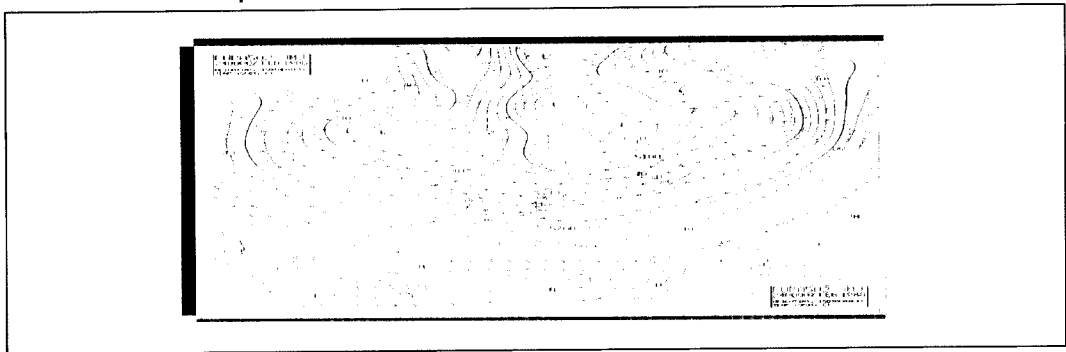

Satellite Radiofacsimile

Weather Satellites

There are two types of weather satellites, stationary orbit satellites and polar orbit satellites. This unit receives radiofacsimile weather photos transmitted by stationary orbit satellites shown on the right. (The optional AN-P1200 antenna is required.)

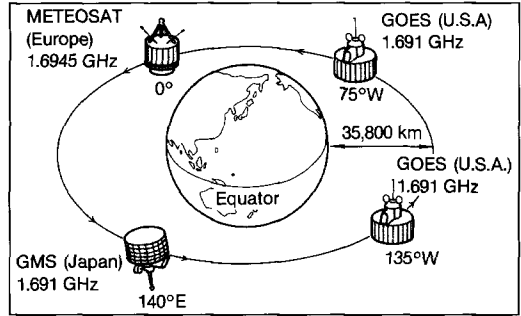

Stationary Orbit Weather Satellites

Stationary orbit satellites are positioned over the equator, and each one transmits information for a particular region. There are presently three types of stationary orbit satellites:

- GMS (Japan)
- GOES (U.S.A.)
- METEOSAT (Europe)

Stationary Weather Satellite Chart

Satellite	Region covered	Longitude
GOES (U.S.A.)	Western North America, East Pacific	135°West
	Eastern North America, South America	75°West
METEOSAT (Europe)	Africa	0°
GMS (Japan)	West Pacific, Southeast Asia, Australia	140°East

Areas Where Stationary Satellite Reception Is Possible

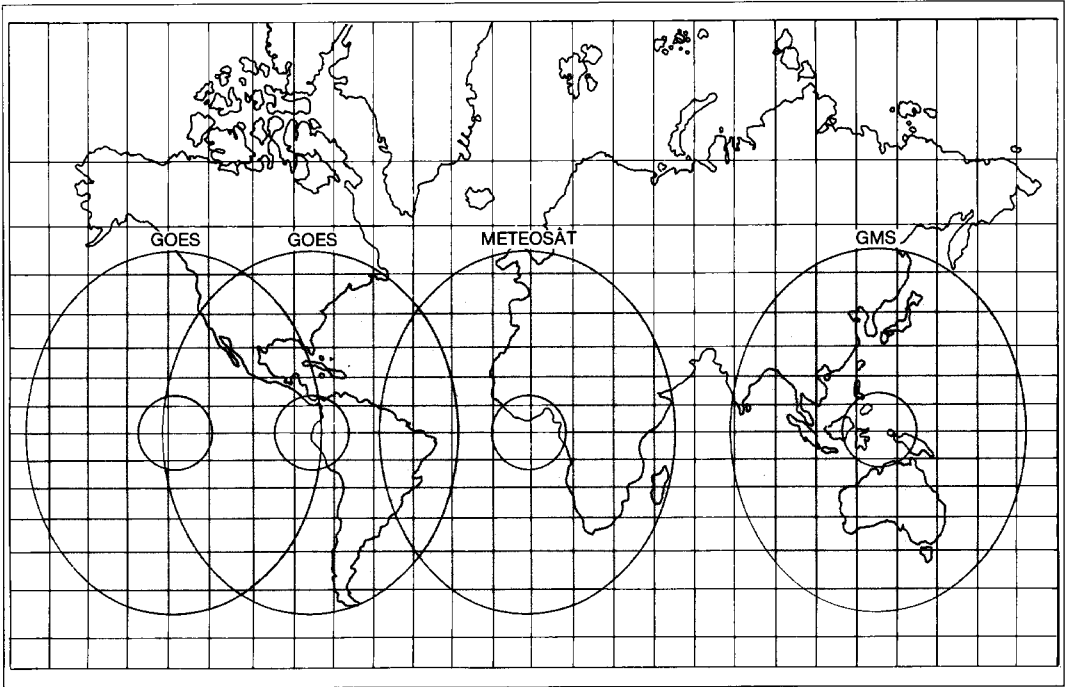

Satellite GMS Hard Copy Example

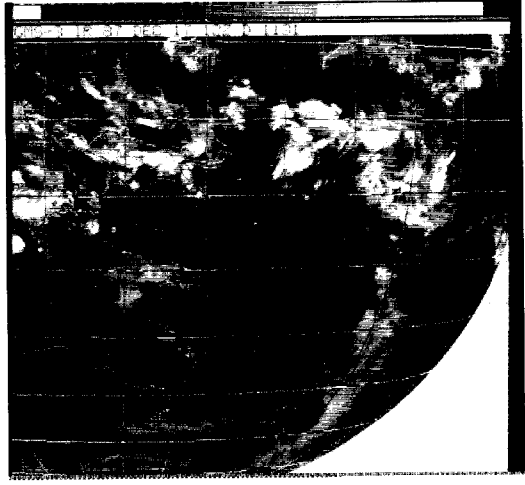
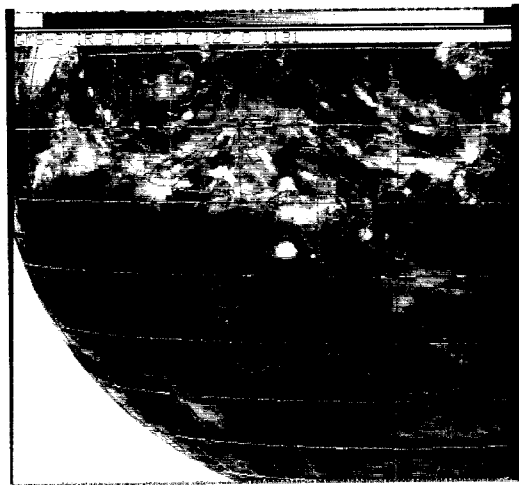
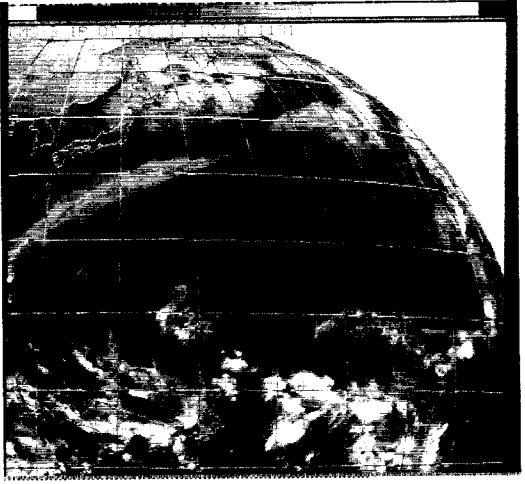
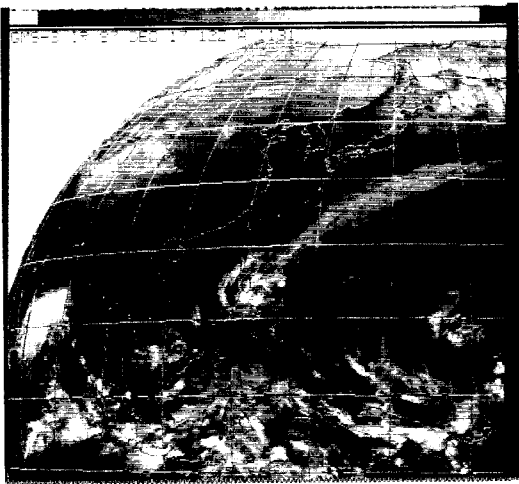

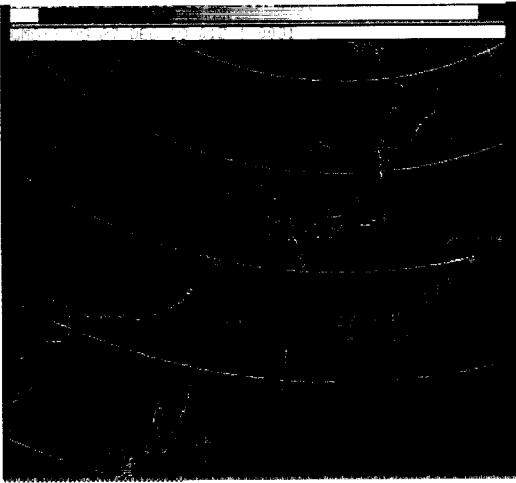
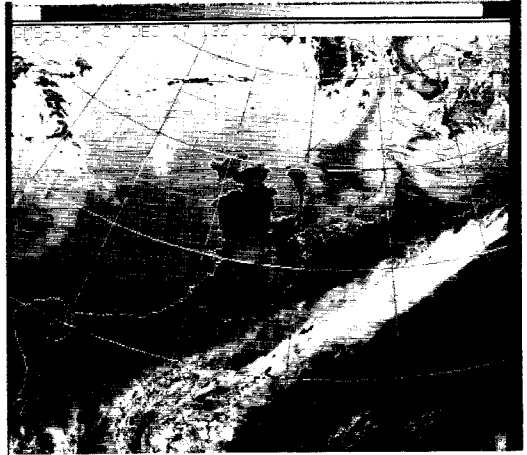
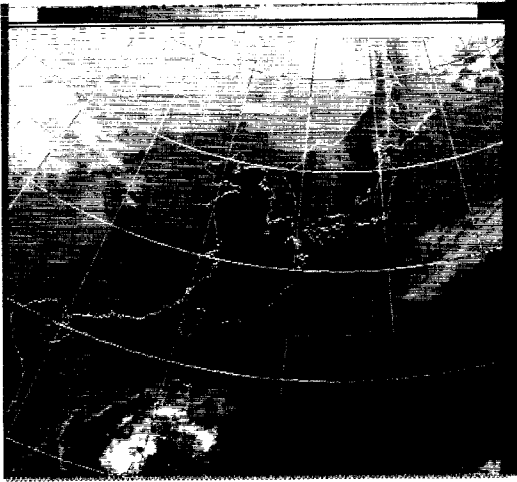

When Clear Reception Cannot Be Obtained — Cause and Cure

Even when reception and facsimile reproduction settings are correct, it may sometimes be difficult to obtain clear reception.

Followings are some examples of certain problems that can arise and how to solve them.

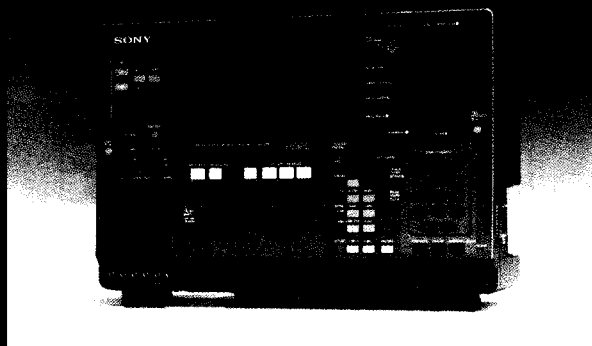

When Clear Reception Cannot Be Obtained

A: Streaking

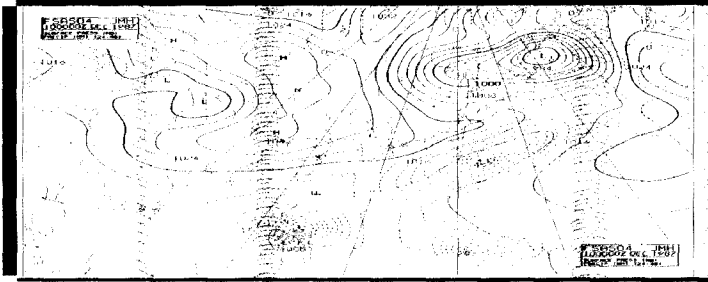

Cause: Fading interference

The signal transmitted from the broadcast station arrives by two different paths. The combined signals result in noise. This is called fading interference.

Cure: Because short-wave signals are strongly affected by the ionosphere, it is impossible to completely eliminate this problem, but using a highly directional beam antenna (one that receives more strongly from one particular direction) will improve reception in many cases.

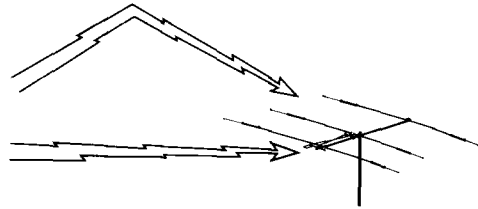

B: Lines appear doubled, or objects appear with tails (echo effect)

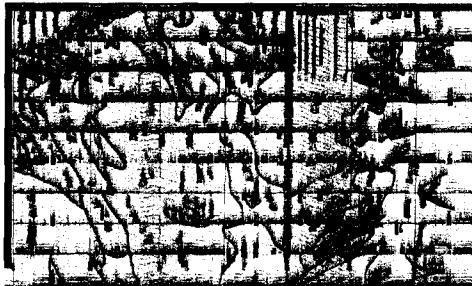

Cause: This is a type of fading interference

Occurs when there is a large time difference between early- and late-arriving signals.

Cure: Using a highly directional beam antenna will improve reception in many cases.

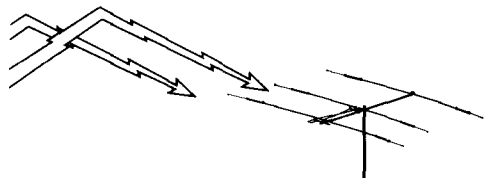

C: Severe stripes appear or chart is difficult to read

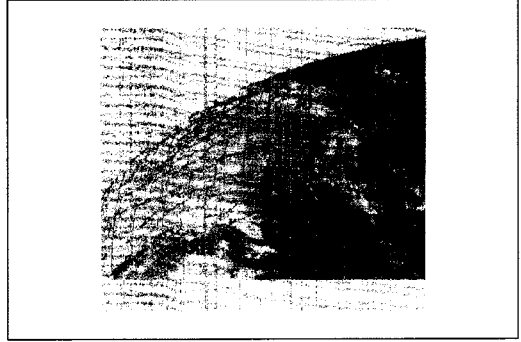

Cause: Radio interference

An interfering station is transmitting near the reception frequency, or a source of electrical interference is near the antenna.

Cure: Naturally, eliminating the source of interference is the best method, but the use of a good beam antenna can make an improvement in many cases.

D: Chart unreadable

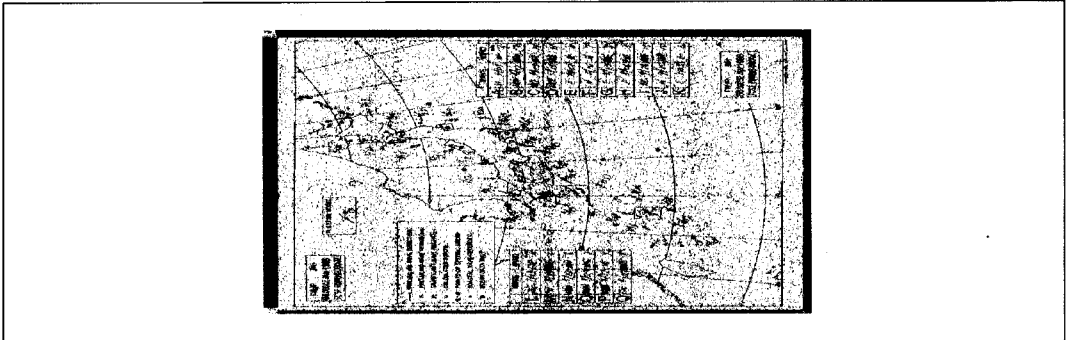

Cause: Weak signal

Cure: When stations on all frequency bands are weak, make sure that the ATTENUATOR switch is set to 0 dB and the AM RF GAIN is set to MAX. Also, make sure that the antenna is not disconnected or shorted.

In the case where the desired signal is too weak, try using a dipole antenna, or use the Activity Search function to find the best time of day for reception.

E: A pattern of stripes or dots appear

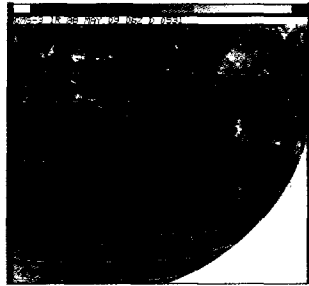

Cause: Electrical interference from a car's ignition system or an electric motor, etc.

Cure: Locate the antenna as far as possible from the source of interference. If the noise is not too bad, it can be reduced by adjusting the printing contrast (see page 44 in the "Operating Instructions").

Weather Chart Radiofacsimile Frequency List

Most broadcast stations transmit simultaneously on several frequencies, so choose the frequency that provides best reception depending on the season, time of day, and location.

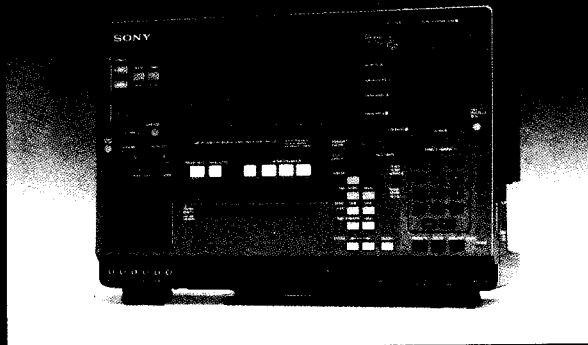

Weather Chart Radiofacsimile Frequency List

Station		Frequency	Transmission speed (rpm)	Index of Cooperation
Japan	Tokyo 1	3622.5 kHz 7305 kHz 9970 kHz 13597 kHz 18220 kHz 22770 kHz	120 (Some broadcasts are 60.)	576(H)
	Tokyo 2	3365 kHz 5405 kHz 9438 kHz 14692.5 kHz 18130 kHz	120	576(H)
People's Republic of China		5525 kHz 8120 kHz 10115 kHz* 14365 kHz 18235 kHz	120	576(H)
Soviet Union	Khabarovsk	4516.7 kHz 7475 kHz 9230 kHz 14737 kHz 19275 kHz	60, 90, 120	576(H) (Some broadcasts are 288(L).)
	Moscow	2815 kHz 5355 kHz 7750 kHz 10980 kHz 15950 kHz	60, 90, 120	576(H) or 288(L)
	Molodezhnaia	6283 kHz 9280 kHz 15830 kHz 17660 kHz 18490 kHz	120	576(H)
Hawaiian Islands	Pearl Harbor	2122 kHz 4855 kHz 8494 kHz 9396 kHz 14826 kHz 16398 kHz 21837 kHz	120	—
	Honolulu	9982.5 kHz 11090 kHz 16135 kHz 23331.5 kHz (2 of these frequencies are used at a time.)	120	576(H)

Some stations transmit on different frequencies at different times.

* Add 1.9 kHz to the listed frequency (10116.9 kHz) when receiving.

Station		Frequency	Transmission speed (rpm)	Index of Cooperation
Kenya		9043 kHz** 17365 kHz**	120	576(H)
Egypt		4526 kHz** 10123 kHz**	120	576(H)
South Africa		7508 kHz** 13773 kHz** 18238 kHz** 4014 kHz**	120	576(H)
Senegal		7587.5 kHz*** 13667.5 kHz*** 19750 kHz***	120 (Some broadcasts are 60.)	576(H)
India		4993.5 kHz 7403 kHz 14842 kHz 18225 kHz	120	576(H)
Thailand		17520 kHz 7395 kHz 6765 kHz	60	576(H) (Some broadcasts are 90(L).)
Argentina		5185 kHz 10720 kHz 18093 kHz	120	576(H)
Brazil	Rio de Janeiro	8291.1 kHz 12025 kHz	120	576(H)
	Brasília	10225 kHz 18080 kHz	120	576(H)
Chile		4766 kHz 6418 kHz 8594 kHz 8595 kHz 13525 kHz 22071 kHz	120	576(H)

** Subtract 1.9 kHz when receiving.

*** Add 1.9 kHz when receiving.

Weather Chart Radiofacsimile Frequency List

Station		Frequency	Transmission speed (rpm)	Index of Cooperation
Canada	Esquimalt	4268 kHz 4495.5 kHz 6944 kHz 12123 kHz	120	576(H)
	Halifax	4271 kHz 6330 kHz 9890 kHz 13510 kHz 122.5 kHz (not used during some periods.)	120	—
United States of America		4346.1 kHz 8682 kHz 12730 kHz 17151.3 kHz	120	—
Australia	Canberra	5100 kHz 11030 kHz 13920 kHz 19690 kHz	120	576(H)
	Darwin	5755 kHz 7535 kHz 10555 kHz 15615 kHz 18060 kHz	120	576(H)
New Zealand		5807 kHz 9459 kHz 13550 kHz 16222 kHz	120	576(H)
Philippines		3377.5 kHz 10966 kHz 13395 kHz 22865 kHz	120	—
Marianna Islands		4975 kHz 7894 kHz 10255 kHz 15990 kHz 19860 kHz 23064 kHz	120	—
Bulgaria		5093 kHz	120	576(H)
Italy		4777.5 kHz 8146.6 kHz 13597 kHz	120	576(H)
Germany	Offenbach	134.2 kHz	120 (Some broadcasts are 240.)	576(H)
	Quickborn/ Pinnerberg	3855 kHz 7880 kHz 13882.5 kHz	120	576(H)

Station		Frequency	Transmission speed (rpm)	Index of Cooperation
United Kingdom		2618.5 kHz 4782 kHz 9203 kHz 14436 kHz 18261 kHz	120	576(H) (Some broadcasts are 288(L).)
Spain	Madrid	3650 kHz 6918.5 kHz 10250 kHz	120 (Some broadcasts are 60.)	576(H)
	Rota	3713 kHz 5206 kHz 7626 kHz 8100 kHz 12184 kHz 12903 kHz 15941.5 kHz	120	576(H)
Sweden		4037.5 kHz 6901 kHz 8077.5 kHz	120	576(H)
Turkey		6790 kHz	90	576(H)

These frequencies are those of June 1987 and are subject to change.